



Metro Collab Pricebook

State Of Connecticut

Contract Number: 25PSX0057

January 2025

Contents

OVERVIEW	9
application guidelines Step 1	10
application guidelines Step 2	11
application guidelines Step 3	12
application guidelines Step 4	13
application guidelines Step 5	14
application guidelines Map	15
application guidelines Grain direction	16
Caution	17
straight desk	19
straight desk executive	20
straight desk professional	22
straight partial modesty executive	24
straight partial modesty professional	26
straight full recessed modesty executive	28
straight full recessed modesty professional	30
arc full recessed modesty executive	32
arc full recessed modesty professional	33

tables	35
D-table executive	36
D-table professional	37
J-table executive	38
J-table professional	39
P-table executive	40
P-table professional	41
F-table executive	42
F-table professional	43
U-table executive	44
U-table professional	45
C-table executive	46
C-table professional	47
corners	49
straight front corner surface full modesty executive	50
straight front corner surface full modesty professional	51
straight front corner surface partial modesty executive	52
straight front corner surface partial modesty professional	53
curved front corner surface full modesty executive	54
curved front corner surface full modesty professional	55
curved front corner surface partial modesty executive	56
curved front corner surface partial modesty professional	57

unitized desks	59
<u>curved front unitized desk full modesty executive</u>	60
<u>curved front unitized desk full modesty professional</u>	61
<u>curved front unitized desk partial modesty executive</u>	62
<u>curved front unitized desk partial modesty professional</u>	63
bridges	65
<u>straight bridge full modesty executive</u>	66
<u>straight bridge full modesty professional</u>	67
<u>straight bridge partial modesty executive</u>	68
<u>straight bridge partial modesty professional</u>	69
returns	71
<u>straight return full modesty executive</u>	72
<u>straight return full modesty professional</u>	74
<u>straight return partial modesty executive</u>	76
<u>straight return partial modesty professional</u>	78
<u>intermediate support & cantilever executive</u>	81
<u>intermediate support & cantilever professional</u>	81
filing and storage	83
<u>pedestals</u>	84
<u>underdesk storage cabinet</u>	85

<u>underdesk combo pedestal BBF & FF</u>	86
<u>underdesk 2-drawer lateral file</u>	87
<u>freestanding storage cabinet executive</u>	88
<u>freestanding storage cabinet professional</u>	89
<u>freestanding combo pedestal BBF & FF executive</u>	90
<u>freestanding combo pedestal BBF & FF professional</u>	91
<u>freestanding 2-drawer lateral file executive</u>	92
<u>freestanding 2-drawer lateral file professional</u>	93
<u>freestanding 3-drawer lateral file executive</u>	94
<u>freestanding 3-drawer lateral file professional</u>	95
<u>freestanding 4-drawer lateral file executive</u>	96
<u>freestanding 4-drawer lateral file professional</u>	97
<u>freestanding storage tower executive</u>	98
<u>freestanding storage tower professional</u>	99
<u>freestanding combo storage tower BBF executive</u>	100
<u>freestanding combo storage tower BBF professional</u>	101
<u>freestanding wardrobe storage tower executive</u>	102
<u>freestanding wardrobe storage tower professional</u>	103
<u>freestanding storage tower glazed door executive</u>	104
<u>freestanding storage tower glazed door professional</u>	105

freestanding combo storage tower FF executive	106
freestanding combo storage tower FF professional	107
freestanding storage tower double door executive	108
freestanding storage tower double door professional	109
freestanding combo lateral storage tower double door executive	110
freestanding combo lateral storage tower double door professional	111
freestanding combo storage tower double door executive	112
freestanding combo storage tower double door professional	113
freestanding storage tower glazed double door executive	114
freestanding storage tower glazed double door professional	115
freestanding combo lateral storage tower glazed double door executive	116
freestanding combo lateral storage tower glazed double door professional	117
freestanding combo storage tower glazed double door executive	118
freestanding combo storage tower glazed double door professional	119
radius corner bookcase short executive	120
radius corner bookcase short professional	121

overhead storage	123
open hutch executive	124
open hutch professional	125
hinged door overhead storage executive	126
hinged door overhead storage professional	127
hinged door overhead storage glazed doors executive	128
hinged door overhead storage glazed doors professional	129
posts	131
large vertical aluminum post	132
small vertical aluminum post	133
electrics	135
power box	136
data box	137
electrical starter harness	138
electrical splitter harness	139
electrical harness	140
screens	143
lamine screens	144
fabric screens	149

glazed screens	154
whiteboard screens	159
accessory screen	163
counter tops	165
glass	166
laminate 1.5 inch	167
boat laminate 1 inch	168
straight laminate 1 inch	169
wire management	171
vertical wire manager	172
horizontal wire manager	173
wire clip	174
accessories	177
Keyboard Tray	178
work organizer	179
monitor arm	180
task light	181

OVERVIEW

Tayco introduces Metropolis Collaborate, a full line of casegoods with a post and screen component that refreshes open spaces, private, and semi-private work areas for today's office environment. Collaborate is divided into two distinct product groups for specifying: Executive and Professional. Executive offers surfaces and tops that are 1.5" thick, Professional offers 1" thick. Listed below are features and benefits of collaborate along with a typical layout.

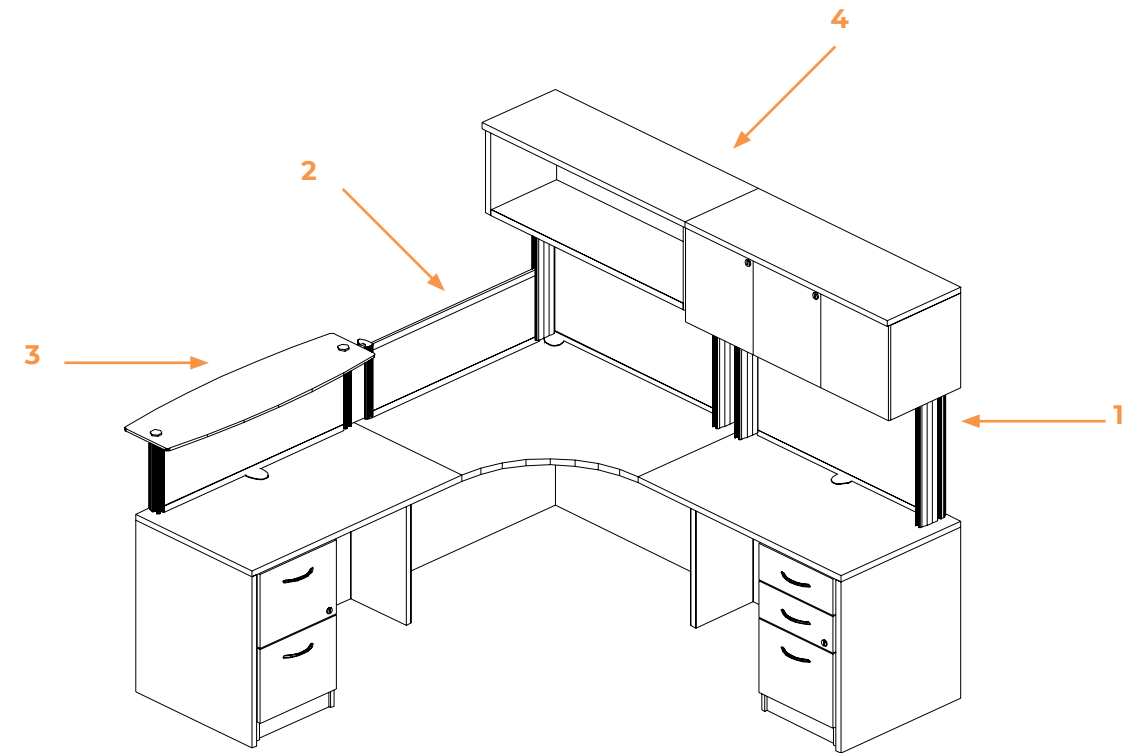

1

- a. Aluminum posts are available in 8, 12, 16, 24, 32 inches high.
- b. Large posts are required to support overhead storage.
- c. Hutches 54 inches and wider require 4 posts in a single span.
- d. Transaction countertops 54 inches and wider require 4 small aluminum posts.
- e. Posts are available in silver, black, and ginger.

2

- a. Screens are available in tackable fabric, laminate, whiteboard, glazed or with accessory slots.
- b. Heights are available in 4, 8, 12, 16, 20, 24, 32 inches high.

3

- a. Countertops are available in tempered glass and laminate finishes.
- b. They are supported by small aluminum posts.

4

- a. Overhead storage is available for assorted desk layouts, optional features include: open, hinged doors, glazed and open laminate.

application guidelines Step 1

STEP

EXPLAINED

NEXT

1

First select the appropriate base components to fit the space planning needs of your customer. Below is a typical corner workstation that consists of the basic items commonly used in today's office environment.

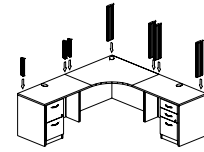

CURVED FRONT CORNER

This item is for use in corners when connected to returns or bridges.

GROMMET

Grommets are available in black or silver. Black is the standard grommet option unless otherwise specified on your Purchase Order.

HANDLES

Six handle options are available in several styles and colors. Melbourne is the standard handle option unless otherwise specified on your Purchase Order.

STRAIGHT RETURNS

This return is semi-supported, it must be connected to a freestanding desk, corner desk or credenza. Allows for fixed and modular underdesk storage.

UNDERDESK FF PEDESTAL

This return is semi-supported, it must be connected to a freestanding desk, corner desk or credenza. Allows for fixed and modular underdesk storage. All pedestals come standard with locks.

UNDERDESK BBF PEDESTAL

This product includes box and file drawers and can be used under a desk, return or credenza for storage. Its full extension drawers can accommodate both letter and legal-size paper. All pedestals come standard with locks and pencil trays.

- | COLORS | |
|---|--|
|  | MELBOUNRE
Brushed Nickel (standard) |
|  | MANHATTAN
Ginger |
|  | CLIFTON
Espresso |
|  | BROOKLYN
Black |
|  | ROSEDALE
Polished Metal
Silver |

application guidelines Step 2

STEP

EXPLAINED

NEXT

2

Select the appropriate post heights to fit the specification needs by your customer. There are only two post structures to work with. Small posts support countertops and all screen heights. Large posts support overheads in conjunction with large screens.

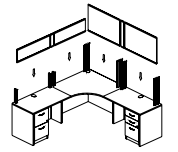

SMALL POSTS

These posts will support a screen only since the transaction top will only span the return. Available in silver, black and ginger.

LARGE POSTS

Large aluminum posts are required to support overhead storage. Hutches 54" and wider require 4 posts in a single span. These posts will also hold the appropriate screen in place. Available in silver, black and ginger.

SMALL POSTS

These small posts will support a glass transaction top and screen. Countertops 54" and wider require 4 small posts. Available in silver, black and ginger.

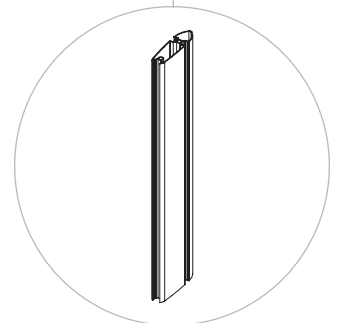
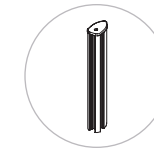

application guidelines Step 3

STEP

3

EXPLAINED

Choose the appropriate screen heights based on post heights. Metropolis Collaborate offers several screen types: laminate, fabric, glazed, whiteboard, and accessory.

NEXT

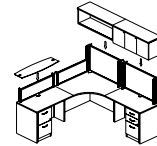

SCREENS

Screens selected in conjunction with corresponding post height and surface width.

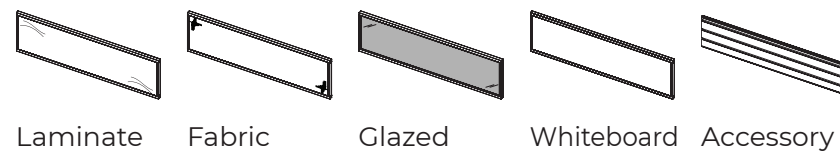
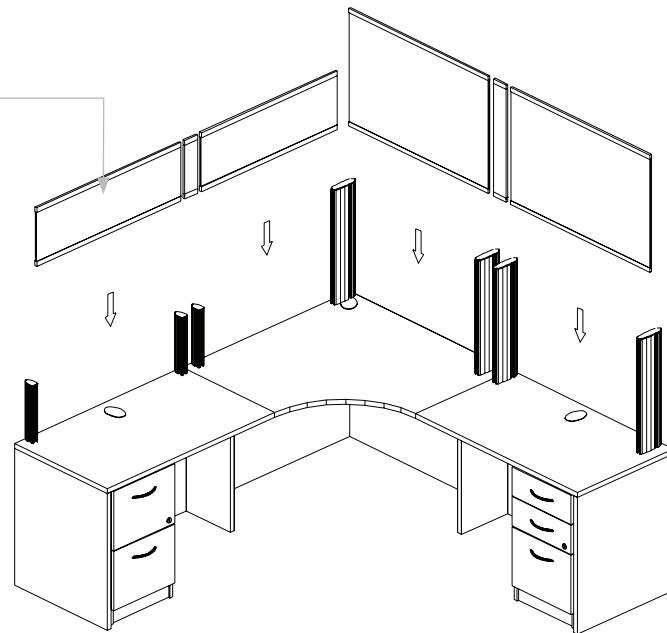

application guidelines Step 4

STEP

4

EXPLAINED

Overhead storage and hutches can now be added to any 24" large vertical posts. In this case an Open and Hinged Door Hutch are being used for storage. A transaction top is placed on the smaller posts.

COMPLETE

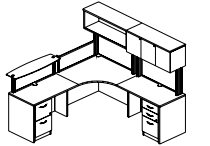

OPEN HUTCH

Provides overhead storage within the workstation. Overheads 54 inches and wider require 4 large vertical posts for support.

HINGED DOOR HUTCH

Provides overhead storage within the workstation. Overheads 54 inches and wider require 4 large vertical posts for support.

TRANSACTION TOP

Transaction tops are available in tempered glass, 1 & 1.5 inches thick laminate surfaces. Transaction tops 54 inches and wider require 4 small vertical posts for support.

HINGED DOOR HUTCH GLAZED

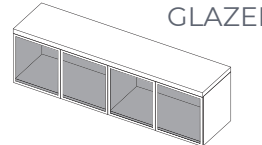

OPEN LAMINATE SHELF

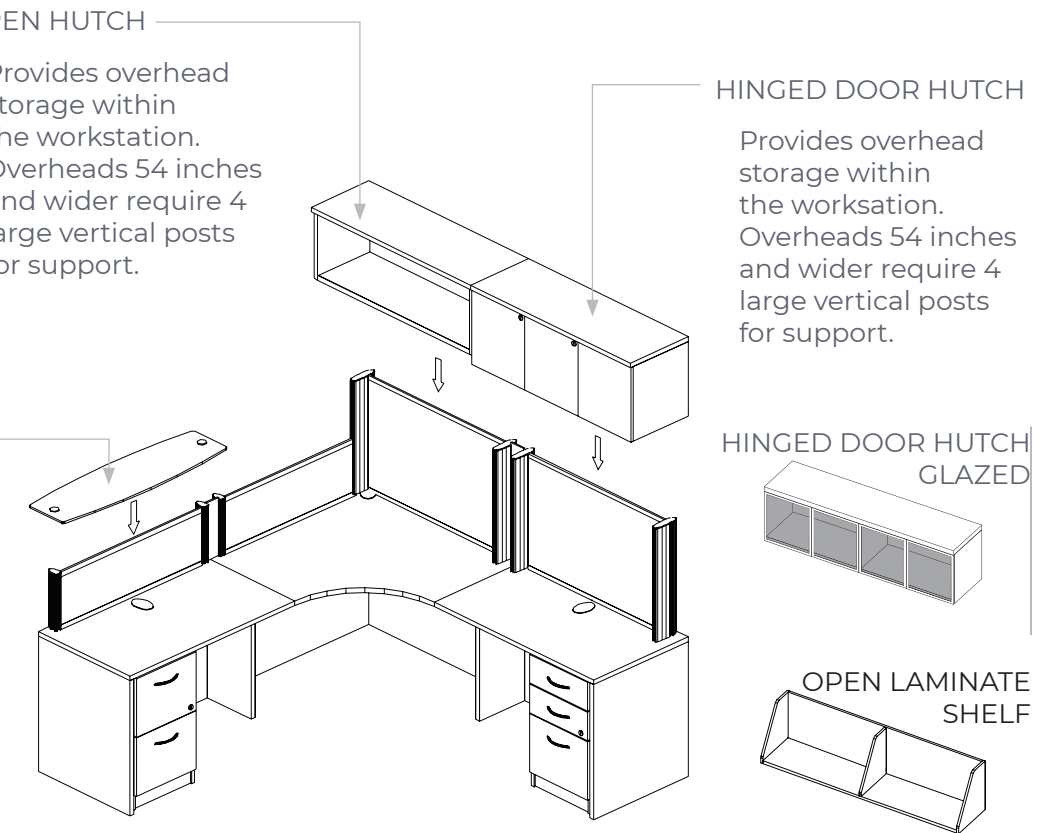
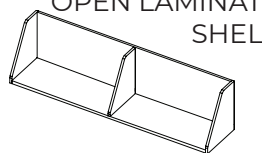

STEP

5

EXPLAINED

The workstation is now complete. Providing detailed floorplans with each order will help avoid errors when quoting Metropolis Collaborate. Tayco can assist with space planning needs by generating proper layouts and pricing.

FLOORPLAN

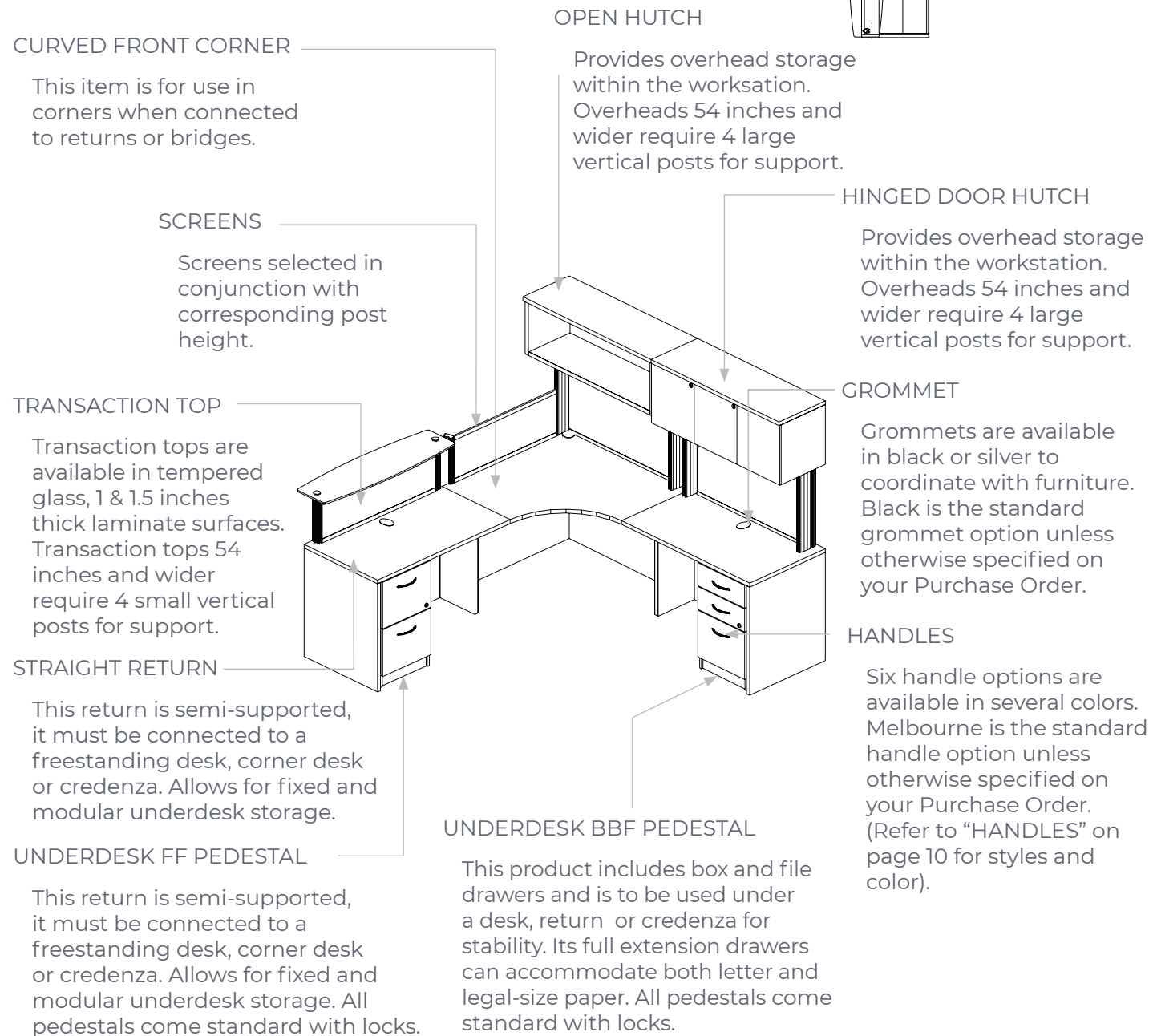
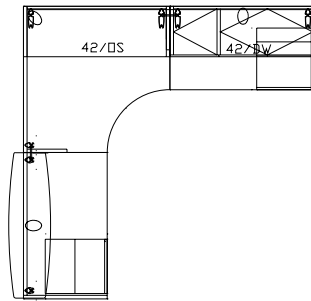

BRIEF

This map contains all the components referred to in this section for easy reference.

MAP

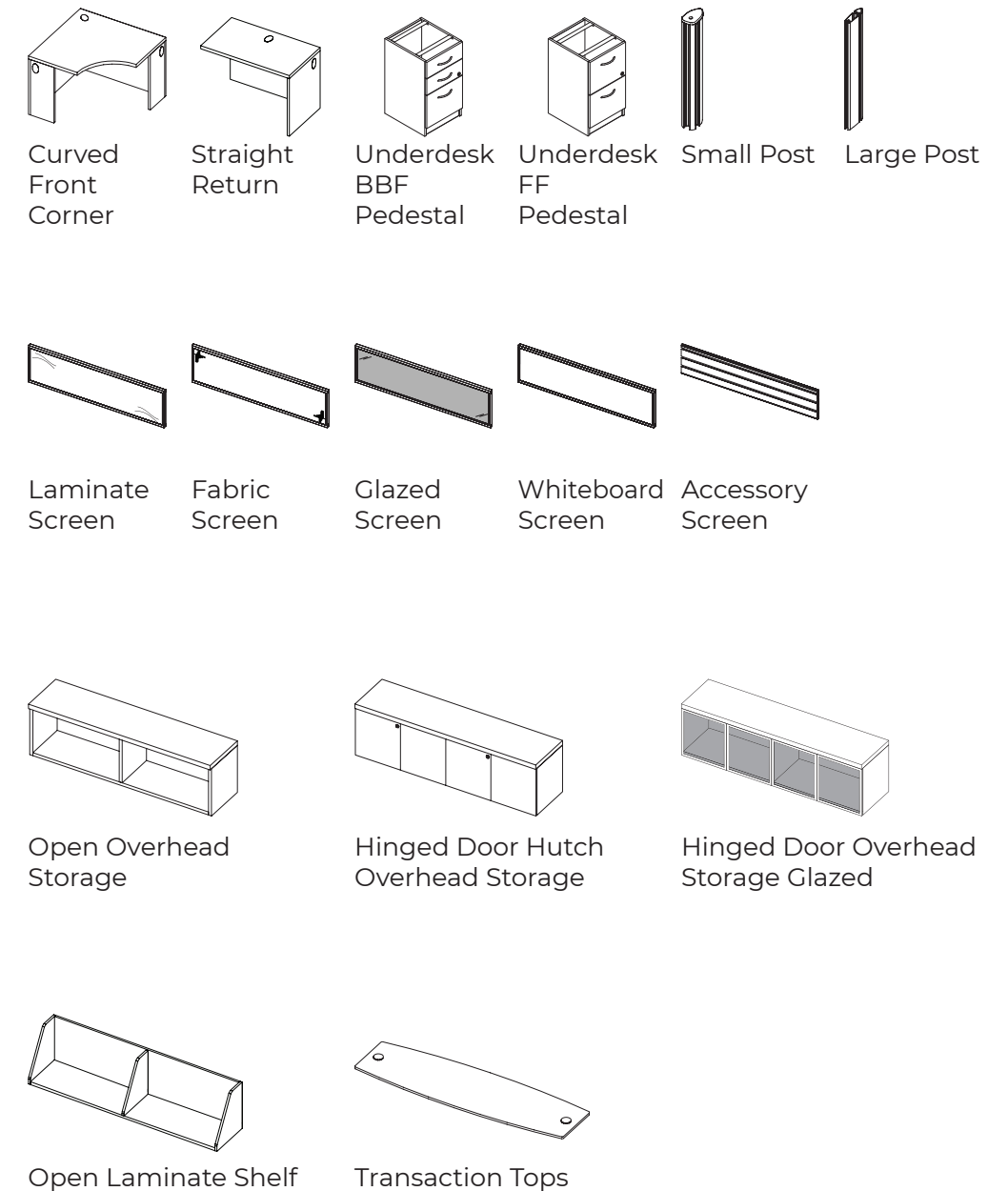

application guidelines Grain direction

HORIZONTAL SURFACES

When ordering a directional laminate, the grain will run the direction of the width of the worksurface (excluding bridge surfaces), hutch or storage top. Grain on bridge modesty run vertically so the grain will run the same direction on the entire suite.

VERTICAL SURFACES

Directional laminates run vertically on vertical surfaces such as cabinet doors, pedestal drawer fronts and gables, as well as all cabinet, lateral file and pedestal kick-plates. The grain runs horizontally across the width of modesty panels.

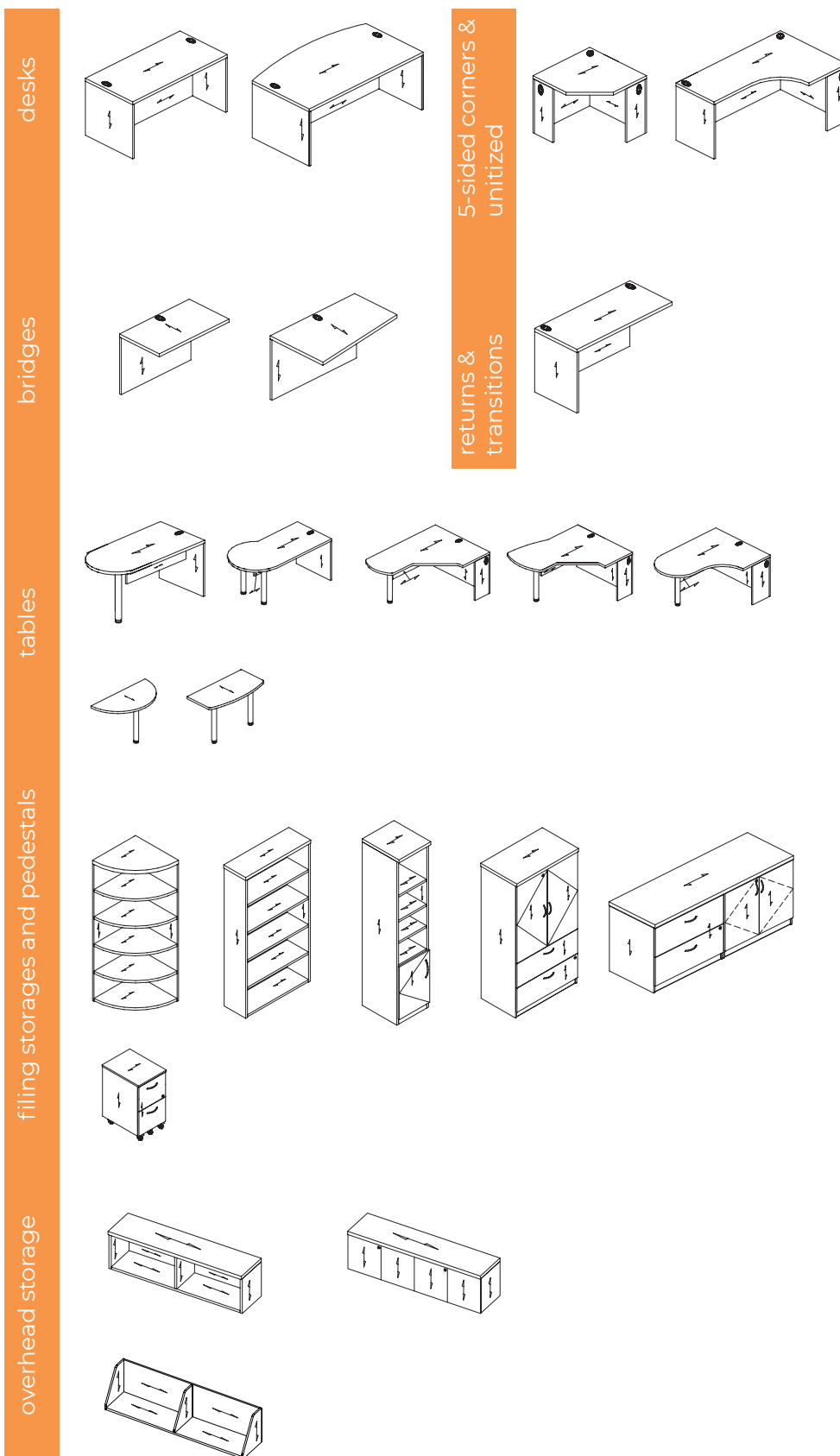

Caution

Load Bottom Drawer First

- Operate one drawer at a time
- Units may tip if loaded incorrectly
- Units should be attached to a wall or other furniture to reduce tipping hazard
- Always load the heaviest files in the bottom drawer

Heavy Load

- Some products must be anchored to wall to ensure stability & safety.
- It is the owner and installers responsibility to ensure that the wall type and construction is of sufficient strength to carry the loads of any wall mounted products and their contents.
- Failure of the wall and anchors to support all imposed loads may result in property damage and/or personal injury.
- Tayco can provide size and empty weight of its products only. As wall blocking is considered a building construction process, Tayco cannot provide recommendations in this respect and cannot be responsible for damage or injury that may occur as a result of improper installation and/or blocking.

Instability Hazard

Mobile items on casters such as flip top, personal and movable tables of any type and storage items of any type may present an instability hazard if not secured correctly while in use or in storage. Flip top tables or training tables of any type, are inherently more unstable when folded. Tayco provides the following guidelines & warnings when using mobile products:

- Lock casters immediately after moving. Do not leave the casters unlocked when in use or in storage.
- Motion may increase the instability of any item with casters. If the wheels hit an obstruction the table's forward momentum often causes overturn, especially if the item is not equipped with wheel extensions. Exercise strong caution while moving these items.
- Use caution when abrupt level changes in the floor are present (such as a doorway or room threshold) as caster failure or tipping may result.
- Do not stand, sit or lean on mobile items for support. They are not intended for this use and personal injury or property damage may result.
- Mobile units that feature height adjustable elements must be lowered to the minimum compressed height when moving to prevent instability. It is also recommended the user remove all computer equipment or other accessories to prevent possible weight imbalance or damage to equipment.
- Failure to follow the guidelines above may result in property damage or personal injury.



Metro Collab
January 2026
Desks

straight desk

Executive

<u>straight desk</u>	20
<u>straight partial modesty</u>	24
<u>straight full recessed modesty</u>	28
<u>arc full recessed modesty</u>	32

Professional

<u>straight desk</u>	22
<u>straight partial modesty</u>	26
<u>straight full recessed modesty</u>	30
<u>arc full recessed modesty</u>	33

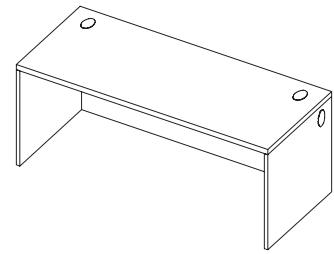

Straight Desk Full Modesty, 1.5" Thick Surface

This desk can be used alone or connected to a bridge or return to complete a full workstation. Allows for fixed and modular underdesk storage.

Ordering Options:

Use the following checklist to customize the finishes on your order:

- laminate
- trim color
- edge profile
- grommet color

Each laminate comes with matching vinyl trim color unless otherwise specified on your purchase order. Refer to the laminate finish card for our current offering.

Details:

Modesty is full height.

Grommets are available in black or silver. Black is the standard grommet option unless otherwise specified on your purchase order.

Surfaces up to and including 48" wide have one grommet located at the back center of the surface. Surfaces 54" wide and greater have two grommets at either side of the back of the surface.

All gables include grommets

Code	Price	H	W	D	Volume (ft ³)	Weight (lb)
K-TS0G-6021	1078	29.5	60	21	4.63	122.55
K-TS0G-6621	1136	29.5	66	21	5.06	131.97
K-TS0G-7221	1182	29.5	72	21	5.5	141.39
K-TS0G-7821	1233	29.5	78	21	5.93	150.81
K-TS0G-8421	1303	29.5	84	21	6.37	160.23
K-TS0G-3024	859	29.5	30	24	2.75	92.02
K-TS0G-3624	911	29.5	36	24	3.24	111.14
K-TS0G-4224	950	29.5	42	24	3.73	130.26
K-TS0G-4824	1006	29.5	48	24	4.21	149.38
K-TS0G-5424	1064	29.5	54	24	4.7	168.5
K-TS0G-6024	1123	29.5	60	24	5.19	187.62
K-TS0G-6624	1182	29.5	66	24	5.67	206.74
K-TS0G-7224	1224	29.5	72	24	6.16	225.86
K-TS0G-7824	1285	29.5	78	24	6.64	244.98
K-TS0G-8424	1353	29.5	84	24	7.13	264.1
K-TS0G-3030	904	29.5	30	30	3.34	99.05
K-TS0G-3630	973	29.5	36	30	3.94	110.58
K-TS0G-4230	1031	29.5	42	30	4.53	122.11
K-TS0G-4830	1099	29.5	48	30	5.12	133.64
K-TS0G-5430	1182	29.5	54	30	5.71	145.17
K-TS0G-6030	1233	29.5	60	30	6.3	156.7
K-TS0G-6630	1285	29.5	66	30	6.89	168.23
K-TS0G-7230	1335	29.5	72	30	7.48	179.76
K-TS0G-8430	1489	29.5	84	30	8.66	202.82

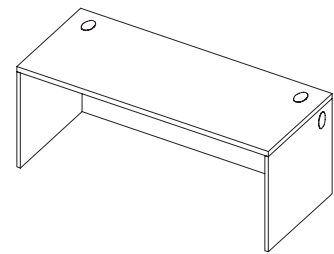

This desk can be used alone or connected to a bridge or return to complete a full workstation. Allows for fixed and modular underdesk storage.

Ordering Options:

Use the following checklist to customize the finishes on your order:

- laminate
- trim color
- grommet color

Each laminate comes with matching vinyl trim color unless otherwise specified on your purchase order. Refer to the laminate finish card for our current offering.

Details:

Modesty is full height.

Grommets are available in black or silver. Black is the standard grommet option unless otherwise specified on your purchase order.

Surfaces up to and including 48" wide have one grommet located at the back center of the surface. Surfaces 54" wide and greater have two grommets at either side of the back of the surface.

All gables include grommets

Code	Price	H	W	D	Volume (ft ³)	Weight (lb)
KL-TS0G-6021	993	29	60	21	4.63	107.7
KL-TS0G-6621	1050	29	66	21	5.06	117.12
KL-TS0G-7221	1090	29	72	21	5.5	126.54
KL-TS0G-7821	1145	29	78	21	5.93	135.96
KL-TS0G-8421	1209	29	84	21	6.37	145.38
KL-TS0G-3024	794	29	30	24	2.75	77.17
KL-TS0G-3624	849	29	36	24	3.24	96.29
KL-TS0G-4224	881	29	42	24	3.73	115.41
KL-TS0G-4824	931	29	48	24	4.21	134.53
KL-TS0G-5424	983	29	54	24	4.7	153.65
KL-TS0G-6024	1038	29	60	24	5.19	172.77
KL-TS0G-6624	1090	29	66	24	5.67	191.89
KL-TS0G-7224	1136	29	72	24	6.16	211.01
KL-TS0G-7824	1186	29	78	24	6.64	230.13
KL-TS0G-8424	1250	29	84	24	7.13	249.25
KL-TS0G-3030	838	29	30	30	3.34	84.2
KL-TS0G-3630	903	29	36	30	3.94	95.73
KL-TS0G-4230	955	29	42	30	4.53	107.26
KL-TS0G-4830	1020	29	48	30	5.12	118.79
KL-TS0G-5430	1089	29	54	30	5.71	130.32
KL-TS0G-6030	1145	29	60	30	6.3	141.85
KL-TS0G-6630	1186	29	66	30	6.89	153.38
KL-TS0G-7230	1236	29	72	30	7.48	164.91
KL-TS0G-7830	1310	29	78	30	8.07	176.44
KL-TS0G-8430	1379	29	84	30	8.66	187.97

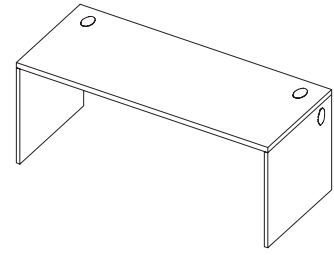

Straight Desk Partial Modesty,
1.5" Thick Surface

Ordering Options:

Use the following checklist to customize the finishes on your order:

- laminate
- trim color
- edge profile
- grommet color

Each laminate comes with matching vinyl trim color unless otherwise specified on your purchase order. Refer to the laminate finish card for our current offering.

Details:

Partial modesty height 12".

Grommets are available in black or silver. Black is the standard grommet option unless otherwise specified on your purchase order.

Surfaces up to and including 48" wide have one grommet located at the back center of the surface. Surfaces 54" wide and greater have two grommets at either side of the back of the surface.

All gables include grommets.

Code	Price	H	W	D	Volume (ft ³)	Weight (lb)
K-TS0Z-6021	1078	29.5	60	21	4.63	97.81
K-TS0Z-6621	1136	29.5	66	21	5.06	104.54
K-TS0Z-7221	1182	29.5	72	21	5.5	111.27
K-TS0Z-7821	1233	29.5	78	21	5.93	118
K-TS0Z-8421	1303	29.5	84	21	6.37	124.73
K-TS0Z-3024	859	29.5	30	24	2.75	71.33
K-TS0Z-3624	911	29.5	36	24	3.24	78.75
K-TS0Z-4224	950	29.5	42	24	3.73	86.17
K-TS0Z-4824	1006	29.5	48	24	4.21	93.59
K-TS0Z-5424	1064	29.5	54	24	4.7	101.01
K-TS0Z-6024	1123	29.5	60	24	5.19	108.43
K-TS0Z-6624	1182	29.5	66	24	5.67	115.85
K-TS0Z-7224	1224	29.5	72	24	6.16	123.27
K-TS0Z-7824	1285	29.5	78	24	6.64	130.69
K-TS0Z-8424	1353	29.5	84	24	7.13	138.11
K-TS0Z-3030	904	29.5	30	30	3.34	75.35
K-TS0Z-3630	973	29.5	36	30	3.94	83.98
K-TS0Z-4230	1031	29.5	42	30	4.53	92.6
K-TS0Z-4830	1099	29.5	48	30	5.12	101.23
K-TS0Z-5430	1182	29.5	54	30	5.71	109.85
K-TS0Z-6030	1233	29.5	60	30	6.3	118.48
K-TS0Z-6630	1285	29.5	66	30	6.89	127.1
K-TS0Z-7230	1335	29.5	72	30	7.48	135.73
K-TS0Z-7830	1419	29.5	78	30	8.07	144.35
K-TS0Z-8430	1489	29.5	84	30	8.66	152.98

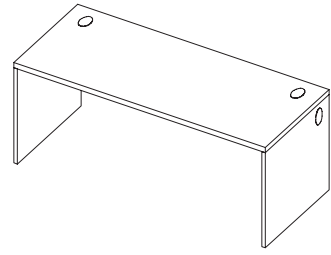

Ordering Options:

Use the following checklist to customize the finishes on your order:

- laminate
- trim color
- grommet color

Each laminate comes with matching vinyl trim color unless otherwise specified on your purchase order. Refer to the laminate finish card for our current offering.

Details:

Partial modesty height 12".

Grommets are available in black or silver. Black is the standard grommet option unless otherwise specified on your purchase order.

Surfaces up to and including 48" wide have one grommet located at the back center of the surface. Surfaces 54" wide and greater have two grommets at either side of the back of the surface.

All gables include grommets.

Code	Price	H	W	D	Volume (ft ³)	Weight (lb)
KL-TS0Z-3030	838	29	30	30	3.34	63.48
KL-TS0Z-3624	849	29	36	24	3.24	67.5
KL-TS0Z-3630	903	29	36	30	3.94	69.97
KL-TS0Z-4224	881	29	42	24	3.73	73.05
KL-TS0Z-4230	955	29	42	30	4.53	76.46
KL-TS0Z-4824	931	29	48	24	4.21	78.6
KL-TS0Z-4830	1020	29	48	30	5.12	82.95
KL-TS0Z-5424	983	29	54	24	4.7	84.15
KL-TS0Z-5430	1089	29	54	30	5.71	89.44
KL-TS0Z-6021	993	29	60	21	4.63	81.41
KL-TS0Z-6024	1038	29	60	24	5.19	89.7
KL-TS0Z-6030	1145	29	60	30	6.3	95.93

Code	Price	H	W	D	Volume (ft ³)	Weight (lb)
KL-TS0Z-6621	1050	29	66	21	5.06	86.6
KL-TS0Z-6624	1090	29	66	24	5.67	95.25
KL-TS0Z-6630	1186	29	66	30	6.89	102.42
KL-TS0Z-7221	1090	29	72	21	5.5	91.79
KL-TS0Z-7224	1136	29	72	24	6.16	100.8
KL-TS0Z-7230	1236	29	72	30	7.48	108.91
KL-TS0Z-7821	1145	29	78	21	5.93	96.98
KL-TS0Z-7824	1186	29	78	24	6.64	106.35
KL-TS0Z-7830	1310	29	78	30	8.07	115.4
KL-TS0Z-8421	1209	29	84	21	6.37	102.17
KL-TS0Z-8424	1250	29	84	24	7.13	111.9
KL-TS0Z-8430	1379	29	84	30	8.66	121.89

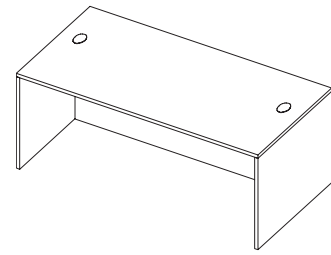

This desk can be used alone or connected to a bridge or return to complete a full workstation. Full modesty recessed in 8 inches for guests. Allows for fixed and modular underdesk storage.

Ordering Options:

Use the following checklist to customize the finishes on your order:

- laminate
- trim color
- edge profile
- grommet color

Each laminate comes with matching vinyl trim color unless otherwise specified on your purchase order. Refer to the laminate finish card for our current offering.

Details:

Full modesty recessed in 8 inches.

Grommets are available in black or silver. Black is the standard grommet option unless otherwise specified on your purchase order

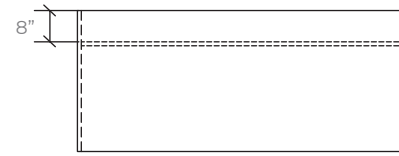

Code	Price	H	W	D	Volume (ft ³)	Weight (lb)
K-TSRG-6030	1257	29.5	60	30	6.3	156.7
K-TSRG-6630	1303	29.5	66	30	6.89	168.23
K-TSRG-7230	1364	29.5	72	30	7.48	179.76
K-TSRG-7830	1442	29.5	78	30	8.07	191.29
K-TSRG-8430	1511	29.5	84	30	8.66	202.82
K-TSRG-6036	1456	29.5	60	36	7.41	178.2
K-TSRG-6636	1511	29.5	66	36	8.1	190.8
K-TSRG-7236	1569	29.5	72	36	8.8	203.4
K-TSRG-7836	1637	29.5	78	36	9.49	216
K-TSRG-8436	1696	29.5	84	36	10.19	228.6

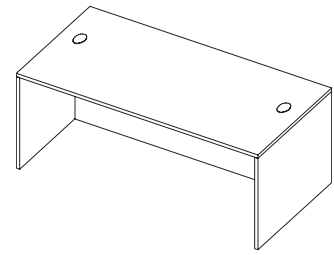

Ordering Options:

Use the following checklist to customize the finishes on your order:

- laminate
- trim color
- grommet color

Each laminate comes with matching vinyl trim color unless otherwise specified on your purchase order. Refer to the laminate finish card for our current offering.

Details:

Full modesty recessed in 8 inches.

Grommets are available in black or silver. Black is the standard grommet option unless otherwise specified on your purchase order

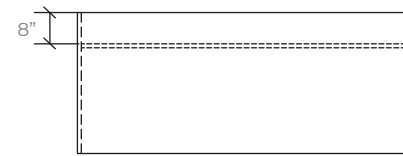

Code	Price	H	W	D	Volume (ft ³)	Weight (lb)
KL-TSRG-6030	1164	29	60	30	6.3	137.93
KL-TSRG-6630	1209	29	66	30	6.89	149.46
KL-TSRG-7230	1262	29	72	30	7.48	160.99
KL-TSRG-7830	1332	29	78	30	8.07	172.52
KL-TSRG-8430	1397	29	84	30	8.66	184.05
KL-TSRG-6036	1348	29	60	36	7.41	150.3
KL-TSRG-6636	1397	29	66	36	8.1	160.2
KL-TSRG-7236	1451	29	72	36	8.8	170.1
KL-TSRG-7836	1515	29	78	36	9.49	180
KL-TSRG-8436	1571	29	84	36	10.19	189.9

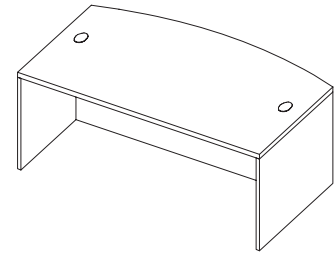

This desk can be used alone or connected to a bridge or return to complete a full workstation. Full modesty recessed in 8 inches for guests. Allows for fixed and modular underdesk storage.

Ordering Options:

Use the following checklist to customize the finishes on your order:

- laminate
- trim color
- edge profile
- grommet color

Each laminate comes with matching vinyl trim color unless otherwise specified on your purchase order. Refer to the laminate finish card for our current offering.

Details:

Full modesty recessed in 8 inches.

Grommets are available in black or silver. Black is the standard grommet option unless otherwise specified on your purchase order

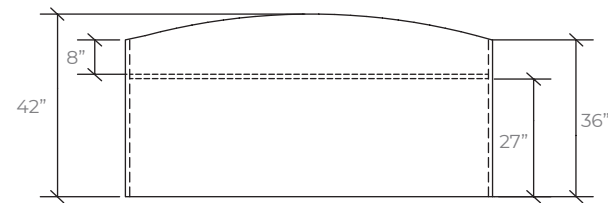

Code	Price	H	W	D	Volume (ft ³)	Weight (lb)
K-TARG-7236	1819	29.5	72	36	8.8	216.17
K-TARG-7836	1903	29.5	78	36	9.49	230.43
K-TARG-8436	1988	29.5	84	36	10.19	244.69

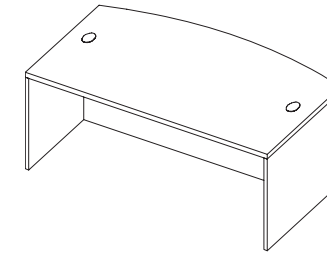

Ordering Options:

Use the following checklist to customize the finishes on your order:

- laminate
- trim color
- grommet color

Each laminate comes with matching vinyl trim color unless otherwise specified on your purchase order. Refer to the laminate finish card for our current offering.

Details:

Full modesty recessed in 8 inches.

Grommets are available in black or silver. Black is the standard grommet option unless otherwise specified on your purchase order

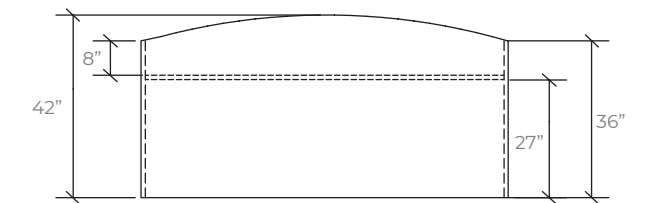

Code	Price	H	W	D	Volume (ft ³)	Weight (lb)
KL-TARG-7236	1692	29	72	36	8.8	178.09
KL-TARG-7836	1776	29	78	36	9.49	188.84
KL-TARG-8436	1864	29	84	36	10.19	199.59

Metro Collab
January 2026
Tables

Executive

D-table	36
J-table	38
P-table	40
F-table	42
U-table	44
C-table	46

Professional

D-table	37
J-table	39
P-table	41
F-table	43
U-table	45
C-table	47

This table is semi-supported and must be used with two freestanding desks or credenzas.

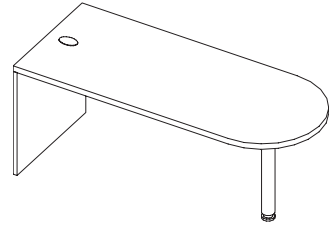

D-Table, 1.5" Thick Surface

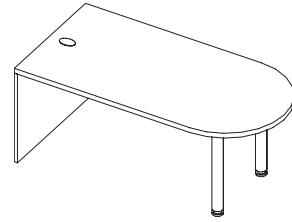

36" depth come with 2 posts

Ordering Options:

Use the following checklist to customize the finishes on your order:

- laminate
- trim color
- edge profile
- grommet color
- metal color (posts)

Each laminate comes with matching vinyl trim color unless otherwise specified on your purchase order. Refer to the laminate finish card for our current offering.

Details:

Grommets are available in black or silver. Black is the standard grommet option unless otherwise specified on your purchase order.

36 inch surface depth requires 2 posts.

Code	Price	H	W	D	Volume (ft ³)	Weight (lb)
K-TD0G-6030	1502	29.5	60	30	5.04	108.29
K-TD0G-6630	1550	29.5	66	30	5.51	117.27
K-TD0G-7230	1603	29.5	72	30	5.98	126.25
K-TD0G-7830	1651	29.5	78	30	6.45	135.23
K-TD0G-8430	1699	29.5	84	30	6.93	144.21
K-TD0G-6036	1612	29.5	60	36	5.93	131.34
K-TD0G-6636	1675	29.5	66	36	6.48	141.76
K-TD0G-7236	1711	29.5	72	36	7.04	152.18
K-TD0G-7836	1756	29.5	78	36	7.59	162.6
K-TD0G-8436	1807	29.5	84	36	8.15	173.02

This table is semi-supported and must be used with two freestanding desks or credenzas.

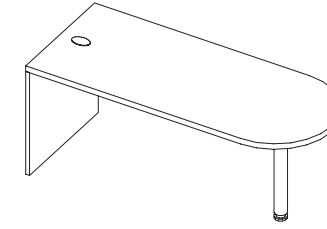

D-Table, 1.5" Thick Surface

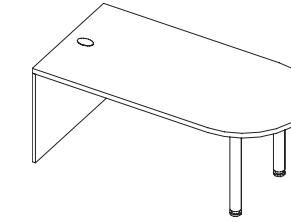

36" depth come with 2 posts

Ordering Options:

Use the following checklist to customize the finishes on your order:

- laminate
- trim color
- grommet color
- metal color (posts)

Each laminate comes with matching vinyl trim color unless otherwise specified on your purchase order. Refer to the laminate finish card for our current offering.

Details:

Grommets are available in black or silver. Black is the standard grommet option unless otherwise specified on your purchase order.

36 inch surface depth requires 2 posts.

Code	Price	H	W	D	Volume (ft ³)	Weight (lb)
KL-TD0G-6030	1232	29	60	30	5.04	86.48
KL-TD0G-6630	1285	29	66	30	5.51	92.95
KL-TD0G-7230	1331	29	72	30	5.98	99.42
KL-TD0G-7830	1379	29	78	30	6.45	105.9
KL-TD0G-8430	1432	29	84	30	6.93	112.38
KL-TD0G-6036	1344	29	60	36	5.93	107.18
KL-TD0G-6636	1403	29	66	36	6.48	115.76
KL-TD0G-7236	1442	29	72	36	7.04	124.34
KL-TD0G-7836	1490	29	78	36	7.59	132.92
KL-TD0G-8436	1542	29	84	36	8.15	141.5

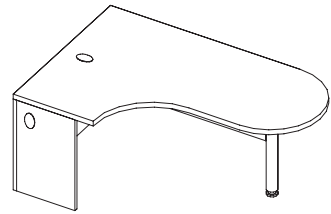

This table should be connected to a bridge or return to complete a full workstation (right hand shown).

J-Table, 1.5" Thick Surface

Ordering Options:

Use the following checklist to customize the finishes on your order:

- laminate
- trim color
- edge profile
- grommet color
- metal color (posts)

Each laminate comes with matching vinyl trim color unless otherwise specified on your purchase order. Refer to the laminate finish card for our current offering.

Details:

Grommets are available in black or silver. Black is the standard grommet option unless otherwise specified on your purchase order.

Item includes worksurface, 1 post leg, and mounting hardware.

All gables include grommets.

Code	Price	H	W	D	Volume (ft ³)	Weight (lb)
Left Hand						
K-TJ0G-604824-L	1979	29.5	60	24	6.22	149.48
K-TJ0G-664824-L	2111	29.5	66	24	6.81	158.56
K-TJ0G-724824-L	2219	29.5	72	24	7.39	167.64
K-TJ0G-784824-L	2335	29.5	78	24	7.97	176.72
K-TJ0G-844824-L	2446	29.5	84	24	8.56	185.8
Right Hand						
K-TJ0G-604824-R	1979	29.5	60	24	6.22	149.48
K-TJ0G-664824-R	2111	29.5	66	24	6.81	158.56
K-TJ0G-724824-R	2219	29.5	72	24	7.39	167.64
K-TJ0G-784824-R	2335	29.5	78	24	7.97	176.72
K-TJ0G-844824-R	2446	29.5	84	24	8.56	185.8

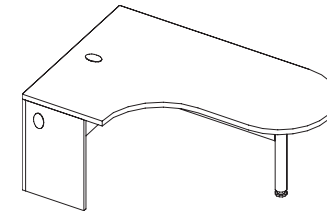

This table should be connected to a bridge or return to complete a full workstation (right hand shown).

Ordering Options:

Use the following checklist to customize the finishes on your order:

- laminate
- trim color
- grommet color
- metal color (posts)

Each laminate comes with matching vinyl trim color unless otherwise specified on your purchase order. Refer to the laminate finish card for our current offering.

Details:

Grommets are available in black or silver. Black is the standard grommet option unless otherwise specified on your purchase order.

Item includes worksurface, 1 post leg, and mounting hardware.

All gables include grommets.

Code	Price	H	W	D	Volume (ft ³)	Weight (lb)
Left Hand						
KL-TJ0G-604824L	1846	29	60	24	6.22	120.67
KL-TJ0G-664824L	1981	29	66	24	6.81	127.15
KL-TJ0G-724824L	2087	29	72	24	7.39	133.63
KL-TJ0G-784824L	2206	29	78	24	7.97	140.11
KL-TJ0G-844824L	2313	29	84	24	8.56	146.59
Right Hand						
KL-TJ0G-604824R	1846	29	60	24	6.22	120.67
KL-TJ0G-664824R	1981	29	66	24	6.81	127.15
KL-TJ0G-724824R	2087	29	72	24	7.39	133.63
KL-TJ0G-784824R	2206	29	78	24	7.97	140.11
KL-TJ0G-844824R	2313	29	84	24	8.56	146.59

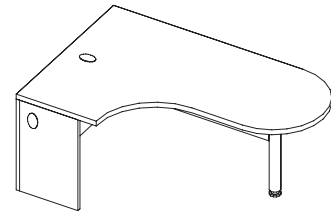

This table should be connected to a bridge or return to complete a full workstation (right hand shown).

J-Table, 1.5" Thick Surface

Ordering Options:

Use the following checklist to customize the finishes on your order:

- laminate
- trim color
- edge profile
- grommet color
- metal color (posts)

Each laminate comes with matching vinyl trim color unless otherwise specified on your purchase order. Refer to the laminate finish card for our current offering.

Details:

Grommets are available in black or silver. Black is the standard grommet option unless otherwise specified on your purchase order.

Item includes worksurface, 1 post leg, and mounting hardware.

All gables include grommets.

Code	Price	H	W	D	Volume (ft ³)	Weight (lb)
Left Hand						
K-TP0G-6030-L	1819	29.5	60	30	7.56	119.92
K-TP0G-6630-L	1903	29.5	66	30	8.26	128.78
K-TP0G-7230-L	1967	29.5	72	30	8.97	137.64
K-TP0G-7830-L	2046	29.5	78	30	9.68	146.5
K-TP0G-8430-L	2119	29.5	84	30	10.39	155.36
Right Hand						
K-TP0G-6030-R	1819	29.5	60	30	7.56	119.92
K-TP0G-6630-R	1903	29.5	66	30	8.26	128.78
K-TP0G-7230-R	1967	29.5	72	30	8.97	137.64
K-TP0G-7830-R	2046	29.5	78	30	9.68	146.5
K-TP0G-8430-R	2119	29.5	84	30	10.39	155.36

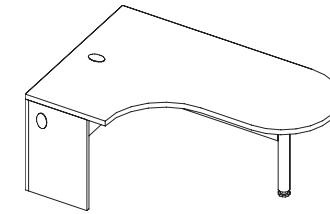

This table should be connected to a bridge or return to complete a full workstation (right hand shown).

Ordering Options:

Use the following checklist to customize the finishes on your order:

- laminate
- trim color
- grommet color
- metal color (posts)

Each laminate comes with matching vinyl trim color unless otherwise specified on your purchase order. Refer to the laminate finish card for our current offering.

Details:

Grommets are available in black or silver. Black is the standard grommet option unless otherwise specified on your purchase order.

Item includes worksurface, 1 post leg, and mounting hardware.

All gables include grommets.

Code	Price	H	W	D	Volume (ft ³)	Weight (lb)
Left Hand						
KL-TP0G-6030-L	1692	29	60	30	7.56	96.51
KL-TP0G-6630-L	1776	29	66	30	8.26	103.34
KL-TP0G-7230-L	1838	29	72	30	8.97	110.17
KL-TP0G-7830-L	1917	29	78	30	9.68	117
KL-TP0G-8430-L	1989	29	84	30	10.39	123.83
Right Hand						
KL-TP0G-6030-R	1692	29	60	30	7.56	96.51
KL-TP0G-6630-R	1776	29	66	30	8.26	103.34
KL-TP0G-7230-R	1838	29	72	30	8.97	110.17
KL-TP0G-7830-R	1917	29	78	30	9.68	117
KL-TP0G-8430-R	1989	29	84	30	10.39	123.83

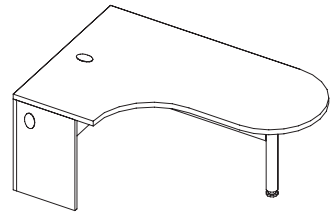

This table should be connected to a bridge or return to complete a full workstation (right hand shown).

F-Table, 1.5" Thick Surface

Ordering Options:

Use the following checklist to customize the finishes on your order:

- laminate
- trim color
- edge profile
- grommet color
- metal color (posts)

Each laminate comes with matching vinyl trim color unless otherwise specified on your purchase order. Refer to the laminate finish card for our current offering.

Details:

Grommets are available in black or silver. Black is the standard grommet option unless otherwise specified on your purchase order.

Item includes worksurface, 1 post leg, and mounting hardware.

All gables include grommets.

Code	Price	H	W	D	Volume (ft ³)	Weight (lb)
Left Hand						
K-TFSG-604824-L	2328	29.5	60	24	7.26	152.9
K-TFSG-664824-L	2377	29.5	66	24	7.94	161.05
K-TFSG-724824-L	2427	29.5	72	24	8.62	169.2
K-TFSG-784824-L	2473	29.5	78	24	9.3	177.35
K-TFSG-844824-L	2523	29.5	84	24	9.98	185.5
Right Hand						
K-TFSG-604824-R	2328	29.5	60	24	7.26	152.9
K-TFSG-664824-R	2377	29.5	66	24	7.94	161.05
K-TFSG-724824-R	2427	29.5	72	24	8.62	169.2
K-TFSG-784824-R	2473	29.5	78	24	9.3	177.35
K-TFSG-844824-R	2523	29.5	84	24	9.98	185.5

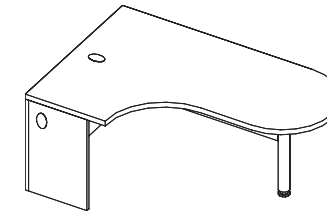

This table should be connected to a bridge or return to complete a full workstation (right hand shown).

Ordering Options:

Use the following checklist to customize the finishes on your order:

- laminate
- trim color
- grommet color
- metal color (posts)

Each laminate comes with matching vinyl trim color unless otherwise specified on your purchase order. Refer to the laminate finish card for our current offering.

Details:

Grommets are available in black or silver. Black is the standard grommet option unless otherwise specified on your purchase order.

Item includes worksurface, 1 post leg, and mounting hardware.

All gables include grommets.

Code	Price	H	W	D	Volume (ft ³)	Weight (lb)
Left Hand						
KL-TFSG-604824L	2254	29	60	24	7.26	123.35
KL-TFSG-664824L	2292	29	66	24	7.94	129.35
KL-TFSG-724824L	2333	29	72	24	8.62	135.35
KL-TFSG-784824L	2373	29	78	24	9.3	141.35
KL-TFSG-844824L	2412	29	84	24	9.98	147.35
Right Hand						
KL-TFSG-604824R	2254	29	60	24	7.26	123.35
KL-TFSG-664824R	2292	29	66	24	7.94	129.35
KL-TFSG-724824R	2333	29	72	24	8.62	135.35
KL-TFSG-784824R	2373	29	78	24	9.3	141.35
KL-TFSG-844824R	2412	29	84	24	9.98	147.35

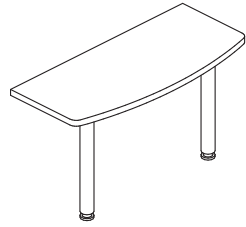

This table is semi-supported and must be used against freestanding furniture. It is typically used as an additional surface in conjunction with two workstation returns.

U-Table, 1.5" Thick Surface

Ordering Options:

Use the following checklist to customize the finishes on your order:

- laminate
- trim color
- edge profile
- grommet color
- metal color (posts)

Each laminate comes with matching vinyl trim color unless otherwise specified on your purchase order. Refer to the laminate finish card for our current offering.

Details:

Item includes worksurface, 2 post legs, and mounting hardware.

Code	Price	H	W	D	Volume (ft ³)	Weight (lb)
T-WEU0-4224	1112	29.5	42	24	2.98	51.19
T-WEU0-4824	1149	29.5	48	24	3.37	56.54
T-WEU0-6024	1356	29.5	60	24	4.15	61.88

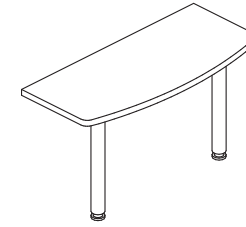

This table is semi-supported and must be used against freestanding furniture. It is typically used as an additional surface in conjunction with two workstation returns.

Ordering Options:

Use the following checklist to customize the finishes on your order:

- laminate
- trim color
- grommet color
- metal color (posts)

Each laminate comes with matching vinyl trim color unless otherwise specified on your purchase order. Refer to the laminate finish card for our current offering.

Details:

Code	Price	H	W	D	Volume (ft ³)	Weight (lb)
TL-WEU0-4224	960	29	42	24	2.98	38.79
TL-WEU0-4824	997	29	48	24	3.37	42.36
TL-WEU0-6024	1204	29	60	24	4.15	45.92

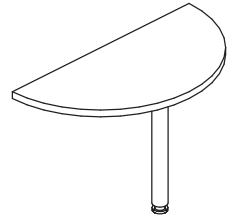

This table is semi-supported and must be used against freestanding furniture. It is typically used as an additional surface in conjunction with two workstation returns.

D-Table, 1.5" Thick Surface

Ordering Options:

Use the following checklist to customize the finishes on your order:

- laminate
- trim color
- edge profile
- grommet color
- metal color (posts)

Each laminate comes with matching vinyl trim color unless otherwise specified on your purchase order. Refer to the laminate finish card for our current offering.

Details:

Item includes worksurface, one post leg, and mounting hardware.

Code	Price	H	W	D	Volume (ft ³)	Weight (lb)
T-TC00-4221	801	29.5	42	21	2	34
T-TC00-4824	921	29.5	48	24	2.53	42.1
T-TC00-6030	1038	29.5	60	30	3.78	50

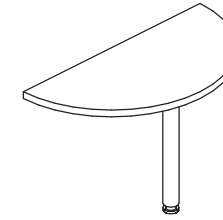

This table is semi-supported and must be used against freestanding furniture. It is typically used as an additional surface in conjunction with two workstation returns.

Ordering Options:

Use the following checklist to customize the finishes on your order:

- laminate
- trim color
- grommet color
- metal color (posts)

Each laminate comes with matching vinyl trim color unless otherwise specified on your purchase order. Refer to the laminate finish card for our current offering.

Details:

Item includes worksurface, one post leg, and mounting hardware.

Code	Price	H	W	D	Volume (ft ³)	Weight (lb)
TL-TC00-4221	744	29	42	21	2	25
TL-TC00-4824	862	29	48	24	2.53	30.56
TL-TC00-6030	982	29	60	30	3.78	36.12

Executive

<u>straight front corner surface</u>	
full modesty	50
partial modesty	52
<u>curved front corner surface</u>	
full modesty	54
partial modesty	56

Professional

<u>straight front corner surface</u>	
full modesty	51
partial modesty	53
<u>curved front corner surface</u>	
full modesty	55
partial modesty	57

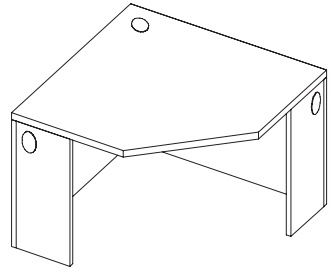

This item is for use in corners when connected to returns or bridges.

Straight Front Corner Surface
Full Modesty, 1.5" Thick Surface

Ordering Options:

Use the following checklist to customize the finishes on your order:

- laminate
- trim color
- edge profile
- grommet color

Each laminate comes with matching vinyl trim color unless otherwise specified on your purchase order. Refer to the laminate finish card for our current offering.

Details:

Grommets are available in black or silver. Black is the standard grommet option unless otherwise specified on your purchase order.

All gables include grommets.

Code	Price	H	W	D	Volume (ft ³)	Weight (lb)
K-W5S0-3621	1233	29.5	36	21	2.89	114.3
K-W5S0-3624	1233	29.5	36	24	3.24	116.21
K-W5S0-4221	1451	29.5	42	21	3.33	137.24
K-W5S0-4224	1451	29.5	42	24	3.73	139.52

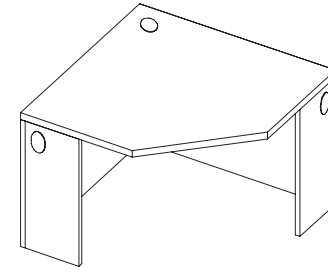

This item is for use in corners when connected to returns or bridges.

Straight Front Corner Surface
Full Modesty, 1" Thick Surface

Ordering Options:

Use the following checklist to customize the finishes on your order:

- laminate
- trim color
- grommet color

Each laminate comes with matching vinyl trim color unless otherwise specified on your purchase order. Refer to the laminate finish card for our current offering.

Details:

Grommets are available in black or silver. Black is the standard grommet option unless otherwise specified on your purchase order.

All gables include grommets.

Code	Price	H	W	D	Volume (ft ³)	Weight (lb)
KL-W5S0-3621	1145	29	36	21	2.89	99.2
KL-W5S0-3624	1145	29	36	24	3.24	100.27
KL-W5S0-4221	1345	29	42	21	3.33	117.14
KL-W5S0-4224	1345	29	42	24	3.73	118.66

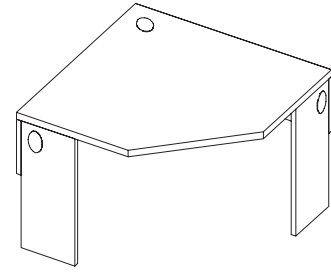

This item is for use in corners when connected to returns or bridges. Partial modesty allows access to electrical outlets when installed against walls.

Straight Front Corner Surface Partial Modesty & Post, 1.5" Thick Surface

Ordering Options:

Use the following checklist to customize the finishes on your order:

- laminate
- trim color
- edge profile
- grommet color

Each laminate comes with matching vinyl trim color unless otherwise specified on your purchase order. Refer to the laminate finish card for our current offering.

Details:

Partial modesty height 12 inches.
 Grommets are available in black or silver. Black is the standard grommet option unless otherwise specified on your purchase order.
 All gables include grommets.
 Metal post leg included.

Code	Price	H	W	D	Volume (ft ³)	Weight (lb)
K-W5S0-3621-P	1233	29.5	36	21	2.89	84.74
K-W5S0-3624-P	1233	29.5	36	24	3.24	86.65
K-W5S0-4221-P	1451	29.5	42	21	3.33	102.88
K-W5S0-4224-P	1451	29.5	42	24	3.73	105.16

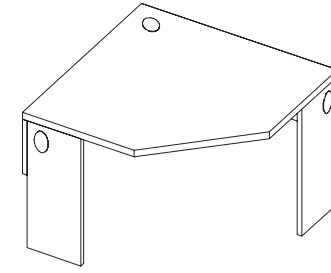

This item is for use in corners when connected to returns or bridges. Partial modesty allows access to electrical outlets when installed against walls.

Straight Front Corner Surface Partial Modesty & Post, 1" Thick Surface

Ordering Options:

Use the following checklist to customize the finishes on your order:

- laminate
- trim color
- grommet color

Each laminate comes with matching vinyl trim color unless otherwise specified on your purchase order. Refer to the laminate finish card for our current offering.

Details:

Partial modesty height 12 inches.
 Grommets are available in black or silver. Black is the standard grommet option unless otherwise specified on your purchase order.
 All gables include grommets.
 Metal post leg included.

Code	Price	H	W	D	Volume (ft ³)	Weight (lb)
KL-W5S0-3621-P	1145	29	36	21	2.89	69.94
KL-W5S0-3624-P	1145	29	36	24	3.24	70.71
KL-W5S0-4221-P	1345	29	42	21	3.33	82.78
KL-W5S0-4224-P	1345	29	42	24	3.73	84.3

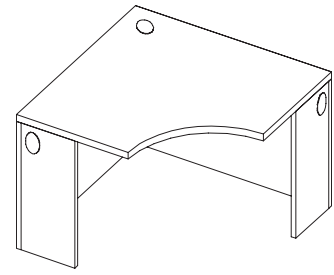

This item is for use in corners when connected to returns or bridges.

Curved Front Corner Surface
Full Modesty, 1.5" Thick Surface

Ordering Options:

Use the following checklist to customize the finishes on your order:

- laminate
- trim color
- edge profile
- grommet color

Each laminate comes with matching vinyl trim color unless otherwise specified on your purchase order. Refer to the laminate finish card for our current offering.

Details:

Grommets are available in black or silver. Black is the standard grommet option unless otherwise specified on your purchase order.

All gables include grommets

Code	Price	H	W	D	Volume (ft ³)	Weight (lb)
K-W5C0-3621	1233	29.5	36	21	2.89	112.21
K-W5C0-3624	1233	29.5	36	24	3.24	114.6
K-W5C0-4221	1451	29.5	42	21	3.33	132.52
K-W5C0-4224	1451	29.5	42	24	3.73	136.12

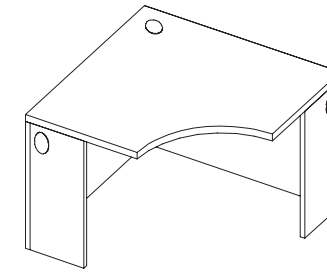

This item is for use in corners when connected to returns or bridges.

Curved Front Corner Surface Full Modesty, 1" Thick Surface

Ordering Options:

Use the following checklist to customize the finishes on your order:

- laminate
- trim color
- grommet color

Each laminate comes with matching vinyl trim color unless otherwise specified on your purchase order. Refer to the laminate finish card for our current offering.

Details:

Grommets are available in black or silver. Black is the standard grommet option unless otherwise specified on your purchase order.

All gables include grommets

Code	Price	H	W	D	Volume (ft ³)	Weight (lb)
KL-W5C0-3621	1145	29	36	21	2.89	97.54
KL-W5C0-3624	1145	29	36	24	3.24	98.3
KL-W5C0-4221	1345	29	42	21	3.33	113.86
KL-W5C0-4224	1345	29	42	24	3.73	116.26

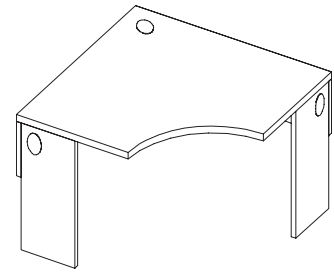

This item is for use in corners when connected to returns or bridges. Partial modesty give access to electrical outlets when installed against walls.

Curved Front Corner Surface
Partial Modesty & Post,
1.5" Thick Surface

Ordering Options:

Use the following checklist to customize the finishes on your order:

- laminate
- trim color
- edge profile
- grommet color

Each laminate comes with matching vinyl trim color unless otherwise specified on your purchase order. Refer to the laminate finish card for our current offering.

Details:

Partial modesty height 12 inches.
Grommets are available in black or silver. Black is the standard grommet option unless otherwise specified on your purchase order.
All gables include grommets.
Metal post included.

Code	Price	H	W	D	Volume (ft ³)	Weight (lb)
K-W5C0-3621-P	1233	29.5	36	21	2.89	82.62
K-W5C0-3624-P	1233	29.5	36	24	3.24	85.1
K-W5C0-4221-P	1451	29.5	42	21	3.33	94.27
K-W5C0-4224-P	1451	29.5	42	24	3.73	97.87

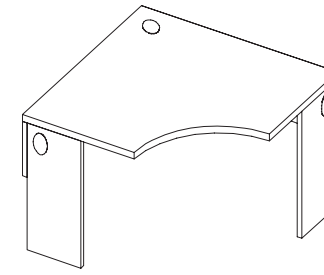

This item is for use in corners when connected to returns or bridges. Partial modesty give access to electrical outlets when installed against walls.

Ordering Options:

Use the following checklist to customize the finishes on your order:

- laminate
- trim color
- grommet color

Each laminate comes with matching vinyl trim color unless otherwise specified on your purchase order. Refer to the laminate finish card for our current offering.

Details:

Partial modesty height 12 inches.
Grommets are available in black or silver. Black is the standard grommet option unless otherwise specified on your purchase order.
All gables include grommets.
Metal post included.

Code	Price	H	W	D	Volume (ft ³)	Weight (lb)
KL-W5C0-3621-P	1145	29	36	21	2.89	67.98
KL-W5C0-3624-P	1145	29	36	24	3.24	68.74
KL-W5C0-4221-P	1345	29	42	21	3.33	75.61
KL-W5C0-4224-P	1345	29	42	24	3.73	78.01

Code	Price	W	D	Description
KL-WTLC-3636	762	36	36	0 29CORNER C/T,F/36X36,1" T8
KL-WTLC-4242	790	42	42	0 CORNER C/T,F/42X42,1" T10
KL-WTLC-4848	834	48	48	0 CORNER C/T,F/48X48,1" T12



Metro Collab
January 2026
**Unitized
Desks**

unitized desks

Executive

curved front unitized desk

full modesty 60

partial modesty 62

Professional

curved front unitized desk

full modesty 61

partial modesty 63

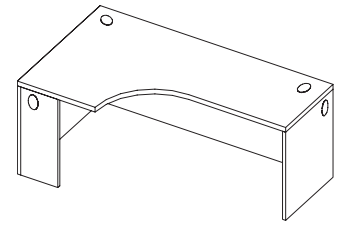

This item is for use in corners when connected to returns or bridges (right hand shown).

Curved Front Unitized Desk Full Modesty, 1.5" Thick Surface

Ordering Options:

Use the following checklist to customize the finishes on your order:

- laminate
- trim color
- edge profile
- grommet color

Each laminate comes with matching vinyl trim color unless otherwise specified on your purchase order. Refer to the laminate finish card for our current offering.

Details:

Grommets are available in black or silver. Black is the standard grommet option unless otherwise specified on your purchase order.

All gables include grommets.

Code	Price	H	W	D	Volume (ft ³)	Weight (lb)
K-UC4G-6639-L	1900	29.5	66	39	10.45	146.65
K-UC4G-7239-L	2024	29.5	72	39	11.35	181.17
K-UC4G-6639-R	1900	29.5	66	39	10.45	146.65
K-UC4G-7239-R	2024	29.5	72	39	11.35	181.17
K-UC4G-6642-L	1979	29.5	66	42	11.18	184.39
K-UC4G-7242-L	2373	29.5	72	42	12.14	194.16
K-UC4G-6642-R	1979	29.5	66	42	11.18	184.39
K-UC4G-7242-R	2373	29.5	72	42	12.14	194.16

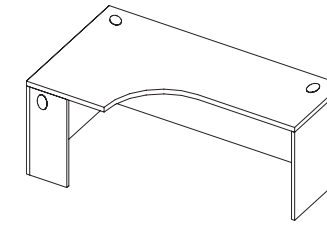

This item is for use in corners when connected to returns or bridges (right hand shown).

Ordering Options:

Use the following checklist to customize the finishes on your order:

- laminate
- trim color
- grommet color

Each laminate comes with matching vinyl trim color unless otherwise specified on your purchase order. Refer to the laminate finish card for our current offering.

Details:

Grommets are available in black or silver. Black is the standard grommet option unless otherwise specified on your purchase order.

All gables include grommets.

Code	Price	H	W	D	Volume (ft ³)	Weight (lb)
KL-UC4G-6639-L	1763	29	66	39	10.45	120.6
KL-UC4G-7239-L	1874	29	72	39	11.35	153.9
KL-UC4G-6639-R	1763	29	66	39	10.45	120.6
KL-UC4G-7239-R	1874	29	72	39	11.35	153.9
KL-UC4G-6642-L	1833	29	66	42	11.18	161.1
KL-UC4G-7242-L	2200	29	72	42	12.14	170.55
KL-UC4G-6642-R	1833	29	66	42	11.18	161.1
KL-UC4G-7242-R	2200	29	72	42	12.14	170.55

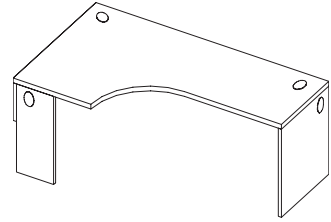

This item is for use in corners when connected to returns or bridges. Partial modesty gives access to electrical outlets when placed against walls (right hand shown).

Curved Front Unitized Desk
Partial Modesty, 1.5" Thick Surface

Ordering Options:

Use the following checklist to customize the finishes on your order:

- laminate
- trim color
- edge profile
- grommet color

Each laminate comes with matching vinyl trim color unless otherwise specified on your purchase order. Refer to the laminate finish card for our current offering.

Details:

Partial modesty height 12 inches.
Grommets are available in black or silver. Black is the standard grommet option unless otherwise specified on your purchase order.
All gables include grommets

Code	Price	H	W	D	Volume (ft ³)	Weight (lb)
K-UC4Z-6639-L	1900	29.5	66	39	10.45	146.65
K-UC4Z-7239-L	2024	29.5	72	39	11.35	181.17
K-UC4Z-6639-R	1900	29.5	66	39	10.45	146.65
K-UC4Z-7239-R	2024	29.5	72	39	11.35	181.17
K-UC4Z-6642-L	1979	29.5	66	42	11.18	184.39
K-UC4Z-7242-L	2373	29.5	72	42	12.14	194.16
K-UC4Z-6642-R	1979	29.5	66	42	11.18	184.39
K-UC4Z-7242-R	2373	29.5	72	42	12.14	194.16

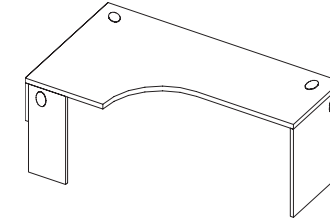

This item is for use in corners when connected to returns or bridges. Partial modesty gives access to electrical outlets when placed against walls (right hand shown).

Curved Front Unitized Desk
Partial Modesty, 1" Thick Surface

Ordering Options:

Use the following checklist to customize the finishes on your order:

- laminate
- trim color
- grommet color

Each laminate comes with matching vinyl trim color unless otherwise specified on your purchase order. Refer to the laminate finish card for our current offering.

Details:

Partial modesty height 12 inches.
Grommets are available in black or silver. Black is the standard grommet option unless otherwise specified on your purchase order.
All gables include grommets

Code	Price	H	W	D	Volume (ft ³)	Weight (lb)
KL-UC4Z-6639-L	1763	29	66	39	10.45	99.79
KL-UC4Z-7239-L	1874	29	72	39	11.35	108.77
KL-UC4Z-6639-R	1763	29	66	39	10.45	99.79
KL-UC4Z-7239-R	1874	29	72	39	11.35	108.77
KL-UC4Z-6642-L	1833	29	66	42	11.18	114.66
KL-UC4Z-7242-L	2200	29	72	42	12.14	126.11
KL-UC4Z-6642-R	1833	29	66	42	11.18	114.66
KL-UC4Z-7242-R	2200	29	72	42	12.14	126.11



Metro Collab
January 2026
Bridges

Executive

straight bridge

full modesty 66

partial modesty 68

Professional

straight bridge

full modesty 67

partial modesty 69

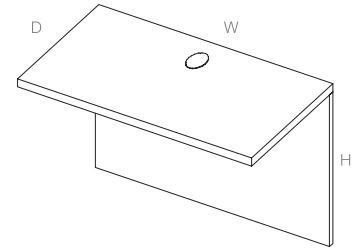

This bridge must be connected to two freestanding desks or credenza. Corners and unitized desks with matching depths can also be connected on either side to complete a workstation.

Straight Bridge Full Modesty, 1.5" Thick Surface

Ordering Options:

Use the following checklist to customize the finishes on your order:

- laminate
- trim color
- edge profile
- grommet color

Each laminate comes with matching vinyl trim color unless otherwise specified on your purchase order. Refer to the laminate finish card for our current offering.

Details:

Grommets are available in black or silver. Black is the standard grommet option unless otherwise specified on your purchase order.

Code	Price	H	W	D	Volume (ft ³)	Weight (lb)
K-BS0G-3021	572	29.5	30	21	1.48	46.17
K-BS0G-3621	616	29.5	36	21	1.74	55.5
K-BS0G-4221	687	29.5	42	21	2	64.83
K-BS0G-4821	730	29.5	48	21	2.26	74.16
K-BS0G-3024	598	29.5	30	24	1.65	49.5
K-BS0G-3624	642	29.5	36	24	1.94	60
K-BS0G-4224	712	29.5	42	24	2.24	70.5
K-BS0G-4824	801	29.5	48	24	2.53	81
K-BS0G-3030	642	29.5	30	30	2.01	56.75
K-BS0G-3630	704	29.5	36	30	2.36	68.28
K-BS0G-4230	778	29.5	42	30	2.72	79.81
K-BS0G-4830	877	29.5	48	30	3.07	91.34

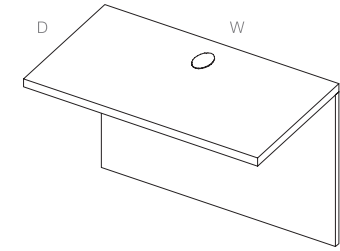

This bridge must be connected to two freestanding desks or credenza. Corners and unitized desks with matching depths can also be connected on either side to complete a workstation.

Straight Bridge Full Modesty, 1" Thick Surface

Ordering Options:

Use the following checklist to customize the finishes on your order:

- laminate
- trim color
- grommet color

Each laminate comes with matching vinyl trim color unless otherwise specified on your purchase order. Refer to the laminate finish card for our current offering.

Details:

Grommets are available in black or silver. Black is the standard grommet option unless otherwise specified on your purchase order.

Code	Price	H	W	D	Volume (ft ³)	Weight (lb)
KL-BS0G-1824	540	29	18	24	0	35
KL-BS0G-2421	517	29	24	21	0	40.35
KL-BS0G-2424	540	29	24	24	0	40.35
KL-BS0G-3021	540	29	30	21	1.48	38
KL-BS0G-3024	565	29	30	24	1.65	40.35
KL-BS0G-3030	605	29	30	30	2.01	45.03
KL-BS0G-3621	582	29	36	21	1.74	45.78
KL-BS0G-3624	605	29	36	24	1.94	48.6
KL-BS0G-3630	661	29	36	30	2.36	54.22
KL-BS0G-4221	647	29	42	21	2	53.56
KL-BS0G-4224	667	29	42	24	2.24	56.85
KL-BS0G-4230	730	29	42	30	2.72	63.41
KL-BS0G-4821	691	29	48	21	2.26	61.34
KL-BS0G-4824	758	29	48	24	2.53	65.1
KL-BS0G-4830	826	29	48	30	3.07	72.6
KL-BS0G-5421	827	29	54	21	0	54
KL-BS0G-5424	827	29	54	24	0	0
KL-BS0G-6024	827	29	60	24	0	0

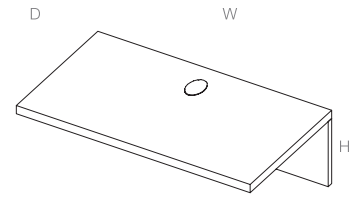

This bridge must be connected to two freestanding desks or credenza. Corners and unitized desks with matching depths can also be connected on either side. Partial modesty gives access to electrical outlets when installed against walls.

Straight Bridge Partial Modesty, 1.5" Thick Surface

Ordering Options:

Use the following checklist to customize the finishes on your order:

- laminate
- trim color
- edge profile
- grommet color

Each laminate comes with matching vinyl trim color unless otherwise specified on your purchase order. Refer to the laminate finish card for our current offering.

Details:

Partial modesty height 12 inches.

Grommets are available in black or silver. Black is the standard grommet option unless otherwise specified on your purchase order.

Code	Price	H	W	D	Volume (ft ³)	Weight (lb)
K-BS0Z-3021	572	29.5	30	21	1.48	33.67
K-BS0Z-3621	616	29.5	36	21	1.74	43
K-BS0Z-4221	687	29.5	42	21	2	52.33
K-BS0Z-4821	730	29.5	48	21	2.26	61.66
K-BS0Z-3024	598	29.5	30	24	1.65	33.3
K-BS0Z-3624	642	29.5	36	24	1.94	43.8
K-BS0Z-4224	712	29.5	42	24	2.24	54.3
K-BS0Z-4824	801	29.5	48	24	2.53	64.8
K-BS0Z-3030	642	29.5	30	30	2.01	44.1
K-BS0Z-3630	704	29.5	36	30	2.36	55.63
K-BS0Z-4230	877	29.5	42	30	2.72	67.16
K-BS0Z-4830	855	29.5	48	30	3.07	78.69

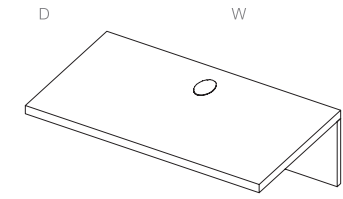

This bridge must be connected to two freestanding desks or credenza. Corners and unitized desks with matching depths can also be connected on either side. Partial modesty gives access to electrical outlets when installed against walls.

Straight Bridge Partial Modesty, 1" Thick Surface

Ordering Options:

Use the following checklist to customize the finishes on your order:

- laminate
- trim color
- grommet color

Each laminate comes with matching vinyl trim color unless otherwise specified on your purchase order. Refer to the laminate finish card for our current offering.

Details:

Grommets are available in black or silver. Black is the standard grommet option unless otherwise specified on your purchase order.

Code	Price	H	W	D	Volume (ft ³)	Weight (lb)
KL-BS0Z-1818	474	29	18	18	0	40
KL-BS0Z-1824	500	29	18	24	0	52.5
KL-BS0Z-2421	517	29	24	21	0	27.75
KL-BS0Z-2424	540	29	24	24	0	27.75
KL-BS0Z-2924	565	29	29	24	0	27.75
KL-BS0Z-3021	540	29	30	21	1.48	25.4
KL-BS0Z-3024	565	29	30	24	1.65	27.75
KL-BS0Z-3030	605	29	30	30	2.01	32.43
KL-BS0Z-3621	582	29	36	21	1.74	33.18
KL-BS0Z-3624	605	29	36	24	1.94	36
KL-BS0Z-3630	661	29	36	30	2.36	41.62
KL-BS0Z-4221	647	29	42	21	2	40.96



Metro Collab
January 2026
Returns

returns

Executive

straight return

full modesty 72

partial modesty 76

Professional

straight return

full modesty 74

partial modesty 78

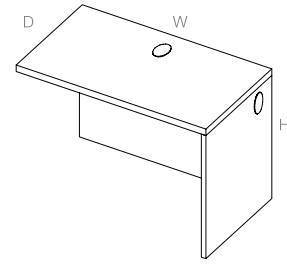

This return is semi-supported, it must be connected to a freestanding desk, corner desk or credenza. Allows for fixed and modular underdesk storage (right hand shown).

Straight Return Full Modesty, 1.5" Thick Surface

Ordering Options:

Use the following checklist to customize the finishes on your order:

- laminate
- trim color
- edge profile
- grommet color

Each laminate comes with matching vinyl trim color unless otherwise specified on your purchase order. Refer to the laminate finish card for our current offering.

Details:

Grommets are available in black or silver. Black is the standard grommet option unless otherwise specified on your purchase order.

Surfaces up to and including 48" wide have one grommet located at the back center of the surface. Surfaces 54" wide and greater have two grommets at either side of the back of the surface.

All gables include grommets.

Code	Price	H	W	D	Volume (ft ³)	Weight (lb)
K-WS1G-2421-L	838	29.5	24	21	1.62	51.3
K-WS1G-2421-R	838	29.5	24	21	1.62	51.3
K-WS1G-2424-L	849	29.5	24	24	1.81	56.65
K-WS1G-2424-R	849	29.5	24	24	1.81	56.65
K-WS1G-2430-L	923	29.5	24	30	2.2	66.42
K-WS1G-2430-R	923	29.5	24	30	2.2	66.42
K-WS1G-3021-L	849	29.5	30	21	1.97	60.74
K-WS1G-3021-R	849	29.5	30	21	1.97	60.74
K-WS1G-3024-L	861	29.5	30	24	2.2	65.92
K-WS1G-3024-R	861	29.5	30	24	2.2	65.92
K-WS1G-3030-L	946	29.5	30	30	2.68	77.42
K-WS1G-3030-R	946	29.5	30	30	2.68	77.42

Code	Price	H	W	D	Volume (ft ³)	Weight (lb)
K-WS1G-3621-L	861	29.5	36	21	2.31	70.18
K-WS1G-3621-R	861	29.5	36	21	2.31	70.18
K-WS1G-3624-L	877	29.5	36	24	2.59	75.19
K-WS1G-3624-R	877	29.5	36	24	2.59	75.19
K-WS1G-3630-L	982	29.5	36	30	3.15	88.42
K-WS1G-3630-R	982	29.5	36	30	3.15	88.42
K-WS1G-4221-L	877	29.5	42	21	2.66	79.62
K-WS1G-4221-R	877	29.5	42	21	2.66	79.62
K-WS1G-4224-L	900	29.5	42	24	2.98	84.46
K-WS1G-4224-R	900	29.5	42	24	2.98	84.46
K-WS1G-4230-L	1021	29.5	42	30	3.62	99.42
K-WS1G-4230-R	1021	29.5	42	30	3.62	99.42
K-WS1G-4821-L	923	29.5	48	21	3.01	89.06
K-WS1G-4821-R	923	29.5	48	21	3.01	89.06
K-WS1G-4824-L	946	29.5	48	24	3.37	93.73
K-WS1G-4824-R	946	29.5	48	24	3.37	93.73
K-WS1G-4830-L	1054	29.5	48	30	4.09	110.42
K-WS1G-4830-R	1054	29.5	48	30	4.09	110.42
K-WS1G-5421-L	969	29.5	54	21	3.36	98.5
K-WS1G-5421-R	969	29.5	54	21	3.36	98.5
K-WS1G-5424-L	993	29.5	54	24	3.76	103
K-WS1G-5424-R	993	29.5	54	24	3.76	103
K-WS1G-5430-L	1090	29.5	54	30	4.56	121.42
K-WS1G-5430-R	1090	29.5	54	30	4.56	121.42
K-WS1G-6021-L	1021	29.5	60	21	3.7	107.94
K-WS1G-6021-R	1021	29.5	60	21	3.7	107.94
K-WS1G-6024-L	1045	29.5	60	24	4.15	112.27
K-WS1G-6024-R	1045	29.5	60	24	4.15	112.27
K-WS1G-6030-L	1151	29.5	60	30	5.04	132.42
K-WS1G-6030-R	1151	29.5	60	30	5.04	132.42

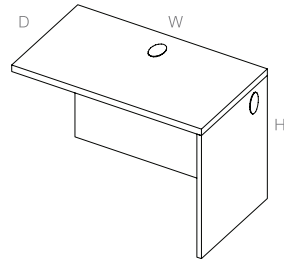

This return is semi-supported, it must be connected to a freestanding desk, corner desk or credenza. Allows for fixed and modular underdesk storage (right hand shown).

Straight Return Full Modesty, 1" Thick Surface

Ordering Options:

Use the following checklist to customize the finishes on your order:

- laminate
- trim color
- grommet color

Each laminate comes with matching vinyl trim color unless otherwise specified on your purchase order. Refer to the laminate finish card for our current offering.

Details:

Grommets are available in black or silver. Black is the standard grommet option unless otherwise specified on your purchase order.

Surfaces up to and including 48" wide have one grommet located at the back center of the surface. Surfaces 54" wide and greater have two grommets at either side of the back of the surface.

All gables include grommets.

Code	Price	H	W	D	Volume (ft ³)	Weight (lb)
KL-WS1G-3621-L	712	29	36	21	2.31	59.8
KL-WS1G-3621-R	712	29	36	21	2.31	59.8
KL-WS1G-3624-L	720	29	36	24	2.59	64.35
KL-WS1G-3624-R	720	29	36	24	2.59	64.35
KL-WS1G-3630-L	832	29	36	30	3.15	74.76
KL-WS1G-3630-R	832	29	36	30	3.15	74.76
KL-WS1G-4221-L	720	29	42	21	2.66	67.2
KL-WS1G-4221-R	720	29	42	21	2.66	67.2
KL-WS1G-4224-L	746	29	42	24	2.98	72.15
KL-WS1G-4224-R	746	29	42	24	2.98	72.15
KL-WS1G-4230-L	864	29	42	30	3.62	83.79
KL-WS1G-4230-R	864	29	42	30	3.62	83.79

Code	Price	H	W	D	Volume (ft ³)	Weight (lb)
KL-WS1G-4821-L	770	29	48	21	3.01	74.6
KL-WS1G-4821-R	770	29	48	21	3.01	74.6
KL-WS1G-4824-L	792	29	48	24	3.37	79.95
KL-WS1G-4824-R	792	29	48	24	3.37	79.95
KL-WS1G-4830-L	904	29	48	30	4.09	92.82
KL-WS1G-4830-R	904	29	48	30	4.09	92.82
KL-WS1G-5421-L	819	29	54	21	3.36	82
KL-WS1G-5421-R	819	29	54	21	3.36	82
KL-WS1G-5424-L	844	29	54	24	3.76	87.75
KL-WS1G-5424-R	844	29	54	24	3.76	87.75
KL-WS1G-5430-L	943	29	54	30	4.56	101.85
KL-WS1G-5430-R	943	29	54	30	4.56	101.85
KL-WS1G-6021-L	864	29	60	21	3.7	89.4
KL-WS1G-6021-R	864	29	60	21	3.7	89.4
KL-WS1G-6024-L	892	29	60	24	4.15	95.55
KL-WS1G-6024-R	892	29	60	24	4.15	95.55
KL-WS1G-6030-L	1004	29	60	30	5.04	110.88
KL-WS1G-6030-R	1004	29	60	30	5.04	110.88
KL-WS1Z-1824-L	700	29	18	24	0	30
K-WS1G-5421-R	969	29.5	54	21	3.36	98.5
K-WS1G-5424-L	993	29.5	54	24	3.76	103
K-WS1G-5424-R	993	29.5	54	24	3.76	103
K-WS1G-5430-L	1090	29.5	54	30	4.56	121.42
K-WS1G-5430-R	1090	29.5	54	30	4.56	121.42
K-WS1G-6021-L	1021	29.5	60	21	3.7	107.94
K-WS1G-6021-R	1021	29.5	60	21	3.7	107.94
K-WS1G-6024-L	1045	29.5	60	24	4.15	112.27
K-WS1G-6024-R	1045	29.5	60	24	4.15	112.27
K-WS1G-6030-L	1151	29.5	60	30	5.04	132.42
K-WS1G-6030-R	1151	29.5	60	30	5.04	132.42

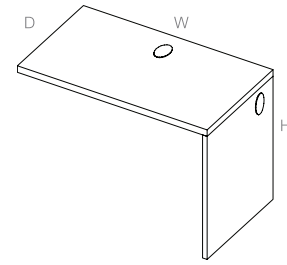

This return is semi-supported, it must be connected to a freestanding desk, corner desk or credenza. Allows for fixed and modular underdesk storage. Partial modesty gives access to electrical outlets when installed against walls (right hand shown).

Straight Return Partial Modesty, 1.5" Thick Surface

Ordering Options:

Use the following checklist to customize the finishes on your order:

- laminate
- trim color
- edge profile
- grommet color

Each laminate comes with matching vinyl trim color unless otherwise specified on your purchase order. Refer to the laminate finish card for our current offering.

Details:

Grommets are available in black or silver. Black is the standard grommet option unless otherwise specified on your purchase order.

Surfaces up to and including 48" wide have one grommet located at the back center of the surface. Surfaces 54" wide and greater have two grommets at either side of the back of the surface.

All gables include grommets.

Code	Price	H	W	D	Volume (ft ³)	Weight (lb)
K-WS1Z-2421-L	838	29.5	24	21	1.62	41.4
K-WS1Z-2421-R	838	29.5	24	21	1.62	41.4
K-WS1Z-2424-L	849	29.5	24	24	1.81	46.35
K-WS1Z-2424-R	849	29.5	24	24	1.81	46.35
K-WS1Z-2430-L	923	29.5	24	30	2.2	58.5
K-WS1Z-2430-R	923	29.5	24	30	2.2	58.5
K-WS1Z-3021-L	849	29.5	30	21	1.97	48.66
K-WS1Z-3021-R	849	29.5	30	21	1.97	48.66
K-WS1Z-3024-L	861	29.5	30	24	2.2	55.62
K-WS1Z-3024-R	861	29.5	30	24	2.2	55.62
K-WS1Z-3030-L	946	29.5	30	30	2.68	69.5
K-WS1Z-3030-R	946	29.5	30	30	2.68	69.5

Code	Price	H	W	D	Volume (ft ³)	Weight (lb)
K-WS1Z-3621-L	861	29.5	36	21	2.31	58.1
K-WS1Z-3621-R	861	29.5	36	21	2.31	58.1
K-WS1Z-3624-L	877	29.5	36	24	2.59	64.89
K-WS1Z-3624-R	877	29.5	36	24	2.59	64.89
K-WS1Z-3630-L	982	29.5	36	30	3.15	80.5
K-WS1Z-3630-R	982	29.5	36	30	3.15	80.5
K-WS1Z-4221-L	877	29.5	42	21	2.66	67.54
K-WS1Z-4221-R	877	29.5	42	21	2.66	67.54
K-WS1Z-4224-L	900	29.5	42	24	2.98	74.16
K-WS1Z-4224-R	900	29.5	42	24	2.98	74.16
K-WS1Z-4230-L	1021	29.5	42	30	3.62	91.5
K-WS1Z-4230-R	1021	29.5	42	30	3.62	91.5
K-WS1Z-4821-L	923	29.5	48	21	3.01	76.98
K-WS1Z-4821-R	923	29.5	48	21	3.01	76.98
K-WS1Z-4824-L	946	29.5	48	24	3.37	83.43
K-WS1Z-4824-R	946	29.5	48	24	3.37	83.43
K-WS1Z-4830-L	1054	29.5	48	30	4.09	102.5
K-WS1Z-4830-R	1054	29.5	48	30	4.09	102.5
K-WS1Z-5421-L	969	29.5	54	21	3.36	86.42
K-WS1Z-5421-R	969	29.5	54	21	3.36	86.42
K-WS1Z-5424-L	993	29.5	54	24	3.76	92.7
K-WS1Z-5424-R	993	29.5	54	24	3.76	92.7
K-WS1Z-5430-L	1090	29.5	54	30	4.56	113.5
K-WS1Z-5430-R	1090	29.5	54	30	4.56	113.5
K-WS1Z-6021-L	1021	29.5	60	21	3.7	95.86
K-WS1Z-6021-R	1021	29.5	60	21	3.7	95.86
K-WS1Z-6024-L	1045	29.5	60	24	4.15	101.97
K-WS1Z-6024-R	1045	29.5	60	24	4.15	101.97
K-WS1Z-6030-L	1151	29.5	60	30	5.04	124.5
K-WS1Z-6030-R	1151	29.5	60	30	5.04	124.5

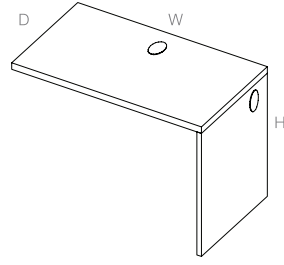

This return is semi-supported, it must be connected to a freestanding desk, corner desk or credenza. Allows for fixed and modular underdesk storage. Partial modesty gives access to electrical outlets when installed against walls

(right hand shown).

Straight Return Partial Modesty,
1" Thick Surface

Ordering Options:

Use the following checklist to customize the finishes on your order:

- laminate
- trim color
- grommet color

Each laminate comes with matching vinyl trim color unless otherwise specified on your purchase order. Refer to the laminate finish card for our current offering.

Details:

Grommets are available in black or silver. Black is the standard grommet option unless otherwise specified on your purchase order.

Surfaces up to and including 48" wide have one grommet located at the back center of the surface. Surfaces 54" wide and greater have two grommets at either side of the back of the surface.

All gables include grommets.

Code	Price	H	W	D	Volume (ft ³)	Weight (lb)
KL-WS1Z-1824-R	700	29	18	24	0	35.5
KL-WS1Z-2424-R-UW	700	29	24	24	0	36.9
KL-WS1Z-3024-R-UW	711.77	29	30	24	2.2	44.7
KL-WS1Z-3624-R-UW	725.94	29	36	24	2.59	52.5
KL-WS1Z-3636-L	947.21	29	36	36	0	75
KL-WS1Z-4024-R	745.56	29	40	24	0	60
KL-WS1Z-4221-L-UW	725.94	29	42	21	2.66	57.3
KL-WS1Z-4221-R-UW	725.94	29	42	21	2.66	57.3
KL-WS1Z-4224-L-UW	745.56	29	42	24	2.98	60.3
KL-WS1Z-4224-R-UW	745.56	29	42	24	2.98	60.3

Code	Price	H	W	D	Volume (ft ³)	Weight (lb)
KL-WS1Z-4230-L-UW	865.46	29	42	30	3.62	76.44
KL-WS1Z-4230-R-UW	865.46	29	42	30	3.62	76.44
KL-WS1Z-4818-L	769.54	29	48	18	0	58
KL-WS1Z-4818-R	769.54	29	48	18	0	58
KL-WS1Z-4821-L-UW	769.54	29	48	21	3.01	64.7
KL-WS1Z-4821-R-UW	769.54	29	48	21	3.01	64.7
KL-WS1Z-4824-L-UW	793.52	29	48	24	3.37	68.1
KL-WS1Z-4824-R-UW	793.52	29	48	24	3.37	68.1
KL-WS1Z-4830-L-UW	904.7	29	48	30	4.09	85.47
KL-WS1Z-4830-R-UW	904.7	29	48	30	4.09	85.47
KL-WS1Z-5424-L-UW	843.66	29	54	24	3.76	75.9
KL-WS1Z-5424-R-UW	843.66	29	54	24	3.76	75.9
KL-WS1Z-5430-L-UW	942.85	29	54	30	4.56	94.5
KL-WS1Z-5430-R-UW	942.85	29	54	30	4.56	94.5
KL-WS1Z-6024-L-UW	892.71	29	60	24	4.15	83.7
KL-WS1Z-6024-R-UW	892.71	29	60	24	4.15	83.7
KL-WS1Z-6030-L-UW	1004.98	29	60	30	5.04	103.53
KL-WS1Z-6030-R-UW	1004.98	29	60	30	0	103.53
KL-WS1Z-6621-L	1001.71	29	66	21	0	80
KL-WS1Z-6621-R	1001.71	29	66	21	0	80
KL-WS1Z-6624-L	1001.71	29	66	24	0	83.7
KL-WS1Z-6624-L-UW	1001.71	29	66	24	0	83.7
KL-WS1Z-6624-R	1001.71	29	66	24	0	83.7
KL-WS1Z-6624-R-UW	1001.71	29	66	24	0	83.7
KL-WS1Z-6630-L	1207.72	29	66	30	0	83.7
KL-WS1Z-6630-R	1207.72	29	66	30	0	83.7

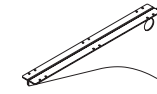

Cantilever



Intermediate Gable

Metro Collab January 2026 Supports

Code	Price	H	W	D	Volume (ft ³)	Weight (lb)
cantilever						
K-CCAB-16	120	0	16	0	3	0.1
K-CCAB-22	129	0	22	0	3	0.1
intermediate						
T-CGU0-12	229	28	12	1	1.48	8.75
T-CGU0-18	244	28	18	1	2.04	13.12

Metro Collab
January 2026
**Filing &
Storage**

Executive & Professional

pedestals	84
underdesk storage cabinet	85
underdesk combo pedestal BBF & FF	86
underdesk 2-drawer lateral file	87

Executive

freestanding storage cabinet	88
freestanding combo pedestal BBF & FF	90
freestanding 2-drawer lateral file	92
freestanding 3-drawer lateral file	94
freestanding 4-drawer lateral file	96
freestanding storage tower	98
freestanding combo storage tower BBF	100
freestanding wardrobe storage tower	102
freestanding storage tower glazed door	104
freestanding combo storage tower FF	106
freestanding storage tower double door	108
freestanding combo lateral storage tower double door	110
freestanding combo storage tower double door	112
freestanding storage tower glazed double door	114
freestanding combo lateral storage tower glazed double door	116
freestanding combo storage tower glazed double door	118
radius corner bookcase short	120

Professional

freestanding storage cabinet	89
freestanding combo pedestal BBF & FF	91
freestanding 2-drawer lateral file	93
freestanding 3-drawer lateral file	95
freestanding 4-drawer lateral file	97
freestanding storage tower	99
freestanding combo storage tower BBF	101
freestanding wardrobe storage tower	103
freestanding storage tower glazed door	105
freestanding combo storage tower FF	107
freestanding storage tower double door	109
freestanding combo lateral storage tower double door	111
freestanding combo storage tower double door	113
freestanding storage tower glazed double door	115
freestanding combo lateral storage tower glazed double door	117
freestanding combo storage tower glazed double door	119
radius corner bookcase short	121

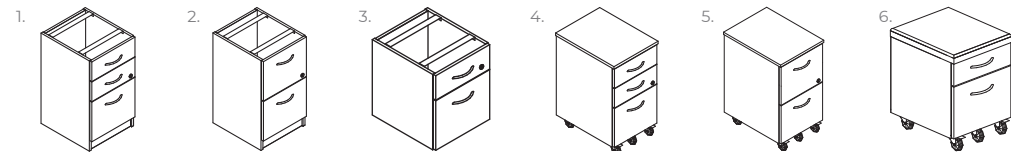

- 1. T-FPBU-1618 Underdesk BBF Pedestal
- 2. T-FPFU-1618 Underdesk FF Pedestal
- 3. T-FPSU-1618 Suspended Underdesk BF Pedestal
- 4. T-FPBM-1621 Mobile BBF Pedestal
- 5. T-FPFM-1621 Mobile FF Pedestal
- 6. T-1030-1618 Mobile BF w/ Seat Cushion Pedestal

Ordering Options:

Use the following checklist to customize the finishes on your order:

- laminate
- trim color
- handle color
- handle style
- fabric color (seats)

Each laminate comes with matching vinyl trim color unless otherwise specified on your purchase order.

Refer to the laminate & fabric finish cards for our current offering.

Code	Price	H	W	D	Volume (ft ³)	Weight (lb)
T-FPBU-1618	1052	28	16	18	8.15	55
T-FPBM-1621	1382	28	16	21	9.26	74
T-FPFU-1618	1052	28	16	18	8.15	55
T-FPFM-1621	1382	28	16	21	9.26	68
T-FPSU-1618	746	16	16	18	5.09	44
T-1030-1618	1686	23	16	18	6.88	55

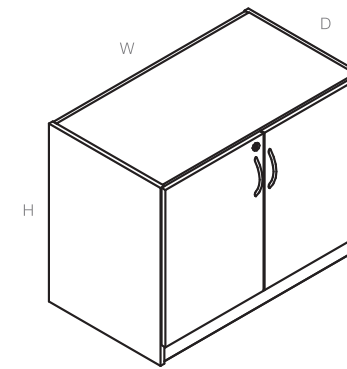

This underdesk storage cabinet provides private storage and shelving. This product is to be used under a desk, return or credenza.

Ordering Options:

Use the following checklist to customize the finishes on your order:

- laminate
- trim color
- handle color
- handle style

Each laminate comes with matching vinyl trim color unless otherwise specified on your purchase order.

Refer to the laminate & fabric finish cards for our current offering.

Details:

Includes locks, keys, and an adjustable shelf.

Code	Price	H	W	D	Volume (ft ³)	Weight (lb)
T-FSU0-3020	1289	28	30	20	15.11	88
T-FSU0-3620	1396	28	36	20	17.78	102
T-FSU0-4220	1502	28	42	20	20.44	117
T-FSU0-3021	1289	28	30	21	15.74	92
T-FSU0-3621	1396	28	36	21	18.52	107
T-FSU0-4221	1502	28	42	21	21.3	122

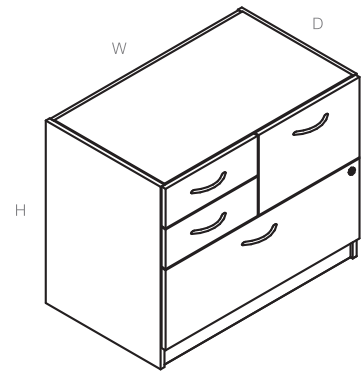

This product includes box and file drawers and is to be used under a desk, return or credenza for legal-sized paper.

Ordering Options:

Use the following checklist to customize the finishes on your order:

- laminate
- trim color
- handle color
- handle style

Each laminate comes with matching vinyl trim color unless otherwise specified on your purchase order.

Refer to the laminate & fabric finish cards for our current offering.

Details:

1. Includes locks and keys.
2. Comes equipped with drawer dividers, hanging file bars and levelers.
3. Hanging bars are installed along the depth only.
4. Includes a pencil tray.

Code	Price	H	W	D	Volume (ft ³)	Weight (lb)
T-FPJU-3620-L	2033	28	36	20	17.78	121
T-FPJU-3621-L	2033	28	36	21	18.52	122
T-FPJU-3620-R	2033	28	36	20	17.78	121
T-FPJU-3621-R	2033	28	36	21	18.52	122

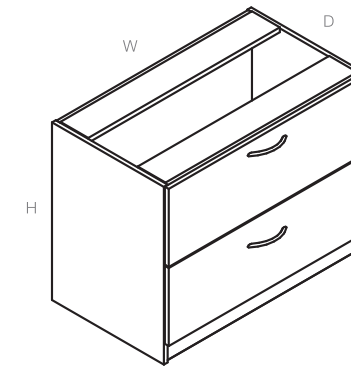

This lateral file provides large capacity filing and organized storage possibilities. It is to be used under a desk, return or credenza shell for stability. Its full extension drawers can accommodate both letter- and legal-sized paper.

Disclaimer: Please note that lateral file drawers are intended for filing letter and legal size paper front to back or side to side only. For details and weight restrictions please contact customer service.

Ordering Options:

Use the following checklist to customize the finishes on your order:

- laminate
- trim color
- handle color
- handle style

Each laminate comes with matching vinyl trim color unless otherwise specified on your purchase order.

Refer to the laminate & fabric finish cards for our current offering.

Details:

1. Includes locks and keys.
2. Comes equipped with drawer dividers, hanging file bars and levelers.
3. Hanging bars are installed along the depth only.

Code	Price	H	W	D	Volume (ft ³)	Weight (lb)
T-FL2U-3020	1663	28	30	20	15.11	82.06
T-FL2U-3620	1723	28	36	20	17.78	86.64
T-FL2U-4220	1819	28	42	20	20.44	89.35
T-FL2U-3021	1663	28	30	21	15.74	84.6
T-FL2U-3621	1723	28	36	21	18.52	88.02
T-FL2U-4221	1819	28	42	21	21.3	91.44

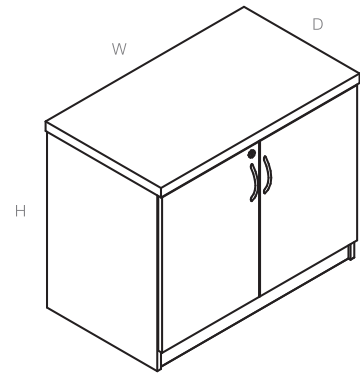

This freestanding storage cabinet provides private storage and shelving.

Freestanding Storage Cabinet, 1.5" Thick Top

Ordering Options:

Use the following checklist to customize the finishes on your order:

- laminate
- trim color
- edge profile
- handle color
- handle style

Each laminate comes with matching vinyl trim color unless otherwise specified on your purchase order.

Refer to the laminate & fabric finish cards for our current offering.

Details:

1. Includes locks and keys.
2. Comes equipped with drawer dividers, hanging file bars and levelers.
3. Hanging bars are installed along the depth only.

Code	Price	H	W	D	Volume (ft ³)	Weight (lb)
T-FSF0-3021	1419	29.5	30	21	16.48	98
T-FSF0-3621	1522	29.5	36	21	19.39	111
T-FSF0-4221	1625	29.5	42	21	22.29	124

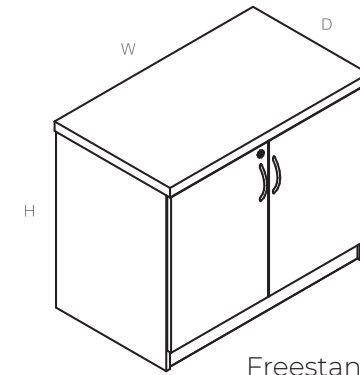

This freestanding storage cabinet provides private storage and shelving.

Freestanding Storage Cabinet, 1" Thick Top

Ordering Options:

Use the following checklist to customize the finishes on your order:

- laminate
- trim color
- handle color
- handle style

Each laminate comes with matching vinyl trim color unless otherwise specified on your purchase order.

Refer to the laminate & fabric finish cards for our current offering.

Details:

Includes locks, keys, and an adjustable shelf.

Code	Price	H	W	D	Volume (ft ³)	Weight (lb)
TL-FSF0-3021	1356	29	30	21	16.23	88
TL-FSF0-3621	1462	29	36	21	19.1	97
TL-FSF0-4221	1565	29	42	21	21.96	106

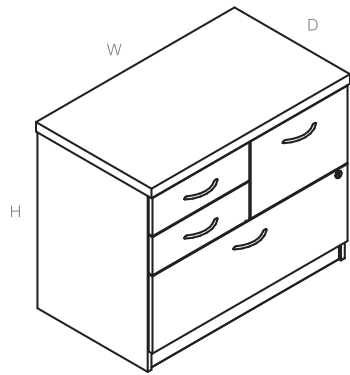

This product includes box and file drawers and is to be used as freestanding furniture. Its full extension drawers can accommodate both letter- and legal-sized paper.

Freestanding Combo Pedestal BBF & FF, 1.5" Thick Top

Ordering Options:

Use the following checklist to customize the finishes on your order:

- laminate
- trim color
- edge profile
- handle color
- handle style

Each laminate comes with matching vinyl trim color unless otherwise specified on your purchase order.

Refer to the laminate & fabric finish cards for our current offering.

Details:

1. Includes locks and keys.
2. Comes equipped with drawer dividers, hanging file bars and levelers.
3. Hanging bars are installed along the depth only.

Code	Price	H	W	D	Volume (ft ³)	Weight (lb)
T-FPJF-3621-L	2129	29.5	36	21	19.39	130
T-FPJF-3621-R	2129	29.5	36	21	19.39	130

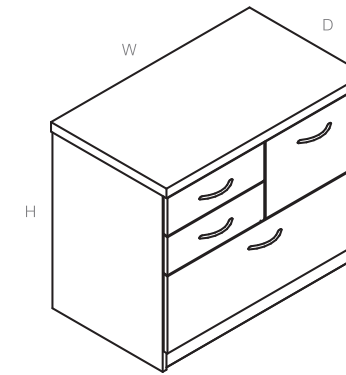

This product includes box and file drawers and is to be used as freestanding furniture. Its full extension drawers can accommodate both letter- and legal-sized paper.

Freestanding Combo Pedestal BBF & FF, 1" Thick Top

Ordering Options:

Use the following checklist to customize the finishes on your order:

- laminate
- trim color
- handle color
- handle style

Each laminate comes with matching vinyl trim color unless otherwise specified on your purchase order.

Refer to the laminate & fabric finish cards for our current offering.

Details:

1. Includes locks and keys.
2. Comes equipped with drawer dividers, hanging file bars and levelers.
3. Hanging bars are installed along the depth only.

Code	Price	H	W	D	Volume (ft ³)	Weight (lb)
TL-FPJF-3621-L	2084	29	36	21	19.1	130
TL-FPJF-3621-R	2084	29	36	21	19.1	130

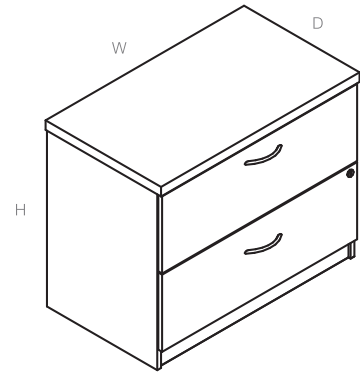

This lateral file with two drawers provides large capacity filing and organized storage. It is to be used as freestanding furniture. Its full extension drawers can accommodate both letter and legal-sized paper.

Disclaimer: Please note that lateral file drawers are intended for filing letter and legal size paper front to back or side to side only. For details and weight restrictions please contact customer service.

Freestanding 2-Drawer Lateral File, 1.5" Thick Top

Ordering Options:

Use the following checklist to customize the finishes on your order:

- laminate
- trim color
- edge profile
- handle color
- handle style

Each laminate comes with matching vinyl trim color unless otherwise specified on your purchase order.

Refer to the laminate & fabric finish cards for our current offering.

Details:

1. Includes locks and keys.
2. Comes equipped with drawer dividers, hanging file bars and levelers.
3. Hanging bars are installed along the depth only.

Code	Price	H	W	D	Volume (ft ³)	Weight (lb)
T-FL2F-3021	1776	29.5	30	21	16.48	108.9
T-FL2F-3621	1833	29.5	36	21	19.39	117.27
T-FL2F-4221	1923	29.5	42	21	22.29	125.64

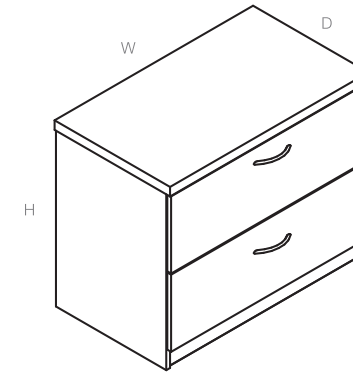

This lateral file with two drawers provides large capacity filing and organized storage. It is to be used as freestanding furniture. Its full extension drawers can accommodate both letter and legal-sized paper.

Disclaimer: Please note that lateral file drawers are intended for filing letter and legal size paper front to back or side to side only. For details and weight restrictions please contact customer service.

Freestanding 2-Drawer Lateral File, 1" Thick Top

Ordering Options:

Use the following checklist to customize the finishes on your order:

- laminate
- trim color
- handle color
- handle style

Each laminate comes with matching vinyl trim color unless otherwise specified on your purchase order.

Refer to the laminate & fabric finish cards for our current offering.

Details:

1. Includes locks and keys.
2. Comes equipped with drawer dividers, hanging file bars and levelers.
3. Hanging bars are installed along the depth only.

Code	Price	H	W	D	Volume (ft ³)	Weight (lb)
TL-FL2F-3021	1721	29	30	21	16.23	92.7
TL-FL2F-3621	1777	29	36	21	19.1	107.1
TL-FL2F-4221	1872	29	42	21	21.96	121.5

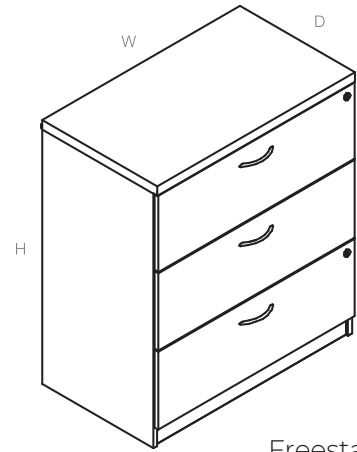

Freestanding 3-Drawer Lateral File, 1.5" Thick Top

This lateral file with two drawers provides large capacity filing and organized storage. It is to be used as freestanding furniture. Its full extension drawers can accommodate both letter and legal-sized paper.

Disclaimer: Please note that lateral file drawers are intended for filing letter and legal size paper front to back or side to side only. For details and weight restrictions please contact customer service.

Ordering Options:

Use the following checklist to customize the finishes on your order:

- laminate
- trim color
- edge profile
- handle color
- handle style

Each laminate comes with matching vinyl trim color unless otherwise specified on your purchase order.

Refer to the laminate & fabric finish cards for our current offering.

Details:

1. Includes locks and keys.
2. Comes equipped with drawer dividers, hanging file bars and levelers.
3. Hanging bars are installed along the depth only.

Code	Price	H	W	D	Volume (ft ³)	Weight (lb)
T-FL3F-3021	2207	40.5	30	21	21.89	145
T-FL3F-3621	2302	40.5	36	21	25.75	154.96

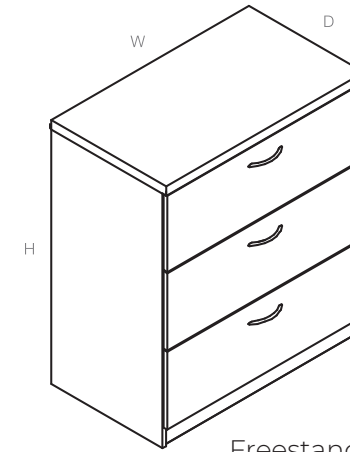

Freestanding 3-Drawer Lateral File, 1" Thick Top

This lateral file with two drawers provides large capacity filing and organized storage. It is to be used as freestanding furniture. Its full extension drawers can accommodate both letter and legal-sized paper.

Disclaimer: Please note that lateral file drawers are intended for filing letter and legal size paper front to back or side to side only. For details and weight restrictions please contact customer service.

Ordering Options:

Use the following checklist to customize the finishes on your order:

- laminate
- trim color
- handle color
- handle style

Each laminate comes with matching vinyl trim color unless otherwise specified on your purchase order.

Refer to the laminate & fabric finish cards for our current offering.

Details:

1. Includes locks and keys.
2. Comes equipped with drawer dividers, hanging file bars and levelers.
3. Hanging bars are installed along the depth only.

Code	Price	H	W	D	Volume (ft ³)	Weight (lb)
TL-FL3F-3021	1939	40	30	21	21.64	136.5
TL-FL3F-3621	2033	40	36	21	25.46	144.25

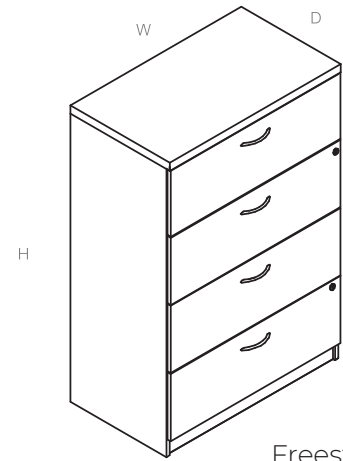

Freestanding 4-Drawer Lateral File, 1.5" Thick Top

This lateral file with two drawers provides large capacity filing and organized storage. It is to be used as freestanding furniture. Its full extension drawers can accommodate both letter and legal-sized paper.

Disclaimer: Please note that lateral file drawers are intended for filing letter and legal size paper front to back or side to side only. For details and weight restrictions please contact customer service.

Ordering Options:

Use the following checklist to customize the finishes on your order:

- laminate
- trim color
- edge profile
- handle color
- handle style

Each laminate comes with matching vinyl trim color unless otherwise specified on your purchase order.

Refer to the laminate & fabric finish cards for our current offering.

Details:

1. Includes locks and keys.
2. Comes equipped with drawer dividers, hanging file bars and levelers.
3. Hanging bars are installed along the depth only.

Code	Price	H	W	D	Volume (ft ³)	Weight (lb)
T-FL4F-3021	2890	52.5	30	21	27.79	171.3
T-FL4F-3621	2983	52.5	36	21	32.7	183.24

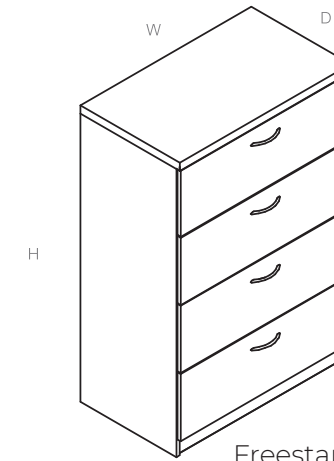

Freestanding 4-Drawer Lateral File, 1" Thick Top

This lateral file with two drawers provides large capacity filing and organized storage. It is to be used as freestanding furniture. Its full extension drawers can accommodate both letter and legal-sized paper.

Disclaimer: Please note that lateral file drawers are intended for filing letter and legal size paper front to back or side to side only. For details and weight restrictions please contact customer service.

Ordering Options:

Use the following checklist to customize the finishes on your order:

- laminate
- trim color
- handle color
- handle style

Each laminate comes with matching vinyl trim color unless otherwise specified on your purchase order.

Refer to the laminate & fabric finish cards for our current offering.

Details:

1. Includes locks and keys.
2. Comes equipped with drawer dividers, hanging file bars and levelers.
3. Hanging bars are installed along the depth only.

Code	Price	H	W	D	Volume (ft ³)	Weight (lb)
TL-FL4F-3021	2617	52	30	21	27.55	153.1
TL-FL4F-3621	2713	52	36	21	32.41	162.98

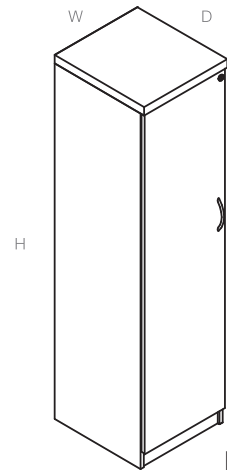

Freestanding Storage Tower,
1.5" Thick Top

This lockable storage tower functions the same way as a storage cabinet but with more vertical space. Shelves are adjustable for user to customize with levelers (left hand shown).

Ordering Options:

Use the following checklist to customize the finishes on your order:

- laminate
- trim color
- edge profile
- handle color
- handle style

Each laminate comes with matching vinyl trim color unless otherwise specified on your purchase order.

Refer to the laminate & fabric finish cards for our current offering.

Details:

1. Includes locks and keys.
2. Comes equipped with drawer dividers, hanging file bars and levelers.

Code	Price	H	W	D	Volume (ft ³)	Weight (lb)
T-FSDS-1821-L	1574	68	18	21	22.92	133.65
T-FSDS-1821-R	1574	68	18	21	22.92	133.65

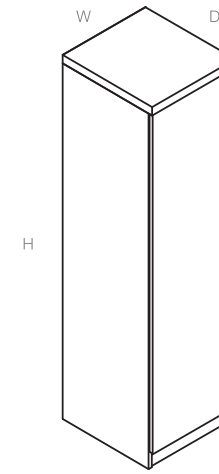

Freestanding Storage Tower,
1" Thick Top

This lockable storage tower functions the same way as a storage cabinet but with more vertical space. Shelves are adjustable for user to customize with levelers (left hand shown).

Ordering Options:

Use the following checklist to customize the finishes on your order:

- laminate
- trim color
- handle color
- handle style

Each laminate comes with matching vinyl trim color unless otherwise specified on your purchase order.

Refer to the laminate & fabric finish cards for our current offering.

Details:

1. Includes locks and keys.
2. Comes equipped with drawer dividers, hanging file bars and levelers.

Code	Price	H	W	D	Volume (ft ³)	Weight (lb)
TL-FSDS-1821-L	1511	67	18	21	22.6	128.7
TL-FSDS-1821-R	1511	67	18	21	22.6	128.7

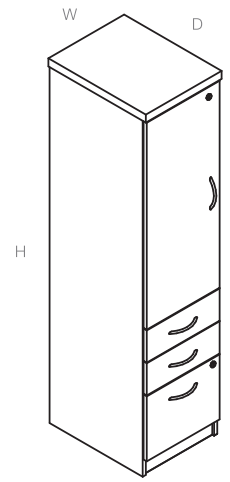

This storage tower combines the filing capabilities of a BBF with the flexibility of a cabinet. Drawers accept both letter and legal-sized paper (left hand shown).

Freestanding Combo Storage Tower BBF, 1.5" Thick Top

Ordering Options:

Use the following checklist to customize the finishes on your order:

- laminate
- trim color
- edge profile
- handle color
- handle style

Each laminate comes with matching vinyl trim color unless otherwise specified on your purchase order.

Refer to the laminate & fabric finish cards for our current offering.

Details:

1. Includes locks and keys.
2. Comes equipped with levelers and adjustable shelves.

Code	Price	H	W	D	Volume (ft ³)	Weight (lb)
T-FCSB-1821-L	2473	68	18	21	22.92	168
T-FCSB-1821-R	2473	68	18	21	22.92	168

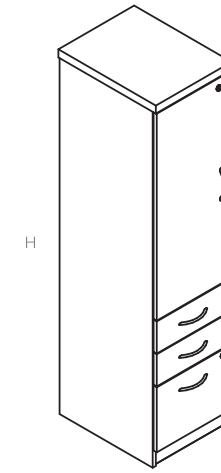

This storage tower combines the filing capabilities of a BBF with the flexibility of a cabinet. Drawers accept both letter and legal-sized paper (left hand shown).

Freestanding Combo Storage Tower BBF, 1" Thick Top

Ordering Options:

Use the following checklist to customize the finishes on your order:

- laminate
- trim color
- handle color
- handle style

Each laminate comes with matching vinyl trim color unless otherwise specified on your purchase order.

Refer to the laminate & fabric finish cards for our current offering.

Details:

1. Includes locks and keys.
2. Comes equipped with levelers and adjustable shelves.

Code	Price	H	W	D	Volume (ft ³)	Weight (lb)
TL-FCSB-1821-L	2205	67	18	21	22.6	163
TL-FCSB-1821-R	2205	67	18	21	22.6	163

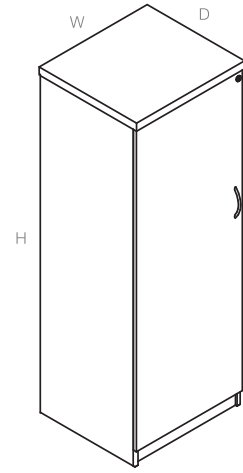

This unit provides a lockable storage area for apparel and other personal items. Includes a coat bar and adjustable shelves with levelers (left hand shown).

Freestanding Wardrobe Storage Tower, 1.5" Thick Top

Ordering Options:

Use the following checklist to customize the finishes on your order:

- laminate
- trim color
- edge profile
- handle color
- handle style

Each laminate comes with matching vinyl trim color unless otherwise specified on your purchase order.

Refer to the laminate & fabric finish cards for our current offering.

Details:

1. Includes locks and keys.
2. Comes equipped with levelers and adjustable shelves.

Code	Price	H	W	D	Volume (ft ³)	Weight (lb)
T-FSDC-2421-L	1697	68	24	21	29.17	179.64
T-FSDC-2421-R	1697	68	24	21	29.17	179.64

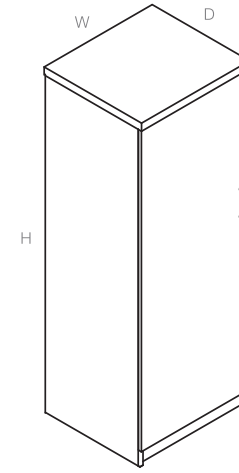

This unit provides a lockable storage area for apparel and other personal items. Includes a coat bar and adjustable shelves with levelers (left hand shown).

Freestanding Wardrobe Storage Tower, 1" Thick Top

Ordering Options:

Use the following checklist to customize the finishes on your order:

- laminate
- trim color
- handle color
- handle style

Each laminate comes with matching vinyl trim color unless otherwise specified on your purchase order.

Refer to the laminate & fabric finish cards for our current offering.

Details:

1. Includes locks and keys.
2. Comes equipped with levelers and adjustable shelves.

Code	Price	H	W	D	Volume (ft ³)	Weight (lb)
TL-FSDC-2421-L	1634	67	24	21	28.76	169.95
TL-FSDC-2421-R	1634	67	24	21	28.76	169.95

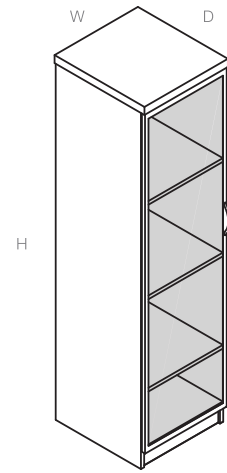

This storage tower functions the same way as a storage cabinet but with more vertical space and a glazed door. Shelves are adjustable for user to customize with levelers (left hand shown).

Freestanding Storage Tower Glazed Door, 1.5" Thick Top

Ordering Options:

Use the following checklist to customize the finishes on your order:

- laminate
- trim color
- edge profile
- handle color
- handle style

Each laminate comes with matching vinyl trim color unless otherwise specified on your purchase order.

Refer to the laminate & fabric finish cards for our current offering.

Details:

1. Includes locks and keys.
2. Comes equipped with levelers and adjustable shelves.

Code	Price	H	W	D	Volume (ft ³)	Weight (lb)
T-FSDS-1821-L-G	3329.95	68	18	21	22.92	119.81

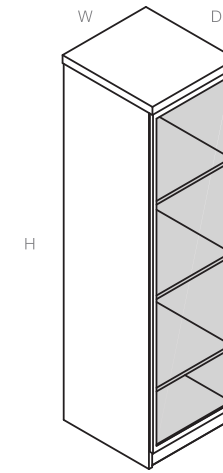

This storage tower functions the same way as a storage cabinet but with more vertical space and a glazed door. Shelves are adjustable for user to customize with levelers (left hand shown).

Freestanding Storage Tower Glazed Door, 1" Thick Top

Ordering Options:

Use the following checklist to customize the finishes on your order:

- laminate
- trim color
- handle color
- handle style

Each laminate comes with matching vinyl trim color unless otherwise specified on your purchase order.

Refer to the laminate & fabric finish cards for our current offering.

Details:

1. Includes locks and keys.
2. Comes equipped with levelers and adjustable shelves.

Code	Price	H	W	D	Volume (ft ³)	Weight (lb)
TL-FSDS-1821-LG	3265.64	67	18	21	22.6	113.85
TL-FSDS-1821-RG	3265.64	67	18	21	22.6	113.85

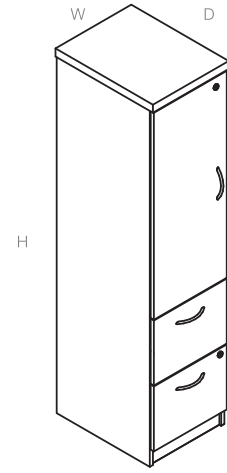

This storage tower combines the filing capabilities of a FF with the flexibility of a cabinet. Drawers accept both letter and legal-sized paper (left hand shown).

Freestanding Combo Storage Tower FF, 1.5" Thick Top

Ordering Options:

Use the following checklist to customize the finishes on your order:

- laminate
- trim color
- edge profile
- handle color
- handle style

Each laminate comes with matching vinyl trim color unless otherwise specified on your purchase order.

Refer to the laminate & fabric finish cards for our current offering.

Details:

1. Includes locks and keys.
2. Comes equipped with levelers and adjustable shelves.

Code	Price	H	W	D	Volume (ft ³)	Weight (lb)
T-FCSF-1821-L	2473	68	18	21	22.92	162
T-FCSF-1821-R	2473	68	18	21	22.92	162

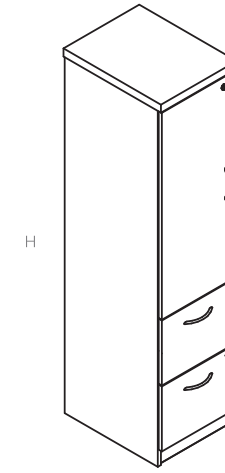

This storage tower combines the filing capabilities of a FF with the flexibility of a cabinet. Drawers accept both letter and legal-sized paper (left hand shown).

Freestanding Combo Storage Tower FF, 1" Thick Top

Ordering Options:

Use the following checklist to customize the finishes on your order:

- laminate
- trim color
- handle color
- handle style

Each laminate comes with matching vinyl trim color unless otherwise specified on your purchase order.

Refer to the laminate & fabric finish cards for our current offering.

Details:

1. Includes locks and keys.
2. Comes equipped with levelers and adjustable shelves.

Code	Price	H	W	D	Volume (ft ³)	Weight (lb)
TL-FCSF-1821-L	2205	67	18	21	22.6	129
TL-FCSF-1821-R	2205	67	18	21	22.6	129

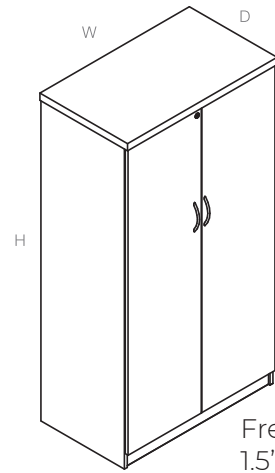

This lockable storage tower with double doors functions the same way as a storage cabinet but with more vertical space. Shelves are adjustable for user to customize with levelers.

Freestanding Storage Tower Double Door, 1.5" Thick Top

Ordering Options:

Use the following checklist to customize the finishes on your order:

- laminate
- trim color
- edge profile
- handle color
- handle style

Each laminate comes with matching vinyl trim color unless otherwise specified on your purchase order.

Refer to the laminate & fabric finish cards for our current offering.

Details:

1. Includes locks and keys.
2. Comes equipped with levelers and adjustable shelves.

Code	Price	H	W	D	Volume (ft ³)	Weight (lb)
T-FSDS-3621	2473	68	36	21	41.67	204.96

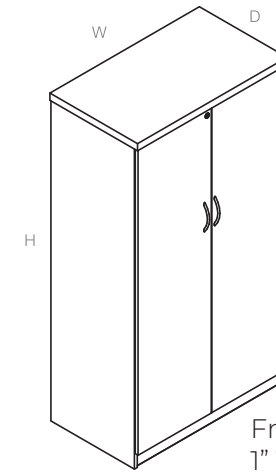

This lockable storage tower with double doors functions the same way as a storage cabinet but with more vertical space. Shelves are adjustable for user to customize with levelers.

Freestanding Storage Tower Double Door, 1" Thick Top

Ordering Options:

Use the following checklist to customize the finishes on your order:

- laminate
- trim color
- handle color
- handle style

Each laminate comes with matching vinyl trim color unless otherwise specified on your purchase order.

Refer to the laminate & fabric finish cards for our current offering.

Details:

1. Includes locks and keys.
2. Comes equipped with levelers and adjustable shelves.

Code	Price	H	W	D	Volume (ft ³)	Weight (lb)
TL-FSDS-3621	2301	67	36	21	41.09	195.39

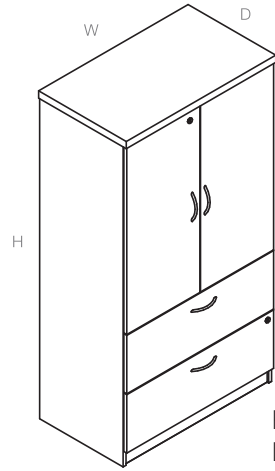

This storage tower combines the filing capabilities of a lateral storage unit with the flexibility of a cabinet. Drawers accept both letter and legal-sized paper.

Freestanding Combo Lateral Storage Tower Double Door, 1.5" Thick Top

Ordering Options:

Use the following checklist to customize the finishes on your order:

- laminate
- trim color
- edge profile
- handle color
- handle style

Each laminate comes with matching vinyl trim color unless otherwise specified on your purchase order.

Refer to the laminate & fabric finish cards for our current offering.

Details:

1. Includes locks and keys.
2. Comes equipped with levelers and adjustable shelves.

Code	Price	H	W	D	Volume (ft ³)	Weight (lb)
T-FCSL-3621	2935	68	36	21	41.67	260.82

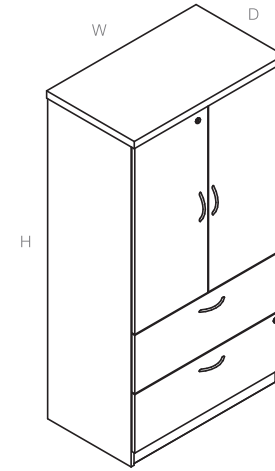

This storage tower combines the filing capabilities of a lateral storage unit with the flexibility of a cabinet. Drawers accept both letter and legal-sized paper.

Freestanding Combo Lateral Storage Tower Double Door, 1" Thick Top

Ordering Options:

Use the following checklist to customize the finishes on your order:

- laminate
- trim color
- handle color
- handle style

Each laminate comes with matching vinyl trim color unless otherwise specified on your purchase order.

Refer to the laminate & fabric finish cards for our current offering.

Details:

1. Includes locks and keys.
2. Comes equipped with levelers and adjustable shelves.

Code	Price	H	W	D	Volume (ft ³)	Weight (lb)
TL-FCSL-3621	2667	67	36	21	41.09	251.25

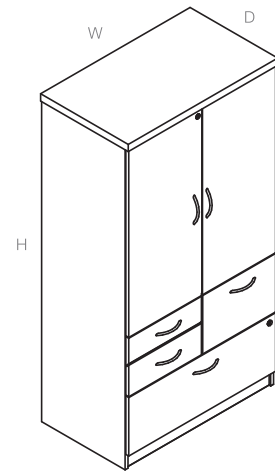

This storage tower combines the filing capabilities of lateral and underdesk storage with the flexibility of a cabinet. Drawers accept both letter and legal-sized paper.

Freestanding Combo Storage Tower Double Door, 1.5" Thick Top

Ordering Options:

Use the following checklist to customize the finishes on your order:

- laminate
- trim color
- edge profile
- handle color
- handle style

Each laminate comes with matching vinyl trim color unless otherwise specified on your purchase order.

Refer to the laminate & fabric finish cards for our current offering.

Details:

1. Includes locks and keys.
2. Comes equipped with levelers and adjustable shelves.

Code	Price	H	W	D	Volume (ft ³)	Weight (lb)
T-FCSJ-3621	3247.11	68	36	21	41.67	266.82

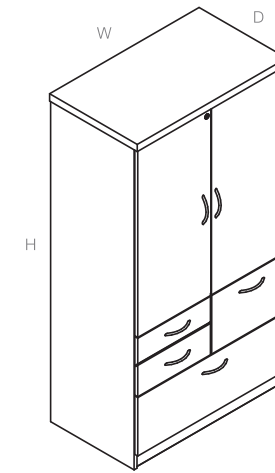

This storage tower combines the filing capabilities of lateral and underdesk storage with the flexibility of a cabinet. Drawers accept both letter and legal-sized paper.

Freestanding Combo Storage Tower Double Door, 1" Thick Top

Ordering Options:

Use the following checklist to customize the finishes on your order:

- laminate
- trim color
- handle color
- handle style

Each laminate comes with matching vinyl trim color unless otherwise specified on your purchase order.

Refer to the laminate & fabric finish cards for our current offering.

Details:

1. Includes locks and keys.
2. Comes equipped with levelers and adjustable shelves.

Code	Price	H	W	D	Volume (ft ³)	Weight (lb)
TL-FCSJ-3621	2978.97	67	36	21	41.09	257.35

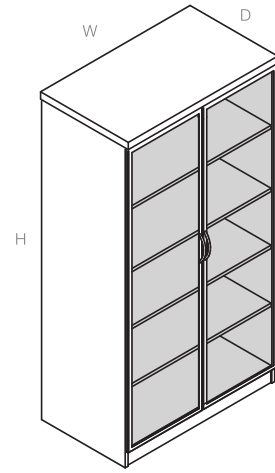

This lockable storage tower with glazed double doors functions the same way as a storage cabinet but with more vertical space. Shelves are adjustable for user to customize with levelers.

Freestanding Storage Tower Glazed Double Door, 1.5" Thick Top

Ordering Options:

Use the following checklist to customize the finishes on your order:

- laminate
- trim color
- edge profile
- handle color
- handle style

Each laminate comes with matching vinyl trim color unless otherwise specified on your purchase order.

Refer to the laminate & fabric finish cards for our current offering.

Details:

1. Includes locks and keys.
2. Comes equipped with levelers and adjustable shelves.

Code	Price	H	W	D	Volume (ft ³)	Weight (lb)
T-FSDS-3621-G	4206.31	68	36	21	41.67	210.6

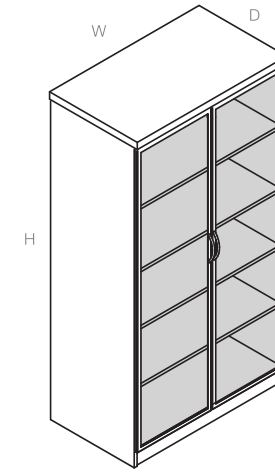

This lockable storage tower with glazed double doors functions the same way as a storage cabinet but with more vertical space. Shelves are adjustable for user to customize with levelers.

Freestanding Storage Tower Glazed Double Door, 1" Thick Top

Ordering Options:

Use the following checklist to customize the finishes on your order:

- laminate
- trim color
- handle color
- handle style

Each laminate comes with matching vinyl trim color unless otherwise specified on your purchase order.

Refer to the laminate & fabric finish cards for our current offering.

Details:

1. Includes locks and keys.
2. Comes equipped with levelers and adjustable shelves.

Code	Price	H	W	D	Volume (ft ³)	Weight (lb)
TL-FSDS-3621-G	4036.27	67	36	21	41.09	210.6

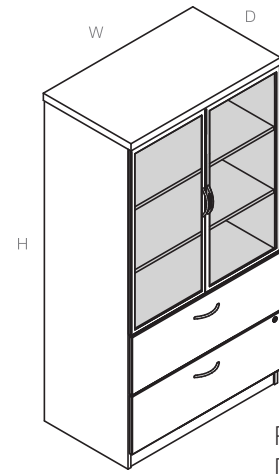

This storage tower combines the filing capabilities of a lateral storage unit with the flexibility of a cabinet. Drawers accept both letter and legal-sized paper.

Freestanding Combo Lateral Storage Tower Glazed Double Door, 1.5" Thick Top

Ordering Options:

Use the following checklist to customize the finishes on your order:

- laminate
- trim color
- edge profile
- handle color
- handle style

Each laminate comes with matching vinyl trim color unless otherwise specified on your purchase order.

Refer to the laminate & fabric finish cards for our current offering.

Details:

1. Includes locks and keys.
2. Comes equipped with levelers and adjustable shelves.

Code	Price	H	W	D	Volume (ft ³)	Weight (lb)
T-FCSL-3621-G	4728	68	36	21	41.67	222.62

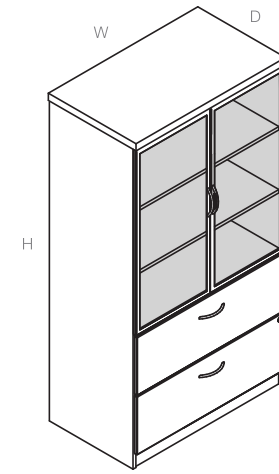

This storage tower combines the filing capabilities of a lateral storage unit with the flexibility of a cabinet. Drawers accept both letter and legal-sized paper.

Freestanding Combo Lateral Storage Tower Glazed Double Door, 1" Thick Top

Ordering Options:

Use the following checklist to customize the finishes on your order:

- laminate
- trim color
- handle color
- handle style

Each laminate comes with matching vinyl trim color unless otherwise specified on your purchase order.

Refer to the laminate & fabric finish cards for our current offering.

Details:

1. Includes locks and keys.
2. Comes equipped with levelers and adjustable shelves.

Code	Price	H	W	D	Volume (ft ³)	Weight (lb)
TL-FCSL-3621-G	4474	67	36	21	41.09	213.05

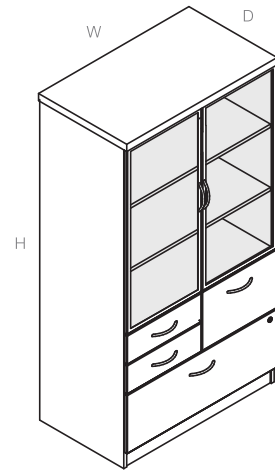

This storage tower combines the filing capabilities of lateral and underdesk storage with the flexibility of a cabinet. Drawers accept both letter and legal-sized paper.

Freestanding Combo Storage Tower Glazed Double Door, 1.5" Thick Top

Ordering Options:

Use the following checklist to customize the finishes on your order:

- laminate
- trim color
- edge profile
- handle color
- handle style

Each laminate comes with matching vinyl trim color unless otherwise specified on your purchase order.

Refer to the laminate & fabric finish cards for our current offering.

Details:

1. Includes locks and keys.
2. Comes equipped with levelers and adjustable shelves.

Code	Price	H	W	D	Volume (ft ³)	Weight (lb)
T-FCSJ-3621-G	5044.52	68	36	21	41.67	229.87

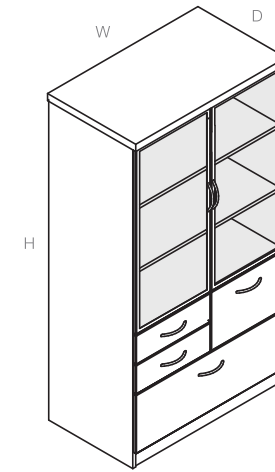

This storage tower combines the filing capabilities of lateral and underdesk storage with the flexibility of a cabinet. Drawers accept both letter and legal-sized paper.

Freestanding Combo Storage Tower Glazed Double Door, 1" Thick Top

Ordering Options:

Use the following checklist to customize the finishes on your order:

- laminate
- trim color
- handle color
- handle style

Each laminate comes with matching vinyl trim color unless otherwise specified on your purchase order.

Refer to the laminate & fabric finish cards for our current offering.

Details:

1. Includes locks and keys.
2. Comes equipped with levelers and adjustable shelves.

Code	Price	H	W	D	Volume (ft ³)	Weight (lb)
TL-FCSJ-3621-G	4776.38	67	36	21	41.09	219.87

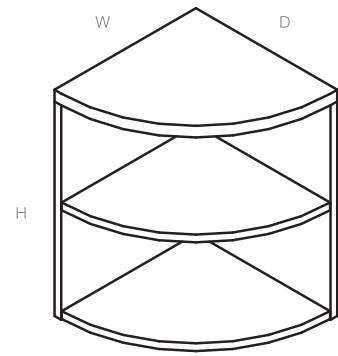

This bookcase provides open storage space within the workstation. Sits nicely against credenzas and other freestanding furniture.

Radius Corner Bookcase Short, 1.5" Thick Top

Ordering Options:

Use the following checklist to customize the finishes on your order:

- laminate
- trim color
- edge profile

Each laminate comes with matching vinyl trim color unless otherwise specified on your purchase order.

Refer to the laminate & fabric finish cards for our current offering.

Details:

1. Comes equipped with levelers and adjustable shelf.
2. Aligns with desk height.

Code	Price	H	W	D	Volume (ft ³)	Weight (lb)
K-SBRC-292121	826.22	29.5	21	21	12.12	71
K-SBRC-292424	960.29	29.5	24	24	13.57	95.5

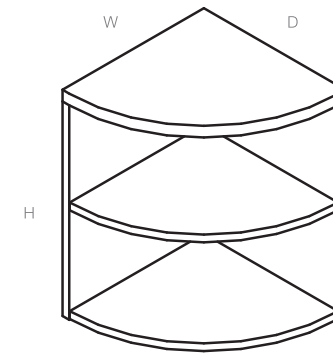

This bookcase provides open storage space within the workstation. Sits nicely against credenzas and other freestanding furniture.

Radius Corner Bookcase Short, 1" Thick Top

Ordering Options:

Use the following checklist to customize the finishes on your order:

- laminate
- trim color

Each laminate comes with matching vinyl trim color unless otherwise specified on your purchase order.

Refer to the laminate & fabric finish cards for our current offering.

Details:

1. Comes equipped with levelers and adjustable shelf.
2. Aligns with desk height.

Code	Price	H	W	D	Volume (ft ³)	Weight (lb)
KL-SBRC-292121	717.22	29	21	21	11.94	50
KL-SBRC-292424	850.2	29	24	24	14.97	58



Metro Collab
January 2026
**Overhead
Storage**

overhead storage

Executive

<u>open hutch</u>	124
<u>hinged door overhead storage</u>	126
<u>hinged door overhead storage glazed doors</u>	128

Professional

<u>open hutch</u>	125
<u>hinged door overhead storage</u>	127
<u>hinged door overhead storage glazed doors</u>	129

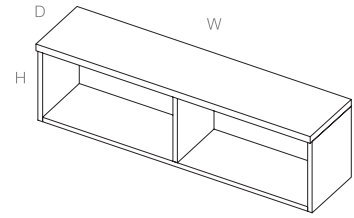

This open hutch provides open overhead storage within the workstation.

Open Hutch, 1.5" Thick Top

Ordering Options:

Use the following checklist to customize the finishes on your order:

- laminate
- trim color
- edge profile

Each laminate comes with matching vinyl trim color unless otherwise specified on your purchase order. Refer to the laminate finish card for our current offering.

Details:

1. Overheads 54 inches and wider require 4 large vertical posts for support.
2. Overheads 48 inches and smaller require 2 large vertical posts for support.
3. The 54, 60, 66, and 72 inch open hutches come with a divider.

Code	Price	H	W	D	Volume (ft ³)	Weight (lb)
K-SHO-1524	596	17	24	15	8	32
K-SHO-1530	641	17	30	15	9	36
K-SHO-1536	685	17	36	15	10	40
K-SHO-1542	761	17	42	15	11	44
K-SHO-1548	806	17	48	15	12	48
K-SHO-1554	849	17	54	15	13	52
K-SHO-1560	923	17	60	15	14	55
K-SHO-1566	966	17	66	15	16	59
K-SHO-1572	1009	17	72	15	17	63

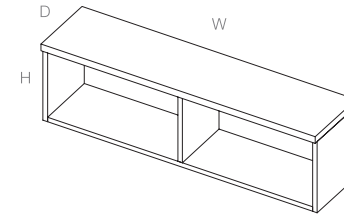

This open hutch provides open overhead storage within the workstation.

Open Hutch, 1" Thick Top

Ordering Options:

Use the following checklist to customize the finishes on your order:

- laminate
- trim color

Each laminate comes with matching vinyl trim color unless otherwise specified on your purchase order. Refer to the laminate finish card for our current offering.

Details:

1. Overheads 54 inches and wider require 4 large vertical posts for support.
2. Overheads 48 inches and smaller require 2 large vertical posts for support.

Code	Price	H	W	D	Volume (ft ³)	Weight (lb)
KL-SHO-1524	566	17	24	15	8	31
KL-SHO-1530	603	17	30	15	9	35
KL-SHO-1536	641	17	36	15	10	39
KL-SHO-1542	712	17	42	15	11	43
KL-SHO-1548	746	17	48	15	12	47
KL-SHO-1554	786	17	54	15	13	51
KL-SHO-1560	850	17	60	15	14	54
KL-SHO-1566	891	17	66	15	16	58
KL-SHO-1572	927	17	72	15	17	62

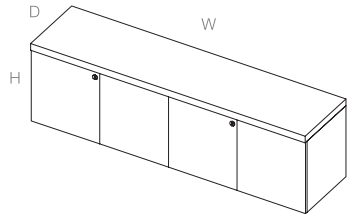

This hinged door hutch provides overhead storage within the workstation.

Hinged Door Overhead Storage, 1.5" Thick Top

Ordering Options:

Use the following checklist to customize the finishes on your order:

- laminate
- trim color
- edge profile

Each laminate comes with matching vinyl trim color unless otherwise specified on your purchase order. Refer to the laminate finish card for our current offering.

Details:

1. Overheads 54 inches and wider require 4 large vertical posts for support.
2. Overheads 48 inches and smaller require 2 large vertical posts for support.
3. The 54, 60, 66, and 72 inch open hutches come with a divider.

Code	Price	H	W	D	Volume (ft ³)	Weight (lb)
K-SHH-1524-L	784	17	24	15	8	41
K-SHH-1530-L	863	17	30	15	9	47
K-SHH-1536-L	906	17	36	15	10	53
K-SHH-1542-L	1099	17	42	15	11	59
K-SHH-1548-L	1164	17	48	15	12	65
K-SHH-1554-L	1230	17	54	15	13	71
K-SHH-1560-L	1344	17	60	15	14	77
K-SHH-1566-L	1413	17	66	15	16	82
K-SHH-1572-L	1473	17	72	15	17	88

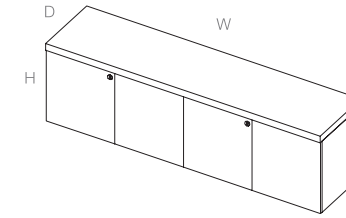

This hinged door hutch provides overhead storage within the workstation.

Hinged Door Overhead Storage, 1" Thick Top

Ordering Options:

Use the following checklist to customize the finishes on your order:

- laminate
- trim color

Each laminate comes with matching vinyl trim color unless otherwise specified on your purchase order. Refer to the laminate finish card for our current offering.

Details:

1. Overheads 54 inches and wider require 4 large vertical posts for support.
2. Overheads 48 inches and smaller require 2 large vertical posts for support.

Code	Price	H	W	D	Volume (ft ³)	Weight (lb)
KL-SHH-1524-L	753	17	24	15	8	40
KL-SHH-1530-L	826	17	30	15	9	46
KL-SHH-1536-L	861	17	36	15	10	52
KL-SHH-1542-L	1049	17	42	15	11	58
KL-SHH-1548-L	1100	17	48	15	12	64
KL-SHH-1554-L	1163	17	54	15	13	70
KL-SHH-1560-L	1269	17	60	15	14	76
KL-SHH-1566-L	1330	17	66	15	16	82
KL-SHH-1572-L	1382	17	72	15	17	88

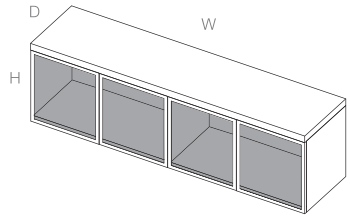

This hinged door hutch provides overhead storage within the workstation.

Hinged Door Overhead Storage Glazed Doors, 1.5" Thick Top

Ordering Options:

Use the following checklist to customize the finishes on your order:

- laminate
- trim color
- edge profile

Each laminate comes with matching vinyl trim color unless otherwise specified on your purchase order. Refer to the laminate finish card for our current offering.

Details:

1. Overheads 54 inches and wider require 4 large vertical posts for support.
2. Overheads 48 inches and smaller require 2 large vertical posts for support.
3. The 54, 60, 66, and 72 inch open hutches come with a divider.

Code	Price	H	W	D	Volume (ft ³)	Weight (lb)
K-SHH-1524-G	1142	17	24	15	8	41
K-SHH-1530-G	1223	17	30	15	9	47
K-SHH-1536-G	1301	17	36	15	10	53
K-SHH-1542-G	1569	17	42	15	11	59
K-SHH-1548-G	1646	17	48	15	12	65
K-SHH-1554-G	1725	17	54	15	13	71
K-SHH-1560-G	2003	17	60	15	14	77
K-SHH-1566-G	2080	17	66	15	16	83
K-SHH-1572-G	2156	17	72	15	17	89

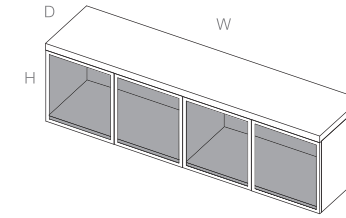

This hinged door hutch provides overhead storage within the workstation.

Hinged Door Overhead Storage Glazed Doors, 1" Thick Top

Ordering Options:

Use the following checklist to customize the finishes on your order:

- laminate
- trim color

Each laminate comes with matching vinyl trim color unless otherwise specified on your purchase order. Refer to the laminate finish card for our current offering.

Details:

1. Overheads 54 inches and wider require 4 large vertical posts for support.
2. Overheads 48 inches and smaller require 2 large vertical posts for support.

Code	Price	H	W	D	Volume (ft ³)	Weight (lb)
KL-SHH-1524-G	1110	17	24	15	8	40
KL-SHH-1530-G	1192	17	30	15	9	46
KL-SHH-1536-G	1280	17	36	15	10	52
KL-SHH-1542-G	1525	17	42	15	11	58
KL-SHH-1548-G	1610	17	48	15	12	64
KL-SHH-1554-G	1695	17	54	15	13	70
KL-SHH-1560-G	1943	17	60	15	14	76
KL-SHH-1566-G	2028	17	66	15	16	82
KL-SHH-1572-G	2112	17	72	15	17	88



Metro Collab
January 2026
Posts

<u>large vertical aluminum post</u>	<u>132</u>
<u>small vertical aluminum post</u>	<u>133</u>



This large post supports overhead storage and screens.

Large Vertical Aluminum Post

Ordering Options:

Use the following checklist to customize the finishes on your order:

- metal color

Details:

1. Large vertical aluminum posts support overheads and hutches.
2. Surfaces 54 inches and wider require 4 posts in a span.

Code	Price	H	W	D	Volume (ft ³)	Weight (lb)
K-PO-24	177	24	0	5	0.1	1.41



This small post supports countertops and screens.

Small Vertical Aluminum Post

Ordering Options:

Use the following checklist to customize the finishes on your order:

- metal color

Details:

1. Large vertical aluminum posts support overheads and hutches.
2. Surfaces 54 inches and wider require 4 posts in a span.

Code	Price	H	W	D	Volume (ft ³)	Weight (lb)
K-PS-08	81	8	0	2.5	0.08	0.24
K-PS-12	87	12	0	2.5	0.03	0.36
K-PS-16	92	16	0	2.5	0.04	0.48
K-PS-24	107	24	0	2.5	0.05	0.75
K-PS-32	126	32	0	2.5	0.07	0.95



Metro Collab
January 2026
Electrics

electrics

<u>power box</u>	136
<u>data box</u>	137
<u>electrical starter harness</u>	138
<u>electrical splitter harness</u>	139
<u>electrical harness</u>	140

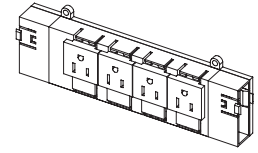

Ordering Options:

There are no ordering options for these items

Code	Price	H	W	D	Volume (ft ³)	Weight (lb)
K-EM84-M	239	3	80	2	0.02	0.6

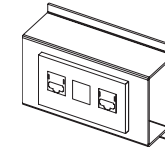

Ordering Options:

There are no ordering options for these items

Code	Price	H	W	D	Volume (ft ³)	Weight (lb)
K-ECK1-M	203	3	4	1	0.02	0.6



Ordering Options:

There are no ordering options for these items

Code	Price	H	W	D	Volume (ft ³)	Weight (lb)
K-ES84-072	399	0	72	0	2.96	2.48
K-ES84-168	680	0	168	0	5.12	4.59

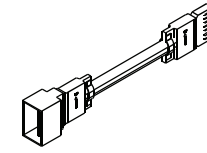

Ordering Options:

There are no ordering options for these items

Code	Price	H	W	D	Volume (ft ³)	Weight (lb)
K-EX84-12	152	0	12	0	0.05	0.9

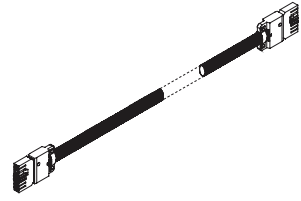

Ordering Options:

There are no ordering options for these items

Code	Price	H	W	D	Volume (ft ³)	Weight (lb)
K-EH-22	233	0	22	0	0.6	0.7
K-EH-25	239	0	25	0	0.7	0.7
K-EH-28	246	0	28	0	0.8	0.7
K-EH-31	251	0	31	0	0.8	0.8
K-EH-34	263	0	34	0	0.9	0.8
K-EH-37	275	0	37	0	1	1
K-EH-40	278	0	40	0	1.1	1
K-EH-43	289	0	43	0	1.2	1.2
K-EH-46	301	0	46	0	1.3	1.5
K-EH-49	307	0	49	0	1.5	1.5
K-EH-52	318	0	52	0	1.5	1.6
K-EH-55	322	0	55	0	1.6	1.6
K-EH-58	334	0	58	0	1.7	1.8
K-EH-61	340	0	61	0	1.8	1.8
K-EH-64	348	0	64	0	1.9	1.9
K-EH-67	354	0	67	0	1.9	1.9
K-EH-70	370	0	70	0	2	1.95
K-EH-73	375	0	73	0	1.95	1.95
K-EH-76	382	0	76	0	2.04	2.12
K-EH-79	396	0	79	0	2.12	2.12
K-EH-82	399	0	82	0	2.12	2.37
K-EH-85	409	0	85	0	2.37	2.37
K-EH-88	422	0	88	0	2.37	2.37
K-EH-91	427	0	91	0	2.37	2.37

continued on next page

electrical harness continued [2 of 2]

Code	Price	H	W	D	Volume (ft ³)	Weight (lb)
K-EH-94	436	0	94	0	2.53	2.53
K-EH-97	444	0	97	0	2.53	2.53
K-EH-100	456	0	100	0	2.7	2.7
K-EH-103	463	0	103	0	2.7	2.7
K-EH-106	472	0	106	0	2.86	2.86
K-EH-109	480	0	109	0	2.86	2.86
K-EH-112	487	0	112	0	3.03	3.03
K-EH-115	499	0	115	0	3.03	3.03
K-EH-118	506	0	118	0	3.19	3.36
K-EH-121	513	0	121	0	3.36	3.36
K-EH-124	522	0	124	0	3.36	3.46
K-EH-127	534	0	127	0	3.52	3.46
K-EH-130	538	0	130	0	3.52	3.56
K-EH-133	545	0	133	0	3.39	3.56
K-EH-136	557	0	136	0	3.68	3.76
K-EH-139	566	0	139	0	3.85	3.76
K-EH-142	572	0	142	0	3.85	3.86
K-EH-145	756	0	145	0	3.85	3.86
K-EH-148	762	0	148	0	3.85	3.86
K-EH-151	774	0	151	0	4.18	4.06
K-EH-154	780	0	154	0	4.26	4.06
K-EH-157	786	0	157	0	4.35	4.16
K-EH-160	794	0	160	0	4.43	4.16
K-EH-163	807	0	163	0	4.51	4.26
K-EH-166	813	0	166	0	4.59	4.26
K-EH-169	819	0	169	0	4.68	4.46
K-EH-172	832	0	172	0	4.76	4.46
K-EH-175	838	0	175	0	4.84	4.46
K-EH-178	844	0	178	0	4.92	4.66
K-EH-181	851	0	181	0	5.01	4.66



Metro Collab
January 2026
Screens

screens

<u>laminare screens</u>	144
<u>fabric screens</u>	149
<u>glazed screens</u>	154
<u>whiteboard screens</u>	159
<u>accessory screen</u>	163

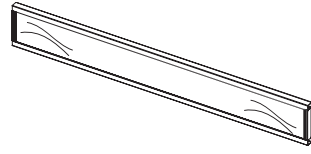

Ordering Options:

Use the following checklist to customize the finishes on your order:

- laminate color

Details:

1. Specify screen width to match surface width.
2. Surfaces 78 inches and wider require 2 screens and filler.

Code	Price	H	W	D	Volume (ft ³)	Weight (lb.)
K-SL0-0418	55	4	18	0	0.02	1.2
K-SL0-0421	56	4	21	0	0.03	1.4
K-SL0-0424	58	4	24	0	0.03	1.6
K-SL0-0427	62	4	27	0	0.03	1.8
K-SL0-0430	66	4	30	0	0.04	2
K-SL0-0433	68	4	33	0	0.04	2.3
K-SL0-0436	69	4	36	0	0.05	2.5
K-SL0-0439	74	4	39	0	0.05	2.7
K-SL0-0442	76	4	42	0	0.06	2.9
K-SL0-0445	78	4	45	0	0.06	3.1
K-SL0-0448	81	4	48	0	0.07	3.3
K-SL0-0451	86	4	51	0	0.07	3.5
K-SL0-0454	87	4	54	0	0.08	3.7
K-SL0-0457	93	4	57	0	0.08	3.9

continued on next page

laminate screens 2 of 5 continued

Code	Price	H	W	D	Volume (ft ³)	Weight (lb.)
K-SL0-0460	94	4	60	0	0.09	4.1
K-SL0-0463	98	4	63	0	0.09	4.3
K-SL0-0466	102	4	66	0	0.1	4.5
K-SL0-0469	102	4	69	0	0.1	4.7
K-SL0-0472	104	4	72	0	0.11	4.9
K-SL0-0804	43	8	4	0	0.01	1
K-SL0-0818	62	8	18	0	0.04	2.4
K-SL0-0821	68	8	21	0	0.06	2.8
K-SL0-0824	72	8	24	0	0.06	3.2
K-SL0-0827	76	8	27	0	0.06	3.6
K-SL0-0830	78	8	30	0	0.08	4
K-SL0-0833	82	8	33	0	0.08	4.6
K-SL0-0836	87	8	36	0	0.1	5
K-SL0-0839	93	8	39	0	0.1	5.4
K-SL0-0842	96	8	42	0	0.12	5.8
K-SL0-0845	100	8	45	0	0.12	6.2
K-SL0-0848	104	8	48	0	0.14	6.6
K-SL0-0851	107	8	51	0	0.14	7
K-SL0-0854	114	8	54	0	0.16	7.4
K-SL0-0857	120	8	57	0	0.16	7.8
K-SL0-0860	124	8	60	0	0.18	8.2
K-SL0-0863	128	8	63	0	0.18	8.6
K-SL0-0866	130	8	66	0	0.2	9
K-SL0-0869	136	8	69	0	0.2	9.4
K-SL0-0872	142	8	72	0	0.2	9.8
K-SL0-1204	47	12	4	0	0.01	1.1
K-SL0-1218	72	12	18	0	0.06	3.6
K-SL0-1221	77	12	21	0	0.09	4.2
K-SL0-1224	78	12	24	0	0.09	4.8
K-SL0-1227	87	12	27	0	0.09	5.4
K-SL0-1230	93	12	30	0	0.12	6

laminate screens 3 of 5 continued

Code	Price	H	W	D	Volume (ft³)	Weight (lb.)
K-SL0-1233	98	12	33	0	0.12	6.9
K-SL0-1236	104	12	36	0	0.15	7.5
K-SL0-1239	107	12	39	0	0.15	8.1
K-SL0-1242	116	12	42	0	0.18	8.7
K-SL0-1245	122	12	45	0	0.18	9.3
K-SL0-1248	128	12	48	0	0.21	9.9
K-SL0-1251	132	12	51	0	0.21	10.5
K-SL0-1254	141	12	54	0	0.24	11.1
K-SL0-1257	145	12	57	0	0.24	11.7
K-SL0-1260	149	12	60	0	0.27	12.3
K-SL0-1263	157	12	63	0	0.27	12.9
K-SL0-1266	162	12	66	0	0.3	13.5
K-SL0-1269	172	12	69	0	0.3	14.1
K-SL0-1272	175	12	72	0	0.33	14.7
K-SL0-1604	48	16	4	0	0.02	1.2
K-SL0-1618	78	16	18	0	0.08	4.8
K-SL0-1621	87	16	21	0	0.12	5.6
K-SL0-1624	93	16	24	0	0.12	6.4
K-SL0-1627	100	16	27	0	0.12	7.2
K-SL0-1630	106	16	30	0	0.16	8
K-SL0-1633	116	16	33	0	0.16	9.2
K-SL0-1636	122	16	36	0	0.2	10
K-SL0-1639	129	16	39	0	0.2	10.8
K-SL0-1642	136	16	42	0	0.24	11.6
K-SL0-1645	144	16	45	0	0.24	12.4
K-SL0-1648	149	16	48	0	0.28	13.2
K-SL0-1651	158	16	51	0	0.28	14
K-SL0-1654	169	16	54	0	0.32	14.8
K-SL0-1657	174	16	57	0	0.32	15.6
K-SL0-1660	180	16	60	0	0.36	16.4
K-SL0-1663	187	16	63	0	0.36	17.2

laminate screens 4 of 5 continued

Code	Price	H	W	D	Volume (ft³)	Weight (lb.)
K-SL0-1666	195	16	66	0	0.4	18
K-SL0-1669	203	16	69	0	0.4	18.8
K-SL0-1672	213	16	72	0	0.44	19.6
K-SL0-2004	53	20	4	0	0.03	1.4
K-SL0-2018	87	20	18	0	0.1	6
K-SL0-2021	98	20	21	0	0.15	7
K-SL0-2024	102	20	24	0	0.15	8
K-SL0-2027	114	20	27	0	0.15	9
K-SL0-2030	124	20	30	0	0.2	10
K-SL0-2033	130	20	33	0	0.2	11.5
K-SL0-2036	141	20	36	0	0.25	12.5
K-SL0-2039	147	20	39	0	0.25	13.5
K-SL0-2042	157	20	42	0	0.3	14.5
K-SL0-2045	169	20	45	0	0.3	15.5
K-SL0-2048	175	20	48	0	0.35	16.5
K-SL0-2051	183	20	51	0	0.35	17.5
K-SL0-2054	191	20	54	0	0.4	18.5
K-SL0-2057	201	20	57	0	0.4	19.5
K-SL0-2060	209	20	60	0	0.45	20.5
K-SL0-2063	220	20	63	0	0.45	21.5
K-SL0-2066	230	20	66	0	0.5	22.5
K-SL0-2069	239	20	69	0	0.5	23.5
K-SL0-2072	246	20	72	0	0.55	24.5
K-SL0-2404	55	24	4	0	0.03	1.6
K-SL0-2418	98	24	18	0	0.12	7.2
K-SL0-2421	107	24	21	0	0.18	8.4
K-SL0-2424	116	24	24	0	0.18	9.6
K-SL0-2427	128	24	27	0	0.18	10.8
K-SL0-2430	136	24	30	0	0.24	12
K-SL0-2433	146	24	33	0	0.24	13.8
K-SL0-2436	157	24	36	0	0.3	15

laminate screens 5 of 5 continued

Code	Price	H	W	D	Volume (ft ³)	Weight (lb.)
K-SL0-2439	170	24	39	0	0.3	16.2
K-SL0-2442	177	24	42	0	0.36	17.4
K-SL0-2445	187	24	45	0	0.36	18.6
K-SL0-2448	198	24	48	0	0.42	19.8
K-SL0-2451	206	24	51	0	0.42	21
K-SL0-2454	220	24	54	0	0.48	22.2
K-SL0-2457	233	24	57	0	0.48	23.4
K-SL0-2460	242	24	60	0	0.54	24.6
K-SL0-2463	249	24	63	0	0.54	25.8
K-SL0-2466	262	24	66	0	0.6	27
K-SL0-2469	274	24	69	0	0.6	28.2
K-SL0-2472	280	24	72	0	0.66	29.4
K-SL0-3204	58	32	4	0	0.04	2.3
K-SL0-3218	117	32	18	0	0.16	9.6
K-SL0-3221	130	32	21	0	0.24	11.2
K-SL0-3224	142	32	24	0	0.24	12.8
K-SL0-3227	156	32	27	0	0.24	14.4
K-SL0-3230	170	32	30	0	0.32	16
K-SL0-3233	180	32	33	0	0.32	18.4
K-SL0-3236	194	32	36	0	0.4	20
K-SL0-3239	206	32	39	0	0.4	21.6
K-SL0-3242	220	32	42	0	0.48	23.2
K-SL0-3245	237	32	45	0	0.48	24.8
K-SL0-3248	246	32	48	0	0.56	26.4
K-SL0-3251	262	32	51	0	0.56	28
K-SL0-3254	275	32	54	0	0.64	29.6
K-SL0-3257	287	32	57	0	0.64	31.2
K-SL0-3260	301	32	60	0	0.72	32.8
K-SL0-3263	315	32	63	0	0.72	34.4
K-SL0-3266	326	32	66	0	0.8	36
K-SL0-3269	339	32	69	0	0.8	37.6
K-SL0-3272	350	32	72	0	0.88	39.2

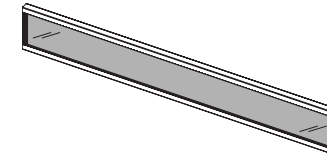

Ordering Options:

Use the following checklist to customize the finishes on your order:

- glazing

Details:

1. Specify screen width to match surface width.
2. Surfaces 78 inches and wider require 2 screens and filler.

Code	Price	H	W	D	Volume (ft ³)	Weight (lb.)
K-SF0-0418	144	4	18	0	0.02	1.3
K-SF0-0421	145	4	21	0	0.03	1.4
K-SF0-0424	145	4	24	0	0.03	1.5
K-SF0-0427	146	4	27	0	0.03	1.6
K-SF0-0430	147	4	30	0	0.04	1.7
K-SF0-0433	149	4	33	0	0.04	1.8
K-SF0-0436	152	4	36	0	0.05	1.8
K-SF0-0439	156	4	39	0	0.05	1.9
K-SF0-0442	175	4	42	0	0.06	2
K-SF0-0445	177	4	45	0	0.06	2.1
K-SF0-0448	180	4	48	0	0.07	2.2
K-SF0-0451	180	4	51	0	0.07	2.3
K-SF0-0454	183	4	54	0	0.08	2.3
K-SF0-0457	185	4	57	0	0.08	2.4
K-SF0-0460	187	4	60	0	0.09	2.5

continued on next page

fabric screens 2 of 5 continued

Code	Price	H	W	D	Volume (ft³)	Weight (lb.)
K-SF0-0463	189	4	63	0	0.09	2.6
K-SF0-0466	191	4	66	0	0.1	2.7
K-SF0-0469	194	4	69	0	0.1	2.8
K-SF0-0472	195	4	72	0	0.11	2.8
K-SF0-0804	132	8	4	0	0.01	0.7
K-SF0-0818	160	8	18	0	0.04	2.7
K-SF0-0821	162	8	21	0	0.06	2.9
K-SF0-0824	162	8	24	0	0.06	3
K-SF0-0827	170	8	27	0	0.06	3.2
K-SF0-0830	172	8	30	0	0.08	3.3
K-SF0-0833	173	8	33	0	0.08	3.5
K-SF0-0836	174	8	36	0	0.1	3.7
K-SF0-0839	175	8	39	0	0.1	3.9
K-SF0-0842	213	8	42	0	0.12	4
K-SF0-0845	216	8	45	0	0.12	4.2
K-SF0-0848	218	8	48	0	0.14	4.3
K-SF0-0851	218	8	51	0	0.14	4.5
K-SF0-0854	220	8	54	0	0.16	4.7
K-SF0-0857	225	8	57	0	0.16	4.9
K-SF0-0860	229	8	60	0	0.18	5
K-SF0-0863	230	8	63	0	0.18	5.2
K-SF0-0866	233	8	66	0	0.2	5.3
K-SF0-0869	237	8	69	0	0.2	5.5
K-SF0-0872	238	8	72	0	0.22	5.7
K-SF0-1204	133	12	4	0	0.01	1
K-SF0-1218	177	12	18	0	0.06	4
K-SF0-1221	180	12	21	0	0.09	4.3
K-SF0-1224	180	12	24	0	0.09	4.5
K-SF0-1227	185	12	27	0	0.09	4.8
K-SF0-1230	187	12	30	0	0.12	5
K-SF0-1233	189	12	33	0	0.12	5.3

fabric screens 3 of 5 continued

Code	Price	H	W	D	Volume (ft³)	Weight (lb.)
K-SF0-1236	191	12	36	0	0.15	5.5
K-SF0-1239	195	12	39	0	0.15	5.8
K-SF0-1242	247	12	42	0	0.18	6
K-SF0-1245	249	12	45	0	0.18	6.3
K-SF0-1248	251	12	48	0	0.21	6.5
K-SF0-1251	251	12	51	0	0.21	6.8
K-SF0-1254	259	12	54	0	0.24	7
K-SF0-1257	263	12	57	0	0.24	7.3
K-SF0-1260	265	12	60	0	0.27	7.5
K-SF0-1263	267	12	63	0	0.27	7.8
K-SF0-1266	274	12	66	0	0.3	8
K-SF0-1269	275	12	69	0	0.3	8.3
K-SF0-1272	277	12	72	0	0.33	8.5
K-SF0-1604	133	16	4	0	0.02	1.3
K-SF0-1618	195	16	18	0	0.08	5.3
K-SF0-1621	199	16	21	0	0.12	5.7
K-SF0-1624	199	16	24	0	0.12	6
K-SF0-1627	203	16	27	0	0.12	6.4
K-SF0-1630	204	16	30	0	0.16	6.7
K-SF0-1633	209	16	33	0	0.16	7.1
K-SF0-1636	213	16	36	0	0.2	7.3
K-SF0-1639	217	16	39	0	0.2	7.7
K-SF0-1642	282	16	42	0	0.24	8
K-SF0-1645	287	16	45	0	0.24	8.4
K-SF0-1648	295	16	48	0	0.28	8.7
K-SF0-1651	296	16	51	0	0.28	9.1
K-SF0-1654	298	16	54	0	0.32	9.3
K-SF0-1657	302	16	57	0	0.32	9.7
K-SF0-1660	307	16	60	0	0.36	10
K-SF0-1663	308	16	63	0	0.36	10.4
K-SF0-1666	313	16	66	0	0.4	10.7

fabric screens 4 of 5 continued

Code	Price	H	W	D	Volume (ft³)	Weight (lb.)
K-SF0-1669	318	16	69	0	0.4	11.1
K-SF0-1672	320	16	72	0	0.44	11.3
K-SF0-2004	136	20	4	0	0.03	1.4
K-SF0-2018	216	20	18	0	0.1	6.7
K-SF0-2021	218	20	21	0	0.15	7.2
K-SF0-2024	218	20	24	0	0.15	7.5
K-SF0-2027	221	20	27	0	0.15	8
K-SF0-2030	229	20	30	0	0.2	8.3
K-SF0-2033	233	20	33	0	0.2	8.8
K-SF0-2036	237	20	36	0	0.25	9.2
K-SF0-2039	238	20	39	0	0.25	9.7
K-SF0-2042	324	20	42	0	0.3	10
K-SF0-2045	327	20	45	0	0.3	10.5
K-SF0-2048	334	20	48	0	0.35	10.8
K-SF0-2051	336	20	51	0	0.35	11.3
K-SF0-2054	337	20	54	0	0.4	11.7
K-SF0-2057	340	20	57	0	0.4	12.2
K-SF0-2060	346	20	60	0	0.45	12.5
K-SF0-2063	349	20	63	0	0.45	13
K-SF0-2066	354	20	66	0	0.5	13.3
K-SF0-2069	361	20	69	0	0.5	13.8
K-SF0-2072	363	20	72	0	0.55	14.2
K-SF0-2404	136	24	4	0	0.03	2
K-SF0-2418	235	24	18	0	0.12	8
K-SF0-2421	238	24	21	0	0.18	8.6
K-SF0-2424	238	24	24	0	0.18	9
K-SF0-2427	243	24	27	0	0.18	9.6
K-SF0-2430	246	24	30	0	0.24	10
K-SF0-2433	249	24	33	0	0.24	10.6
K-SF0-2436	251	24	36	0	0.3	11
K-SF0-2439	259	24	39	0	0.3	11.6

fabric screens 5 of 5 continued

Code	Price	H	W	D	Volume (ft³)	Weight (lb.)
K-SF0-2442	363	24	42	0	0.36	12
K-SF0-2445	368	24	45	0	0.36	12.6
K-SF0-2448	371	24	48	0	0.42	13
K-SF0-2451	375	24	51	0	0.42	13.6
K-SF0-2454	379	24	54	0	0.48	14
K-SF0-2457	383	24	57	0	0.48	14.6
K-SF0-2460	387	24	60	0	0.54	15
K-SF0-2463	393	24	63	0	0.54	15.6
K-SF0-2466	397	24	66	0	0.6	16
K-SF0-2469	399	24	69	0	0.6	26.6
K-SF0-2472	407	24	72	0	0.66	17
K-SF0-3204	142	32	4	0	0.04	2.7
K-SF0-3218	270	32	18	0	0.16	10.7
K-SF0-3221	276	32	21	0	0.24	11.5
K-SF0-3224	277	32	24	0	0.24	12
K-SF0-3227	280	32	27	0	0.24	12.8
K-SF0-3230	287	32	30	0	0.32	13.3
K-SF0-3233	295	32	33	0	0.32	14.1
K-SF0-3236	298	32	36	0	0.4	14.7
K-SF0-3239	302	32	39	0	0.4	15.5
K-SF0-3242	438	32	42	0	0.48	16
K-SF0-3245	440	32	45	0	0.48	16.8
K-SF0-3248	450	32	48	0	0.56	17.3
K-SF0-3251	453	32	51	0	0.56	18.1
K-SF0-3254	457	32	54	0	0.64	18.7
K-SF0-3257	463	32	57	0	0.64	19.5
K-SF0-3260	470	32	60	0	0.72	20
K-SF0-3263	474	32	63	0	0.72	20.8
K-SF0-3266	480	32	66	0	0.8	21.3
K-SF0-3269	482	32	69	0	0.8	22.1
K-SF0-3272	487	32	72	0	0.88	22.7

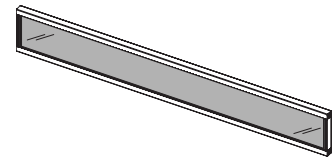

Ordering Options:

Use the following checklist to customize the finishes on your order:

- glazing color

Details:

1. Specify screen width to match surface width.
2. Surfaces 78 inches and wider require 2 screens and filler.

Code	Price	H	W	D	Volume (ft ³)	Weight (lb.)
K-SG0-0418	174	4	18	0	0.02	0.8
K-SG0-0421	187	4	21	0	0.03	0.9
K-SG0-0424	201	4	24	0	0.03	0.98
K-SG0-0427	218	4	27	0	0.03	1.1
K-SG0-0430	235	4	30	0	0.04	1.23
K-SG0-0433	246	4	33	0	0.04	1.3
K-SG0-0436	263	4	36	0	0.05	1.47
K-SG0-0439	277	4	39	0	0.05	1.6
K-SG0-0442	295	4	42	0	0.06	1.72
K-SG0-0445	308	4	45	0	0.06	1.8
K-SG0-0448	322	4	48	0	0.07	1.96
K-SG0-0451	337	4	51	0	0.07	2.1
K-SG0-0454	350	4	54	0	0.08	2.21
K-SG0-0457	370	4	57	0	0.08	2.3
K-SG0-0460	383	4	60	0	0.09	2.45

continued on next page

glazed screens 2 of 5 continued

Code	Price	H	W	D	Volume (ft ³)	Weight (lb.)
K-SG0-0463	399	4	63	0	0.09	2.6
K-SG0-0466	413	4	66	0	0.1	2.8
K-SG0-0469	432	4	69	0	0.1	3
K-SG0-0472	441	4	72	0	0.11	3.2
K-SG0-0804	64	8	4	0	0.01	0.4
K-SG0-0818	195	8	18	0	0.04	1.6
K-SG0-0821	217	8	21	0	0.06	1.8
K-SG0-0824	238	8	24	0	0.06	1.96
K-SG0-0827	253	8	27	0	0.06	2.2
K-SG0-0830	277	8	30	0	0.08	2.46
K-SG0-0833	298	8	33	0	0.08	2.6
K-SG0-0836	319	8	36	0	0.1	2.94
K-SG0-0839	337	8	39	0	0.1	3.2
K-SG0-0842	361	8	42	0	0.12	3.44
K-SG0-0845	379	8	45	0	0.12	3.6
K-SG0-0848	399	8	48	0	0.14	3.92
K-SG0-0851	420	8	51	0	0.14	4.2
K-SG0-0854	440	8	54	0	0.16	4.42
K-SG0-0857	463	8	57	0	0.16	4.6
K-SG0-0860	482	8	60	0	0.18	4.9
K-SG0-0863	505	8	63	0	0.18	5.2
K-SG0-0866	522	8	66	0	0.2	5.6
K-SG0-0869	543	8	69	0	0.2	6
K-SG0-0872	566	8	72	0	0.22	6.4
K-SG0-1204	72	12	4	0	0.01	0.6
K-SG0-1218	220	12	18	0	0.06	2.4
K-SG0-1221	244	12	21	0	0.09	2.7
K-SG0-1224	274	12	24	0	0.09	2.94
K-SG0-1227	298	12	27	0	0.09	3.3
K-SG0-1230	324	12	30	0	0.12	3.69
K-SG0-1233	348	12	33	0	0.12	3.9

glazed screens 3 of 5 continued

Code	Price	H	W	D	Volume (ft³)	Weight (lb.)
K-SG0-1236	375	12	36	0	0.15	4.41
K-SG0-1239	402	12	39	0	0.15	4.8
K-SG0-1242	424	12	42	0	0.18	5.16
K-SG0-1245	453	12	45	0	0.18	5.4
K-SG0-1248	480	12	48	0	0.21	5.88
K-SG0-1251	505	12	51	0	0.21	6.3
K-SG0-1254	531	12	54	0	0.24	6.63
K-SG0-1257	557	12	57	0	0.24	6.9
K-SG0-1260	582	12	60	0	0.27	7.35
K-SG0-1263	608	12	63	0	0.27	7.8
K-SG0-1266	637	12	66	0	0.3	8.4
K-SG0-1269	659	12	69	0	0.3	9
K-SG0-1272	687	12	72	0	0.33	9.6
K-SG0-1604	81	16	4	0	0.02	0.8
K-SG0-1618	265	16	18	0	0.08	3.2
K-SG0-1621	298	16	21	0	0.12	3.6
K-SG0-1624	327	16	24	0	0.12	3.92
K-SG0-1627	361	16	27	0	0.12	4.4
K-SG0-1630	393	16	30	0	0.16	4.92
K-SG0-1633	422	16	33	0	0.16	5.2
K-SG0-1636	453	16	36	0	0.2	5.88
K-SG0-1639	485	16	39	0	0.2	6.4
K-SG0-1642	516	16	42	0	0.24	6.88
K-SG0-1645	545	16	45	0	0.24	7.2
K-SG0-1648	580	16	48	0	0.28	7.84
K-SG0-1651	608	16	51	0	0.28	8.4
K-SG0-1654	641	16	54	0	0.32	8.84
K-SG0-1657	671	16	57	0	0.32	9.2
K-SG0-1660	704	16	60	0	0.36	9.8
K-SG0-1663	734	16	63	0	0.36	10.4
K-SG0-1666	764	16	66	0	0.4	11.2

glazed screens 4 of 5 continued

Code	Price	H	W	D	Volume (ft³)	Weight (lb.)
K-SG0-1669	799	16	69	0	0.4	12
K-SG0-1672	828	16	72	0	0.44	12.8
K-SG0-2004	92	20	4	0	0.03	0.9
K-SG0-2018	267	20	18	0	0.1	4
K-SG0-2021	307	20	21	0	0.15	4.5
K-SG0-2024	340	20	24	0	0.15	4.9
K-SG0-2027	379	20	27	0	0.15	5.5
K-SG0-2030	414	20	30	0	0.2	6.15
K-SG0-2033	453	20	33	0	0.2	6.5
K-SG0-2036	487	20	36	0	0.25	7.35
K-SG0-2039	523	20	39	0	0.25	8
K-SG0-2042	565	20	42	0	0.3	8.6
K-SG0-2045	600	20	45	0	0.3	9
K-SG0-2048	639	20	48	0	0.35	9.8
K-SG0-2051	671	20	51	0	0.35	10.5
K-SG0-2054	709	20	54	0	0.4	11.05
K-SG0-2057	744	20	57	0	0.4	11.5
K-SG0-2060	784	20	60	0	0.45	12.25
K-SG0-2063	819	20	63	0	0.45	13
K-SG0-2066	855	20	66	0	0.5	14
K-SG0-2069	893	20	69	0	0.5	15
K-SG0-2072	931	20	72	0	0.55	16
K-SG0-2404	98	24	4	0	0.03	0.98
K-SG0-2418	294	24	18	0	0.12	4.8
K-SG0-2421	335	24	21	0	0.18	5.4
K-SG0-2424	376	24	24	0	0.18	5.88
K-SG0-2427	416	24	27	0	0.18	6.6
K-SG0-2430	461	24	30	0	0.24	7.38
K-SG0-2433	505	24	33	0	0.24	7.8
K-SG0-2436	543	24	36	0	0.3	8.82
K-SG0-2439	584	24	39	0	0.3	9.6

glazed screens 5 of 5 continued

Code	Price	H	W	D	Volume (ft³)	Weight (lb.)
K-SG0-2442	629	24	42	0	0.36	10.32
K-SG0-2445	667	24	45	0	0.36	10.8
K-SG0-2448	715	24	48	0	0.42	11.76
K-SG0-2451	758	24	51	0	0.42	12.6
K-SG0-2454	794	24	54	0	0.48	13.26
K-SG0-2457	840	24	57	0	0.48	13.8
K-SG0-2460	885	24	60	0	0.54	14.7
K-SG0-2463	925	24	63	0	0.54	15.6
K-SG0-2466	967	24	66	0	0.6	16.8
K-SG0-2469	1009	24	69	0	0.6	18
K-SG0-2472	1052	24	72	0	0.66	19.2
K-SG0-3204	116	32	4	0	0.04	1.3
K-SG0-3218	339	32	18	0	0.16	6.4
K-SG0-3221	396	32	21	0	0.24	7.2
K-SG0-3224	444	32	24	0	0.24	7.84
K-SG0-3227	500	32	27	0	0.24	8.8
K-SG0-3230	555	32	30	0	0.32	9.84
K-SG0-3233	605	32	33	0	0.32	10.4
K-SG0-3236	658	32	36	0	0.4	11.76
K-SG0-3239	712	32	39	0	0.4	12.8
K-SG0-3242	762	32	42	0	0.48	13.76
K-SG0-3245	818	32	45	0	0.48	14.4
K-SG0-3248	865	32	48	0	0.56	15.68
K-SG0-3251	923	32	51	0	0.56	16.8
K-SG0-3254	978	32	54	0	0.64	17.68
K-SG0-3257	1028	32	57	0	0.64	18.4
K-SG0-3260	1083	32	60	0	0.72	19.6
K-SG0-3263	1136	32	63	0	0.72	20.8
K-SG0-3266	1187	32	66	0	0.8	22.4
K-SG0-3269	1243	32	69	0	0.8	24
K-SG0-3272	1298	32	72	0	0.88	25.6

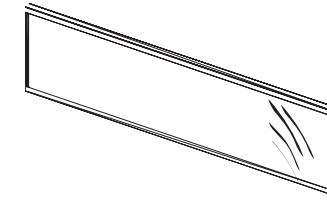

Ordering Options:

There are no ordering options for this item.

Details:

1. Specify screen width to match surface width.
2. Surfaces 78 inches and wider require 2 screens and filler.

Code	Price	H	W	D	Volume (ft³)	Weight (lb.)
K-SW0-0818	101	8	18	0	0.04	2.4
K-SW0-0821	107	8	21	0	0.06	2.8
K-SW0-0824	117	8	24	0	0.06	3.2
K-SW0-0827	122	8	27	0	0.06	3.6
K-SW0-0830	129	8	30	0	0.08	4
K-SW0-0833	135	8	33	0	0.08	4.6
K-SW0-0836	144	8	36	0	0.1	5
K-SW0-0839	149	8	39	0	0.1	5.4
K-SW0-0842	158	8	42	0	0.12	5.8
K-SW0-0845	160	8	45	0	0.12	6.2
K-SW0-0848	167	8	48	0	0.14	6.6
K-SW0-0851	175	8	51	0	0.14	7
K-SW0-0854	180	8	54	0	0.16	7.4
K-SW0-0857	187	8	57	0	0.16	7.8
K-SW0-0860	196	8	60	0	0.18	8.2
K-SW0-0863	202	8	63	0	0.18	8.6
K-SW0-0866	213	8	66	0	0.2	9
K-SW0-0869	218	8	69	0	0.2	9.4

continued on next page

whiteboard screens 2 of 4 continued

Code	Price	H	W	D	Volume (ft³)	Weight (lb.)
K-SW0-0872	221	8	72	0	0.22	9.8
K-SW0-1218	116	12	18	0	0.06	3.6
K-SW0-1221	122	12	21	0	0.09	4.2
K-SW0-1224	130	12	24	0	0.09	4.8
K-SW0-1227	142	12	27	0	0.09	5.4
K-SW0-1230	149	12	30	0	0.12	6
K-SW0-1233	159	12	33	0	0.12	6.9
K-SW0-1236	164	12	36	0	0.15	7.5
K-SW0-1239	175	12	39	0	0.15	8.1
K-SW0-1242	184	12	42	0	0.18	8.7
K-SW0-1245	195	12	45	0	0.18	9.3
K-SW0-1248	204	12	48	0	0.21	9.9
K-SW0-1251	217	12	51	0	0.21	10.5
K-SW0-1254	221	12	54	0	0.24	11.1
K-SW0-1257	233	12	57	0	0.24	11.7
K-SW0-1260	242	12	60	0	0.27	12.3
K-SW0-1263	250	12	63	0	0.27	12.9
K-SW0-1266	263	12	66	0	0.3	13.5
K-SW0-1269	274	12	69	0	0.3	14.1
K-SW0-1272	281	12	72	0	0.33	14.7
K-SW0-1618	124	16	18	0	0.08	4.8
K-SW0-1621	135	16	21	0	0.12	5.6
K-SW0-1624	149	16	24	0	0.12	6.4
K-SW0-1627	159	16	27	0	0.12	7.2
K-SW0-1630	173	16	30	0	0.16	8
K-SW0-1633	181	16	33	0	0.16	9.2
K-SW0-1636	195	16	36	0	0.2	10
K-SW0-1639	204	16	39	0	0.2	10.8
K-SW0-1642	218	16	42	0	0.24	11.6
K-SW0-1645	228	16	45	0	0.24	12.4
K-SW0-1648	242	16	48	0	0.28	13.2
K-SW0-1651	254	16	51	0	0.28	14

whiteboard screens3 of 4 continued

Code	Price	H	W	D	Volume (ft³)	Weight (lb.)
K-SW0-1654	264	16	54	0	0.32	14.8
K-SW0-1657	277	16	57	0	0.32	15.6
K-SW0-1660	294	16	60	0	0.36	16.4
K-SW0-1663	304	16	63	0	0.36	17.2
K-SW0-1666	313	16	66	0	0.4	18
K-SW0-1669	329	16	69	0	0.4	18.8
K-SW0-1672	342	16	72	0	0.44	19.6
K-SW0-2018	135	20	18	0	0.1	6
K-SW0-2021	155	20	21	0	0.15	7
K-SW0-2024	161	20	24	0	0.15	8
K-SW0-2027	175	20	27	0	0.15	9
K-SW0-2030	189	20	30	0	0.2	10
K-SW0-2033	209	20	33	0	0.2	11.5
K-SW0-2036	221	20	36	0	0.25	12.5
K-SW0-2039	235	20	39	0	0.25	13.5
K-SW0-2042	249	20	42	0	0.3	14.5
K-SW0-2045	264	20	45	0	0.3	15.5
K-SW0-2048	277	20	48	0	0.35	16.5
K-SW0-2051	298	20	51	0	0.35	17.5
K-SW0-2054	306	20	54	0	0.4	18.5
K-SW0-2057	323	20	57	0	0.4	19.5
K-SW0-2060	340	20	60	0	0.45	20.5
K-SW0-2063	350	20	63	0	0.45	21.5
K-SW0-2066	371	20	66	0	0.5	22.5
K-SW0-2069	387	20	69	0	0.5	23.5
K-SW0-2072	400	20	72	0	0.55	24.5
K-SW0-2418	149	24	18	0	0.12	7.2
K-SW0-2421	161	24	21	0	0.18	8.4
K-SW0-2424	180	24	24	0	0.18	9.6
K-SW0-2427	196	24	27	0	0.18	10.8
K-SW0-2430	217	24	30	0	0.24	12
K-SW0-2433	233	24	33	0	0.24	13.8

whiteboard screens 4 of 4 continued

Code	Price	H	W	D	Volume (ft³)	Weight (lb.)
K-SW0-2436	247	24	36	0	0.3	15
K-SW0-2439	264	24	39	0	0.3	16.2
K-SW0-2442	287	24	42	0	0.36	17.4
K-SW0-2445	302	24	45	0	0.36	18.6
K-SW0-2448	313	24	48	0	0.42	19.8
K-SW0-2451	335	24	51	0	0.42	21
K-SW0-2454	349	24	54	0	0.48	22.2
K-SW0-2457	371	24	57	0	0.48	23.4
K-SW0-2460	388	24	60	0	0.54	24.6
K-SW0-2463	407	24	63	0	0.54	25.8
K-SW0-2466	423	24	66	0	0.6	27
K-SW0-2469	438	24	69	0	0.6	28.2
K-SW0-2472	461	24	72	0	0.66	29.4
K-SW0-3218	173	32	18	0	0.16	9.6
K-SW0-3221	189	32	21	0	0.24	11.2
K-SW0-3224	214	32	24	0	0.24	12.8
K-SW0-3227	238	32	27	0	0.24	14.4
K-SW0-3230	256	32	30	0	0.32	16
K-SW0-3233	281	32	33	0	0.32	18.4
K-SW0-3236	304	32	36	0	0.4	20
K-SW0-3239	327	32	39	0	0.4	21.6
K-SW0-3242	348	32	42	0	0.48	23.2
K-SW0-3245	374	32	45	0	0.48	24.8
K-SW0-3248	395	32	48	0	0.56	26.4
K-SW0-3251	416	32	51	0	0.56	28
K-SW0-3254	436	32	54	0	0.64	29.6
K-SW0-3257	462	32	57	0	0.64	31.2
K-SW0-3260	483	32	60	0	0.72	32.8
K-SW0-3263	508	32	63	0	0.72	34.4
K-SW0-3266	528	32	66	0	0.8	36
K-SW0-3269	553	32	69	0	0.8	37.6
K-SW0-3272	576	32	72	0	0.88	39.2

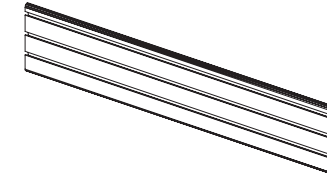

Ordering Options:

Use the following checklist to customize the finishes on your order:

- Metal color

Details:

- Specify screen width to match surface width.
- Surfaces 78 inches and wider require 2 screens and filler.

Code	Price	H	W	D	Volume (ft³)	Weight (lb.)
K-SA0-0818	114	8	18	0	0.05	1.3
K-SA0-0821	124	8	21	0	0.06	1.7
K-SA0-0824	133	8	24	0	0.07	1.96
K-SA0-0827	146	8	27	0	0.08	2.3
K-SA0-0830	158	8	30	0	0.09	2.45
K-SA0-0833	173	8	33	0	0.1	2.7
K-SA0-0836	180	8	36	0	0.1	2.94
K-SA0-0839	194	8	39	0	0.11	3.3
K-SA0-0842	204	8	42	0	0.12	3.43
K-SA0-0845	218	8	45	0	0.13	3.6
K-SA0-0848	230	8	48	0	0.14	3.92
K-SA0-0851	242	8	51	0	0.15	4.2
K-SA0-0854	250	8	54	0	0.16	4.41
K-SA0-0857	263	8	57	0	0.17	4.7
K-SA0-0860	277	8	60	0	0.18	4.9
K-SA0-0863	287	8	63	0	0.19	5.1
K-SA0-0866	301	8	66	0	2	5.4
K-SA0-0869	313	8	69	0	2.1	5.7
K-SA0-0872	324	8	72	0	2.2	6



Metro Collab
January 2026
Counter Tops

counter tops

glass	166
laminare 1.5 inch	167
boat laminare 1 inch	168
straight laminare 1 inch	169

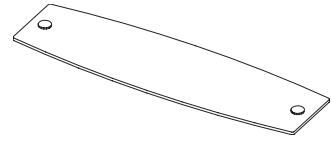

Glass, 3/8 inch

Ordering Options:

Details:

1. Tempered glass counter tops.
2. Counter tops 54 inches and wider are supported with 4 small posts.
3. Counter tops 48 inches and smaller supported by 2 small posts.

Code	Price	H	W	D	Volume (ft ³)	Weight (lb)
K-WTG-1221	667	0.37	21	12	0.2	15
K-WTG-1224	807	0.37	24	12	0.2	18
K-WTG-1230	877	0.37	30	12	0.3	21
K-WTG-1236	944	0.37	36	12	0.3	24
K-WTG-1242	1009	0.37	42	12	0.4	30
K-WTG-1248	1079	0.37	48	12	0.4	30
K-WTG-1254	1254	0.37	54	12	0.5	33
K-WTG-1260	1319	0.37	60	12	0.5	36
K-WTG-1266	1389	0.37	66	12	0.6	39
K-WTG-1272	1457	0.37	72	12	0.6	42

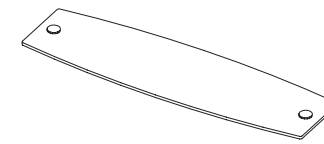

Laminate 1.5 inch

Ordering Options:

Use the following checklist to customize the finishes on your order:

- laminate color
- trim profile, 1.5 inches
- metal color

Details:

1. Laminate counter tops.
2. Counter tops 54 inches and wider are supported with 4 small posts.
3. Counter tops 48 inches and smaller supported by 2 small posts.

Code	Price	H	W	D	Volume (ft ³)	Weight (lb)
K-WTL-1221	334	1.5	21	12	0.2	12
K-WTL-1224	340	1.5	24	12	0.2	14
K-WTL-1230	362	1.5	30	12	0.3	17
K-WTL-1236	382	1.5	36	12	0.3	20
K-WTL-1242	402	1.5	42	12	0.4	23
K-WTL-1248	422	1.5	48	12	0.4	26
K-WTL-1254	439	1.5	54	12	0.5	29
K-WTL-1260	461	1.5	60	12	0.5	33
K-WTL-1266	482	1.5	66	12	0.6	36
K-WTL-1272	501	1.5	72	12	0.6	39

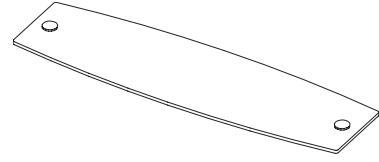

Boat, 1 inch

Ordering Options:

Use the following checklist to customize the finishes on your order:

- laminate color
- trim profile 1 inch
- metal color

Details:

1. Laminate counter tops.
2. Counter tops 54 inches and wider are supported with 4 small posts.
3. Counter tops 48 inches and smaller supported by 2 small posts.

Code	Price	H	W	D	Volume (ft ³)	Weight (lb)
KL-WTL-1221	319	1	21	12	0.2	8
KL-WTL-1224	326	1	24	12	0.2	9
KL-WTL-1230	339	1	30	12	0.3	11
KL-WTL-1236	360	1	36	12	0.3	13
KL-WTL-1242	374	1	42	12	0.4	15
KL-WTL-1248	387	1	48	12	0.4	17
KL-WTL-1254	403	1	54	12	0.5	19
KL-WTL-1260	420	1	60	12	0.5	22
KL-WTL-1266	436	1	66	12	0.6	24
KL-WTL-1272	453	1.5	72	12	0.6	26

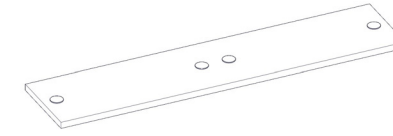

Straight 1 inch

Ordering Options:

Use the following checklist to customize the finishes on your order:

- laminate color
- trim profile, 1 inch
- metal color

Details:

1. Laminate counter tops.
2. Counter tops 54 inches and wider are supported with 4 small posts.
3. Counter tops 48 inches and smaller supported by 2 small posts.

Code	Price	H	W	D	Volume (ft ³)	Weight (lb)
KL-WTLS-1221	320	1.5	21	12	0	3.6
KL-WTLS-1224	326	1.5	24	12	0	4.1
KL-WTLS-1230	339	1.5	30	12	0	4.5
KL-WTLS-1236	360	1.5	36	12	0	4.9
KL-WTLS-1242	374	1.5	42	12	0	5.3
KL-WTLS-1245	383	1.5	45	12	0	5.5
KL-WTLS-1248	389	1.5	48	12	0	5.7
KL-WTLS-1254	403	1.5	54	12	0	6.1
KL-WTLS-1260	421	1.5	60	12	0	6.5
KL-WTLS-1266	436	1.5	66	12	0	6.9
KL-WTLS-1272	456	1.5	72	12	0	7.3



Metro Collab
January 2026

Wire Management

wire management

<u>vertical wire manager</u>	172
<u>horizontal wire manager</u>	173
<u>wire clip</u>	174



Ordering Options:

There are no ordering options for these items

Code	Price	H	W	D	Volume (ft ³)	Weight (lb)
V-EE00	362	28	4	4	0.25	1

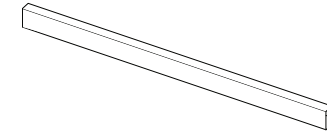

Ordering Options:

There are no ordering options for these items

Code	Price	H	W	D	Volume (ft ³)	Weight (lb)
V-EWHB-12	9	0	12	0	0.25	0.15
V-EWHB-24	19	0	24	0	0.25	0.35
V-EWHB-36	26	0	36	0	0.25	0.55

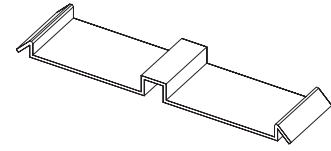

Ordering Options:

There are no ordering options for these items

Code	Price	H	W	D	Volume (ft ³)	Weight (lb)
V-EE00	362	28	4	4	0.25	1



Metro Collab
January 2026
Accessories

accessories

<u>Keyboard Tray</u>	<u>178</u>
<u>work organizer</u>	<u>179</u>
<u>monitor arm</u>	<u>180</u>
<u>task light</u>	<u>181</u>

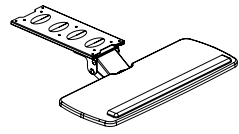

Articulating Keyboard Tray

What's Included:

Keyboard Tray, installation hardware.

How to Specify:

The articulating keyboards are available only in black.

Notes:

Keyboard trays provide adjustable ergonomic support for individuals in multi-task environments

Code	Price	H	W	D	Volume (ft ³)	Weight (lb)
Articulating Keyboard Tray						
V-KASX-2510	459	0	25	10	0	15

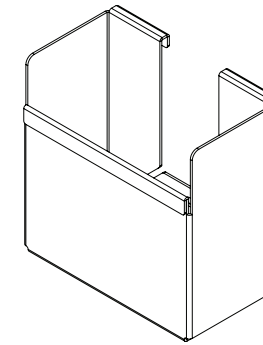

pencil holder

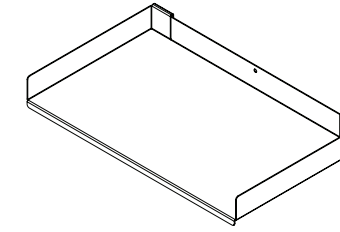

paper tray - legal

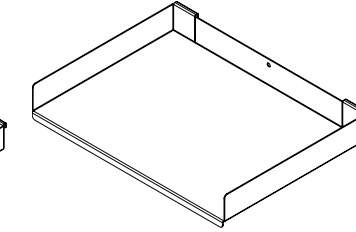

paper tray - letter

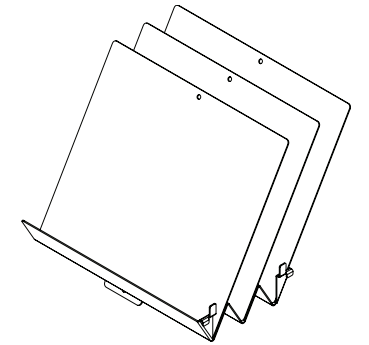

document sorter

Ordering Options:

Use the following checklist to customize the finishes on your order:

- metal color

Details:

Work organizers facilitate paper management and storage and easily hang on to accessory screens.

Code	Price	H	W	D	Weight (lb.)	Volume (ft ³)
pencil holder						
F-AAH	94	0	0	0	0.1	0.7
paper tray - legal						
F-AAP-13	117	0	15	10	3.2	0.1
paper tray - letter						
F-AAP-9	102	0	12	10	3.2	0.1
document sorter						
F-AAS	206	0	0	0	2.5	0.1

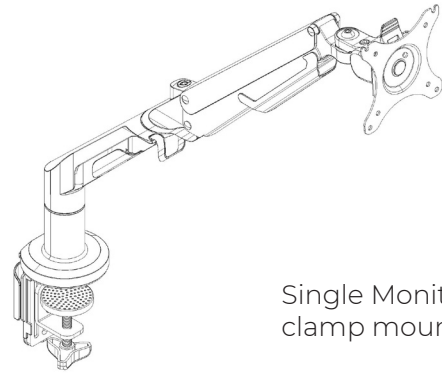

Single Monitor Arm - clamp mount

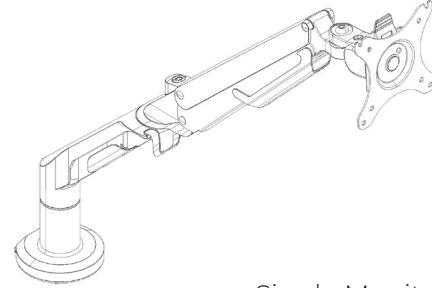

Single Monitor Arm - grommet mount

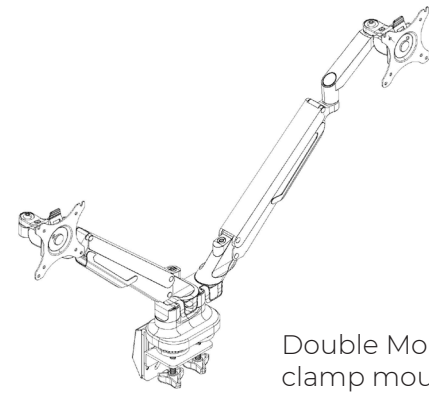

Double Monitor Arm - clamp mount

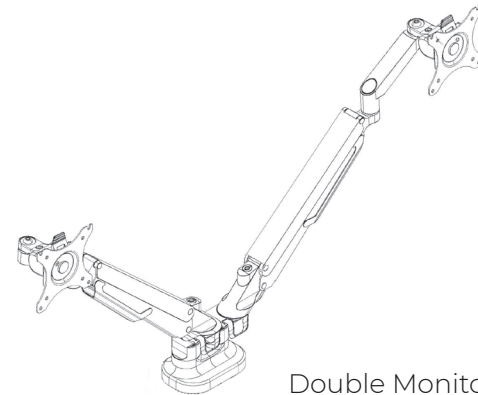

Double Monitor Arm - grommet mount

What's Included:

One monitor arm and installation hardware for both clamp and grommet mount

How to Specify:

- Specify type

Dimensions:

Vesa: 75x75 and 100x100

Notes:

- Available in silver only
- Single Monitor Arm
 - Screen Size - 17"-36"
 - Load Capacity - 6.6-26.4lbs/3-12kg
 - Tilt Range - -90 degrees - -15 degrees
- Dual Monitor Arm
 - Screen Size - 17"-32"
 - Load Capacity - 4.4-19.8lbs/2-9kg
 - Tilt Range - -90 degrees - -15 degrees

Code	Price
Monitor Arm - Single Mount	
V-AFMA-01	426
Monitor Arm - Double Mount	
V-AFMA-02	711

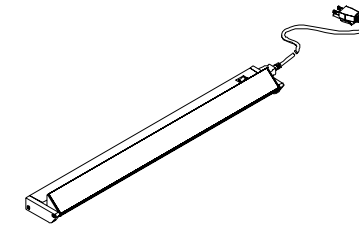

What's Included:

Task Light (1) and installation hardware.

How to Specify:

This product is available only in silver.

Notes:

- The task light can be mounted beneath an overhead cabinet or shelf to provide focused lighting within the workstation.
- The task light cord is 9-feet long from the end of the task light.
- Task lights come with built-in occupancy sensor with 30 minute delay

Options:

Width 24", 36", 48"

Code	Price	H	W	D	Volume (ft ³)	Weight (lb)
V-ELU-24	344	1.1	24	3.5	0.16	9.5
V-ELU-36	387	1.1	36	3.5	0.27	13.5
V-ELU-48	486	1.1	48	3.5	0.38	17.9