



# Halifax Pricebook

**State Of Connecticut**

Contract Number: 25PSX0057

January 2025

# Tables & Casegoods

Caution	5
Tables	6
A-Leg	7
Super Ellipse   Standing	8
Super Ellipse   Seated	10
Super Ellipse   Coffee	12
Rectangle   Standing	14
Rectangle   Seated	16
Rectangle   Coffee	18
Rectangle   Mobile	20
Video   Standing	22
Video   Seated	24
Square   Seated	26
Square   Coffee	27
Circle   Seated	28
Circle   Coffee	29
Squircle   Seated	30
Squircle   Coffee	31
Trilobe   Seated	32
Trilobe   Coffee	33
V-Leg	34
Super Ellipse   Standing	34
Super Ellipse   Seated	36
Super Ellipse   Coffee	38
Rectangle   Standing	40
Rectangle   Seated	42
Rectangle   Coffee	44
Video   Standing	46
Video   Seated	48
Square   Seated	50
Square   Coffee	51
Circle   Seated	52
Circle   Coffee	53
Squircle   Seated	54
Squircle   Coffee	55
Trilobe   Seated	56
Trilobe   Coffee	57

Desking	58
Freestanding A-Leg	60
Freestanding V-Leg	62
Freestanding Hanging Pedestal	64
Low Credenza Mount   A-Leg Hutch & Gallery Wall	66
Low Credenza Mount   A-Leg Short Gable	68
Low Credenza Mount   V-Leg Hutch & Gallery Wall	70
Low Credenza Mount   V-Leg Short Gable	72
Low Credenza Mount   No Leg Hutch & Gallery Wall	74
Low Credenza Mount   No Leg Short Gable	76
High Credenza Mount   A leg	78
High Credenza Mount   V leg	80
Height Adjustable Table	82
Height Adjustable Table Suspended Pedestal	84
Height Adjustable Table Credenza integrated	86
Height Adjustable Table Credenza & Pedestal	88
Worksurface No Grommet	90
Worksurface w/ Grommet	92
Bridge	94
Reinforcement Bar	96
Modesty	98
Worksurface Support & Hardware	100
Table Support	102
Storage	104
Pedestal   Underdesk	106
Pedestal   Underdesk w/ hinged Door	108
Pedestal   Mobile	110
Lateral   Underdesk & Freestanding Box/File	112
Lateral   Single File	114
Lateral   Freestanding File Drawers	116
Lateral   Freestanding w/ Shelf	118
Lateral   Underdesk w/ Shelf	119
Low Credenza   Hinged Doors	120
Low Credenza   Sliding Doors	122
Low Credenza Open & Lateral	124
Low Credenza   End Cap	126
High Credenza   Hinged Door	128

High Credenza   Lateral & Doors	130
High Credenza   Open & Lateral	132
High Credenza   Shelf Above Sliding Door	134
High Credenza   Open Shelf Above Lateral	136
Credenza   Raised Back	137
Credenza Open End Box w/ Top	138
Cushion	140
Gallery Wall	142
Mobile Credenza   Open & Lateral	144
Hutch   Laminate w/ Hinged doors	146
Hutch   Laminate w/ Sliding Door	148
Hutch   Metal w/ Hinged doors	150
Hutch   Metal w/ Sliding Door	152
Hutch   Wall Mounted w/ Hinged door	154
Hutch   Wall mounted w/ Sliding Door	156
Accent Shelf	158
Combo Cabinet   Open Shelf/File Drawer	160
Combo Cabinet   Lateral Storage	162
Locker Tower w/shelves	164
Locker w/ side access	166
Bookcase	168
Audio Visual Unit	170
Support	171
Audio Visual   Mounted Video Table	172
<b>Accessories</b>	<b>174</b>
PET Acoustic board	176
Power	178
Purse Hook, Shelf, Metal Storage	179
Tasklight	180
Monitor Arm	181
Keyboard Tray	182

Caution

**Load Bottom Drawer First**

- Operate one drawer at a time
- Units may tip if loaded incorrectly
- Units should be attached to a wall or other furniture to reduce tipping hazard
- Always load the heaviest files in the bottom drawer

**Heavy Load**

- Some products must be anchored to wall to ensure stability & safety.
- It is the owner and installers responsibility to ensure that the wall type and construction is of sufficient strength to carry the loads of any wall mounted products and their contents.
- Failure of the wall and anchors to support all imposed loads may result in property damage and/or personal injury.
- Tayco can provide size and empty weight of its products only. As wall blocking is considered a building construction process, Tayco cannot provide recommendations in this respect and cannot be responsible for damage or injury that may occur as a result of improper installation and/or blocking.

**Instability Hazard**

Mobile items on casters such as flip top, personal and movable tables of any type and storage items of any type may present an instability hazard if not secured correctly while in use or in storage. Flip top tables or training tables of any type, are inherently more unstable when folded. Tayco provides the following guidelines & warnings when using mobile products:

- Lock casters immediately after moving. Do not leave the casters unlocked when in use or in storage.
- Motion may increase the instability of any item with casters. If the wheels hit an obstruction the table's forward momentum often causes overturn, especially if the item is not equipped with wheel extensions. Exercise strong caution while moving these items.
- Use caution when abrupt level changes in the floor are present (such as a doorway or room threshold) as caster failure or tipping may result.
- Do not stand, sit or lean on mobile items for support. They are not intended for this use and personal injury or property damage may result.
- Mobile units that feature height adjustable elements must be lowered to the minimum compressed height when moving to prevent instability. It is also recommended the user remove all computer equipment or other accessories to prevent possible weight imbalance or damage to equipment.
- Failure to follow the guidelines above may result in property damage or personal injury.



# Halifax Pricebook January 2026 Tables

## Tables

### A-Leg

Super Ellipse   Standing	8
Super Ellipse   Seated	10
Super Ellipse   Coffee	12
Rectangle   Standing	14
Rectangle   Seated	16
Rectangle   Coffee	18
Rectangle   Mobile	20
Video   Standing	22
Video   Seated	24
Square   Seated	26
Square   Coffee	27
Circle   Seated	28
Circle   Coffee	29
Squircle   Seated	30
Squircle   Coffee	31
Trilobe   Seated	32
Trilobe   Coffee	33

### V-Leg

Super Ellipse   Standing	34
Super Ellipse   Seated	36
Super Ellipse   Coffee	38
Rectangle   Standing	40
Rectangle   Seated	42
Rectangle   Coffee	44
Video   Standing	46
Video   Seated	48
Square   Seated	50
Square   Coffee	51
Circle   Seated	52
Circle   Coffee	53
Squircle   Seated	54
Squircle   Coffee	55
Trilobe   Seated	56
Trilobe   Coffee	57

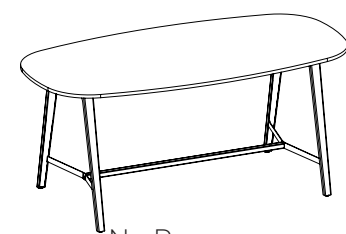

No Power



With Power

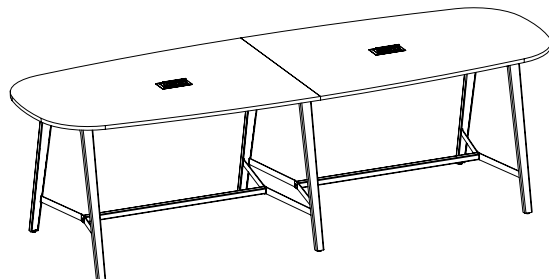
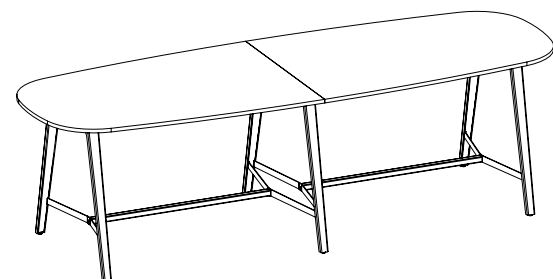

**What's Included:**

- 1" thick super ellipse top
- Sizes: 60"-96: 1-piece top, 4 A-legs with removable infill
- Sizes: 108"-144: 2-piece top, 6 A-legs with removable infill
- Reinforcement bar(s)
- Leg support structure
- Optional Electrics

In-surface powered option comes with one grommet per table piece with 2 AC outlets, dual USB-A chargers, and a blank slot to add an optional HDMI, RJ11, or RJ45 (see [page 180](#) for more options)

**How to Specify:**

Table is sold with base

Each laminate comes with matching vinyl trim unless otherwise specified on the order cover sheet

Infill can match the paint finish of the A-leg or can be specified in a different finish

**Options:**

Widths: 72", 84", 96", 108", 120", 132", 144"

Depths: 30", 36", 42", 48"

Worksurface Laminate

A-Leg paint

A-Leg infill paint

Electrics

**Notes:**

Table corners have 4" radius

Table legs come with adjustable glides up to 1/2"

A-leg has removable infill for wire management capabilities

One of the A-Legs will come with an infill with a small hole to run wires out the bottom

Reinforcement bars have wire management capabilities

**Optional Electrics**

In-surface power+USB module available, offered in silver finish

Optional side-mount USB module, offered in black finish

**No Power**

Code	Price	H	W	D	Vol.	Wt.
H-MEAN-427236	2829	42	72	36	7	104
H-MEAN-427242	3519	42	72	42	8	121
H-MEAN-427248	3730	42	72	48	10	138
H-MEAN-428436	2924	42	84	36	8	121
H-MEAN-428442	3625	42	84	42	10	141
H-MEAN-428448	3846	42	84	48	11	161
H-MEAN-429636	3092	42	96	36	10	138
H-MEAN-429642	3798	42	96	42	11	161
H-MEAN-429648	4026	42	96	48	13	184
H-MEAN-4210836	3710	42	108	36	11	156
H-MEAN-4210842	5887	42	108	42	13	181
H-MEAN-4210848	6132	42	108	48	14	207
H-MEAN-4212036	3895	42	120	36	12	173
H-MEAN-4212042	6103	42	120	42	14	202
H-MEAN-4212048	6350	42	120	48	16	230
H-MEAN-4213236	3985	42	132	36	13	190
H-MEAN-4213242	6225	42	132	42	15	222
H-MEAN-4213248	6471	42	132	48	18	253
H-MEAN-4214436	4077	42	144	36	14	207
H-MEAN-4214442	6400	42	144	42	17	242
H-MEAN-4214448	6627	42	144	48	19	276

**Power**

Code	Price	H	W	D	Vol.	Wt.
H-MEAP-427242	4687	42	72	42	8	121
H-MEAP-427248	4898	42	72	48	10	138
H-MEAP-428442	4792	42	84	42	10	141
H-MEAP-428448	5012	42	84	48	11	161
H-MEAP-429642	4965	42	96	42	11	161
H-MEAP-429648	5195	42	96	48	13	184
H-MEAP-4210842	8914	42	108	42	13	181
H-MEAP-4210848	9161	42	108	48	14	207
H-MEAP-4212042	9129	42	120	42	14	202
H-MEAP-4212048	9375	42	120	48	16	230
H-MEAP-4213242	9251	42	132	42	15	222
H-MEAP-4213248	9497	42	132	48	18	253
H-MEAP-4214442	9425	42	144	42	17	242
H-MEAP-4214448	9655	42	144	48	19	276

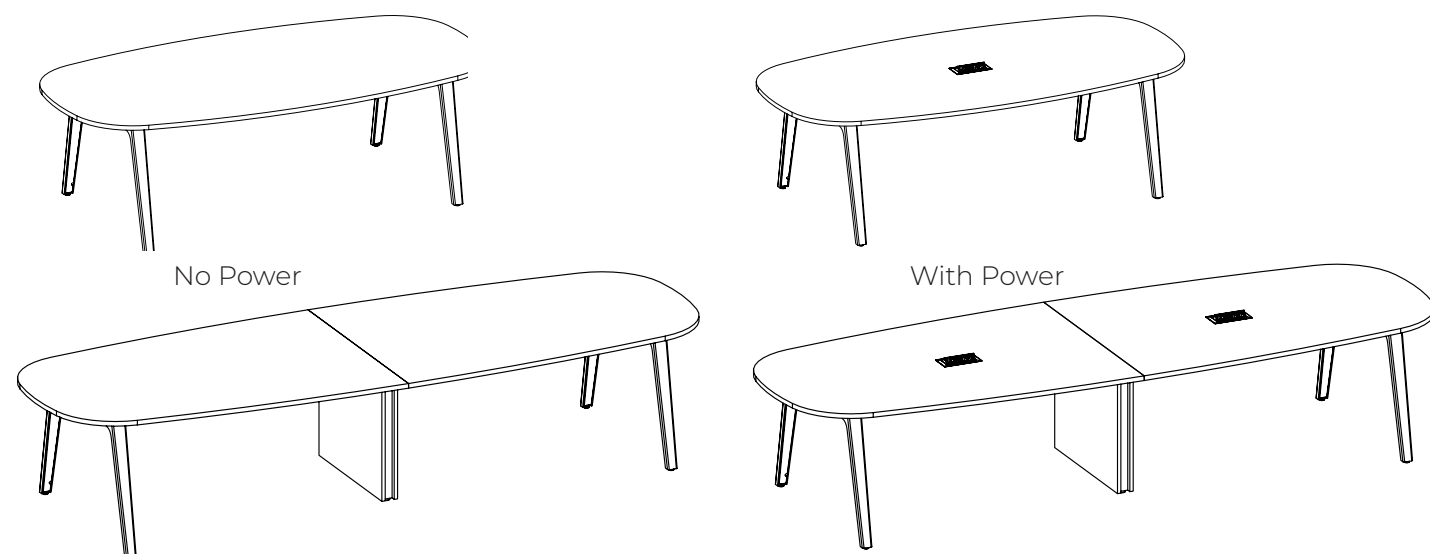

**What's Included:**

- 1" thick super ellipse top
- Sizes: 60"-96: 1-piece top, 4 A-legs with removable infill
- Sizes: 108"-144: 2-piece top, 4 A-legs with removable infill and mid plinth
- Reinforcement bar(s)
- Optional Electrics
  - In-surface powered option comes with one grommet per table piece with 2 AC outlets, dual USB-A chargers, and a blank slot to add an optional HDMI, RJ11, or RJ45 (see [page 178](#) for more options)

**How to Specify:**

Table is sold with base

Each laminate comes with matching vinyl trim unless otherwise specified on the order cover sheet

Infill can match the paint finish of the A-leg or can be specified in a different finish

**Options:**

Widths:

Depths:

Worksurface Laminate

A-Leg paint

A-Leg infill paint

Electrics

**Notes:**

- Table corners have 4" radius
- Table legs come with adjustable glides up to 1/2"
- A-leg has removable infill for wire management capabilities
- One of the A-Legs will come with an infill with a small hole to run wires out the bottom
- Reinforcement bars have wire management capabilities
- Optional Electrics
  - In-surface power+USB module available, offered in silver finish
  - Optional side-mount USB module, offered in black finish

**No Power**

Code	Price	H	W	D	Vol.	Wt.
H-MEAN-297236	2579	29	72	36	5.22	75.17
H-MEAN-297242	2654	29	72	42	6.09	87.7
H-MEAN-297248	2869	29	72	48	6.96	100.22
H-MEAN-298436	2673	29	84	36	6.09	87.7
H-MEAN-298442	2757	29	84	42	7.11	102.31
H-MEAN-298448	2980	29	84	48	8.12	116.93
H-MEAN-299636	2830	29	96	36	6.96	100.22
H-MEAN-299642	2921	29	96	42	8.12	116.93
H-MEAN-299648	3156	29	96	48	9.28	133.63
H-MEAN-2910836	4237	29	108	36	7.83	112.75
H-MEAN-2910842	4643	29	108	42	9.14	131.54
H-MEAN-2910848	4808	29	108	48	10.44	150.34
H-MEAN-2912036	4412	29	120	36	10.44	150.34
H-MEAN-2912042	4851	29	120	42	10.15	146.16
H-MEAN-2912048	5014	29	120	48	11.6	167.04
H-MEAN-2913236	4465	29	132	36	9.57	137.81
H-MEAN-2913242	4932	29	132	42	11.17	160.78
H-MEAN-2913248	5098	29	132	48	12.76	183.74
H-MEAN-2914436	4604	29	144	36	10.44	150.34
H-MEAN-2914442	5099	29	144	42	12.18	175.39
H-MEAN-2914448	5269	29	144	48	12.18	175.39

**Power**

Code	Price	H	W	D	Vol.	Wt.
H-MEAP-297236	3745	29	72	36	5.22	75.17
H-MEAP-297242	3823	29	72	42	6.09	87.7
H-MEAP-297248	4036	29	72	48	6.96	100.22
H-MEAP-298436	3839	29	84	36	6.09	87.7
H-MEAP-298442	3925	29	84	42	7.11	102.31
H-MEAP-298448	4146	29	84	48	8.12	116.93
H-MEAP-299636	3998	29	96	36	6.96	100.22
H-MEAP-299642	4089	29	96	42	8.12	116.93
H-MEAP-299648	4320	29	96	48	9.28	133.63
H-MEAP-2910836	7264	29	108	36	7.83	112.75
H-MEAP-2910842	7668	29	108	42	9.14	131.54
H-MEAP-2910848	7835	29	108	48	10.44	150.34
H-MEAP-2912036	7439	29	120	36	8.7	125.28
H-MEAP-2912042	7874	29	120	42	10.15	146.16
H-MEAP-2912048	8044	29	120	48	11.6	167.04
H-MEAP-2913236	7492	29	132	36	9.57	137.81
H-MEAP-2913242	7959	29	132	42	11.17	160.78
H-MEAP-2913248	8126	29	132	48	12.76	183.74
H-MEAP-2914436	7627	29	144	36	10.44	150.34
H-MEAP-2914442	8127	29	144	42	12.18	175.39
H-MEAP-2914448	8295	29	144	48	13.92	200.45

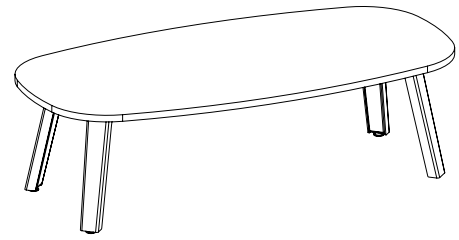

Coffee Table

**What's Included:**

- 3/4" thick super ellipse top
- 4 A-legs with infill

**How to Specify:**

Table is sold with base

Each laminate comes with matching vinyl trim unless otherwise specified on the order cover sheet

Infill can match the paint finish of the A-leg or can be specified in a different finish

**Notes:**

Table corners have 4" radius

Table legs come with adjustable glides up to 1/2"

A-leg has removable infill for wire management capabilities

One of the A-Legs will come with an infill with a small hole to run wires out the bottom

**Options:**

24"D: Widths: 36", 42", 48", 54", 60"

30"D: Widths: 48", 54", 60"

36"D: Widths: 60"

Height: 14"

Worksurface Laminate

A-Leg paint finish

A-Leg infill paint finish

Code	Price	H	W	D	Volume	Weight
H-TEAN-143624	1382	14	36	24	1	12
H-TEAN-144224	1397	14	42	24	1	14
H-TEAN-144824	1417	14	48	24	1	16
H-TEAN-144830	1449	14	48	30	1	20
H-TEAN-145424	1436	14	54	24	1	18
H-TEAN-145430	1472	14	54	30	2	23
H-TEAN-146024	1451	14	60	24	1	20
H-TEAN-146030	1492	14	60	30	2	25
H-TEAN-146036	1536	14	60	36	2	30



No Power

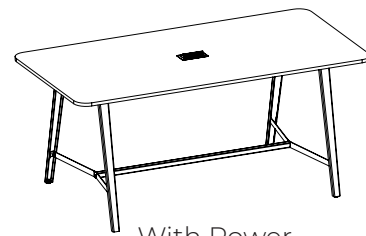

With Power

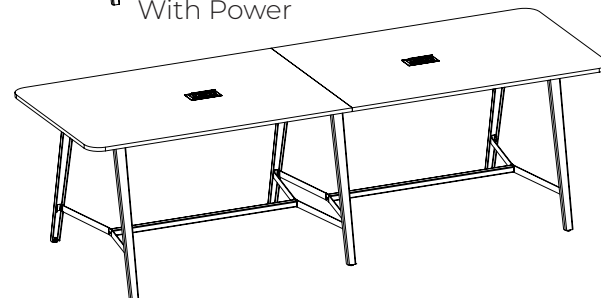
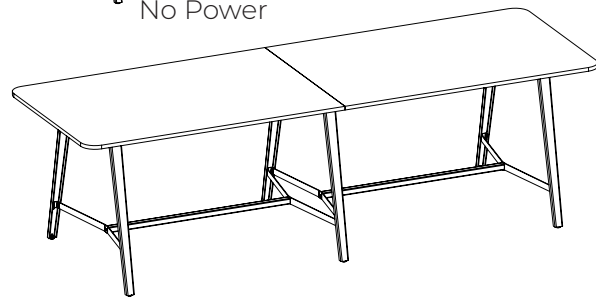

**What's Included:**

- 1" thick rectangular top
- Sizes: 60"-96: 1-piece top, 4 A-legs with removable infill
- Sizes: 108"-144: 2-piece top, 6 A-legs with removable infill
- Reinforcement bar(s)
- Optional Electrics

In-surface powered option comes with one grommet per table piece with 2 AC outlets, dual USB-A chargers, and a blank slot to add an optional HDMI, RJ11, or RJ45 (see [page 178](#) for more options)

**How to Specify:**

Table is sold with base

Each laminate comes with matching vinyl trim unless otherwise specified on the order cover sheet

Infill can match the paint finish of the A-leg or can be specified in a different finish

**Options:**

Widths: 60", 72", 84", 96", 108", 120", 132", 144"

Depths: 36", 42", 48"

Height: 42"

Worksurface Laminate

A-Leg & leg support structure paint finish

A-Leg infill paint finish

Electrics

**Notes:**

Table corners have 4" radius

Table legs come with adjustable glides up to 1/2"

A-leg has removable infill for wire management capabilities

One of the A-Legs will come with an infill with a small hole to run wires out the bottom

Reinforcement bars have wire management capabilities

Optional Electrics

In-surface power+USB module available, offered in silver finish

Optional side-mount USB module, offered in black finish

**No Power**

Code	Price	H	W	D	Vol.	Wt.
H-MRAN-426036	3123	42	60	36	6	86
H-MRAN-426042	3476	42	60	42	7	101
H-MRAN-426048	3576	42	60	48	8	115
H-MRAN-427236	3407	42	72	36	7	104
H-MRAN-427242	3617	42	72	42	8	121
H-MRAN-427248	3728	42	72	48	10	138
H-MRAN-428436	3504	42	84	36	8	121
H-MRAN-428442	3726	42	84	42	10	141
H-MRAN-428448	3842	42	84	48	11	161
H-MRAN-429636	3668	42	96	36	10	138
H-MRAN-429642	3899	42	96	42	11	161
H-MRAN-429648	4022	42	96	48	13	184
H-MRAN-4210836	5461	42	108	36	11	156
H-MRAN-4210842	6005	42	108	42	13	181
H-MRAN-4210848	6117	42	108	48	14	207
H-MRAN-4212036	5642	42	120	36	12	173
H-MRAN-4212042	6218	42	120	42	14	202
H-MRAN-4212048	6332	42	120	48	16	230
H-MRAN-4213236	5738	42	132	36	13	190
H-MRAN-4213242	6344	42	132	42	15	222
H-MRAN-4213248	6454	42	132	48	18	253
H-MRAN-4214436	5881	42	144	36	14	207
H-MRAN-4214442	6519	42	144	42	17	242
H-MRAN-4214448	6632	42	144	48	19	276

**Power**

Code	Price	H	W	D	Vol.	Wt.
H-MRAP-426036	4292	42	60	36	6	86
H-MRAP-426042	4643	42	60	42	7	101
H-MRAP-426048	4743	42	60	48	8	115
H-MRAP-427236	4571	42	72	36	7	104
H-MRAP-427242	4786	42	72	42	8	121
H-MRAP-427248	4894	42	72	48	10	138
H-MRAP-428436	4672	42	84	36	8	121
H-MRAP-428442	4891	42	84	42	10	141
H-MRAP-428448	5010	42	84	48	11	161
H-MRAP-429636	4835	42	96	36	10	138
H-MRAP-429642	5064	42	96	42	11	161
H-MRAP-429648	5192	42	96	48	13	184
H-MRAP-4210836	8488	42	108	36	11	156
H-MRAP-4210842	9032	42	108	42	13	181
H-MRAP-4210848	9144	42	108	48	14	207
H-MRAP-4212036	8673	42	120	36	12	173
H-MRAP-4212042	9248	42	120	42	14	202
H-MRAP-4212048	9359	42	120	48	16	230
H-MRAP-4213236	8761	42	132	48	13	190
H-MRAP-4213242	9366	42	132	42	15	222
H-MRAP-4213248	9481	42	132	48	18	253
H-MRAP-4214436	8909	42	144	36	14	207
H-MRAP-4214442	9544	42	144	42	17	242
H-MRAP-4214448	9657	42	144	48	19	276

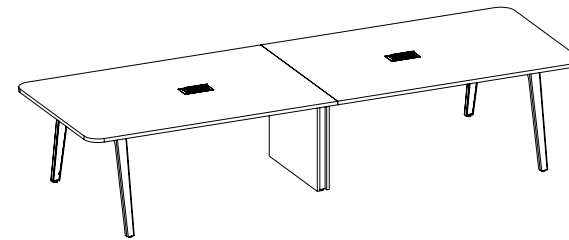
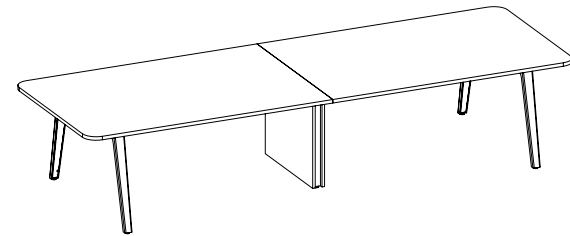

**What's Included:**

- 1" thick rectangular top
- Sizes: 60"-96: 1-piece top, 4 A-legs with removable infill
- Sizes: 108"-144: 2-piece top, 4 A-legs with removable infill and mid plinth
- Reinforcement bar(s)
- Optional Electrics

In-surface powered option comes with one grommet per table piece with 2 AC outlets, dual USB-A chargers, and a blank slot to add an optional HDMI, RJ11, or RJ45 (see [page 178](#) for more options)

**How to Specify:**

Table is sold with base

Each laminate comes with matching vinyl trim unless otherwise specified on the order cover sheet

Infill can match the paint finish of the A-leg or can be specified in a different finish

**Options:**

Widths: 60", 72", 84", 96", 108", 120", 132", 144"

Depths: 30", 36", 42", 48"

Worksurface Laminate

A-Leg paint

A-Leg infill paint

Electrics

**Notes:**

Table corners have 4" radius

Table legs come with adjustable glides up to 1/2"

A-leg has removable infill for wire management capabilities

One of the A-Legs will come with an infill with a small hole to run wires out the bottom

Reinforcement bars have wire management capabilities

Optional Electrics

In-surface power+USB module available, offered in silver finish

Optional side-mount USB module, offered in black finish

**No Power**

Code	Price	H	W	D	Vol.	Wt.
H-MRAN-296030	2422	29	60	30	4	52
H-MRAN-296036	2494	29	60	36	4	63
H-MRAN-296042	2699	29	60	42	5	73
H-MRAN-296048	2758	29	60	48	6	84
H-MRAN-297230	2528	29	72	30	4	63
H-MRAN-297236	2603	29	72	36	5	75
H-MRAN-297242	2732	29	72	42	6	88
H-MRAN-297248	2885	29	72	48	6	88
H-MRAN-298430	2615	29	84	30	5	73
H-MRAN-298436	2699	29	84	36	6	88
H-MRAN-298442	2922	29	84	42	7	102
H-MRAN-298448	2996	29	84	48	8	117
H-MRAN-299630	2763	29	96	30	6	84
H-MRAN-299636	2855	29	96	36	7	100
H-MRAN-299642	3086	29	96	42	8	117
H-MRAN-299648	3170	29	96	48	9	134
H-MRAN-2910830	4165	29	108	30	7	94
H-MRAN-2910836	4263	29	108	36	8	113
H-MRAN-2910842	4808	29	108	42	9	132
H-MRAN-2910848	4827	29	108	48	10	150
H-MRAN-2912030	4328	29	120	30	7	104
H-MRAN-2912036	4441	29	120	36	9	125
H-MRAN-2912042	5014	29	120	42	10	146
H-MRAN-2912048	5034	29	120	48	12	167
H-MRAN-2913230	4373	29	132	30	8	115
H-MRAN-2913236	4490	29	132	36	10	138
H-MRAN-2913242	5098	29	132	42	11	161
H-MRAN-2913248	5115	29	132	48	13	184
H-MRAN-2914430	4504	29	144	30	9	125
H-MRAN-2914436	4630	29	144	36	10	150
H-MRAN-2914442	5269	29	144	42	12	175
H-MRAN-2914448	5285	29	144	48	14	200

**Power**

Code	Price	H	W	D	Vol.	Wt.
H-MRAP-296030	3589	29	60	30	4	52
H-MRAP-296036	3657	29	60	36	4	63
H-MRAP-296042	3868	29	60	42	5	73
H-MRAP-296048	3926	29	60	48	6	84
H-MRAP-297230	3696	29	72	30	4	63
H-MRAP-297236	3770	29	72	36	5	75
H-MRAP-297242	3899	29	72	42	6	88
H-MRAP-297248	4054	29	72	48	7	100
H-MRAP-298430	3782	29	84	30	5	73
H-MRAP-298436	3868	29	84	36	6	88
H-MRAP-298442	4090	29	84	42	7	102
H-MRAP-298448	4166	29	84	48	8	117
H-MRAP-299630	3931	29	96	30	6	84
H-MRAP-299636	4022	29	96	36	7	100
H-MRAP-299642	4253	29	96	42	8	117
H-MRAP-299648	4338	29	96	48	9	134
H-MRAP-2910830	7189	29	108	30	7	94
H-MRAP-2910836	7292	29	108	36	8	113
H-MRAP-2910842	7835	29	108	42	9	132
H-MRAP-2910848	7853	29	108	48	10	150
H-MRAP-2912030	7359	29	120	30	7	104
H-MRAP-2912036	7467	29	120	36	9	125
H-MRAP-2912042	8044	29	120	42	10	146
H-MRAP-2912048	8059	29	120	48	12	167
H-MRAP-2913230	7405	29	132	30	8	115
H-MRAP-2913236	7519	29	132	36	10	138
H-MRAP-2913242	8126	29	132	42	11	161
H-MRAP-2913248	8143	29	132	48	11	184
H-MRAP-2914430	7533	29	144	30	9	125
H-MRAP-2914436	7654	29	144	36	10	150
H-MRAP-2914442	8295	29	144	42	12	175
H-MRAP-2914448	8312	29	144	48	14	200

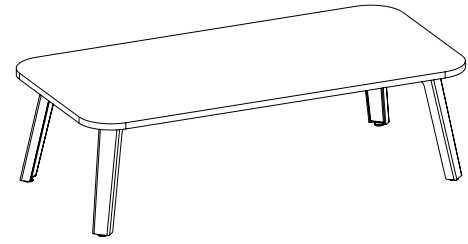

Coffee Table

**What's Included:**

- 3/4" thick rectangular top
- 4 A-legs with infill

**How to Specify:**

Table is sold with base

Each laminate comes with matching vinyl trim unless otherwise specified on the order cover sheet

Infill can match the paint finish of the A-leg or can be specified in a different finish

**Notes:**

Table corners have 4" radius

Table legs come with adjustable glides up to 1/2"

A-leg has removable infill for wire management capabilities

One of the A-Legs will come with an infill with a small hole to run wires out the bottom

**Options:**

24"D: Widths: 36", 42", 48", 54", 60"

30"D: Widths: 48", 54", 60"

36"D: Widths: 60"

Height: 14"

Worksurface Laminate

A-Leg paint finish

A-Leg infill paint finish

Code	Price	H	W	D	Volume	Weight
H-TRAN-143624	1352	14	36	24	1	12
H-TRAN-144224	1369	14	42	24	1	14
H-TRAN-144824	1384	14	48	24	1	16
H-TRAN-144830	1417	14	48	30	1	20
H-TRAN-145424	1402	14	54	24	1	18
H-TRAN-145430	1442	14	54	30	2	23
H-TRAN-146024	1419	14	60	24	1	20
H-TRAN-146030	1462	14	60	30	2	25
H-TRAN-146036	1501	14	60	36	2	30

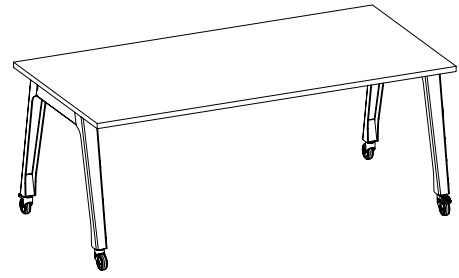

Mobile Table

**What's Included:**

- 1" thick rectangular top
- 4 A-legs with caster cover
- 4 casters

**How to Specify:**

Table is sold with base and casters

**Notes:**

Table corners have 4" radius  
 One of the A-Legs will come with an infill with a small hole to run wires out the bottom

**Options:**

- 24"D: Widths: 36", 42", 48", 54", 60", 72"
- 30"D: Widths: 48", 54", 60", 72"
- 36"D: Widths: 60", 72"
- Height: 29"
- Worksurface Laminate
- A-Leg paint finish
- A-Leg caster cover paint

Code	Price	H	W	D	Volume	Weight
H-ZRAN-293624	1603	29	36	24	2	25
H-ZRAN-294224	1619	29	42	24	2	29
H-ZRAN-294824	2149	29	48	24	2	33
H-ZRAN-295424	2181	29	54	24	3	38
H-ZRAN-296024	2226	29	60	24	3	42
H-ZRAN-297224	2299	29	72	24	3	50
H-ZRAN-294830	2512	29	48	30	3	42
H-ZRAN-295430	2571	29	54	30	3	47
H-ZRAN-296030	2641	29	60	30	4	52
H-ZRAN-297230	2763	29	72	30	4	63
H-ZRAN-296036	2742	29	60	36	4	63
H-ZRAN-297236	2872	29	72	36	5	75

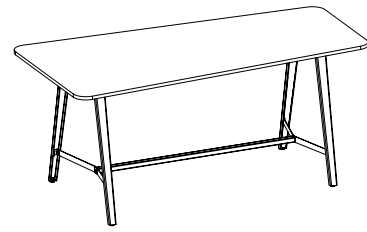

No Power



With Power

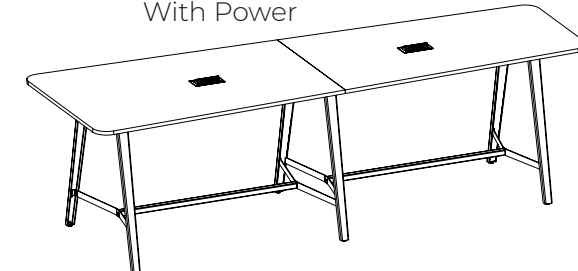
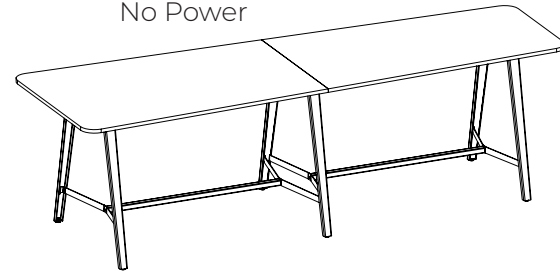

**What's Included:**

- 1" thick video top
- Sizes: 60"-96": 1-piece top, 4 A-legs with removable infill
- Sizes: 108"-144": 2-piece top, 6 A-legs with removable infill
- Reinforcement bar(s)
- Optional Electrics
  - In-surface powered option comes with one grommet per table piece with 2 AC outlets, dual USB-A chargers, and a blank slot to add an optional HDMI, RJ11, or RJ45 (see [page 178](#) for more options)

**How to Specify:**

Table is sold with base

Each laminate comes with matching vinyl trim unless otherwise specified on the order cover sheet

Infill can match the paint finish of the A-leg or can be specified in a different finish

**Notes:**

- Table corners have 4" radius
- Table legs come with adjustable glides up to 1/2"
- A-leg has removable infill for wire management capabilities
- One of the A-Legs will come with an infill with a small hole to run wires out the bottom
- Reinforcement bars have wire management capabilities
- Optional Electrics
  - In-surface power+USB module available, offered in silver finish
  - Optional side-mount USB module, offered in black finish

**Options:**

Widths: 72", 84", 96", 108", 120", 132", 144"

Depths: 48"

Worksurface Laminate

A-Leg paint

A-Leg infill paint

Electrics

**No Power**

Code	Price	H	W	D	Vol.	Wt.
H-MVAN-427248	3649	42	72	48	10	138
H-MVAN-428448	3763	42	84	48	11	161
H-MVAN-429648	3944	42	96	48	13	184
H-MVAN-4210848	6053	42	108	48	14	207
H-MVAN-4212048	6266	42	120	48	16	230
H-MVAN-4213248	6387	42	132	48	18	253
H-MVAN-4214448	6564	42	144	48	19	276

**Power**

Code	Price	H	W	D	Vol.	Wt.
H-MVAP-427248	4817	42	72	48	10	138
H-MVAP-428448	4931	42	84	48	11	161
H-MVAP-429648	5111	42	96	48	13	184
H-MVAP-4210848	9081	42	108	48	14	207
H-MVAP-4212048	9293	42	120	48	16	230
H-MVAP-4213248	9417	42	132	48	18	253
H-MVAP-4214448	9593	42	144	48	19	276

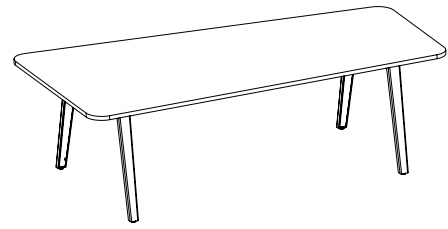

No Power

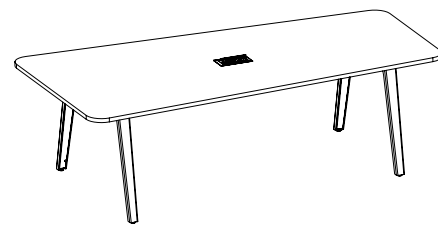

With Power

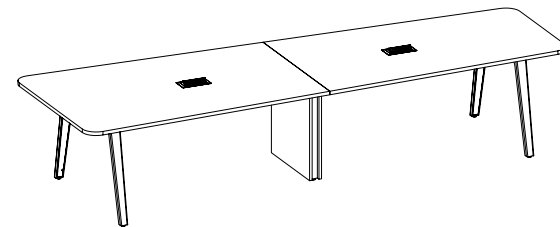
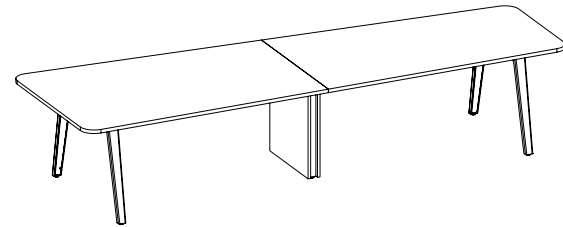

**What's Included:**

- 1" thick video top
- Sizes: 60"-96: 1-piece top, 4 A-legs with removable infill
- Sizes: 108"-144: 2-piece top, 4 A-legs with removable infill and mid plinth
- Reinforcement bar(s)
- Optional Electrics

In-surface powered option comes with one grommet per table piece with 2 AC outlets, dual USB-A chargers, and a blank slot to add an optional HDMI, RJ11, or RJ45 (see [page 178](#) for more options)

**How to Specify:**

Table is sold with base

Each laminate comes with matching vinyl trim unless otherwise specified on the order cover sheet

Infill can match the paint finish of the A-leg or can be specified in a different finish

**Options:**

Widths: 72", 84", 96", 108", 120", 132", 144"

Depths: 42", 48"

Worksurface Laminate

A-Leg paint

A-Leg infill paint

Electrics

**Notes:**

Table corners have 4" radius

Table legs come with adjustable glides up to 1/2"

A-leg has removable infill for wire management capabilities

One of the A-Legs will come with an infill with a small hole to run wires out the bottom

Reinforcement bars have wire management capabilities

Optional Electrics

In-surface power+USB module available, offered in silver finish

Optional side-mount USB module, offered in black finish

**No Power**

Code	Price	H	W	D	Vol.	Wt.
H-MVAN-297242	2674	29	72	42	6	88
H-MVAN-297248	2818	29	72	48	7	100
H-MVAN-298442	2775	29	84	42	7	102
H-MVAN-298448	2927	29	84	48	8	117
H-MVAN-299642	2939	29	96	42	8	117
H-MVAN-299648	3099	29	96	48	9	134
H-MVAN-2910842	4485	29	108	42	9	132
H-MVAN-2910848	4622	29	108	48	10	150
H-MVAN-2912042	4689	29	120	42	10	146
H-MVAN-2912048	4830	29	120	48	12	167
H-MVAN-2913242	4776	29	132	42	11	161
H-MVAN-2913248	4910	29	132	48	13	184
H-MVAN-2914442	4945	29	144	42	12	175
H-MVAN-2914448	5080	29	144	48	14	200

**Power**

Code	Price	H	W	D	Vol.	Wt.
H-MVAP-297242	3841	29	72	42	6	88
H-MVAP-297248	3985	29	72	48	7	100
H-MVAP-298442	3943	29	84	42	7	102
H-MVAP-298448	4094	29	84	48	8	117
H-MVAP-299642	4107	29	96	42	8	117
H-MVAP-299648	4267	29	96	48	9	134
H-MVAP-2910842	7509	29	108	42	9	132
H-MVAP-2910848	7649	29	108	48	10	150
H-MVAP-2912042	7719	29	120	42	10	146
H-MVAP-2912048	7853	29	120	48	12	167
H-MVAP-2913242	7800	29	132	42	11	161
H-MVAP-2913248	7942	29	132	48	13	184
H-MVAP-2914442	7970	29	144	42	12	175
H-MVAP-2914448	8105	29	144	48	14	200

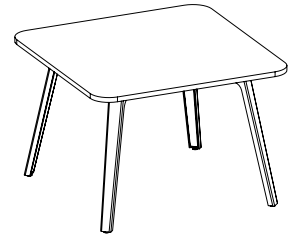

**What's Included:**

- 1" thick square top
- 4 A-legs with removable infill

**How to Specify:**

Table is sold with base

Each laminate comes with matching vinyl trim unless otherwise specified on the order cover sheet

Infill can match the paint finish of the A-leg or can be specified in a different finish

**Notes:**

Table corners have 4" radius

Table legs come with adjustable glides up to 1/2"

A-leg has removable infill for wire management capabilities

One of the A-Legs will come with an infill with a small hole to run wires out the bottom

**Options:**

Widths: 36", 42", 48"

Depths: 36", 42", 48"

Worksurface Laminate

A-Leg paint

A-Leg infill paint

Electrics

Code	Price	H	W	D	Volume	Weight
H-MSAN-293636	2527	29	36	36	3	38
H-MSAN-294242	2552	29	42	42	4	51
H-MSAN-294848	2572	29	48	48	5	67

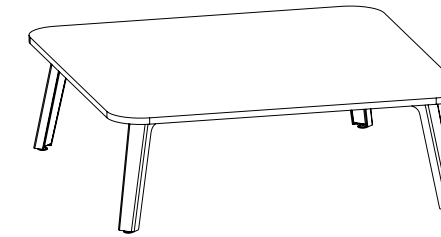

Coffee Table

**What's Included:**

- 3/4" thick square top
- 4 A-legs with infill

**How to Specify:**

Table is sold with base

Each laminate comes with matching vinyl trim unless otherwise specified on the order cover sheet

Infill can match the paint finish of the A-leg or can be specified in a different finish

**Notes:**

Table corners have 4" radius

Table legs come with adjustable glides up to 1/2"

A-leg has removable infill for wire management capabilities

**Options:**

Depths: 30", 36", 42", 48"

Height: 14"

Worksurface Laminate

A-Leg paint finish

A-Leg infill paint finish

Code	Price	H	W	D	Volume	Weight
H-TSAN-143030	1355	14	30	30	1	13
H-TSAN-143636	1400	14	36	36	1	18
H-TSAN-144242	1545	14	42	42	2	25
H-TSAN-144848	1584	14	48	48	2	32



**What's Included:**

- 1" circle top
- 3 A-legs with removable infill

**How to Specify:**

Table is sold with base

Each laminate comes with matching vinyl trim unless otherwise specified on the order cover sheet

Infill can match the paint finish of the A-leg or can be specified in a different finish

**Notes:**

Table corners have 4" radius

Table legs come with adjustable glides up to 1/2"

A-leg has removable infill for wire management capabilities

One of the A-Legs will come with an infill with a small hole to run wires out the bottom

**Options:**

Widths: 36", 42", 48"

Depths: 36", 42", 48"

Worksurface Laminate

A-Leg paint

A-Leg infill paint

Electrics

Code	Price	H	W	D	Volume	Weight
H-MOAN-293636	1846	29	36	36	3	38
H-MOAN-294242	2115	29	42	42	4	51
H-MOAN-294848	2132	29	48	48	5	67

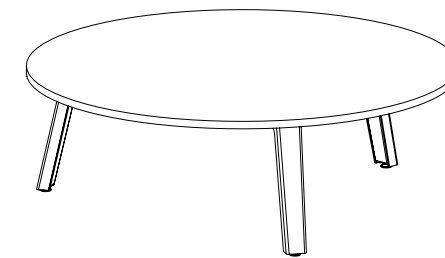

Coffee Table

**What's Included:**

- 3/4" thick circle top
- 3 A-legs with infill

**How to Specify:**

Table is sold with base

Each laminate comes with matching vinyl trim unless otherwise specified on the order cover sheet

Infill can match the paint finish of the A-leg or can be specified in a different finish

**Notes:**

Table corners have 4" radius

Table legs come with adjustable glides up to 1/2"

A-leg has removable infill for wire management capabilities

**Options:**

Depths: 30", 36", 42", 48"

Height: 14"

Worksurface Laminate

A-Leg paint finish

A-Leg infill paint finish

Code	Price	H	W	D	Volume	Weight
H-TOAN-143030	1104	14	30	30	1	13
H-TOAN-143636	1251	14	36	36	1	18
H-TOAN-144242	1295	14	42	42	2	25
H-TOAN-144848	1332	14	48	48	2	32



**What's Included:**

- 1" squircle top
- 4 A-legs with removable infill

**How to Specify:**

Table is sold with base

Each laminate comes with matching vinyl trim unless otherwise specified on the order cover sheet

Infill can match the paint finish of the A-leg or can be specified in a different finish

**Notes:**

Table corners have 4" radius

Table legs come with adjustable glides up to 1/2"

A-leg has removable infill for wire management capabilities

One of the A-Legs will come with an infill with a small hole to run wires out the bottom

**Options:**

Widths: 36", 42", 48"

Depths: 36", 42", 48"

Worksurface Laminate

A-Leg paint

A-Leg infill paint

Electrics

Code	Price	H	W	D	Volume	Weight
H-MQAN-293636	2350	29	36	36	3	38
H-MQAN-294242	2616	29	42	42	4	51
H-MQAN-294848	2632	29	48	48	5	67

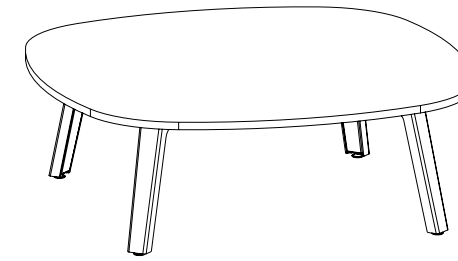

Coffee Table

**What's Included:**

- 3/4" thick squircle top
- 4 A-legs with infill

**How to Specify:**

Table is sold with base

Each laminate comes with matching vinyl trim unless otherwise specified on the order cover sheet

Infill can match the paint finish of the A-leg or can be specified in a different finish

**Notes:**

Table corners have 4" radius

Table legs come with adjustable glides up to 1/2"

A-leg has removable infill for wire management capabilities

**Options:**

Depths: 30", 36", 42", 48"

Height: 14"

Worksurface Laminate

A-Leg paint finish

A-Leg infill paint finish

Code	Price	H	W	D	Volume	Weight
H-TQAN-143030	1384	14	30	30	1	13
H-TQAN-143636	1536	14	36	36	1	18
H-TQAN-144242	1575	14	42	42	2	25
H-TQAN-144848	1616	14	48	48	2	32



**What's Included:**

- 1" trilobe top
- 3 A-legs with removable infill

**How to Specify:**

Table is sold with base

Each laminate comes with matching vinyl trim unless otherwise specified on the order cover sheet

Infill can match the paint finish of the A-leg or can be specified in a different finish

**Notes:**

Table corners have 4" radius

Table legs come with adjustable glides up to 1/2"

A-leg has removable infill for wire management capabilities

One of the A-Legs will come with an infill with a small hole to run wires out the bottom

**Options:**

Widths: 36", 42", 48"

Depths: 36", 42", 48"

Worksurface Laminate

A-Leg paint

A-Leg infill paint

Electrics

Code	Price	H	W	D	Volume	Weight
H-MTAN-293636	1846	29	36	36	3	38
H-MTAN-294242	2115	29	42	42	4	51
H-MTAN-294848	2132	29	48	48	4	51

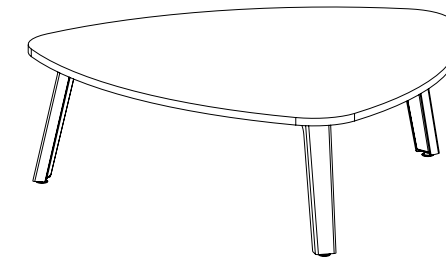

Coffee Table

**What's Included:**

- 3/4" thick trilobe top
- 3 A-legs with infill

**How to Specify:**

Table is sold with base

Each laminate comes with matching vinyl trim unless otherwise specified on the order cover sheet

Infill can match the paint finish of the A-leg or can be specified in a different finish

**Notes:**

Table corners have 4" radius

Table legs come with adjustable glides up to 1/2"

A-leg has removable infill for wire management capabilities

**Options:**

Depths: 30", 36", 42", 48"

Height: 14"

Worksurface Laminate

A-Leg paint finish

A-Leg infill paint finish

Code	Price	H	W	D	Volume	Weight
H-TTAN-143030	1104	14	30	30	1	13
H-TTAN-143636	1251	14	36	36	1	18
H-TTAN-144242	1295	14	42	42	2	25
H-TTAN-144848	1332	14	48	48	2	32

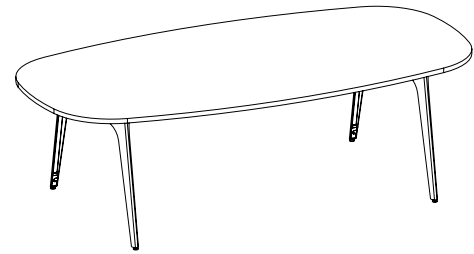

No Power



With Power

**What's Included:**

- 1" thick super ellipse top
- 4 V-legs with magnetic wire escape
- Reinforcement bar(s)
- Optional Electrics

In-surface powered option comes with one grommet per table piece with 2 AC outlets, dual USB-A chargers, and a blank slot to add an optional HDMI, RJ11, or RJ45 (see [page 178](#) for more options)

If in-surface power option is specified, wire management strips are included in the V-legs

Side-mount USB option comes with 2 USB-A chargers (see [page 178](#) for more options)

**How to Specify:**

Table is sold with base

Each laminate comes with matching vinyl trim unless otherwise specified on the order cover sheet

**Notes:**

Table corners have 4" radius

Table legs come with adjustable glides up to 1/2"

48" and 54"W are finish offered in 30"D

Magnetic wire escape offered in charcoal finish

Reinforcement bars have wire management capabilities

Optional Electrics

In-surface power+USB module available, offered in silver finish

Optional side-mount USB module, offered in black finish

**Options:**

Depths: 36", 42", 48"

Widths: 72", 84", 96"

Height: 42"

Worksurface Laminate

V-leg paint finish

**No Power**

Code	Price	H	W	D	Vol.	Wt.
H-MEVN-427242	3292	42	72	42	8.4	120.96
H-MEVN-427248	3309	42	72	48	9.6	138.24
H-MEVN-428442	3410	42	84	42	9.8	141.12
H-MEVN-428448	3426	42	84	48	11.2	161.28
H-MEVN-429642	3575	42	96	42	11.2	161.28
H-MEVN-429648	3590	42	96	48	12.8	184.32

**Power**

Code	Price	H	W	D	Vol.	Wt.
H-MEVP-427242	4459	42	72	42	8.4	120.96
H-MEVP-427248	4476	42	72	48	9.6	138.24
H-MEVP-428442	4574	42	84	42	8.4	141.12
H-MEVP-428448	4592	42	84	48	11.2	161.28
H-MEVP-429642	4742	42	96	42	11.2	161.28
H-MEVP-429648	4760	42	96	48	12.8	184.32

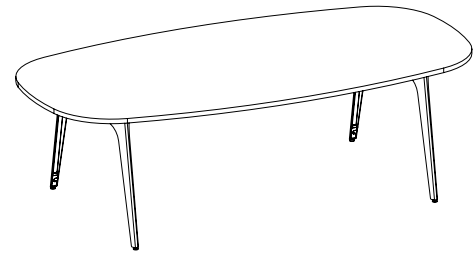

No Power



With Power

**What's Included:**

- 1" thick super ellipse top
- 4 V-legs with magnetic wire escape
- Reinforcement bar(s)
- Optional Electrics

In-surface powered option comes with one grommet per table piece with 2 AC outlets, dual USB-A chargers, and a blank slot to add an optional HDMI, RJ11, or RJ45 (see [page 178](#) for more options)

If in-surface power option is specified, wire management strips are included in the V-legs

Side-mount USB option comes with 2 USB-A chargers (see [page 178](#) for more options)

**How to Specify:**

Table is sold with base

Each laminate comes with matching vinyl trim unless otherwise specified on the order cover sheet

**Notes:**

Table corners have 4" radius

Table legs come with adjustable glides up to 1/2"

48" and 54"W are finish offered in 30"D

Magnetic wire escape offered in charcoal finish

Reinforcement bars have wire management capabilities

Optional Electrics

In-surface power+USB module available, offered in silver finish

Optional side-mount USB module, offered in black finish

**Options:**

Depths: 36", 42" 48"

Widths: 72", 84", 96"

Height: 29"

Worksurface Laminate

V-leg paint finish

**No Power**

Code	Price	H	W	D	Vol.	Wt.
H-MEVN-297236	2742	29	72	36	5	75
H-MEVN-297242	2936	29	72	42	6	88
H-MEVN-297248	2953	29	72	48	7	100
H-MEVN-298436	2825	29	84	36	6	88
H-MEVN-298442	3054	29	84	42	7	102
H-MEVN-298448	3071	29	84	48	8	117
H-MEVN-299636	2960	29	96	36	7	100
H-MEVN-299642	3219	29	96	42	8	117
H-MEVN-299648	3238	29	96	48	9	134

**Power**

Code	Price	H	W	D	Vol.	Wt.
H-MEVP-297236	3908	29	72	36	5	75
H-MEVP-297242	4104	29	72	42	6	88
H-MEVP-297248	4121	29	72	48	6	88
H-MEVP-298436	3994	29	84	36	6	88
H-MEVP-298442	4222	29	84	42	6	88
H-MEVP-298448	4238	29	84	48	8	117
H-MEVP-299636	4129	29	96	36	7	100
H-MEVP-299642	4386	29	96	42	8	117
H-MEVP-299648	4404	29	96	48	9	134

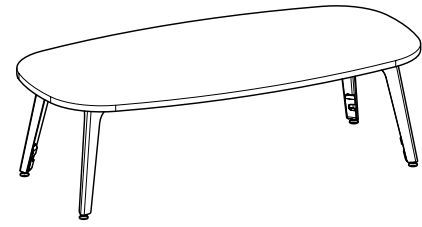

**What's Included:**

- 3/4" thick super ellipse top
- 4 V-legs with magnetic wire escape

**How to Specify:**

Table is sold with base

Each laminate comes with matching vinyl trim unless otherwise specified on the order cover sheet

**Notes:**

Table corners have 4" radius

Table legs come with adjustable glides up to 1/2"

Magnetic wire escape offered in charcoal finish

**Options:**

24"D: Widths: 36", 42", 48", 54", 60"

30"D: Widths: 48", 54", 60"

36"D: Widths: 60"

Height: 14"

Worksurface Laminate

V-leg paint finish

Code	Price	H	W	D	Volume	Weight
H-TEVN-143624	1052	14	36	24	1	12
H-TEVN-144224	1066	14	42	24	1	14
H-TEVN-144824	1085	14	48	24	1	16
H-TEVN-144830	1121	14	48	30	1	20
H-TEVN-145424	1102	14	54	24	1	18
H-TEVN-145430	1140	14	54	30	2	23
H-TEVN-146024	1123	14	60	24	1	20
H-TEVN-146030	1160	14	60	24	1	20
H-TEVN-146036	1369	14	60	36	2	30

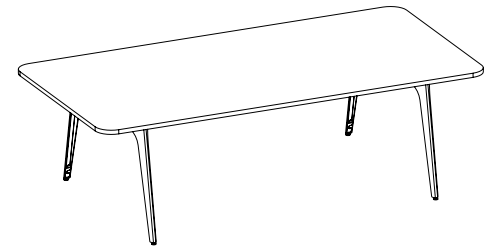

No Power



With Power

**What's Included:**

- 1" thick rectangular top
- 4 V-legs with magnetic wire escape
- Reinforcement bar(s)
- Optional Electrics

In-surface powered option comes with one grommet per table piece with 2 AC outlets, dual USB-A chargers, and a blank slot to add an optional HDMI, RJ11, or RJ45 (see [page 178](#) for more options)

If in-surface power option is specified, wire management strips are included in the V-legs

Side-mount USB option comes with 2 USB-A chargers (see [page 178](#) for more options)

**How to Specify:**

Table is sold with base

Each laminate comes with matching vinyl trim unless otherwise specified on the order cover sheet

**Notes:**

Table corners have 4" radius

Table legs come with adjustable glides up to 1/2"

48" and 54"W are finish offered in 30"D

Magnetic wire escape offered in charcoal finish

Reinforcement bars have wire management capabilities

Optional Electrics

In-surface power+USB module available, offered in silver finish

Optional side-mount USB module, offered in black finish

**Options:**

Depths: 36", 42" 48"

Widths: 60", 72", 84", 96"

Height: 42"

Worksurface Laminate

V-leg paint finish

**No Power**

Code	Price	H	W	D	Vol.	Wt.
H-MRVN-426036	2983	42	60	36	6	86
H-MRVN-426042	3145	42	60	42	7	101
H-MRVN-426048	3163	42	60	48	8	115
H-MRVN-427236	3066	42	72	36	7	104
H-MRVN-427242	3262	42	72	42	8	121
H-MRVN-427248	3281	42	72	48	10	138
H-MRVN-428436	3199	42	84	36	8	121
H-MRVN-428442	3427	42	84	42	10	141
H-MRVN-428448	3444	42	84	48	11	161
H-MRVN-429636	3333	42	96	36	10	138
H-MRVN-429642	3589	42	96	42	11	161
H-MRVN-429648	3608	42	96	48	11	161

**Power**

Code	Price	H	W	D	Vol.	Wt.
H-MRVP-426036	4147	42	60	36	6	86
H-MRVP-426042	4312	42	60	42	6	101
H-MRVP-426048	4328	42	60	48	8	115
H-MRVP-427236	4234	42	72	36	7	104
H-MRVP-427242	4430	42	72	42	8	121
H-MRVP-427248	4447	42	72	48	10	138
H-MRVP-428436	4370	42	84	36	8	121
H-MRVP-428442	4597	42	84	42	10	141
H-MRVP-428448	4613	42	84	48	11	161
H-MRVP-429636	4501	42	96	36	11	138
H-MRVP-429642	4758	42	96	42	11	161
H-MRVP-429648	4776	42	96	48	13	184

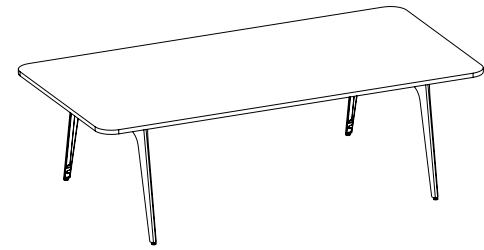

No Power

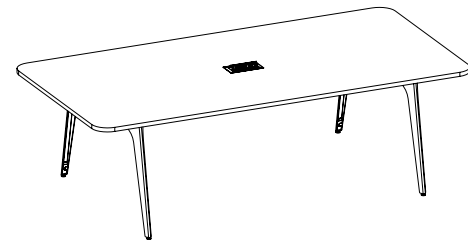

With Power

**What's Included:**

- 1" thick rectangular top
- 4 V-legs with magnetic wire escape
- Reinforcement bar(s)
- Optional Electrics

In-surface powered option comes with one grommet per table piece with 2 AC outlets, dual USB-A chargers, and a blank slot to add an optional HDMI, RJ11, or RJ45 (see [page 178](#) for more options)

If in-surface power option is specified, wire management strips are included in the V-legs

Side-mount USB option comes with 2 USB-A chargers (see [page 178](#) for more options)

**Notes:**

- Table corners have 4" radius
- Table legs come with adjustable glides up to 1/2"
- 48" and 54"W are finish offered in 30"D
- Magnetic wire escape offered in charcoal finish
- Reinforcement bars have wire management capabilities
- Optional Electrics
  - In-surface power+USB module available, offered in silver finish
  - Optional side-mount USB module, offered in black finish

**How to Specify:**

Table is sold with base

Each laminate comes with matching vinyl trim unless otherwise specified on the order cover sheet

**Options:**

- 30"D: Widths: 60"
- 36",42",48"D: Widths: 60", 72", 84", 96"
- Height: 29"
- Worksurface Laminate
- V-leg paint finish

**No Power**

Code	Price	H	W	D	Vol.	Wt.
H-MRVN-296030	2584	29	60	30	4	52
H-MRVN-296036	2627	29	60	36	4	63
H-MRVN-296042	2790	29	60	42	5	73
H-MRVN-296048	2808	29	60	48	6	84
H-MRVN-297230	2628	29	72	30	4	63
H-MRVN-297236	2677	29	72	36	5	75
H-MRVN-297242	2872	29	72	42	6	88
H-MRVN-297248	2892	29	72	48	7	100
H-MRVN-298430	2704	29	84	30	5	73
H-MRVN-298436	2762	29	84	36	6	88
H-MRVN-298442	2990	29	84	42	7	102
H-MRVN-298448	3006	29	84	48	8	117
H-MRVN-299630	2832	29	96	30	6	84
H-MRVN-299636	2896	29	96	36	7	100
H-MRVN-299642	3158	29	96	42	8	117
H-MRVN-299648	3172	29	96	48	9	134

**Power**

Code	Price	H	W	D	Vol.	Wt.
H-MRVP-296030	3754	29	60	30	4	52
H-MRVP-296036	3795	29	60	36	4	63
H-MRVP-296042	3958	29	60	42	5	73
H-MRVP-296048	3973	29	60	48	6	84
H-MRVP-297230	3796	29	72	30	4	63
H-MRVP-297236	3843	29	72	36	5	75
H-MRVP-297242	4042	29	72	42	6	88
H-MRVP-297248	4058	29	72	48	7	100
H-MRVP-298430	3875	29	84	30	5	73
H-MRVP-298436	3929	29	84	36	6	88
H-MRVP-298442	4157	29	84	42	7	102
H-MRVP-298448	4174	29	84	48	8	117
H-MRVP-299630	4000	29	96	30	6	84
H-MRVP-299636	4065	29	96	36	7	100
H-MRVP-299642	4322	29	96	42	8	117
H-MRVP-299648	4339	29	96	48	9	134

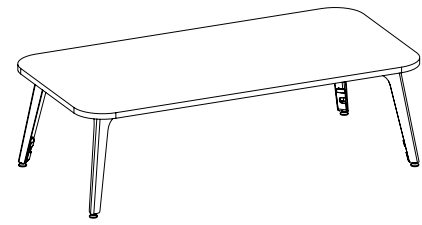

**What's Included:**

- 3/4" thick rectangular top
- 4 V-legs with magnetic wire escape

**How to Specify:**

Table is sold with base

Each laminate comes with matching vinyl trim unless otherwise specified on the order cover sheet

**Notes:**

Table corners have 4" radius

Table legs come with adjustable glides up to 1/2"

Magnetic wire escape offered in charcoal finish

**Options:**

24"D: Widths: 36", 42", 48", 54", 60"

30"D: Widths: 48", 54", 60"

36"D: Widths: 60"

Height: 14"

Worksurface Laminate

V-leg paint finish

Code	Price	H	W	D	Volume	Weight
H-TRVN-143624	1018	14	36	24	1	12
H-TRVN-144224	1034	14	42	24	1	14
H-TRVN-144824	1054	14	48	24	1	16
H-TRVN-144830	1086	14	48	30	1	20
H-TRVN-145424	1070	14	54	24	1	18
H-TRVN-145430	1110	14	54	30	2	23
H-TRVN-146024	1087	14	60	24	1	20
H-TRVN-146030	1129	14	60	30	2	25
H-TRVN-146036	1171	14	60	36	2	30

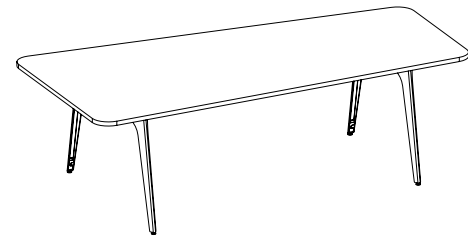

No Power

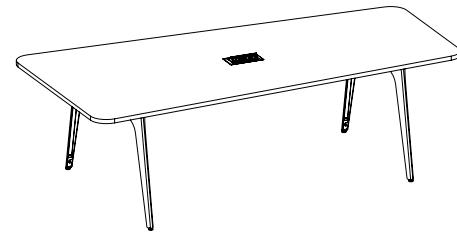

With Power

**What's Included:**

- 1" thick video top
- 4 V-legs with magnetic wire escape
- Reinforcement bar(s)
- Optional Electrics

In-surface powered option comes with one grommet per table piece with 2 AC outlets, dual USB-A chargers, and a blank slot to add an optional HDMI, RJ11, or RJ45 (see [page 178](#) for more options)

If in-surface power option is specified, wire management strips are included in the V-legs

Side-mount USB option comes with 2 USB-A chargers (see [page 178](#) for more options)

**How to Specify:**

Table is sold with base

Each laminate comes with matching vinyl trim unless otherwise specified on the order cover sheet

**Notes:**

Table corners have 4" radius

Table legs come with adjustable glides up to 1/2"

48" and 54"W are finish offered in 30"D

Magnetic wire escape offered in charcoal finish

Reinforcement bars have wire management capabilities

Optional Electrics

In-surface power+USB module available, offered in silver finish

Optional side-mount USB module, offered in black finish

**Options:**

Depths: 48"

Widths: 72", 84", 96"

Height: 42"

Worksurface Laminate

V-leg paint finish

**No Power**

Code	Price	H	W	D	Vol.	Wt.
H-MVVN-427248	3328	42	72	48	10	138
H-MVVN-428448	3493	42	84	48	11	161
H-MVVN-429648	3655	42	96	48	11	161

**Power**

Code	Price	H	W	D	Vol.	Wt.
H-MVVP-427248	4492	42	72	48	10	138
H-MVVP-428448	4661	42	84	48	11	161
H-MVVP-429648	4824	42	96	48	13	184

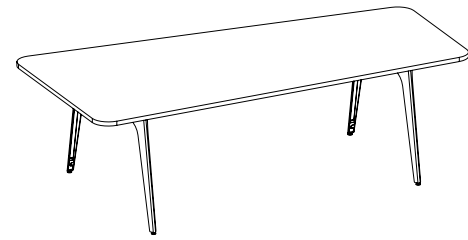

No Power

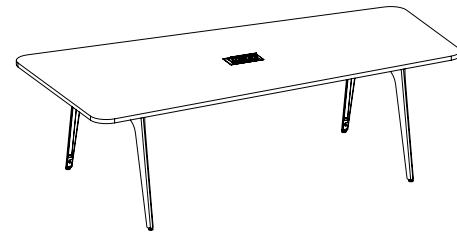

With Power

**What's Included:**

- 1" thick video top
- 4 V-legs with magnetic wire escape
- Reinforcement bar(s)
- Optional Electrics

In-surface powered option comes with one grommet per table piece with 2 AC outlets, dual USB-A chargers, and a blank slot to add an optional HDMI, RJ11, or RJ45 (see [page 178](#) for more options)

If in-surface power option is specified, wire management strips are included in the V-legs

Side-mount USB option comes with 2 USB-A chargers (see [page 178](#) for more options)

**How to Specify:**

Table is sold with base

Each laminate comes with matching vinyl trim unless otherwise specified on the order cover sheet

**Notes:**

Table corners have 4" radius

Table legs come with adjustable glides up to 1/2"

48" and 54"W are finish offered in 30"D

Magnetic wire escape offered in charcoal finish

Reinforcement bars have wire management capabilities

Optional Electrics

In-surface power+USB module available, offered in silver finish

Optional side-mount USB module, offered in black finish

**Options:**

Depths: 42", 48"D

Widths: 72", 84", 96"

Height: 29

Worksurface Laminate

V-leg paint finish

**No Power**

Code	Price	H	W	D	Vol.	Wt.
H-MVVN-297242	2936	29	72	42	6	88
H-MVVN-297248	2953	29	72	48	7	100
H-MVVN-298442	3054	29	84	42	7	102
H-MVVN-298448	3071	29	84	48	8	117
H-MVVN-299642	3219	29	96	42	8	117
H-MVVN-299648	3238	29	96	48	9	134

**Power**

Code	Price	H	W	D	Vol.	Wt.
H-MVVP-297242	4104	29	72	42	6	88
H-MVVP-297248	4121	29	72	48	7	100
H-MVVP-298442	4222	29	84	42	7	102
H-MVVP-298448	4238	29	84	48	13	117
H-MVVP-299642	4386	29	96	42	8	117
H-MVVP-299648	4404	29	96	48	8	117



**What's Included:**

- 1" thick square top
- 4 V-legs with magnetic wire escape

**How to Specify:**

Table is sold with base

Each laminate comes with matching vinyl trim unless otherwise specified on the order cover sheet

**Options:**

Widths: 36", 42", 48"

Depths: 36", 42", 48"

Worksurface Laminate

V-Leg Paint Finish

**Notes:**

Table corners have 4" radius

Table legs come with adjustable glides up to 1/2"

48" and 54"W are finish offered in 30"D

Magnetic wire escape offered in charcoal finish

Code	Price	H	W	D	Volume	Weight
H-MSVN-293636	2020	29	36	36	3	38
H-MSVN-294242	2115	29	42	42	3	38
H-MSVN-294848	2206	29	48	48	5	67

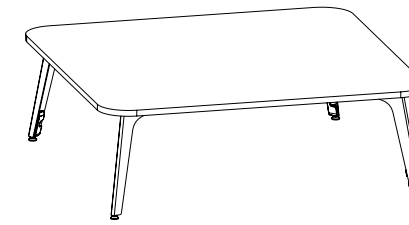

**What's Included:**

- 3/4" thick square top
- 4 V-legs with magnetic wire escape

**How to Specify:**

Table is sold with base

Each laminate comes with matching vinyl trim unless otherwise specified on the order cover sheet

**Options:**

Depths: 30", 36", 42", 48"

Height: 14"

Worksurface Laminate

V-leg paint finish

**Notes:**

Table corners have 4" radius

Table legs come with adjustable glides up to 1/2"

Magnetic wire escape offered in charcoal finish

Code	Price	H	W	D	Volume	Weight
H-TSVN-143030	1022	14	30	30	1	13
H-TSVN-143636	1069	14	36	36	1	18
H-TSVN-144242	1211	14	42	42	2	25
H-TSVN-144848	1251	14	48	48	2	32



**What's Included:**

- 1" thick circle top
- 3 V-legs with magnetic wire escape

**How to Specify:**

Table is sold with base

Each laminate comes with matching vinyl trim unless otherwise specified on the order cover sheet

**Notes:**

Table corners have 4" radius  
 Table legs come with adjustable glides up to 1/2"  
 48" and 54"W are finish offered in 30"D  
 Magnetic wire escape offered in charcoal finish

**Options:**

Widths: 36", 42", 48"

Depths: 36", 42", 48"

Worksurface Laminate

V-Leg Paint Finish

Code	Price	H	W	D	Volume	Weight
H-MOVN-293636	1648	29	36	36	3	38
H-MOVN-294242	1792	29	42	42	3	38
H-MOVN-294848	1834	29	48	48	5	67

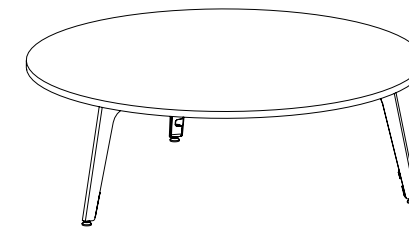

**What's Included:**

- 3/4" thick circle top
- 3 V-legs with magnetic wire escape

**How to Specify:**

Table is sold with base

Each laminate comes with matching vinyl trim unless otherwise specified on the order cover sheet

**Notes:**

Table corners have 4" radius  
 Table legs come with adjustable glides up to 1/2"  
 Magnetic wire escape offered in charcoal finish

**Options:**

Depths: 30", 36", 42", 48"

Height: 14"

Worksurface Laminate

V-leg paint finish

Code	Price	H	W	D	Volume	Weight
H-TOVN-143030	855	14	30	30	1	13
H-TOVN-143636	1005	14	36	36	1	18
H-TOVN-144242	1043	14	42	42	2	25
H-TOVN-144848	1085	14	48	48	2	32



**What's Included:**

- 1" thick squircle top
- 4 V-legs with magnetic wire escape

**How to Specify:**

Table is sold with base

Each laminate comes with matching vinyl trim unless otherwise specified on the order cover sheet

**Notes:**

- Table corners have 4" radius
- Table legs come with adjustable glides up to 1/2"
- Magnetic wire escape offered in charcoal finish

**Options:**

Widths: 36", 42", 48"

Depths: 36", 42", 48"

Worksurface Laminate

V-Leg Paint Finish

Code	Price	H	W	D	Volume	Weight
H-MQVN-293636	2086	29	36	36	3	38
H-MQVN-294242	2229	29	42	42	4	51
H-MQVN-294848	2269	29	48	48	4	51

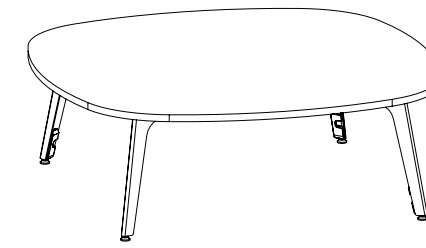

**What's Included:**

- 3/4" thick squircle top
- 4 V-legs with magnetic wire escape

**How to Specify:**

Table is sold with base

Each laminate comes with matching vinyl trim unless otherwise specified on the order cover sheet

**Notes:**

- Table corners have 4" radius
- Table legs come with adjustable glides up to 1/2"
- Magnetic wire escape offered in charcoal finish

**Options:**

Depths: 30", 36", 42", 48"

Height: 14"

Worksurface Laminate

V-leg paint finish

Code	Price	H	W	D	Volume	Weight
H-TQVN-143030	1054	14	30	30	1	13
H-TQVN-143636	1203	14	36	36	1	18
H-TQVN-144242	1244	14	42	42	2	25
H-TQVN-144848	1285	14	48	48	2	32



**What's Included:**

- 1" thick trilobe top
- 3 V-legs with magnetic wire escape

**How to Specify:**

Table is sold with base

Each laminate comes with matching vinyl trim unless otherwise specified on the order cover sheet

**Options:**

Widths: 36", 42", 48"

Depths: 36", 42", 48"

Worksurface Laminate

V-Leg Paint Finish

**Notes:**

Table corners have 4" radius

Table legs come with adjustable glides up to 1/2"

Magnetic wire escape offered in charcoal finish

Code	Price	H	W	D	Volume	Weight
H-MTVN-293636	1648	29	36	36	3	38
H-MTVN-294242	1792	29	42	42	4	51
H-MTVN-294848	1834	29	48	48	5	67

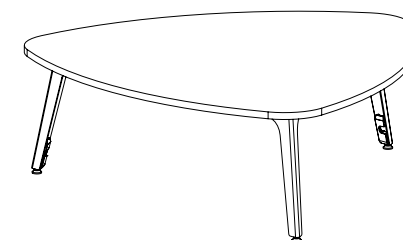

**What's Included:**

- 3/4" thick trilobe top
- 3 V-legs with magnetic wire escape

**How to Specify:**

Table is sold with base

Each laminate comes with matching vinyl trim unless otherwise specified on the order cover sheet

**Options:**

Depths: 30", 36", 42", 48"

Height: 14"

Worksurface Laminate

V-leg paint finish

**Notes:**

Table corners have 4" radius

Table legs come with adjustable glides up to 1/2"

Magnetic wire escape offered in charcoal finish

Code	Price	H	W	D	Volume	Weight
H-TTVN-143030	1054	14	30	30	1	13
H-TTVN-143636	1203	14	36	36	1	18
H-TTVN-144242	1244	14	42	42	2	25
H-TTVN-144848	1285	14	48	48	2	32



Halifax Pricebook  
January 2026  
**Desking**

Freestanding	
A-Leg	60
V-Leg	62
Hanging Pedestal	64
Low Credenza Mount	
A-Leg Hutch & Gallery Wall	66
A-Leg Short Gable	68
V-Leg Hutch & Gallery Wall	70
V-Leg Short Gable	72
No Leg Hutch & Gallery Wall	74
No Leg Short Gable	76
High Credenza Mount	
A leg	78
V leg	80
Height Adjustable Table	82
Suspended Pedestal	84
Credenza integrated	86
Credenza & Pedestal	88
Worksurface	
No Grommet	90
w/ Grommet	92
Bridge	94
Reinforcement Bar	96
Modesty	98
Worksurface Support & Hardware	100
Table Support	102

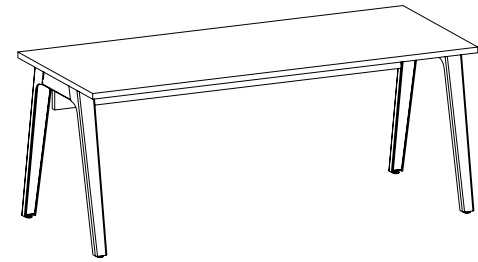

A-Leg No Grommet

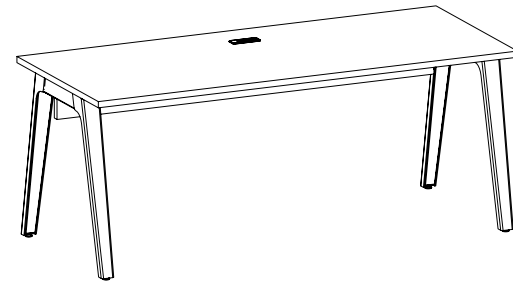

A-Leg With Grommet

**What's Included:**

- Worksurface
- 2 A-leg gables
- reinforcement bar
- modesty

**Notes:**

One of the A-Legs will come with an infill with a small hole to run wires out the bottom

**Options:**

Widths: 60", 66", 72", 78", 84"

Depths: 30"

Laminate

Paint Finish

Electrics

**A-Leg**

Code	Price	H	W	D	Volume	Weight
<b>No Grommet</b>						
H-TFAN-296030	2843	29	60	30	5	61
H-TFAN-296630	2903	29	66	30	6	68
H-TFAN-297230	2963	29	72	30	6	74
H-TFAN-297830	3054	29	78	30	7	80
H-TFAN-298430	3088	29	84	30	7	86
<b>w/ Grommet</b>						
H-TFAH-296030	2850	29	60	30	5	61
H-TFAH-296630	2907	29	66	30	6	68
H-TFAH-297230	2970	29	72	30	6	74
H-TFAH-297830	3059	29	78	30	7	80
H-TFAH-298430	3093	29	84	30	7	86

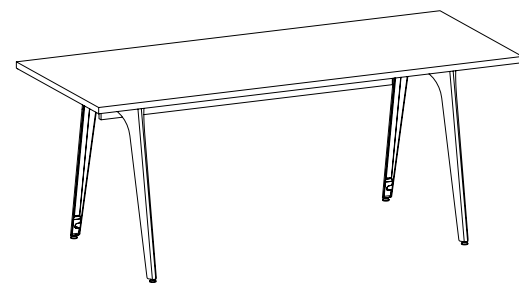

V-Leg No Grommet



V-Leg With Grommet

**What's Included:**

- Worksurface
- 2 A-leg gables
- reinforcement bar
- modesty

**Notes:**

**Options:**

Widths: 60", 66", 72", 78", 84"

Depths: 30"

Laminate

Paint Finish

Electrics

V-Leg

Code	Price	H	W	D	Vol.	Wt.
<b>No Grommet</b>						
H-TFVN-296030	2632	29	60	30	5	61
H-TFVN-296630	2656	29	66	30	6	68
H-TFVN-297230	2691	29	72	30	6	74
H-TFVN-297830	2751	29	78	30	7	80
H-TFVN-298430	2780	29	84	30	7	86
<b>w/ Grommet</b>						
H-TFVH-296030	2639	29	60	30	5	61
H-TFVH-296630	2660	29	66	30	6	68
H-TFVH-297230	2697	29	72	30	6	74
H-TFVH-297830	2757	29	78	30	7	80
H-TFVH-298430	2788	29	84	30	7	86

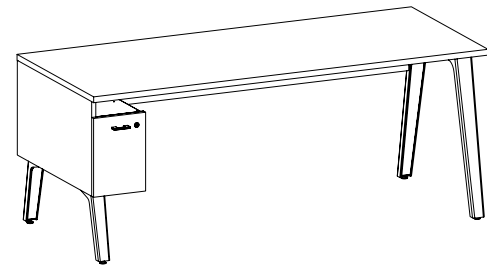

no Grommet

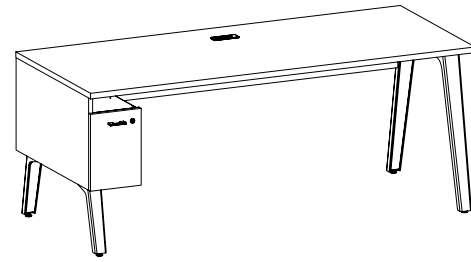

With Grommet

**What's Included:**

- Desk with a hanging pedestal with A-Leg

**How to Specify:**

Hanging pedestal on RH or LH

**Notes:**

Hanging pedestal has a 9-1/2"W file drawer

**Options:**

Widths: 60", 66", 72"

Depths: 30"

Laminate

Paint Finish

Electrics

**A-Leg**

Code	Price	H	W	D	Volume	Weight
<b>No Grommet</b>						
H-TSAN-296030-L	3536	29	60	30	5	61
H-TSAN-296630-L	3566	29	66	30	6	68
H-TSAN-297230-L	3640	29	72	30	6	74
H-TSAN-296030-R	3536	29	60	30	5	61
H-TSAN-296630-R	3566	29	66	30	6	68
H-TSAN-297230-R	3640	29	72	30	6	74
<b>w/ Grommet</b>						
H-TSAH-296030-L	3541	29	60	30	5	61
H-TSAH-296630-L	3573	29	66	30	6	68
H-TSAH-297230-L	3642	29	72	30	6	74
H-TSAH-296030-R	3541	29	60	30	5	61
H-TSAH-296630-R	3573	29	66	30	6	68
H-TSAH-297230-R	3642	29	72	30	6	74

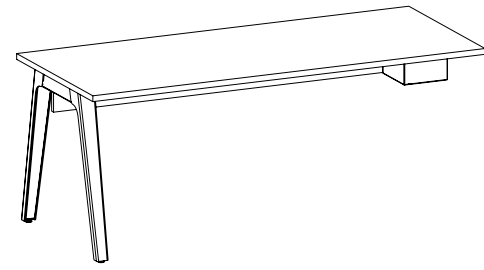

no Grommet

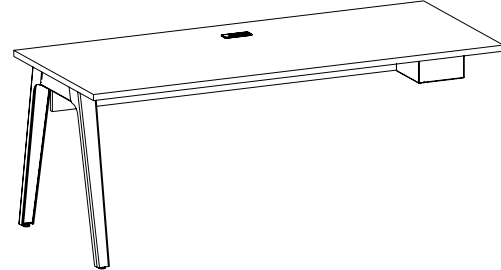

With Grommet

**What's Included:**

- Worksurface
- Modesty
- A-leg
- Reinforcement bar
- Credenza mounting box

**How to Specify:**

**Notes:**

Application is for layout with a freestanding hutch or a gallery wall

One of the A-Legs will come with an infill with a small hole to run wires out the bottom

**Options:**

Widths: 60", 66", 72", 78", 84"

Depths: 30"

Laminate

Paint Finish

Electrics

Code	Price	H	W	D	Volume	Weight
<b>w/ Grommet</b>						
H-TLAN-296030-L	2231	29	60	30	5.0	61
H-TLAN-296630-L	2292	29	66	30	6.0	68
H-TLAN-297230-L	2353	29	72	30	6.0	74
H-TLAN-297830-L	2442	29	78	30	7.0	80
H-TLAN-298430-L	2473	29	84	30	7.0	86
H-TLAN-296030-R	2231	29	60	30	5.0	61
H-TLAN-296630-R	2292	29	66	30	6.0	68
H-TLAN-297230-R	2353	29	72	30	6.0	74
H-TLAN-297830-R	2442	29	78	30	7.0	80
H-TLAN-298430-R	2473	29	84	30	7.0	86
<b>No Grommet</b>						
H-TLAH-296030-L	2236	29	60	30	5.0	61
H-TLAH-296630-L	2297	29	66	30	6.0	68
H-TLAH-297230-L	2358	29	72	30	6.0	74
H-TLAH-297830-L	2448	29	78	30	7.0	80
H-TLAH-298430-L	2479	29	84	30	7.0	86
H-TLAH-296030-R	2236	29	60	30	5.0	61
H-TLAH-296630-R	2297	29	66	30	6.0	68
H-TLAH-297230-R	2358	29	72	30	6.0	74
H-TLAH-297830-R	2448	29	78	30	7.0	80
H-TLAH-298430-R	2479	29	84	30	7.0	86

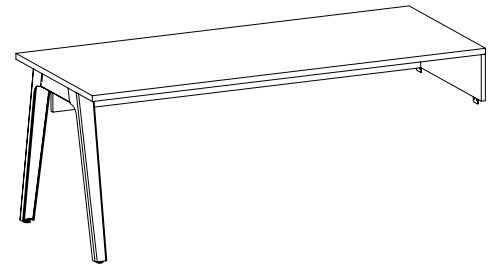

no Grommet

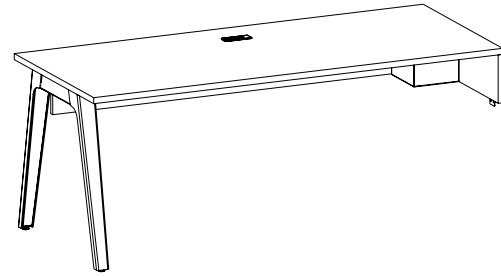

With Grommet

**What's Included:**

- Worksurface
- Short Gable
- Modesty
- A-leg
- Reinforcement bar
- Credenza mounting box

**How to Specify:**

**Notes:**

Application is for layout that does not include a freestanding hutch or a gallery wall  
 One of the A-Legs will come with an infill with a small hole to run wires out the bottom

**Options:**

Widths: 60", 66", 72", 78", 84"

Depths: 30"

Laminate

Paint Finish

Electrics

Code	Price	H	W	D	Volume	Weight
<b>No Grommet</b>						
H-TLSAN-296030-GL	2360	29	60	30	5.0	61
H-TLSAN-296630-GL	2420	29	66	30	6.0	68
H-TLSAN-297230-GL	2482	29	72	30	6.0	74
H-TLSAN-297830-GL	2572	29	78	30	7.0	80
H-TLSAN-298430-GL	2603	29	84	30	7.0	86
H-TLSAN-296030-GR	2360	29	60	30	5.0	61
H-TLSAN-296630-GR	2420	29	66	30	6.0	68
H-TLSAN-297230-GR	2482	29	72	30	6.0	74
H-TLSAN-297830-GR	2572	29	78	30	7.0	80
H-TLSAN-298430-GR	2603	29	84	30	7.0	86
<b>w/ Grommet</b>						
H-TLSAH-296030-GL	2363	29	60	30	5.0	61
H-TLSAH-296630-GL	2424	29	66	30	6.0	68
H-TLSAH-297230-GL	2487	29	72	30	6.0	74
H-TLSAH-297830-GL	2577	29	78	30	7.0	80
H-TLSAH-298430-GL	2611	29	84	30	7.0	86
H-TLSAH-296030-GR	2363	29	60	30	5.0	61
H-TLSAH-296630-GR	2424	29	66	30	6.0	68
H-TLSAH-297230-GR	2487	29	72	30	6.0	74
H-TLSAH-297830-GR	2577	29	78	30	7.0	80
H-TLSAH-298430-GR	2611	29	84	30	7.0	86

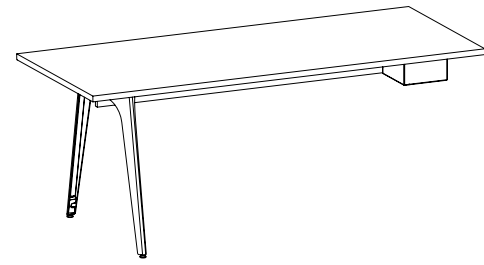

no Grommet

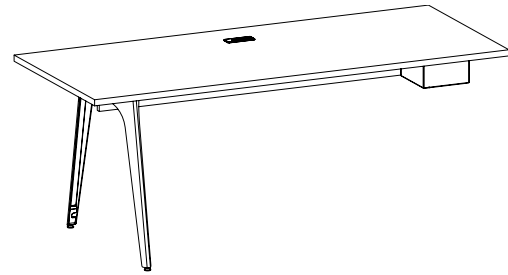

With Grommet

**What's Included:**

- Worksurface
- Modesty
- V-leg
- Reinforcement bar
- Credenza mounting box

**How to Specify:**

**Notes:**

Application is for layout with a freestanding hutch or a gallery wall

**Options:**

Widths: 60", 66", 72", 78", 84"

Depths: 30"

Laminate

Paint Finish

Electrics

Code	Price	H	W	D	Volume	Weight
<b>No Grommet</b>						
H-TLVN-296030-L	1938	29	60	30	5.0	61
H-TLVN-296630-L	1973	29	66	30	6.0	68
H-TLVN-297230-L	2032	29	72	30	6.0	74
H-TLVN-297830-L	2059	29	78	30	7.0	80
H-TLVN-298430-L	2109	29	84	30	7.0	86
H-TLVN-296030-R	1938	29	60	30	5.0	61
H-TLVN-296630-R	1973	29	66	30	6.0	68
H-TLVN-297230-R	2032	29	72	30	6.0	74
H-TLVN-297830-R	2059	29	78	30	7.0	80
H-TLVN-298430-R	2109	29	84	30	7.0	86
<b>w/ Grommet</b>						
H-TLVH-296030-L	1943	29	60	30	5.0	61
H-TLVH-296630-L	1977	29	66	30	6.0	68
H-TLVH-297230-L	2035	29	72	30	6.0	74
H-TLVH-297830-L	2064	29	78	30	7.0	80
H-TLVH-298430-L	2116	29	84	30	7.0	86
H-TLVH-296030-R	1943	29	60	30	5.0	61
H-TLVH-296630-R	1977	29	66	30	6.0	68
H-TLVH-297230-R	2035	29	72	30	6.0	74
H-TLVH-297830-R	2064	29	78	30	7.0	80
H-TLVH-298430-R	2116	29	84	30	7.0	86

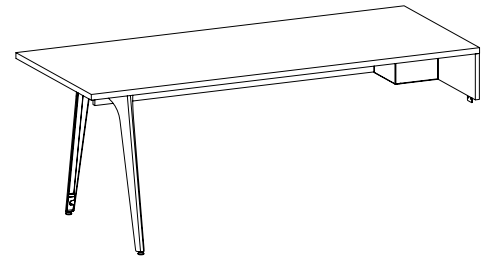

no Grommet



With Grommet

**What's Included:**

- Worksurface
- Short Gable
- Modesty
- V-leg
- Reinforcement bar
- Credenza mounting box

**How to Specify:**

**Notes:**

Application is for layout that does not include a freestanding hutch or a gallery wall

**Options:**

Widths: 60", 66", 72", 78", 84"

Depths: 30"

Laminate

Paint Finish

Electrics

Code	Price	H	W	D	Volume	Weight
<b>No Grommet</b>						
H-TLSVN-296030-GL	2100	29	60	30	5.0	61
H-TLSVN-296630-GL	2134	29	66	30	6.0	68
H-TLSVN-297230-GL	2196	29	72	30	6.0	74
H-TLSVN-297830-GL	2226	29	78	30	7.0	80
H-TLSVN-298430-GL	2278	29	84	30	7.0	86
H-TLSVN-296030-GR	2100	29	60	30	5.0	61
H-TLSVN-296630-GR	2134	29	66	30	6.0	68
H-TLSVN-297230-GR	2196	29	72	30	6.0	74
H-TLSVN-297830-GR	2226	29	78	30	7.0	80
H-TLSVN-298430-GR	2278	29	84	30	7.0	86
<b>w/ Grommet</b>						
H-TLSVH-296030-GL	2106	29	60	30	5.0	61
H-TLSVH-296630-GL	2137	29	66	30	6.0	68
H-TLSVH-297230-GL	2204	29	72	30	6.0	74
H-TLSVH-297830-GL	2231	29	78	30	7.0	80
H-TLSVH-298430-GL	2281	29	84	30	7.0	86
H-TLSVH-296030-GR	2106	29	60	30	5.0	61
H-TLSVH-296630-GR	2137	29	66	30	6.0	68
H-TLSVH-297230-GR	2204	29	72	30	6.0	74
H-TLSVH-297830-GR	2231	29	78	30	7.0	80
H-TLSVH-298430-GR	2281	29	84	30	7.0	86

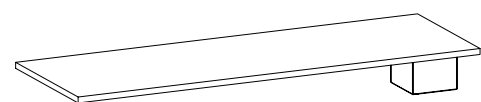

no Grommet

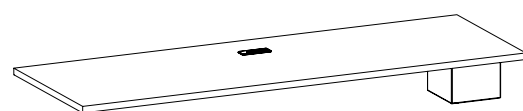

With Grommet

**What's Included:**

- Worksurface
- Credenza mounting bo

**How to Specify:**

Modesty, support and reinforcement bar to be specified separately

**Notes:**

Application is for layout with a freestanding hutch or a gallery wall

**Options:**

Widths: 60", 66", 72", 78", 84"

Depths: 19", 24", 30"

Laminate

Paint Finish

Electrics

No Grommet

w/Grommet

Code	Price	H	W	D	Vol.	Wt.	Code	Price	H	W	D	Vol.	Wt.
H-TLSN-296019-L	432	29	60	19	5.0	39	H-TLSH-296019-L	436	29	60	19	5.0	39
H-TLSN-296619-L	441	29	66	19	6.0	43	H-TLSH-296619-L	451	29	66	19	6.0	43
H-TLSN-297219-L	461	29	72	19	6.0	47	H-TLSH-297219-L	464	29	72	19	6.0	47
H-TLSN-297819-L	472	29	78	19	7.0	51	H-TLSH-297819-L	480	29	78	19	7.0	51
H-TLSN-298419-L	487	29	84	19	7.0	54	H-TLSH-298419-L	492	29	84	19	7.0	54
H-TLSN-296019-R	432	29	60	19	5.0	39	H-TLSH-296019-R	436	29	60	19	5.0	39
H-TLSN-296619-R	441	29	66	19	6.0	43	H-TLSH-296619-R	451	29	66	19	6.0	43
H-TLSN-297219-R	461	29	72	19	6.0	47	H-TLSH-297219-R	464	29	72	19	6.0	47
H-TLSN-297819-R	472	29	78	19	7.0	51	H-TLSH-297819-R	480	29	78	19	7.0	51
H-TLSN-298419-R	487	29	84	19	7.0	54	H-TLSH-298419-R	492	29	84	19	7.0	54
H-TLSN-296024-L	464	29	60	24	5.0	49	H-TLSH-296024-L	468	29	60	24	5.0	49
H-TLSN-296624-L	483	29	66	24	6.0	54	H-TLSH-296624-L	487	29	66	24	6.0	54
H-TLSN-297224-L	499	29	72	24	6.0	59	H-TLSH-297224-L	506	29	72	24	6.0	59
H-TLSN-297824-L	517	29	78	24	7.0	64	H-TLSH-297824-L	522	29	78	24	7.0	64
H-TLSN-298424-L	536	29	84	24	7.0	69	H-TLSH-298424-L	541	29	84	24	7.0	69
H-TLSN-296024-R	464	29	60	24	5.0	49	H-TLSH-296024-R	468	29	60	24	5.0	49
H-TLSN-296624-R	483	29	66	24	6.0	54	H-TLSH-296624-R	487	29	66	24	6.0	54
H-TLSN-297224-R	499	29	72	24	6.0	59	H-TLSH-297224-R	506	29	72	24	6.0	59
H-TLSN-297824-R	517	29	78	24	7.0	64	H-TLSH-297824-R	522	29	78	24	7.0	64
H-TLSN-298424-R	536	29	84	24	7.0	69	H-TLSH-298424-R	541	29	84	24	7.0	69
H-TLSN-296030-L	506	29	60	30	5.0	61	H-TLSH-296030-L	511	29	60	30	5.0	61
H-TLSN-296630-L	526	29	66	30	6.0	68	H-TLSH-296630-L	535	29	66	30	6.0	68
H-TLSN-297230-L	548	29	72	30	6.0	74	H-TLSH-297230-L	555	29	72	30	6.0	74
H-TLSN-297830-L	571	29	78	30	7.0	80	H-TLSH-297830-L	574	29	78	30	7.0	80
H-TLSN-298430-L	592	29	84	30	7.0	86	H-TLSH-298430-L	597	29	84	30	7.0	86
H-TLSN-296030-R	506	29	60	30	5.0	61	H-TLSH-296030-R	511	29	60	30	5.0	61
H-TLSN-296630-R	526	29	66	30	6.0	68	H-TLSH-296630-R	535	29	66	30	6.0	68
H-TLSN-297230-R	548	29	72	30	6.0	74	H-TLSH-297230-R	555	29	72	30	6.0	74
H-TLSN-297830-R	571	29	78	30	7.0	80	H-TLSH-297830-R	574	29	78	30	7.0	80
H-TLSN-298430-R	592	29	84	30	7.0	86	H-TLSH-298430-R	597	29	84	30	7.0	86

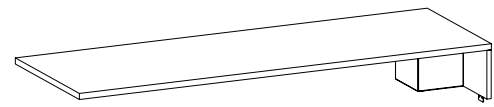

no Grommet

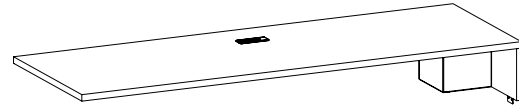

With Grommet

**What's Included:**

- Worksurface
- Short Gable
- Credenza mounting box

**How to Specify:**

Need modesty, supports, and reinforcement bar to be specified separately

**Notes:**

Application is for layout that does not include a freestanding hutch or a gallery wall

**Options:**

Widths: 60", 66", 72", 78", 84"

Depths: 19", 24", 30"

Laminate

Paint Finish

Electrics

No Grommet

Code	Price	H	W	D	Vol.	Wt.
H-TLSN-296019-GL	437	29	60	19		
H-TLSN-296619-GL	560	29	66	19	6.0	43
H-TLSN-297219-GL	574	29	72	19	6.0	47
H-TLSN-297819-GL	589	29	78	19	7.0	51
H-TLSN-298419-GL	603	29	84	19	7.0	54
H-TLSN-296019-GR	437	29	60	19		
H-TLSN-296619-GR	560	29	66	19	6.0	43
H-TLSN-297219-GR	574	29	72	19	6.0	47
H-TLSN-297819-GR	589	29	78	19	7.0	51
H-TLSN-298419-GR	603	29	84	19	7.0	54
H-TLSN-296024-GL	472	29	60	24	5.0	49
H-TLSN-296624-GL	603	29	66	24	6.0	54
H-TLSN-297224-GL	623	29	72	24	6.0	59
H-TLSN-297824-GL	640	29	78	24	7.0	64
H-TLSN-298424-GL	658	29	84	24	7.0	69
H-TLSN-296024-GR	472	29	60	24	5.0	49
H-TLSN-296624-GR	603	29	66	24	6.0	54
H-TLSN-297224-GR	623	29	72	24	6.0	59
H-TLSN-297824-GR	640	29	78	24	7.0	64
H-TLSN-298424-GR	658	29	84	24	7.0	69
H-TLSN-296030-GL	514	29	60	30	5.0	61
H-TLSN-296630-GL	658	29	66	30	6.0	68
H-TLSN-297230-GL	678	29	72	30	6.0	74
H-TLSN-297830-GL	702	29	78	30	7.0	80
H-TLSN-298430-GL	719	29	84	30	7.0	86
H-TLSN-296030-GR	514	29	60	30	5.0	61
H-TLSN-296630-GR	658	29	66	30	6.0	68
H-TLSN-297230-GR	678	29	72	30	6.0	74
H-TLSN-297830-GR	702	29	78	30	7.0	80
H-TLSN-298430-GR	719	29	84	30	7.0	86

With Grommet

Code	Price	H	W	D	Vol.	Wt.
H-TLSH-296019-GL	456	29	60	19	5.0	39
H-TLSH-296619-GL	566	29	66	19	6.0	43
H-TLSH-297219-GL	581	29	72	19	6.0	47
H-TLSH-297819-GL	596	29	78	19	7.0	51
H-TLSH-298419-GL	608	29	84	19	7.0	54
H-TLSH-296019-GR	456	29	60	19	5.0	39
H-TLSH-296619-GR	566	29	66	19	6.0	43
H-TLSH-297219-GR	581	29	72	19	6.0	47
H-TLSH-297819-GR	596	29	78	19	7.0	51
H-TLSH-298419-GR	608	29	84	19	7.0	54
H-TLSH-296024-GL	487	29	60	24	5.0	49
H-TLSH-296624-GL	608	29	66	24	6.0	54
H-TLSH-297224-GL	627	29	72	24	6.0	59
H-TLSH-297824-GL	644	29	78	24	7.0	64
H-TLSH-298424-GL	662	29	84	24	7.0	69
H-TLSH-296024-GR	487	29	60	24	5.0	49
H-TLSH-296624-GR	608	29	66	24	6.0	54
H-TLSH-297224-GR	627	29	72	24	6.0	59
H-TLSH-297824-GR	644	29	78	24	7.0	64
H-TLSH-298424-GR	662	29	84	24	7.0	69
H-TLSH-296030-GL	530	29	60	30	5.0	61
H-TLSH-296630-GL	662	29	66	30	6.0	68
H-TLSH-297230-GL	682	29	72	30	6.0	74
H-TLSH-297830-GL	704	29	78	30	7.0	80
H-TLSH-298430-GL	727	29	84	30	7.0	86
H-TLSH-296030-GR	530	29	60	30	5.0	61
H-TLSH-296630-GR	662	29	66	30	6.0	68
H-TLSH-297230-GR	682	29	72	30	6.0	74
H-TLSH-297830-GR	704	29	78	30	7.0	80
H-TLSH-298430-GR	727	29	84	30	7.0	86

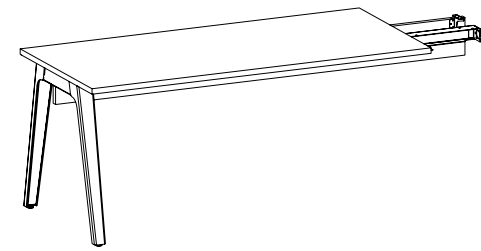

No Grommet

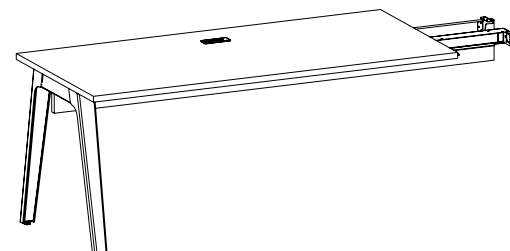

With Grommet

**What's Included:**

- Worksurface
- Modesty
- Reinforcement bar
- Supporting Leg

**Notes:**

One of the A-Legs will come with an infill with a small hole to run wires out the bottom

**Options:**

Widths: 42" 48", 54", 60", 66"

Depths: 30"

Laminate

Paint Finish

Electrics

A-Leg

Code	Price	H	W	D	Volume	Weight
<b>No Grommet</b>						
H-THAN-294230-L	2000	29	42	30	5.0	61
H-THAN-294830-L	2030	29	48	30	6.0	68
H-THAN-295430-L	2056	29	54	30	6.0	55
H-THAN-296030-L	2086	29	60	30	7.0	61
H-THAN-296630-L	2112	29	66	30	7.0	68
H-THAN-294230-R	2000	29	42	30	5.0	61
H-THAN-294830-R	2030	29	48	30	6.0	68
H-THAN-295430-R	2056	29	54	30	6.0	55
H-THAN-296030-R	2086	29	60	30	7.0	61
H-THAN-296630-R	2112	29	66	30	7.0	68
<b>w/ Grommet</b>						
H-THAH-294230-L	2005	29	42	30	5.0	43
H-THAH-294830-L	2032	29	48	30	6.0	49
H-THAH-295430-L	2059	29	54	30	6.0	55
H-THAH-296030-L	2091	29	60	30	7.0	61
H-THAH-296630-L	2117	29	66	30	7.0	68
H-THAH-294230-R	2005	29	42	30	5.0	43
H-THAH-294830-R	2032	29	48	30	6.0	49
H-THAH-295430-R	2059	29	54	30	6.0	55
H-THAH-296030-R	2091	29	60	30	7.0	61
H-THAH-296630-R	2117	29	66	30	7.0	68

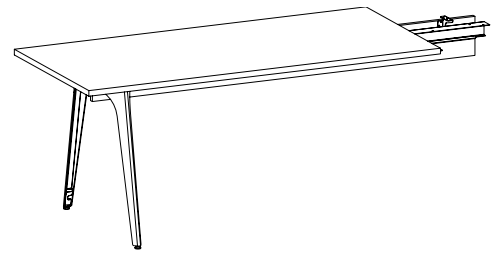

No Grommet



With Grommet

What's Included:

- Worksurface
- Modesty
- Reinforcement bar
- Supporting Leg

Notes:

Options:

Widths: 42" 48", 54", 60", 66"

Depths: 30"

Laminate

Paint Finish

Electrics

V-Leg

Code	Price	H	W	D	Volume	Weight
<b>No Grommet</b>						
H-THVN-294230-L	1704	29	42	30	5.0	61
H-THVN-294830-L	1737	29	48	30	6.0	68
H-THVN-295430-L	1797	29	54	30	6.0	55
H-THVN-296030-L	1828	29	60	30	7.0	61
H-THVN-296630-L	1877	29	66	30	7.0	68
H-THVN-294230-R	1704	29	42	30	5.0	61
H-THVN-294830-R	1737	29	48	30	6.0	68
H-THVN-295430-R	1797	29	54	30	6.0	55
H-THVN-296030-R	1828	29	60	30	7.0	61
H-THVN-296630-R	1877	29	66	30	7.0	68
<b>w/ Grommet</b>						
H-THVH-294230-L	1712	29	42	30	5.0	43
H-THVH-294830-L	1743	29	48	30	6.0	49
H-THVH-295430-L	1805	29	54	30	6.0	55
H-THVH-296030-L	1834	29	60	30	7.0	61
H-THVH-296630-L	1884	29	66	30	7.0	68
H-THVH-294230-R	1712	29	42	30	5.0	43
H-THVH-294830-R	1743	29	48	30	6.0	49
H-THVH-295430-R	1805	29	54	30	6.0	55
H-THVH-296030-R	1834	29	60	30	7.0	61
H-THVH-296630-R	1884	29	66	30	7.0	68

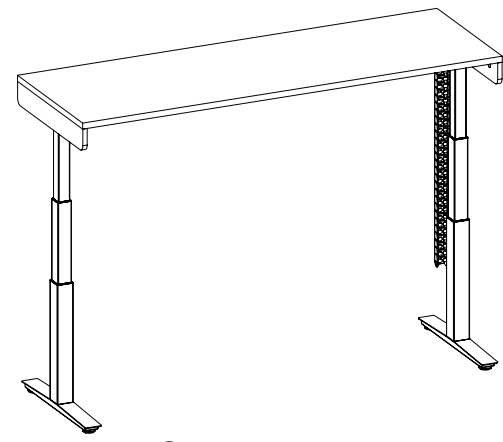

no Grommet

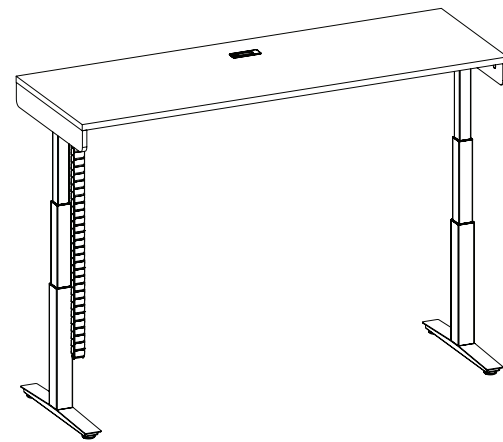

With Grommet

What's Included:

- Height Adjustable Table Base
- e-chain
- Worksurface

How to Specify:

Notes:

Options:

Widths: 60", 66", 72"

Depths: 24", 30"

Laminate

Paint Finish

Electrics

Code	Price	H	W	D	Volume	Weight
<b>No Grommet</b>						
H-HATN-A-6024	2298	26	60	24	3.0	128
H-HATN-A-6624	2321	26	66	24	4.0	132
H-HATN-A-7224	2336	26	72	24	5.0	136
H-HATN-A-6030	2382	26	60	30	4.0	132
H-HATN-A-6630	2407	26	66	30	5.0	136
H-HATN-A-7230	2429	26	72	30	6.0	140
<b>w/ Grommet</b>						
H-HATH-A-6024	2305	26	60	24	3.0	128
H-HATH-A-6624	2325	26	66	24	4.0	132
H-HATH-A-7224	2339	26	72	24	5.0	136
H-HATH-A-6030	2387	26	60	30	4.0	132
H-HATH-A-6630	2411	26	66	30	5.0	136
H-HATH-A-7230	2434	26	72	30	6.0	140

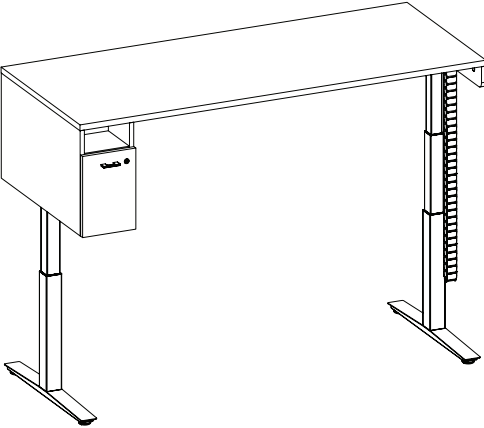

no Grommet

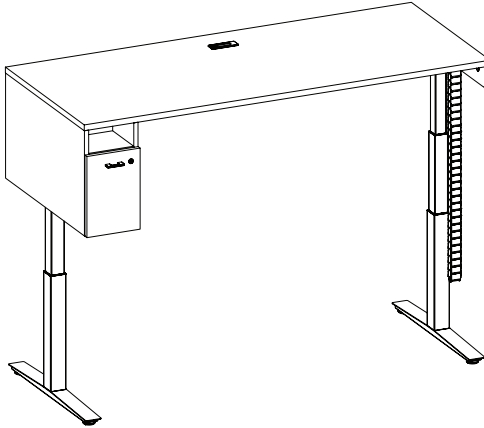

With Grommet

**What's Included:**

- Height Adjustable Table Base
- e-chain
- Worksurface
- Suspended storage

**How to Specify:**

LH storage or RH storage

**Notes:**

**Options:**

Widths: 60", 66", 72"

---

Depths: 24", 30"

---

Laminate

---

Paint Finish

---

Electrics

---

Code	Price	H	W	D	Volume	Weight
<b>No Grommet</b>						
H-HATN-B-6030-L	3133	26	60	30	4.0	132
H-HATN-B-6630-L	3156	26	66	30	5.0	136
H-HATN-B-7230-L	3174	26	72	30	6.0	140
H-HATN-B-6030-R	3133	26	60	30	4.0	132
H-HATN-B-6630-R	3156	26	66	30	5.0	136
H-HATN-B-7230-R	3174	26	72	30	6.0	140
<b>w/ Grommet</b>						
H-HATH-B-6030-L	3137	26	60	30	4.0	132
H-HATH-B-6630-L	3159	26	66	30	5.0	136
H-HATH-B-7230-L	3182	26	72	30	6.0	140
H-HATH-B-6030-R	3137	26	60	30	4.0	132
H-HATH-B-6630-R	3159	26	66	30	5.0	136
H-HATH-B-7230-R	3182	26	72	30	6.0	140

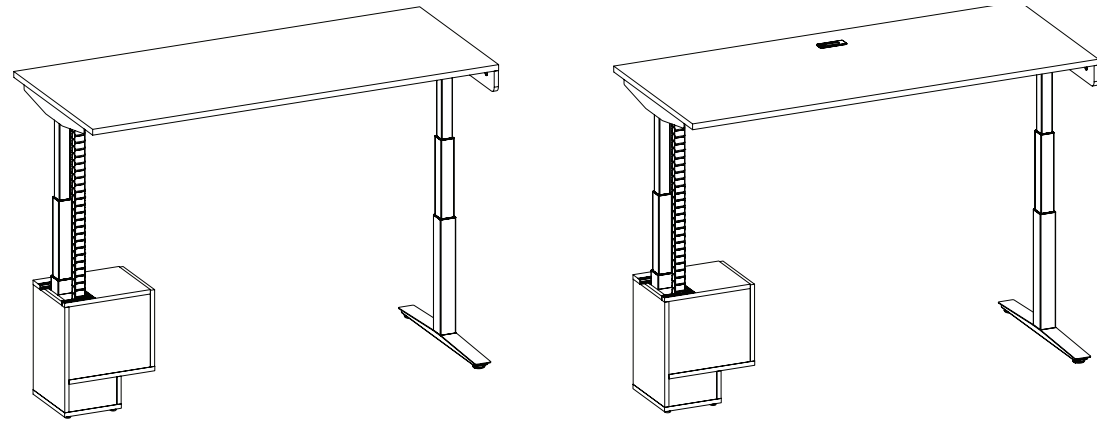

no Grommet

With Grommet

**What's Included:**

- Height Adjustable Table Base
- e-chain
- Worksurface
- Suspended storage
- Credenza Box

**Notes:**

**How to Specify:**

Extension to the RH or Extension to the LH

**Options:**

Widths: 60", 66", 72"

Depths: 24", 30"

Laminate

Paint Finish

Electrics

**No Grommet**

**w/Grommet**

Code	Price	H	W	D	Vol.	Wt.
H-HATN-6-6024-L	3467	26	60	24	3.0	128
H-HATN-6-6624-L	3481	26	66	24	4.0	132
H-HATN-6-7224-L	3500	26	72	24	5.0	136
H-HATN-6-6024-R	3467	26	60	24	3.0	128
H-HATN-6-6624-R	3481	26	66	24	4.0	132
H-HATN-6-7224-R	3500	26	72	24	5.0	136
H-HATN-6-6030-L	3533	26	60	30	4.0	132
H-HATN-6-6630-L	3554	26	66	30	5.0	136
H-HATN-6-7230-L	3577	26	72	30	6.0	140
H-HATN-6-6030-R	3533	26	60	30	4.0	132
H-HATN-6-6630-R	3554	26	66	30	5.0	136
H-HATN-6-7230-R	3577	26	72	30	6.0	140
H-HATN-9-6024-L	3488	26	60	24	3.0	128
H-HATN-9-6624-L	3507	26	66	24	4.0	132
H-HATN-9-7224-L	3526	26	72	24	5.0	136
H-HATN-9-6024-R	3488	26	60	24	3.0	128
H-HATN-9-6624-R	3507	26	66	24	4.0	132
H-HATN-9-7224-R	3526	26	72	24	5.0	136
H-HATN-9-6030-L	3556	26	60	30	4.0	132
H-HATN-9-6630-L	3580	26	66	30	5.0	136
H-HATN-9-7230-L	3601	26	72	30	6.0	140
H-HATN-9-6030-R	3556	26	60	30	4.0	132
H-HATN-9-6630-R	3580	26	66	30	5.0	136
H-HATN-9-7230-R	3601	26	72	30	6.0	140

Code	Price	H	W	D	Vol.	Wt.
H-HATH-6-6024-L	3485	26	60	24	3.0	132
H-HATH-6-6624-L	3497	26	66	24	4.0	132
H-HATH-6-7224-L	3516	26	72	24	5.0	136
H-HATH-6-6024-R	3485	26	60	24	3.0	132
H-HATH-6-6624-R	3497	26	66	24	4.0	132
H-HATH-6-7224-R	3516	26	72	24	5.0	136
H-HATH-6-6030-L	3548	26	60	30	4.0	132
H-HATH-6-6630-L	3573	26	66	30	5.0	136
H-HATH-6-7230-L	3594	26	72	30	6.0	140
H-HATH-6-6030-R	3548	26	60	30	4.0	132
H-HATH-6-6630-R	3573	26	66	30	5.0	136
H-HATH-6-7230-R	3594	26	72	30	6.0	140
H-HATH-9-6024-L	3504	26	60	24	3.0	128
H-HATH-9-6624-L	3522	26	66	24	4.0	132
H-HATH-9-7224-L	3544	26	72	24	5.0	136
H-HATH-9-6024-R	3504	26	60	24	3.0	128
H-HATH-9-6624-R	3522	26	66	24	4.0	132
H-HATH-9-7224-R	3544	26	72	24	5.0	136
H-HATH-9-6030-L	3574	26	60	30	4.0	132
H-HATH-9-6630-L	3596	26	66	30	5.0	136
H-HATH-9-7230-L	3621	26	72	30	6.0	140
H-HATH-9-6030-R	3574	26	60	30	4.0	132
H-HATH-9-6630-R	3596	26	66	30	5.0	136
H-HATH-9-7230-R	3621	26	72	30	6.0	140

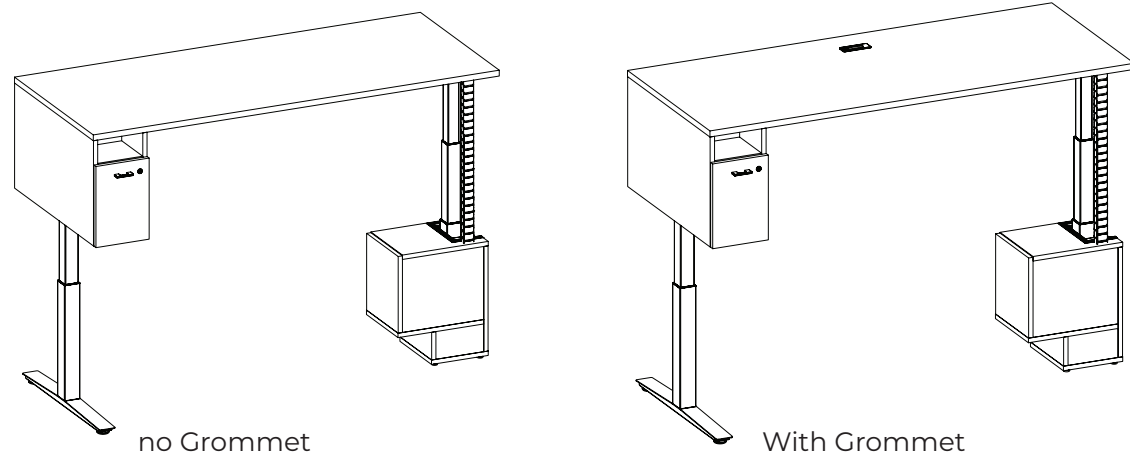

**What's Included:**

- Height Adjustable Table Base
- e-chain
- Worksurface
- Suspended storage
- Credenza Box

**Notes:**

**How to Specify:**

Extension to the RH or Extension to the LH

**Options:**

Widths: 60", 66", 72"

Depths: 24", 30"

Laminate

Paint Finish

Electrics

Code	Price	H	W	D	Volume	Weight
<b>No Grommet</b>						
H-HATN-D6-6030-L	4279	26	60	30	4.0	132
H-HATN-D6-6030-R	4279	26	60	30	4.0	132
H-HATN-D6-6630-L	4289	26	66	30	5.0	136
H-HATN-D6-6630-R	4289	26	66	30	5.0	136
H-HATN-D6-7230-L	4312	26	72	30	6.0	140
H-HATN-D6-7230-R	4312	26	72	30	6.0	140
H-HATN-D9-6030-L	4298	26	60	30	4.0	132
H-HATN-D9-6030-R	4298	26	60	30	4.0	132
H-HATN-D9-6630-L	4319	26	66	30	5.0	136
H-HATN-D9-6630-R	4319	26	66	30	5.0	136
H-HATN-D9-7230-L	4339	26	72	30	6.0	140
H-HATN-D9-7230-R	4339	26	72	30	6.0	140
<b>w/ Grommet</b>						
H-HATH-D6-6030-L	4298	26	60	30	4.0	132
H-HATH-D6-6630-L	4304	26	66	30	5.0	136
H-HATH-D6-7230-L	4327	26	72	30	6.0	140
H-HATH-D6-6030-R	4298	26	60	30	4.0	132
H-HATH-D6-6630-R	4304	26	66	30	5.0	136
H-HATH-D6-7230-R	4327	26	72	30	6.0	140
H-HATH-D9-6030-L	4312	26	60	30	4.0	132
H-HATH-D9-6630-L	4333	26	66	30	5.0	136
H-HATH-D9-7230-L	4359	26	72	30	6.0	140
H-HATH-D9-6030-R	4312	26	60	30	4.0	132
H-HATH-D9-6630-R	4333	26	66	30	5.0	136
H-HATH-D9-7230-R	4359	26	72	30	6.0	140

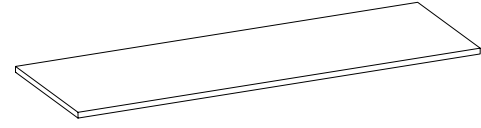

no Grommet

**What's Included:**

- Worksurface
- Grommet cover if grommet option is selected

**How to Specify:**

**Notes:**

Woodgrain runs side-to-side

**Options:**

Widths: 24", 30", 36", 42", 48", 54", 60", 66", 72", 78", 84"

Depths: 19", 24", 30", 36"

Laminate

Paint Finish

Electrics

Code	Price	H	W	D	Volume	Weight
H-WS0N-2419	288	1	24	19	0.4	8
H-WS0N-3019	313	1	30	19	0.4	10
H-WS0N-3619	323	1	36	19	0.4	11
H-WS0N-4219	374	1	42	19	0.5	13
H-WS0N-4819	395	1	48	19	0.5	15
H-WS0N-5419	476	1	54	19	1.0	17
H-WS0N-6019	517	1	60	19	1.0	19
H-WS0N-6619	589	1	66	19	1.0	21
H-WS0N-7219	629	1	72	19	1.0	23
H-WS0N-7819	686	1	78	19	1.0	25
H-WS0N-8419	741	1	84	19	1.0	25
H-WS0N-2424	305	1	24	24	1.0	10
H-WS0N-3024	322	1	30	24	1.0	12
H-WS0N-3624	336	1	36	24	1.0	14
H-WS0N-4224	399	1	42	24	1.0	17
H-WS0N-4824	427	1	48	24	1.0	19
H-WS0N-5424	522	1	54	24	1.0	22
H-WS0N-6024	552	1	60	24	1.0	24
H-WS0N-6624	611	1	66	24	1.0	26
H-WS0N-7224	642	1	72	24	1.0	29
H-WS0N-7824	706	1	78	24	1.0	31
H-WS0N-8424	760	1	84	24	1.0	34
H-WS0N-3630	413	1	36	30	1.0	18
H-WS0N-4230	450	1	42	30	1.0	21
H-WS0N-4830	485	1	48	30	1.0	24
H-WS0N-5430	549	1	54	30	1.0	27
H-WS0N-6030	581	1	60	30	1.0	30
H-WS0N-6630	666	1	66	30	1.0	33
H-WS0N-7230	682	1	72	30	1.0	36
H-WS0N-7830	751	1	78	30	1.0	39
H-WS0N-8430	811	1	84	30	1.0	42
H-WS0N-5436	574	1	54	36	1.0	32
H-WS0N-6036	610	1	60	36	1.0	36
H-WS0N-6636	700	1	66	36	1.0	40
H-WS0N-7236	718	1	72	36	1.0	43
H-WS0N-7836	783	1	78	36	1.0	47
H-WS0N-8436	850	1	84	36	1.0	50

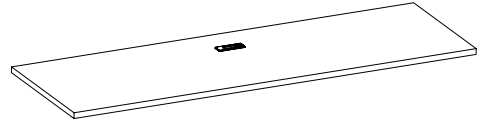

w/ Grommet

**What's Included:**

- Worksurface
- Grommet cover if grommet option is selected

**How to Specify:**

**Notes:**

- Woodgrain runs side-to-side
- Grommet in the center back

**Options:**

Widths: 24", 30", 36", 42", 48", 54", 60", 66", 72", 78", 84"

Depths: 19", 24", 30", 36"

Laminate

Paint Finish

Electrics

Code	Price	H	W	D	Volume	Weight
H-WS0H-2419	317	1	24	19	0.4	8
H-WS0H-3019	339	1	30	19	0.4	10
H-WS0H-3619	350	1	36	19	0.4	11
H-WS0H-4219	399	1	42	19	0.5	13
H-WS0H-4819	421	1	48	19	0.5	15
H-WS0H-5419	499	1	54	19	1.0	17
H-WS0H-6019	542	1	60	19	1.0	19
H-WS0H-6619	616	1	66	19	1.0	21
H-WS0H-7219	658	1	72	19	1.0	23
H-WS0H-7819	712	1	78	19	1.0	25
H-WS0H-8419	770	1	84	19	1.0	27
H-WS0H-2424	336	1	24	24	1.0	10
H-WS0H-3024	348	1	30	24	1.0	12
H-WS0H-3624	362	1	36	24	1.0	14
H-WS0H-4224	424	1	42	24	1.0	17
H-WS0H-4824	459	1	48	24	1.0	19
H-WS0H-5424	549	1	54	24	1.0	22
H-WS0H-6024	576	1	60	24	1.0	24
H-WS0H-6624	640	1	66	24	1.0	26
H-WS0H-7224	667	1	72	24	1.0	29
H-WS0H-7824	728	1	78	24	1.0	31
H-WS0H-8424	787	1	84	24	1.0	34
H-WS0H-3630	436	1	36	30	1.0	18
H-WS0H-4230	477	1	42	30	1.0	21
H-WS0H-4830	516	1	48	30	1.0	24
H-WS0H-5430	574	1	54	30	1.0	27
H-WS0H-6030	607	1	60	30	1.0	30
H-WS0H-6630	694	1	66	30	1.0	33
H-WS0H-7230	712	1	72	30	1.0	36
H-WS0H-7830	774	1	78	30	1.0	39
H-WS0H-8430	834	1	84	30	1.0	42
H-WS0H-5436	600	1	54	36	1.0	32
H-WS0H-6036	637	1	60	36	1.0	36
H-WS0H-6636	720	1	66	36	1.0	40
H-WS0H-7236	742	1	72	36	1.0	43
H-WS0H-7836	806	1	78	36	1.0	47
H-WS0H-8436	876	1	84	36	1.0	50

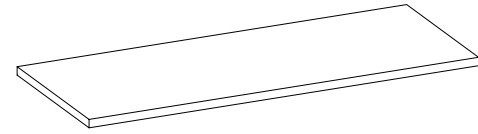

no Grommet

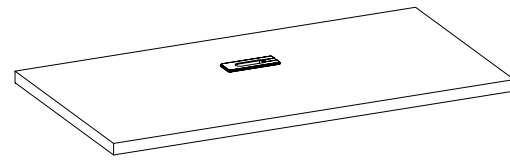

With Grommet

**What's Included:**

- Bridge surface
- Grommet cover if grommet option is selected

**How to Specify:**

**Notes:**

Woodgrain runs front to back  
 Grommet in the center back

**Options:**

Widths: 36", 42", 48"

Depths: 19"

Laminate

Paint Finish

Electrics

Code	Price	H	W	D	Vol.	Wt.
<b>No Grommet</b>						
H-WB0N-3619	323	1	36	19	0.4	11
H-WB0N-4219	374	1	42	19	0.5	13
H-WB0N-4819	395	1	48	19	0.5	15
H-WB0N-3624	336	1	36	24	1.0	14
H-WB0N-4224	399	1	42	24	1.0	17
H-WB0N-4824	427	1	48	24	1.0	19
<b>w/ Grommet</b>						
H-WB0H-3619	350	1	36	19	0.4	11
H-WB0H-4219	399	1	42	19	0.5	13
H-WB0H-4819	421	1	48	19	0.5	15
H-WB0H-3624	362	1	36	24	1.0	14
H-WB0H-4224	424	1	42	24	1.0	17
H-WB0H-4824	459	1	48	24	1.0	19

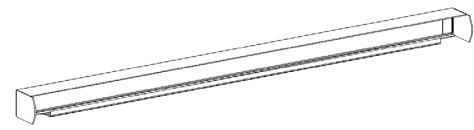

A-Leg

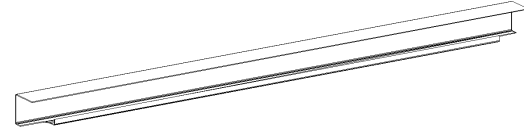

V-Leg

**What's Included:**

- Reinforcement bar and screws

**How to Specify:**

A-leg reinforcement bar needs to cover the full span between 2 A-legs or 1 A-leg to surface support storage

V-leg reinforcement bar does not connect to legs

**Notes:**

Bridge surfaces are supported by V-leg reinforcement bars

**Options:**

Widths: 24", 33", 39", 42", 45", 48", 51", 54", 57", 60", 63", 66", 69", 72", 78"

Depths: 2"

Laminate

Paint Finish

Electrics

Code	Price	H	W	D	Vol.	Wt.
<b>A-Leg</b>						
H-HRBA-24	310	2	24	2	0.2	6
H-HRBA-33	319	2	33	2	0.3	8
H-HRBA-39	323	2	39	2	0.3	10
H-HRBA-42	344	2	42	2	0.4	10
H-HRBA-45	355	2	45	2	0.4	11
H-HRBA-48	359	2	48	2	0.4	12
H-HRBA-51	375	2	51	2	0.4	13
H-HRBA-54	385	2	54	2	0.5	13
H-HRBA-57	396	2	57	2	1.0	14
H-HRBA-60	402	2	60	2	1.0	15
H-HRBA-63	407	2	63	2	1.0	16
H-HRBA-66	421	2	66	2	1.0	16
H-HRBA-69	425	2	69	2	1.0	17
H-HRBA-72	451	2	72	2	1.0	18
H-HRBA-78	453	2	78	2	1.0	19
<b>V-Leg</b>						
H-HRBV-24	144	2	24	2	0.2	6
H-HRBV-33	147	2	33	2	0.3	8
H-HRBV-39	155	2	39	2	0.3	10
H-HRBV-42	172	2	42	2	0.4	10
H-HRBV-45	185	2	45	2	0.4	11
H-HRBV-48	187	2	48	2	0.4	12
H-HRBV-51	198	2	51	2	0.4	13
H-HRBV-54	216	2	54	2	0.5	13
H-HRBV-57	222	2	57	2	1.0	14
H-HRBV-60	229	2	60	2	1.0	15
H-HRBV-63	233	2	63	2	1.0	16
H-HRBV-66	247	2	66	2	1.0	16
H-HRBV-69	254	2	69	2	1.0	17
H-HRBV-72	278	2	72	2	1.0	18
H-HRBV-78	279	2	78	2	1.0	19

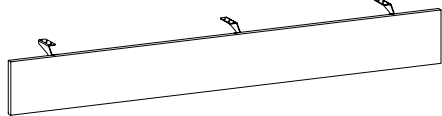

Modesty

**What's Included:**

- 6"H laminate modesty and mounting brackets

**How to Specify:**

**Notes:**

woodgrain on the modesty runs horizontally

**Options:**

Widths:

Depths:

Laminate

Paint Finish

Electrics

Code	Price	H	W	D	Vol.	Wt.
H-TM-0640	310	6	40	1	0.3	5
H-TM-0643	317	6	43	1	0.3	5
H-TM-0646	319	6	46	1	0.3	6
H-TM-0649	322	6	49	1	0.3	6
H-TM-0652	324	6	52	1	0.4	6
H-TM-0653	326	6	53	1	0.4	6
H-TM-0655	327	6	55	1	0.4	7
H-TM-0658	335	6	55	1	0.4	7
H-TM-0659	336	6	59	1	0.4	7
H-TM-0661	337	6	61	1	0.4	7
H-TM-0664	340	6	64	1	0.4	8
H-TM-0665	342	6	65	1	0.4	8
H-TM-0666	344	6	66	1	0.4	8
H-TM-0667	346	6	67	1	0.5	8
H-TM-0670	347	6	67	1	0.5	8
H-TM-0671	348	6	71	1	0.5	9
H-TM-0672	349	6	72	1	0.5	9
H-TM-0673	350	6	73	1	0.5	9
H-TM-0677	354	6	77	1	1.0	9
H-TM-0678	355	6	77	1	1.0	9
H-TM-0679	359	6	79	1	1.0	9

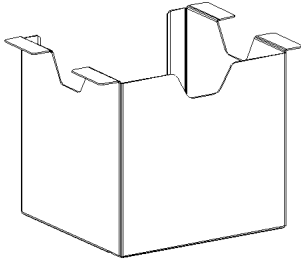

Support Box

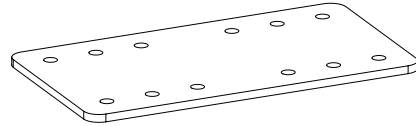

WS to WS Flush Plate

**What's Included:**

- Worksurface support & hardware

**How to Specify:**

A-leg reinforcement bar needs to cover the full span between 2 A-legs or 1 A-leg to surface support storage

V-leg reinforcement bar does not connect to legs

**Notes:**

Bridge surfaces are supported by V-leg reinforcement bars

**Options:**

- Widths: 24", 33", 39", 42", 45", 48", 51", 54", 57", 60", 63", 66", 69", 72", 78"
- Depths: 2"
- Laminate
- Paint Finish
- Electrics

Code	Price	H	W	D	Vol.	Wt.
<b>Support Box</b>						
H-HBOX	169	2	78	2	1.0	19
<b>WS to WS Flush Plate</b>						
H-HFP	52	2	78	2	1.0	19

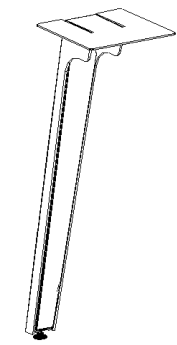

Single A-Leg

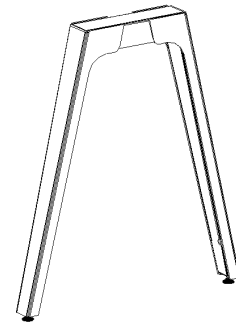

Double A-Leg

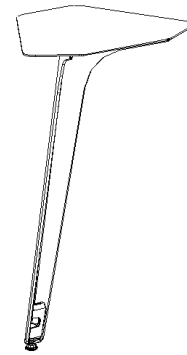

Single V-Leg

**What's Included:**

- Table Support Leg & Hardware

**How to Specify:**

**Notes:**

One of the A-Legs will come with an infill with a small hole to run wires out the bottom

**Options:**

Widths: 2"

Depths: 2"

Laminate

Paint Finish

Electrics

Code	Price	H	W	D	Volume	Weight
<b>A-Leg</b>						
Single/Seated Height						
H-HTA1-28	481	28	2	2	1.0	5
Double/Seated Height						
H-HTA2-2824	743	28	2	2	1.0	5
H-HTA2-2830	758	28	2	2	1.0	6
H-HTA2-2836	768	28	2	2	1.0	7
H-HTA2-2842	849	28	2	2	1.0	8
H-HTA2-2848	859	28	2	2	1.0	9
Double/Standing Height						
H-HTA2-4136	944	41	2	2	1.0	7
H-HTA2-4142	1020	41	2	2	1.0	8
H-HTA2-4148	1036	41	2	2	1.0	9
<b>V-Leg</b>						
Single/Seated Height						
H-HTV1-28	424	28	2	2	1.0	5
Single/Standing Height						
H-HTV1-41	506	41	2	2	1.0	7



# Halifax Pricebook January 2026 Storage

Pedestal	
Underdesk	106
Underdesk w/ hinged Door	108
Mobile	110
Lateral	
Underdesk & Freestanding Box/File	112
Single File	114
Freestanding File Drawers	116
Freestanding w/ Shelf	118
Underdesk w/ Shelf	119
Low Credenza	
Hinged Doors	120
Sliding Doors	122
Open & Lateral	124
End Cap	126
High Credenza	
Hinged Door	128
Lateral & Doors	130
Open & Lateral	132
Shelf Above Sliding Door	134
Open Shelf Above Lateral	136
Credenza   Raised Back	137
Credenza Open End Box w/ Top	138
Cushion	140
Gallery Wall	142
Mobile Credenza   Open & Lateral	144
Hutch	
Laminate w/ Hinged doors	146
Laminate w/ Sliding Door	148
Metal w/ Hinged doors	150
Metal w/ Sliding Door	152
Wall Mounted w/ Hinged door	154
Wall mounted w/ Sliding Door	156
Accent Shelf	158
Combo Cabinet   Open Shelf/File Drawer	160
Combo Cabinet   Lateral Storage	162
Locker Tower w/shelves	164
Locker w/ side access	166
Bookcase	168
Audio Visual Unit	170
Support	171
Audio Visual   Mounted Video Table	172

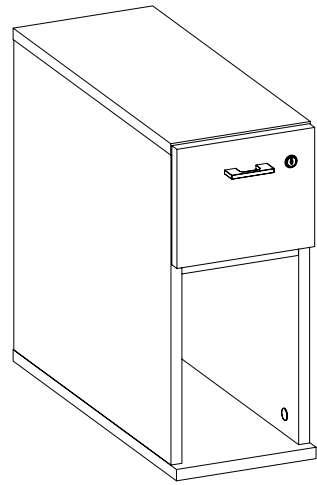

Box/Open

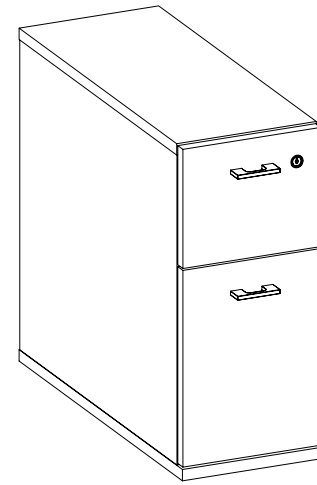

Box/File

**What's Included:**

- Underdesk Box/Open Pedestal or
- Underdesk Box/File Pedestal

**How to Specify:**

- Legs to be specified separately

**Notes:**

Only mckay handles are available.

**Options:**

Widths: 10", 16"

Depths: 19", 24", 30"

Laminate

Paint Finish

Electrics

**Box/Open**

Code	Price	H	W	D	Volume	Weight
H-FPBO-281019	876	28	10	19	3.0	20
H-FPBO-281619	941	28	16	19	4.0	34
H-FPBO-281624	996	28	16	24	5.0	43
H-FPBO-281024	915	28	10	19	3.0	26
H-FPBO-281030	971	28	10	19	4.0	32
H-FPBO-281630	1062	28	16	30	7.0	54

**Box/File**

Code	Price	H	W	D	Volume	Weight
H-FPBF-281019	1149	28	9.5	19	3.0	22
H-FPBF-281619	1186	28	16	19	5.0	39.5
H-FPBF-281024	1183	28	9.5	24	3.2	25.54
H-FPBF-281624	1207	28	16	24	5.4	43.01
H-FPBF-281030	1199	28	9.5	30	4.0	31.92
H-FPBF-281630	1224	28	16	30	6.7	53.76

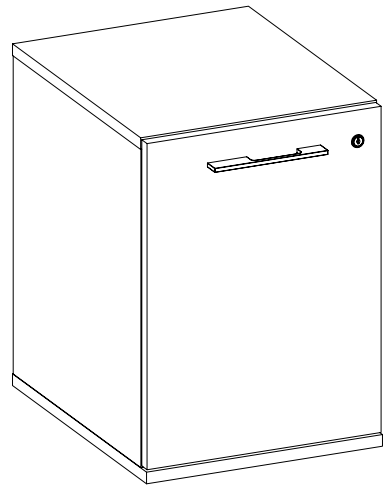

Left hand hinged door

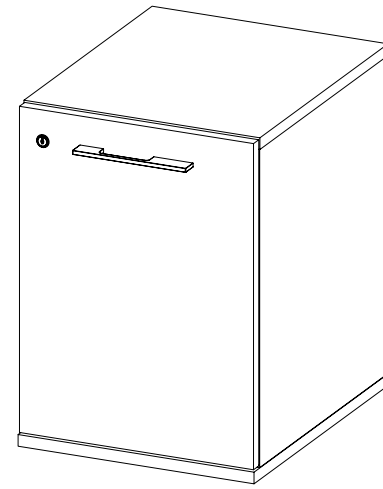

Right hand hinged door

**What's Included:**

- Underdesk Storage Pedestal

**How to Specify:**

- Legs to be specified separately

**Notes:**

**Options:**

Widths: 10", 16"

Depths: 19", 24", 30"

Laminate

Paint Finish

Electrics

Code	Price	H	W	D	Volume	Weight
H-FPH0-281019-L	850	28	10	19	3.0	20
H-FPH0-281019-R	850	28	10	19	3.0	20
H-FPH0-281619-L	915	28	16	19	4.0	34
H-FPH0-281619-R	915	28	16	19	4.0	34
H-FPH0-281024-L	891	28	10	24	3.0	26
H-FPH0-281024-R	891	28	10	24	3.0	26
H-FPH0-281624-L	971	28	16	24	5.0	43
H-FPH0-281624-R	971	28	16	24	5.0	43
H-FPH0-281030-L	941	28	10	30	3.0	32
H-FPH0-281030-R	941	28	10	30	3.0	32
H-FPH0-281630-L	1028	28	16	30	7.0	53
H-FPH0-281630-R	1028	28	16	30	7.0	53

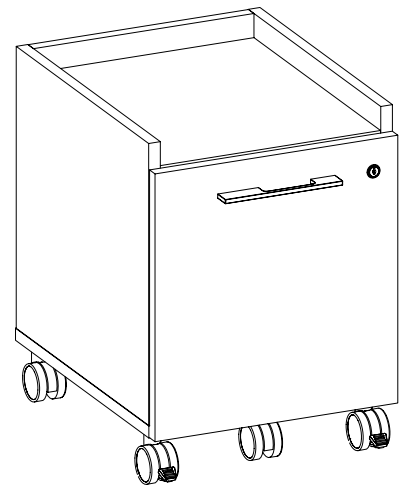

File

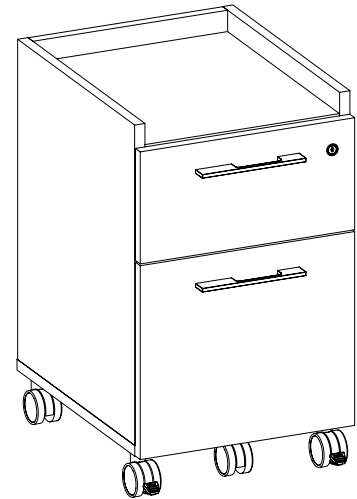

Box/File

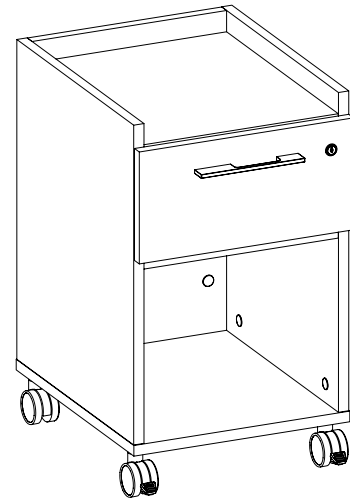

Box Drawer/  
Open Bottom

**What's Included:**

- Mobile Pedestal

**How to Specify:**

- Legs to be specified separately

**Notes:**

**Options:**

Widths: 16"

Depths: 19", 20"

Laminate

Paint Finish

Electrics

Code	Price	H	W	D	Volume	Weight
<b>File</b>						
H-FP0F-221620-M	1027	22	16	19	4.0	34
<b>Box/File</b>						
H-FPBF-271620-M	1092	27	16	19	4.0	34
<b>Box Drawer/Open Bottom</b>						
H-FPBO-271620-M	1085	27	16	20	4.0	34

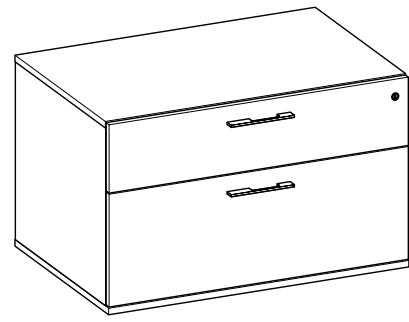

Underdesk

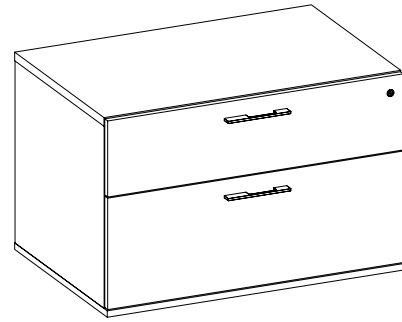

Freestanding

**What's Included:**

- Underdesk Box/File Lateral

**How to Specify:**

- Legs to be specified separately

**Notes:**

**Options:**

Widths: 24", 30", 36", 42"

Depths: 19", 24"

Laminate

Paint Finish

Electrics

Code	Price	H	W	D	Volume	Weight
<b>Underdesk</b>						
H-FLBU-282419	1444	28	24	19	8.0	55
H-FLBU-283019	1518	28	30	19	8.0	60
H-FLBU-283619	1664	28	36	19	10.0	72
H-FLBU-284219	1678	28	42	19	12.0	84
H-FLBU-282424	1495	28	24	24	9.0	59
H-FLBU-283024	1575	28	30	24	8.0	60
H-FLBU-283624	1822	28	36	24	10.0	72
H-FLBU-284224	1752	28	42	24	12.0	84
<b>Freestanding</b>						
H-FLBF-292419	1692	29	24	19	8.0	56
H-FLBF-293019	1782	29	30	19	8.0	60
H-FLBF-293619	1856	29	36	19	10.0	72
H-FLBF-294219	1928	29	42	19	12.0	84
H-FLBF-292424	1742	29	24	24	9.0	60
H-FLBF-293024	1834	29	30	24	10.0	76
H-FLBF-293624	1915	29	36	24	13.0	91
H-FLBF-294224	1993	29	42	24	15.0	106



Single File

**What's Included:**

- Single Lateral

**How to Specify:**

- Legs to be specified separately

**Notes:**

**Options:**

Widths: 24", 30", 36", 42"

Depths: 19", 24"

Laminate

Paint Finish

Electrics

Code	Price	H	W	D	Volume	Weight
H-FL1F-202419	1143	20	24	19	6.0	42
H-FL1F-203019	1204	20	30	19	6.0	46
H-FL1F-203619	1265	20	36	19	7.0	55
H-FL1F-204219	1330	20	42	19	8.0	64
H-FL1F-202424	1195	20	24	24	6.0	54
H-FL1F-203024	1256	20	30	24	7.0	58
H-FL1F-203624	1323	20	36	24	9.0	69
H-FL1F-204224	1397	20	42	24	10.0	81

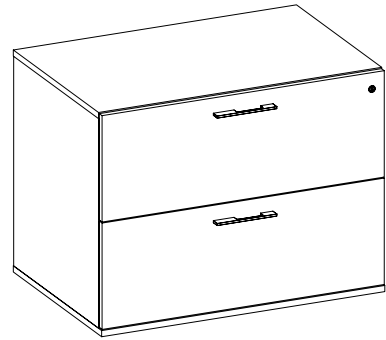

2 Drawers



3 Drawers

**What's Included:**

- Freestanding Lateral

**How to Specify:**

- Legs to be specified separately

**Notes:**

**Options:**

Widths: 24", 30", 36", 42"

Depths: 19", 24"

Laminate

Paint Finish

Electrics

Code	Price	H	W	D	Volume	Weight
<b>2 Drawer</b>						
H-FL2F-342419	1666	34	24	19	10.0	72
H-FL2F-343019	1754	34	30	19	10.0	78
H-FL2F-343619	1819	34	36	19	93.0	93
H-FL2F-344219	1949	34	42	19	14.0	109
H-FL2F-342424	1709	34	24	24	10.0	79
H-FL2F-343024	1796	34	30	24	12.0	98
H-FL2F-343624	1933	34	36	24	15.0	118
H-FL2F-344224	2071	34	42	24	17.0	137
<b>3 Drawer</b>						
H-FL3F-472419	2692	47	24	19	13.0	98
H-FL3F-473019	2834	47	30	19	13.0	107
H-FL3F-473619	2934	47	36	19	16.0	129
H-FL3F-474219	3159	47	47	19	19.0	150
H-FL3F-472424	2752	47	24	24	14.0	118
H-FL3F-473024	2896	47	30	24	17.0	135
H-FL3F-473624	3138	47	36	24	20.0	162
H-FL3F-474224	3381	47	47	19	24.0	190



Freestanding w/ Shelf

**What's Included:**

- Underdesk w/shelf

**How to Specify:**

- Legs to be specified separately

**Options:**

Widths: 24",30", 36", 42"

Depths: 19", 24"

Height: 29"

Laminate

Paint Finish

Electrics

**Notes:**

Code	Price	H	W	D	Volume	Weight
H-FLSF-292419	1244	29	24	19	8.0	56
H-FLSF-293019	1310	29	30	19	8.0	60
H-FLSF-293619	1390	29	36	19	10.0	72
H-FLSF-294219	1472	29	42	19	12.0	84
H-FLSF-292424	1312	29	24	19	9.0	60
H-FLSF-293024	1382	29	30	24	10.0	76
H-FLSF-293624	1545	29	36	24	13.0	91
H-FLSF-294224	1559	29	42	19	15.0	106



Underdesk w/ Shelf

**What's Included:**

- Underdesk w/shelf

**How to Specify:**

- Legs to be specified separately

**Options:**

Widths: 24",30", 36", 42"

Depths: 19", 24"

Height: 29"

Laminate

Paint Finish

Electrics

**Notes:**

Code	Price	H	W	D	Volume	Weight
H-FLSU-282419	1211	28	24	24	8.3	51
H-FLSU-282424	1275	28	24	19	8.3	56
H-FLSU-283019	1231	28	30	24	8.3	55.11
H-FLSU-283024	1299	28	30	19	8.3	60.14
H-FLSU-283619	1306	28	36	24	8.3	67.23
H-FLSU-283624	1449	28	36	19	8.3	72.56
H-FLSU-284219	1383	28	42	24	8.3	79.15
H-FLSU-284224	1465	28	42	19	8.3	92.13

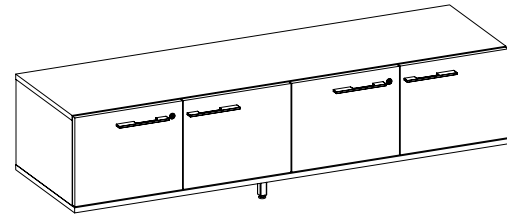

no Grommet

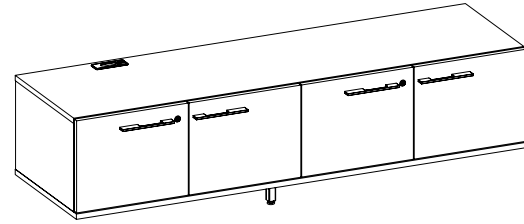

With Grommet

**What's Included:**

- Low Credenza

**How to Specify:**

- Legs to be specified separately

**Options:**

Widths: 30", 36", 42", 48", 54", 60", 66", 72", 78", 84"

Depths: 16", 19"

Height: 20"

Laminate

Paint Finish

Electrics

**Notes:**

**No Grommet**

Code	Price	H	W	D	Vol.	Wt.
H-CRHH-203016	904	20	30	16	8.0	35
H-CRHH-203616	953	20	36	16	10.0	42
H-CRHH-204216	1061	20	42	16	11.0	50
H-CRHH-204816	1110	20	48	16	13.0	57
H-CRHH-205416	1209	20	54	16	14.0	65
H-CRHH-206016	1317	20	60	16	16.0	73
H-CRHH-206616	1368	20	66	16	17.0	80
H-CRHH-207216	1416	20	72	16	19.0	88
H-CRHH-207816	1465	20	78	16	21.0	95
H-CRHH-208416	1516	20	84	16	22.0	103

Code	Price	H	W	D	Vol.	Wt.
H-CRHH-204219	1164	20	42	16	11.0	53
H-CRHH-203019	993	20	30	19	8.0	38
H-CRHH-203619	1046	20	36	19	10.0	46
H-CRHH-204819	1216	20	48	19	13.0	61
H-CRHH-205419	1324	20	54	19	14.0	68
H-CRHH-206019	1444	20	60	19	16.0	76
H-CRHH-206619	1495	20	66	19	17.0	84
H-CRHH-207219	1551	20	72	19	19.0	91
H-CRHH-207819	1609	20	78	19	21.0	99
H-CRHH-208419	1662	20	84	16	22.0	106

**w/Grommet - left hand**

Code	Price	H	W	D	Vol.	Wt.
H-CRHH-203016-L	1063	20	30	16	8.0	35
H-CRHH-203616-L	1112	20	36	16	10.0	42
H-CRHH-204216-L	1357	20	42	16	11.0	50
H-CRHH-204816-L	1404	20	48	16	13.0	57
H-CRHH-205416-L	1559	20	54	16	14.0	65
H-CRHH-206016-L	1609	20	60	16	16.0	73
H-CRHH-206616-L	1838	20	66	16	17.0	80
H-CRHH-207216-L	1885	20	72	16	19.0	88
H-CRHH-207816-L	1933	20	78	16	21.0	95
H-CRHH-208416-L	1981	20	84	16	22.0	103
H-CRHH-203019-L	1093	20	30	19	8.0	38
H-CRHH-203619-L	1143	20	36	19	10.0	46
H-CRHH-204219-L	1404	20	42	16	11.0	53
H-CRHH-204819-L	1454	20	48	19	13.0	61
H-CRHH-205419-L	1615	20	54	19	14.0	68
H-CRHH-206019-L	1663	20	60	19	16.0	76
H-CRHH-206619-L	1899	20	66	19	17.0	84
H-CRHH-207219-L	1949	20	72	19	19.0	91
H-CRHH-207819-L	2007	20	78	19	21.0	99
H-CRHH-208419-L	2054	20	84	16	22.0	106

**w/Grommet - right hand**

Code	Price	H	W	D	Vol.	Wt.
H-CRHH-203016-R	1063	20	30	16	8.0	35
H-CRHH-203616-R	1112	20	36	16	10.0	42
H-CRHH-204216-R	1357	20	42	16	11.0	50
H-CRHH-204816-R	1404	20	48	16	13.0	57
H-CRHH-205416-R	1559	20	54	16	14.0	65
H-CRHH-206016-R	1609	20	60	16	16.0	73
H-CRHH-206616-R	1838	20	66	16	17.0	80
H-CRHH-207216-R	1885	20	72	16	19.0	88
H-CRHH-207816-R	1933	20	78	16	21.0	95
H-CRHH-208416-R	1981	20	84	16	22.0	103
H-CRHH-204219-R	1404	20	42	16	11.0	53
H-CRHH-208419-R	2054	20	84	16	22.0	106
H-CRHH-203019-R	1093	20	30	19	8.0	38
H-CRHH-203619-R	1143	20	36	19	10.0	46
H-CRHH-204819-R	1454	20	48	19	13.0	61
H-CRHH-205419-R	1615	20	54	19	14.0	68
H-CRHH-206019-R	1663	20	60	19	16.0	76
H-CRHH-206619-R	1899	20	66	19	17.0	84
H-CRHH-207219-R	1949	20	72	19	19.0	91
H-CRHH-207819-R	2007	20	78	19	21.0	99

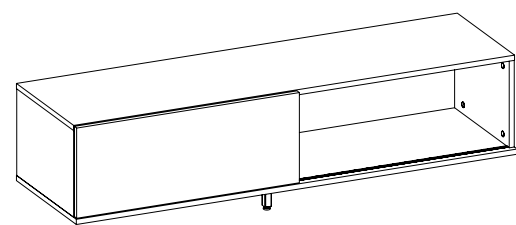

no Grommet

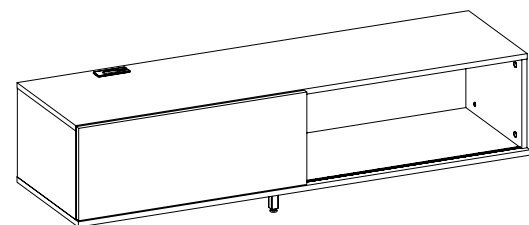

With Grommet

**What's Included:**

- Low Credenza

**How to Specify:**

- Legs to be specified separately

**Notes:**

**Options:**

Widths: 30", 36", 42", 48", 54", 60", 66", 72", 78", 84"

Depths: 16", 19"

Height:

Laminate

Paint Finish

Electrics

**No Grommet**

Code	Price	H	W	D	Vol.	Wt.
H-CRSD-203016	1310	20	30	16	8.0	28
H-CRSD-203616	1360	20	36	16	10.0	35
H-CRSD-204216	1419	20	42	16	11.0	41
H-CRSD-204816	1472	20	48	16	13.0	48
H-CRSD-205416	1638	20	54	16	14.0	54
H-CRSD-206016	1697	20	60	16	16.0	61
H-CRSD-206616	1751	20	66	16	17.0	66
H-CRSD-207216	1808	20	72	16	19.0	74
H-CRSD-207816	1858	20	78	16	21.0	80
H-CRSD-208416	1919	20	84	16	22.0	86

Code	Price	H	W	D	Vol.	Wt.
H-CRSD-203619	1402	20	36	19	10.0	39
H-CRSD-203019	1344	20	30	19	8.0	33
H-CRSD-204219	1463	20	42	19	11.0	46
H-CRSD-204819	1522	20	48	19	13.0	52
H-CRSD-205419	1691	20	54	19	14.0	59
H-CRSD-206019	1751	20	60	19	16.0	65
H-CRSD-206619	1808	20	66	19	17.0	72
H-CRSD-207219	1868	20	72	19	19.0	78
H-CRSD-207819	1937	20	78	19	21.0	85
H-CRSD-208419	1995	20	84	19	22.0	91

**No Grommet- left hand**

Code	Price	H	W	D	Vol.	Wt.
H-CRSD-203016-L	1389	20	30	16	8.0	28
H-CRSD-203616-L	1446	20	36	16	10.0	35
H-CRSD-204216-L	1505	20	42	16	11.0	41
H-CRSD-204816-L	1565	20	48	16	13.0	48
H-CRSD-205416-L	1743	20	54	16	14.0	54
H-CRSD-206016-L	1802	20	60	16	16.0	61
H-CRSD-206616-L	1864	20	66	16	17.0	66
H-CRSD-207216-L	1923	20	72	16	19.0	74
H-CRSD-207816-L	1979	20	78	16	21.0	80
H-CRSD-208416-L	2040	20	84	16	22.0	86
H-CRSD-203019-L	1431	20	30	19	8.0	33
H-CRSD-203619-L	1490	20	36	19	10.0	39
H-CRSD-204219-L	1555	20	42	19	11.0	46
H-CRSD-204819-L	1616	20	48	19	13.0	52
H-CRSD-205419-L	1794	20	54	19	14.0	59
H-CRSD-206019-L	1864	20	60	19	16.0	65
H-CRSD-206619-L	1923	20	66	19	17.0	72
H-CRSD-207219-L	1988	20	72	19	19.0	78
H-CRSD-207819-L	2047	20	78	19	21.0	85
H-CRSD-208419-L	2116	20	84	19	22.0	91

**w/Grommet- right hand**

Code	Price	H	W	D	Vol.	Wt.
H-CRSD-203616-R	1446	20	36	16	10.0	35
H-CRSD-203016-R	1389	20	30	16	8.0	28
H-CRSD-204216-R	1505	20	42	16	11.0	41
H-CRSD-204816-R	1565	20	48	16	13.0	48
H-CRSD-205416-R	1743	20	54	16	14.0	54
H-CRSD-206016-R	1802	20	60	16	16.0	61
H-CRSD-206616-R	1864	20	66	16	17.0	66
H-CRSD-207216-R	1923	20	72	16	19.0	74
H-CRSD-207816-R	1979	20	78	16	21.0	80
H-CRSD-208416-R	2040	20	84	16	22.0	86
H-CRSD-203019-R	1431	20	30	19	8.0	33
H-CRSD-203619-R	1490	20	36	19	10.0	39
H-CRSD-204219-R	1555	20	42	19	11.0	46
H-CRSD-204819-R	1616	20	48	19	13.0	52
H-CRSD-205419-R	1794	20	54	19	14.0	59
H-CRSD-206019-R	1864	20	60	19	16.0	65
H-CRSD-206619-R	1923	20	66	19	17.0	72
H-CRSD-207219-R	1988	20	72	19	19.0	78
H-CRSD-207819-R	2047	20	78	19	21.0	85
H-CRSD-208419-R	2116	20	84	19	22.0	91

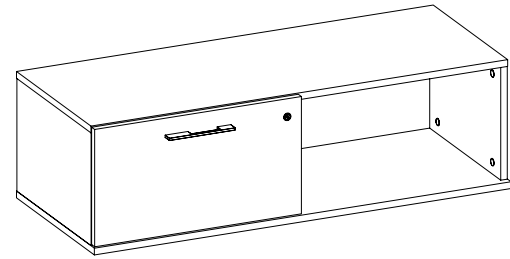

Lateral/Open No Grommet

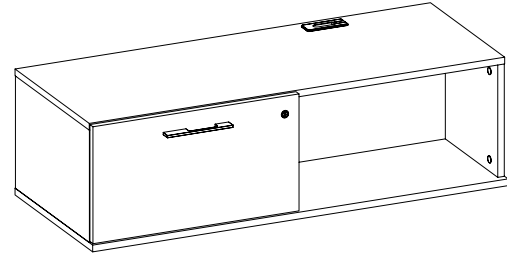

Lateral/Open With Grommet

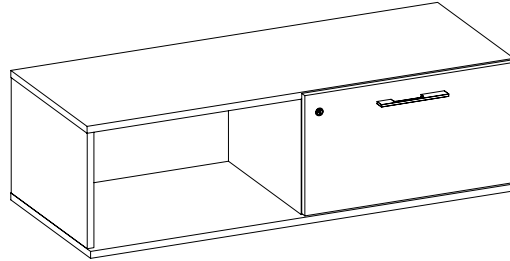

Open/Lateral No Grommet

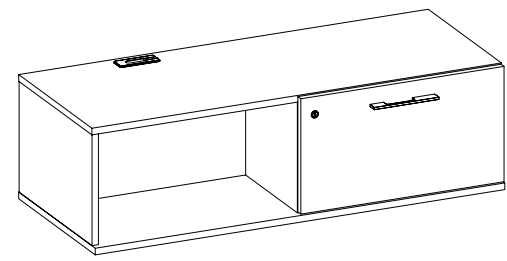

Open/Lateral w/ Grommet

**What's Included:**

- Low Credenza

**How to Specify:**

- Legs to be specified separately

**Notes:**

**Options:**

Widths: 48", 54", 60", 66", 72", 78", 84"

Depths: 19"

Laminate

Paint Finish

Electrics

**No Grommet**

Code	Price	H	W	D	Vol.	Wt.
Lateral/Open						
H-CRLO-204819	1391	20	48	19	13.0	61
H-CRLO-205419	1552	20	54	19	14.0	68
H-CRLO-206019	1621	20	60	19	16.0	76
H-CRLO-206619	1671	20	66	19	17.0	84
H-CRLO-207219	1737	20	72	19	19.0	91
H-CRLO-207819	1782	20	78	19	21.0	99
H-CRLO-208419	1849	20	84	19	22.0	106
Open/Lateral						
H-CROL-204819	1391	20	48	19	13.0	61
H-CROL-205419	1552	20	54	19	14.0	68
H-CROL-206019	1621	20	60	19	16.0	76
H-CROL-206619	1671	20	66	19	17.0	84
H-CROL-207219	1737	20	72	19	19.0	91
H-CROL-207819	1782	20	78	19	21.0	99
H-CROL-208419	1849	20	84	19	22.0	106

**w/Grommet**

Code	Price	H	W	D	Vol.	Wt.
Lateral/Open						
H-CRLO-204819-R	1494	20	48	19	13.0	61
H-CRLO-205419-R	1666	20	54	19	14.0	68
H-CRLO-206019-R	1733	20	60	19	16.0	76
H-CRLO-206619-R	1783	20	66	19	17.0	84
H-CRLO-207219-R	1858	20	72	19	19.0	91
H-CRLO-207819-R	1910	20	78	19	21.0	99
H-CRLO-208419-R	1977	20	84	19	22.0	106
Open/Lateral						
H-CROL-204819-L	1494	20	48	19	13.0	61
H-CROL-205419-L	1666	20	54	19	14.0	68
H-CROL-206019-L	1733	20	60	19	16.0	76
H-CROL-206619-L	1783	20	66	19	17.0	84
H-CROL-207219-L	1858	20	72	19	19.0	91
H-CROL-207819-L	1910	20	78	19	21.0	99
H-CROL-208419-L	1977	20	84	19	22.0	106

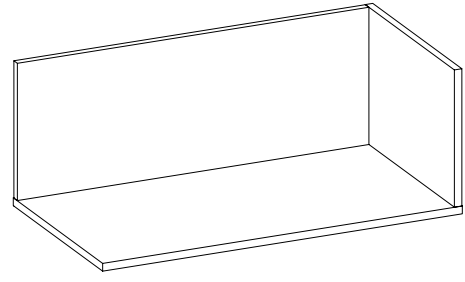

End Cap-  
LH shown

**What's Included:**

- Low Credenza End Cap Open Shelf

**How to Specify:**

- Legs to be specified separately
- Open to RH or LH

**Notes:**

**Options:**

Widths: 9", 12", 15", 18", 21", 27", 30", 36", 39", 42", 45", 48"

Depths: 16", 19"

Height: 20", 29"

Laminate

Paint Finish

Electrics?

Code	Price	H	W	D	Vol.	Wt.
H-CREC-200916-L	305	29	9	16	1.0	8
H-CREC-200916-R	305	20	9	16	1.0	8
H-CREC-201216-L	322	20	12	16	2.0	11
H-CREC-201216-R	322	20	12	16	2.0	11
H-CREC-201516-L	334	20	15	16	2.0	14
H-CREC-201516-R	334	20	15	16	2.0	14
H-CREC-201816-L	340	20	18	16	2.0	17
H-CREC-201816-R	340	20	18	16	2.0	17
H-CREC-202116-L	354	20	21	16	2.0	20
H-CREC-202116-R	354	20	21	16	2.0	20
H-CREC-202416-L	374	20	24	16	2.0	23
H-CREC-202416-R	374	20	24	16	2.0	23
H-CREC-202716-L	382	20	27	16	2.0	26
H-CREC-202716-R	382	20	27	16	2.0	26
H-CREC-203016-L	393	20	30	16	2.0	29
H-CREC-203016-R	393	20	30	16	2.0	29
H-CREC-203316-L	408	20	33	16	2.0	32
H-CREC-203316-R	408	20	33	16	2.0	32
H-CREC-203616-L	414	20	36	16	2.0	35
H-CREC-203616-R	414	20	36	16	2.0	35
H-CREC-203916-L	432	20	39	16	2.0	38
H-CREC-203916-R	432	20	39	16	2.0	38
H-CREC-204216-L	438	20	42	16	3.0	41
H-CREC-204216-R	438	20	42	16	3.0	41
H-CREC-204516-L	450	20	45	16	3.0	44
H-CREC-204516-R	450	20	45	16	3.0	44
H-CREC-204816-L	465	20	48	16	3.0	47
H-CREC-204816-R	465	20	48	16	3.0	47

Code	Price	H	W	D	Vol.	Wt.
H-CREC-200919-L	315	20	9	19	2.0	10
H-CREC-200919-R	315	20	9	19	2.0	10
H-CREC-201219-L	334	20	12	19	2.0	13
H-CREC-201219-R	334	20	12	19	2.0	13
H-CREC-201519-L	340	20	15	19	2.0	16
H-CREC-201519-R	340	20	15	19	2.0	16
H-CREC-201819-L	347	20	18	19	2.0	19
H-CREC-201819-R	347	20	18	19	2.0	19
H-CREC-202119-L	354	20	21	19	2.0	22
H-CREC-202119-R	354	20	21	19	2.0	22
H-CREC-202419-L	374	20	24	19	2.0	25
H-CREC-202419-R	374	20	24	19	2.0	25
H-CREC-202719-L	396	20	27	19	2.0	27
H-CREC-202719-R	396	20	27	19	2.0	27
H-CREC-203019-L	409	20	30	19	2.0	31
H-CREC-203019-R	409	20	30	19	2.0	31
H-CREC-203319-L	423	20	33	19	2.0	33
H-CREC-203319-R	423	20	33	19	2.0	33
H-CREC-203619-L	426	20	36	19	2.0	37
H-CREC-203619-R	426	20	36	19	2.0	37
H-CREC-203919-L	440	20	39	19	3.0	40
H-CREC-203919-R	440	20	39	19	3.0	40
H-CREC-204219-L	451	20	42	19	3.0	43
H-CREC-204219-R	451	20	42	19	3.0	43
H-CREC-204519-L	461	20	45	19	3.0	46
H-CREC-204519-R	461	20	45	19	3.0	46
H-CREC-204819-L	480	20	48	19	3.0	49
H-CREC-204819-R	480	20	48	19	3.0	49

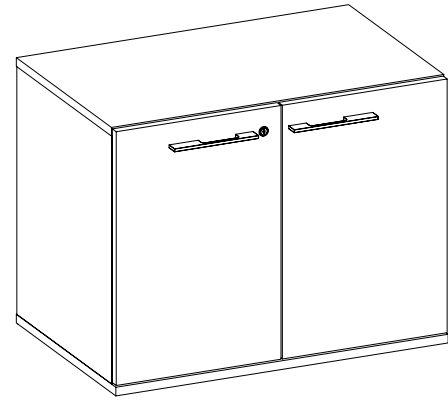

High Credenza w/ hinged door

**What's Included:**

- High Credenza

**How to Specify:**

Legs to be specified separately

**Notes:**

**Options:**

Widths: 30", 36", 42", 48", 54", 60", 66", 72", 78", 84"

Depths: 19", 24"

Height: 29"

Laminate

Paint Finish

Electrics

Code	Price	H	W	D	Volume	Weight
H-CRHH-293019	1369	29	30	19	11.0	55
H-CRHH-293619	1474	29	36	19	14.0	66
H-CRHH-294219	1591	29	42	19	16.0	77
H-CRHH-294819	1838	29	48	19	18.0	88
H-CRHH-295419	2033	29	54	19	18.0	96
H-CRHH-296019	2115	29	60	19	23.0	110
H-CRHH-296619	2292	29	66	19	23.0	118
H-CRHH-297219	2367	29	72	19	28.0	132
H-CRHH-297819	2444	29	78	19	28.0	140
H-CRHH-298419	2510	29	84	19	32.0	154
H-CRHH-293024	1449	29	30	24	15.0	70
H-CRHH-293624	1563	29	36	24	17.0	84
H-CRHH-294224	1880	29	42	24	20.0	97
H-CRHH-294824	1971	29	48	24	23.0	111
H-CRHH-295424	2177	29	54	24	18.0	117
H-CRHH-296024	2266	29	60	24	29.0	139
H-CRHH-296624	2459	29	66	24	29.0	145
H-CRHH-297224	2547	29	72	24	35.0	167
H-CRHH-297824	2630	29	78	24	35.0	175
H-CRHH-298424	2713	29	84	24	41.0	195

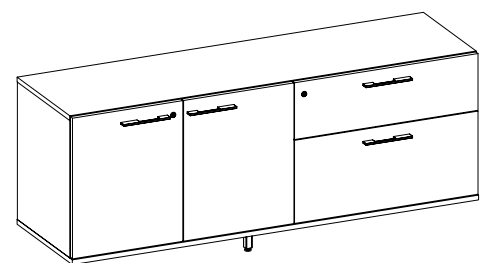

High Credenza w/ Lateral & Doors

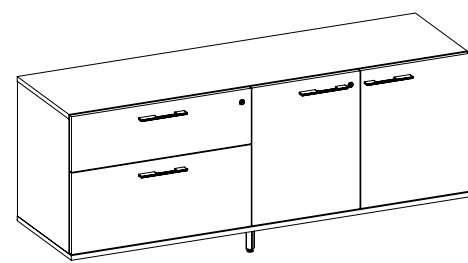

High Credenza w/Doors & Lateral

**What's Included:**

- High Credenza

**How to Specify:**

Legs to be specified separately

**Notes:**

**Options:**

Widths: 48", 54", 60", 66", 72", 78", 84"

Depths: 19", 24"

Height: 29"

Laminate

Paint Finish

Electrics

Code	Price	H	W	D	Volume	Weight
<b>Hinged Door &amp; Lateral</b>						
H-CRHL-294819	1870	29	48	19	18.0	76
H-CRHL-295419	2028	29	54	19	18.0	81
H-CRHL-296019	2093	29	60	19	23.0	94
H-CRHL-296619	2144	29	66	18	23.0	100
H-CRHL-297219	2194	29	72	19	28.0	113
H-CRHL-297819	2373	29	78	19	28.0	120
H-CRHL-298419	2449	29	84	19	32.0	132
H-CRHL-294824	1981	29	48	24	23.0	95
H-CRHL-295424	2135	29	54	24	23.0	101
H-CRHL-296024	2217	29	60	24	29.0	119
H-CRHL-296624	2276	29	66	24	29.0	125
H-CRHL-297224	2326	29	72	24	35.0	143
H-CRHL-297824	2524	29	78	24	35.0	150
H-CRHL-298424	2611	29	84	24	41.0	167
<b>Lateral &amp; Hinged Door</b>						
H-CRLH-294819	1870	29	48	19	18.0	76
H-CRLH-295419	2028	29	54	19	18.0	81
H-CRLH-296019	2093	29	60	19	23.0	94
H-CRLH-296619	2144	29	66	19	23.0	100
H-CRLH-297219	2194	29	72	19	28.0	113
H-CRLH-297819	2373	29	78	19	28.0	120
H-CRLH-298419	2449	29	84	19	32.0	132
H-CRLH-294824	1981	29	48	24	23.0	95
H-CRLH-295424	2135	29	54	24	23.0	101
H-CRLH-296024	2217	29	60	24	29.0	119
H-CRLH-296624	2276	29	66	24	29.0	125
H-CRLH-297224	2326	29	72	24	35.0	143
H-CRLH-297824	2524	29	78	24	35.0	150
H-CRLH-298424	2611	29	84	24	41.0	167

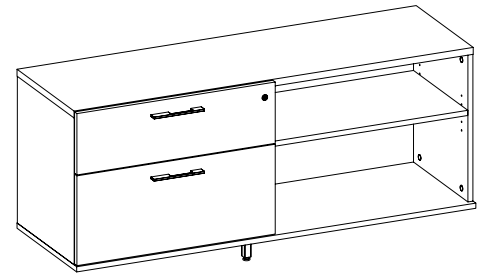

High Credenza w/ Lateral & Open

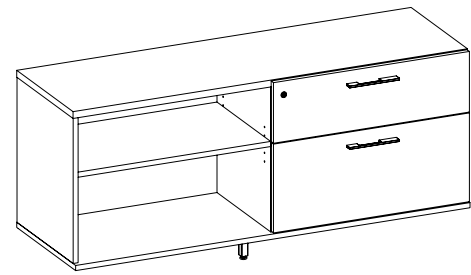

High Credenza w/ Open & Lateral

**What's Included:**

- High Credenza

**How to Specify:**

Legs to be specified separately

**Notes:**

**Options:**

Widths: 48", 60", 72", 84"

Depths: 19", 24"

Laminate

Paint Finish

Electrics

Code	Price	H	W	D	Volume	Weight
<b>Lateral &amp; Open</b>						
H-CRLO-294819	1938	29	48	19	18.0	88
H-CRLO-296019	2176	29	60	19	23.0	110
H-CRLO-297219	2297	29	72	19	28.0	132
H-CRLO-298419	2429	29	84	19	32.0	154
H-CRLO-294824	2047	29	48	24	23.0	111
H-CRLO-296024	2310	29	60	24	29.0	139
H-CRLO-297224	2449	29	72	24	35.0	167
H-CRLO-298424	2597	29	84	24	41.0	195
<b>Open &amp; Lateral</b>						
H-CROL-294819	1938	29	48	19	18.0	88
H-CROL-296019	2176	29	60	19	23.0	110
H-CROL-297219	2297	29	72	19	28.0	132
H-CROL-298419	2429	29	84	19	32.0	154
H-CROL-294824	2047	29	48	24	23.0	111
H-CROL-296024	2310	29	60	24	29.0	139
H-CROL-297224	2449	29	72	24	35.0	167
H-CROL-298424	2597	29	84	24	41.0	195

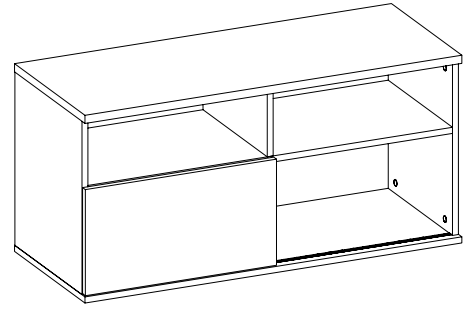

High Credenza w/ Shelf above Sliding Door

**What's Included:**

- High Credenza

**How to Specify:**

Legs to be specified separately

**Notes:**

**Options:**

Widths: 48", 54", 60", 66", 72", 78", 84"

Depths: 19", 24"

Height: 29"

Laminate

Paint Finish

Electrics

Code	Price	H	W	D	Volume	Weight
H-CRFS-294819	1742	29	48	19	18.4	75.57
H-CRFS-294824	1856	29	48	24	23.2	95.45
H-CRFS-295419	1910	29	54	19	18.4	83
H-CRFS-295424	2042	29	54	24	23.2	86
H-CRFS-296019	1986	29	60	19	23.0	94.46
H-CRFS-296024	2117	29	60	24	29.0	119.31
H-CRFS-296619	2057	29	66	19	23.0	100
H-CRFS-296624	2204	29	66	24	29.0	125
H-CRFS-297219	2128	29	72	19	27.6	113.35
H-CRFS-297224	2287	29	72	24	34.8	143.18
H-CRFS-297819	2204	29	78	19	27.6	120
H-CRFS-297824	2362	29	78	24	34.8	150
H-CRFS-298419	2273	29	84	19	32.1	132.24
H-CRFS-298424	2449	29	84	24	40.6	167.04

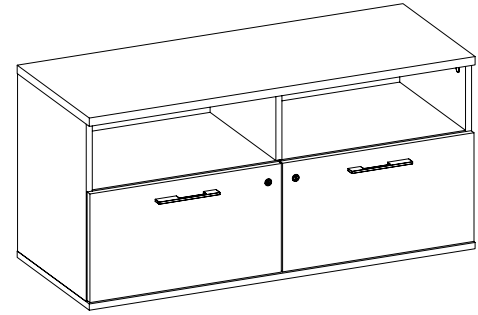

High Credenza w/ Open Shelf above Lateral

**What's Included:**

- High Credenza

**How to Specify:**

Legs to be specified separately

**Notes:**

**Options:**

Widths: 48", 54", 60", 66", 72", 78", 84"

Depths: 19", 24"

Height: 29"

Laminate

Paint Finish

Electrics

Code	Price	H	W	D	Volume	Weight
H-CRFL-294819	2013	29	48	19	18.4	88.16
H-CRFL-294824	2132	29	48	24	23.2	111.36
H-CRFL-296019	2275	29	60	19	23.0	110.2
H-CRFL-296024	2389	29	60	24	29.0	139.2
H-CRFL-297219	2454	29	72	19	27.6	132.24
H-CRFL-297224	2599	29	72	24	34.8	167.04
H-CRFL-298419	2651	29	84	19	32.1	154.28
H-CRFL-298424	2806	29	84	24	40.6	194.88

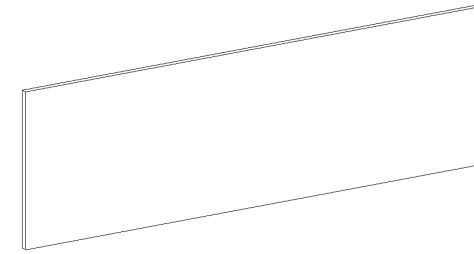

Raised Back for Credenza

**What's Included:**

- Laminate raised credenza panel

**How to Specify:**

**Notes:**

**Options:**

Widths: 48", 54", 60", 66", 72", 78", 84"

Depths: 0.75"

Height: 18"

Laminate

Paint Finish

Electrics?

Code	Price	H	W	D	Volume	Weight
H-CRBO-1848	353	18	48	1	4.0	4
H-CRBO-1854	379	18	54	1	1.0	4
H-CRBO-1860	407	18	60	1	1.0	5
H-CRBO-1866	438	18	66	1	1.1	5.28
H-CRBO-1872	499	18	72	1	1.2	5.76
H-CRBO-1878	543	18	78	1	1.3	6.24
H-CRBO-1884	596	18	84	1	1.4	6.72

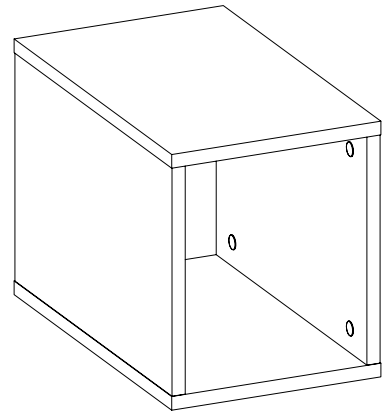

Credenza Open End Box

**What's Included:**

- Credenza End Box

**How to Specify:**

- Used beside the Integrated Height Adjustable Table Box to make up the full width
- Legs to be specified separately

**Notes:**

**Options:**

Widths: 9", 12"  
 Depths: 16", 19"  
 Height: 20"

Laminate

Paint Finish

Electrics?

Code	Price	H	W	D	Volume	Weight
H-CREB-200916	438	20	9	16	2.0	12
H-CREB-201216	487	20	12	16	2.0	14
H-CREB-200919	453	20	9	19	2.0	14
H-CREB-201219	506	20	12	19	3.0	18

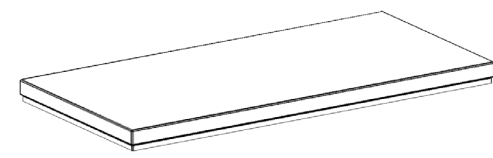

Credenza Cushion

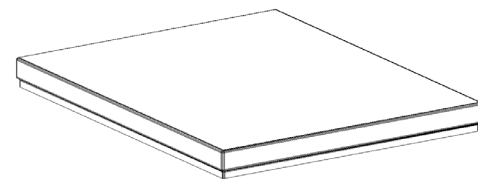

Pedestal Cushion

**What's Included:**

- upholstered cushion

**How to Specify:**

- Used beside the Integrated Height Adjustable Table Box to make up the full width
- Legs to be specified separately

**Notes:**

Credenza cushions leave 1.5" gap on all 4 sides of the credenza top

**Options:**

Widths:	21", 27", 33", 39", 45", 51", 57", 63", 69", 75", 81"
Depths:	13, 16"
Height:	2"
Cushion Fabric	

Code	Price	H	W	D	Volume	Weight
<b>Credenza cushion</b>						
H-AC-2113	339	2	21	13	0.2	3
H-AC-2713	382	2	27	13	0.2	4
H-AC-3313	426	2	33	13	0.3	4
H-AC-3913	482	2	39	13	0.3	5
H-AC-4513	525	2	45	13	0.4	6
H-AC-5113	576	2	51	13	0.4	7
H-AC-5713	622	2	57	13	0.5	7
H-AC-6313	671	2	63	13	1.0	8
H-AC-6913	718	2	69	13	1.0	9
H-AC-7513	767	2	75	13	1.0	10
H-AC-8113	813	2	81	13	1.0	11
H-AC-2116	354	2	21	16	0.2	3
H-AC-2716	402	2	27	16	0.3	4
H-AC-3316	451	2	33	16	0.4	5
H-AC-3916	507	2	39	16	0.4	6
H-AC-4516	555	2	45	16	0.5	7
H-AC-5116	607	2	51	16	1.0	8
H-AC-5716	655	2	57	16	1.0	9
H-AC-6316	711	2	63	16	1.0	10
H-AC-6916	758	2	69	16	1.0	11
H-AC-7516	807	2	75	16	1.0	12
H-AC-8116	859	2	81	16	1.0	13
<b>Pedestal Cushion</b>						
H-FPAC-16	336	1.25	16	19	0.7	2

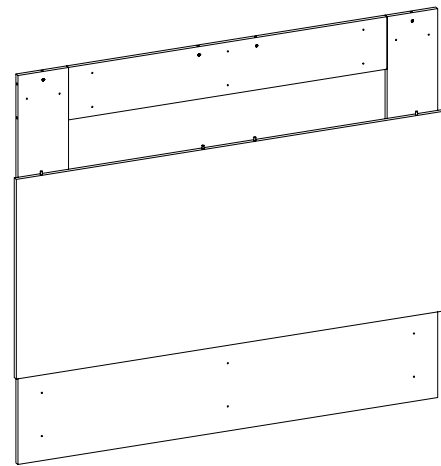

Gallery Wall for Accent Shelves

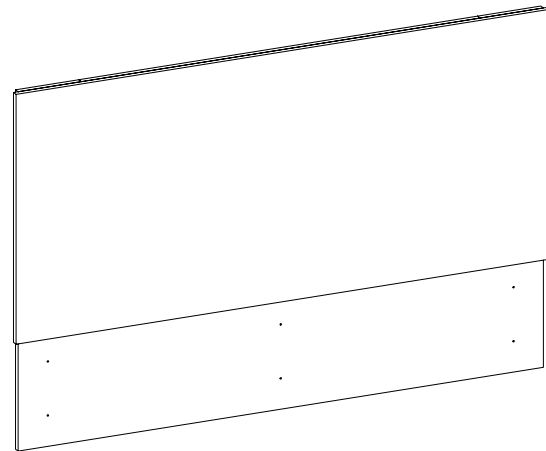

No Overheads

**What's Included:**

- Gallery wall backer,
- Gallery wall Front

**Notes:**

**How to Specify:**

**Options:**

Widths: 48", 60", 66", 72", 84", 96"

Depths: 0.75"

Height: 33", 49"

Laminate

Paint Finish

Electrics

Code	Price	H	W	D	Volume	Weight
<b>For Accent Shelves</b>						
H-CGWA-4948	1164	49	48	1	0.4	12
H-CGWA-4960	1245	49	60	1	1.0	15
H-CGWA-4972	1349	49	72	1	1.0	18
H-CGWA-4984	1470	49	84	1	1.0	21
H-CGWA-4996	1513	49	96	1	1.0	21
<b>No Overheads</b>						
H-CGWN-3348	1125	33	48	1	0.3	8
H-CGWN-3354	1164	33	48	1	0.3	9
H-CGWN-3360	1207	33	60	1	0.4	10
H-CGWN-3366	1245	33	66	1	0.4	10
H-CGWN-3372	1317	33	72	1	0.5	12
H-CGWN-3378	1357	33	78	1	0.5	13
H-CGWN-3384	1396	33	84	1	1.0	14
H-CGWN-3390	1431	33	90	1	1.0	15
H-CGWN-3396	1470	33	96	1	1.0	17

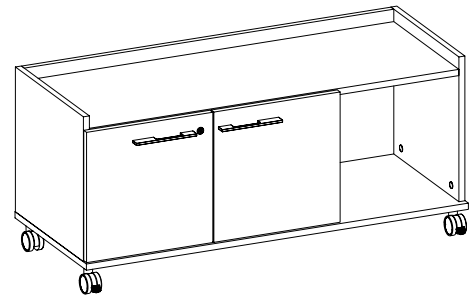

Mobile Credenza w/ Hinged Door/Open

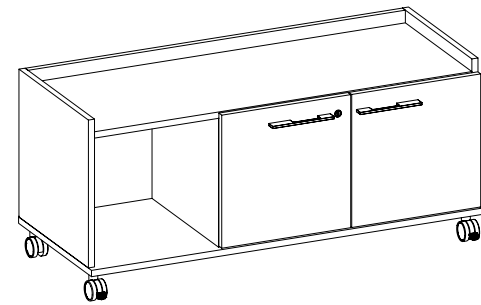

Mobile Credenza w/Open/Hinged Door

**What's Included:**

- Mobile Credenza

**How to Specify:**

**Notes:**

**Options:**

Widths: 30", 36", 42", 48"

Depths: 19"

Height: 20"

Laminate

Paint Finish

Electrics?

Code	Price	H	W	D	Volume	Weight
<b>Hinged Door/Open</b>						
H-CMHO-203019	1085	20	30	19	17.0	60
H-CMHO-203619	1119	20	36	19	17.0	72
H-CMHO-204219	1142	20	42	19	17.0	84
H-CMHO-204819	1172	20	48	19	17.0	96
<b>Open/Hinged Door</b>						
H-CMOH-203019	1085	20	30	19	17.0	60
H-CMOH-203619	1119	20	36	19	17.0	72
H-CMOH-204219	1142	20	42	19	17.0	84
H-CMOH-204819	1172	20	48	19	17.0	96

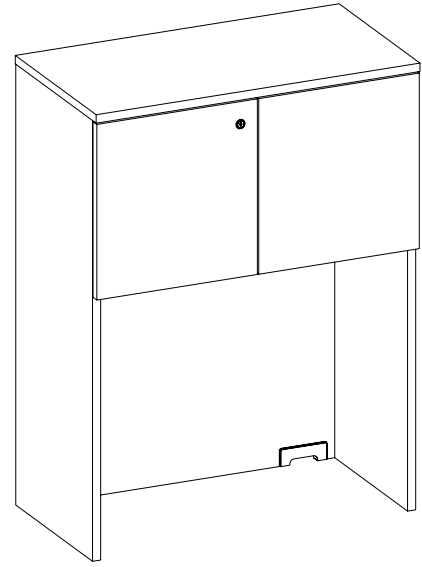

Laminate w/ hinged Door

**What's Included:**

- Laminate Gable Hutch

**How to Specify:**

To Match the width of the desk or credenza it is mounted on

**Notes:**

Item ships assembled

**Options:**

Widths: 30", 36", 42", 48", 54", 60", 66", 72", 78" 84"

Depths: 16 "

Laminate

Paint Finish

Electrics

Code	Price	H	W	D	Volume	Weight
H-SHH0-403016	1182	40	30	16	10.0	56
H-SHH0-403616	1244	40	36	16	12.0	67
H-SHH0-404216	1425	40	42	16	14.0	78
H-SHH0-404816	1542	40	48	16	16.0	90
H-SHH0-405416	1674	40	54	16	18.0	101
H-SHH0-406016	1781	40	60	16	19.0	112
H-SHH0-406616	1893	40	66	16	21.0	123
H-SHH0-407216	1988	40	72	16	23.0	134
H-SHH0-407816	2090	40	78	16	25.0	146
H-SHH0-408416	2166	40	84	16	27.0	157
H-SHH0-496016	1888	49	60	16	24.0	137
H-SHH0-496616	2007	49	66	16	26.0	151
H-SHH0-497216	2107	49	72	16	29.0	165
H-SHH0-497816	2214	49	78	16	31.0	178
H-SHH0-498416	2296	49	84	16	33.0	192

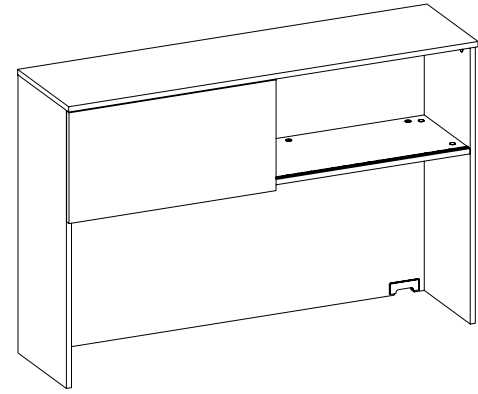

Laminate w/ sliding Door

**What's Included:**

- Laminate Gable Hutch

**How to Specify:**

To Match the width of the desk or credenza it is mounted on

**Notes:**

Item ships assembled

**Options:**

Widths: 30", 36", 42", 48", 54", 60", 66", 72", 78" 84"

Depths: 16 "

Laminate

Paint Finish

Electrics

Code	Price	H	W	D	Volume	Weight
H-SHS0-403016	1324	40	30	16	10.0	56
H-SHS0-403616	1396	40	36	16	12.0	67
H-SHS0-404216	1545	40	42	16	14.0	78
H-SHS0-404816	1609	40	48	16	16.0	90
H-SHS0-405416	1678	40	54	16	18.0	101
H-SHS0-406016	1744	40	60	16	19.0	112
H-SHS0-406616	1816	40	66	16	21.0	123
H-SHS0-407216	1880	40	72	16	23.0	134
H-SHS0-407816	1954	40	78	16	25.0	146
H-SHS0-408416	2018	40	84	16	27.0	157
H-SHS0-496016	1834	49	60	16	24.0	137
H-SHS0-496616	1904	49	66	16	26.0	151
H-SHS0-497216	1977	49	72	16	29.0	165
H-SHS0-497816	2058	49	78	16	31.0	178
H-SHS0-498416	2132	49	84	16	33.0	192

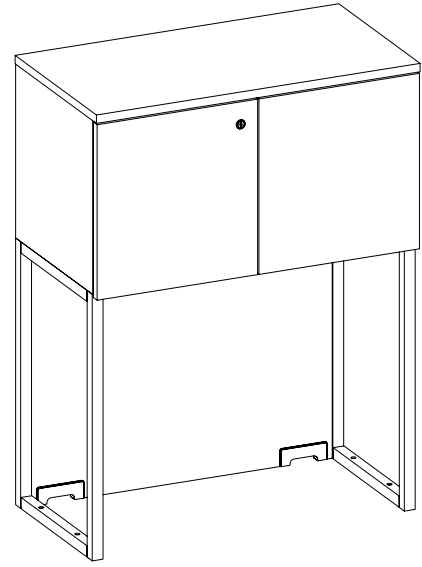

Metal w/ hinged Door

**What's Included:**

- Metal Gable Hutch

**How to Specify:**

To Match the width of the desk or credenza it is mounted on

**Notes:**

Item ships assembled

**Options:**

Widths: 30", 36", 42", 48", 54", 60", 66", 72", 78" 84"

Depths: 16 "

Laminate

Paint Finish

Electrics

Code	Price	H	W	D	Volume	Weight
H-SHHM-403016	1766	40	30	16	10.0	56
H-SHHM-403616	1819	40	36	16	12.0	67
H-SHHM-404216	2069	40	42	16	14.0	78
H-SHHM-404816	2132	40	48	16	16.0	90
H-SHHM-405416	2189	40	54	16	18.0	101
H-SHHM-406016	2253	40	60	16	19.0	112
H-SHHM-406616	2499	40	66	16	19.0	123
H-SHHM-407216	2554	40	72	16	23.0	134
H-SHHM-407816	2618	40	75	16	25.0	146
H-SHHM-408416	2675	40	84	16	27.0	157
H-SHHM-496016	2350	49	60	16	24.0	137
H-SHHM-496616	2602	49	66	16	26.0	151
H-SHHM-497216	2669	49	72	16	29.0	165
H-SHHM-497816	2733	49	78	16	31.0	178
H-SHHM-498416	2794	49	84	16	33.0	192

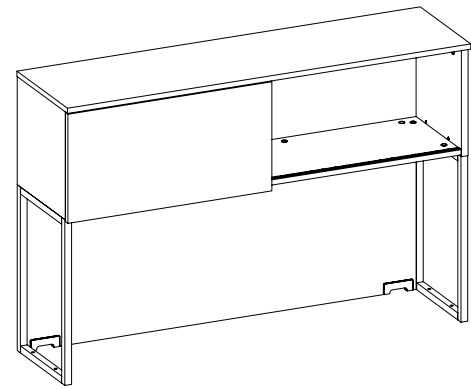

Metal w/ sliding Door

**What's Included:**

- Metal Gable Hutch

**How to Specify:**

To Match the width of the desk or credenza it is mounted on

**Notes:**

Item ships assembled

**Options:**

Widths: 30", 36", 42", 48", 54", 60", 66", 72", 78" 84"

Depths: 16 "

Laminate

Paint Finish

Electrics

Code	Price	H	W	D	Volume	Weight
H-SHSM-403016	1983	40	30	16	10.0	56
H-SHSM-403616	2056	40	36	16	12.0	67
H-SHSM-404216	2119	40	42	16	14.0	78
H-SHSM-404816	2192	40	48	16	16.0	90
H-SHSM-405416	2255	40	54	16	18.0	101
H-SHSM-406016	2328	40	60	16	19.0	112
H-SHSM-406616	2394	40	66	16	21.0	123
H-SHSM-407216	2466	40	72	16	23.0	134
H-SHSM-407816	2529	40	78	16	25.0	146
H-SHSM-408416	2602	40	84	16	27.0	157
H-SHSM-496016	2424	49	60	16	24.0	137
H-SHSM-496616	2498	49	66	16	26.0	151
H-SHSM-497216	2571	49	72	16	29.0	165
H-SHSM-497816	2641	49	78	16	31.0	178
H-SHSM-498416	2722	49	84	16	33.0	192

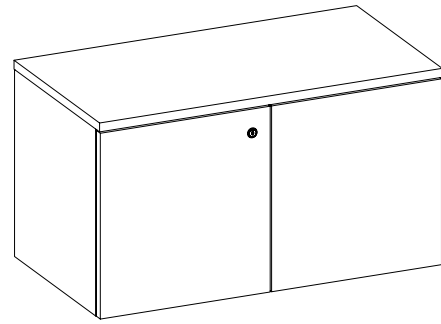

Wall mounted w/ hinged Door

**What's Included:**

- Wall mounted hinged door hutch

**How to Specify:**

To Match the width of the desk or credenza it is mounted on

**Notes:**

Item ships assembled

**Options:**

Widths: 30", 36", 42", 48", 54", 60", 66", 72", 78" 84"

Depths: 16 "

Laminate

Paint Finish

Electrics

Code	Price	H	W	D	Volume	Weight
H-SWH0-153016	904	15	30	16	10.0	56
H-SWH0-153616	953	15	36	16	12.0	67
H-SWH0-154216	1061	15	42	16	14.0	78
H-SWH0-154816	1110	15	48	16	16.0	90
H-SWH0-155416	1155	15	54	16	18.0	101
H-SWH0-156016	1267	15	60	16	19.0	112
H-SWH0-156616	1315	15	66	16	21.0	123
H-SWH0-157216	1365	15	72	16	23.0	134
H-SWH0-157816	1415	15	78	16	25.0	146
H-SWH0-158416	1464	15	84	16	27.0	157

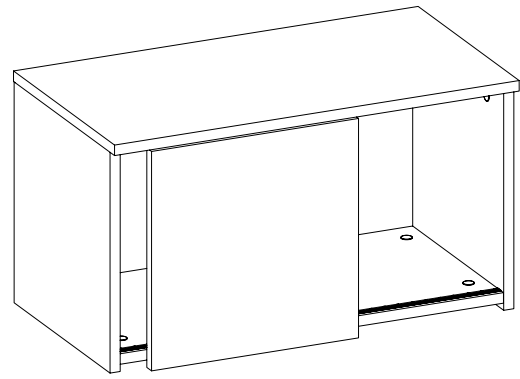

Wall mounted w/ sliding Door

**What's Included:**

- Wall mounted sliding door hutch

**How to Specify:**

To Match the width of the desk or credenza it is mounted on

**Notes:**

Item ships assembled

**Options:**

Widths: 30", 36", 42", 48", 54", 60", 66", 72", 78" 84"

Depths: 16 "

Laminate

Paint Finish

Electrics

Code	Price	H	W	D	Volume	Weight
H-SWS0-153016	1090	15	30	16	10.0	56
H-SWS0-153616	1145	15	36	16	12.0	67
H-SWS0-154216	1200	15	42	16	14.0	78
H-SWS0-154816	1254	15	42	16	16.0	90
H-SWS0-155416	1301	15	54	16	18.0	101
H-SWS0-156016	1356	15	60	16	19.0	112
H-SWS0-156616	1408	15	66	16	21.0	123
H-SWS0-157216	1464	15	72	16	23.0	134
H-SWS0-157816	1517	15	78	16	25.0	146
H-SWS0-158416	1564	15	84	16	27.0	157

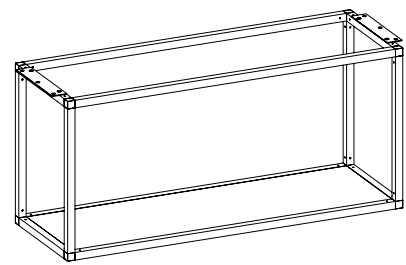

Side Mount/ No Back

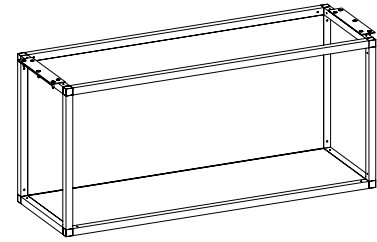

Side Mount w/ Back

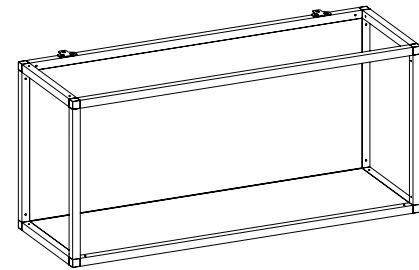

Gallery Wall Mount w/Back

**What's Included:**

- Accent Shelf

**How to Specify:**

Side mount accent shelf needs storage supporting the shelf on LH and RH

**Notes:**

Gallery wall mounted accent shelf cannot be mounted to a drywall

**Options:**

Widths: 30", 36", 42", 48"

Depths: 12"

Height: 16.5"

Laminate

Paint Finish

Electrics

Code	Price	H	W	D	Volume	Weight
<b>Side Mount/ No Back</b>						
H-ASSM-163012	2483	17	30	12	9.0	50
H-ASSM-163612	2536	17	36	12	11.0	60
H-ASSM-164212	2618	17	42	12	12.0	71
H-ASSM-164812	2705	16	48	12	14.0	81
<b>Side Mount w/ Back</b>						
H-ASSM-163012-B	2615	17	30	12	9.0	50
H-ASSM-163612-B	2669	17	36	12	11.0	60
H-ASSM-164212-B	2750	17	42	12	12.0	71
H-ASSM-164812-B	2837	17	48	12	14.0	81
<b>Gallery Wall Mount w/Back</b>						
H-ASWM-163012	2615	17	30	12	9.0	50
H-ASWM-163612	2669	15	36	12	11.0	60
H-ASWM-164212	2750	17	42	12	12.0	71
H-ASWM-164812	2837	16	48	12	14.0	81

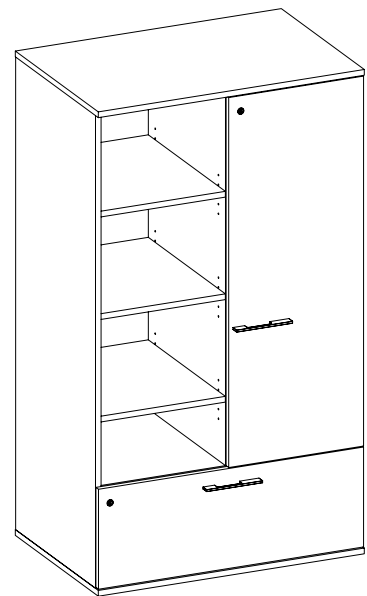

Combo Cabinet - Right w/Open Shelf/File Drawer

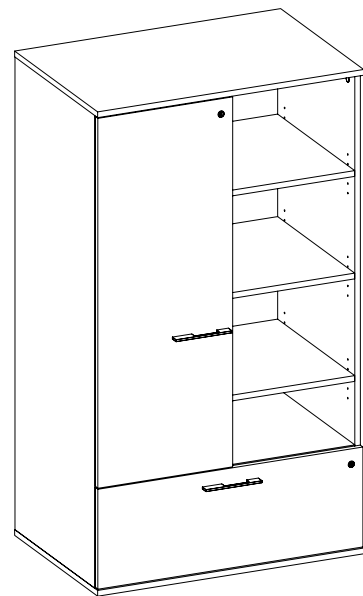

Combo Cabinet - Left w/Open Shelf/File Drawer

**What's Included:**

- Combo Closet

**How to Specify:**

Legs to be specified separately

**Notes:**

**Options:**

Widths: 24", 30", 36"

Depths: 19", 24"

Laminate

Paint Finish

Electrics

Code	Price	H	W	D	Volume	Weight
H-FCCF-532419-L	1725	53	24	19	13.0	102
H-FCCF-533019-L	1889	53	30	19	13.0	102
H-FCCF-533619-L	1993	53	36	19	13.0	102
H-FCCF-532419-R	1725	53	24	19	13.0	102
H-FCCF-533019-R	1889	53	30	19	13.0	102
H-FCCF-533619-R	1993	53	36	19	13.0	102
H-FCCF-532424-L	1751	53	24	24	15.0	122
H-FCCF-533024-L	2001	53	30	24	15.0	122
H-FCCF-533624-L	2115	53	36	24	15.0	122
H-FCCF-532424-R	1751	53	24	24	15.0	122
H-FCCF-533024-R	2001	53	30	24	15.0	122
H-FCCF-533624-R	2115	53	36	24	15.0	122
H-FCCF-692419-L	1837	69	24	19	17.0	132
H-FCCF-693019-L	2064	69	30	19	17.0	132
H-FCCF-693619-L	2188	69	36	19	17.0	132
H-FCCF-692419-R	1837	69	24	19	17.0	132
H-FCCF-693019-R	2064	69	30	19	17.0	132
H-FCCF-693619-R	2188	69	36	19	17.0	132
H-FCCF-692424-L	1924	69	24	24	20.0	159
H-FCCF-693024-L	2204	69	30	24	20.0	159
H-FCCF-693624-L	2333	69	36	24	20.0	159
H-FCCF-692424-R	1924	69	24	24	20.0	159
H-FCCF-693024-R	2204	69	30	24	20.0	159
H-FCCF-693624-R	2333	69	36	24	20.0	159

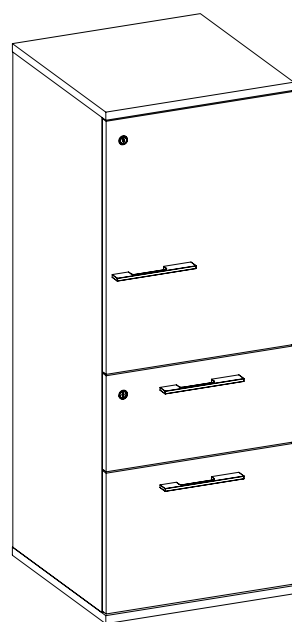

Combo Cabinet w/ single door

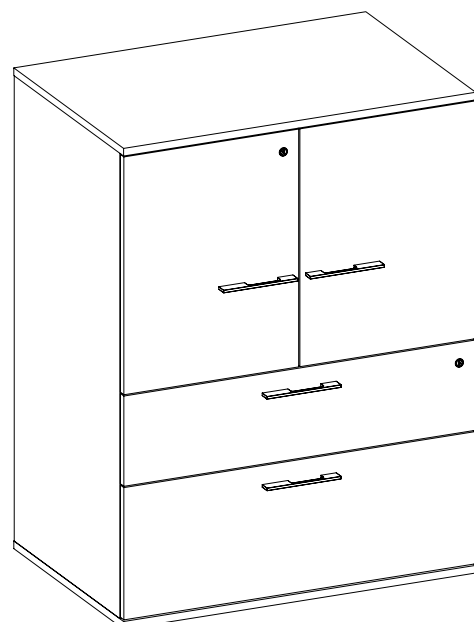

Combo Cabinet w/ double door

**What's Included:**

- Combo Cabinet

**How to Specify:**

Legs to be specified separately

**Notes:**

**Options:**

Widths: 18", 24", 30", 36", 42"

Depths: 19", 24"

Laminate

Paint Finish

Electrics

Code	Price	H	W	D	Volume	Weight
<b>Single door</b>						
H-FCSL-531819-L	1771	53	18	19	13.0	95
H-FCSL-531819-R	1771	53	18	19	13.0	95
H-FCSL-531824-L	1865	53	18	24	13.0	99
H-FCSL-531824-R	1865	53	18	24	13.0	99
H-FCSL-691819-L	2003	69	18	19	17.0	122
H-FCSL-691819-R	2003	69	18	19	17.0	122
H-FCSL-691824-L	2070	69	18	24	17.0	130
H-FCSL-691824-R	2070	69	18	24	17.0	130
<b>Double Door</b>						
H-FCSL-532419	2212	53	24	19	13.0	102
H-FCSL-533019	2350	53	30	19	16.0	127
H-FCSL-533619	2495	53	36	19	19.0	153
H-FCSL-534219	2630	53	36	24	22.0	178
H-FCSL-532424	2313	53	24	19	15.0	122
H-FCSL-533024	2466	53	30	24	19.0	153
H-FCSL-533624	2618	53	36	24	23.0	183
H-FCSL-534224	2757	53	42	24	27.0	214
H-FCSL-692419	2427	69	24	19	17.0	132
H-FCSL-693019	2587	69	30	19	21.0	166
H-FCSL-693619	2691	69	36	19	25.0	199
H-FCSL-694219	2829	69	42	19	29.0	232
H-FCSL-692424	2562	69	24	24	20.0	159
H-FCSL-693024	2739	69	30	24	25.0	199
H-FCSL-693624	2917	69	36	24	30.0	238
H-FCSL-694224	3054	69	42	19	35.0	278

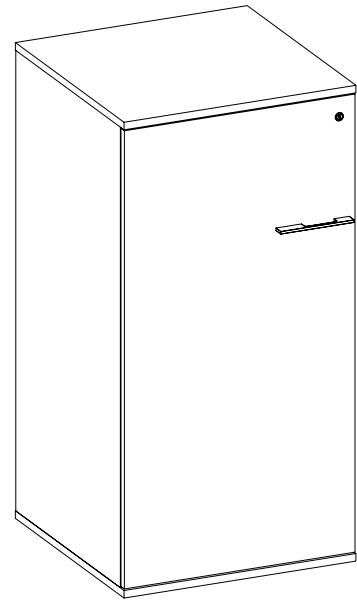

Locker Tower with Shelves

**What's Included:**

- Locker Tower with Shelves

**How to Specify:**

Legs to be specified separately

**Notes:**

**Options:**

Widths: 12", 18", 24"

Depths: 16", 19", 24", 30"

Laminate

Paint Finish

Electrics

Code	Price	H	W	D	Vol.	Wt.
H-FCKT-531216-L	1357	53	12	16	5.0	34
H-FCKT-531816-L	1494	53	18	16	7.0	51
H-FCKT-532416-L	1645	53	24	16	11.0	68
H-FCKT-531216-R	1357	53	12	16	5.0	34
H-FCKT-531816-R	1494	53	18	16	7.0	51
H-FCKT-532416-R	1645	53	24	16	11.0	68
H-FCKT-531219-L	1417	53	12	19	6.0	40
H-FCKT-531819-L	1591	53	18	19	8.0	60
H-FCKT-532419-L	1751	53	24	19	10.0	81
H-FCKT-531219-R	1417	53	12	19	6.0	40
H-FCKT-531819-R	1591	53	18	19	8.0	60
H-FCKT-532419-R	1751	53	24	19	10.0	81
H-FCKT-531224-L	1533	53	12	24	7.0	51
H-FCKT-531824-L	1704	53	18	24	9.0	76
H-FCKT-532424-L	1880	53	24	24	11.0	102
H-FCKT-531224-R	1533	53	12	24	7.0	51
H-FCKT-531824-R	1704	53	18	24	9.0	76
H-FCKT-532424-R	1880	53	24	24	11.0	102
H-FCKT-531230-L	1650	53	12	30	8.0	64
H-FCKT-531830-L	1822	53	18	30	10.0	95
H-FCKT-532430-L	2014	53	24	30	12.0	127
H-FCKT-531230-R	1650	53	12	30	8.0	64
H-FCKT-531830-R	1822	53	18	30	10.0	95

Code	Price	H	W	D	Vol.	Wt.
H-FCKT-532430-R	2014	53	24	30	12.0	127
H-FCKT-691216-L	1536	69	12	16	13.0	44
H-FCKT-691816-L	1709	69	18	16	9.0	66
H-FCKT-692416-L	1888	69	24	16	12.0	88
H-FCKT-691216-R	1536	69	12	16	13.0	44
H-FCKT-691816-R	1709	69	18	16	9.0	66
H-FCKT-692416-R	1888	69	24	16	12.0	88
H-FCKT-691219-L	1643	69	12	19	6.0	52
H-FCKT-691819-L	1815	69	18	19	9.0	79
H-FCKT-692419-L	2009	69	24	19	13.0	105
H-FCKT-691219-R	1643	69	12	19	6.0	52
H-FCKT-691819-R	1815	69	18	19	9.0	79
H-FCKT-692419-R	2009	69	24	19	13.0	105
H-FCKT-691224-L	1814	69	12	24	7.0	66
H-FCKT-691824-L	1953	69	18	24	10.0	99
H-FCKT-692424-L	2165	69	24	24	14.0	132
H-FCKT-691224-R	1814	69	12	24	7.0	66
H-FCKT-691824-R	1953	69	18	24	10.0	99
H-FCKT-692424-R	2165	69	24	24	14.0	132
H-FCKT-691230-L	1916	69	12	30	8.0	83
H-FCKT-691830-L	2090	69	18	30	11.0	124
H-FCKT-692430-L	2315	69	24	30	15.0	166
H-FCKT-691230-R	1916	69	12	30	8.0	83

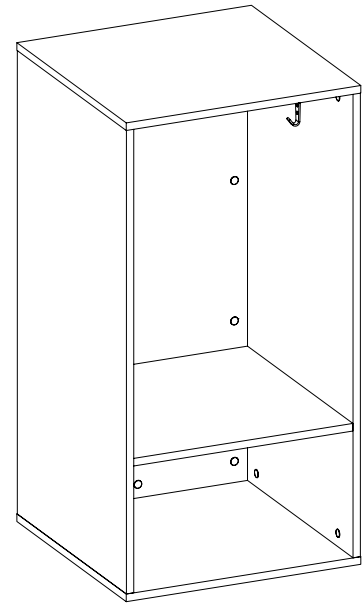

Side Access Locker w/ Open Shelf/Open Bottom

**What's Included:**

- Side Access Locker with a shelf and coat hooks

**How to Specify:**

Legs to be specified separately

**Notes:**

**Options:**

Widths: 12", 18", 24"

Depths: 16", 19", 24"

Laminate

Paint Finish

Electrics

Code	Price	H	W	D	Volume	Weight
H-FCCO-531816	938	53	18	16	7.0	44
H-FCCO-532416	1004	53	16	24	10.0	58
H-FCCO-531819	1058	53	18	19	8.0	52
H-FCCO-532419	1069	53	24	19	11.0	69
H-FCCO-531824	1065	53	18	24	9.0	65
H-FCCO-532424	1139	53	24	24	12.0	87
H-FCCO-691816	1027	69	18	16	9.0	57
H-FCCO-692416	1099	69	24	16	12.0	76
H-FCCO-691819	1081	69	18	19	10.0	67
H-FCCO-692419	1160	69	19	24	13.0	90
H-FCCO-691824	1179	69	18	24	11.0	85
H-FCCO-692424	1269	69	24	24	14.0	114

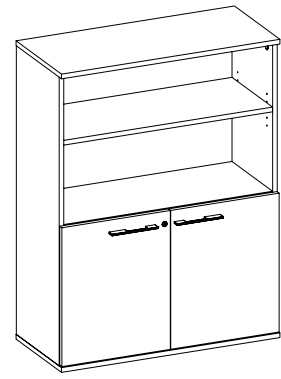

Bottom hinged

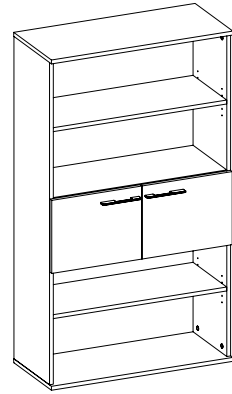

Middle hinged

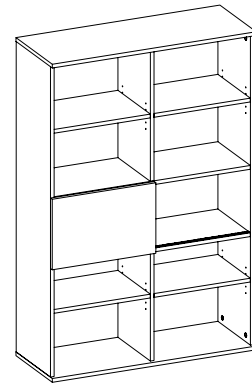

Sliding Door

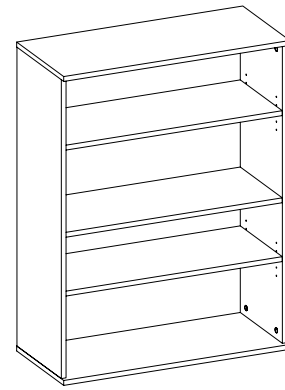

Open

**What's Included:**

- Bookcase

**How to Specify:**

Legs to be specified separately

**Notes:**

**Options:**

Widths: 24", 30", 36", 42", 48", 54", 60"

Depths: 16"

Height: 53", 69"

Laminate

Paint Finish

Electrics

Code	Price	H	W	D	Vol.	Wt.
<b>Bottom Hinged</b>						
H-BCBH-532416	1589	53	24	16	7.0	42
H-BCBH-533016	1696	53	30	16	9.0	50
H-BCBH-533616	1797	53	36	16	10.0	59
H-BCBH-534216	2176	53	42	16	12.0	67
H-BCBH-534816	2276	53	48	16	13.0	76
H-BCBH-535416	2461	53	54	16	15.0	84
H-BCBH-536016	2575	53	60	16	16.0	92
H-BCBH-692416	1792	69	24	16	10.0	56
H-BCBH-693016	1919	69	30	16	12.0	67
H-BCBH-693616	2035	69	36	16	14.0	78
H-BCBH-694216	2463	69	42	16	16.0	90
H-BCBH-694816	2590	69	48	16	18.0	101
H-BCBH-695416	2829	69	54	16	19.0	112
H-BCBH-696016	2946	69	60	16	21.0	123
<b>Middle Hinged</b>						
H-BCMh-693016	1868	69	30	16	12.0	67
H-BCMh-693616	1986	69	36	16	14.0	78
H-BCMh-694216	2407	69	42	16	16.0	90
H-BCMh-694816	2523	69	48	16	18.0	101
H-BCMh-695416	2728	69	54	16	19.0	112
H-BCMh-696016	2845	69	54	16	21.0	123
<b>Sliding Door</b>						
H-BCMS-693016	2094	69	30	16	12.0	67
H-BCMS-693616	2349	69	36	16	14.0	78
H-BCMS-694216	2473	69	42	16	16.0	90
H-BCMS-694816	2730	69	48	16	18.0	101
H-BCMS-695416	2939	69	54	16	19.0	112
H-BCMS-696016	3077	69	60	16	21.0	123

Code	Price	H	W	D	Vol.	Wt.
<b>Open</b>						
H-BCOO-532416	1199	53	24	16	7.0	42
H-BCOO-533016	1325	53	30	16	9.0	50
H-BCOO-533616	1449	53	36	16	10.0	59
H-BCOO-534216	1624	53	42	16	12.0	67
H-BCOO-534816	1718	53	48	16	13.0	76
H-BCOO-535416	1896	53	54	16	15.0	84
H-BCOO-536016	1979	53	60	16	16.0	92
H-BCOO-692416	1403	69	24	16	10.0	56
H-BCOO-693016	1555	69	30	16	12.0	67
H-BCOO-693616	1710	69	36	16	14.0	78
H-BCOO-694216	1924	69	42	16	16.0	90
H-BCOO-694816	2024	69	48	19	18.0	101
H-BCOO-695416	2253	69	54	16	19.0	112
H-BCOO-696016	2361	69	60	16	21.0	123
H-BCOO-532419	1319	53	24	19	8.0	47
H-BCOO-533019	1458	53	30	19	9.0	50
H-BCOO-533619	1596	53	36	19	12.0	66
H-BCOO-534219	1743	53	42	19	13.0	76
H-BCOO-534819	1845	53	48	19	15.0	85
H-BCOO-535419	2056	53	54	19	16.0	95
H-BCOO-536019	2149	53	60	19	18.0	104
H-BCOO-692419	1545	69	24	19	11.0	63
H-BCOO-693019	1713	69	30	19	13.0	76
H-BCOO-693619	1879	69	36	19	15.0	89
H-BCOO-694219	2064	69	42	16	18.0	101
H-BCOO-694819	2185	69	48	19	20.0	114
H-BCOO-695419	2421	69	54	19	22.0	127
H-BCOO-696019	2538	69	60	19	24.0	139

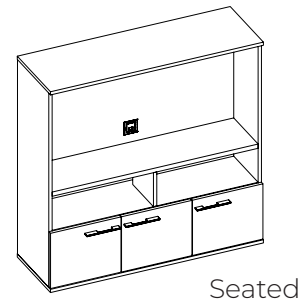

Seated

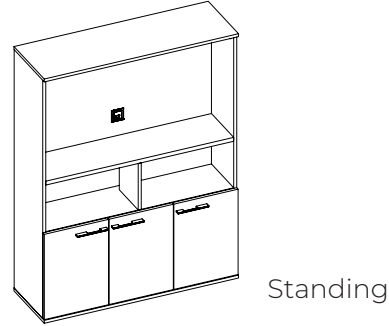

Standing

**What's Included:**

- AV Unit

**How to Specify:**

Legs to be specified separately

**Notes:**

- Seated 48"W unit accommodates up to 40" flat screen TV
- Seated 60"W unit accommodates up to 65" flat screen TV
- Standing 48"W unit accommodates up to 48" flat screen TV

**Options:**

Widths: 48", 60"

Depths: 16"

Height: 53", 69"

Laminate

Paint Finish

Electrics

Code	Price	H	W	D	Volume	Weight
<b>Seated w/finished Back</b>						
H-AVL0-534816	2577	53	48	16	16.0	142
H-AVL0-696016	3113	69	60	16	27.0	232
<b>Seated /no finished back</b>						
H-AVLN-534816	2279	53	48	16	21.0	142
H-AVLN-696016	2679	69	60	16	21.0	232
<b>Standing w/finished back</b>						
H-AVS0-694816	2829	69	48	16	16.0	185
<b>Standing /no finished back</b>						
H-AVSN-694816	2463	69	48	16	27.0	185

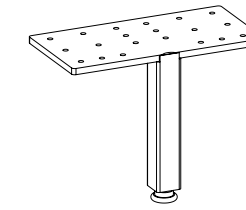
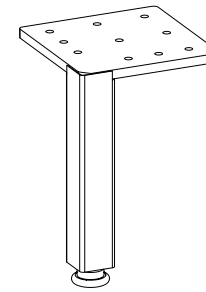

**What's Included:**

- 1 Storage support leg and hardware

**How to Specify:**

- Single or Shared
- Shared leg is used the front of two cabinet joints

**Options:**

Widths: 0

Depths: 0

Laminate

Paint Finish

Electrics

Code	Price	H	W	D	Volume	Weight
H-HCL-1	55	6	0	0	0.0	1
H-HCL-2	57	6	0	0	0.0	2

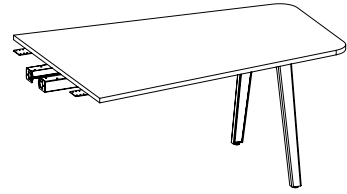

A-Leg No Grommet

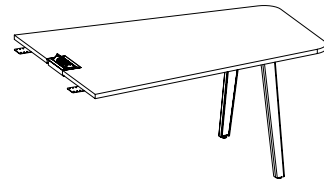

A-Leg Grommet

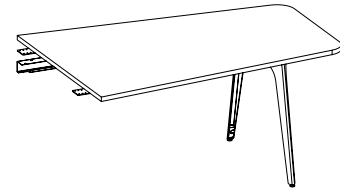

V-Leg No Grommet

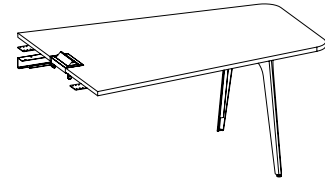

V-Leg Grommet

**What's Included:**

- Worksurface
- Legs
- Reinforcement Bars
- Optional Power

**How to Specify:**

6" smaller than the width of the AV Unit

**Notes:**

One of the A-Legs will come with an infill with a small hole to run wires out the bottom

**Options:**

Widths: 48", 60", 72", 84"

Depths: 42", 54",

Laminate

Paint Finish

Electrics

**A-Leg**

Code	Price	H	W	D	Vol.	Wt.
No Grommet						
H-TAAN-294842	1742	29	48	42	5.0	69
H-TAAN-294854	1914	29	48	54	5.0	88
H-TAAN-296042	1868	29	60	42	6.0	86
H-TAAN-296054	2056	29	60	54	6.0	111
H-TAAN-297254	2230	29	72	54	7.0	133
H-TAAN-298454	2406	29	84	54	8.0	155
H-TAAN-424842	1938	42	48	42	5.0	100
H-TAAN-426042	2064	42	60	42	6.0	125
w/ Grommet						
H-TAAH-294842	2986	29	48	42	5.0	69
H-TAAH-294854	3158	29	48	54	5.0	88
H-TAAH-296042	3112	29	60	42	6.0	86
H-TAAH-296054	3302	29	60	54	6.0	111
H-TAAH-297254	3475	29	72	54	7.0	133
H-TAAH-298454	3648	29	84	54	8.0	155
H-TAAH-424842	3184	42	48	42	5.0	100
H-TAAH-426042	3309	42	60	42	6.0	125

**V-Leg**

Code	Price	H	W	D	Vol.	Wt.
No Grommet						
H-TAVN-294842	1634	29	48	42	5.0	69
H-TAVN-294854	1699	29	48	54	5.0	88
H-TAVN-296042	1718	29	60	42	6.0	86
H-TAVN-296054	1805	29	60	54	6.0	111
H-TAVN-297254	1896	29	72	54	7.0	133
H-TAVN-298454	2035	29	84	54	8.0	155
H-TAVN-424842	1810	42	48	42	5.0	100
H-TAVN-426042	1896	42	60	42	6.0	125
w/ Grommet						
H-TAVH-294842	2877	29	48	42	5.0	69
H-TAVH-294854	2944	29	48	54	5.0	88
H-TAVH-296042	2960	29	60	42	6.0	86
H-TAVH-296054	3045	29	60	54	6.0	111
H-TAVH-297254	3139	29	72	54	7.0	133
H-TAVH-298454	3281	29	84	54	8.0	155
H-TAVH-424842	3054	42	48	42	5.0	100
H-TAVH-426042	3138	42	60	42	6.0	125



Halifax Pricebook  
January 2026  
**Accessories**

Accessories

PET Acoustic board	176
Power	178
Purse Hook, Shelf, Metal Storage	179
Tasklight	180
Monitor Arm	181
Keyboard Tray	182

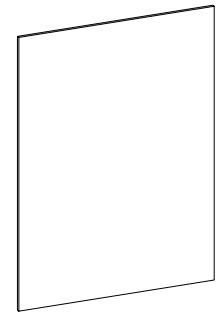

Gallery Wall Slim

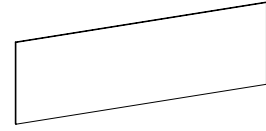

Gallery Wall/ Hutch - High Credenza

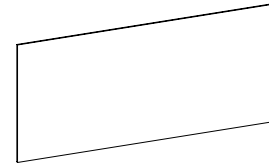

Gallery Wall/ Hutch - Low Credenza

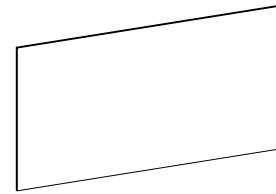

Locker Tower

**What's Included:**

- PET acoustic board

**How to Specify:**

**Notes:**

**Options:**

Widths: 9", 12", 18", 24", 26", 32", 38", 44", 50", 56", 62", 68", 74", 80", 86", 92"

Depths: 0.5"

Laminate

Paint Finish

Electrics

Code	Price	H	W	D	Volume	Weight
<b>For Gallery Wall Slim</b>						
H-PFG-3209	177	32	9	1	0.1	1
H-PFG-3212	201	32	12	1	0.1	2
H-PFG-3218	310	32	18	1	0.2	3
H-PFG-3224	326	32	24	0	0.2	4
<b>For Gallery Wall / Hutch - High Credenza</b>						
H-PFH-2226	342	22	26	1	0.2	3
H-PFH-2232	353	22	32	1	0.2	1
H-PFH-2238	457	22	38	1	0.3	4.18
H-PFH-2244	477	22	44	1	0.3	5
H-PFH-2250	677	22	50	1	0.3	6
H-PFH-2256	682	22	56	1	0.4	6
H-PFH-2262	689	22	62	1	0.4	7
H-PFH-2268	694	22	68	1	0.5	7
H-PFH-2274	812	22	74	1	0.5	8
H-PFH-2280	818	22	80	1	1.0	9
H-PFH-2286	827	22	86	1	1.0	9
H-PFH-2292	832	22	92	1	1.0	10
<b>For Gallery Wall / Hutch - Low Credenza</b>						
H-PFH-3126	344	31	26	1	0.2	4
H-PFH-3132	347	31	32	1	0.3	5
H-PFH-3138	463	31	38	1	0.4	6
H-PFH-3144	470	31	44	1	0.4	7
H-PFH-3150	677	31	50	1	0.5	8
H-PFH-3156	680	31	56	1	1.0	9
H-PFH-3162	685	31	62	1	1.0	10
H-PFH-3168	687	31	68	1	1.0	11
H-PFH-3174	812	31	74	1	1.0	11
H-PFH-3180	820	31	80	1	1.0	12
H-PFH-3186	827	31	86	1	1.0	13
H-PFH-3192	832	31	92	1	1.0	14
<b>For Locker Tower</b>						
H-PFL-4718	395	47	18	1	0.3	4
H-PFL-4724	399	47	24	1	0.3	5
H-PFL-6318	586	63	18	1	0.3	6
H-PFL-6324	680	63	24	1	0.3	7

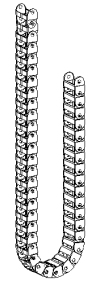

E-Chain Wire Manager

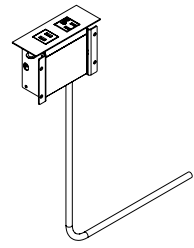

Side Mounted Module With Power And USB

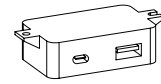

Side Mounted USB A & C, 1 Module, with AC Adapter

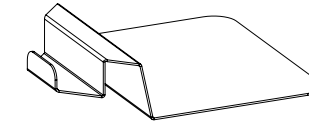
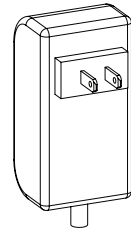

Purse Hook

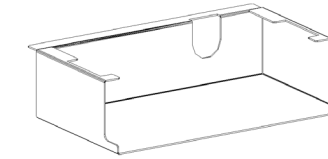

Under Mount Open Shelf

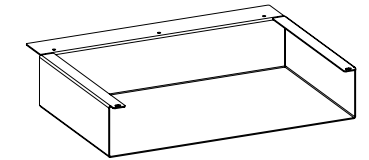

Metal Storage,- For Under Hutch

Code	Price	H	W	D	Volume	Weight
E-Chain Wire Manager						
V-EE-28	336	28	0	0	1.0	1.0
USB adapter (1ea USB A & C ports with adapter)						
V-ESMU-A	204				2.0	2.0
Side Mounted USB, 4 Module, With Hub						
V-ESMU-K	1134				2.0	2.0
Side Mounted Module With Power And USB						
V-ESMU-P	296				2.0	2.0
RJ11 Jack W/84" Cable						
H-RJ11	87				0.2	1.1
RJ45, Cat6 W/Cord 72", Black						
H-RJ45	233				0.2	1.2
HDMI Coupler, 18"Cord,F/F						
H-HDMI	225				0.2	1.1

Code	Price	H	W	D	Volume	Weight
Purse Hook						
H-APH	198	0	0	0	2.2	0.5
Under Mount Open Shelf						
H-AUS-1209	161	3	12	9	0.3	1
Metal Storage,For Under Hutch						
H-SHUS-031409	167	4	14	10	0.0	0

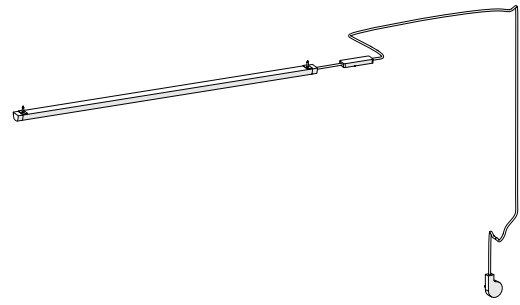

Halifax LED Light 30"(1) with transformer, Wire manager, Mounting Plate and hardware

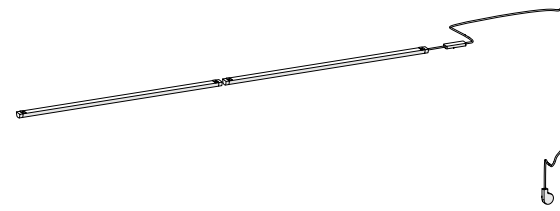

Halifax LED Light 30"(2) with transformer, Wire manager, Mounting Plate and hardware

**What's Included:**

- LED Tasklight
- Transformer
- Mounting Plate
- Mounting Hardware

**How to Specify:**

3666 fits under overheads between 36"-66"W  
7284 fits under overheads between 72-84"W

**Notes:**

7284 consists of two 30" lights  
Hardware includes screws for wood overhead and magnets for metal overheads

**Options:**

Available in Silver only

Code	Price
Tasklight	
V-ELU-3666	481
V-ELU-7284	891

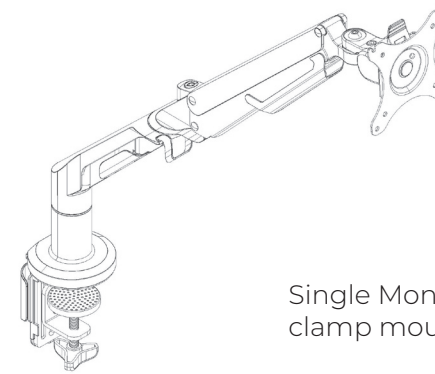

Single Monitor Arm - clamp mount

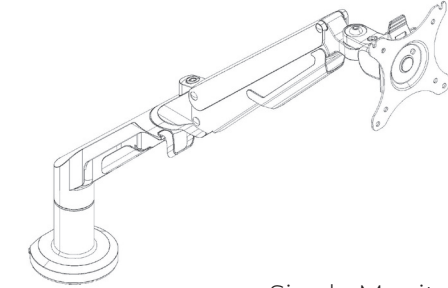

Single Monitor Arm - grommet mount

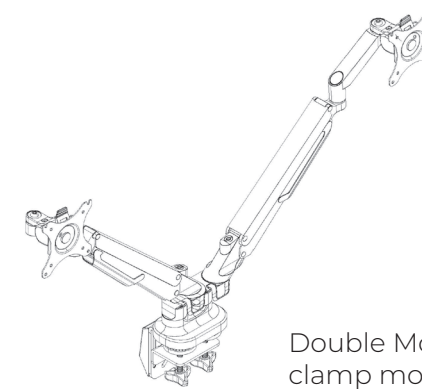

Double Monitor Arm - clamp mount

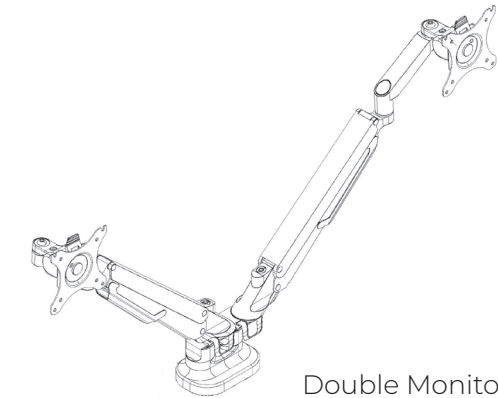

Double Monitor Arm - grommet mount

**What's Included:**

One monitor arm and installation hardware for both clamp and grommet mount

**How to Specify:**

- Specify type

**Notes:**

Available in silver only  
Single Monitor Arm  
• Screen Size - 17"-36"  
• Load Capacity - 6.6-26.4lbs/3-12kg  
• Tilt Range - -90 degrees - -15 degrees  
Dual Monitor Arm  
• Screen Size - 17"-32"  
• Load Capacity - 4.4-19.8lbs/2-9kg  
• Tilt Range - -90 degrees - -15 degrees

**Dimensions:**

Vesa: 75x75 and 100x100

Code	Price
Monitor Arm - Single Mount	
V-AFMA-01	426
Monitor Arm - Double Mount	
V-AFMA-02	711

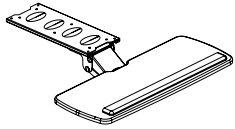

Articulating Keyboard Tray

### What's Included:

Keyboard Tray, installation hardware.

### How to Specify:

The articulating keyboards are available only in black.

### Notes:

Keyboard trays provide adjustable ergonomic support for individuals in multi-task environments

Code	Price	H	W	D	Volume (ft <sup>3</sup> )	Weight (lb)
Articulating Keyboard Tray						
V-KASX-2510	459	25	25	10	15.0	0.94