

The logo for Tayco, featuring the word "tayco" in a lowercase, sans-serif font with a registered trademark symbol (®) to the upper right. The background of the cover is split into three geometric sections: a large orange triangle on the left, a white triangle at the top right, and a dark grey triangle at the bottom right.

tayco®

Switch USA
Pricebook
April 2024

Contents

Statement of Line	vi
Space Division	vi
Worksurface & Supports	viii
Connections & Trims	x
Storage	xi
Electrics	xii
Accessories	xii
Segment Types	xiii
Cautions	xiv
Application Guidelines	xv
Types of Surfaces	xv
Gallery Panel Planning	xvi
Connection Types - Panel Doors	xvii
Connection Types - Sliding Doors	xviii
Connection Types - Fillers	xix
Wire Play Planning	xxi
Panels	3
Standard Panel - Monolithic	4
Non Powered Capable	4
Powered Capable	8
Standard - Glazed	12
Non Powered	12
Powered	28
Elevated - Monolithic	44
Elevated - Glazed	48
Gallery - Woodgrain	64
Horizontal Grain	64
Vertical Grain	76
Gallery - Solid	88
Frameless Blade	100
Standard & Elevated Panel Mounted Glass	100
Standard & Elevated Panel Mounted Acrylic	102
Gallery Panel Mounted Glass	104
Gallery Panel Mounted Acrylic	106

Panel Mounted Add Ons	108
Whiteboard	108
Tackboard	109
Doors	110
Hinged	110
Sliding	112
Connections & Trims	117
2-Way Connection	118
3-Way T Connection	119
4-Way X Connection	120
Top Cap	121
Full Height End Trim	122
Partial Height End Trim	123
Full Height T Filler	124
Partial Height T Filler	125
90 Degree Filler-Full Height	126
90 Degree Filler- Partial Height	127
Straight Filler	128
Gallery Panel Filler	129
Adjustable Connections and Trims	130
Worksurface	133
Straight w grommet	134
Straight Worksurface w/o Grommet	136
Straight Worksurface w/ Wire Play	140
5-sided w Grommet	144
Straight Worksurface with Wire Play	146
Unitized w/ Grommet	148
Unitized w/ Wire Play	150
Transaction Top	152

Supports	155
Ladder Gable	156
Standard Panel	156
Gallery Panel	158
Freestanding Panel	160
Laminate Gable	161
Standard Panel	161
Gallery Panel	162
Freestanding	163
Wrap Gable	164
Standard Panel	164
Gallery Panel	165
Tech Drop	166
Cantilever	167
Standard Panel	167
Gallery Panel	168
Standard Panel Mount Corner Bracket	170
Flush Plates	171
Storage Support Bracket	172
Fixed Credenza Support Bracket	173
90 Degree Storage Bracket	174
Horizontal Surface Support	175
Electrics	177
Power Module	178
Power & Data	179
Connector Harness	180
Male to Female Extension Harness	182
New York Junction Box	183
Chicago Electrical Box	184
Wire Manager	185
Communication Kit	186
Conversion Kit	187

Storage	189
Pedestals	190
Underdesk Pedestal	190
Mobile	191
Upholstered Seat Pad	192
Lateral File	193
Underdesk	193
Freestanding	194
Credenza	195
Open Lateral	195
Storage Tower	196
Wardrobe Tower	197
Combo Tower	198
w/ Front Access	198
w/ Side Access	200
Panel Mounted Overheads - Cabinet	202
Flipper	202
Hinged Door	203
Shared	204
Cubby	206
Metal Shelf	207
Accessories	209
Cable manager	210
Desktop Power Module	211
Tasklight	212
Monitor Arm	213
Keyboard Tray	214
Work Organizers	215
Accessory Rail	216
Pencil Tray	217

Statement of Line

Space Division

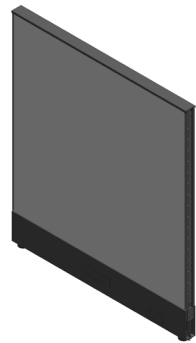

L-PPFO
Standard Fabric Panel
H: 34", 42", 50", 66", 82"
W: 24" - 72"
*66"H available up to 60"W
*82"H available up to 48"W

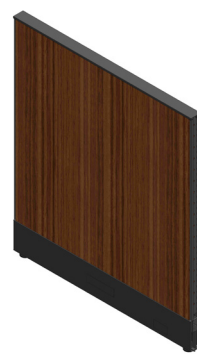

L-PPLO
Standard Laminate Panel
H: 34", 42", 50", 66", 82"
W: 24" - 48"
*82"H available up to 36"W



L-PPFCA/LPPFCG
L-PPFFA/L-PPFFG
Standard Segmented Laminate Panel
H: 34", 42", 50", 66", 82"
W: 24" - 60"
*82"H available up to 48"W



L-PPLCA/LPPLCG
L-PPLFA/L-PPLFG
Standard Segmented Laminate Panel
H: 34", 42", 50", 66", 82"
W: 24" - 60"
*82"H available up to 36"W



L-PYSE-S1/ L-PYSM-S1
Solid Single Gallery Panel
H: 34", 42", 50"
W: 26" - 74"



L-PYGE-S1/L-PYSM-S1
Woodgrain Single Gallery Panel
H: 34", 42", 50"
W: 26" - 56"



L-PD00
Hinge Door
H: 82"
W: 36", 42"

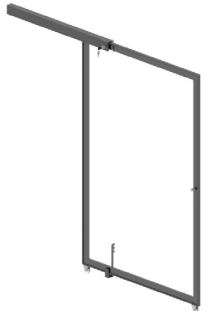

L-PDS
Sliding Door
H: 66"
W: 30", 36", 42"

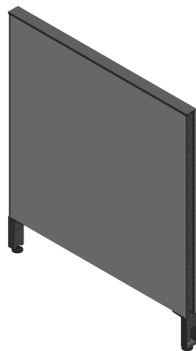

L-PEFO
Elevated Fabric Panel
H: 34", 42", 50", 66", 82"
W: 24" - 72"
*66"H available up to 60"W
*82"H available up to 48"W



L-PELO
Elevated Laminate Panel
H: 34", 42", 50", 66", 82"
W: 24" - 48"
*82"H available up to 36"W

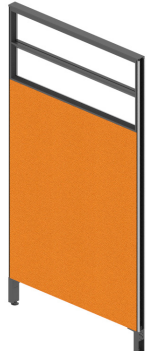

L-PEFCA/LPEFCG
L-PEFFA/L-PEFFG
Elevated Glazed Fabric Panel
H: 34", 42", 50", 66", 82"
W: 24" - 60"
*82"H available up to 48"W



L-PELCA/LPELCG
L-PELFA/L-PELFG
Elevated Glazed Laminate Panel
H: 34", 42", 50", 66", 82"
W: 24" - 60"
*82"H available up to 36"W

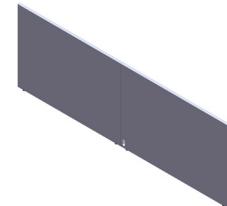

L-PYSE-D1/D2/ L-PYSM-D1/D2
Solid Double Gallery Panel
H: 34", 42", 50"
W: 42" - 146"

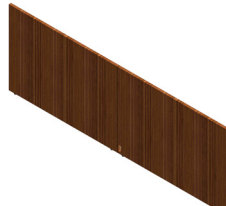

L-PYGE-01/02/ L-PYGM-D1/D2
Woodgrain Double Gallery Panel
H: 34", 42", 50"
W: 42" - 110"

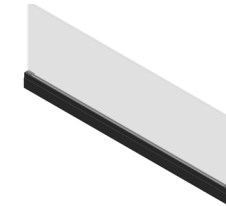

L-VG-P/ L-VA-P
Frameless Glass Standard Panel Mount
H: 8", 16", 20"
W: 24" - 72"

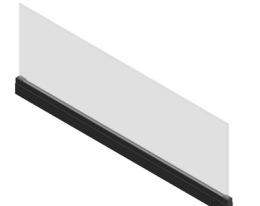

L-VG-Y/ L-VA-Y
Frameless Glass Gallery Panel Mount
H: 8", 16"
W: 24" - 60"

Worksurface & Supports



L-HCB
Corner Bracket
H: 3"
W: 4"

L-PWW
Mending Plate
D: 4"
W: 6"

L-HSSE-Y
Return Support Gallery
Panel Mount with Power
H: 3"
W: 24", 30"

L-HSSE-P
Return Support Standard
Mount with Power
H: 3"
W: 24", 30"

L-HCFM
Credenza Support
H: 8"
W: 4"



L-CCAB
Cantilever
H: 8"
D: 16", 22"

L-HSSB
Storage Support Bracket
H: 3"
D: 1"



L-WTT
Transaction Top
D: 15"
W: 24" - 60"

L-WS00
Straight Worksurface
W: 24" - 96"
D: 20", 24", 30"

L-WS00
Straight Worksurface with
Cropped Depth
W: 23" - 96"
D: 19" - 30"

L-WS0G
Straight Worksurface with
Grommets
W: 24" - 96"
D: 20", 24", 30"

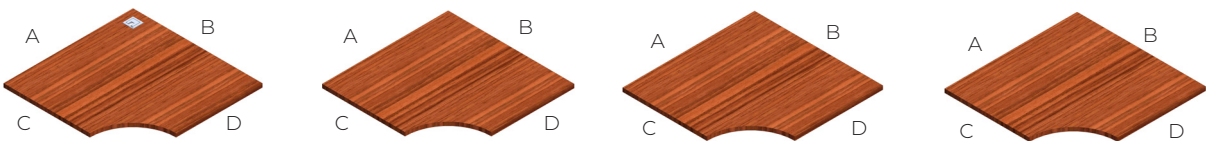

L-W5C0
5 Corner Curved Worksurface
with Grommet
A: 36" - 48"
B: 36" - 48"
C: 24" - 30"
D: 24" - 30"

**5 Corner Curved Worksurface
with Double Hand Cropped
Depth**
A: 35" - 47"
B: 35" - 47"
C: 23" - 39"
D: 23" - 29"

**5 Corner Curved Worksurface
with Left Hand Cropped
Depth**
A: 36" - 48"
B: 35" - 47"
C: 23" - 39"
D: 24" - 30"

**5 Corner Curved Worksurface
with Right Hand Cropped
Depth**
A: 35" - 47"
B: 36" - 48"
C: 24" - 30"
D: 23" - 29"

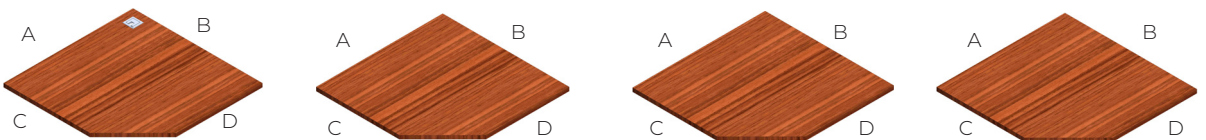

**5 Corner Straight Worksurface
with Grommet**
A: 36" - 48"
B: 36" - 48"
C: 24" - 30"
D: 24" - 30"

**5 Corner Straight Worksurface
with Double Hand Cropped
Depth**
A: 35" - 47"
B: 35" - 47"
C: 23" - 39"
D: 23" - 29"

**5 Corner Straight Worksurface
with Left Hand Cropped
Depth**
A: 36" - 48"
B: 35" - 47"
C: 23" - 39"
D: 24" - 30"

**5 Corner Straight Worksurface
with Right Hand Cropped
Depth**
A: 35" - 47"
B: 36" - 48"
C: 24" - 30"
D: 23" - 29"

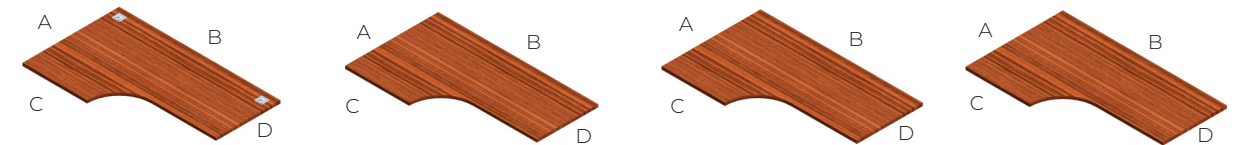

L-WUCG
Unitized Curved Worksurface
with Grommets
A: 36"
B: 54" - 96"
C: 24"
D: 24"
RH Shown

L-WUC0
Unitized Curved Worksurface
with Side A Cropped Depth
A: 35"
B: 54" - 96"
C: 24"
D: 23"
RH Shown

**Unitized Curved Worksurface
with Side B Cropped Depth**
A: 36"
B: 53" - 95"
C: 23"
D: 24"
RH Shown

**Unitized Curved Work-
surface with Side A & B
Cropped Depth**
A: 35"
B: 53" - 95"
C: 23"
D: 23"
RH Shown

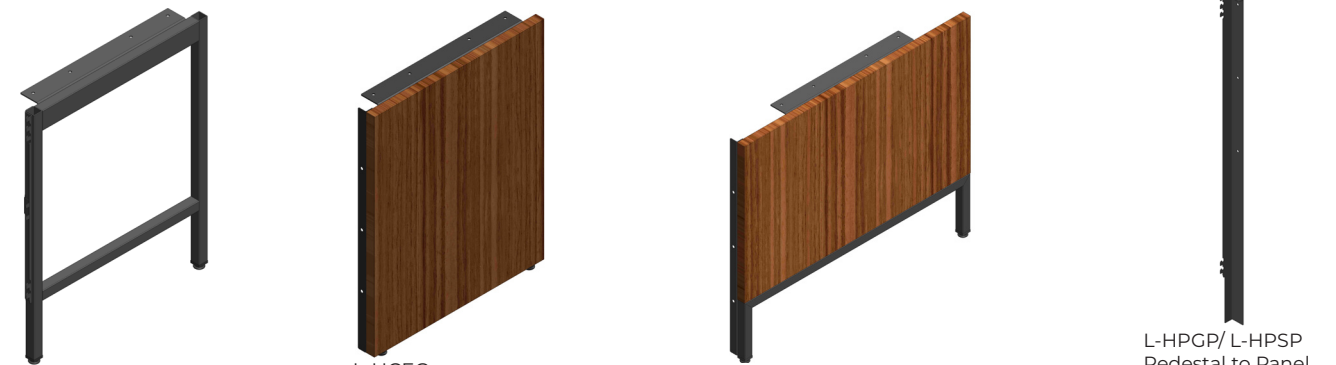

L-HOEG/ L-HOMG
Ladder Leg
H: 25", 28"
D: 20", 24", 30"

L-HCEG
Laminate Gable Leg
H: 25", 28"
D: 20", 24", 30"

L-HWEG
Wrap Gable
H: 25", 28"
D: 20", 24", 30"

L-HPGP/ L-HPSP
Pedestal to Panel
Bracket
H: 28"
W: 1", 7"

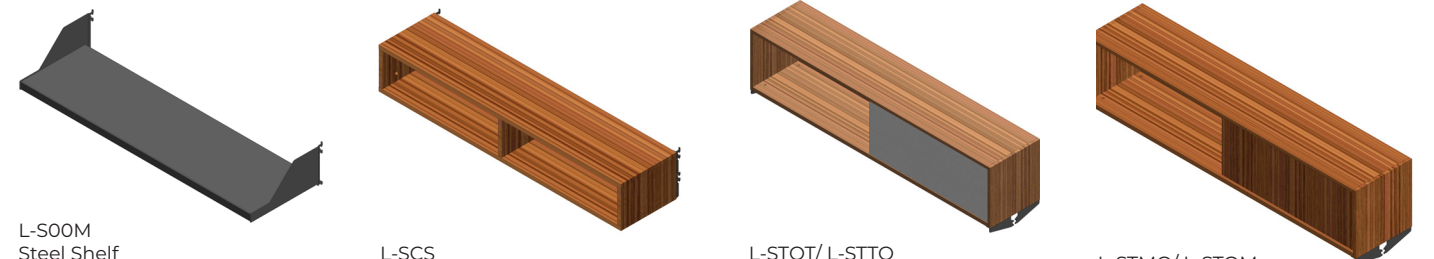

L-S00M
Steel Shelf
H: 6"
W: 30" - 60"
D: 12"

L-SCS
Cubby
H: 8"
W: 24" - 48"
D: 11"

L-STOT/ L-STTO
Shared Overhead with Tack-
board
H: 16"
W: 36" - 72"
D: 15"

L-STMO/ L-STOM
Shared Overhead
H: 16"
W: 36" - 72"
D: 15"



L-SPLO/ L-SPOL
Split Overhead Cabinet
H: 16"
W: 36" - 60"
D: 12"

L-SPFL/ L-SPFM
Flipper Cabinet
H: 16"
W: 30" - 60"
D: 14"

L-FL2F
2D Freestanding Lateral
H: 29"
W: 30", 36"
D: 24"

L-FL3F
3D Freestanding
Lateral
H: 42"
W: 30", 36"
D: 24"

L-FL4F
4D Freestanding
Lateral
H: 54"
W: 30", 36"
D: 24"

Connections & Trims

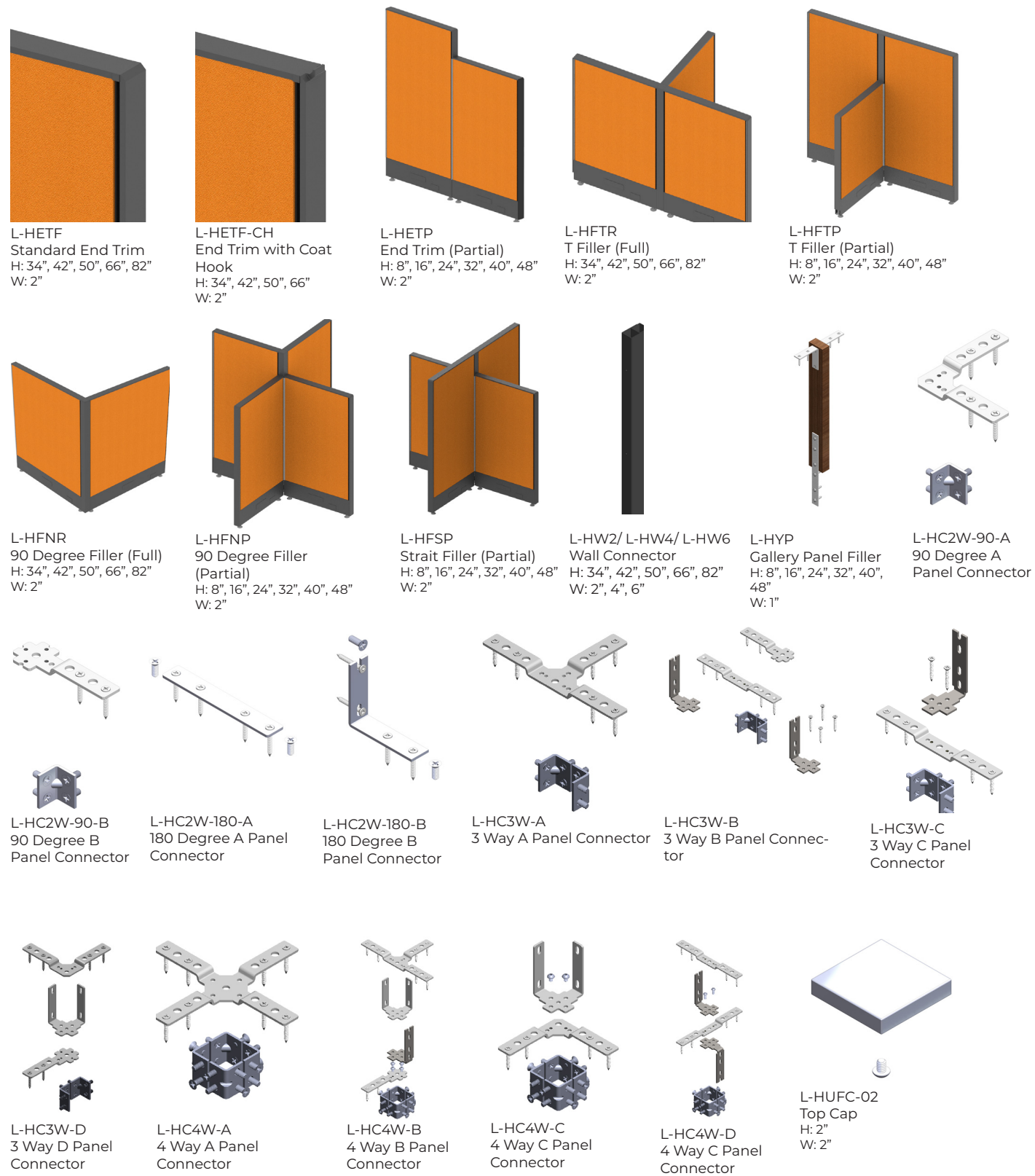

Storage

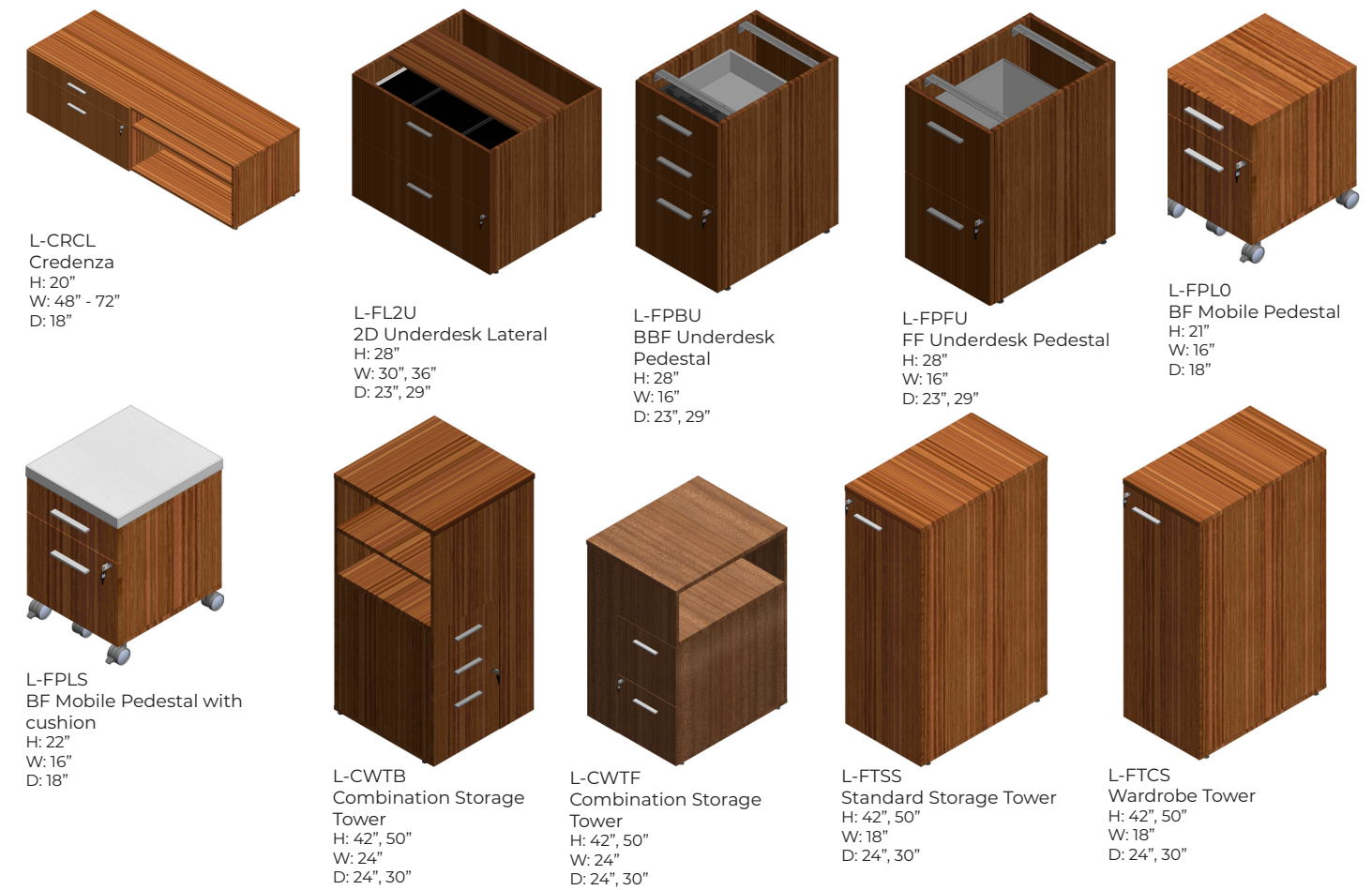

Electrics



Accessories

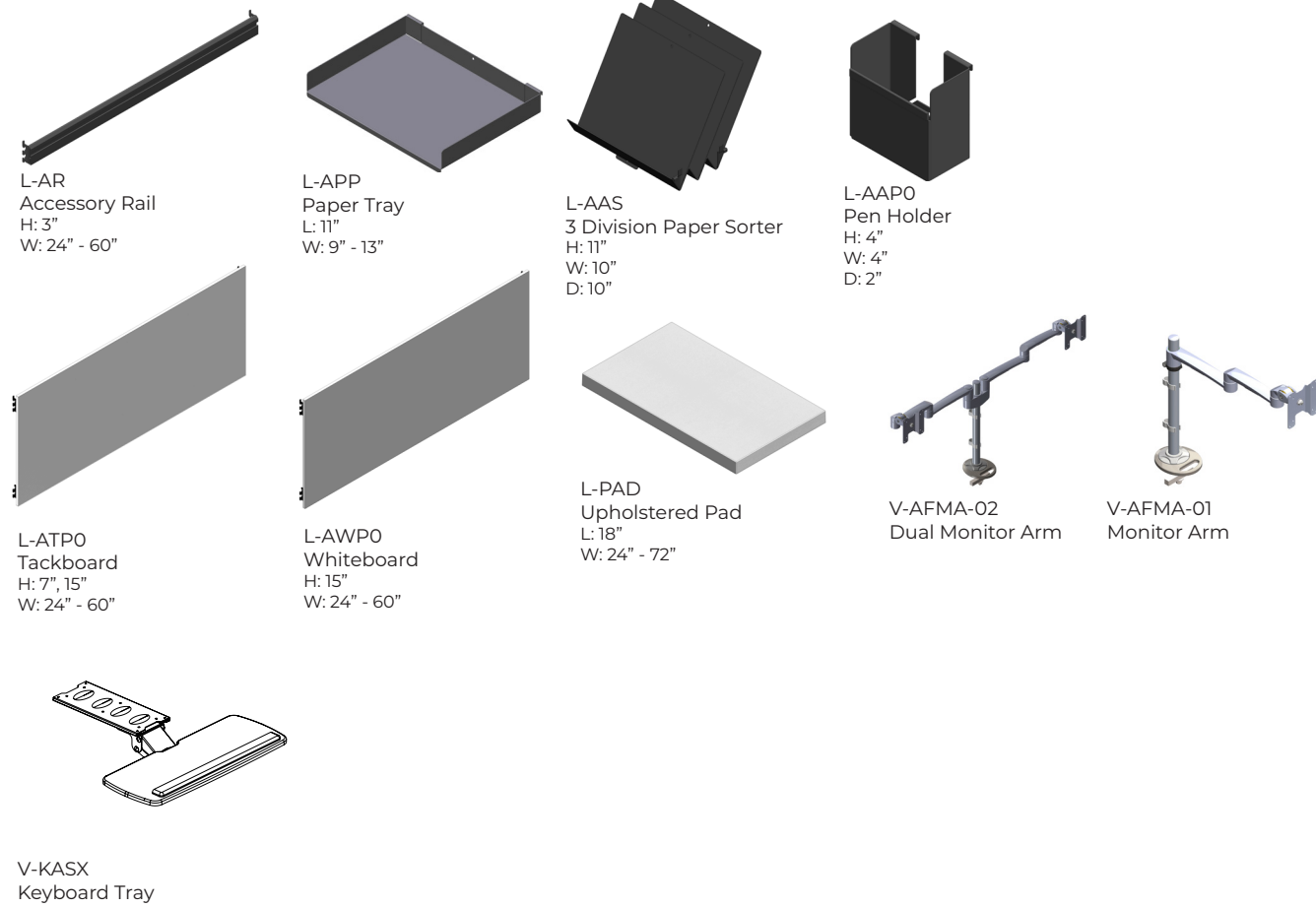

Segment Types

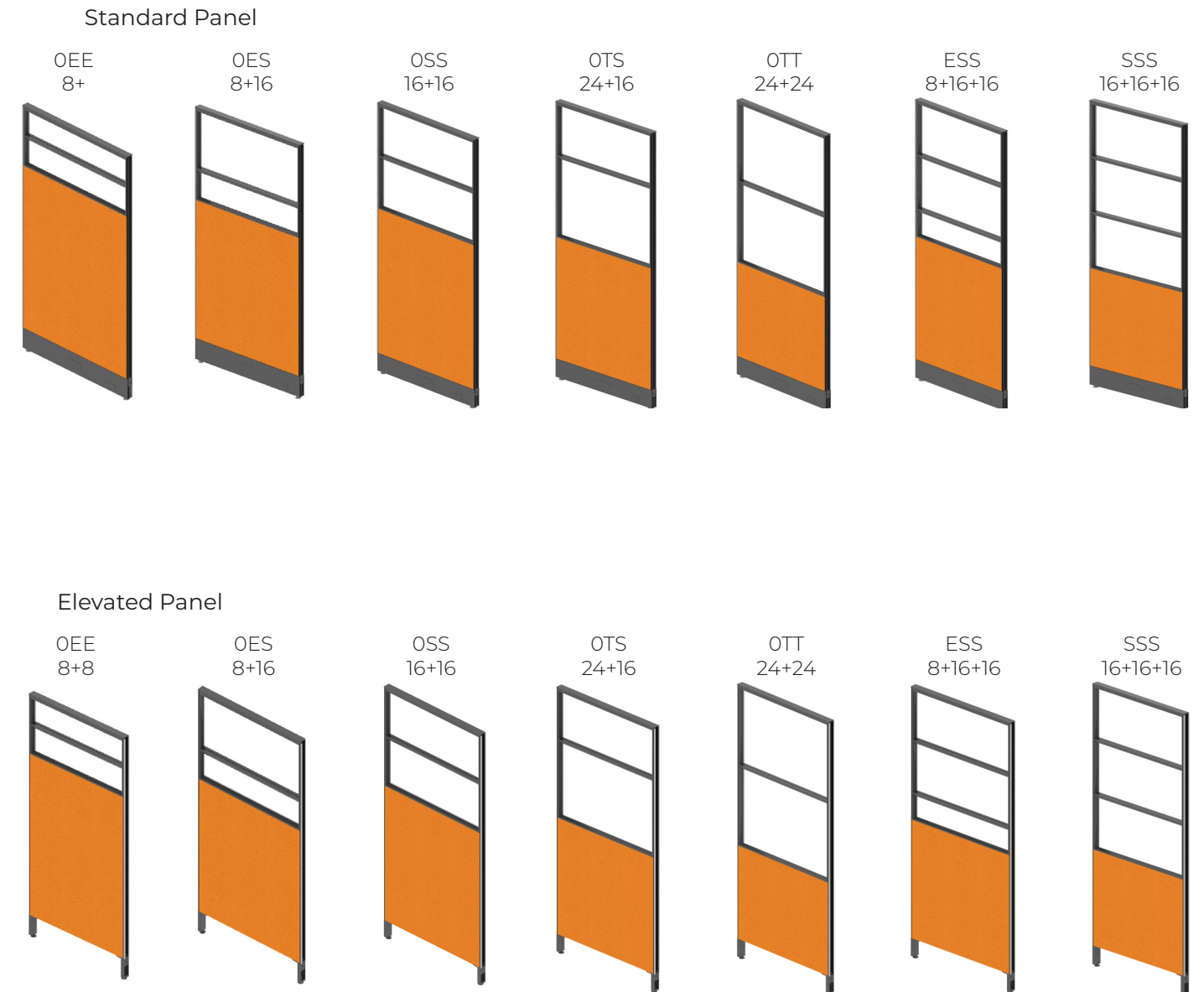

Caution

Load Bottom Drawer First

- Operate one drawer at a time
- Units may tip if loaded incorrectly
- Units should be attached to a wall or other furniture to reduce tipping hazard
- Always load the heaviest files in the bottom drawer

Heavy Load

- Some products must be anchored to wall to ensure stability & safety.
- It is the owner and installers responsibility to ensure that the wall type and construction is of sufficient strength to carry the loads of any wall mounted products and their contents.
- Failure of the wall and anchors to support all imposed loads may result in property damage and/or personal injury.
- Tayco can provide size and empty weight of its products only. As wall blocking is considered a building construction process, Tayco cannot provide recommendations in this respect and cannot be responsible for damage or injury that may occur as a result of improper installation and/or blocking.

Instability Hazard

Mobile items on casters such as flip top, personal and movable tables of any type and storage items of any type may present an instability hazard if not secured correctly while in use or in storage. Flip top tables or training tables of any type, are inherently more unstable when folded. Tayco provides the following guidelines & warnings when using mobile products:

- Lock casters immediately after moving. Do not leave the casters unlocked when in use or in storage.
- Motion may increase the instability of any item with casters. If the wheels hit an obstruction the table's forward momentum often causes overturn, especially if the item is not equipped with wheel extensions. Exercise strong caution while moving these items.
- Use caution when abrupt level changes in the floor are present (such as a doorway or room threshold) as caster failure or tipping may result.
- Do not stand, sit or lean on mobile items for support. They are not intended for this use and personal injury or property damage may result.
- Mobile units that feature height adjustable elements must be lowered to the minimum compressed height when moving to prevent instability. It is also recommended the user remove all computer equipment or other accessories to prevent possible weight imbalance or damage to equipment.
- Failure to follow the guidelines above may result in property damage or personal injury.

Application Guidelines

Types of Surfaces

no grommet

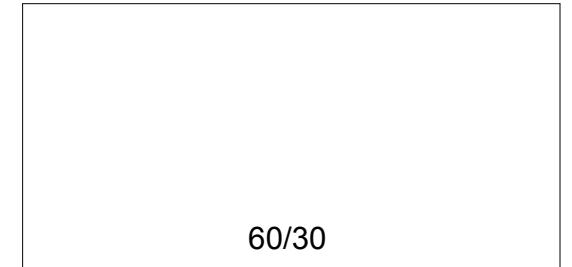
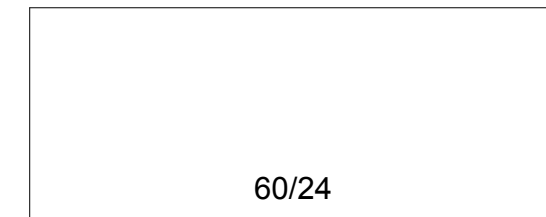

with grommet

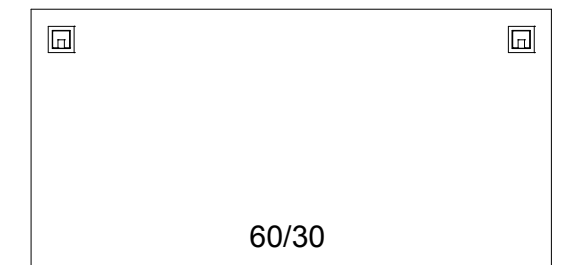
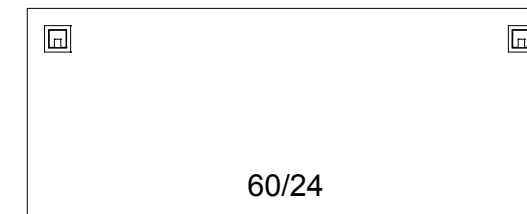

wireplay

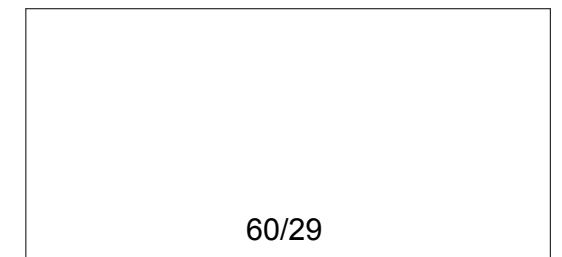
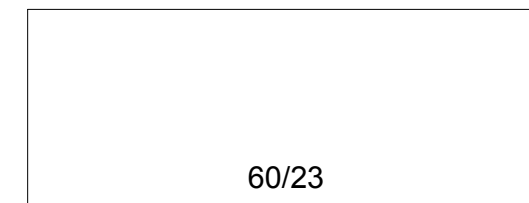

Gallery Panel Planning

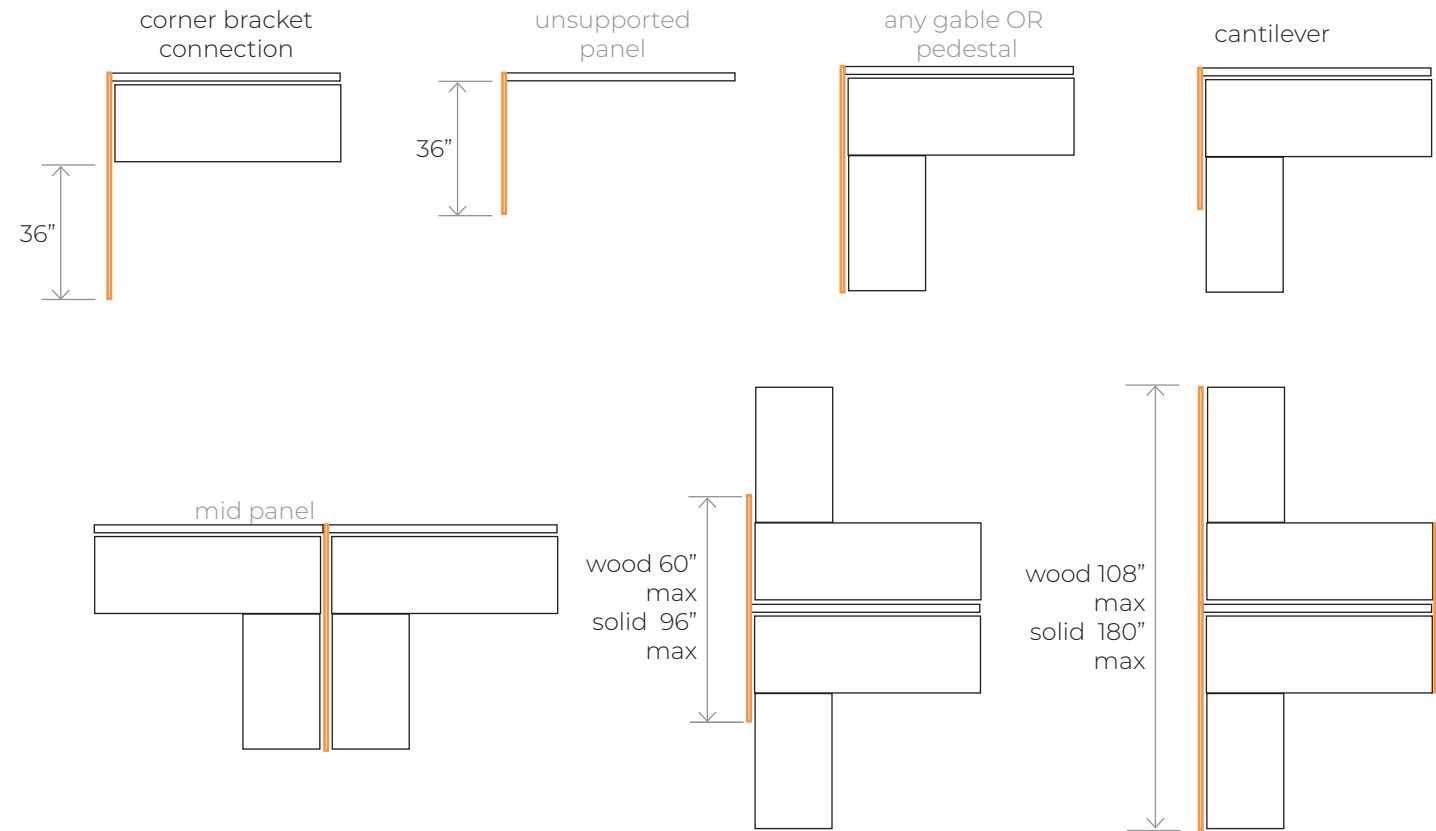

Connection Types - Panel Doors

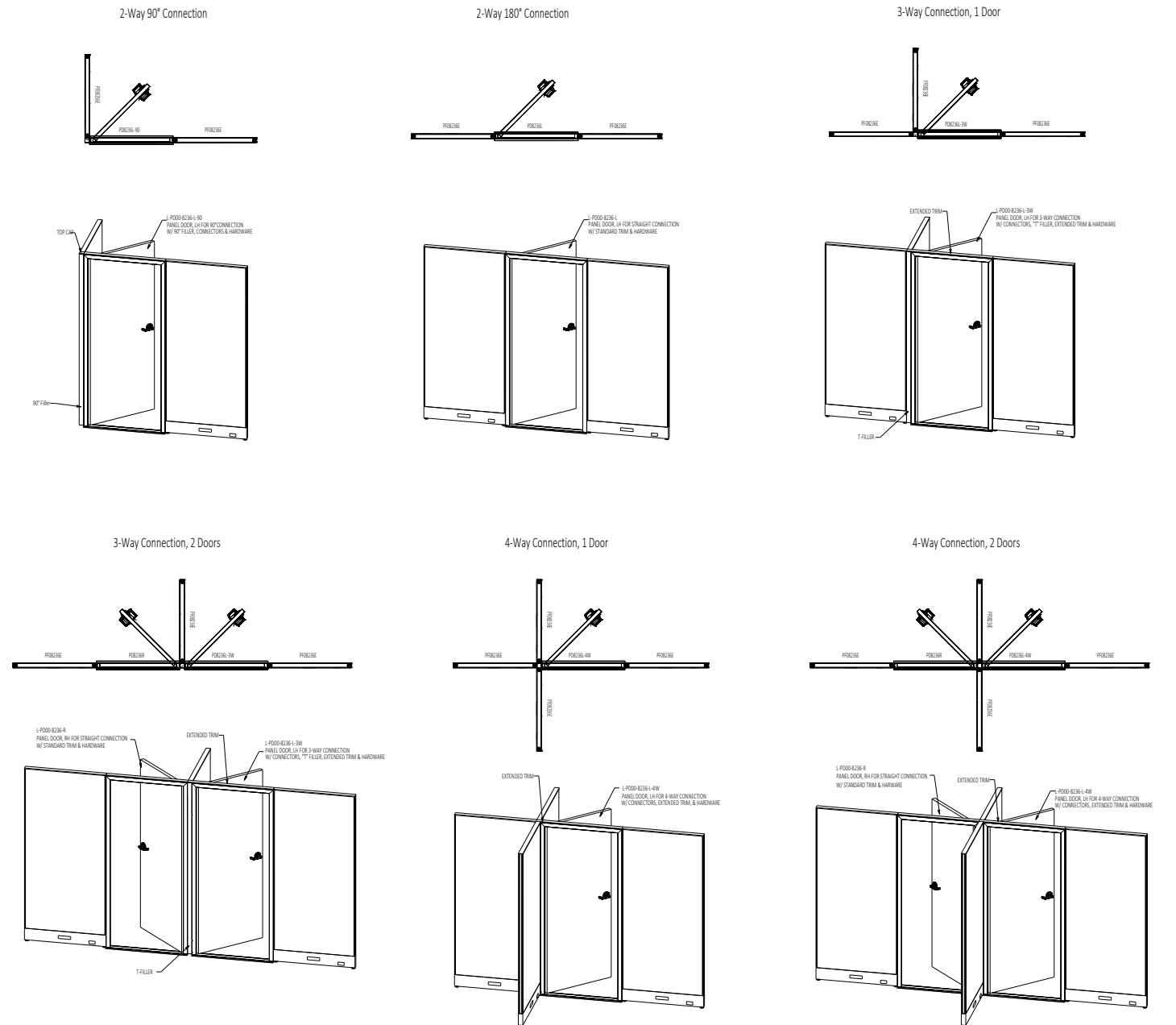

Connection Types - Sliding Doors

2-Way 90° Connection

2-Way 180° Connection

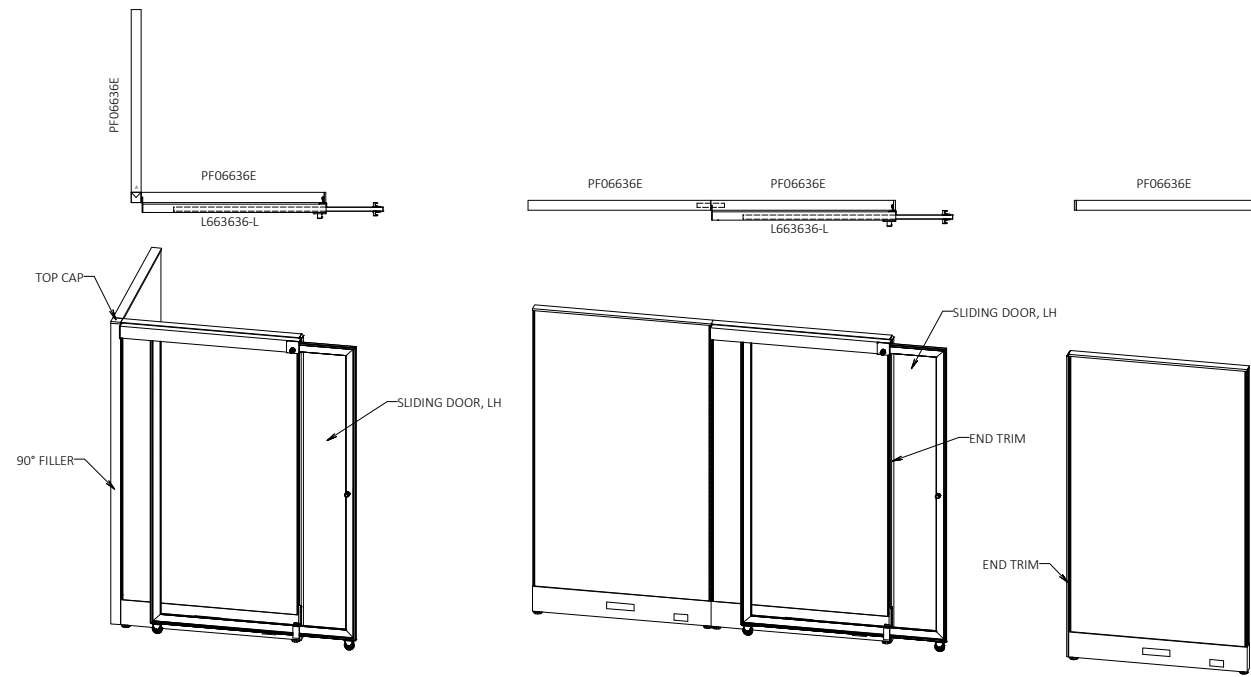

3-Way Connection, 1 Door

3-Way Connection, 2 Doors

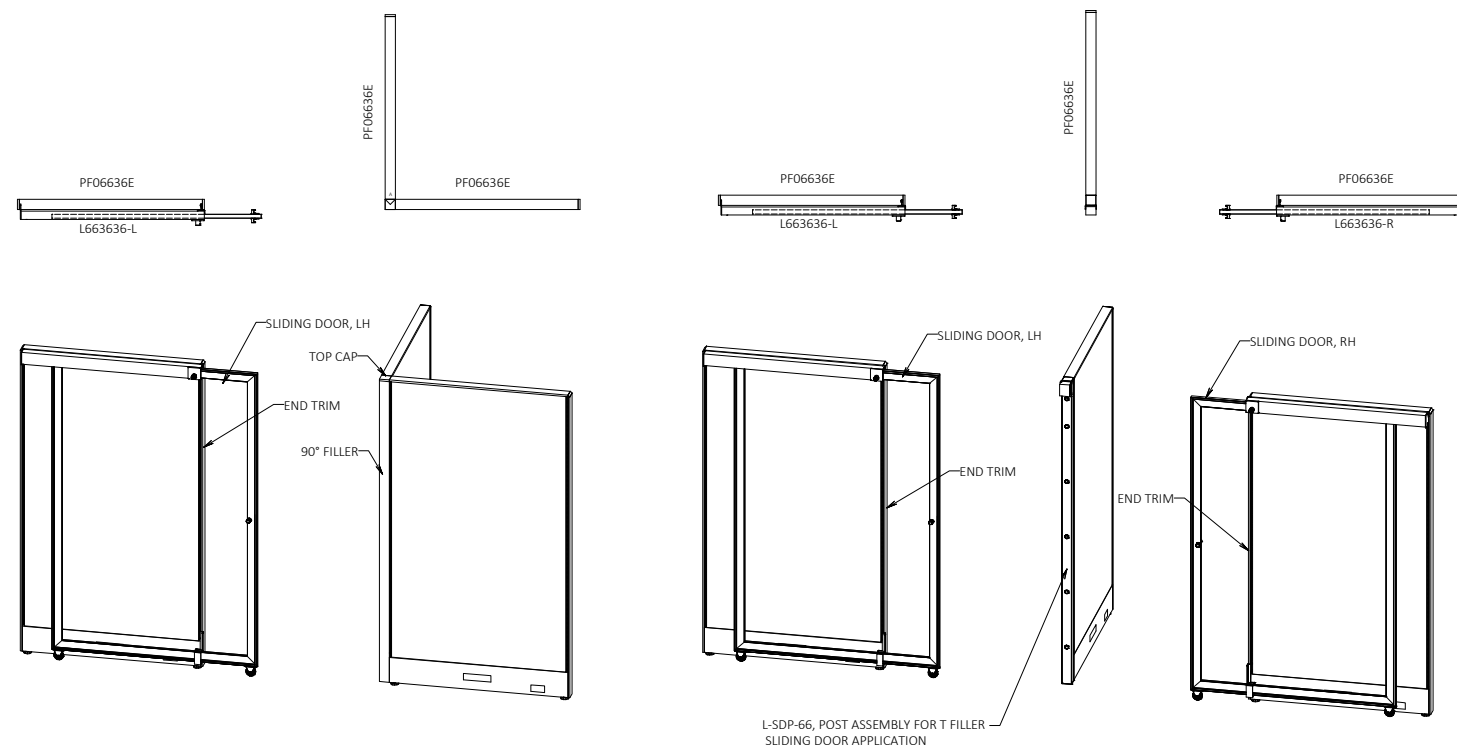

Connection Types - Fillers

2-Way 90° Connection

2-Way 180° Connection

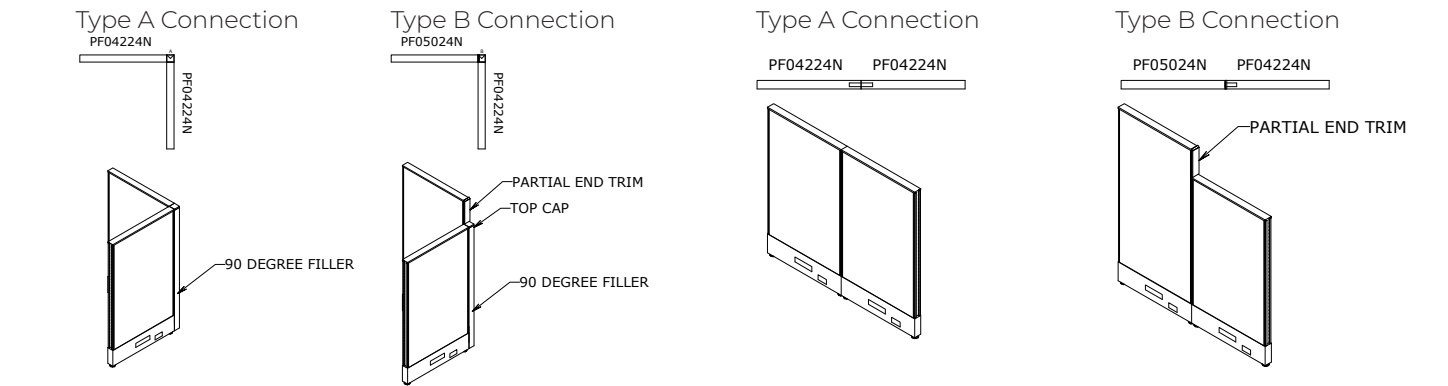

3-Way Connection

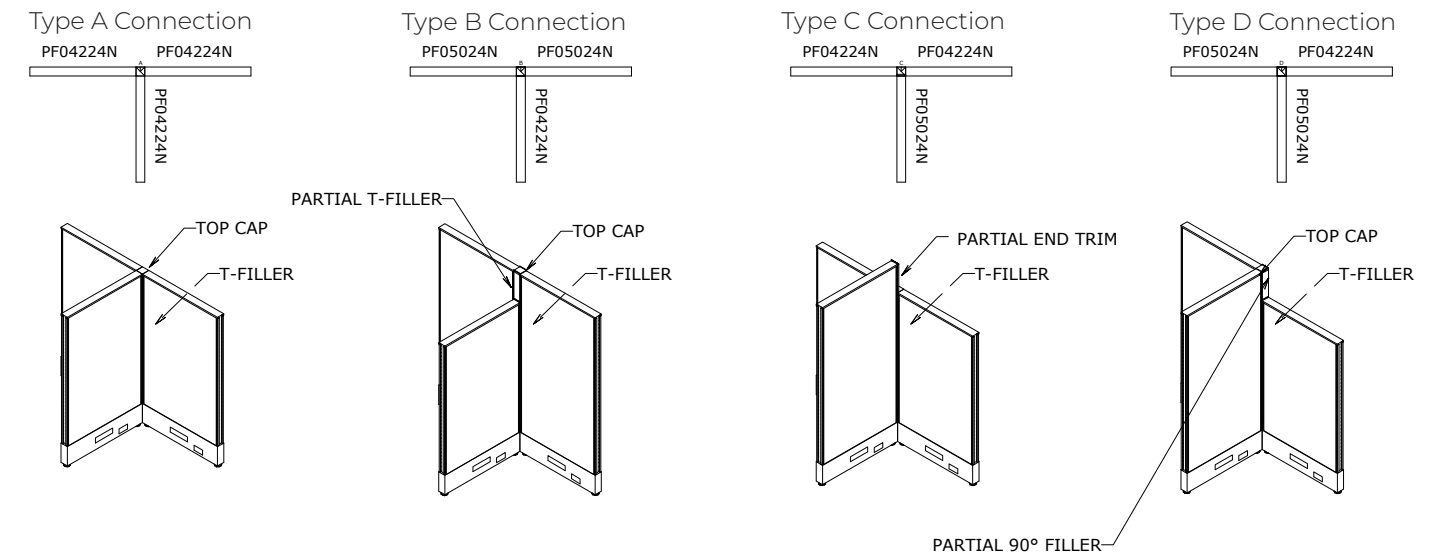

4-Way Connection

Type A Connection

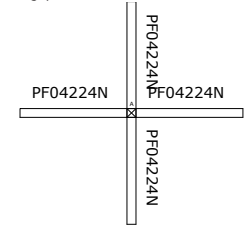

Type B Connection

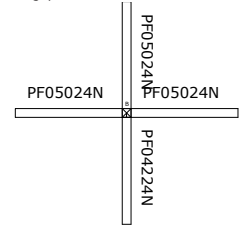

Type C Connection

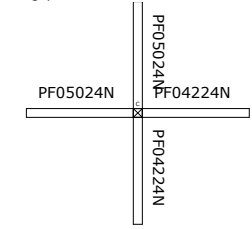

Type D Connection

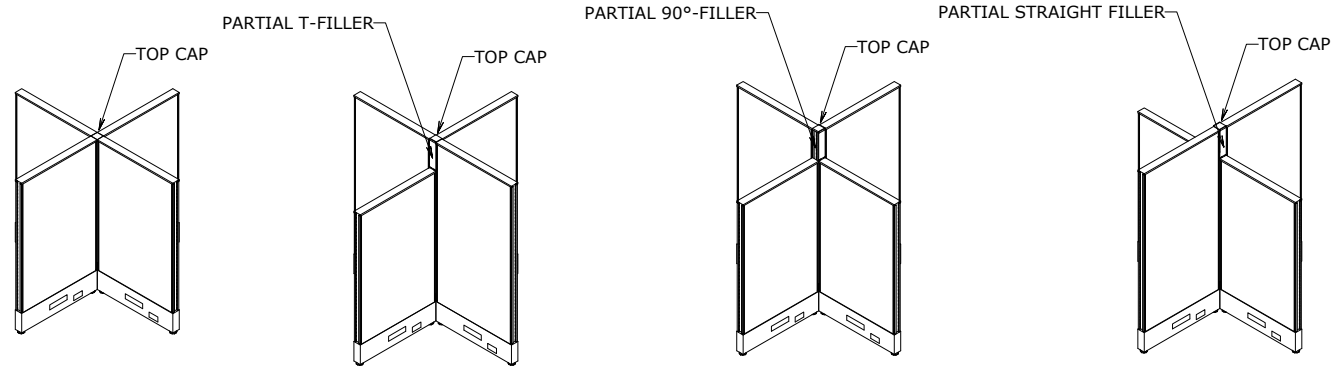
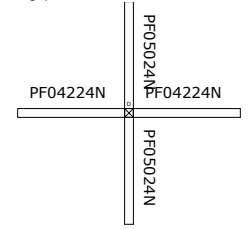

Wire Play Planning

1" wire play along spine

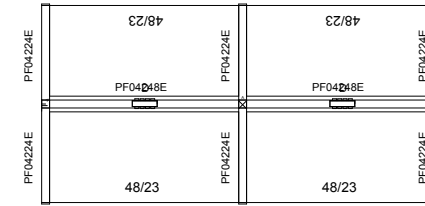

1" wire play along spine

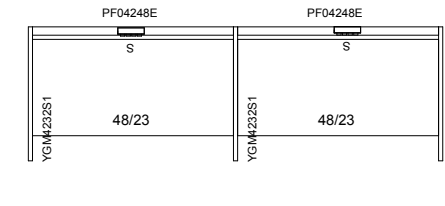

1" wire play along all surfaces

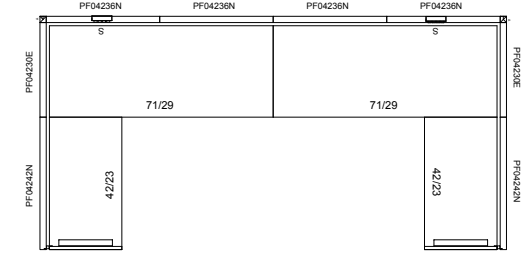

1" wire play along all surfaces

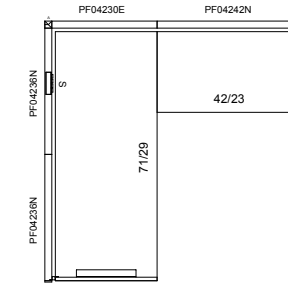

1" wire play along return

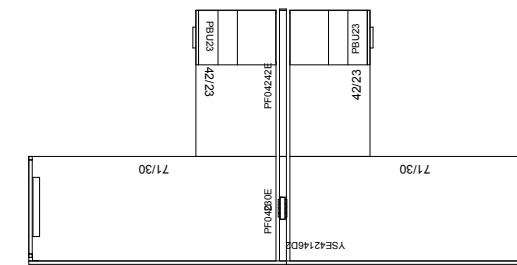

1" wire play along spine

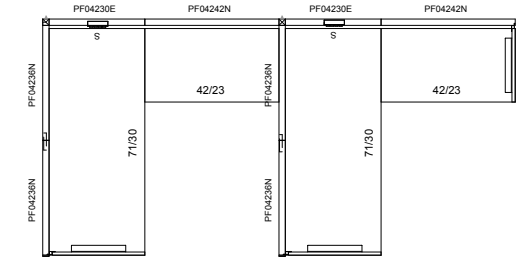

1" wire play along spine and worksurface

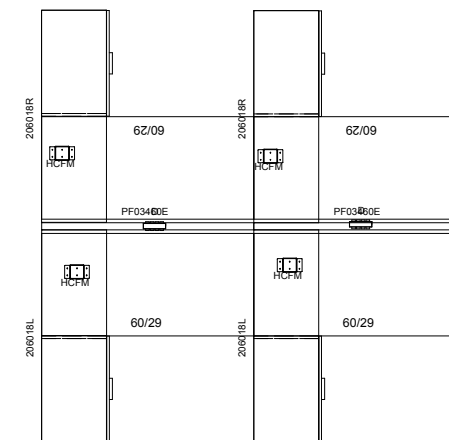

1" wire play along spine and worksurface

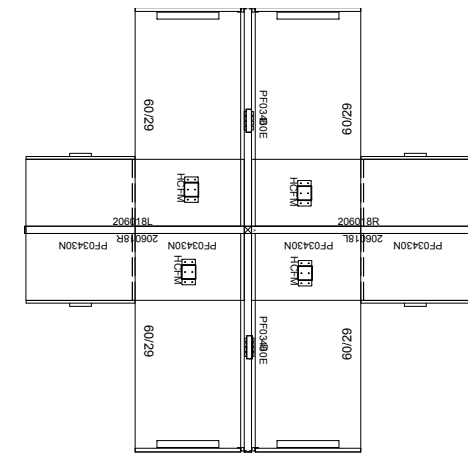



Switch USA Pricebook
November 2024
Panels

Panels

Standard Panel - Monolithic	4	Gallery - Woodgrain	64
Non Powered Capable	4	Horizontal Grain	64
Fabric	4	Single Span Middle	64
Laminate	6	Double Span Middle	66
Powered Capable	8	Single Span End /No Cutout	68
Fabric	8	Single Span End/w Cutout	70
Laminate	10	Double Span End /No Cutout	72
Standard - Glazed	12	Double Span End/w Cutout	74
Non Powered	12	Vertical Grain	76
Fabric/Clear Acrylic	12	Single Span Middle	76
Fabric/Frosted Acrylic	14	Double Span Middle	78
Fabric/Clear Glass	16	Single Span End /No Cutout	80
Fabric/Frosted Glass	18	Single Span End /w Cutout	82
Laminate/Clear Acrylic	20	Double Span End/No Cutout	84
Laminate/Frosted Acrylic	22	Double Span End /w Cutout	86
Laminate/Clear Glass	24	Gallery - Solid	88
Laminate/Frosted Glass	26	Single Span Middle	88
Powered	28	Double Span Middle	90
Fabric/Clear Acrylic	28	Single Span End /No Cutout	92
Fabric/Frosted Acrylic	30	Single Span End /w Cutout	94
Fabric/Clear Glass	32	Double Span End/No Cutout	96
Fabric/Frosted Glass	34	Double Span End /w Cutout	98
Laminate/Clear Acrylic	36	Frameless Blade	100
Laminate/Frosted Acrylic	38	Standard & Elevated	
Laminate/Clear Glass	40	Panel Mounted Glass	100
Laminate/Frosted Glass	42	Standard & Elevated	
Elevated - Monolithic	44	Panel Mounted Acrylic	102
Fabric	44	Gallery Panel Mounted Glass	104
Laminate	46	Gallery Panel Mounted Acrylic	106
Elevated - Glazed	48	Panel Mounted Add Ons	108
Fabric/Clear Acrylic	48	Whiteboard	108
Fabric/Frosted Acrylic	50	Tackboard	109
Fabric/Clear Glass	52	Doors	110
Fabric/Frosted Glass	54	Hinged	110
Laminate/Clear Acrylic	56	Sliding	112
Laminate/Frosted Acrylic	58	Clear Acrylic	113
Laminate/Clear Glass	60	Frosted Acrylic	114
Laminate/Frosted Glass	62	Fluted Acrylic	115

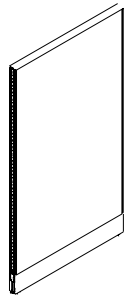

Standard Monolithic
Non-Powered Fabric Panel

What's Included:

One (1) 2" thick fabric panel with
1" incremented slotted channels,
Two (2) raceway covers,
One (1) top trim

How to Specify:

Refer to panel fabric cards for fabric selections
Choose White, Black, Silver, Charcoal for Panel
Frame colour

Notes:

Non-power capable panel.
Can be used in run with power-capable
panels and allows wires to pass through.
Panels are non tackable. For tackable
option see Panel Add-On section.
Fabric Upcharge
Grade 2 - \$216 per panel,
Grade 3- \$266 per panel

Options:

Height*:	34", 42", 50", 66", 82"
Width:	24", 30", 36", 42", 48", 54", 60", 66", 72"
Fabric	
Metal Powder Coat Paint:	White, Black, Silver, Charcoal

*34" high - 50" high available up to 72" wide, 66" high available up to 60" wide, 82" high available up to 48" wide

Code	Price	H	W	D	Weight (lb.)	Volume (ft ³)
L-PPF0-3424-N	401	34	24	2	16.3	0.94
L-PPF0-3430-N	433	34	30	2	20.4	1.18
L-PPF0-3436-N	465	34	36	2	24.5	1.42
L-PPF0-3442-N	497	34	42	2	28.6	1.65
L-PPF0-3448-N	527	34	48	2	32.6	1.89
L-PPF0-3454-N	559	34	54	2	36.7	2.13
L-PPF0-3460-N	590	34	60	2	40.8	2.36
L-PPF0-3466-N	851	34	66	2		
L-PPF0-3472-N	880	34	72	2		

Code	Price	H	W	D	Weight (lb.)	Volume (ft ³)
L-PPF0-4224-N	401	42	24	2	20.2	1.17
L-PPF0-4230-N	433	42	30	2	25.2	1.46
L-PPF0-4236-N	465	42	36	2	30.2	1.75
L-PPF0-4242-N	497	42	42	2	35.3	2.04
L-PPF0-4248-N	527	42	48	2	40.3	2.33
L-PPF0-4254-N	559	42	54	2	45.4	2.63
L-PPF0-4260-N	590	42	60	2	50.4	2.92
L-PPF0-4266-N	851	42	66	2		
L-PPF0-4272-N	880	42	72	2		
L-PPF0-5024-N	433	50	24	2	24.0	1.39
L-PPF0-5030-N	480	50	30	2	30.0	1.74
L-PPF0-5036-N	527	50	36	2	36.0	2.08
L-PPF0-5042-N	575	50	42	2	42.0	2.43
L-PPF0-5048-N	623	50	48	2	48.0	2.78
L-PPF0-5054-N	671	50	54	2	54.0	3.13
L-PPF0-5060-N	715	50	60	2	60.0	3.47
L-PPF0-5066-N	951	50	66	2		
L-PPF0-5072-N	994	50	72	2		
L-PPF0-6624-N	497	66	24	2	31.7	1.83
L-PPF0-6630-N	552	66	30	2	39.6	2.29
L-PPF0-6636-N	600	66	36	2	47.5	2.75
L-PPF0-6642-N	647	66	42	2	55.4	3.21
L-PPF0-6648-N	694	66	48	2	63.4	3.67
L-PPF0-6654-N	757	66	54	2	71.3	4.13
L-PPF0-6660-N	819	66	60	2	79.2	4.58
L-PPF0-8224-N	941	82	24	2		
L-PPF0-8230-N	1009	82	30	2		
L-PPF0-8236-N	1222	82	36	2		
L-PPF0-8242-N	1286	82	42	2		
L-PPF0-8248-N	1352	82	48	2		

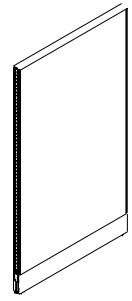

Standard Monolithic
Non-Powered Laminate
Panel

What's Included:

One (1) 2" thick laminate panel with
1" incremented slotted channels,
Two (2) raceway covers,
One (1) top trim

How to Specify:

Refer to laminate cards for laminate
selections Choose White, Black, Silver, Charcoal
for Panel Frame colour

Notes:

Non-power capable panel.
Can be used in run with power-capable
panels and allows wires to pass through.
Panels are non tackable. For tackable
option see Panel Add-On section.

Options:

Height*: 34", 42", 50", 66", 82"

Width: 24", 30", 36", 42", 48"

Fabric

Metal Powder Coat Paint: White, Black, Silver, Charcoal

*82" high available up to 36" wide

Code	Price	H	W	D	Weight (lb.)	Volume (ft ³)
L-PPL0-3424-N	507	34	24	2	16.3	0.94
L-PPL0-3430-N	553	34	30	2	20.4	1.18
L-PPL0-3436-N	631	34	36	2	24.5	1.42
L-PPL0-3442-N	678	34	42	2	28.6	1.65
L-PPL0-3448-N	744	34	48	2	32.6	1.89
L-PPL0-4224-N	553	42	24	2	20.2	1.17
L-PPL0-4230-N	602	42	30	2	25.2	1.46
L-PPL0-4236-N	678	42	36	2	30.2	1.75
L-PPL0-4242-N	726	42	42	2	35.3	2.04
L-PPL0-4248-N	789	42	48	2	40.3	2.33
L-PPL0-5024-N	602	50	24	2	24.0	1.39
L-PPL0-5030-N	649	50	30	2	30.0	1.74
L-PPL0-5036-N	744	50	36	2	36.0	2.08
L-PPL0-5042-N	789	50	42	2	42.0	2.43
L-PPL0-5048-N	854	50	48	2	48.0	2.78
L-PPL0-6624-N	744	66	24	2	31.7	1.83
L-PPL0-6630-N	789	66	30	2	39.6	2.29
L-PPL0-6636-N	932	66	36	2	47.5	2.75
L-PPL0-6642-N	981	66	42	2	55.4	3.21
L-PPL0-6648-N	1042	66	48	2	63.4	3.67
L-PPL0-8224-N	1007	82	24	2		
L-PPL0-8230-N	1022	82	30	2		
L-PPL0-8236-N	1336	82	36	2		

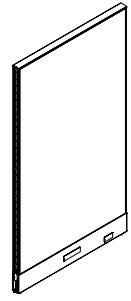

Standard Monolithic Powered Fabric Panel

What's Included:

One (1) 2" thick fabric panel with 1" incremented slotted channels, Two (2) raceway covers, One (1) top trim

How to Specify:

Refer to panel fabric cards for fabric selections
Choose White, Black, Silver, Charcoal for Panel Frame colour

Notes:

Power capable panel with bracket for power module.

Power module must be specified seperately.

Panels are non tackable. For tackable option see Panel Add-On section.

Fabric Upcharge
Grade 2 - \$216 per panel,
Grade 3- \$266 per panel

Options:

Height*: 34", 42", 50", 66", 82"

Width: 24", 30", 36", 42", 48", 54", 60", 66", 72"

Fabric

Metal Powder Coat Paint: White, Black, Silver, Charcoal

*34" high - 50" high available up to 72" wide, 66" high available up to 60" wide, 82" high available up to 48" wide

Code	Price	H	W	D	Weight (lb.)	Volume (ft ³)
L-PPF0-3424-E	448	34	24	2	16.3	0.94
L-PPF0-3430-E	480	34	30	2	20.4	1.18
L-PPF0-3436-E	511	34	36	2	24.5	1.42
L-PPF0-3442-E	545	34	42	2	28.6	1.65
L-PPF0-3448-E	575	34	48	2	32.6	1.89
L-PPF0-3454-E	608	34	54	2	36.7	2.13
L-PPF0-3460-E	636	34	60	2	40.8	2.36
L-PPF0-3466-E	893	34	66	2		
L-PPF0-3472-E	920	34	72	2		

Code	Price	H	W	D	Weight (lb.)	Volume (ft ³)
L-PPF0-4224-E	448	42	24	2	20.2	1.17
L-PPF0-4230-E	480	42	30	2	25.2	1.46
L-PPF0-4236-E	511	42	36	2	30.2	1.75
L-PPF0-4242-E	545	42	42	2	35.3	2.04
L-PPF0-4248-E	575	42	48	2	40.3	2.33
L-PPF0-4254-E	608	42	54	2	45.4	2.63
L-PPF0-4260-E	636	42	60	2	50.4	2.92
L-PPF0-4266-E	893	42	66	2		
L-PPF0-4272-E	920	42	72	2		
L-PPF0-5024-E	480	50	24	2	24.0	1.39
L-PPF0-5030-E	527	50	30	2	30.0	1.74
L-PPF0-5036-E	575	50	36	2	36.0	2.08
L-PPF0-5042-E	623	50	42	2	42.0	2.43
L-PPF0-5048-E	671	50	48	2	48.0	2.78
L-PPF0-5054-E	715	50	54	2	54.0	3.13
L-PPF0-5060-E	762	50	60	2	60.0	3.47
L-PPF0-5066-E	993	50	66	2		
L-PPF0-5072-E	1034	50	72	2		
L-PPF0-6624-E	545	66	24	2	31.7	1.83
L-PPF0-6630-E	600	66	30	2	39.6	2.29
L-PPF0-6636-E	647	66	36	2	47.5	2.75
L-PPF0-6642-E	694	66	42	2	55.4	3.21
L-PPF0-6648-E	743	66	48	2	63.4	3.67
L-PPF0-6654-E	804	66	54	2	71.3	4.13
L-PPF0-6660-E	864	66	60	2	79.2	4.58
L-PPF0-8224-E	983	82	24	2		
L-PPF0-8230-E	1051	82	30	2		
L-PPF0-8236-E	1262	82	36	2		
L-PPF0-8242-E	1328	82	42	2		
L-PPF0-8248-E	1394	82	48	2		

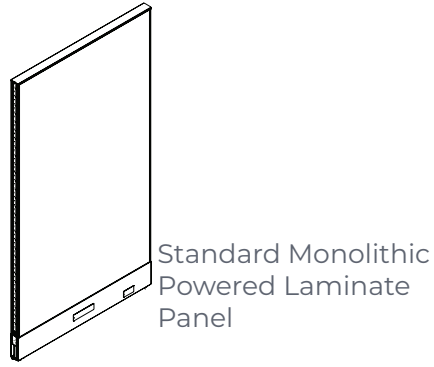

What's Included:

One (1) 2" thick flaminite panel with 1" incremented slotted channels,
Two (2) raceway covers,
One (1) top trim

How to Specify:

Refer to laminate cards for laminate selections
Choose White, Black, Silver, Charcoal for Panel Frame colour

Notes:

Power capable panel with bracket for power module.
Power module must be specified seperately.
Panels are non tackable. For tackable option see Panel Add-On section.

Options:

Height*: 34", 42", 50", 66", 82"

Width: 24", 30", 36", 42", 48",

Laminate

Metal Powder Coat Paint: White, Black, Silver, Charcoal

*82"H available up to 36"W

Code	Price	H	W	D	Weight (lb.)	Volume (ft ³)
L-PPL0-3424-E	552	34	24	2	16.3	0.94
L-PPL0-3430-E	600	34	30	2	20.4	1.18
L-PPL0-3436-E	677	34	36	2	24.5	1.42
L-PPL0-3442-E	724	34	42	2	28.6	1.65
L-PPL0-3448-E	788	34	48	2	32.6	1.89
L-PPL0-4224-E	600	42	24	2	20.2	1.17
L-PPL0-4230-E	647	42	30	2	25.2	1.46
L-PPL0-4236-E	724	42	36	2	30.2	1.75
L-PPL0-4242-E	773	42	42	2	35.3	2.04
L-PPL0-4248-E	835	42	48	2	40.3	2.33
L-PPL0-5024-E	647	50	24	2	24.0	1.39
L-PPL0-5030-E	694	50	30	2	30.0	1.74
L-PPL0-5036-E	788	50	36	2	36.0	2.08
L-PPL0-5042-E	835	50	42	2	42.0	2.43
L-PPL0-5048-E	899	50	48	2	48.0	2.78
L-PPL0-6624-E	788	66	24	2	31.7	1.83
L-PPL0-6630-E	835	66	30	2	39.6	2.29
L-PPL0-6636-E	979	66	36	2	47.5	2.75
L-PPL0-6642-E	1026	66	42	2	55.4	3.21
L-PPL0-6648-E	1088	66	48	2	63.4	3.67
L-PPL0-8224-E	1021	82	24	2		
L-PPL0-8230-E	1034	82	30	2		
L-PPL0-8236-E	1378	82	36	2		

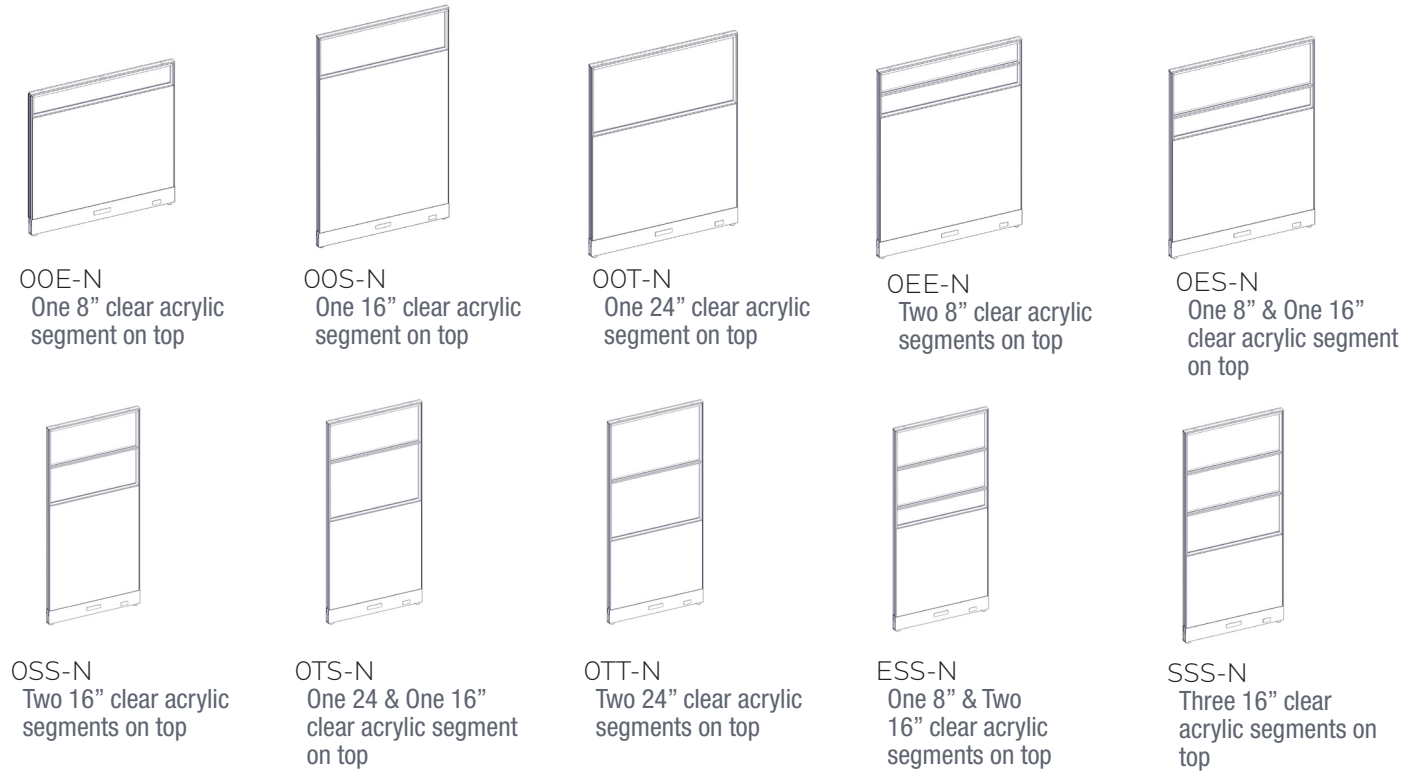

How to order and read your code

L - P P F C A - 42 24 - 00E - N

product line	standard	P=glazed E=Elevated	F=Fabric L=Laminate	C=Clear F=Frosted G=Glass	A=Acrylic height	width	O = No segment E = 8 inch segment S = 16 inch segment T = 24 inch segment	N=Non powered E=Powered
--------------	----------	------------------------	------------------------	---------------------------------	------------------	-------	--	----------------------------

What's Included:

One (1) 2" thick fabric panel with 1" incremented slotted channels, Two (2) raceway covers, One (1) top trim

How to Specify:

Refer to panel fabric cards for fabric selections
Choose White, Black, Silver, Charcoal for Panel Frame colour

Options:

Height*:	34", 42", 50", 66", 82"
Width:	24", 30", 36", 42", 48", 54", 60", 66", 72"
Fabric	
Metal Powder Coat Paint:	White, Black, Silver, Charcoal

*34" high - 50" high available up to 72" wide, 66" high available up to 60" wide, 82" high available up to 48" wide

Code	Price	H	W	D
One 8" clear acrylic segment on top				
L-PPFCA-4224-00E-N	780	42	24	2
L-PPFCA-4230-00E-N	860	42	30	2
L-PPFCA-4236-00E-N	941	42	36	2
L-PPFCA-4242-00E-N	1021	42	42	2
L-PPFCA-4248-00E-N	1103	42	48	2
L-PPFCA-4254-00E-N	1181	42	54	2
L-PPFCA-4260-00E-N	1261	42	60	2
L-PPFCA-5024-00E-N	780	50	24	2
L-PPFCA-5030-00E-N	860	50	30	2
L-PPFCA-5036-00E-N	941	50	36	2
L-PPFCA-5042-00E-N	1021	50	42	2
L-PPFCA-5048-00E-N	1103	50	48	2
L-PPFCA-5054-00E-N	1181	50	54	2
L-PPFCA-5060-00E-N	1261	50	60	2
One 16" clear acrylic segment on top				
L-PPFCA-5024-00S-N	780	50	24	2
L-PPFCA-5030-00S-N	860	50	30	2
L-PPFCA-5036-00S-N	941	50	36	2
L-PPFCA-5042-00S-N	1021	50	42	2
L-PPFCA-5048-00S-N	1103	50	48	2
L-PPFCA-5054-00S-N	1181	50	54	2
L-PPFCA-5060-00S-N	1261	50	60	2
One 24" clear acrylic segment on top				
L-PPFCA-6624-00T-N	907	66	24	2
L-PPFCA-6630-00T-N	1009	66	30	2
L-PPFCA-6636-00T-N	1109	66	36	2
L-PPFCA-6642-00T-N	1210	66	42	2
L-PPFCA-6648-00T-N	1312	66	48	2
L-PPFCA-6654-00T-N	1412	66	54	2
L-PPFCA-6660-00T-N	1513	66	60	2
One 8" & Two 16" clear acrylic segments on top				
L-PPFCA-8224-00T-N	1570	82	24	2
L-PPFCA-8230-00T-N	1861	82	30	2
L-PPFCA-8236-00T-N	1944	82	36	2
L-PPFCA-8242-00T-N	1946	82	42	2
L-PPFCA-8248-00T-N	2132	82	48	2
Three 16" clear acrylic segments on top				
L-PPFCA-8224-SSS-N	1595	82	24	2
L-PPFCA-8230-SSS-N	1805	82	30	2
L-PPFCA-8236-SSS-N	1972	82	36	2
L-PPFCA-8242-SSS-N	2038	82	42	2
L-PPFCA-8248-SSS-N	2127	82	48	2

Code	Price	H	W	D
Two 8" clear acrylic segments on top				
L-PPFCA-6624-0EE-N	1457	66	24	2
L-PPFCA-6630-0EE-N	1649	66	30	2
L-PPFCA-6636-0EE-N	1719	66	36	2
L-PPFCA-6642-0EE-N	1777	66	42	2
L-PPFCA-6648-0EE-N	1851	66	48	2
L-PPFCA-6654-0EE-N	1970	66	54	2
L-PPFCA-6660-0EE-N	2024	66	60	2
One 8" & One 16" clear acrylic segment on top				
L-PPFCA-6624-0ES-N	1422	66	24	2
L-PPFCA-6630-0ES-N	1608	66	30	2
L-PPFCA-6636-0ES-N	1690	66	36	2
L-PPFCA-6642-0ES-N	1772	66	42	2
L-PPFCA-6648-0ES-N	1857	66	48	2
L-PPFCA-6654-0ES-N	1947	66	54	2
L-PPFCA-6660-0ES-N	1990	66	60	2
Two 16" clear acrylic segments on top				
L-PPFCA-8224-0SS-N	1515	82	24	2
L-PPFCA-8230-0SS-N	1760	82	30	2
L-PPFCA-8236-0SS-N	1887	82	36	2
L-PPFCA-8242-0SS-N	1944	82	42	2
L-PPFCA-8248-0SS-N	2021	82	48	2
One 24" & One 16" clear acrylic segment on top				
L-PPFCA-8224-0TS-N	1506	82	24	2
L-PPFCA-8230-0TS-N	1730	82	30	2
L-PPFCA-8236-0TS-N	1798	82	36	2
L-PPFCA-8242-0TS-N	1854	82	42	2
L-PPFCA-8248-0TS-N	2042	82	48	2
Two 24" clear acrylic segments on top				
L-PPFCA-8224-0TT-N	1503	82	24	2
L-PPFCA-8230-0TT-N	1703	82	30	2
L-PPFCA-8236-0TT-N	1794	82	36	2
L-PPFCA-8242-0TT-N	1911	82	42	2
L-PPFCA-8248-0TT-N	1989	82	48	2

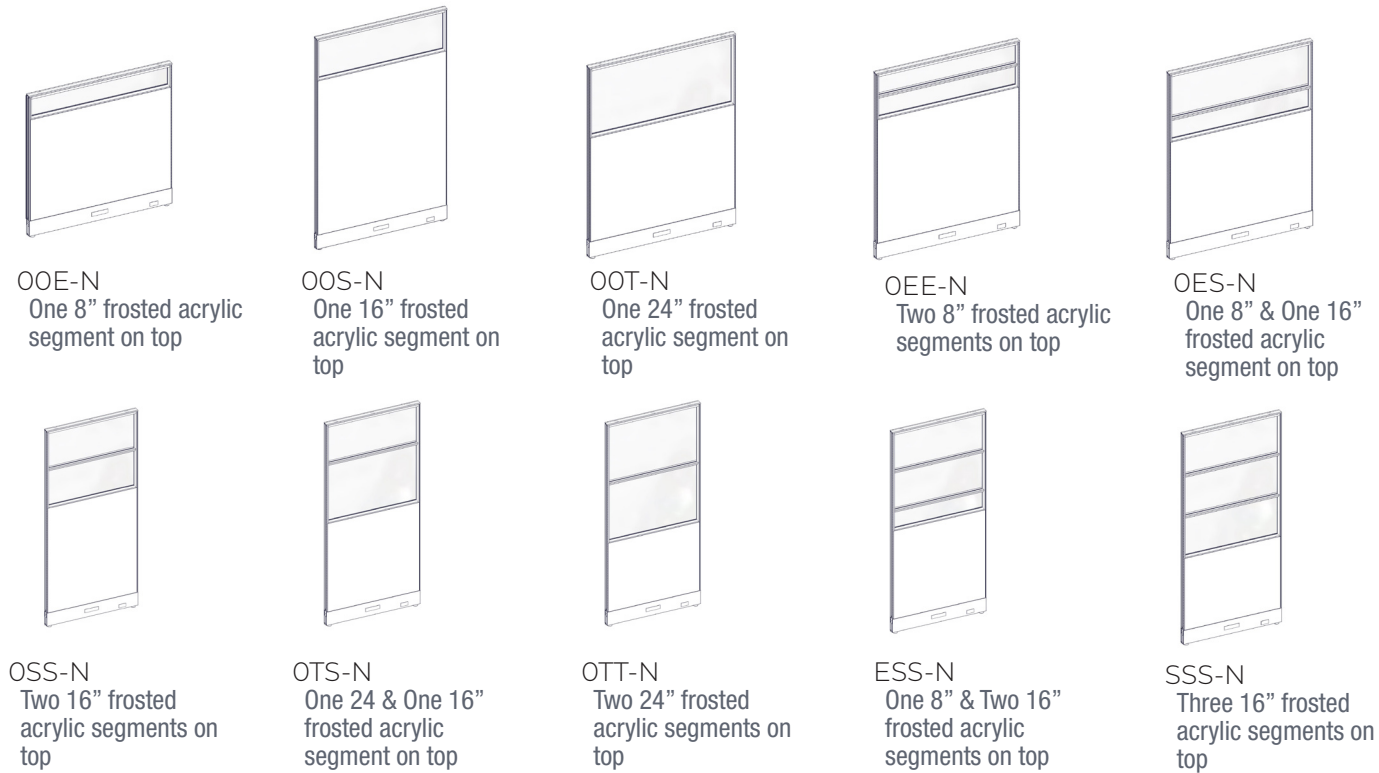

How to order and read your code

L - P P F F A - 42 24 - 00E - N

product standard P=glazed F=Fabric C=Clear A=Acrylic height width 0=No segment N=Non powered
 line E=Elevated L=Laminate F=Frosted G=Glass E=8 inch segment E=Powered
 S=16 inch segment
 T=24 inch segment

What's Included:

One (1) 2" thick fabric panel with 1" incremented slotted channels, Two (2) raceway covers, One (1) top trim

How to Specify:

Refer to panel fabric cards for fabric selections
 Choose White, Black, Silver, Charcoal for Panel Frame colour

Options:

Height*:	34", 42", 50", 66", 82"
Width:	24", 30", 36", 42", 48", 54", 60", 66", 72"
Fabric	
Metal Powder Coat Paint:	White, Black, Silver, Charcoal

*34" high - 50" high available up to 72" wide, 66" high available up to 60" wide, 82" high available up to 48" wide

Code	Price	H	W	D
One 8" frosted acrylic segment on top				
L-PPFFA-4224-00E-N	882	42	24	2
L-PPFFA-4230-00E-N	962	42	30	2
L-PPFFA-4236-00E-N	1043	42	36	2
L-PPFFA-4242-00E-N	1123	42	42	2
L-PPFFA-4248-00E-N	1205	42	48	2
L-PPFFA-4254-00E-N	1283	42	54	2
L-PPFFA-4260-00E-N	1363	42	60	2
L-PPFFA-5024-00E-N	882	50	24	2
L-PPFFA-5030-00E-N	962	50	30	2
L-PPFFA-5036-00E-N	1043	50	36	2
L-PPFFA-5042-00E-N	1123	50	42	2
L-PPFFA-5048-00E-N	1205	50	48	2
L-PPFFA-5054-00E-N	1283	50	54	2
L-PPFFA-5060-00E-N	1363	50	60	2
One 16" frosted acrylic segment on top				
L-PPFFA-5024-00S-N	882	50	24	2
L-PPFFA-5030-00S-N	962	50	30	2
L-PPFFA-5036-00S-N	1043	50	36	2
L-PPFFA-5042-00S-N	1123	50	42	2
L-PPFFA-5048-00S-N	1205	50	48	2
L-PPFFA-5054-00S-N	1283	50	54	2
L-PPFFA-5060-00S-N	1363	50	60	2
L-PPFFA-6624-00S-N	1009	50	24	2
L-PPFFA-6630-00S-N	1111	50	30	2
L-PPFFA-6636-00S-N	1211	50	36	2
L-PPFFA-6642-00S-N	1312	50	42	2
L-PPFFA-6648-00S-N	1415	50	48	2
L-PPFFA-6654-00S-N	1515	50	54	2
L-PPFFA-6660-00S-N	1616	50	60	2
L-PPFFA-8224-00S-N	1509	82	24	2
L-PPFFA-8230-00S-N	1756	82	30	2
L-PPFFA-8236-00S-N	1858	82	36	2
L-PPFFA-8242-00S-N	1911	82	42	2
L-PPFFA-8248-00S-N	1994	82	48	2
One 24" frosted acrylic segment on top				
L-PPFFA-6624-00T-N	1009	66	24	2
L-PPFFA-6630-00T-N	1111	66	30	2
L-PPFFA-6636-00T-N	1211	66	36	2
L-PPFFA-6642-00T-N	1298	66	42	2
L-PPFFA-6648-00T-N	1400	66	48	2
L-PPFFA-6654-00T-N	1515	66	54	2
L-PPFFA-6660-00T-N	1616	66	60	2

Code	Price	H	W	D
Two 8" frosted acrylic segments on top				
L-PPFFA-6624-0EE-N	1517	66	24	2
L-PPFFA-6630-0EE-N	1731	66	30	2
L-PPFFA-6636-0EE-N	1826	66	36	2
L-PPFFA-6642-0EE-N	1882	66	42	2
L-PPFFA-6648-0EE-N	1973	66	48	2
L-PPFFA-6654-0EE-N	2057	66	54	2
L-PPFFA-6660-0EE-N	2108	66	60	2
One 8" & One 16" frosted acrylic segment on top				
L-PPFFA-6624-0ES-N	1473	66	24	2
L-PPFFA-6630-0ES-N	1678	66	30	2
L-PPFFA-6636-0ES-N	1774	66	36	2
L-PPFFA-6642-0ES-N	1877	66	42	2
L-PPFFA-6648-0ES-N	1960	66	48	2
L-PPFFA-6654-0ES-N	2060	66	54	2
L-PPFFA-6660-0ES-N	2123	66	60	2
Two 16" frosted acrylic segments on top				
L-PPFFA-8224-0SS-N	1418	82	24	2
L-PPFFA-8230-0SS-N	1623	82	30	2
L-PPFFA-8236-0SS-N	1702	82	36	2
L-PPFFA-8242-0SS-N	1765	82	42	2
L-PPFFA-8248-0SS-N	1831	82	48	2
One 24" & One 16" frosted acrylic segment on top				
L-PPFFA-8224-0TS-N	1610	82	24	2
L-PPFFA-8230-0TS-N	1867	82	30	2
L-PPFFA-8236-0TS-N	1935	82	36	2
L-PPFFA-8242-0TS-N	2027	82	42	2
L-PPFFA-8248-0TS-N	2247	82	48	2
Two 24" frosted acrylic segments on top				
L-PPFFA-8224-0TT-N	1606	82	24	2
L-PPFFA-8230-0TT-N	1843	82	30	2
L-PPFFA-8236-0TT-N	1960	82	36	2
L-PPFFA-8242-0TT-N	2118	82	42	2
L-PPFFA-8248-0TT-N	2195	82	48	2
One 8" & Two 16" frosted acrylic segments on top				
L-PPFFA-8224-ESS-N	1673	82	24	2
L-PPFFA-8230-ESS-N	2001	82	30	2
L-PPFFA-8236-ESS-N	2081	82	36	2
L-PPFFA-8242-ESS-N	2148	82	42	2
L-PPFFA-8248-ESS-N	2267	82	48	2
Three 16" frosted acrylic segments on top				
L-PPFFA-8224-SSS-N	1698	82	24	2
L-PPFFA-8230-SSS-N	1944	82	30	2
L-PPFFA-8236-SSS-N	2179	82	36	2
L-PPFFA-8242-SSS-N	2244	82	42	2
L-PPFFA-8248-SSS-N	2332	82	48	2

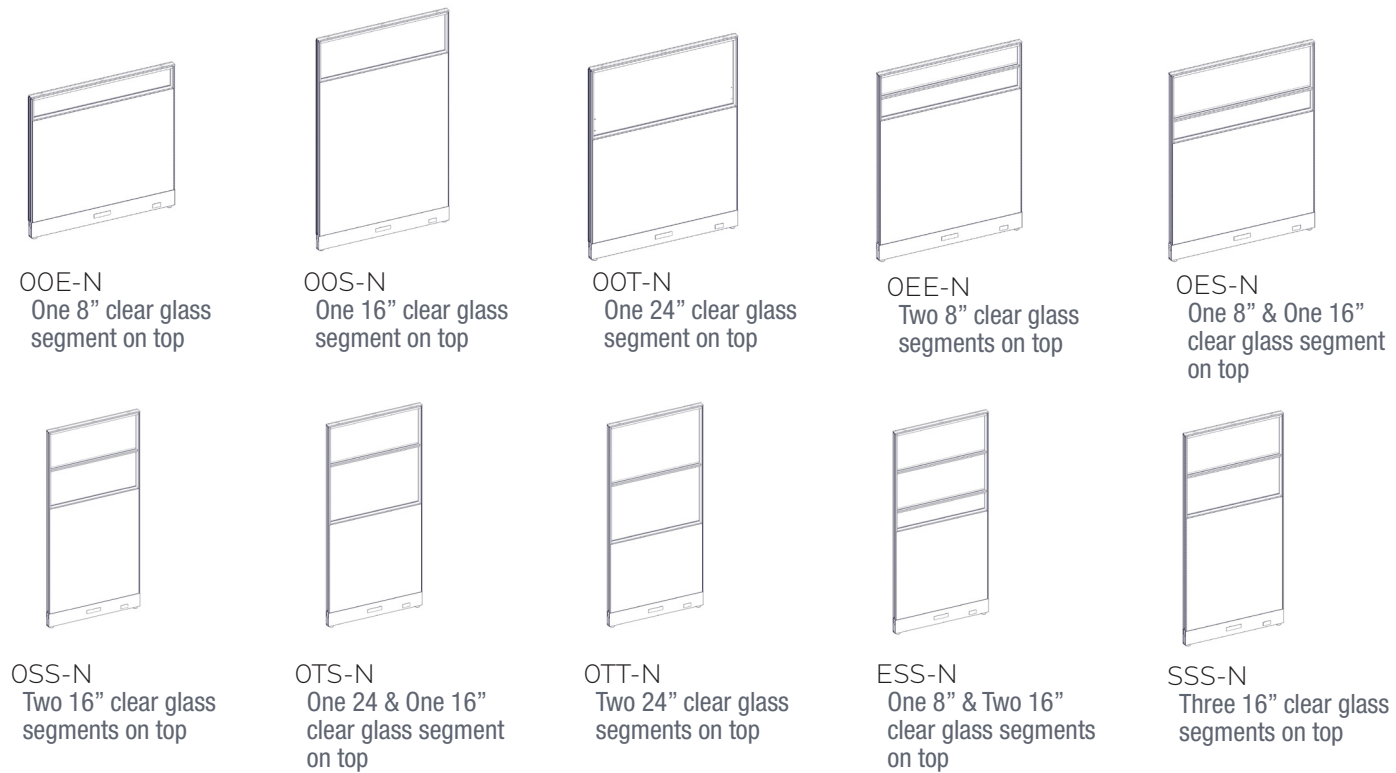

How to order and read your code

L - P P F C G - 42 24 - 00 E - N

product standard line P=glazed E=Elevated F=Fabric L=Laminate C=Clear F=Frosted A=Acrylic G=Glass height width 0=No segment E=8 inch segment S=16 inch segment T=24 inch segment N=Non powered E=Powered

What's Included:

One (1) 2" thick fabric panel with 1" incremented slotted channels, Two (2) raceway covers, One (1) top trim

How to Specify:

Refer to panel fabric cards for fabric selections
Choose White, Black, Silver, Charcoal for Panel Frame colour

Notes:

Power capable panel with bracket for power module.
Power module must be specified seperately.
Panels are non tackable. For tackable option see Panel Add-On section.
Fabric Upcharge
Grade 2 - \$216 per panel,
Grade 3- \$266 per panel

Options:

Height*:	34", 42", 50", 66", 82"
Width:	24", 30", 36", 42", 48", 54", 60", 66", 72"
Fabric	
Metal Powder Coat Paint:	White, Black, Silver, Charcoal

*34" high - 50" high available up to 72" wide, 66" high available up to 60" wide, 82" high available up to 48" wide

Code	Price	H	W	D
One 8" clear glass segment on top				
L-PPFCG-4224-00E-N	917	42	24	2
L-PPFCG-4230-00E-N	997	42	30	2
L-PPFCG-4236-00E-N	1079	42	36	2
L-PPFCG-4242-00E-N	1158	42	42	2
L-PPFCG-4248-00E-N	1237	42	48	2
L-PPFCG-4254-00E-N	1318	42	54	2
L-PPFCG-4260-00E-N	1397	42	60	2
L-PPFCG-5024-00E-N	917	50	24	2
L-PPFCG-5030-00E-N	997	50	30	2
L-PPFCG-5036-00E-N	1079	50	36	2
L-PPFCG-5042-00E-N	1158	50	42	2
L-PPFCG-5048-00E-N	1237	50	48	2
L-PPFCG-5054-00E-N	1318	50	54	2
L-PPFCG-5060-00E-N	1397	50	60	2
One 16" clear glass segment on top				
L-PPFCG-5024-00S-N	917	50	24	2
L-PPFCG-5030-00S-N	997	50	30	2
L-PPFCG-5036-00S-N	1079	50	36	2
L-PPFCG-5042-00S-N	1158	50	42	2
L-PPFCG-5048-00S-N	1237	50	48	2
L-PPFCG-5054-00S-N	1318	50	54	2
L-PPFCG-5060-00S-N	1397	50	60	2
L-PPFCG-6624-00S-N	1054	66	24	2
L-PPFCG-6630-00S-N	1156	66	30	2
L-PPFCG-6636-00S-N	1257	66	36	2
L-PPFCG-6642-00S-N	1360	66	42	2
L-PPFCG-6648-00S-N	1461	66	48	2
L-PPFCG-6654-00S-N	1563	66	54	2
L-PPFCG-6660-00S-N	1662	66	60	2
L-PPFCG-8224-00S-N	1435	82	24	2
L-PPFCG-8230-00S-N	1695	82	30	2
L-PPFCG-8236-00S-N	1804	82	36	2
L-PPFCG-8242-00S-N	1864	82	42	2
L-PPFCG-8248-00S-N	1969	82	48	2
One 24" clear glass segment on top				
L-PPFCG-6624-00T-N	1054	66	24	2
L-PPFCG-6630-00T-N	1156	66	30	2
L-PPFCG-6636-00T-N	1257	66	36	2
L-PPFCG-6642-00T-N	1360	66	42	2
L-PPFCG-6648-00T-N	1461	66	48	2
L-PPFCG-6654-00T-N	1563	66	54	2
L-PPFCG-6660-00T-N	1662	66	60	2

Code	Price	H	W	D
Two 8" clear glass segments on top				
L-PPFCG-6624-0EE-N	1550	66	24	2
L-PPFCG-6630-0EE-N	1779	66	30	2
L-PPFCG-6636-0EE-N	1874	66	36	2
L-PPFCG-6642-0EE-N	1942	66	42	2
L-PPFCG-6648-0EE-N	2034	66	48	2
L-PPFCG-6654-0EE-N	2153	66	54	2
L-PPFCG-6660-0EE-N	2216	66	60	2
One 8" & One 16" clear glass segment on top				
L-PPFCG-6624-0ES-N	1511	66	24	2
L-PPFCG-6630-0ES-N	1712	66	30	2
L-PPFCG-6636-0ES-N	1809	66	36	2
L-PPFCG-6642-0ES-N	1898	66	42	2
L-PPFCG-6648-0ES-N	2012	66	48	2
L-PPFCG-6654-0ES-N	2139	66	54	2
L-PPFCG-6660-0ES-N	2209	66	60	2
Two 16" clear glass segments on top				
L-PPFCG-8224-0SS-N	1606	82	24	2
L-PPFCG-8230-0SS-N	1847	82	30	2
L-PPFCG-8236-0SS-N	1972	82	36	2
L-PPFCG-8242-0SS-N	2072	82	42	2
L-PPFCG-8248-0SS-N	2195	82	48	2
One 24" & One 16" clear glass segment on top				
L-PPFCG-8224-0TS-N	1594	82	24	2
L-PPFCG-8230-0TS-N	1819	82	30	2
L-PPFCG-8236-0TS-N	1939	82	36	2
L-PPFCG-8242-0TS-N	2051	82	42	2
L-PPFCG-8248-0TS-N	2189	82	48	2
Two 24" clear glass segments on top				
L-PPFCG-8224-0TT-N	1623	82	24	2
L-PPFCG-8230-0TT-N	1840	82	30	2
L-PPFCG-8236-0TT-N	1952	82	36	2
L-PPFCG-8242-0TT-N	2068	82	42	2
L-PPFCG-8248-0TT-N	2204	82	48	2
One 8" & Two 16" clear glass segments on top				
L-PPFCG-8224-ESS-N	1743	82	24	2
L-PPFCG-8230-ESS-N	2029	82	30	2
L-PPFCG-8236-ESS-N	2160	82	36	2
L-PPFCG-8242-ESS-N	2182	82	42	2
L-PPFCG-8248-ESS-N	2354	82	48	2
Three 16" clear glass segments on top				
L-PPFCG-8224-SSS-N	1780	82	24	2
L-PPFCG-8230-SSS-N	1990	82	30	2
L-PPFCG-8236-SSS-N	2127	82	36	2
L-PPFCG-8242-SSS-N	2256	82	42	2
L-PPFCG-8248-SSS-N	2409	82	48	2

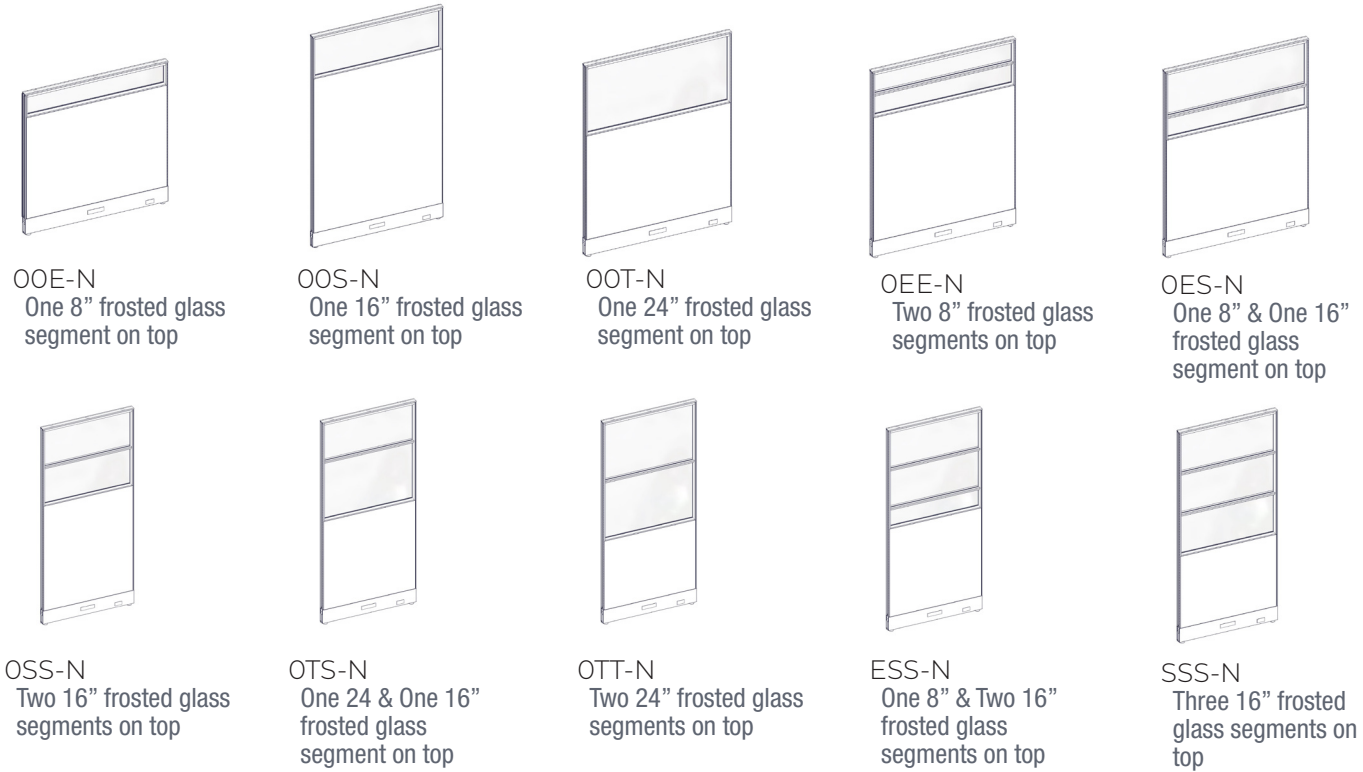

How to order and read your code

L - P P F F G - 42 24 - 00E - N

product standard line P=glazed E=Elevated F=Fabric L=Laminate C=Clear F=Frosted A=Acrylic height G=Glass width O=No segment E=8 inch segment S=16 inch segment T=24 inch segment N=Non powered E=Powered

What's Included:

One (1) 2" thick fabric panel with 1" incremented slotted channels, Two (2) raceway covers, One (1) top trim

How to Specify:

Refer to panel fabric cards for fabric selections
Choose White, Black, Silver, Charcoal for Panel Frame colour

Options:

Height*: 34", 42", 50", 66", 82"
Width: 24", 30", 36", 42", 48", 54", 60", 66", 72"
Fabric
Metal Powder Coat Paint: White, Black, Silver, Charcoal

*34" high - 50" high available up to 72" wide, 66" high available up to 60" wide, 82" high available up to 48" wide

Code	Price	H	W	D
One 8" frosted glass segment on top				
L-PPFFG-4224-00E-N	1005	42	24	2
L-PPFFG-4230-00E-N	1097	42	30	2
L-PPFFG-4236-00E-N	1180	42	36	2
L-PPFFG-4242-00E-N	1260	42	42	2
L-PPFFG-4248-00E-N	1340	42	48	2
L-PPFFG-4254-00E-N	1420	42	54	2
L-PPFFG-4260-00E-N	1499	42	60	2
L-PPFFG-5024-00E-N	1019	50	24	2
L-PPFFG-5030-00E-N	1097	50	30	2
L-PPFFG-5036-00E-N	1180	50	36	2
L-PPFFG-5042-00E-N	1260	50	42	2
L-PPFFG-5048-00E-N	1340	50	48	2
L-PPFFG-5054-00E-N	1420	50	54	2
L-PPFFG-5060-00E-N	1499	50	60	2
One 16" frosted glass segment on top				
L-PPFFG-5024-00S-N	1019	50	24	2
L-PPFFG-5030-00S-N	1097	50	30	2
L-PPFFG-5036-00S-N	1180	50	36	2
L-PPFFG-5042-00S-N	1260	50	42	2
L-PPFFG-5048-00S-N	1340	50	48	2
L-PPFFG-5054-00S-N	1420	50	54	2
L-PPFFG-5060-00S-N	1499	50	60	2
L-PPFFG-6624-00S-N	1156	66	24	2
L-PPFFG-6630-00S-N	1258	66	30	2
L-PPFFG-6636-00S-N	1359	66	36	2
L-PPFFG-6642-00S-N	1462	66	42	2
L-PPFFG-6648-00S-N	1563	66	48	2
L-PPFFG-6654-00S-N	1664	66	54	2
L-PPFFG-6660-00S-N	1765	66	60	2
L-PPFFG-8224-00S-N	1517	82	24	2
L-PPFFG-8230-00S-N	1787	82	30	2
L-PPFFG-8236-00S-N	1917	82	36	2
L-PPFFG-8242-00S-N	1994	82	42	2
L-PPFFG-8248-00S-N	2117	82	48	2
One 24" frosted glass segment on top				
L-PPFFG-6624-00T-N	1156	66	24	2
L-PPFFG-6630-00T-N	1258	66	30	2
L-PPFFG-6636-00T-N	1359	66	36	2
L-PPFFG-6642-00T-N	1462	66	42	2
L-PPFFG-6648-00T-N	1563	66	48	2
L-PPFFG-6654-00T-N	1664	66	54	2
L-PPFFG-6660-00T-N	1765	66	60	2
One 8" & Two 16" frosted glass segments on top				
L-PPFFG-8224-ESS-N	1994	82	24	2
L-PPFFG-8230-ESS-N	2298	82	30	2
L-PPFFG-8236-ESS-N	2467	82	36	2
L-PPFFG-8242-ESS-N	2526	82	42	2
L-PPFFG-8248-ESS-N	2737	82	48	2
Three 16" frosted glass segments on top				
L-PPFFG-8224-SSS-N	2030	82	24	2
L-PPFFG-8230-SSS-N	2266	82	30	2
L-PPFFG-8236-SSS-N	2458	82	36	2
L-PPFFG-8242-SSS-N	2646	82	42	2
L-PPFFG-8248-SSS-N	2854	82	48	2

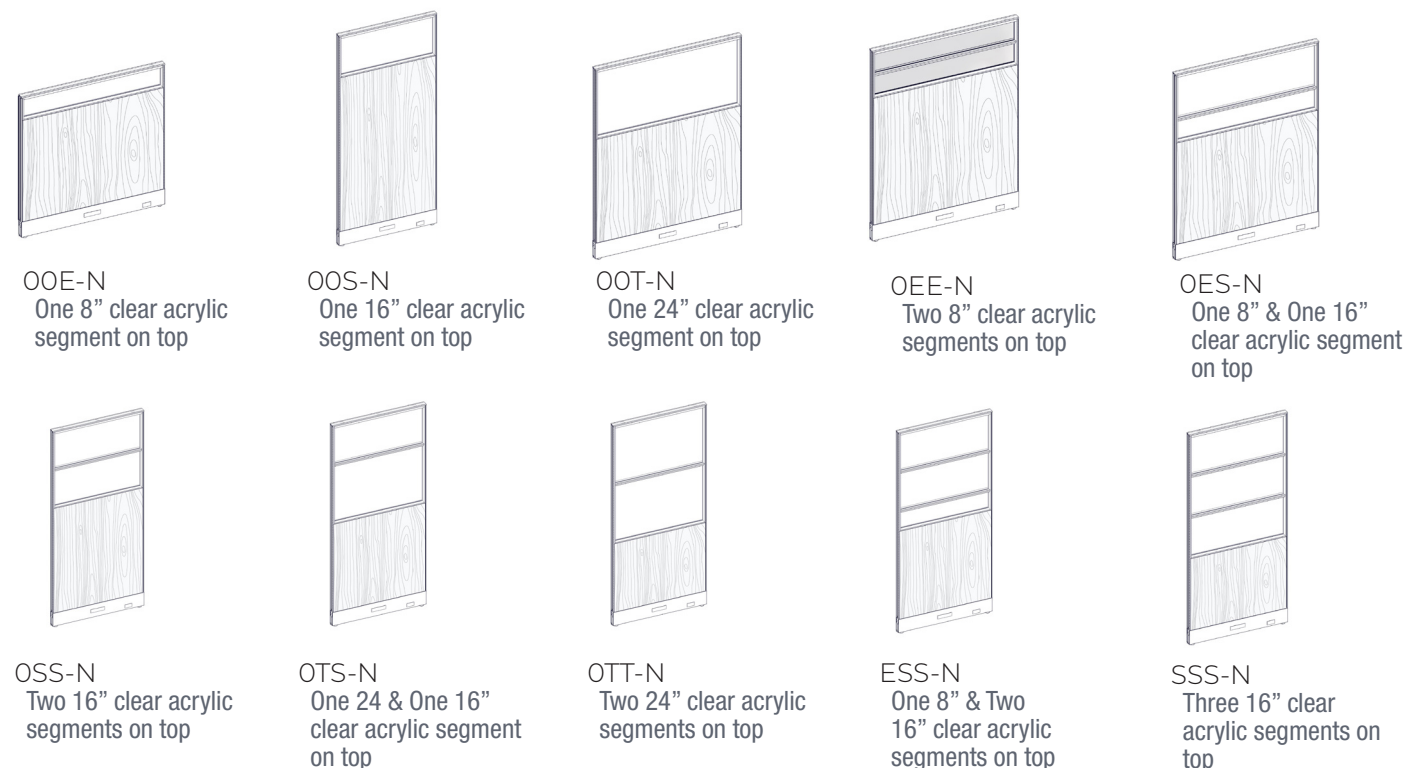

How to order and read your code

L - P P L C A - 42 24 - 00E - N

product line	standard	P=glazed E=Elevated	F=Fabric L=Laminate	C=Clear F=Frosted	A=Acrylic height G=Glass	width	0=No segment E=8 inch segment S=16 inch segment T=24 inch segment	N=Non powered E=Powered
--------------	----------	------------------------	------------------------	----------------------	-----------------------------	-------	--	----------------------------

What's Included:

One (1) 2" thick laminate panel with 1" incremented slotted channels,
Two (2) raceway covers,
One (1) top trim

How to Specify:

Refer to laminate cards for laminate selections
Choose White, Black, Silver, Charcoal for Panel Frame colour

Options:

Height*:	34", 42", 50", 66", 82"
Width:	24", 30", 36", 42", 48",
Laminate	
Metal Powder Coat Paint:	White, Black, Silver, Charcoal

*82"H available up to 36"W

Code	Price	H	W	D
One 8" clear acrylic segment on top				
L-PPLCA-4224-00E-N	1151	42	24	2
L-PPLCA-4230-00E-N	1203	42	30	2
L-PPLCA-4236-00E-N	1258	42	36	2
L-PPLCA-4242-00E-N	1367	42	42	2
L-PPLCA-4248-00E-N	1396	42	48	2
L-PPLCA-5024-00E-N	1051	50	24	2
L-PPLCA-5030-00E-N	1080	50	30	2
L-PPLCA-5036-00E-N	1135	50	36	2
L-PPLCA-5042-00E-N	1289	50	42	2
L-PPLCA-5048-00E-N	1318	50	48	2
One 16" clear acrylic segment on top				
L-PPLCA-5024-00S-N	1066	50	24	2
L-PPLCA-5030-00S-N	1105	50	30	2
L-PPLCA-5036-00S-N	1167	50	36	2
L-PPLCA-5042-00S-N	1305	50	42	2
L-PPLCA-5048-00S-N	1341	50	48	2
L-PPLCA-6624-00S-N	1167	66	24	2
L-PPLCA-6630-00S-N	1203	66	30	2
L-PPLCA-6636-00S-N	1280	66	36	2
L-PPLCA-6642-00S-N	1482	66	42	2
L-PPLCA-6648-00S-N	1521	66	48	2
L-PPLCA-8224-00S-N	1541	82	24	2
L-PPLCA-8230-00S-N	1556	82	30	2
L-PPLCA-8236-00S-N	2076	82	36	2
One 24" clear acrylic segment on top				
L-PPLCA-6624-00T-N	1156	66	24	2
L-PPLCA-6630-00T-N	1201	66	30	2
L-PPLCA-6636-00T-N	1278	66	36	2
L-PPLCA-6642-00T-N	1445	66	42	2
L-PPLCA-6648-00T-N	1492	66	48	2
Two 8" clear acrylic segments on top				
L-PPLCA-6624-0EE-N	1344	66	24	2
L-PPLCA-6630-0EE-N	1362	66	30	2
L-PPLCA-6636-0EE-N	1644	66	36	2
L-PPLCA-6642-0EE-N	1680	66	42	2
L-PPLCA-6648-0EE-N	1736	66	48	2
One 8" & One 16" clear acrylic segment on top				
L-PPLCA-6624-0ES-N	1350	66	24	2
L-PPLCA-6630-0ES-N	1407	66	30	2
L-PPLCA-6636-0ES-N	1712	66	36	2
L-PPLCA-6642-0ES-N	1770	66	42	2
L-PPLCA-6648-0ES-N	1827	66	48	2
Two 16" clear acrylic segments on top				
L-PPLCA-8224-0SS-N	1404	82	24	2
L-PPLCA-8230-0SS-N	1474	82	30	2
L-PPLCA-8236-0SS-N	1812	82	36	2
One 24" & One 16" clear acrylic segment on top				
L-PPLCA-8224-0TS-N	1436	82	24	2
L-PPLCA-8230-0TS-N	1529	82	30	2
L-PPLCA-8236-0TS-N	1821	82	36	2
Two 24" clear acrylic segments on top				
L-PPLCA-8224-0TT-N	1373	82	24	2
L-PPLCA-8230-0TT-N	1453	82	30	2
L-PPLCA-8236-0TT-N	1707	82	36	2
One 8" & Two 16" clear acrylic segments on top				
L-PPLCA-8224-ESS-N	1498	82	24	2
L-PPLCA-8230-ESS-N	1661	82	30	2
L-PPLCA-8236-ESS-N	1964	82	36	2
Three 16" clear acrylic segments on top				
L-PPLCA-8224-SSS-N	1468	82	24	2
L-PPLCA-8230-SSS-N	1555	82	30	2
L-PPLCA-8236-SSS-N	1884	82	36	2

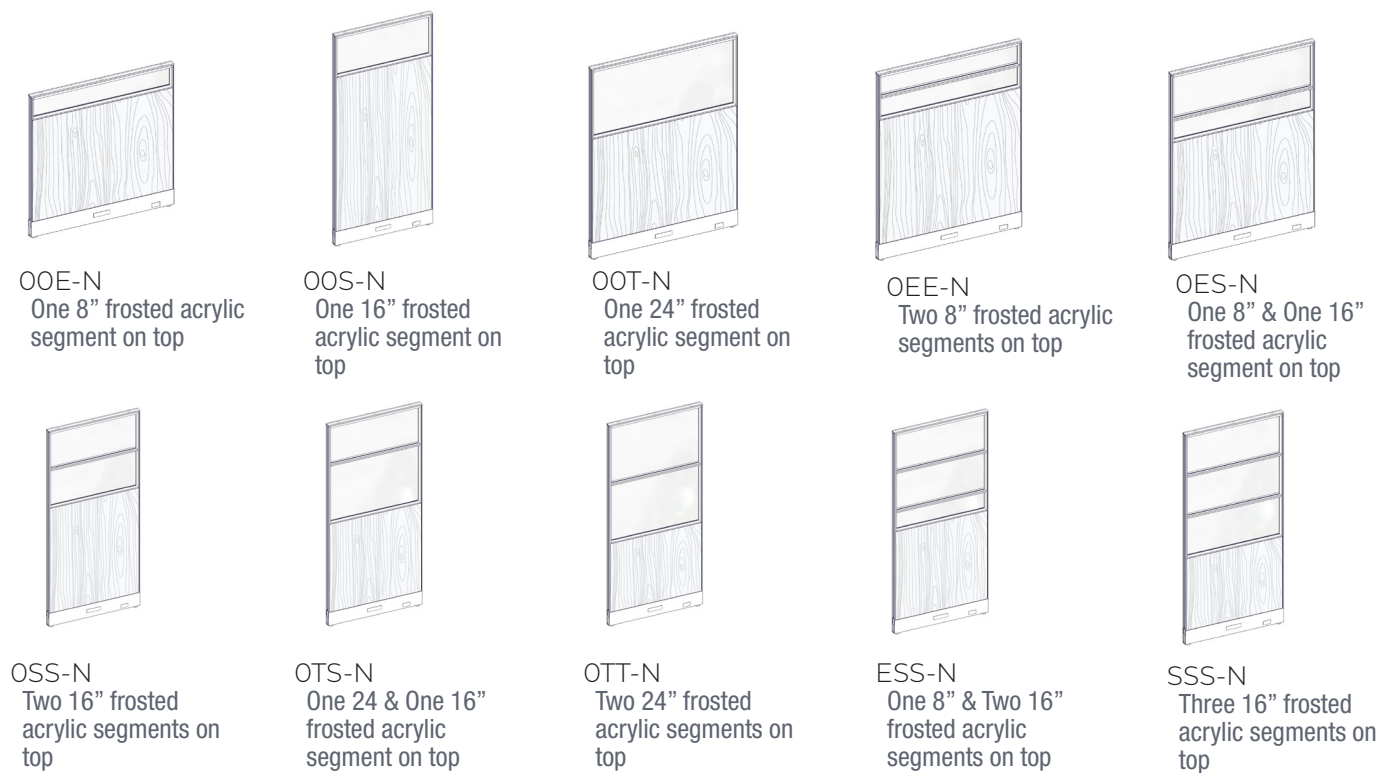

How to order and read your code

L - P P L F A - 42 24 - 00E - N

product line	standard	P=glazed E=Elevated	F=Fabric L=Laminate	C=Clear F=Frosted	A=Acrylic height G=Glass	width	0=No segment E=8 inch segment S=16 inch segment T=24 inch segment	N=Non powered E=Powered
--------------	----------	------------------------	------------------------	----------------------	-----------------------------	-------	--	----------------------------

What's Included:

One (1) 2" thick laminate panel with 1" incremented slotted channels,
Two (2) raceway covers,
One (1) top trim

How to Specify:

Refer to laminate cards for laminate selections
Choose White, Black, Silver, Charcoal for Panel Frame colour

Options:

Height*:	34", 42", 50", 66", 82"
Width:	24", 30", 36", 42", 48",
Laminate	
Metal Powder Coat Paint:	White, Black, Silver, Charcoal

*82"H available up to 36"W

Code	Price	H	W	D
One 8" frosted acrylic segment on top				
L-PPLFA-4224-00E-N	1117	42	24	2
L-PPLFA-4230-00E-N	1144	42	30	2
L-PPLFA-4236-00E-N	1197	42	36	2
L-PPLFA-4242-00E-N	1330	42	42	2
L-PPLFA-4248-00E-N	1359	42	48	2
L-PPLFA-5024-00E-N	1154	50	24	2
L-PPLFA-5030-00E-N	1181	50	30	2
L-PPLFA-5036-00E-N	1237	50	36	2
L-PPLFA-5042-00E-N	1391	50	42	2
L-PPLFA-5048-00E-N	1420	50	48	2
One 16" frosted acrylic segment on top				
L-PPLFA-5024-00S-N	1168	50	24	2
L-PPLFA-5030-00S-N	1207	50	30	2
L-PPLFA-5036-00S-N	1269	50	36	2
L-PPLFA-5042-00S-N	1407	50	42	2
L-PPLFA-5048-00S-N	1443	50	48	2
L-PPLFA-6624-00S-N	1269	66	24	2
L-PPLFA-6630-00S-N	1305	66	30	2
L-PPLFA-6636-00S-N	1382	66	36	2
L-PPLFA-6642-00S-N	1584	66	42	2
L-PPLFA-6648-00S-N	1623	66	48	2
L-PPLFA-8224-00S-N	1575	82	24	2
L-PPLFA-8230-00S-N	1605	82	30	2
L-PPLFA-8236-00S-N	2134	82	36	2
One 24" frosted acrylic segment on top				
L-PPLFA-6624-00T-N	1258	66	24	2
L-PPLFA-6630-00T-N	1304	66	30	2
L-PPLFA-6636-00T-N	1369	66	36	2
L-PPLFA-6642-00T-N	1547	66	42	2
L-PPLFA-6648-00T-N	1594	66	48	2
Two 8" frosted acrylic segments on top				
L-PPLFA-6624-0EE-N	1406	66	24	2
L-PPLFA-6630-0EE-N	1443	66	30	2
L-PPLFA-6636-0EE-N	1752	66	36	2
L-PPLFA-6642-0EE-N	1785	66	42	2
L-PPLFA-6648-0EE-N	1858	66	48	2
One 8" & One 16" frosted acrylic segment on top				
L-PPLFA-6624-0ES-N	1403	66	24	2
L-PPLFA-6630-0ES-N	1477	66	30	2
L-PPLFA-6636-0ES-N	1794	66	36	2
L-PPLFA-6642-0ES-N	1872	66	42	2
L-PPLFA-6648-0ES-N	1930	66	48	2
Two 16" frosted acrylic segments on top				
L-PPLFA-8224-0SS-N	1306	82	24	2
L-PPLFA-8230-0SS-N	1336	82	30	2
L-PPLFA-8236-0SS-N	1628	82	36	2
One 24" & One 16" frosted acrylic segment on top				
L-PPLFA-8224-0TS-N	1540	82	24	2
L-PPLFA-8230-0TS-N	1667	82	30	2
L-PPLFA-8236-0TS-N	1959	82	36	2
Two 24" frosted acrylic segments on top				
L-PPLFA-8224-0TT-N	1477	82	24	2
L-PPLFA-8230-0TT-N	1592	82	30	2
L-PPLFA-8236-0TT-N	1872	82	36	2
One 8" & Two 16" frosted acrylic segments on top				
L-PPLFA-8224-ESS-N	1602	82	24	2
L-PPLFA-8230-ESS-N	1798	82	30	2
L-PPLFA-8236-ESS-N	2102	82	36	2
Three 16" frosted acrylic segments on top				
L-PPLFA-8224-SSS-N	1571	82	24	2
L-PPLFA-8230-SSS-N	1694	82	30	2
L-PPLFA-8236-SSS-N	2092	82	36	2

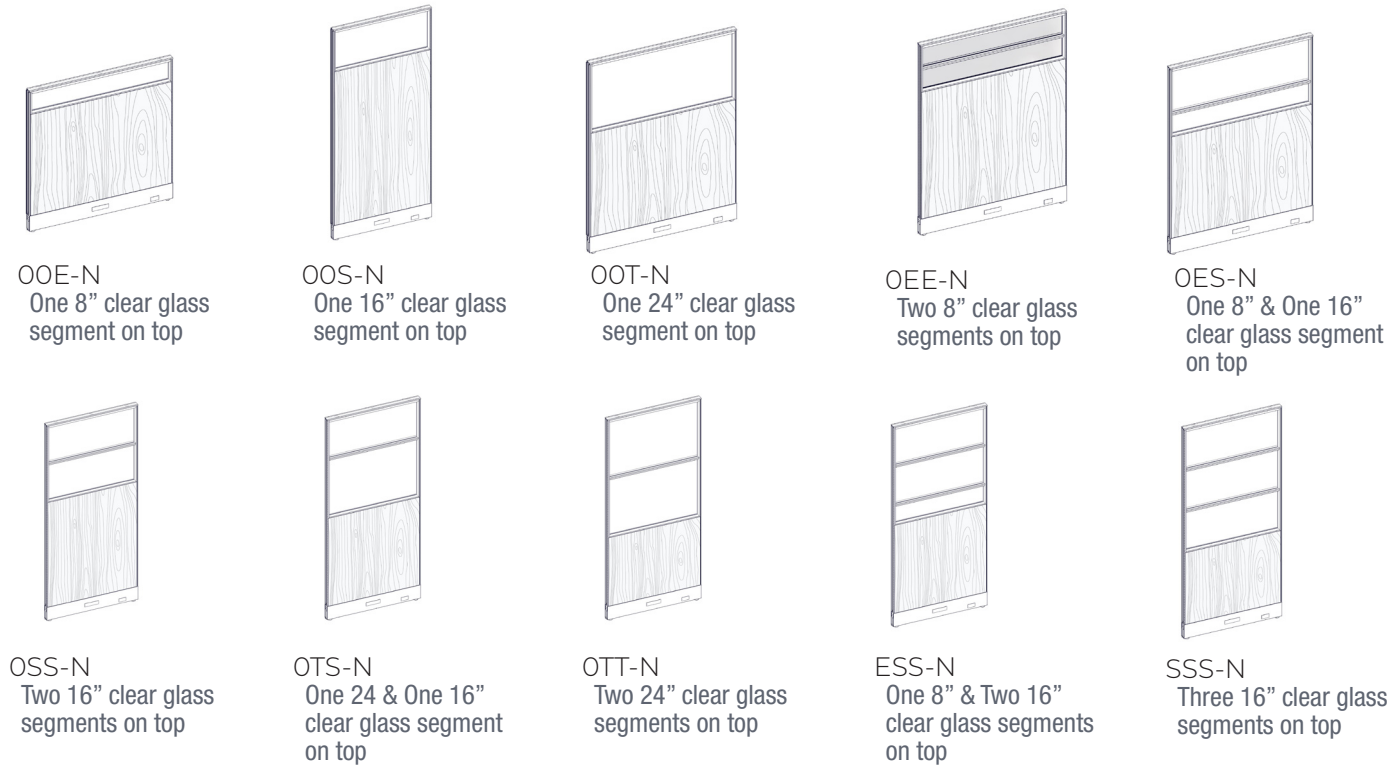

How to order and read your code

L - P P L C G - 42 24 - 00E - N

product line	standard	P=glazed E=Elevated	F=Fabric L=Laminate	C=Clear F=Frosted	A=Acrylic G=Glass	height	width	0=No segment E=8 inch segment S=16 inch segment T=24 inch segment	N=Non powered E=Powered
--------------	----------	------------------------	------------------------	----------------------	----------------------	--------	-------	--	----------------------------

What's Included:

One (1) 2" thick laminate panel with 1" incremented slotted channels,
Two (2) raceway covers,
One (1) top trim

How to Specify:

Refer to laminate cards for laminate selections
Choose White, Black, Silver, Charcoal for Panel Frame colour

Options:

Height*:	34", 42", 50", 66", 82"
Width:	24", 30", 36", 42", 48",
Laminate	
Metal Powder Coat Paint:	White, Black, Silver, Charcoal

*82"H available up to 36"W

Code	Price	H	W	D
One 8" clear glass segment on top				
L-PPLCG-4224-00E-N	1249	42	24	2
L-PPLCG-4230-00E-N	1312	42	30	2
L-PPLCG-4236-00E-N	1373	42	36	2
L-PPLCG-4242-00E-N	1443	42	42	2
L-PPLCG-4248-00E-N	1408	42	48	2
L-PPLCG-5024-00E-N	1134	50	24	2
L-PPLCG-5030-00E-N	1179	50	30	2
L-PPLCG-5036-00E-N	1256	50	36	2
L-PPLCG-5042-00E-N	1420	50	42	2
L-PPLCG-5048-00E-N	1469	50	48	2
One 16" clear glass segment on top				
L-PPLCG-5024-00S-N	1203	50	24	2
L-PPLCG-5030-00S-N	1268	50	30	2
L-PPLCG-5036-00S-N	1361	50	36	2
L-PPLCG-5042-00S-N	1525	50	42	2
L-PPLCG-5048-00S-N	1592	50	48	2
L-PPLCG-6624-00S-N	1301	66	24	2
L-PPLCG-6630-00S-N	1368	66	30	2
L-PPLCG-6636-00S-N	1472	66	36	2
L-PPLCG-6642-00S-N	1700	66	42	2
L-PPLCG-6648-00S-N	1767	66	48	2
L-PPLCG-8224-00S-N	1499	82	24	2
L-PPLCG-8230-00S-N	1543	82	30	2
L-PPLCG-8236-00S-N	2082	82	36	2
One 24" clear glass segment on top				
L-PPLCG-6624-00T-N	1343	66	24	2
L-PPLCG-6630-00T-N	1430	66	30	2
L-PPLCG-6636-00T-N	1543	66	36	2
L-PPLCG-6642-00T-N	1752	66	42	2
L-PPLCG-6648-00T-N	1842	66	48	2
Two 8" clear glass segments on top				
L-PPLCG-6624-0EE-N	1441	66	24	2
L-PPLCG-6630-0EE-N	1491	66	30	2
L-PPLCG-6636-0EE-N	1798	66	36	2
L-PPLCG-6642-0EE-N	1846	66	42	2
L-PPLCG-6648-0EE-N	1919	66	48	2
One 8" & One 16" clear glass segment on top				
L-PPLCG-6624-0ES-N	1441	66	24	2
L-PPLCG-6630-0ES-N	1510	66	30	2
L-PPLCG-6636-0ES-N	1833	66	36	2
L-PPLCG-6642-0ES-N	1895	66	42	2
L-PPLCG-6648-0ES-N	1983	66	48	2
Two 16" clear glass segments on top				
L-PPLCG-8224-0SS-N	1494	82	24	2
L-PPLCG-8230-0SS-N	1561	82	30	2
L-PPLCG-8236-0SS-N	1898	82	36	2
One 24" & One 16" clear glass segment on top				
L-PPLCG-8224-0TS-N	1524	82	24	2
L-PPLCG-8230-0TS-N	1617	82	30	2
L-PPLCG-8236-0TS-N	1960	82	36	2
Two 24" clear glass segments on top				
L-PPLCG-8224-0TT-N	1494	82	24	2
L-PPLCG-8230-0TT-N	1590	82	30	2
L-PPLCG-8236-0TT-N	1861	82	36	2
One 8" & Two 16" clear glass segments on top				
L-PPLCG-8224-ESS-N	1673	82	24	2
L-PPLCG-8230-ESS-N	1827	82	30	2
L-PPLCG-8236-ESS-N	2183	82	36	2
Three 16" clear glass segments on top				
L-PPLCG-8224-SSS-N	1650	82	24	2
L-PPLCG-8230-SSS-N	1740	82	30	2
L-PPLCG-8236-SSS-N	2035	82	36	2

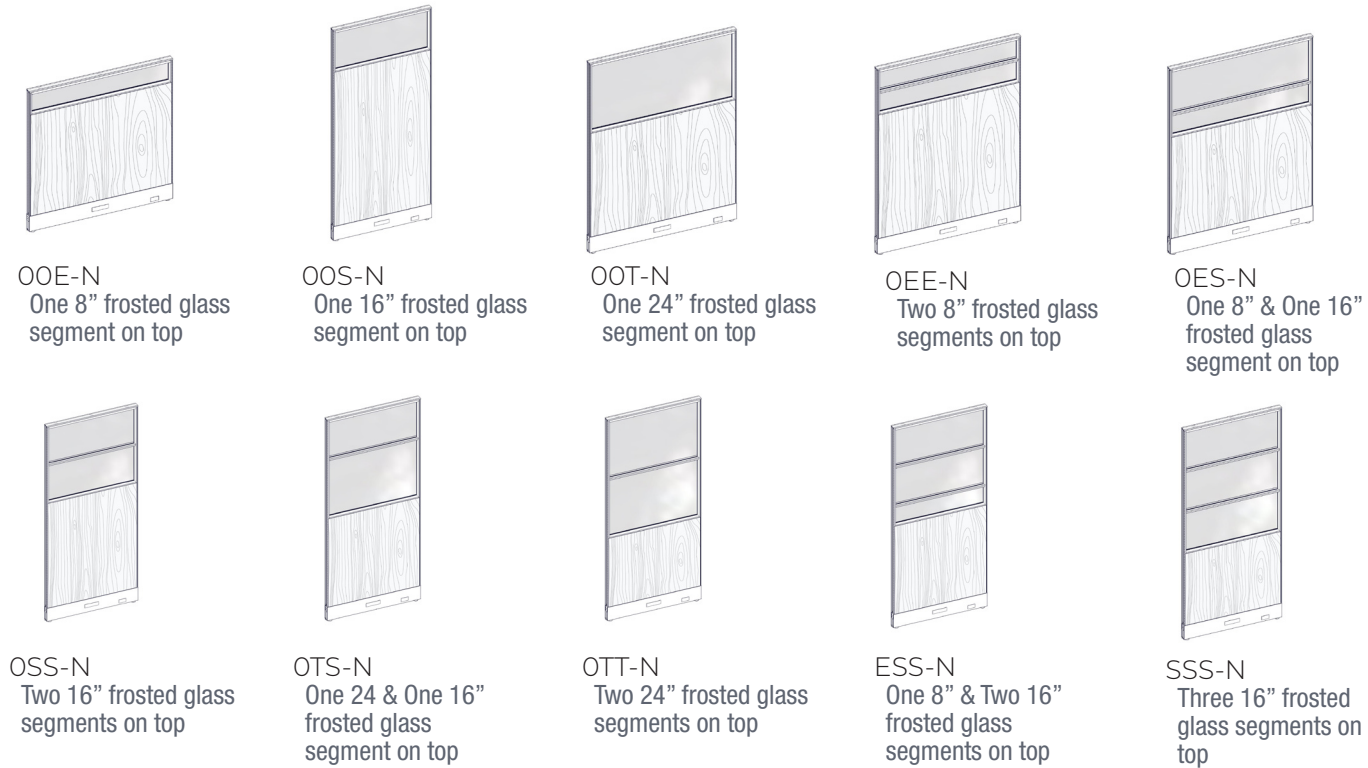

How to order and read your code

L - P P L F G - 42 24 - 00E - N

product standard P=glazed F=Fabric C=Clear A=Acrylic height width 0=No segment N=Non powered
 line E=Elevated L=Laminate F=Frosted G=Glass E=Powered
 S=16 inch segment
 T=24 inch segment

What's Included:

One (1) 2" thick laminate panel with 1" incremented slotted channels,
 Two (2) raceway covers,
 One (1) top trim

How to Specify:

Refer to laminate cards for laminate selections
 Choose White, Black, Silver, Charcoal for Panel Frame colour

Options:

Height*: 34", 42", 50", 66", 82"

Width: 24", 30", 36", 42", 48",

Laminate

Metal Powder Coat Paint: White, Black, Silver, Charcoal

*82"H available up to 36"W

Code	Price	H	W	D
One 8" frosted glass segment on top				
L-PPLFG-4224-00E-N	1201	42	24	2
L-PPLFG-4230-00E-N	1243	42	30	2
L-PPLFG-4236-00E-N	1315	42	36	2
L-PPLFG-4242-00E-N	1465	42	42	2
L-PPLFG-4248-00E-N	1510	42	48	2
L-PPLFG-5024-00E-N	1236	50	24	2
L-PPLFG-5030-00E-N	1281	50	30	2
L-PPLFG-5036-00E-N	1358	50	36	2
L-PPLFG-5042-00E-N	1522	50	42	2
L-PPLFG-5048-00E-N	1571	50	48	2
One 16" frosted glass segment on top				
L-PPLFG-5024-00S-N	1305	50	24	2
L-PPLFG-5030-00S-N	1369	50	30	2
L-PPLFG-5036-00S-N	1463	50	36	2
L-PPLFG-5042-00S-N	1628	50	42	2
L-PPLFG-5048-00S-N	1694	50	48	2
L-PPLFG-6624-00S-N	1404	66	24	2
L-PPLFG-6630-00S-N	1470	66	30	2
L-PPLFG-6636-00S-N	1574	66	36	2
L-PPLFG-6642-00S-N	1803	66	42	2
L-PPLFG-6648-00S-N	1869	66	48	2
L-PPLFG-8224-00S-N	1584	82	24	2
L-PPLFG-8230-00S-N	1635	82	30	2
L-PPLFG-8236-00S-N	2193	82	36	2
One 24" frosted glass segment on top				
L-PPLFG-6624-00T-N	1445	66	24	2
L-PPLFG-6630-00T-N	1532	66	30	2
L-PPLFG-6636-00T-N	1645	66	36	2
L-PPLFG-6642-00T-N	1854	66	42	2
L-PPLFG-6648-00T-N	1944	66	48	2
Two 8" frosted glass segments on top				
L-PPLFG-6624-0EE-N	1608	66	24	2
L-PPLFG-6630-0EE-N	1657	66	30	2
L-PPLFG-6636-0EE-N	1964	66	36	2
L-PPLFG-6642-0EE-N	2014	66	42	2
L-PPLFG-6648-0EE-N	2085	66	48	2
One 8" & One 16" frosted glass segment on top				
L-PPLFG-6624-0ES-N	1608	66	24	2
L-PPLFG-6630-0ES-N	1686	66	30	2
L-PPLFG-6636-0ES-N	2028	66	36	2
L-PPLFG-6642-0ES-N	2108	66	42	2
L-PPLFG-6648-0ES-N	2216	66	48	2
Two 16" frosted glass segments on top				
L-PPLFG-8224-0SS-N	1661	82	24	2
L-PPLFG-8230-0SS-N	1745	82	30	2
L-PPLFG-8236-0SS-N	2121	82	36	2
One 24" & One 16" frosted glass segment on top				
L-PPLFG-8224-0TS-N	1719	82	24	2
L-PPLFG-8230-0TS-N	1847	82	30	2
L-PPLFG-8236-0TS-N	2240	82	36	2
Two 24" frosted glass segments on top				
L-PPLFG-8224-0TT-N	1718	82	24	2
L-PPLFG-8230-0TT-N	1868	82	30	2
L-PPLFG-8236-0TT-N	2197	82	36	2
One 8" & Two 16" frosted glass segments on top				
L-PPLFG-8224-ESS-N	1924	82	24	2
L-PPLFG-8230-ESS-N	2096	82	30	2
L-PPLFG-8236-ESS-N	2490	82	36	2
Three 16" frosted glass segments on top				
L-PPLFG-8224-SSS-N	1901	82	24	2
L-PPLFG-8230-SSS-N	2017	82	30	2
L-PPLFG-8236-SSS-N	2369	82	36	2

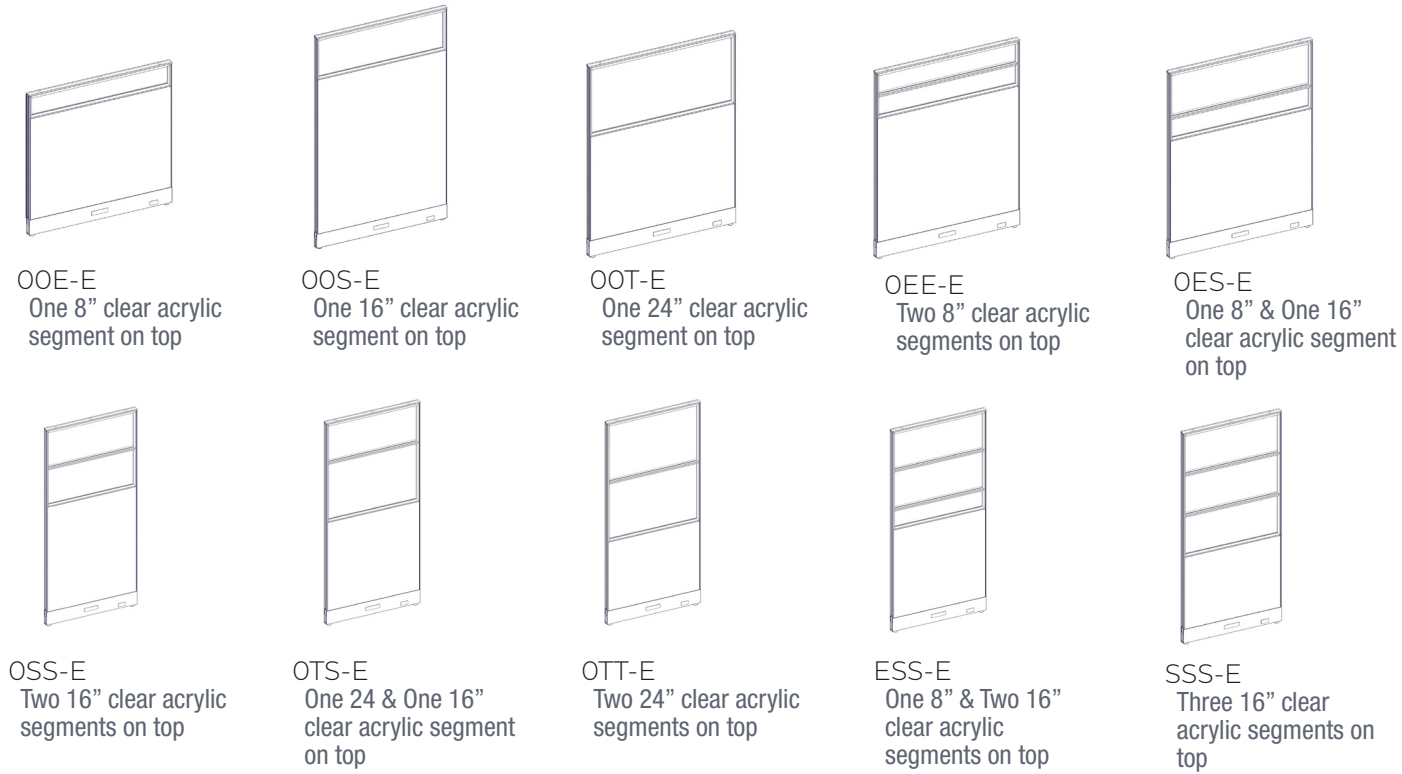

How to order and read your code

L - P P F C A - 42 24 - 00E - E

product standard P= glazed F=Fabric C=Clear A=Acrylic height width 0 = No segment N=Non powered
 line E = Elevated L=Laminate F=Frosted G=Glass E = 8 inch segment E=Powered
 S = 16 inch segment
 T = 24 inch segment

What's Included:

One (1) 2" thick laminate panel with 1" incremented slotted channels,
 Two (2) raceway covers,
 One (1) top trim

How to Specify:

Refer to laminate cards for laminate selections
 Choose White, Black, Silver, Charcoal for Panel Frame colour

Options:

Height*: 34", 42", 50", 66", 82"

Width: 24", 30", 36", 42", 48",

Laminate

Metal Powder Coat Paint: White, Black, Silver, Charcoal

*82"H available up to 36"W

Code	Price	H	W	D
One 8" clear acrylic segment on top				
L-PPFCA-4224-00E-E	827	42	24	2
L-PPFCA-4230-00E-E	907	42	30	2
L-PPFCA-4236-00E-E	987	42	36	2
L-PPFCA-4242-00E-E	1067	42	42	2
L-PPFCA-4248-00E-E	1147	42	48	2
L-PPFCA-4254-00E-E	1231	42	54	2
L-PPFCA-4260-00E-E	1310	42	60	2
L-PPFCA-5024-00E-E	827	50	24	2
L-PPFCA-5030-00E-E	907	50	30	2
L-PPFCA-5036-00E-E	987	50	36	2
L-PPFCA-5042-00E-E	1067	50	42	2
L-PPFCA-5048-00E-E	1147	50	48	2
L-PPFCA-5054-00E-E	1231	50	54	2
L-PPFCA-5060-00E-E	1310	50	60	2
One 16" clear acrylic segment on top				
L-PPFCA-5024-00S-E	827	50	24	2
L-PPFCA-5030-00S-E	907	50	30	2
L-PPFCA-5036-00S-E	987	50	36	2
L-PPFCA-5042-00S-E	1067	50	42	2
L-PPFCA-5048-00S-E	1147	50	48	2
L-PPFCA-5054-00S-E	1231	50	54	2
L-PPFCA-5060-00S-E	1310	50	60	2
L-PPFCA-6624-00S-E	956	66	24	2
L-PPFCA-6630-00S-E	1056	66	30	2
L-PPFCA-6636-00S-E	1157	66	36	2
L-PPFCA-6642-00S-E	1258	66	42	2
L-PPFCA-6648-00S-E	1360	66	48	2
L-PPFCA-6654-00S-E	1461	66	54	2
L-PPFCA-6660-00S-E	1563	66	60	2
L-PPFCA-8224-00S-E	1487	82	24	2
L-PPFCA-8230-00S-E	1723	82	30	2
L-PPFCA-8236-00S-E	1812	82	36	2
L-PPFCA-8242-00S-E	1856	82	42	2
L-PPFCA-8248-00S-E	1939	82	48	2
One 24" clear acrylic segment on top				
L-PPFCA-6624-00T-E	956	66	24	2
L-PPFCA-6630-00T-E	1056	66	30	2
L-PPFCA-6636-00T-E	1157	66	36	2
L-PPFCA-6642-00T-E	1258	66	42	2
L-PPFCA-6648-00T-E	1360	66	48	2
L-PPFCA-6654-00T-E	1461	66	54	2
L-PPFCA-6660-00T-E	1563	66	60	2
Two 8" clear acrylic segments on top				
L-PPFCA-6624-0EE-E	1470	66	24	2
L-PPFCA-6630-0EE-E	1662	66	30	2
L-PPFCA-6636-0EE-E	1732	66	36	2
L-PPFCA-6642-0EE-E	1789	66	42	2
L-PPFCA-6648-0EE-E	1866	66	48	2
L-PPFCA-6654-0EE-E	1984	66	54	2
L-PPFCA-6660-0EE-E	2036	66	60	2
One 8" & One 16" clear acrylic segment on top				
L-PPFCA-6624-0ES-E	1436	66	24	2
L-PPFCA-6630-0ES-E	1621	66	30	2
L-PPFCA-6636-0ES-E	1703	66	36	2
L-PPFCA-6642-0ES-E	1785	66	42	2
L-PPFCA-6648-0ES-E	1870	66	48	2
L-PPFCA-6654-0ES-E	1960	66	54	2
L-PPFCA-6660-0ES-E	2003	66	60	2
Two 16" clear acrylic segments on top				
L-PPFCA-8224-0SS-E	1529	82	24	2
L-PPFCA-8230-0SS-E	1777	82	30	2
L-PPFCA-8236-0SS-E	1901	82	36	2
L-PPFCA-8242-0SS-E	1956	82	42	2
L-PPFCA-8248-0SS-E	2034	82	48	2
One 24" & One 16" clear acrylic segment on top				
L-PPFCA-8224-0TS-E	1520	82	24	2
L-PPFCA-8230-0TS-E	1743	82	30	2
L-PPFCA-8236-0TS-E	1812	82	36	2
L-PPFCA-8242-0TS-E	1867	82	42	2
L-PPFCA-8248-0TS-E	2055	82	48	2
Two 24" clear acrylic segments on top				
L-PPFCA-8224-0TT-E	1516	82	24	2
L-PPFCA-8230-0TT-E	1718	82	30	2
L-PPFCA-8236-0TT-E	1808	82	36	2
L-PPFCA-8242-0TT-E	1926	82	42	2
L-PPFCA-8248-0TT-E	2002	82	48	2
One 8" & Two 16" clear acrylic segments on top				
L-PPFCA-8224-ESS-E	1583	82	24	2
L-PPFCA-8230-ESS-E	1878	82	30	2
L-PPFCA-8236-ESS-E	1956	82	36	2
L-PPFCA-8242-ESS-E	1959	82	42	2
L-PPFCA-8248-ESS-E	2145	82	48	2
Three 16" clear acrylic segments on top				
L-PPFCA-8224-SSS-E	1610	82	24	2
L-PPFCA-8230-SSS-E	1820	82	30	2
L-PPFCA-8236-SSS-E	1986	82	36	2
L-PPFCA-8242-SSS-E	2052	82	42	2
L-PPFCA-8248-SSS-E	2139	82	48	2

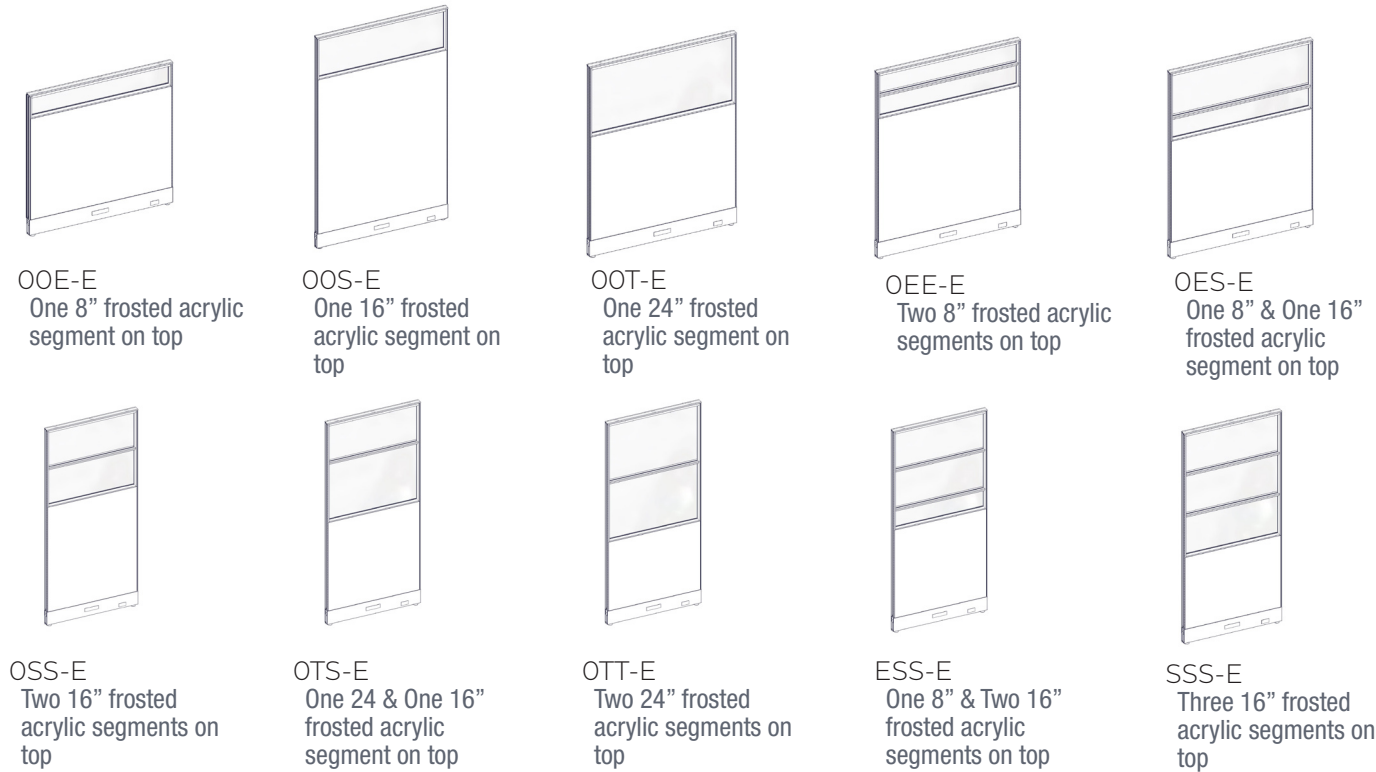

How to order and read your code

L - P P F F A - 42 24 - 00 E - E

product standard P=glazed F=Fabric C=Clear A=Acrylic height width O=No segment N=Non powered
 line E=Elevated L=Laminate F=Frosted G=Glass E=8 inch segment E=Powered
 S=16 inch segment
 T=24 inch segment

What's Included:

One (1) 2" thick laminate panel with 1" incremented slotted channels,
 Two (2) raceway covers,
 One (1) top trim

How to Specify:

Refer to laminate cards for laminate selections
 Choose White, Black, Silver, Charcoal for Panel Frame colour

Options:

Height*:	34", 42", 50", 66", 82"
Width:	24", 30", 36", 42", 48",
Laminate	
Metal Powder Coat Paint:	White, Black, Silver, Charcoal

*82"H available up to 36"W

Code	Price	H	W	D
One 8" frosted acrylic segment on top				
L-PPFFA-4224-00E-E	929	42	24	2
L-PPFFA-4230-00E-E	1009	42	30	2
L-PPFFA-4236-00E-E	1089	42	36	2
L-PPFFA-4242-00E-E	1169	42	42	2
L-PPFFA-4248-00E-E	1249	42	48	2
L-PPFFA-4254-00E-E	1333	42	54	2
L-PPFFA-4260-00E-E	1411	42	60	2
L-PPFFA-5024-00E-E	929	50	24	2
L-PPFFA-5030-00E-E	1009	50	30	2
L-PPFFA-5036-00E-E	1089	50	36	2
L-PPFFA-5042-00E-E	1169	50	42	2
L-PPFFA-5048-00E-E	1249	50	48	2
L-PPFFA-5054-00E-E	1333	50	54	2
L-PPFFA-5060-00E-E	1411	50	60	2
One 16" frosted acrylic segment on top				
L-PPFFA-5024-00S-E	929	50	24	2
L-PPFFA-5030-00S-E	1009	50	30	2
L-PPFFA-5036-00S-E	1089	50	36	2
L-PPFFA-5042-00S-E	1169	50	42	2
L-PPFFA-5048-00S-E	1249	50	48	2
L-PPFFA-5054-00S-E	1333	50	54	2
L-PPFFA-5060-00S-E	1411	50	60	2
L-PPFFA-6624-00S-E	1058	50	24	2
L-PPFFA-6630-00S-E	1158	50	30	2
L-PPFFA-6636-00S-E	1259	50	36	2
L-PPFFA-6642-00S-E	1360	50	42	2
L-PPFFA-6648-00S-E	1462	50	48	2
L-PPFFA-6654-00S-E	1563	50	54	2
L-PPFFA-6660-00S-E	1664	50	60	2
L-PPFFA-8224-00S-E	1522	82	24	2
L-PPFFA-8230-00S-E	1771	82	30	2
L-PPFFA-8236-00S-E	1872	82	36	2
L-PPFFA-8242-00S-E	1926	82	42	2
L-PPFFA-8248-00S-E	2007	82	48	2
One 24" frosted acrylic segment on top				
L-PPFFA-6624-00T-E	1058	66	24	2
L-PPFFA-6630-00T-E	1158	66	30	2
L-PPFFA-6636-00T-E	1259	66	36	2
L-PPFFA-6642-00T-E	1312	66	42	2
L-PPFFA-6648-00T-E	1415	66	48	2
L-PPFFA-6654-00T-E	1563	66	54	2
L-PPFFA-6660-00T-E	1664	66	60	2

Code	Price	H	W	D
Two 8" frosted acrylic segments on top				
L-PPFFA-6624-0EE-E	1531	66	24	2
L-PPFFA-6630-0EE-E	1744	66	30	2
L-PPFFA-6636-0EE-E	1840	66	36	2
L-PPFFA-6642-0EE-E	1895	66	42	2
L-PPFFA-6648-0EE-E	1989	66	48	2
L-PPFFA-6654-0EE-E	2071	66	54	2
L-PPFFA-6660-0EE-E	2122	66	60	2
One 8" & One 16" frosted acrylic segment on top				
L-PPFFA-6624-0ES-E	1486	66	24	2
L-PPFFA-6630-0ES-E	1691	66	30	2
L-PPFFA-6636-0ES-E	1786	66	36	2
L-PPFFA-6642-0ES-E	1889	66	42	2
L-PPFFA-6648-0ES-E	1973	66	48	2
L-PPFFA-6654-0ES-E	2075	66	54	2
L-PPFFA-6660-0ES-E	2138	66	60	2
Two 16" frosted acrylic segments on top				
L-PPFFA-8224-0SS-E	1431	82	24	2
L-PPFFA-8230-0SS-E	1636	82	30	2
L-PPFFA-8236-0SS-E	1717	82	36	2
L-PPFFA-8242-0SS-E	1779	82	42	2
L-PPFFA-8248-0SS-E	1845	82	48	2
One 24" & One 16" frosted acrylic segment on top				
L-PPFFA-8224-0TS-E	1623	82	24	2
L-PPFFA-8230-0TS-E	1881	82	30	2
L-PPFFA-8236-0TS-E	1949	82	36	2
L-PPFFA-8242-0TS-E	2039	82	42	2
L-PPFFA-8248-0TS-E	2263	82	48	2
Two 24" frosted acrylic segments on top				
L-PPFFA-8224-0TT-E	1619	82	24	2
L-PPFFA-8230-0TT-E	1856	82	30	2
L-PPFFA-8236-0TT-E	1973	82	36	2
L-PPFFA-8242-0TT-E	2132	82	42	2
L-PPFFA-8248-0TT-E	2207	82	48	2
One 8" & Two 16" frosted acrylic segments on top				
L-PPFFA-8224-ESS-E	1686	82	24	2
L-PPFFA-8230-ESS-E	2014	82	30	2
L-PPFFA-8236-ESS-E	2094	82	36	2
L-PPFFA-8242-ESS-E	2160	82	42	2
L-PPFFA-8248-ESS-E	2281	82	48	2
Three 16" frosted acrylic segments on top				
L-PPFFA-8224-SSS-E	1714	82	24	2
L-PPFFA-8230-SSS-E	1956	82	30	2
L-PPFFA-8236-SSS-E	2194	82	36	2
L-PPFFA-8242-SSS-E	2258	82	42	2
L-PPFFA-8248-SSS-E	2345	82	48	2

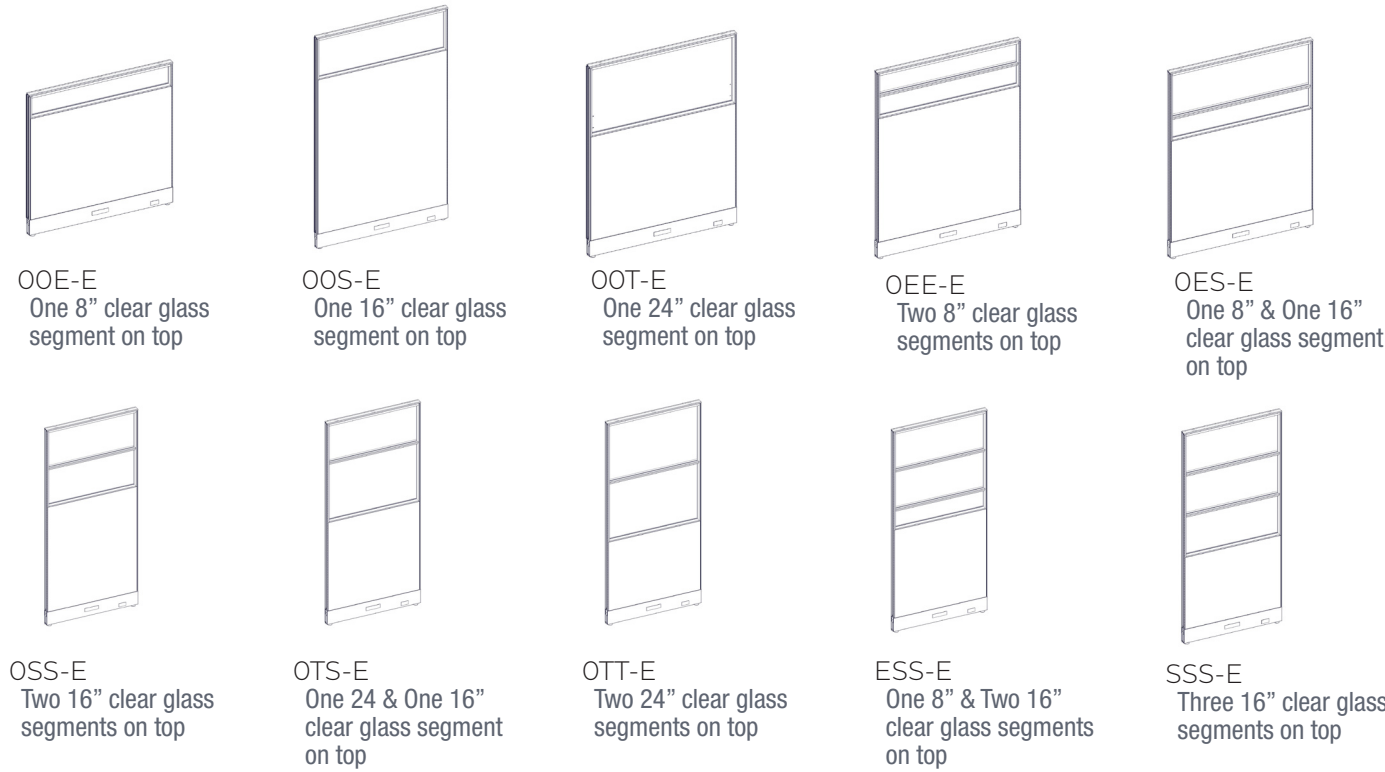

How to order and read your code

L - P P F C G - 42 24 - 00E - E

product standard P= glazed F=Fabric C=Clear A=Acrylic height width 0= No segment N=Non powered
 line line E = Elevated L=Laminate F=Frosted G=Glass E = 8 inch segment E=Powered
 S = 16 inch segment
 T = 24 inch segment

What's Included:

One (1) 2" thick laminate panel with 1" incremented slotted channels,
 Two (2) raceway covers,
 One (1) top trim

How to Specify:

Refer to laminate cards for laminate selections
 Choose White, Black, Silver, Charcoal for Panel Frame colour

Options:

Height*: 34", 42", 50", 66", 82"
 Width: 24", 30", 36", 42", 48",
 Laminate
 Metal Powder Coat Paint: White, Black, Silver, Charcoal

*82"H available up to 36"W

Code	Price	H	W	D
One 8" clear glass segment on top				
L-PPFCG-4224-00E-E	962	42	24	2
L-PPFCG-4230-00E-E	1042	42	30	2
L-PPFCG-4236-00E-E	1123	42	36	2
L-PPFCG-4242-00E-E	1203	42	42	2
L-PPFCG-4248-00E-E	1283	42	48	2
L-PPFCG-4254-00E-E	1366	42	54	2
L-PPFCG-4260-00E-E	1443	42	60	2
L-PPFCG-5024-00E-E	962	50	24	2
L-PPFCG-5030-00E-E	1042	50	30	2
L-PPFCG-5036-00E-E	1123	50	36	2
L-PPFCG-5042-00E-E	1203	50	42	2
L-PPFCG-5048-00E-E	1283	50	48	2
L-PPFCG-5054-00E-E	1366	50	54	2
L-PPFCG-5060-00E-E	1443	50	60	2
One 16" clear glass segment on top				
L-PPFCG-5024-00S-E	962	50	24	2
L-PPFCG-5030-00S-E	1042	50	30	2
L-PPFCG-5036-00S-E	1123	50	36	2
L-PPFCG-5042-00S-E	1203	50	42	2
L-PPFCG-5048-00S-E	1283	50	48	2
L-PPFCG-5054-00S-E	1366	50	54	2
L-PPFCG-5060-00S-E	1443	50	60	2
L-PPFCG-6624-00S-E	1100	66	24	2
L-PPFCG-6630-00S-E	1199	66	30	2
L-PPFCG-6636-00S-E	1301	66	36	2
L-PPFCG-6642-00S-E	1403	66	42	2
L-PPFCG-6648-00S-E	1506	66	48	2
L-PPFCG-6654-00S-E	1607	66	54	2
L-PPFCG-6660-00S-E	1709	66	60	2
L-PPFCG-8224-00S-E	1447	82	24	2
L-PPFCG-8230-00S-E	1709	82	30	2
L-PPFCG-8236-00S-E	1819	82	36	2
L-PPFCG-8242-00S-E	1879	82	42	2
L-PPFCG-8248-00S-E	1983	82	48	2
One 24" clear glass segment on top				
L-PPFCG-6624-00T-E	1100	66	24	2
L-PPFCG-6630-00T-E	1199	66	30	2
L-PPFCG-6636-00T-E	1301	66	36	2
L-PPFCG-6642-00T-E	1403	66	42	2
L-PPFCG-6648-00T-E	1506	66	48	2
L-PPFCG-6654-00T-E	1607	66	54	2
L-PPFCG-6660-00T-E	1709	66	60	2

Code	Price	H	W	D
Two 8" clear glass segments on top				
L-PPFCG-6624-0EE-E	1566	66	24	2
L-PPFCG-6630-0EE-E	1792	66	30	2
L-PPFCG-6636-0EE-E	1887	66	36	2
L-PPFCG-6642-0EE-E	1955	66	42	2
L-PPFCG-6648-0EE-E	2048	66	48	2
L-PPFCG-6654-0EE-E	2165	66	54	2
L-PPFCG-6660-0EE-E	2229	66	60	2
One 8" & One 16" clear glass segment on top				
L-PPFCG-6624-0ES-E	1525	66	24	2
L-PPFCG-6630-0ES-E	1724	66	30	2
L-PPFCG-6636-0ES-E	1823	66	36	2
L-PPFCG-6642-0ES-E	1911	66	42	2
L-PPFCG-6648-0ES-E	2027	66	48	2
L-PPFCG-6654-0ES-E	2153	66	54	2
L-PPFCG-6660-0ES-E	2223	66	60	2
Two 16" clear glass segments on top				
L-PPFCG-8224-0SS-E	1619	82	24	2
L-PPFCG-8230-0SS-E	1860	82	30	2
L-PPFCG-8236-0SS-E	1986	82	36	2
L-PPFCG-8242-0SS-E	2086	82	42	2
L-PPFCG-8248-0SS-E	2207	82	48	2
One 24" & One 16" clear glass segment on top				
L-PPFCG-8224-0TS-E	1608	82	24	2
L-PPFCG-8230-0TS-E	1831	82	30	2
L-PPFCG-8236-0TS-E	1952	82	36	2
L-PPFCG-8242-0TS-E	2064	82	42	2
L-PPFCG-8248-0TS-E	2201	82	48	2
Two 24" clear glass segments on top				
L-PPFCG-8224-0TT-E	1636	82	24	2
L-PPFCG-8230-0TT-E	1854	82	30	2
L-PPFCG-8236-0TT-E	1966	82	36	2
L-PPFCG-8242-0TT-E	2082	82	42	2
L-PPFCG-8248-0TT-E	2218	82	48	2
One 8" & Two 16" clear glass segments on top				
L-PPFCG-8224-0SS-E	1756	82	24	2
L-PPFCG-8230-0SS-E	2042	82	30	2
L-PPFCG-8236-0SS-E	2175	82	36	2
L-PPFCG-8242-0SS-E	2195	82	42	2
L-PPFCG-8248-0SS-E	2367	82	48	2
Three 16" clear glass segments on top				
L-PPFCG-8224-0SS-E	1793	82	24	2
L-PPFCG-8230-0SS-E	2003	82	30	2
L-PPFCG-8236-0SS-E	2139	82	36	2
L-PPFCG-8242-0SS-E	2268	82	42	2
L-PPFCG-8248-0SS-E	2423	82	48	2

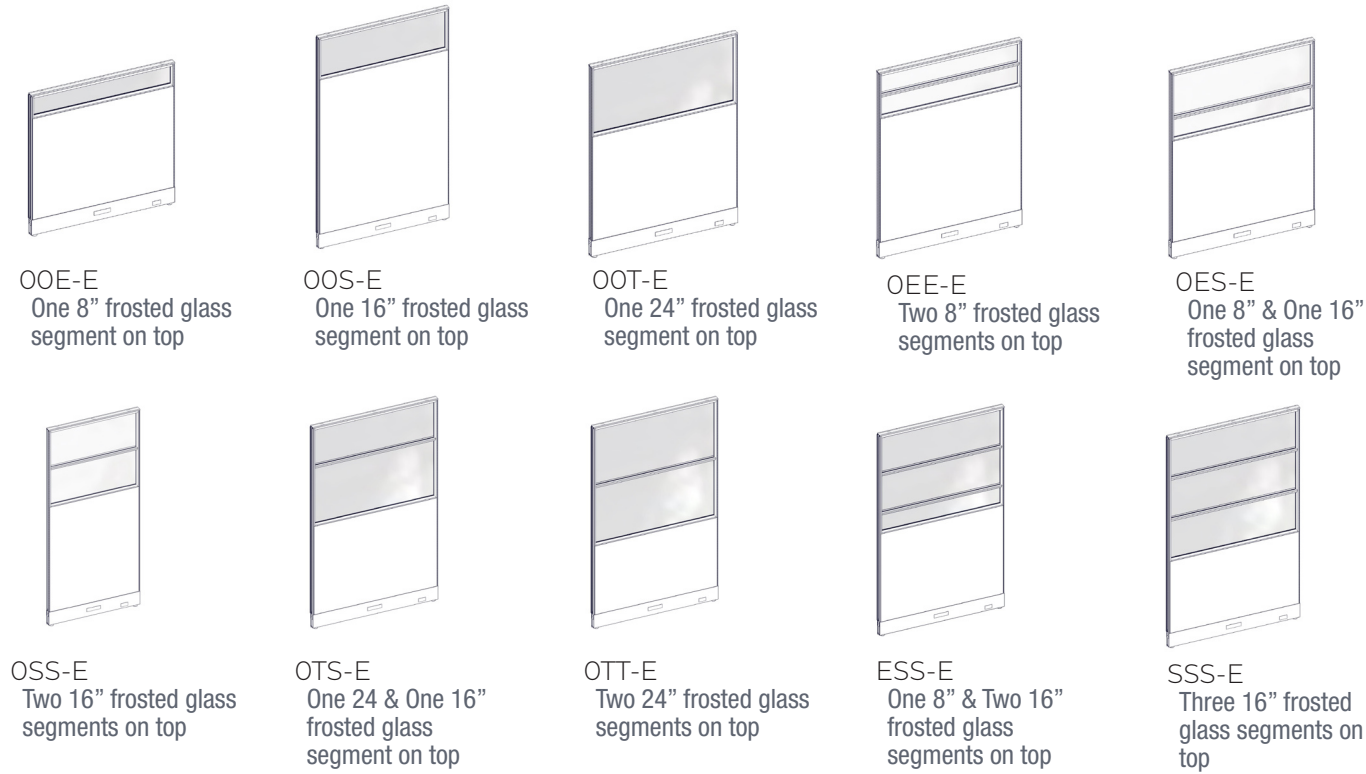

How to order and read your code

L - P P F F G - 42 24 - 00E - E

product standard P=glazed F=Fabric C=Clear A=Acrylic height width 0=No segment N=Non powered
line E=Elevated L=Laminate F=Frosted G=Glass E=8 inch segment E=Powered
S=16 inch segment
T=24 inch segment

What's Included:

One (1) 2" thick laminate panel with 1" incremented slotted channels,
Two (2) raceway covers,
One (1) top trim

How to Specify:

Refer to laminate cards for laminate selections
Choose White, Black, Silver, Charcoal for Panel Frame colour

Options:

Height*: 34", 42", 50", 66", 82"

Width: 24", 30", 36", 42", 48",

Laminate

Metal Powder Coat Paint: White, Black, Silver, Charcoal

*82"H available up to 36"W

Notes:

Power capable panel with bracket for power module.
Power module must be specified seperately.
Panels are non tackable. For tackable option see Panel Add-On section.
Fabric Upcharge
Grade 2 - \$216 per panel,
Grade 3- \$266 per panel

Code	Price	H	W	D
One 8" frosted glass segment on top				
L-PPFFG-4224-00E-E	1064	42	24	2
L-PPFFG-4230-00E-E	1144	42	30	2
L-PPFFG-4236-00E-E	1225	42	36	2
L-PPFFG-4242-00E-E	1305	42	42	2
L-PPFFG-4248-00E-E	1385	42	48	2
L-PPFFG-4254-00E-E	1468	42	54	2
L-PPFFG-4260-00E-E	1545	42	60	2
L-PPFFG-5024-00E-E	1064	50	24	2
L-PPFFG-5030-00E-E	1144	50	30	2
L-PPFFG-5036-00E-E	1225	50	36	2
L-PPFFG-5042-00E-E	1305	50	42	2
L-PPFFG-5048-00E-E	1385	50	48	2
L-PPFFG-5054-00E-E	1468	50	54	2
L-PPFFG-5060-00E-E	1545	50	60	2
One 16" frosted glass segment on top				
L-PPFFG-5024-00S-E	1064	50	24	2
L-PPFFG-5030-00S-E	1144	50	30	2
L-PPFFG-5036-00S-E	1225	50	36	2
L-PPFFG-5042-00S-E	1305	50	42	2
L-PPFFG-5048-00S-E	1385	50	48	2
L-PPFFG-5054-00S-E	1468	50	54	2
L-PPFFG-5060-00S-E	1545	50	60	2
L-PPFFG-6624-00S-E	1201	66	24	2
L-PPFFG-6630-00S-E	1301	66	30	2
L-PPFFG-6636-00S-E	1404	66	36	2
L-PPFFG-6642-00S-E	1505	66	42	2
L-PPFFG-6648-00S-E	1608	66	48	2
L-PPFFG-6654-00S-E	1709	66	54	2
L-PPFFG-6660-00S-E	1811	66	60	2
L-PPFFG-8224-00S-E	1531	82	24	2
L-PPFFG-8230-00S-E	1801	82	30	2
L-PPFFG-8236-00S-E	1929	82	36	2
L-PPFFG-8242-00S-E	2007	82	42	2
L-PPFFG-8248-00S-E	2131	82	48	2
One 24" frosted glass segment on top				
L-PPFFG-6624-00T-E	1201	66	24	2
L-PPFFG-6630-00T-E	1301	66	30	2
L-PPFFG-6636-00T-E	1404	66	36	2
L-PPFFG-6642-00T-E	1505	66	42	2
L-PPFFG-6648-00T-E	1608	66	48	2
L-PPFFG-6654-00T-E	1709	66	54	2
L-PPFFG-6660-00T-E	1811	66	60	2

Code	Price	H	W	D
Two 8" frosted glass segments on top				
L-PPFFG-6624-0EE-E	1732	66	24	2
L-PPFFG-6630-0EE-E	1959	66	30	2
L-PPFFG-6636-0EE-E	2054	66	36	2
L-PPFFG-6642-0EE-E	2122	66	42	2
L-PPFFG-6648-0EE-E	2213	66	48	2
L-PPFFG-6654-0EE-E	2333	66	54	2
L-PPFFG-6660-0EE-E	2413	66	60	2
One 8" & One 16" frosted glass segment on top				
L-PPFFG-6624-0ES-E	1692	66	24	2
L-PPFFG-6630-0ES-E	1901	66	30	2
L-PPFFG-6636-0ES-E	2019	66	36	2
L-PPFFG-6642-0ES-E	2127	66	42	2
L-PPFFG-6648-0ES-E	2258	66	48	2
L-PPFFG-6654-0ES-E	2404	66	54	2
L-PPFFG-6660-0ES-E	2503	66	60	2
Two 16" frosted glass segments on top				
L-PPFFG-8224-0SS-E	1786	82	24	2
L-PPFFG-8230-0SS-E	2047	82	30	2
L-PPFFG-8236-0SS-E	2209	82	36	2
L-PPFFG-8242-0SS-E	2345	82	42	2
L-PPFFG-8248-0SS-E	2505	82	48	2
One 24" & One 16" frosted glass segment on top				
L-PPFFG-8224-0TS-E	1803	82	24	2
L-PPFFG-8230-0TS-E	2063	82	30	2
L-PPFFG-8236-0TS-E	2232	82	36	2
L-PPFFG-8242-0TS-E	2390	82	42	2
L-PPFFG-8248-0TS-E	2572	82	48	2
Two 24" frosted glass segments on top				
L-PPFFG-8224-0TT-E	1859	82	24	2
L-PPFFG-8230-0TT-E	2132	82	30	2
L-PPFFG-8236-0TT-E	2300	82	36	2
L-PPFFG-8242-0TT-E	2470	82	42	2
L-PPFFG-8248-0TT-E	2664	82	48	2
One 8" & Two 16" frosted glass segments on top				
L-PPFFG-8224-0SS-E	2007	82	24	2
L-PPFFG-8230-0SS-E	2310	82	30	2
L-PPFFG-8236-0SS-E	2480	82	36	2
L-PPFFG-8242-0SS-E	2539	82	42	2
L-PPFFG-8248-0SS-E	2749	82	48	2
Three 16" frosted glass segments on top				
L-PPFFG-8224-0SS-E	2044	82	24	2
L-PPFFG-8230-0SS-E	2280	82	30	2
L-PPFFG-8236-0SS-E	2471	82	36	2
L-PPFFG-8242-0SS-E	2659	82	42	2
L-PPFFG-8248-0SS-E	2868	82	48	2

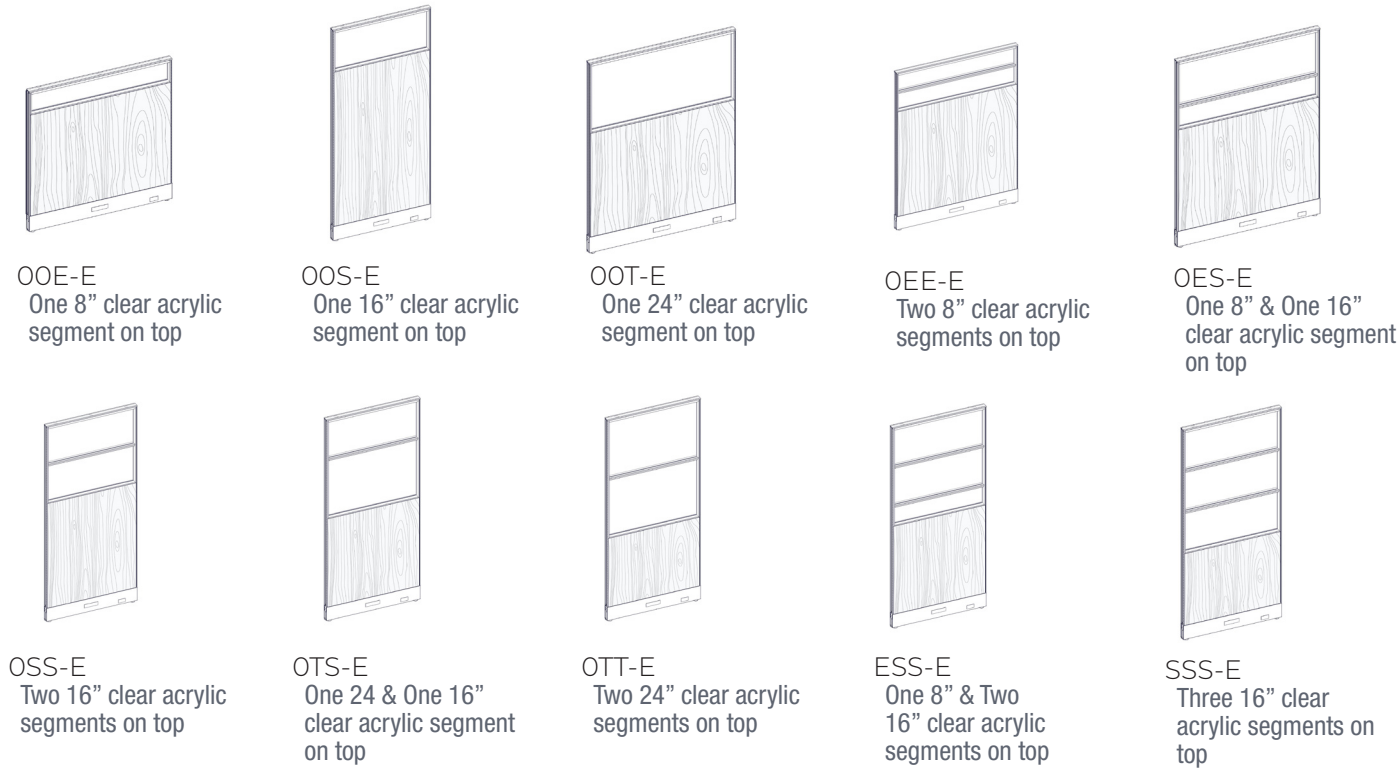

How to order and read your code

L - P P L C A - 42 24 - 00E - E

product standard P=glazed F=Fabric C=Clear A=Acrylic height width 0=No segment N=Non powered
 line line E=Elevated L=Laminate F=Frosted G=Glass E=8 inch segment E=Powered
 S=16 inch segment
 T=24 inch segment

What's Included:

One (1) 2" thick laminate panel with 1" incremented slotted channels,
 Two (2) raceway covers,
 One (1) top trim

How to Specify:

Refer to laminate cards for laminate selections
 Choose White, Black, Silver, Charcoal for Panel Frame colour

Options:

Height*: 34", 42", 50", 66", 82"
 Width: 24", 30", 36", 42", 48",
 Laminate
 Metal Powder Coat Paint: White, Black, Silver, Charcoal

*82"H available up to 36"W

Code	Price	H	W	D
One 8" clear acrylic segment on top				
L-PPLCA-4224-00E-E	1173	42	24	2
L-PPLCA-4230-00E-E	1228	42	30	2
L-PPLCA-4236-00E-E	1280	42	36	2
L-PPLCA-4242-00E-E	1391	42	42	2
L-PPLCA-4248-00E-E	1404	42	48	2
L-PPLCA-5024-00E-E	1210	50	24	2
L-PPLCA-5030-00E-E	1125	50	30	2
L-PPLCA-5036-00E-E	1181	50	36	2
L-PPLCA-5042-00E-E	1334	50	42	2
L-PPLCA-5048-00E-E	1366	50	48	2
One 16" clear acrylic segment on top				
L-PPLCA-5024-00S-E	1111	50	24	2
L-PPLCA-5030-00S-E	1147	50	30	2
L-PPLCA-5036-00S-E	1211	50	36	2
L-PPLCA-5042-00S-E	1347	50	42	2
L-PPLCA-5048-00S-E	1386	50	48	2
L-PPLCA-6624-00S-E	1211	66	24	2
L-PPLCA-6630-00S-E	1247	66	30	2
L-PPLCA-6636-00S-E	1326	66	36	2
L-PPLCA-6642-00S-E	1527	66	42	2
L-PPLCA-6648-00S-E	1568	66	48	2
L-PPLCA-8224-00S-E	1553	82	24	2
L-PPLCA-8230-00S-E	1572	82	30	2
L-PPLCA-8236-00S-E	2091	82	36	2
One 24" clear acrylic segment on top				
L-PPLCA-6624-00T-E	1199	66	24	2
L-PPLCA-6630-00T-E	1246	66	30	2
L-PPLCA-6636-00T-E	1323	66	36	2
L-PPLCA-6642-00T-E	1490	66	42	2
L-PPLCA-6648-00T-E	1537	66	48	2

Code	Price	H	W	D
Two 8" clear acrylic segments on top				
L-PPLCA-6624-0EE-E	1359	66	24	2
L-PPLCA-6630-0EE-E	1375	66	30	2
L-PPLCA-6636-0EE-E	1656	66	36	2
L-PPLCA-6642-0EE-E	1694	66	42	2
L-PPLCA-6648-0EE-E	1749	66	48	2
One 8" & One 16" clear acrylic segment on top				
L-PPLCA-6624-0ES-E	1366	66	24	2
L-PPLCA-6630-0ES-E	1420	66	30	2
L-PPLCA-6636-0ES-E	1724	66	36	2
L-PPLCA-6642-0ES-E	1782	66	42	2
L-PPLCA-6648-0ES-E	1842	66	48	2
Two 16" clear acrylic segments on top				
L-PPLCA-8224-0SS-E	1418	82	24	2
L-PPLCA-8230-0SS-E	1487	82	30	2
L-PPLCA-8236-0SS-E	1826	82	36	2
One 24" & One 16" clear acrylic segment on top				
L-PPLCA-8224-0TS-E	1448	82	24	2
L-PPLCA-8230-0TS-E	1542	82	30	2
L-PPLCA-8236-0TS-E	1834	82	36	2
Two 24" clear acrylic segments on top				
L-PPLCA-8224-0TT-E	1385	82	24	2
L-PPLCA-8230-0TT-E	1469	82	30	2
L-PPLCA-8236-0TT-E	1720	82	36	2
One 8" & Two 16" clear acrylic segments on top				
L-PPLCA-8224-ESS-E	1511	82	24	2
L-PPLCA-8230-ESS-E	1675	82	30	2
L-PPLCA-8236-ESS-E	1980	82	36	2
Three 16" clear acrylic segments on top				
L-PPLCA-8224-SSS-E	1481	82	24	2
L-PPLCA-8230-SSS-E	1571	82	30	2
L-PPLCA-8236-SSS-E	1898	82	36	2

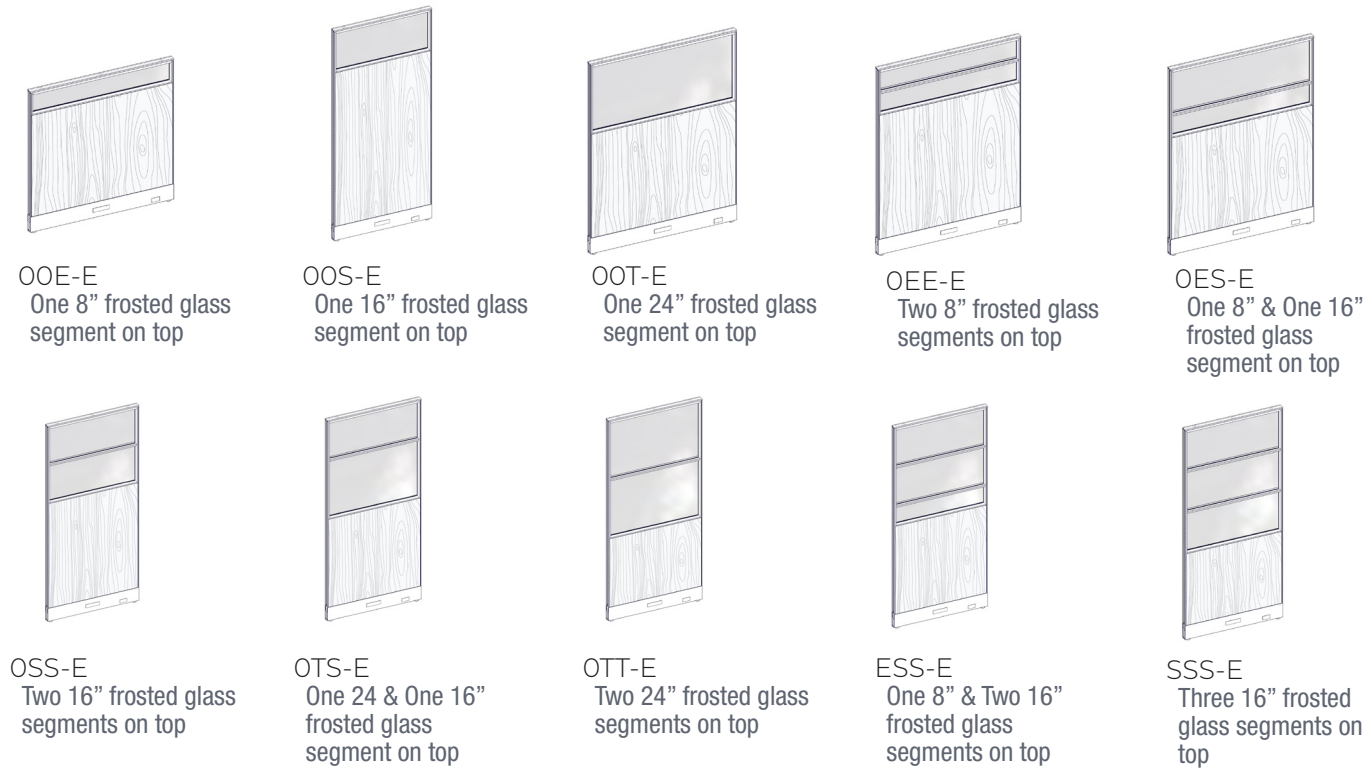

How to order and read your code

L - P P L F A - 42 24 - 00E - E

product standard P=glazed F=Fabric C=Clear A=Acrylic height width 0 = No segment N=Non powered
 line E = Elevated L=Laminate F=Frosted G=Glass E = 8 inch segment E=Powered
 S = 16 inch segment
 T = 24 inch segment

What's Included:

One (1) 2" thick laminate panel with 1" incremented slotted channels,
 Two (2) raceway covers,
 One (1) top trim

How to Specify:

Refer to laminate cards for laminate selections
 Choose White, Black, Silver, Charcoal for Panel Frame colour

Options:

Height*: 34", 42", 50", 66", 82"

Width: 24", 30", 36", 42", 48",

Laminate

Metal Powder Coat Paint: White, Black, Silver, Charcoal

*82"H available up to 36"W

Code	Price	H	W	D
One 8" frosted acrylic segment on top				
L-PPLFA-4224-00E-E	1160	42	24	2
L-PPLFA-4230-00E-E	1191	42	30	2
L-PPLFA-4236-00E-E	1242	42	36	2
L-PPLFA-4242-00E-E	1373	42	42	2
L-PPLFA-4248-00E-E	1404	42	48	2
L-PPLFA-5024-00E-E	1197	50	24	2
L-PPLFA-5030-00E-E	1228	50	30	2
L-PPLFA-5036-00E-E	1283	50	36	2
L-PPLFA-5042-00E-E	1436	50	42	2
L-PPLFA-5048-00E-E	1468	50	48	2
One 16" frosted acrylic segment on top				
L-PPLFA-5024-00S-E	1213	50	24	2
L-PPLFA-5030-00S-E	1249	50	30	2
L-PPLFA-5036-00S-E	1313	50	36	2
L-PPLFA-5042-00S-E	1449	50	42	2
L-PPLFA-5048-00S-E	1490	50	48	2
L-PPLFA-6624-00S-E	1313	66	24	2
L-PPLFA-6630-00S-E	1348	66	30	2
L-PPLFA-6636-00S-E	1429	66	36	2
L-PPLFA-6642-00S-E	1629	66	42	2
L-PPLFA-6648-00S-E	1670	66	48	2
L-PPLFA-8224-00S-E	1589	82	24	2
L-PPLFA-8230-00S-E	1618	82	30	2
L-PPLFA-8236-00S-E	2149	82	36	2
One 24" frosted acrylic segment on top				
L-PPLFA-6624-00T-E	1301	66	24	2
L-PPLFA-6630-00T-E	1347	66	30	2
L-PPLFA-6636-00T-E	1382	66	36	2
L-PPLFA-6642-00T-E	1592	66	42	2
L-PPLFA-6648-00T-E	1640	66	48	2

Code	Price	H	W	D
Two 8" frosted acrylic segments on top				
L-PPLFA-6624-0EE-E	1419	66	24	2
L-PPLFA-6630-0EE-E	1458	66	30	2
L-PPLFA-6636-0EE-E	1765	66	36	2
L-PPLFA-6642-0EE-E	1798	66	42	2
L-PPLFA-6648-0EE-E	1872	66	48	2
One 8" & One 16" frosted acrylic segment on top				
L-PPLFA-6624-0ES-E	1417	66	24	2
L-PPLFA-6630-0ES-E	1490	66	30	2
L-PPLFA-6636-0ES-E	1808	66	36	2
L-PPLFA-6642-0ES-E	1885	66	42	2
L-PPLFA-6648-0ES-E	1945	66	48	2
Two 16" frosted acrylic segments on top				
L-PPLFA-8224-0SS-E	1320	82	24	2
L-PPLFA-8230-0SS-E	1348	82	30	2
L-PPLFA-8236-0SS-E	1641	82	36	2
One 24" & One 16" frosted acrylic segment on top				
L-PPLFA-8224-0TS-E	1552	82	24	2
L-PPLFA-8230-0TS-E	1679	82	30	2
L-PPLFA-8236-0TS-E	1972	82	36	2
Two 24" frosted acrylic segments on top				
L-PPLFA-8224-0TT-E	1490	82	24	2
L-PPLFA-8230-0TT-E	1606	82	30	2
L-PPLFA-8236-0TT-E	1885	82	36	2
One 8" & Two 16" frosted acrylic segments on top				
L-PPLFA-8224-ESS-E	1616	82	24	2
L-PPLFA-8230-ESS-E	1812	82	30	2
L-PPLFA-8236-ESS-E	2116	82	36	2
Three 16" frosted acrylic segments on top				
L-PPLFA-8224-SSS-E	1584	82	24	2
L-PPLFA-8230-SSS-E	1708	82	30	2
L-PPLFA-8236-SSS-E	2105	82	36	2

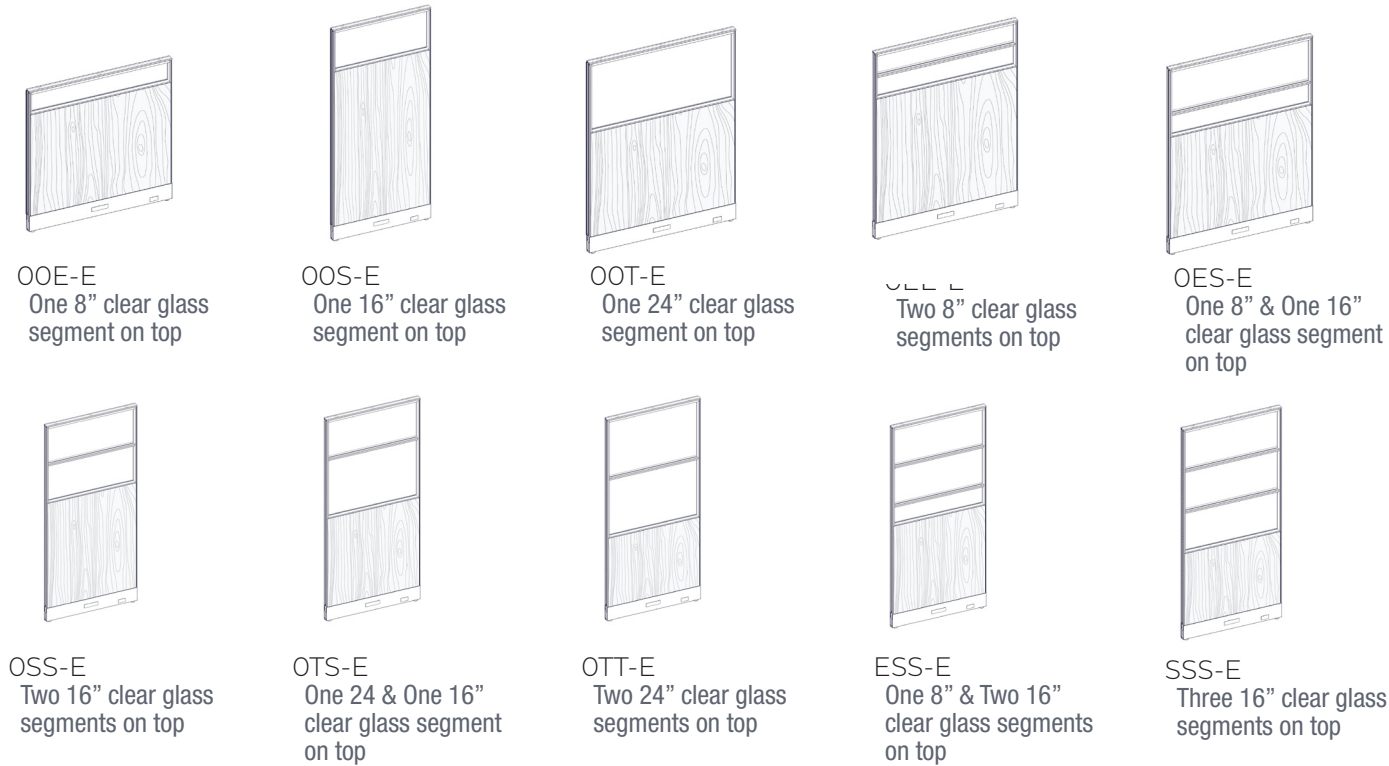

How to order and read your code

L - P P L C G - 42 24 - 00E - E

product standard P= glazed F=Fabric C=Clear A=Acrylic height width 0= No segment N=Non powered
 line line E = Elevated L=Laminate F=Frosted G=Glass E = 8 inch segment E=Powered
 S = 16 inch segment
 T = 24 inch segment

What's Included:

One (1) 2" thick laminate panel with 1" incremented slotted channels,
 Two (2) raceway covers,
 One (1) top trim

How to Specify:

Refer to laminate cards for laminate selections
 Choose White, Black, Silver, Charcoal for Panel Frame colour

Options:

Height*: 34", 42", 50", 66", 82"

Width: 24", 30", 36", 42", 48",

Laminate

Metal Powder Coat Paint: White, Black, Silver, Charcoal

*82"H available up to 36"W

Code	Price	H	W	D
One 8" clear glass segment on top				
L-PPLCG-4224-00E-E	1700	42	24	2
L-PPLCG-4230-00E-E	1335	42	30	2
L-PPLCG-4236-00E-E	1396	42	36	2
L-PPLCG-4242-00E-E	1466	42	42	2
L-PPLCG-4248-00E-E	1536	42	48	2
L-PPLCG-5024-00E-E	1180	50	24	2
L-PPLCG-5030-00E-E	1225	50	30	2
L-PPLCG-5036-00E-E	1299	50	36	2
L-PPLCG-5042-00E-E	1468	50	42	2
L-PPLCG-5048-00E-E	1515	50	48	2
One 16" clear glass segment on top				
L-PPLCG-5024-00S-E	1247	50	24	2
L-PPLCG-5030-00S-E	1313	50	30	2
L-PPLCG-5036-00S-E	1404	50	36	2
L-PPLCG-5042-00S-E	1572	50	42	2
L-PPLCG-5048-00S-E	1638	50	48	2
L-PPLCG-6624-00S-E	1345	66	24	2
L-PPLCG-6630-00S-E	1412	66	30	2
L-PPLCG-6636-00S-E	1519	66	36	2
L-PPLCG-6642-00S-E	1745	66	42	2
L-PPLCG-6648-00S-E	1815	66	48	2
L-PPLCG-8224-00S-E	1513	82	24	2
L-PPLCG-8230-00S-E	1555	82	30	2
L-PPLCG-8236-00S-E	2095	82	36	2
One 24" clear glass segment on top				
L-PPLCG-6624-00T-E	1388	66	24	2
L-PPLCG-6630-00T-E	1473	66	30	2
L-PPLCG-6636-00T-E	1589	66	36	2
L-PPLCG-6642-00T-E	1797	66	42	2
L-PPLCG-6648-00T-E	1885	66	48	2

Code	Price	H	W	D
Two 8" clear glass segments on top				
L-PPLCG-6624-0EE-E	1453	66	24	2
L-PPLCG-6630-0EE-E	1505	66	30	2
L-PPLCG-6636-0EE-E	1812	66	36	2
L-PPLCG-6642-0EE-E	1859	66	42	2
L-PPLCG-6648-0EE-E	1932	66	48	2
One 8" & One 16" clear glass segment on top				
L-PPLCG-6624-0ES-E	1453	66	24	2
L-PPLCG-6630-0ES-E	1524	66	30	2
L-PPLCG-6636-0ES-E	1846	66	36	2
L-PPLCG-6642-0ES-E	1908	66	42	2
L-PPLCG-6648-0ES-E	1995	66	48	2
Two 16" clear glass segments on top				
L-PPLCG-8224-0SS-E	1508	82	24	2
L-PPLCG-8230-0SS-E	1574	82	30	2
L-PPLCG-8236-0SS-E	1911	82	36	2
One 24" & One 16" clear glass segment on top				
L-PPLCG-8224-0TS-E	1537	82	24	2
L-PPLCG-8230-0TS-E	1630	82	30	2
L-PPLCG-8236-0TS-E	1973	82	36	2
Two 24" clear glass segments on top				
L-PPLCG-8224-0TT-E	1508	82	24	2
L-PPLCG-8230-0TT-E	1605	82	30	2
L-PPLCG-8236-0TT-E	1878	82	36	2
One 8" & Two 16" clear glass segments on top				
L-PPLCG-8224-ESS-E	1686	82	24	2
L-PPLCG-8230-ESS-E	1842	82	30	2
L-PPLCG-8236-ESS-E	2196	82	36	2
Three 16" clear glass segments on top				
L-PPLCG-8224-SSS-E	1664	82	24	2
L-PPLCG-8230-SSS-E	1753	82	30	2
L-PPLCG-8236-SSS-E	2049	82	36	2

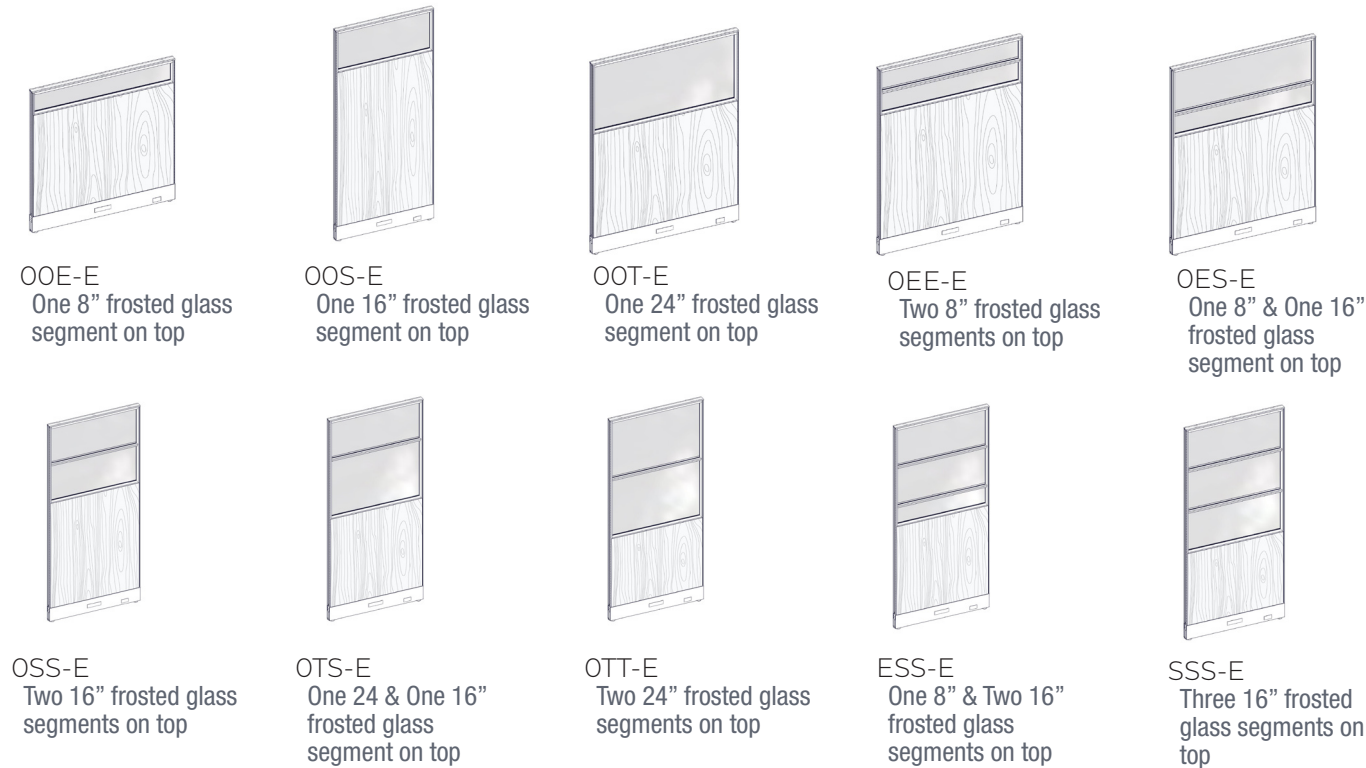

How to order and read your code

L - P P L F G - 42 24 - 00E - E

product standard P=glazed F=Fabric C=Clear A=Acrylic height width 0=No segment N=Non powered
 line line E=Elevated L=Laminate F=Frosted G=Glass E=8 inch segment E=Powered
 S=16 inch segment
 T=24 inch segment

What's Included:

One (1) 2" thick laminate panel with 1" incremented slotted channels,
 Two (2) raceway covers,
 One (1) top trim

How to Specify:

Refer to laminate cards for laminate selections
 Choose White, Black, Silver, Charcoal for Panel Frame colour

Options:

Height*: 34", 42", 50", 66", 82"
 Width: 24", 30", 36", 42", 48",
 Laminate
 Metal Powder Coat Paint: White, Black, Silver, Charcoal

*82"H available up to 36"W

Code	Price	H	W	D
One 8" frosted glass segment on top				
L-PPLFG-4224-00E-E	1594	42	24	2
L-PPLFG-4230-00E-E	1291	42	30	2
L-PPLFG-4236-00E-E	1361	42	36	2
L-PPLFG-4242-00E-E	1509	42	42	2
L-PPLFG-4248-00E-E	1555	42	48	2
L-PPLFG-5024-00E-E	1282	50	24	2
L-PPLFG-5030-00E-E	1326	50	30	2
L-PPLFG-5036-00E-E	1401	50	36	2
L-PPLFG-5042-00E-E	1570	50	42	2
L-PPLFG-5048-00E-E	1617	50	48	2
One 16" frosted glass segment on top				
L-PPLFG-5024-00S-E	1348	50	24	2
L-PPLFG-5030-00S-E	1416	50	30	2
L-PPLFG-5036-00S-E	1506	50	36	2
L-PPLFG-5042-00S-E	1674	50	42	2
L-PPLFG-5048-00S-E	1741	50	48	2
L-PPLFG-6624-00S-E	1447	66	24	2
L-PPLFG-6630-00S-E	1515	66	30	2
L-PPLFG-6636-00S-E	1620	66	36	2
L-PPLFG-6642-00S-E	1847	66	42	2
L-PPLFG-6648-00S-E	1917	66	48	2
L-PPLFG-8224-00S-E	1597	82	24	2
L-PPLFG-8230-00S-E	1649	82	30	2
L-PPLFG-8236-00S-E	2205	82	36	2
One 24" frosted glass segment on top				
L-PPLFG-6624-00T-E	1491	66	24	2
L-PPLFG-6630-00T-E	1575	66	30	2
L-PPLFG-6636-00T-E	1691	66	36	2
L-PPLFG-6642-00T-E	1899	66	42	2
L-PPLFG-6648-00T-E	1989	66	48	2
Two 8" frosted glass segments on top				
L-PPLFG-6624-0EE-E	1621	66	24	2
L-PPLFG-6630-0EE-E	1673	66	30	2
L-PPLFG-6636-0EE-E	1980	66	36	2
L-PPLFG-6642-0EE-E	2028	66	42	2
L-PPLFG-6648-0EE-E	2097	66	48	2
One 8" & One 16" frosted glass segment on top				
L-PPLFG-6624-0ES-E	1621	66	24	2
L-PPLFG-6630-0ES-E	1698	66	30	2
L-PPLFG-6636-0ES-E	2041	66	36	2
L-PPLFG-6642-0ES-E	2122	66	42	2
L-PPLFG-6648-0ES-E	2229	66	48	2
Two 16" frosted glass segments on top				
L-PPLFG-8224-0SS-E	1675	82	24	2
L-PPLFG-8230-0SS-E	1758	82	30	2
L-PPLFG-8236-0SS-E	2134	82	36	2
One 24" & One 16" frosted glass segment on top				
L-PPLFG-8224-0TS-E	1732	82	24	2
L-PPLFG-8230-0TS-E	1860	82	30	2
L-PPLFG-8236-0TS-E	2254	82	36	2
Two 24" frosted glass segments on top				
L-PPLFG-8224-0TT-E	1731	82	24	2
L-PPLFG-8230-0TT-E	1882	82	30	2
L-PPLFG-8236-0TT-E	2210	82	36	2
One 8" & Two 16" frosted glass segments on top				
L-PPLFG-8224-ESS-E	1938	82	24	2
L-PPLFG-8230-ESS-E	2109	82	30	2
L-PPLFG-8236-ESS-E	2503	82	36	2
Three 16" frosted glass segments on top				
L-PPLFG-8224-SSS-E	1914	82	24	2
L-PPLFG-8230-SSS-E	2031	82	30	2
L-PPLFG-8236-SSS-E	2383	82	36	2

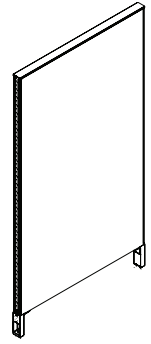

Elevated Non-Powered Fabric Panel

What's Included:

One (1) 2" thick fabric panel with 1" incremented slotted channels, One (1) top trim

How to Specify:

Refer to panel fabric cards for fabric selections

Choose White, Black, Silver, Charcoal for Panel Frame colour

Notes:

Non-power capable panel.

Can be used in run with power-capable panels and allows wires to pass through.

Panels are non tackable. For tackable option see Panel Add-On section.

Fabric Upcharge
Grade 2 - \$216 per panel,
Grade 3- \$266 per panel

Options:

Height*: 34", 42", 50", 66", 82"

Width: 24", 30", 36", 42", 48", 54", 60", 66", 72"

Fabric

Metal Powder Coat Paint: White, Black, Silver, Charcoal

*34" high - 50" high available up to 72" wide, 66" high available up to 60" wide, 82" high available up to 48" wide

Code	Price	H	W	D	Weight (lb.)	Volume (ft ³)
L-PEF0-3424	401	34	24	2	14.8	0.94
L-PEF0-3430	433	34	30	2	18.5	1.18
L-PEF0-3436	465	34	36	2	22.3	1.42
L-PEF0-3442	497	34	42	2	26.0	1.65
L-PEF0-3448	527	34	48	2	29.7	1.89
L-PEF0-3454	559	34	54	2	33.4	2.13
L-PEF0-3460	590	34	60	2	37.1	2.36
L-PEF0-4224	401	42	24	2	18.3	1.17
L-PEF0-4230	433	42	30	2	22.9	1.46
L-PEF0-4236	465	42	36	2	27.5	1.75
L-PEF0-4242	497	42	42	2	32.1	2.04
L-PEF0-4248	527	42	48	2	36.7	2.33
L-PEF0-4254	559	42	54	2	41.2	2.63
L-PEF0-4260	590	42	60	2	45.8	2.92
L-PEF0-5024	433	50	24	2	21.8	1.39
L-PEF0-5030	480	50	30	2	27.3	1.74
L-PEF0-5036	527	50	36	2	32.7	2.08
L-PEF0-5042	575	50	42	2	38.2	2.43
L-PEF0-5048	623	50	48	2	43.6	2.78
L-PEF0-5054	671	50	54	2	49.1	3.13
L-PEF0-5060	715	50	60	2	54.5	3.47
L-PEF0-6624	497	66	24	2	28.8	1.83
L-PEF0-6630	552	66	30	2	36.0	2.29
L-PEF0-6636	600	66	36	2	43.2	2.75
L-PEF0-6642	647	66	42	2	50.4	3.21
L-PEF0-6648	694	66	48	2	57.6	3.67
L-PEF0-6654	757	66	54	2	64.8	4.13
L-PEF0-6660	819	66	60	2	72.0	4.58
L-PEF0-8224	941	82	24	2		
L-PEF0-8230	1009	82	30	2		
L-PEF0-8236	1222	82	36	2		
L-PEF0-8242	1286	82	42	2		
L-PEF0-8248	1352	82	48	2		

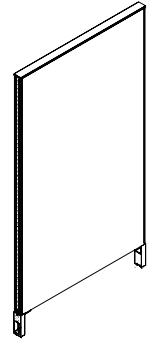

Elevated Monolithic
Non-powered
Laminate Panel

What's Included:

One (1) 2" thick laminate panel with
1" incremented slotted channels,
One (1) top trim

How to Specify:

Refer to laminate cards for laminate selections
Choose White, Black, Silver, Charcoal for Panel
Frame colour

Notes:

Non-power capable panel.
Can be used in run with power-capable
panels and allows wires to pass through.
Panels are non tackable. For tackable
option see Panel Add-On section.

Options:

Height*: 34", 42", 50", 66", 82"

Width: 24", 30", 36", 42", 48",

Laminate

Metal Powder Coat Paint: White, Black, Silver, Charcoal

*82"H available up to 36"W

Code	Price	H	W	D	Weight (lb.)	Volume (ft ³)
L-PELO-3424	507	34	24	2	14.8	0.94
L-PELO-3430	553	34	30	2	18.5	1.18
L-PELO-3436	631	34	36	2	22.3	1.42
L-PELO-3442	678	34	42	2	26.0	1.65
L-PELO-3448	744	34	48	2	29.7	1.89
L-PELO-4224	553	42	24	2	18.3	1.17
L-PELO-4230	602	42	30	2	22.9	1.46
L-PELO-4236	678	42	36	2	27.5	1.75
L-PELO-4242	726	42	42	2	32.1	2.04
L-PELO-4248	789	42	48	2	36.7	2.33
L-PELO-5024	602	50	24	2	21.8	1.39
L-PELO-5030	649	50	30	2	27.3	1.74
L-PELO-5036	744	50	36	2	32.7	2.08
L-PELO-5042	789	50	42	2	38.2	2.43
L-PELO-5048	854	50	48	2	43.6	2.78
L-PELO-6624	744	66	24	2	28.8	1.83
L-PELO-6630	789	66	30	2	36.0	2.29
L-PELO-6636	932	66	36	2	43.2	2.75
L-PELO-6642	981	66	42	2	50.4	3.21
L-PELO-6648	1042	66	48	2	57.6	3.67
L-PELO-8224	1000	82	24	2		
L-PELO-8230	1006	82	30	2		
L-PELO-8236	1336	82	36	2		

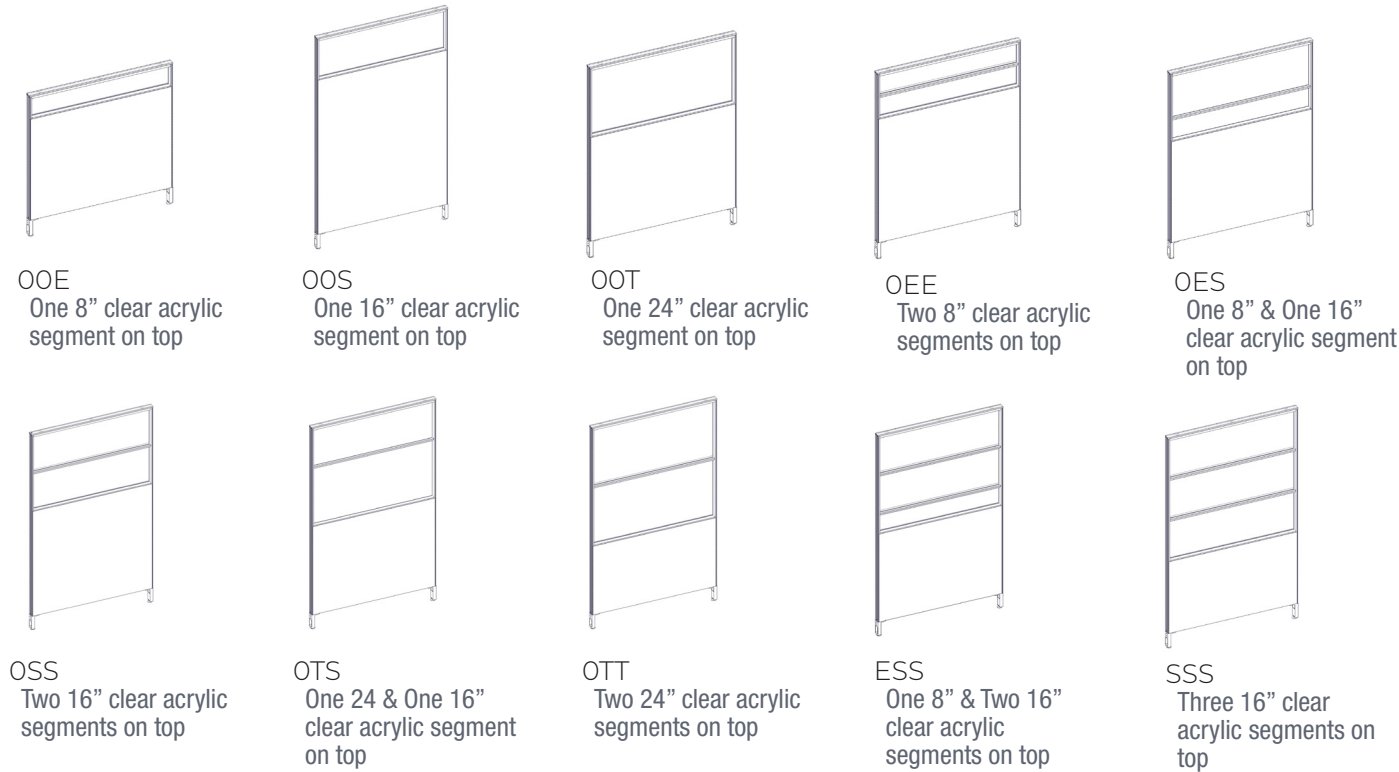

How to order and read your code

L - P E F C A - 42 24 - 0 0 E

product standard line P=glazed E=Elevated F=Fabric L=Laminate C=Clear F=Frosted A=Acrylic height G=Glass width 0 = No segment E = 8 inch segment S = 16 inch segment T = 24 inch segment

What's Included:

One (1) 2" thick fabric panel with glazed glass top and laminate bottom, also with 1" incremented slotted channels, One (1) top trim

How to Specify:

Refer to panel fabric cards for fabric selections
Choose White, Black, Silver, Charcoal for Panel Frame colour

Options:

Height*	34", 42", 50", 66", 82"
Width:	24", 30", 36", 42", 48", 54", 60", 66", 72"
Fabric	
Glass/Acrylic	
Metal Powder Coat Paint:	White, Black, Silver, Charcoal

*34" high - 50" high available up to 72" wide, 66" high available up to 60" wide, 82" high available up to 48" wide

Code	Price	H	W	D
One 8" clear acrylic segment on top				
L-PEFCA-4224-00E	780	42	24	2
L-PEFCA-4230-00E	860	42	30	2
L-PEFCA-4236-00E	941	42	36	2
L-PEFCA-4242-00E	1021	42	42	2
L-PEFCA-4248-00E	1103	42	48	2
L-PEFCA-4254-00E	1181	42	54	2
L-PEFCA-4260-00E	1261	42	60	2
L-PEFCA-5024-00E	780	50	24	2
L-PEFCA-5030-00E	860	50	30	2
L-PEFCA-5036-00E	941	50	36	2
L-PEFCA-5042-00E	1021	50	42	2
L-PEFCA-5048-00E	1103	50	48	2
L-PEFCA-5054-00E	1181	50	54	2
L-PEFCA-5060-00E	1261	50	60	2
One 16" clear acrylic segment on top				
L-PEFCA-5024-00S	780	50	24	2
L-PEFCA-5030-00S	860	50	30	2
L-PEFCA-5036-00S	941	50	36	2
L-PEFCA-5042-00S	1021	50	42	2
L-PEFCA-5048-00S	1103	50	48	2
L-PEFCA-5054-00S	1181	50	54	2
L-PEFCA-5060-00S	1261	50	60	2
L-PEFCA-6624-00S	907	66	24	2
L-PEFCA-6630-00S	1009	66	30	2
L-PEFCA-6636-00S	1109	66	36	2
L-PEFCA-6642-00S	1210	66	42	2
L-PEFCA-6648-00S	1312	66	48	2
L-PEFCA-6654-00S	1412	66	54	2
L-PEFCA-6660-00S	1513	66	60	2
L-PEFCA-8224-00S	1469	82	24	2
L-PEFCA-8230-00S	1694	82	30	2
L-PEFCA-8236-00S	1774	82	36	2
L-PEFCA-8242-00S	1806	82	42	2
L-PEFCA-8248-00S	1880	82	48	2
One 24" clear acrylic segment on top				
L-PEFCA-6624-00T	907	66	24	2
L-PEFCA-6630-00T	1009	66	30	2
L-PEFCA-6636-00T	1109	66	36	2
L-PEFCA-6642-00T	1210	66	42	2
L-PEFCA-6648-00T	1312	66	48	2
L-PEFCA-6654-00T	1412	66	54	2
L-PEFCA-6660-00T	1513	66	60	2

Code	Price	H	W	D
Two 8" clear acrylic segments on top				
L-PEFCA-6624-0EE	1448	66	24	2
L-PEFCA-6630-0EE	1633	66	30	2
L-PEFCA-6636-0EE	1692	66	36	2
L-PEFCA-6642-0EE	1741	66	42	2
L-PEFCA-6648-0EE	1806	66	48	2
L-PEFCA-6654-0EE	1914	66	54	2
L-PEFCA-6660-0EE	1958	66	60	2
One 8" & One 16" clear acrylic segment on top				
L-PEFCA-6624-0ES	1416	66	24	2
L-PEFCA-6630-0ES	1592	66	30	2
L-PEFCA-6636-0ES	1664	66	36	2
L-PEFCA-6642-0ES	1736	66	42	2
L-PEFCA-6648-0ES	1812	66	48	2
L-PEFCA-6654-0ES	1891	66	54	2
L-PEFCA-6660-0ES	1924	66	60	2
Two 16" clear acrylic segments on top				
L-PEFCA-8224-0SS	1508	82	24	2
L-PEFCA-8230-0SS	1745	82	30	2
L-PEFCA-8236-0SS	1860	82	36	2
L-PEFCA-8242-0SS	1907	82	42	2
L-PEFCA-8248-0SS	1973	82	48	2
One 24" & One 16" clear acrylic segment on top				
L-PEFCA-8224-0TS	1499	82	24	2
L-PEFCA-8230-0TS	1714	82	30	2
L-PEFCA-8236-0TS	1774	82	36	2
L-PEFCA-8242-0TS	1819	82	42	2
L-PEFCA-8248-0TS	1995	82	48	2
Two 24" clear acrylic segments on top				
L-PEFCA-8224-0TT	1497	82	24	2
L-PEFCA-8230-0TT	1687	82	30	2
L-PEFCA-8236-0TT	1770	82	36	2
L-PEFCA-8242-0TT	1877	82	42	2
L-PEFCA-8248-0TT	1942	82	48	2
One 8" & Two 16" clear acrylic segments on top				
L-PEFCA-8224-ESS	1563	82	24	2
L-PEFCA-8230-ESS	1846	82	30	2
L-PEFCA-8236-ESS	1917	82	36	2
L-PEFCA-8242-ESS	1910	82	42	2
L-PEFCA-8248-ESS	2086	82	48	2
Three 16" clear acrylic segments on top				
L-PEFCA-8224-SSS	1589	82	24	2
L-PEFCA-8230-SSS	1789	82	30	2
L-PEFCA-8236-SSS	1947	82	36	2
L-PEFCA-8242-SSS	2002	82	42	2
L-PEFCA-8248-SSS	2080	82	48	2

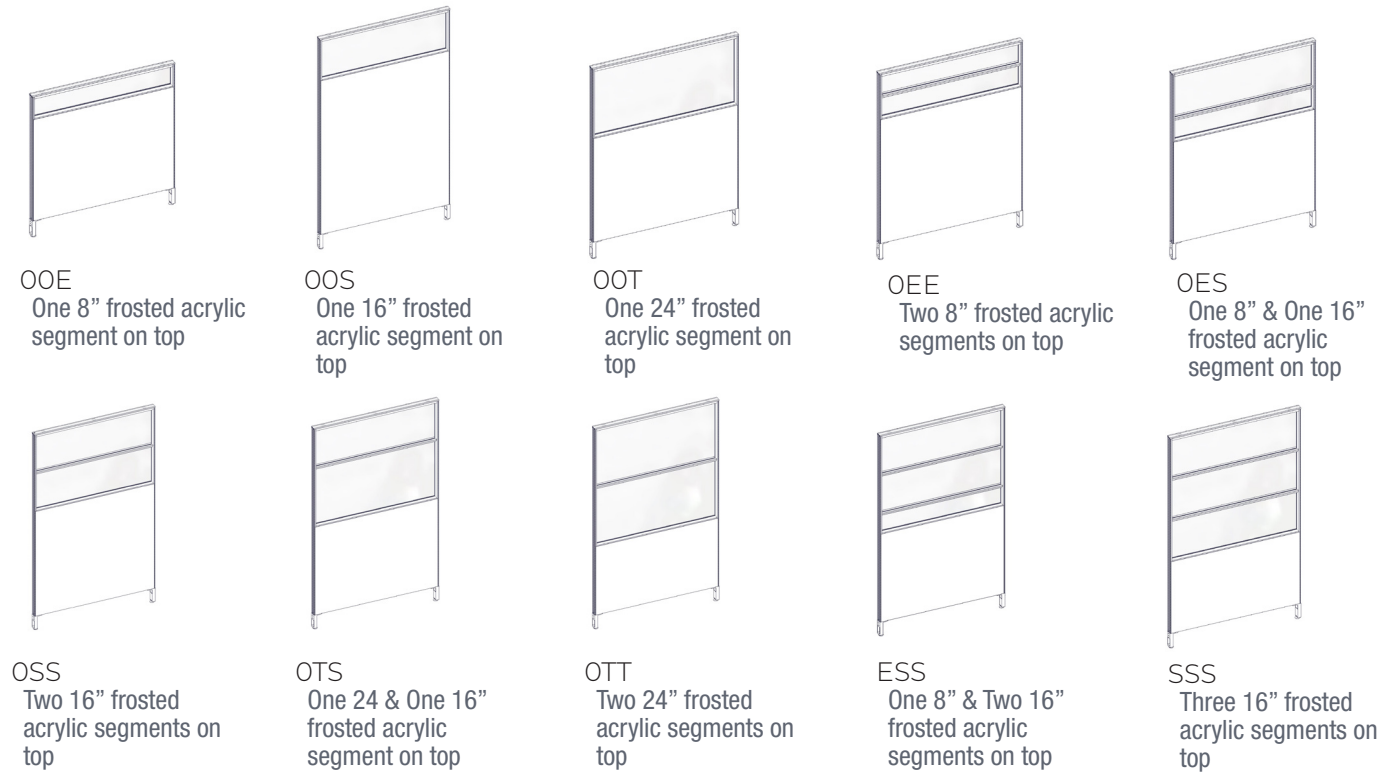

How to order and read your code

L - P E F F A - 42 24 - 00 E

product standard line P=glazed E=Elevated F=Fabric L=Laminate C=Clear F=Frosted A=Acrylic height G=Glass width 0 = No segment E = 8 inch segment S = 16 inch segment T = 24 inch segment

What's Included:

One (1) 2" thick fabric panel with glazed glass top and laminate bottom, also with 1" incremented slotted channels, One (1) top trim

How to Specify:

Refer to panel fabric cards for fabric selections
Choose White, Black, Silver, Charcoal for Panel Frame colour

Options:

Height*	34", 42", 50", 66", 82"
Width:	24", 30", 36", 42", 48", 54", 60", 66" 72"
Fabric	
Glass/Acrylic	
Metal Powder Coat Paint:	White, Black, Silver, Charcoal

*34" high - 50" high available up to 72" wide, 66" high available up to 60" wide, 82" high available up to 48" wide

Code	Price	H	W	D
One 8" frosted acrylic segment on top				
L-PEFFA-4224-00E	882	42	24	2
L-PEFFA-4230-00E	962	42	30	2
L-PEFFA-4236-00E	1043	42	36	2
L-PEFFA-4242-00E	1123	42	42	2
L-PEFFA-4248-00E	1205	42	48	2
L-PEFFA-4254-00E	1283	42	54	2
L-PEFFA-4260-00E	1363	42	60	2
L-PEFFA-5024-00E	882	50	24	2
L-PEFFA-5030-00E	962	50	30	2
L-PEFFA-5036-00E	1043	50	36	2
L-PEFFA-5042-00E	1123	50	42	2
L-PEFFA-5048-00E	1205	50	48	2
L-PEFFA-5054-00E	1283	50	54	2
L-PEFFA-5060-00E	1363	50	60	2
One 16" frosted acrylic segment on top				
L-PEFFA-5024-00S	882	50	24	2
L-PEFFA-5030-00S	962	50	30	2
L-PEFFA-5036-00S	1043	50	36	2
L-PEFFA-5042-00S	1123	50	42	2
L-PEFFA-5048-00S	1205	50	48	2
L-PEFFA-5054-00S	1283	50	54	2
L-PEFFA-5060-00S	1363	50	60	2
One 24" frosted acrylic segment on top				
L-PEFFA-6624-00S	1009	66	24	2
L-PEFFA-6630-00S	1111	66	30	2
L-PEFFA-6636-00S	1211	66	36	2
L-PEFFA-6642-00S	1312	66	42	2
L-PEFFA-6648-00S	1415	66	48	2
L-PEFFA-6654-00S	1515	66	54	2
L-PEFFA-6660-00S	1616	66	60	2
One 8" & Two 16" frosted acrylic segments on top				
L-PEFFA-8224-00S	1504	82	24	2
L-PEFFA-8230-00S	1741	82	30	2
L-PEFFA-8236-00S	1831	82	36	2
L-PEFFA-8242-00S	1877	82	42	2
L-PEFFA-8248-00S	1948	82	48	2
One 24" frosted acrylic segment on top				
L-PEFFA-6624-00T	1009	66	24	2
L-PEFFA-6630-00T	1111	66	30	2
L-PEFFA-6636-00T	1211	66	36	2
L-PEFFA-6642-00T	1312	66	42	2
L-PEFFA-6648-00T	1415	66	48	2
L-PEFFA-6654-00T	1515	66	54	2
L-PEFFA-6660-00T	1616	66	60	2

Code	Price	H	W	D
Two 8" frosted acrylic segments on top				
L-PEFFA-6624-0EE	1510	66	24	2
L-PEFFA-6630-0EE	1715	66	30	2
L-PEFFA-6636-0EE	1799	66	36	2
L-PEFFA-6642-0EE	1845	66	42	2
L-PEFFA-6648-0EE	1929	66	48	2
L-PEFFA-6654-0EE	2002	66	54	2
L-PEFFA-6660-0EE	2044	66	60	2
One 8" & One 16" frosted acrylic segment on top				
L-PEFFA-6624-0ES	1468	66	24	2
L-PEFFA-6630-0ES	1661	66	30	2
L-PEFFA-6636-0ES	1746	66	36	2
L-PEFFA-6642-0ES	1840	66	42	2
L-PEFFA-6648-0ES	1917	66	48	2
L-PEFFA-6654-0ES	2005	66	54	2
L-PEFFA-6660-0ES	2058	66	60	2
Two 16" frosted acrylic segments on top				
L-PEFFA-8224-0SS	1411	82	24	2
L-PEFFA-8230-0SS	1607	82	30	2
L-PEFFA-8236-0SS	1677	82	36	2
L-PEFFA-8242-0SS	1729	82	48	2
L-PEFFA-8248-0SS	1786	82	48	2
One 24" & One 16" frosted acrylic segment on top				
L-PEFFA-8224-0TS	1604	82	24	2
L-PEFFA-8230-0TS	1849	82	30	2
L-PEFFA-8236-0TS	1910	82	36	2
L-PEFFA-8242-0TS	1991	82	42	2
L-PEFFA-8248-0TS	2202	82	48	2
Two 24" frosted acrylic segments on top				
L-PEFFA-8224-0TT	1599	82	24	2
L-PEFFA-8230-0TT	1826	82	30	2
L-PEFFA-8236-0TT	1934	82	36	2
L-PEFFA-8242-0TT	2082	82	42	2
L-PEFFA-8248-0TT	2149	82	48	2
One 8" & Two 16" frosted acrylic segments on top				
L-PEFFA-8224-ESS	1667	82	24	2
L-PEFFA-8230-ESS	1984	82	30	2
L-PEFFA-8236-ESS	2054	82	36	2
L-PEFFA-8242-ESS	2109	82	42	2
L-PEFFA-8248-ESS	2221	82	48	2
Three 16" frosted acrylic segments on top				
L-PEFFA-8224-SSS	1692	82	24	2
L-PEFFA-8230-SSS	1927	82	30	2
L-PEFFA-8236-SSS	2154	82	36	2
L-PEFFA-8242-SSS	2207	82	36	2
L-PEFFA-8248-SSS	2286	82	48	2

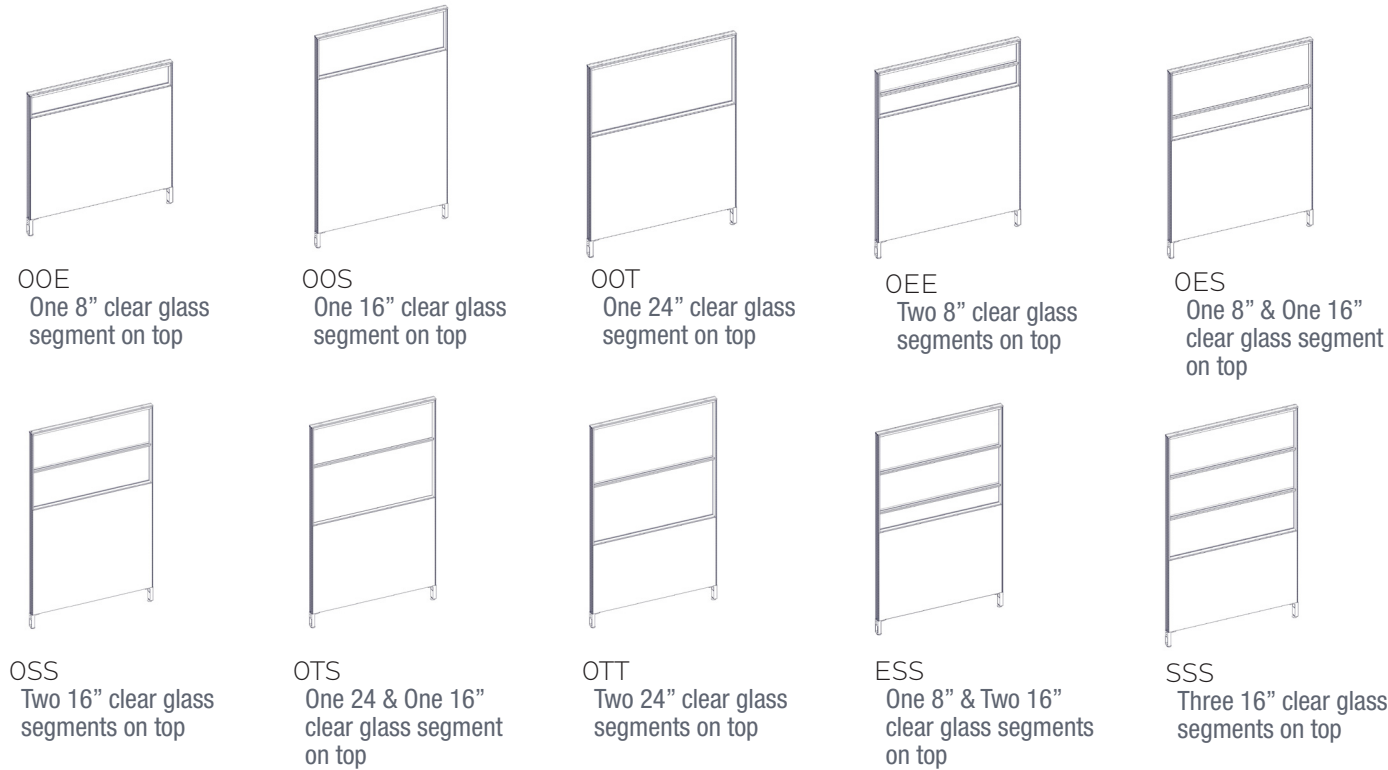

How to order and read your code

L - P E F C G - 42 24 - 0 0 E

product standard line P=glazed E=Elevated F=Fabric L=Laminate C=Clear F=Frosted A=Acrylic G=Glass height width 0=No segment E=8 inch segment S=16 inch segment T=24 inch segment

What's Included:

One (1) 2" thick fabric panel with glazed glass top and laminate bottom, also with 1" incremented slotted channels, One (1) top trim

How to Specify:

Refer to panel fabric cards for fabric selections
Choose White, Black, Silver, Charcoal for Panel Frame colour

Options:

Height*:	34", 42", 50", 66", 82"
Width:	24", 30", 36", 42", 48", 54", 60", 66", 72"
Fabric	
Glass/Acrylic	
Metal Powder Coat Paint:	White, Black, Silver, Charcoal

*34" high - 50" high available up to 72" wide, 66" high available up to 60" wide, 82" high available up to 48" wide

Code	Price	H	W	D
One 8" clear glass segment on top				
L-PEFCG-4224-00E	917	42	24	2
L-PEFCG-4230-00E	997	42	30	2
L-PEFCG-4236-00E	1079	42	36	2
L-PEFCG-4242-00E	1158	42	42	2
L-PEFCG-4248-00E	1237	42	48	2
L-PEFCG-4254-00E	1318	42	54	2
L-PEFCG-4260-00E	1397	42	60	2
L-PEFCG-5024-00E	917	50	24	2
L-PEFCG-5030-00E	997	50	30	2
L-PEFCG-5036-00E	1079	50	36	2
L-PEFCG-5042-00E	1158	50	42	2
L-PEFCG-5048-00E	1237	50	48	2
L-PEFCG-5054-00E	1318	50	54	2
L-PEFCG-5060-00E	1397	50	60	2
One 16" clear glass segment on top				
L-PEFCG-5024-00S	917	50	24	2
L-PEFCG-5030-00S	997	50	30	2
L-PEFCG-5036-00S	1079	50	36	2
L-PEFCG-5042-00S	1158	50	42	2
L-PEFCG-5048-00S	1237	50	48	2
L-PEFCG-5054-00S	1318	50	54	2
L-PEFCG-5060-00S	1397	50	60	2
One 24" clear glass segment on top				
L-PEFCG-6624-00T	1054	66	24	2
L-PEFCG-6630-00T	1156	66	30	2
L-PEFCG-6636-00T	1257	66	36	2
L-PEFCG-6642-00T	1360	66	42	2
L-PEFCG-6648-00T	1461	66	48	2
L-PEFCG-6654-00T	1563	66	54	2
L-PEFCG-6660-00T	1662	66	60	2

Code	Price	H	W	D
Two 8" clear glass segments on top				
L-PEFCG-6624-0EE	1544	66	24	2
L-PEFCG-6630-0EE	1760	66	30	2
L-PEFCG-6636-0EE	1847	66	36	2
L-PEFCG-6642-0EE	1906	66	42	2
L-PEFCG-6648-0EE	1989	66	48	2
L-PEFCG-6654-0EE	2096	66	54	2
L-PEFCG-6660-0EE	2151	66	60	2
One 8" & One 16" clear glass segment on top				
L-PEFCG-6624-0ES	1505	66	24	2
L-PEFCG-6630-0ES	1695	66	30	2
L-PEFCG-6636-0ES	1783	66	36	2
L-PEFCG-6642-0ES	1861	66	42	2
L-PEFCG-6648-0ES	1968	66	48	2
L-PEFCG-6654-0ES	2085	66	54	2
L-PEFCG-6660-0ES	2143	66	60	2
Two 16" clear glass segments on top				
L-PEFCG-8224-0SS	1598	82	24	2
L-PEFCG-8230-0SS	1831	82	30	2
L-PEFCG-8236-0SS	1947	82	36	2
L-PEFCG-8242-0SS	2036	82	42	2
L-PEFCG-8248-0SS	2149	82	48	2
One 24" & One 16" clear glass segment on top				
L-PEFCG-8224-0TS	1587	82	24	2
L-PEFCG-8230-0TS	1801	82	30	2
L-PEFCG-8236-0TS	1912	82	36	2
L-PEFCG-8242-0TS	2015	82	42	2
L-PEFCG-8248-0TS	2141	82	48	2
Two 24" clear glass segments on top				
L-PEFCG-8224-0TT	1617	82	24	2
L-PEFCG-8230-0TT	1823	82	30	2
L-PEFCG-8236-0TT	1926	82	36	2
L-PEFCG-8242-0TT	2031	82	42	2
L-PEFCG-8248-0TT	2157	82	48	2
One 8" & Two 16" clear glass segments on top				
L-PEFCG-8224-ESS	1737	82	24	2
L-PEFCG-8230-ESS	2012	82	30	2
L-PEFCG-8236-ESS	2133	82	36	2
L-PEFCG-8242-ESS	2145	82	42	2
L-PEFCG-8248-ESS	2307	82	48	2
Three 16" clear glass segments on top				
L-PEFCG-8224-SSS	1774	82	24	2
L-PEFCG-8230-SSS	1972	82	30	2
L-PEFCG-8236-SSS	2098	82	36	2
L-PEFCG-8242-SSS	2220	82	42	2
L-PEFCG-8248-SSS	2364	82	48	2

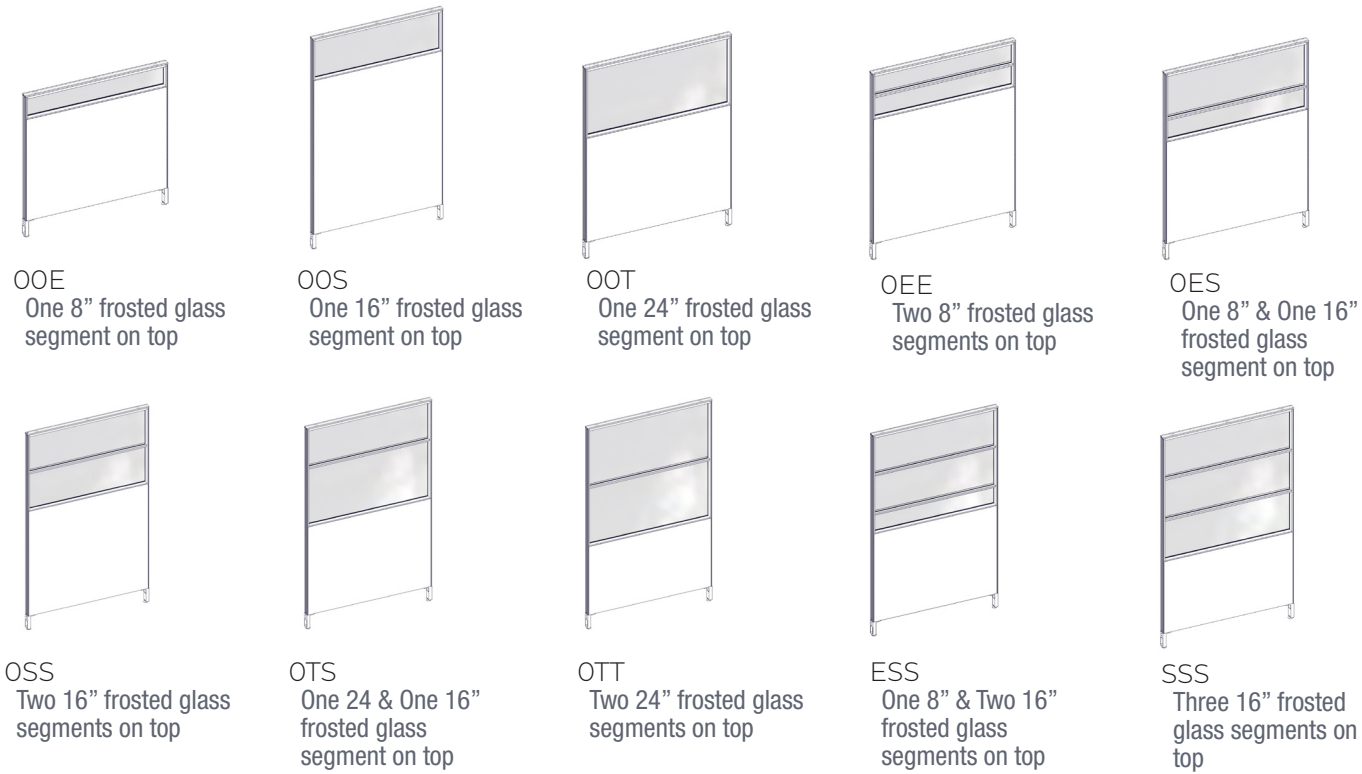

How to order and read your code

L - P E F F G - 42 24 - 0 0 E

product standard line P=glazed E=Elevated F=Fabric L=Laminate C=Clear F=Frosted A=Acrylic height G=Glass width O=No segment E=8 inch segment S=16 inch segment T=24 inch segment

What's Included:

One (1) 2" thick fabric panel with glazed glass top and laminate bottom, also with 1" incremented slotted channels, One (1) top trim

How to Specify:

Refer to panel fabric cards for fabric selections
Choose White, Black, Silver, Charcoal for Panel Frame colour

Options:

Height*	34", 42", 50", 66", 82"
Width:	24", 30", 36", 42", 48", 54", 60", 66", 72"
Fabric	
Glass/Acrylic	
Metal Powder Coat Paint:	White, Black, Silver, Charcoal

*34" high - 50" high available up to 72" wide, 66" high available up to 60" wide, 82" high available up to 48" wide

Code	Price	H	W	D
One 8" frosted glass segment on top				
L-PEFFG-4224-00E	1019	42	24	2
L-PEFFG-4230-00E	1097	42	30	2
L-PEFFG-4236-00E	1180	42	36	2
L-PEFFG-4242-00E	1260	42	42	2
L-PEFFG-4248-00E	1340	42	48	2
L-PEFFG-4254-00E	1420	42	54	2
L-PEFFG-4260-00E	1499	42	60	2
L-PEFFG-5024-00E	1019	50	24	2
L-PEFFG-5030-00E	1097	50	30	2
L-PEFFG-5036-00E	1180	50	36	2
L-PEFFG-5042-00E	1260	50	42	2
L-PEFFG-5048-00E	1340	50	48	2
L-PEFFG-5054-00E	1420	50	54	2
L-PEFFG-5060-00E	1499	50	60	2
One 16" frosted glass segment on top				
L-PEFFG-5024-00S	1019	50	24	2
L-PEFFG-5030-00S	1097	50	30	2
L-PEFFG-5036-00S	1180	50	36	2
L-PEFFG-5042-00S	1260	50	42	2
L-PEFFG-5048-00S	1340	50	48	2
L-PEFFG-5054-00S	1420	50	54	2
L-PEFFG-5060-00S	1499	50	60	2
L-PEFFG-6624-00S	1156	66	24	2
L-PEFFG-6630-00S	1258	66	30	2
L-PEFFG-6636-00S	1359	66	36	2
L-PEFFG-6642-00S	1462	66	42	2
L-PEFFG-6648-00S	1563	66	48	2
L-PEFFG-6654-00S	1664	66	54	2
L-PEFFG-6660-00S	1765	66	60	2
L-PEFFG-8224-00S	1615	82	24	2
L-PEFFG-8230-00S	1874	82	30	2
L-PEFFG-8236-00S	1992	82	36	2
L-PEFFG-8242-00S	2059	82	42	2
L-PEFFG-8248-00S	2175	82	48	2
One 24" frosted glass segment on top				
L-PEFFG-6624-00T	1156	66	24	2
L-PEFFG-6630-00T	1258	66	30	2
L-PEFFG-6636-00T	1359	66	36	2
L-PEFFG-6642-00T	1462	66	42	2
L-PEFFG-6648-00T	1563	66	48	2
L-PEFFG-6654-00T	1664	66	54	2
L-PEFFG-6660-00T	1765	66	60	2

Code	Price	H	W	D
Two 8" frosted glass segments on top				
L-PEFFG-6624-0EE	1712	66	24	2
L-PEFFG-6630-0EE	1929	66	30	2
L-PEFFG-6636-0EE	2014	66	36	2
L-PEFFG-6642-0EE	2073	66	42	2
L-PEFFG-6648-0EE	2155	66	48	2
L-PEFFG-6654-0EE	2264	66	54	2
L-PEFFG-6660-0EE	2335	66	60	2
One 8" & One 16" frosted glass segment on top				
L-PEFFG-6624-0ES	1673	66	24	2
L-PEFFG-6630-0ES	1872	66	30	2
L-PEFFG-6636-0ES	1980	66	36	2
L-PEFFG-6642-0ES	2076	66	42	2
L-PEFFG-6648-0ES	2198	66	48	2
L-PEFFG-6654-0ES	2335	66	54	2
L-PEFFG-6660-0ES	2423	66	60	2
Two 16" frosted glass segments on top				
L-PEFFG-8224-0SS	1766	82	24	2
L-PEFFG-8230-0SS	2016	82	30	2
L-PEFFG-8236-0SS	2170	82	36	2
L-PEFFG-8242-0SS	2297	82	42	2
L-PEFFG-8248-0SS	2445	82	48	2
One 24" & One 16" frosted glass segment on top				
L-PEFFG-8224-0TS	1782	82	24	2
L-PEFFG-8230-0TS	2032	82	30	2
L-PEFFG-8236-0TS	2193	82	36	2
L-PEFFG-8242-0TS	2341	82	42	2
L-PEFFG-8248-0TS	2513	82	48	2
Two 24" frosted glass segments on top				
L-PEFFG-8224-0TT	1840	82	24	2
L-PEFFG-8230-0TT	2102	82	30	2
L-PEFFG-8236-0TT	2259	82	36	2
L-PEFFG-8242-0TT	2422	82	42	2
L-PEFFG-8248-0TT	2604	82	48	2
One 8" & Two 16" frosted glass segments on top				
L-PEFFG-8224-ESS	1989	82	24	2
L-PEFFG-8230-ESS	2281	82	30	2
L-PEFFG-8236-ESS	2442	82	36	2
L-PEFFG-8242-ESS	2491	82	42	2
L-PEFFG-8248-ESS	2688	82	48	2
Three 16" frosted glass segments on top				
L-PEFFG-8224-SSS	2026	82	24	2
L-PEFFG-8230-SSS	2252	82	30	2
L-PEFFG-8236-SSS	2433	82	36	2
L-PEFFG-8242-SSS	2612	82	42	2
L-PEFFG-8248-SSS	2809	82	48	2

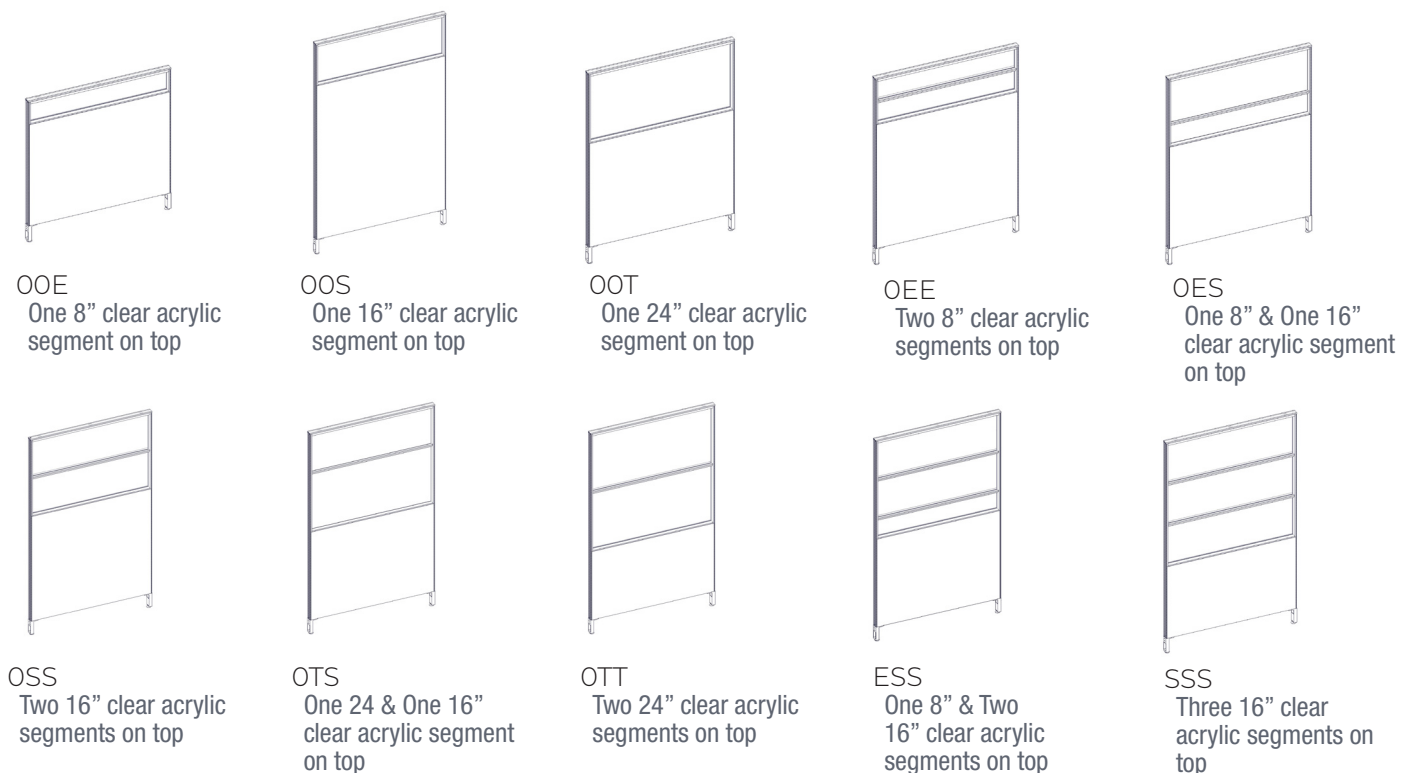

How to order and read your code

L - P E L C A - 42 24 - 0 0 E

product standard line P=glazed E=Elevated F=Fabric L=Laminate C=Clear F=Frosted A=Acrylic G=Glass height width 0 = No segment E = 8 inch segment S = 16 inch segment T = 24 inch segment

What's Included:

One (1) 2" thick panel with glazed glass top and laminate bottom, also 1" incremented slotted channels, One (1) top trim

How to Specify:

Refer to laminate cards for laminate selections
Choose glass or acrylic
Choose White, Black, Silver, Charcoal for Panel Frame colour

Options:

Height*	34", 42", 50", 66", 82"
Width:	24", 30", 36", 42", 48",
Laminate	
Glass/Acrylic	
Metal Powder Coat Paint:	White, Black, Silver, Charcoal

*82"H available up to 36"W

Notes:

Non-power capable panel.
Can be used in run with power-capable panels and allows wires to pass through.
Panels are non tackable. For tackable option see Panel Add-On section.

Code	Price	H	W	D
One 8" clear acrylic segment on top				
L-PELCA-4224-00E	1012	42	24	2
L-PELCA-4230-00E	1042	42	30	2
L-PELCA-4236-00E	1095	42	36	2
L-PELCA-4242-00E	1228	42	42	2
L-PELCA-4248-00E	1257	42	48	2
L-PELCA-5024-00E	1051	50	24	2
L-PELCA-5030-00E	1080	50	30	2
L-PELCA-5036-00E	1135	50	36	2
L-PELCA-5042-00E	1289	50	42	2
L-PELCA-5048-00E	1318	50	48	2
One 16" clear acrylic segment on top				
L-PELCA-5024-00S	1066	50	24	2
L-PELCA-5030-00S	1105	50	30	2
L-PELCA-5036-00S	1167	50	36	2
L-PELCA-5042-00S	1305	50	42	2
L-PELCA-5048-00S	1341	50	48	2
L-PELCA-6624-00S	1167	66	24	2
L-PELCA-6630-00S	1203	66	30	2
L-PELCA-6636-00S	1280	66	36	2
L-PELCA-6642-00S	1482	66	42	2
L-PELCA-6648-00S	1521	66	48	2
L-PELCA-8224-00S	1534	82	24	2
L-PELCA-8230-00S	1542	82	30	2
L-PELCA-8236-00S	2049	82	36	2
One 24" clear acrylic segment on top				
L-PELCA-6624-00T	1156	66	24	2
L-PELCA-6630-00T	1201	66	30	2
L-PELCA-6636-00T	1278	66	36	2
L-PELCA-6642-00T	1445	66	42	2
L-PELCA-6648-00T	1492	66	48	2
Two 8" clear acrylic segments on top				
L-PELCA-6624-0EE	1337	66	24	2
L-PELCA-6630-0EE	1345	66	30	2
L-PELCA-6636-0EE	1617	66	36	2
L-PELCA-6642-0EE	1645	66	42	2
L-PELCA-6648-0EE	1691	66	48	2
One 8" & One 16" clear acrylic segment on top				
L-PELCA-6624-0ES	1344	66	24	2
L-PELCA-6630-0ES	1391	66	30	2
L-PELCA-6636-0ES	1686	66	36	2
L-PELCA-6642-0ES	1733	66	42	2
L-PELCA-6648-0ES	1781	66	48	2
Two 16" clear acrylic segments on top				
L-PELCA-8224-0SS	1397	82	24	2
L-PELCA-8230-0SS	1460	82	30	2
L-PELCA-8236-0SS	1786	82	36	2
One 24" & One 16" clear acrylic segment on top				
L-PELCA-8224-0TS	1429	82	24	2
L-PELCA-8230-0TS	1511	82	30	2
L-PELCA-8236-0TS	1794	82	36	2
Two 24" clear acrylic segments on top				
L-PELCA-8224-0TT	1368	82	24	2
L-PELCA-8230-0TT	1438	82	30	2
L-PELCA-8236-0TT	1680	82	36	2
One 8" & Two 16" clear acrylic segments on top				
L-PELCA-8224-0SS	1491	82	24	2
L-PELCA-8230-0SS	1645	82	30	2
L-PELCA-8236-0SS	1939	82	36	2
Three 16" clear acrylic segments on top				
L-PELCA-8224-0SS	1461	82	24	2
L-PELCA-8230-0SS	1541	82	30	2
L-PELCA-8236-0SS	1858	82	36	2

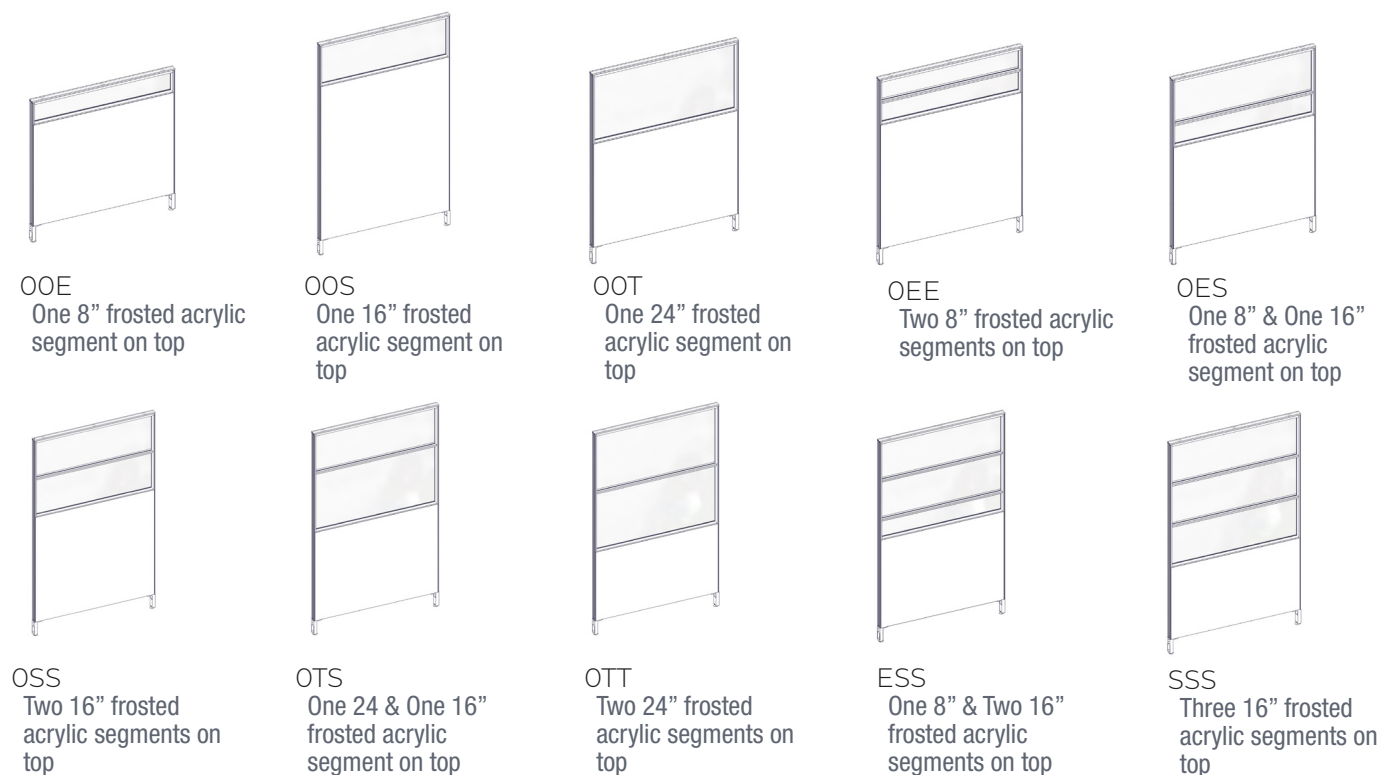

How to order and read your code

L - P E L F A - 4 2 2 4 - 0 0 E

product standard line P=glazed E=Elevated F=Fabric L=Laminate C=Clear F=Frosted A=Acrylic height G=Glass width 0 = No segment E = 8 inch segment S = 16 inch segment T = 24 inch segment

What's Included:

One (1) 2" thick panel with glazed glass top and laminate bottom, also 1" incremented slotted channels, One (1) top trim

How to Specify:

Refer to laminate cards for laminate selections
 Choose glass or acrylic
 Choose White, Black, Silver, Charcoal for Panel Frame colour

Options:

Height*	34", 42", 50", 66", 82"
Width:	24", 30", 36", 42", 48",
Laminate	
Glass/Acrylic	
Metal Powder Coat Paint:	White, Black, Silver, Charcoal

*82"H available up to 36"W

Notes:

Non-power capable panel.
 Can be used in run with power-capable panels and allows wires to pass through.
 Panels are non tackable. For tackable option see Panel Add-On section.

Code	Price	H	W	D
One 8" frosted acrylic segment on top				
L-PELFA-4224-00E	1117	24	42	2
L-PELFA-4230-00E	1144	30	42	2
L-PELFA-4236-00E	1197	36	42	2
L-PELFA-4242-00E	1330	42	42	2
L-PELFA-4248-00E	1359	48	42	2
L-PELFA-5024-00E	1154	24	50	2
L-PELFA-5030-00E	1181	30	50	2
L-PELFA-5036-00E	1237	36	50	2
L-PELFA-5042-00E	1391	42	50	2
L-PELFA-5048-00E	1420	48	50	2
One 16" frosted acrylic segment on top				
L-PELFA-5024-00S	1168	24	50	2
L-PELFA-5030-00S	1207	30	50	2
L-PELFA-5036-00S	1269	36	50	2
L-PELFA-5042-00S	1407	42	50	2
L-PELFA-5048-00S	1443	48	50	2
L-PELFA-6624-00S	1269	24	66	2
L-PELFA-6630-00S	1305	30	66	2
L-PELFA-6636-00S	1382	36	66	2
L-PELFA-6642-00S	1584	42	66	2
L-PELFA-6648-00S	1623	48	66	2
L-PELFA-8224-00S	1570	24	82	2
L-PELFA-8230-00S	1587	30	82	2
L-PELFA-8236-00S	2108	36	82	2
One 24" frosted acrylic segment on top				
L-PELFA-6624-00T	1258	24	66	2
L-PELFA-6630-00T	1304	30	66	2
L-PELFA-6636-00T	1380	36	66	2
L-PELFA-6642-00T	1547	42	66	2
L-PELFA-6648-00T	1594	48	66	2

Code	Price	H	W	D
Two 8" frosted acrylic segments on top				
L-PELFA-6624-0EE	1400	24	66	2
L-PELFA-6630-0EE	1428	30	66	2
L-PELFA-6636-0EE	1724	36	66	2
L-PELFA-6642-0EE	1749	42	66	2
L-PELFA-6648-0EE	1815	48	66	2
One 8" & One 16" frosted acrylic segment on top				
L-PELFA-6624-0ES	1396	24	66	2
L-PELFA-6630-0ES	1461	30	66	2
L-PELFA-6636-0ES	1770	36	66	2
L-PELFA-6642-0ES	1836	42	66	2
L-PELFA-6648-0ES	1884	48	66	2
Two 16" frosted acrylic segments on top				
L-PELFA-8224-0SS	1300	24	82	2
L-PELFA-8230-0SS	1320	30	82	2
L-PELFA-8236-0SS	1602	36	82	2
One 24" & One 16" frosted acrylic segment on top				
L-PELFA-8224-0TS	1532	24	82	2
L-PELFA-8230-0TS	1649	30	82	2
L-PELFA-8236-0TS	1933	36	82	2
Two 24" frosted acrylic segments on top				
L-PELFA-8224-0TT	1471	24	82	2
L-PELFA-8230-0TT	1575	30	82	2
L-PELFA-8236-0TT	1845	36	82	2
One 8" & Two 16" frosted acrylic segments on top				
L-PELFA-8224-ESS	1594	24	82	2
L-PELFA-8230-ESS	1782	30	82	2
L-PELFA-8236-ESS	2076	36	82	2
Three 16" frosted acrylic segments on top				
L-PELFA-8224-SSS	1565	24	82	2
L-PELFA-8230-SSS	1678	30	82	2
L-PELFA-8236-SSS	2065	36	82	2

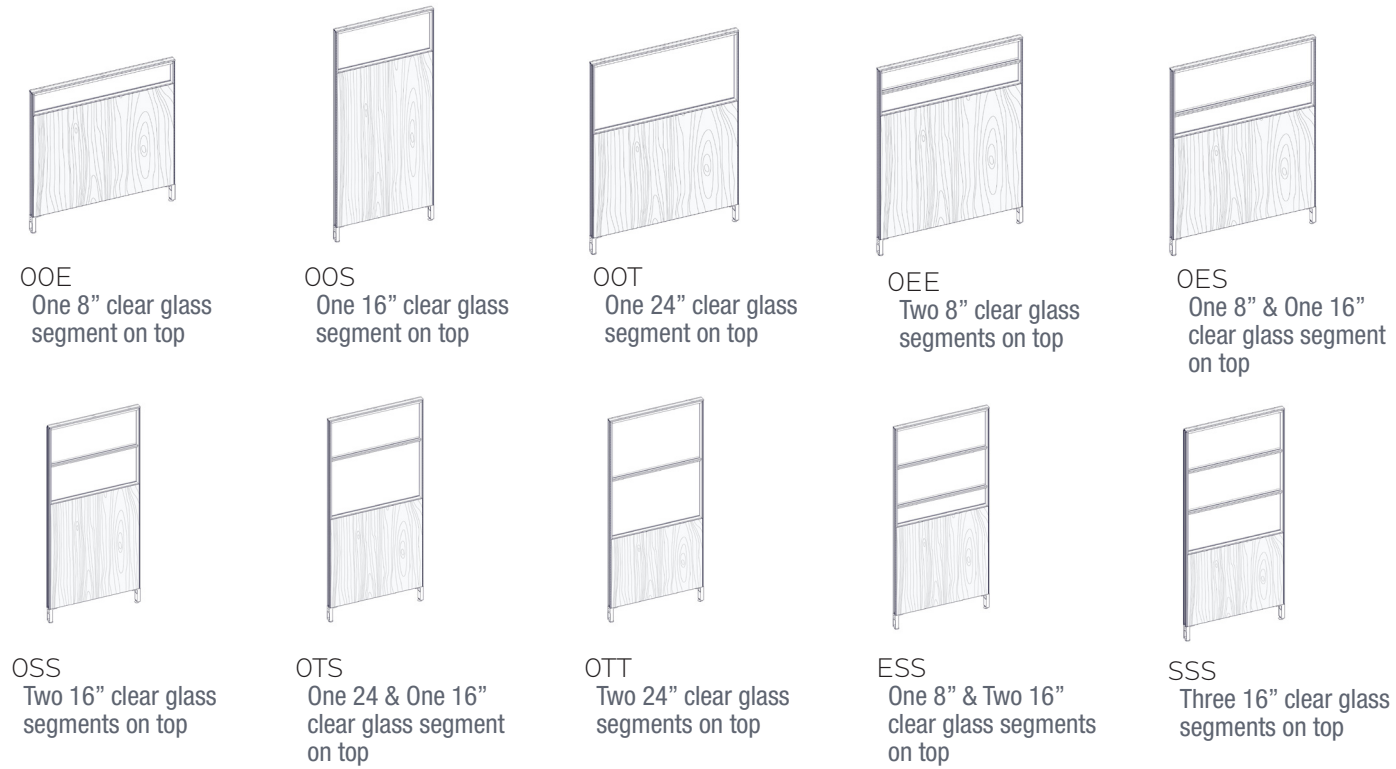

How to order and read your code

L - P E L C G - 42 24 - 0 0 E

product standard line P=glazed E=Elevated F=Fabric L=Laminate C=Clear F=Frosted A=Acrylic G=Glass height width 0 = No segment E = 8 inch segment S = 16 inch segment T = 24 inch segment

What's Included:

One (1) 2" thick panel with glazed glass top and laminate bottom, also 1" incremented slotted channels, One (1) top trim

How to Specify:

Refer to laminate cards for laminate selections
 Choose glass or acrylic
 Choose White, Black, Silver, Charcoal for Panel Frame color

Options:

Height*:	34", 42", 50", 66", 82"
Width:	24", 30", 36", 42", 48",
Laminate	
Glass/Acrylic	
Metal Powder Coat Paint:	White, Black, Silver, Charcoal

*82"H available up to 36"W

Notes:

Non-power capable panel.
 Can be used in run with power-capable panels and allows wires to pass through.
 Panels are non tackable. For tackable option see Panel Add-On section.

Code	Price	H	W	D
One 8" clear glass segment on top				
L-PELCG-4224-00E	1096	42	24	2
L-PELCG-4230-00E	1139	42	30	2
L-PELCG-4236-00E	1211	42	36	2
L-PELCG-4242-00E	1360	42	42	2
L-PELCG-4248-00E	1407	42	48	2
L-PELCG-5024-00E	1133	50	24	2
L-PELCG-5030-00E	1178	50	30	2
L-PELCG-5036-00E	1255	50	36	2
L-PELCG-5042-00E	1419	50	42	2
L-PELCG-5048-00E	1468	50	48	2
One 16" clear glass segment on top				
L-PELCG-5024-00S	1199	50	24	2
L-PELCG-5030-00S	1266	50	30	2
L-PELCG-5036-00S	1358	50	36	2
L-PELCG-5042-00S	1524	50	42	2
L-PELCG-5048-00S	1589	50	48	2
L-PELCG-6624-00S	1299	66	24	2
L-PELCG-6630-00S	1367	66	30	2
L-PELCG-6636-00S	1470	66	36	2
L-PELCG-6642-00S	1697	66	42	2
L-PELCG-6648-00S	1766	66	48	2
L-PELCG-8224-00S	1494	82	24	2
L-PELCG-8230-00S	1527	82	30	2
L-PELCG-8236-00S	2054	82	36	2
One 24" clear glass segment on top				
L-PELCG-6624-00T	1341	66	24	2
L-PELCG-6630-00T	1429	66	30	2
L-PELCG-6636-00T	1542	66	36	2
L-PELCG-6642-00T	1748	66	42	2
L-PELCG-6648-00T	1840	66	48	2
Two 8" clear glass segments on top				
L-PELCG-6624-0EE	1435	66	24	2
L-PELCG-6630-0EE	1474	66	30	2
L-PELCG-6636-0EE	1772	66	36	2
L-PELCG-6642-0EE	1811	66	42	2
L-PELCG-6648-0EE	1872	66	48	2
One 8" & One 16" clear glass segment on top				
L-PELCG-6624-0ES	1435	66	24	2
L-PELCG-6630-0ES	1494	66	30	2
L-PELCG-6636-0ES	1806	66	36	2
L-PELCG-6642-0ES	1859	66	42	2
L-PELCG-6648-0ES	1935	66	48	2
Two 16" clear glass segments on top				
L-PELCG-8224-0SS	1487	82	24	2
L-PELCG-8230-0SS	1544	82	30	2
L-PELCG-8236-0SS	1872	82	36	2
One 24" & One 16" clear glass segment on top				
L-PELCG-8224-0TS	1517	82	24	2
L-PELCG-8230-0TS	1599	82	30	2
L-PELCG-8236-0TS	1934	82	36	2
Two 24" clear glass segments on top				
L-PELCG-8224-0TT	1486	82	24	2
L-PELCG-8230-0TT	1574	82	30	2
L-PELCG-8236-0TT	1836	82	36	2
One 8" & Two 16" clear glass segments on top				
L-PELCG-8224-ESS	1668	82	24	2
L-PELCG-8230-ESS	1811	82	30	2
L-PELCG-8236-ESS	2156	82	36	2
Three 16" clear glass segments on top				
L-PELCG-8224-SSS	1644	82	24	2
L-PELCG-8230-SSS	1723	82	30	2
L-PELCG-8236-SSS	2009	82	36	2

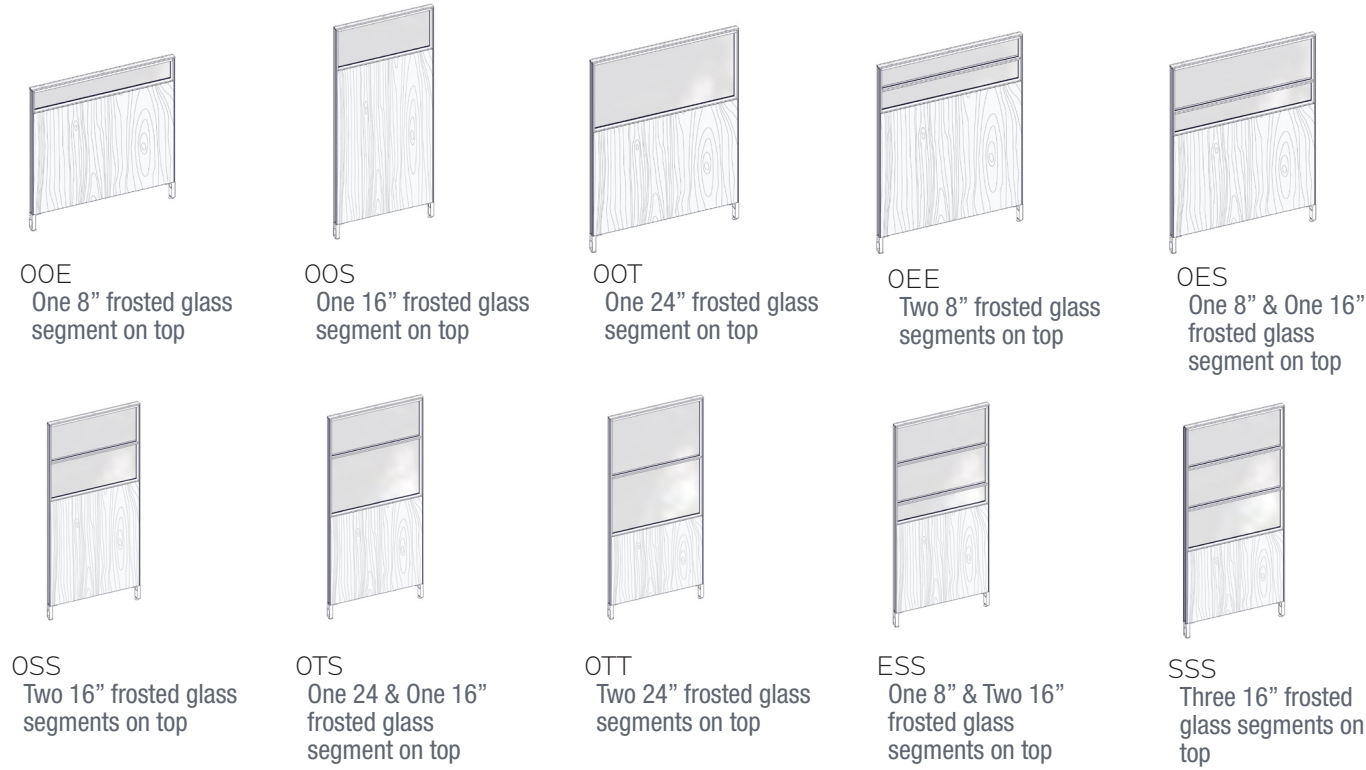

How to order and read your code

L - P E L F G - 42 24 - 00 E

product standard line P=glazed E=Elevated F=Fabric L=Laminate C=Clear F=Frosted A=Acrylic height width G=Glass
 0 = No segment
 E = 8 inch segment
 S = 16 inch segment
 T = 24 inch segment

What's Included:

One (1) 2" thick panel with glazed glass top and laminate bottom, also 1" incremented slotted channels, One (1) top trim

How to Specify:

Refer to laminate cards for laminate selections
 Choose glass or acrylic
 Choose White, Black, Silver, Charcoal for Panel Frame colour

Options:

Height*:	34", 42", 50", 66", 82"
Width:	24", 30", 36", 42", 48",
Laminate	
Glass/Acrylic	
Metal Powder Coat Paint:	White, Black, Silver, Charcoal

*82"H available up to 36"W

Code	Price	H	W	D
One 8" frosted glass segment on top				
L-PELFG-4224-00E	1198	24	42	2
L-PELFG-4230-00E	1242	30	42	2
L-PELFG-4236-00E	1313	36	42	2
L-PELFG-4242-00E	1462	42	42	2
L-PELFG-4248-00E	1509	48	42	2
L-PELFG-5024-00E	1235	24	50	2
L-PELFG-5030-00E	1280	30	50	2
L-PELFG-5036-00E	1357	36	50	2
L-PELFG-5042-00E	1521	42	50	2
L-PELFG-5048-00E	1570	48	50	2
One 16" frosted glass segment on top				
L-PELFG-5024-00S	1301	24	50	2
L-PELFG-5030-00S	1368	30	50	2
L-PELFG-5036-00S	1460	36	50	2
L-PELFG-5042-00S	1627	42	50	2
L-PELFG-5048-00S	1691	48	50	2
L-PELFG-6624-00S	1401	24	66	2
L-PELFG-6630-00S	1469	30	66	2
L-PELFG-6636-00S	1572	36	66	2
L-PELFG-6642-00S	1799	42	66	2
L-PELFG-6648-00S	1868	48	66	2
L-PELFG-8224-00S	1679	24	82	2
L-PELFG-8230-00S	1721	30	82	2
L-PELFG-8236-00S	2267	36	82	2
One 24" frosted glass segment on top				
L-PELFG-6624-00T	1443	24	66	2
L-PELFG-6630-00T	1531	30	66	2
L-PELFG-6636-00T	1644	36	66	2
L-PELFG-6642-00T	1849	42	66	2
L-PELFG-6648-00T	1942	48	66	2

Code	Price	H	W	D
Two 8" frosted glass segments on top				
L-PELFG-6624-0EE	1602	24	66	2
L-PELFG-6630-0EE	1642	30	66	2
L-PELFG-6636-0EE	1939	36	66	2
L-PELFG-6642-0EE	1978	42	66	2
L-PELFG-6648-0EE	2039	48	66	2
One 8" & One 16" frosted glass segment on top				
L-PELFG-6624-0ES	1602	24	66	2
L-PELFG-6630-0ES	1670	30	66	2
L-PELFG-6636-0ES	2002	36	66	2
L-PELFG-6642-0ES	2073	42	66	2
L-PELFG-6648-0ES	2168	48	66	2
Two 16" frosted glass segments on top				
L-PELFG-8224-0SS	1654	24	82	2
L-PELFG-8230-0SS	1730	30	82	2
L-PELFG-8236-0SS	2095	36	82	2
One 24" & One 16" frosted glass segment on top				
L-PELFG-8224-0TS	1712	24	82	2
L-PELFG-8230-0TS	1831	30	82	2
L-PELFG-8236-0TS	2213	36	82	2
Two 24" frosted glass segments on top				
L-PELFG-8224-0TT	1710	24	82	2
L-PELFG-8230-0TT	1851	30	82	2
L-PELFG-8236-0TT	2172	36	82	2
One 8" & Two 16" frosted glass segments on top				
L-PELFG-8224-ESS	1918	24	82	2
L-PELFG-8230-ESS	2081	30	82	2
L-PELFG-8236-ESS	2463	36	82	2
Three 16" frosted glass segments on top				
L-PELFG-8224-SSS	1895	24	82	2
L-PELFG-8230-SSS	2002	30	82	2
L-PELFG-8236-SSS	2344	36	82	2

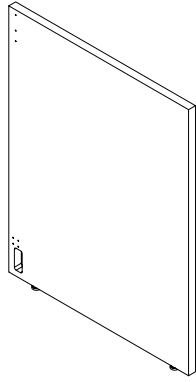

Single Span Middle
Horizontal Woodgrain
Gallery Panel

What's Included:

One (1) 1" thick laminate gallery panel, two (2) gallery panel top brackets

How to Specify:

Refer to laminate cards for laminate selections

Notes:

Gallery panels come with pre-drilled holes on each side and bottom notch for wire routing

Gallery panels must be used between two standard fabric or laminate panels

Gallery panels must be the same height or lower than the connecting standard fabric or laminate panel

Options:

Height: 34", 42", 50"

Width: 26", 32", 38", 44", 50", 56", 62", 68", 74"

Laminate color

Code	Price	H	W	D	Weight (lb.)	Volume (ft ³)
L-PYHM-3426-S1	284	34	26	2		
L-PYHM-3432-S1	314	34	32	2		
L-PYHM-3438-S1	343	34	38	2		
L-PYHM-3444-S1	371	34	44	2		
L-PYHM-3450-S1	400	34	50	2		
L-PYHM-3456-S1	427	34	50	2		
L-PYHM-3462-S1	459	34	62	2		
L-PYHM-3468-S1	486	34	68	2		
L-PYHM-3474-S1	514	34	74	2		
L-PYHM-4226-S1	314	42	26	2		
L-PYHM-4232-S1	350	42	32	2		
L-PYHM-4238-S1	385	42	38	2		
L-PYHM-4244-S1	421	42	44	2		
L-PYHM-4250-S1	457	42	50	2		
L-PYHM-4256-S1	488	42	50	2		
L-PYHM-4262-S1	525	42	62	2		
L-PYHM-4268-S1	561	42	68	2		
L-PYHM-4274-S1	599	42	74	2		
L-PYHM-5026-S1	347	50	26	2		
L-PYHM-5032-S1	386	50	32	2		
L-PYHM-5038-S1	426	50	38	2		
L-PYHM-5044-S1	471	50	44	2		
L-PYHM-5050-S1	510	50	50	2		
L-PYHM-5056-S1	553	50	50	2		
L-PYHM-5062-S1	595	50	62	2		
L-PYHM-5068-S1	633	50	68	2		
L-PYHM-5074-S1	677	50	74	2		

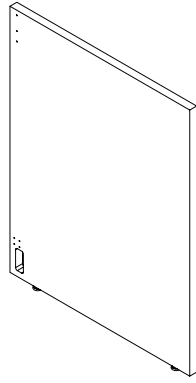

Double Span Middle
Horizontal Woodgrain
Gallery Panel

What's Included:

- X"-X": One (1) 1"thick laminate gallery panel, two (2) gallery panel top brackets
- X"-X": Two (2) 1"thick laminate gallery panel, four (4) gallery panel top brackets

How to Specify:

Refer to laminate cards for laminate selections

Notes:

- Gallery panels come with pre-drilled holes on each side and bottom notch for wire routing
- Gallery panels must be used between two standard fabric or laminate panels
- Gallery panels must be the same height or lower than the connecting standard fabric or laminate panel

Options:

Height:	34", 42", 50"
Width:	26", 32", 38", 44", 50", 56", 62", 68", 74"
Laminate color	

Code	Price	H	W	D	Weight (lb.)	Volume (ft ³)
1 Piece						
L-PYHM-3442-D1	361	34	42	2		
L-PYHM-3450-D1	400	34	50	2		
L-PYHM-3462-D1	459	34	62	2		
L-PYHM-3474-D1	514	34	74	2		
L-PYHM-3486-D1	574	34	86	2		
L-PYHM-4242-D1	409	42	42	2		
L-PYHM-4250-D1	457	42	50	2		
L-PYHM-4262-D1	525	42	62	2		
L-PYHM-4274-D1	599	42	74	2		
L-PYHM-4286-D1	668	42	86	2		
L-PYHM-5042-D1	457	50	42	2		
L-PYHM-5050-D1	510	50	50	2		
L-PYHM-5062-D1	595	50	62	2		
L-PYHM-5074-D1	677	50	74	2		
L-PYHM-5086-D1	760	50	86	2		
2 Pieces						
L-PYHM-3498-D2	736	34	98	2		
L-PYHM-4298-D2	846	42	98	2		
L-PYHM-5098-D2	956	50	98	2		
L-PYHM-34110-D2	796	34	110	2		
L-PYHM-34122-D2	854	34	122	2		
L-PYHM-34134-D2	909	34	134	2		
L-PYHM-34146-D2	969	34	146	2		
L-PYHM-42110-D2	917	42	110	2		
L-PYHM-42122-D2	986	42	122	2		
L-PYHM-42134-D2	1058	42	134	2		
L-PYHM-42146-D2	1130	42	146	2		
L-PYHM-50110-D2	1038	50	110	2		
L-PYHM-50122-D2	1122	50	122	2		
L-PYHM-50134-D2	1207	50	134	2		
L-PYHM-50146-D2	1289	50	146	2		



Single Span End Horizontal Woodgrain Gallery Panel No Power Cutout

What's Included:

One (1) 1" thick laminate gallery panel, two (2) gallery panel top brackets

How to Specify:

Refer to laminate cards for laminate selections

Choose option for power cut out or no power cut out

Options:

Height: 34", 42", 50"

Width: 26", 32", 38", 44", 50", 56", 62", 68", 74"

Laminate color

Power cut out

Notes:

Gallery panels come with pre-drilled holes on each side and bottom notch for wire routing

Gallery panels must be used between two standard fabric or laminate panels

Gallery panels must be the same height or lower than the connecting standard fabric or laminate panel

Code	Price	H	W	D	Weight (lb.)	Volume (ft ³)
left hand						
L-PYHE-3426-S1L	245	34	26	2		
L-PYHE-3432-S1L	273	34	32	2		
L-PYHE-3438-S1L	301	34	38	2		
L-PYHE-3444-S1L	329	34	44	2		
L-PYHE-3450-S1L	359	34	50	2		
L-PYHE-3456-S1L	388	34	56	2		
L-PYHE-3462-S1L	418	34	62	2		
L-PYHE-3468-S1L	445	34	68	2		
L-PYHE-3474-S1L	475	34	74	2		
L-PYHE-4226-S1L	273	42	26	2		
L-PYHE-4232-S1L	308	42	32	2		
L-PYHE-4238-S1L	344	42	38	2		
L-PYHE-4244-S1L	378	42	44	2		
L-PYHE-4250-S1L	415	42	50	2		
L-PYHE-4256-S1L	448	42	56	2		

Code	Price	H	W	D	Weight (lb.)	Volume (ft ³)
L-PYHE-4262-S1L	484	42	62	2		
L-PYHE-4268-S1L	521	42	68	2		
L-PYHE-4274-S1L	557	42	74	2		
L-PYHE-5026-S1L	303	50	26	2		
L-PYHE-5032-S1L	347	50	32	2		
L-PYHE-5038-S1L	386	50	38	2		
L-PYHE-5044-S1L	427	50	44	2		
L-PYHE-5050-S1L	471	50	50	2		
L-PYHE-5056-S1L	511	50	56	2		
L-PYHE-5062-S1L	553	50	62	2		
L-PYHE-5068-S1L	595	50	68	2		
L-PYHE-5074-S1L	634	50	74	2		
right hand						
L-PYHE-3426-S1R	245	34	26	2		
L-PYHE-3432-S1R	273	34	32	2		
L-PYHE-3438-S1R	301	34	38	2		
L-PYHE-3444-S1R	329	34	44	2		
L-PYHE-3450-S1R	359	34	50	2		
L-PYHE-3456-S1R	388	34	56	2		
L-PYHE-3462-S1R	418	34	62	2		
L-PYHE-3468-S1R	445	34	68	2		
L-PYHE-3474-S1R	475	34	74	2		
L-PYHE-4226-S1R	273	42	26	2		
L-PYHE-4232-S1R	308	42	32	2		
L-PYHE-4238-S1R	344	42	38	2		
L-PYHE-4244-S1R	378	42	44	2		
L-PYHE-4250-S1R	415	42	50	2		
L-PYHE-4256-S1R	448	42	56	2		
L-PYHE-4262-S1R	484	42	62	2		
L-PYHE-4268-S1R	521	42	68	2		
L-PYHE-4274-S1R	557	42	74	2		
L-PYHE-5026-S1R	303	50	26	2		
L-PYHE-5032-S1R	347	50	32	2		
L-PYHE-5038-S1R	386	50	38	2		
L-PYHE-5044-S1R	427	50	44	2		
L-PYHE-5050-S1R	471	50	50	2		
L-PYHE-5056-S1R	511	50	56	2		
L-PYHE-5062-S1R	553	50	62	2		
L-PYHE-5068-S1R	595	50	68	2		
L-PYHE-5074-S1R	634	50	74	2		



Single Span End Horizontal Woodgrain Gallery Panel with Power Cutout

What's Included:

One (1) 1" thick laminate gallery panel, two (2) gallery panel top brackets

How to Specify:

Refer to laminate cards for laminate selections

Choose option for power cut out or no power cut out

Options:

Height: 34", 42", 50"

Width: 26", 32", 38", 44", 50", 56", 62", 68", 74"

Laminate color

No power cut out

Code	Price	H	W	D	Weight (lb.)	Volume (ft ³)
left hand						
L-PCHE-3426-S1L	245	34	26	1		
L-PCHE-3432-S1L	273	34	32	1		
L-PCHE-3438-S1L	301	34	38	1		
L-PCHE-3444-S1L	329	34	44	1		
L-PCHE-3450-S1L	359	34	50	1		
L-PCHE-3456-S1L	388	34	56	1		
L-PCHE-3462-S1L	418	34	62	1		
L-PCHE-3468-S1L	445	34	68	1		
L-PCHE-3474-S1L	475	34	74	1		
L-PCHE-4226-S1L	273	42	26	1		
L-PCHE-4232-S1L	308	42	32	1		
L-PCHE-4238-S1L	344	42	38	1		
L-PCHE-4244-S1L	378	42	44	1		
L-PCHE-4250-S1L	415	42	50	1		
L-PCHE-4256-S1L	448	42	56	1		

Code	Price	H	W	D	Weight (lb.)	Volume (ft ³)
L-PCHE-4262-S1L	484	42	62	1		
L-PCHE-4268-S1L	521	42	68	1		
L-PCHE-4274-S1L	557	42	74	1		
L-PCHE-5026-S1L	303	50	26	1		
L-PCHE-5032-S1L	347	50	32	1		
L-PCHE-5038-S1L	386	50	38	1		
L-PCHE-5044-S1L	427	50	44	1		
L-PCHE-5050-S1L	471	50	50	1		
L-PCHE-5056-S1L	511	50	56	1		
L-PCHE-5062-S1L	553	50	62	1		
L-PCHE-5068-S1L	595	50	68	1		
L-PCHE-5074-S1L	634	50	74	1		
right hand						
L-PCHE-3426-S1R	245	34	26	1		
L-PCHE-3432-S1R	273	34	32	1		
L-PCHE-3438-S1R	301	34	38	1		
L-PCHE-3444-S1R	329	34	44	1		
L-PCHE-3450-S1R	359	34	50	1		
L-PCHE-3456-S1R	388	34	56	1		
L-PCHE-3462-S1R	418	34	62	1		
L-PCHE-3468-S1R	445	34	68	1		
L-PCHE-3474-S1R	475	34	74	1		
L-PCHE-4226-S1R	273	42	26	1		
L-PCHE-4232-S1R	308	42	32	1		
L-PCHE-4238-S1R	344	42	38	1		
L-PCHE-4244-S1R	378	42	44	1		
L-PCHE-4250-S1R	415	42	50	1		
L-PCHE-4256-S1R	448	42	56	1		
L-PCHE-4262-S1R	484	42	62	1		
L-PCHE-4268-S1R	521	42	68	1		
L-PCHE-4274-S1R	557	42	74	1		
L-PCHE-5026-S1R	303	50	26	1		
L-PCHE-5032-S1R	347	50	32	1		
L-PCHE-5038-S1R	386	50	38	1		
L-PCHE-5044-S1R	427	50	44	1		
L-PCHE-5050-S1R	471	50	50	1		
L-PCHE-5056-S1R	511	50	56	1		
L-PCHE-5062-S1R	553	50	62	1		
L-PCHE-5068-S1R	595	50	68	1		
L-PCHE-5074-S1R	634	50	74	1		



Single piece
Double Span End
Horizontal Woodgrain
Gallery Panel
No Power Cutout



Two pieces
Double Span End
Horizontal Woodgrain
Gallery Panel
No Power Cutout

What's Included:

- X"-X": One (1) 1"thick laminate gallery panel, two (2) gallery panel top brackets
- X"-X": Two (2) 1"thick laminate gallery panel, four (4) gallery panel top brackets

How to Specify:

- Refer to laminate cards for laminate selections
- Choose option for power cut out or no power cut out

Options:

Height:

Width:

Laminate color

Power cut out

Notes:

- Gallery panels come with pre-drilled holes on each side and bottom notch for wire routing
- Gallery panels must be used between two standard fabric or laminate panels
- Gallery panels must be the same height or lower than the connecting standard fabric or laminate panel

Code	Price	H	W	D	Weight (lb.)	Volume (ft ³)
single piece						
L-PYHE-3442-D1	320	34	42	2		
L-PYHE-3450-D1	359	34	50	2		
L-PYHE-3462-D1	418	34	62	2		
L-PYHE-3474-D1	475	34	74	2		
L-PYHE-3486-D1	533	34	86	2		
L-PYHE-4242-D1	369	42	42	2		
L-PYHE-4250-D1	415	42	50	2		
L-PYHE-4262-D1	484	42	62	2		
L-PYHE-4274-D1	557	42	74	2		
L-PYHE-4286-D1	626	42	86	2		
L-PYHE-5042-D1	415	50	42	2		
L-PYHE-5050-D1	471	50	50	2		
L-PYHE-5062-D1	553	50	62	2		
L-PYHE-5074-D1	634	50	74	2		
L-PYHE-5086-D1	720	50	86	2		
2 pieces						
L-PYHE-3498-D2	736	34	98	2		
L-PYHE-4298-D2	846	42	98	2		
L-PYHE-5098-D2	956	50	98	2		
L-PYHE-34110-D2	796	34	110	2		
L-PYHE-34122-D2	854	34	122	2		
L-PYHE-34134-D2	909	34	134	2		
L-PYHE-34146-D2	969	34	146	2		
L-PYHE-42110-D2	917	42	110	2		
L-PYHE-42122-D2	986	42	122	2		
L-PYHE-42134-D2	1058	42	134	2		
L-PYHE-42146-D2	1130	42	146	2		
L-PYHE-50110-D2	1038	50	110	2		
L-PYHE-50122-D2	1122	50	122	2		
L-PYHE-50134-D2	1207	50	134	2		
L-PYHE-50146-D2	1289	50	146	2		



Single piece

Double Span End Horizontal Woodgrain Gallery Panel with Power Cutout



2 pieces

What's Included:

X"-X": One (1) 1"thick laminate gallery panel, two (2) gallery panel top brackets

X"-X": Two (2) 1"thick laminate gallery panel, four (4) gallery panel top brackets

How to Specify:

Refer to laminate cards for laminate selections

Choose option for power cut out or no power cut out

Notes:

Gallery panels come with pre-drilled holes on each side and bottom notch for wire routing

Gallery panels must be used between two standard fabric or laminate panels

Gallery panels must be the same height or lower than the connecting standard fabric or laminate panel

Options:

Height: 34", 42", 50"

Width: 26", 32", 38", 44", 50", 56", 62", 68", 74"

Laminate color

No power cut out

Code	Price	H	W	D	Weight (lb.)	Volume (ft ³)
single piece						
L-PCHE-3442-D1	320	34	42	1		
L-PCHE-3450-D1	359	34	50	1		
L-PCHE-3462-D1	418	34	62	1		
L-PCHE-3474-D1	475	34	74	1		
L-PCHE-3486-D1	533	34	86	1		
L-PCHE-4242-D1	369	42	42	1		
L-PCHE-4250-D1	415	42	50	1		
L-PCHE-4262-D1	484	42	62	1		
L-PCHE-4274-D1	557	42	74	1		
L-PCHE-4286-D1	626	42	86	1		
L-PCHE-5042-D1	415	50	42	1		
L-PCHE-5050-D1	471	50	50	1		
L-PCHE-5062-D1	553	50	62	1		
L-PCHE-5074-D1	634	50	74	1		
L-PCHE-5086-D1	720	50	86	1		
2 pieces						
L-PCHE-3498-D2	736	34	98	1		
L-PCHE-34110-D2	796	34	110	1		
L-PCHE-34122-D2	854	34	122	1		
L-PCHE-34134-D2	909	34	134	1		
L-PCHE-34146-D2	969	34	146	1		
L-PCHE-4298-D2	846	42	98	1		
L-PCHE-42110-D2	917	42	110	1		
L-PCHE-42122-D2	986	42	122	1		
L-PCHE-42134-D2	1058	42	134	1		
L-PCHE-42146-D2	1130	42	146	1		
L-PCHE-5098-D2	956	50	98	1		
L-PCHE-50110-D2	1038	50	110	1		
L-PCHE-50122-D2	1122	50	122	1		
L-PCHE-50134-D2	1207	50	134	1		
L-PCHE-50146-D2	1289	50	146	1		

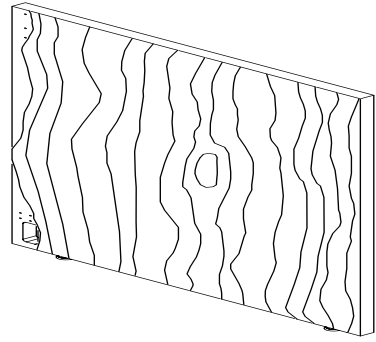

Single Span Middle
Vertical Woodgrain
Gallery Panel

What's Included:

One (1) 1" thick laminate gallery panel,
two (2) gallery panel top brackets

How to Specify:

Refer to laminate cards for laminate selections

Notes:

Gallery panels come with pre-drilled holes on each side and bottom notch for wire routing

Gallery panels must be used between two standard fabric or laminate panels

Gallery panels must be the same height or lower than the connecting standard fabric or laminate panel

Options:

Height: 34", 42", 50"

Width: 26", 32", 38", 44", 50", 56", 62", 68", 74"

Laminate color

Code	Price	H	W	D	Weight (lb.)	Volume (ft ³)
L-PYGM-3426-S1	284	34	26	1	17.7	0.51
L-PYGM-3432-S1	314	34	32	1	21.8	0.63
L-PYGM-3438-S1	343	34	38	1	25.8	0.75
L-PYGM-3444-S1	371	34	44	1	29.9	0.87
L-PYGM-3450-S1	400	34	50	1	34.0	0.98
L-PYGM-3456-S1	427	34	56	1	38.1	1.10
L-PYGM-4226-S1	314	42	26	1	21.8	0.63
L-PYGM-4232-S1	350	42	32	1	26.9	0.78
L-PYGM-4238-S1	385	42	38	1	31.9	0.92
L-PYGM-4244-S1	421	42	44	1	37.0	1.07
L-PYGM-4250-S1	457	42	50	1	42.0	1.22
L-PYGM-4256-S1	488	42	56	1	47.0	1.36
L-PYGM-5026-S1	347	50	26	1	26.0	0.75
L-PYGM-5032-S1	386	50	32	1	32.0	0.93
L-PYGM-5038-S1	426	50	38	1	38.0	1.10
L-PYGM-5044-S1	471	50	44	1	44.0	1.27
L-PYGM-5050-S1	510	50	50	1	50.0	1.45
L-PYGM-5056-S1	553	50	56	1	56.0	1.62

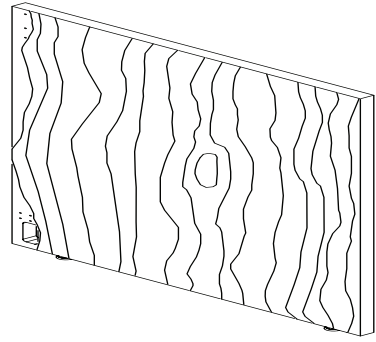

Double Span Middle
Vertical Woodgrain
Gallery Panel

What's Included:

X"-X": One (1) 1"thick laminate gallery panel, two (2) gallery panel top brackets

X"-X": Two (2) 1"thick laminate gallery panel, four (4) gallery panel top brackets

How to Specify:

Refer to laminate cards for laminate selections

Notes:

Gallery panels come with pre-drilled holes on each side and bottom notch for wire routing

Gallery panels must be used between two standard fabric or laminate panels

Gallery panels must be the same height or lower than the connecting standard fabric or laminate panel

Options:

Height: 34", 42", 50"

Width: 26", 32", 38", 44", 50", 56", 62", 68", 74"

Laminate color

Code	Price	H	W	D	Weight (lb.)	Volume (ft ³)
single piece						
L-PYGM-3442-D1	361	34	42	1	28.6	0.83
L-PYGM-3450-D1	400	34	50	1	34.0	0.98
L-PYGM-4242-D1	409	42	42	1	28.6	1.02
L-PYGM-4250-D1	457	42	50	1	42.0	1.22
L-PYGM-5042-D1	457	50	42	1	28.6	1.22
L-PYGM-5050-D1	510	50	50	1	50.0	1.45
2 pieces						
L-PYGM-3462-D2	563	34	62	1	42.2	1.22
L-PYGM-3474-D2	622	34	74	1	50.3	1.46
L-PYGM-3486-D2	678	34	86	1	58.5	1.69
L-PYGM-3498-D2	736	34	98	1	66.6	1.93
L-PYGM-4262-D2	633	42	62	1	52.1	1.51
L-PYGM-4274-D2	706	42	74	1	62.2	1.80
L-PYGM-4286-D2	775	42	86	1	72.2	2.09
L-PYGM-4298-D2	846	42	98	1	82.3	2.38
L-PYGM-5062-D2	707	50	62	1	62.0	1.79
L-PYGM-5074-D2	788	50	74	1	74.0	2.14
L-PYGM-5086-D2	872	50	86	1	86.0	2.49
L-PYGM-5098-D2	956	50	98	1	98.0	2.84
L-PYGM-34110-D2	796	34	110	1	74.8	2.16
L-PYGM-42110-D2	917	42	110	1	92.4	2.67
L-PYGM-50110-D2	1038	50	110	1	110.0	3.18

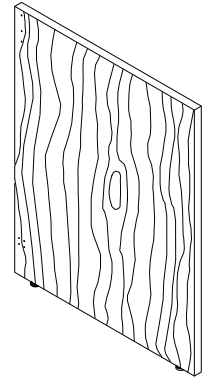

Single Span End
Vertical Woodgrain
Gallery Panel
No Power Cutout

What's Included:

One (1) 1"thick laminate gallery panel,
two (2) gallery panel top brackets

How to Specify:

Refer to laminate cards for laminate selections

Choose option for power cut out or no power cut out

Notes:

Gallery panels come with pre-drilled holes on each side and bottom notch for wire routing

Gallery panels must be used between two standard fabric or laminate panels

Gallery panels must be the same height or lower than the connecting standard fabric or laminate panel

Options:

Height: 34", 42", 50"

Width: 26", 32", 38", 44", 50", 56", 62", 68", 74"

Laminate color

Power cut out, No power cut out

Code	Price	H	W	D	Weight (lb.)	Volume (ft ³)
left hand						
L-PYGE-3426-S1L	245	34	26	1	17.7	0.51
L-PYGE-3432-S1L	273	34	32	1	21.8	0.63
L-PYGE-3438-S1L	301	34	38	1	25.8	0.75
L-PYGE-3444-S1L	329	34	44	1	29.9	0.87
L-PYGE-3450-S1L	359	34	50	1	34.0	0.98
L-PYGE-3456-S1L	388	34	56	1	38.1	1.10
L-PYGE-4226-S1L	273	42	26	1	21.8	0.63
L-PYGE-4232-S1L	308	42	32	1	26.9	0.78
L-PYGE-4238-S1L	344	42	38	1	31.9	0.92
L-PYGE-4244-S1L	378	42	44	1	37.0	1.07
L-PYGE-4250-S1L	415	42	50	1	42.0	1.22
L-PYGE-4256-S1L	448	42	56	1	47.0	1.36
L-PYGE-5026-S1L	303	50	26	1	26.0	0.75
L-PYGE-5032-S1L	347	50	32	1	32.0	0.93
L-PYGE-5038-S1L	386	50	38	1	38.0	1.10
L-PYGE-5044-S1L	427	50	44	1	44.0	1.27
L-PYGE-5050-S1L	471	50	50	1	50.0	1.45
L-PYGE-5056-S1L	511	50	56	1	56.0	1.62
right hand						
L-PYGE-3426-S1R	245	34	26	1	17.7	0.51
L-PYGE-3432-S1R	273	34	32	1	21.8	0.63
L-PYGE-3438-S1R	301	34	38	1	25.8	0.75
L-PYGE-3444-S1R	329	34	44	1	29.9	0.87
L-PYGE-3450-S1R	359	34	50	1	34.0	0.98
L-PYGE-3456-S1R	388	34	56	1	38.1	1.10
L-PYGE-4226-S1R	273	42	26	1	21.8	0.63
L-PYGE-4232-S1R	308	42	32	1	26.9	0.78
L-PYGE-4238-S1R	344	42	38	1	31.9	0.92
L-PYGE-4244-S1R	378	42	44	1	37.0	1.07
L-PYGE-4250-S1R	415	42	50	1	42.0	1.22
L-PYGE-4256-S1R	448	42	56	1	47.0	1.36
L-PYGE-5026-S1R	303	50	26	1	26.0	0.75
L-PYGE-5032-S1R	347	50	32	1	32.0	0.93
L-PYGE-5038-S1R	386	50	38	1	38.0	1.10
L-PYGE-5044-S1R	427	50	44	1	44.0	1.27
L-PYGE-5050-S1R	471	50	50	1	50.0	1.45
L-PYGE-5056-S1R	511	50	56	1	56.0	1.62

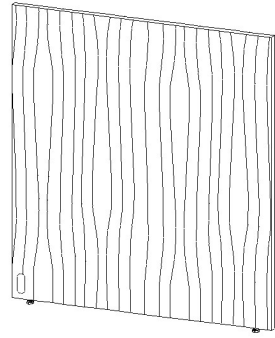

Single Span End
Vertical Woodgrain
Gallery Panel
with Power Cutout

What's Included:

One (1) 1"thick laminate gallery panel,
two (2) gallery panel top brackets

How to Specify:

Refer to laminate cards for laminate selections

Choose option for power cut out or no power cut out

Notes:

Gallery panels come with pre-drilled holes on each side and bottom notch for wire routing

Gallery panels must be used between two standard fabric or laminate panels

Gallery panels must be the same height or lower than the connecting standard fabric or laminate panel

Options:

Height: 34", 42", 50"

Width: 26", 32", 38", 44", 50", 56", 62", 68", 74"

Laminate color

Power cut out, No power cut out

Code	Price	H	W	D	Weight (lb.)	Volume (ft ³)
left hand						
L-PCGE-3426-S1L	245	34	26	1	17.7	0.51
L-PCGE-3432-S1L	273	34	32	1	21.8	0.63
L-PCGE-3438-S1L	301	34	38	1	25.8	0.75
L-PCGE-3444-S1L	329	34	44	1	29.9	0.87
L-PCGE-3450-S1L	359	34	50	1	34.0	0.98
L-PCGE-3456-S1L	388	34	56	1	38.1	1.10
L-PCGE-4226-S1L	273	42	26	1	21.8	0.63
L-PCGE-4232-S1L	308	42	32	1	26.9	0.78
L-PCGE-4238-S1L	344	42	38	1	31.9	0.92
L-PCGE-4244-S1L	378	42	44	1	37.0	1.07
L-PCGE-4250-S1L	415	42	50	1	42.0	1.22
L-PCGE-4256-S1L	448	42	56	1	47.0	1.36
L-PCGE-5026-S1L	303	50	26	1	26.0	0.75
L-PCGE-5032-S1L	347	50	32	1	32.0	0.93
L-PCGE-5038-S1L	386	50	38	1	38.0	1.10
L-PCGE-5044-S1L	427	50	44	1	44.0	1.27
L-PCGE-5050-S1L	471	50	50	1	50.0	1.45
L-PCGE-5056-S1L	511	50	56	1	56.0	1.62
right hand						
L-PCGE-3426-S1R	245	34	26	1	17.7	0.51
L-PCGE-3432-S1R	273	34	32	1	21.8	0.63
L-PCGE-3438-S1R	301	34	38	1	25.8	0.75
L-PCGE-3444-S1R	329	34	44	1	29.9	0.87
L-PCGE-3450-S1R	359	34	50	1	34.0	0.98
L-PCGE-3456-S1R	388	34	56	1	38.1	1.10
L-PCGE-4226-S1R	273	42	26	1	21.8	0.63
L-PCGE-4232-S1R	308	42	32	1	26.9	0.78
L-PCGE-4238-S1R	344	42	38	1	31.9	0.92
L-PCGE-4244-S1R	378	42	44	1	37.0	1.07
L-PCGE-4250-S1R	415	42	50	1	42.0	1.22
L-PCGE-4256-S1R	448	42	56	1	47.0	1.36
L-PCGE-5026-S1R	303	50	26	1	26.0	0.75
L-PCGE-5032-S1R	347	50	32	1	32.0	0.93
L-PCGE-5038-S1R	386	50	38	1	38.0	1.10
L-PCGE-5044-S1R	427	50	44	1	44.0	1.27
L-PCGE-5050-S1R	471	50	50	1	50.0	1.45
L-PCGE-5056-S1R	511	50	56	1	56.0	1.62

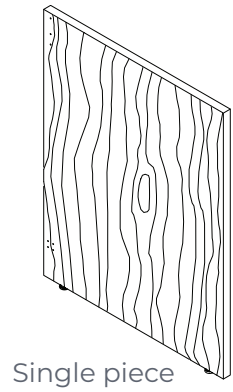

Double Span End
Vertical Woodgrain
Gallery Panel
No Power Cutout

Single piece

What's Included:

X"-X": One (1) 1"thick laminate gallery panel, two (2) gallery panel top brackets

X"-X": Two (2) 1"thick laminate gallery panel, four (4) gallery panel top brackets

How to Specify:

Refer to laminate cards for laminate selections

Choose option for power cut out or no power cut out

Notes:

Gallery panels come with pre-drilled holes on each side and bottom notch for wire routing

Gallery panels must be used between two standard fabric or laminate panels

Gallery panels must be the same height or lower than the connecting standard fabric or laminate panel

Options:

Height: 34", 42", 50"

Width: 26", 32", 38", 44", 50", 56", 62", 68", 74"

Laminate color

Power cut out, no power cut out

Code	Price	H	W	D	Weight (lb.)	Volume (ft ³)
single piece						
L-PYGE-3442-D1	320	34	42	1	28.6	0.83
L-PYGE-3450-D1	359	34	50	1	34.0	0.98
L-PYGE-4242-D1	369	42	42	1	28.6	1.02
L-PYGE-4250-D1	415	42	50	1	42.0	1.22
L-PYGE-5042-D1	415	50	42	1	28.6	1.22
L-PYGE-5050-D1	471	50	50	1	50.0	1.45
2 pieces						
L-PYGE-3462-D2	563	34	62	1	42.2	1.22
L-PYGE-3474-D2	622	34	74	1	50.3	1.46
L-PYGE-3486-D2	678	34	86	1	58.5	1.69
L-PYGE-3498-D2	736	34	98	1	66.6	1.93
L-PYGE-4262-D2	633	42	62	1	52.1	1.51
L-PYGE-4274-D2	706	42	74	1	62.2	1.80
L-PYGE-4286-D2	775	42	86	1	72.2	2.09
L-PYGE-4298-D2	846	42	98	1	82.3	2.38
L-PYGE-5062-D2	707	50	62	1	62.0	1.79
L-PYGE-5074-D2	788	50	74	1	74.0	2.14
L-PYGE-5086-D2	872	50	86	1	86.0	2.49
L-PYGE-5098-D2	956	50	98	1	98.0	2.84
L-PYGE-34110-D2	796	34	110	1	74.8	2.16
L-PYGE-42110-D2	917	42	110	1	92.4	2.67
L-PYGE-50110-D2	1038	50	110	1	110.0	3.18

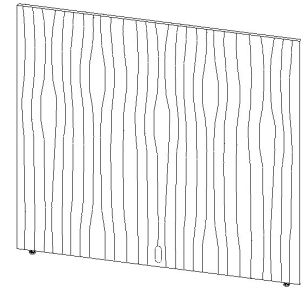

Single piece

Double Span End Vertical Woodgrain Gallery Panel with Power Cutout

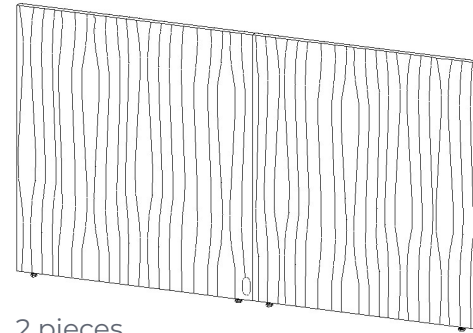

2 pieces

What's Included:

X"-X": One (1) 1"thick laminate gallery panel, two (2) gallery panel top brackets

X"-X": Two (2) 1"thick laminate gallery panel, four (4) gallery panel top brackets

How to Specify:

Refer to laminate cards for laminate selections

Choose option for power cut out or no power cut out

Notes:

Gallery panels come with pre-drilled holes on each side and bottom notch for wire routing

Gallery panels must be used between two standard fabric or laminate panels

Gallery panels must be the same height or lower than the connecting standard fabric or laminate panel

Options:

Height: 34", 42", 50"

Width: 26", 32", 38", 44", 50", 56", 62", 68", 74"

Laminate color

Power cut out, no power cut out

Code	Price	H	W	D	Weight (lb.)	Volume (ft ³)
single piece						
L-PCGE-3442-D1	320	34	42	1	28.6	0.83
L-PCGE-3450-D1	359	34	50	1	34.0	0.98
L-PCGE-4242-D1	369	42	42	1	28.6	1.02
L-PCGE-4250-D1	415	42	50	1	42.0	1.22
L-PCGE-5042-D1	415	50	42	1	28.6	1.22
L-PCGE-5050-D1	471	50	50	1	50.0	1.45
2 pieces						
L-PCGE-3462-D2	563	34	62	1	42.2	1.22
L-PCGE-3474-D2	622	34	74	1	50.3	1.46
L-PCGE-3486-D2	678	34	86	1	58.5	1.69
L-PCGE-3498-D2	736	34	98	1	66.6	1.93
L-PCGE-34110-D2	796	34	110	1	52.1	1.51
L-PCGE-4262-D2	633	42	62	1	62.2	1.80
L-PCGE-4274-D2	706	42	74	1	72.2	2.09
L-PCGE-4286-D2	775	42	86	1	82.3	2.38
L-PCGE-4298-D2	846	42	98	1	62.0	1.79
L-PCGE-42110-D2	917	42	110	1	74.0	2.14
L-PCGE-5062-D2	707	50	62	1	86.0	2.49
L-PCGE-5074-D2	788	50	74	1	98.0	2.84
L-PCGE-5086-D2	872	50	86	1	74.8	2.16
L-PCGE-5098-D2	956	50	98	1	92.4	2.67
L-PCGE-50110-D2	1038	50	110	1	110.0	3.18

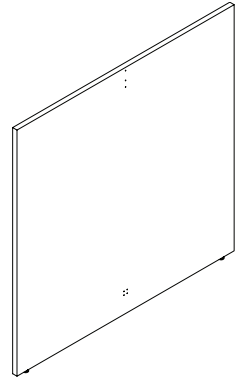

Single Span Middle
Solid Gallery Panel

What's Included:

One (1) 1"thick laminate gallery panel,
two (2) gallery panel top brackets

How to Specify:

Refer to laminate cards for laminate selections

Options:

Height: 34", 42", 50"

Width: 26", 32", 38", 44", 50", 56", 62", 68", 74"

Laminate color

Notes:

Gallery panels come with pre-drilled holes on each side and bottom notch for wire routing

Gallery panels must be used between two standard fabric or laminate panels

Gallery panels must be the same height or lower than the connecting standard fabric or laminate panel

Code	Price	H	W	D	Weight (lb.)	Volume (ft ³)
L-PYSM-3426-S1	284	34	26	1	17.7	0.51
L-PYSM-3432-S1	314	34	32	1	21.8	0.63
L-PYSM-3438-S1	343	34	38	1	25.8	0.75
L-PYSM-3444-S1	371	34	44	1	29.9	0.87
L-PYSM-3450-S1	400	34	50	1	34.0	0.98
L-PYSM-3456-S1	427	34	56	1	38.1	1.10
L-PYSM-3462-S1	459	34	62	1	42.2	1.22
L-PYSM-3468-S1	486	34	68	1	46.2	1.34
L-PYSM-3474-S1	514	34	74	1	50.3	1.46
L-PYSM-4226-S1	314	42	26	1	21.8	0.63
L-PYSM-4232-S1	350	42	32	1	26.9	0.78
L-PYSM-4238-S1	385	42	38	1	31.9	0.92
L-PYSM-4244-S1	421	42	44	1	37.0	1.07
L-PYSM-4250-S1	457	42	50	1	42.0	1.22
L-PYSM-4256-S1	488	42	56	1	47.0	1.36
L-PYSM-4262-S1	525	42	62	1	52.1	1.51
L-PYSM-4268-S1	561	42	68	1	57.1	1.65
L-PYSM-4274-S1	599	42	74	1	62.2	1.80
L-PYSM-5026-S1	347	50	26	1	26.0	0.75
L-PYSM-5032-S1	386	50	32	1	32.0	0.93
L-PYSM-5038-S1	426	50	38	1	38.0	1.10
L-PYSM-5044-S1	471	50	44	1	44.0	1.27
L-PYSM-5050-S1	510	50	50	1	50.0	1.45
L-PYSM-5056-S1	553	50	56	1	56.0	1.62
L-PYSM-5062-S1	595	50	62	1	62.0	1.79
L-PYSM-5068-S1	633	50	68	1	68.0	1.97
L-PYSM-5074-S1	677	50	74	1	74.0	2.14

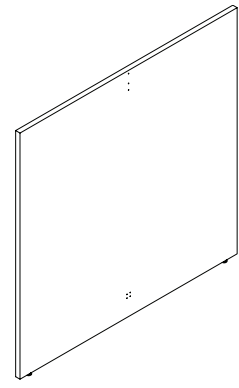

Single piece

Double Span Middle
Solid Gallery Panel

What's Included:

X"-X": One (1) 1"thick laminate gallery panel, two (2) gallery panel top brackets

X"-X": Two (2) 1"thick laminate gallery panel, four (4) gallery panel top brackets

How to Specify:

Refer to laminate cards for laminate selections

Notes:

Gallery panels come with pre-drilled holes on each side and bottom notch for wire routing

Gallery panels must be used between two standard fabric or laminate panels

Gallery panels must be the same height or lower than the connecting standard fabric or laminate panel

Options:

Height: 34", 42", 50"

Width: 26", 32", 38", 44", 50", 56", 62", 68", 74"

Laminate color

Power cut out, no power cut out

Code	Price	H	W	D	Weight (lb.)	Volume (ft ³)
single piece						
L-PYSM-3442-D1	361	34	42	1	28.6	0.83
L-PYSM-3450-D1	400	34	50	1	34.0	0.98
L-PYSM-3462-D1	459	34	62	1	42.2	1.22
L-PYSM-3474-D1	514	34	74	1	50.3	1.46
L-PYSM-3486-D1	574	34	86	1	58.5	1.69
L-PYSM-4242-D1	409	42	42	1	35.3	1.02
L-PYSM-4250-D1	457	42	50	1	42.0	1.22
L-PYSM-4262-D1	525	42	62	1	52.1	1.51
L-PYSM-4274-D1	599	42	74	1	62.2	1.80
L-PYSM-4286-D1	668	42	86	1	72.2	2.09
L-PYSM-5042-D1	457	50	42	1	42.0	1.22
L-PYSM-5050-D1	510	50	50	1	50.0	1.45
L-PYSM-5062-D1	595	50	62	1	62.0	1.79
L-PYSM-5074-D1	677	50	74	1	74.0	2.14
L-PYSM-5086-D1	760	50	86	1	86.0	2.49
2 pieces						
L-PYSM-3498-D2	736	34	98	1	66.6	1.93
L-PYSM-4298-D2	846	42	98	1	82.3	2.38
L-PYSM-5098-D2	956	50	98	1	98.0	2.84
L-PYSM-34110-D2	796	34	110	1	74.8	2.16
L-PYSM-34122-D2	854	34	122	1	83.0	2.40
L-PYSM-34134-D2	909	34	134	1	91.1	2.64
L-PYSM-34146-D2	969	34	146	1	99.3	2.87
L-PYSM-42110-D2	917	42	110	1	92.4	2.67
L-PYSM-42122-D2	986	42	122	1	102.5	2.97
L-PYSM-42134-D2	1058	42	134	1	112.6	3.26
L-PYSM-42146-D2	1130	42	146	1	122.6	3.55
L-PYSM-50110-D2	1038	50	110	1	110.0	3.18
L-PYSM-50122-D2	1122	50	122	1	122.0	3.53
L-PYSM-50134-D2	1207	50	134	1	134.0	3.88
L-PYSM-50146-D2	1289	50	146	1	146.0	4.22

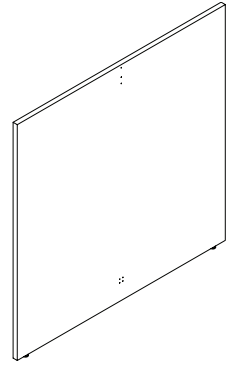

Single Span End Solid Gallery Panel

What's Included:

One (1) 1"thick laminate gallery panel, two (2) gallery panel top brackets

How to Specify:

Refer to laminate cards for laminate selections

Choose option for power cut out or no power cut out

Options:

Height: 34", 42", 50"

Width: 26", 32", 38", 44", 50", 56", 62", 68", 74"

Laminate color

Power cut out, No power cut out

Code	Price	H	W	D	Weight (lb.)	Volume (ft ³)
left hand						
L-PYSE-3426-S1L	245	34	26	1	17.7	0.51
L-PYSE-3432-S1L	273	34	32	1	21.8	0.63
L-PYSE-3438-S1L	301	34	38	1	25.8	0.75
L-PYSE-3444-S1L	329	34	44	1	29.9	0.87
L-PYSE-3450-S1L	359	34	50	1	34.0	0.98
L-PYSE-3456-S1L	388	34	56	1	38.1	1.10
L-PYSE-3462-S1L	418	34	62	1	42.2	1.22
L-PYSE-3468-S1L	445	34	68	1	46.2	1.34
L-PYSE-3474-S1L	475	34	74	1	50.3	1.46
L-PYSE-4226-S1L	273	42	26	1	21.8	0.63
L-PYSE-4232-S1L	308	42	32	1	26.9	0.78
L-PYSE-4238-S1L	344	42	38	1	31.9	0.92
L-PYSE-4244-S1L	378	42	44	1	37.0	1.07
L-PYSE-4250-S1L	415	42	50	1	42.0	1.22
L-PYSE-4256-S1L	448	42	56	1	47.0	1.36

Code	Price	H	W	D	Weight (lb.)	Volume (ft ³)
L-PYSE-4262-S1L	484	42	62	1	52.1	1.51
L-PYSE-4268-S1L	521	42	68	1	57.1	1.65
L-PYSE-4274-S1L	557	42	74	1	62.2	1.80
L-PYSE-5026-S1L	303	50	26	1	26.0	0.75
L-PYSE-5032-S1L	347	50	32	1	32.0	0.93
L-PYSE-5038-S1L	386	50	38	1	38.0	1.10
L-PYSE-5044-S1L	427	50	44	1	44.0	1.27
L-PYSE-5050-S1L	471	50	50	1	50.0	1.45
L-PYSE-5056-S1L	511	50	56	1	56.0	1.62
L-PYSE-5062-S1L	553	50	62	1	62.0	1.79
L-PYSE-5068-S1L	595	50	68	1	68.0	1.97
L-PYSE-5074-S1L	634	50	74	1	74.0	2.14
right hand						
L-PYSE-3426-S1R	245	34	26	1	17.7	0.51
L-PYSE-3432-S1R	273	34	32	1	21.8	0.63
L-PYSE-3438-S1R	301	34	38	1	25.8	0.75
L-PYSE-3444-S1R	329	34	44	1	29.9	0.87
L-PYSE-3450-S1R	359	34	50	1	34.0	0.98
L-PYSE-3456-S1R	388	34	56	1	38.1	1.10
L-PYSE-3462-S1R	418	34	62	1	42.2	1.22
L-PYSE-3468-S1R	445	34	68	1	46.2	1.34
L-PYSE-3474-S1R	475	34	74	1	50.3	1.46
L-PYSE-4226-S1R	273	42	26	1	21.8	0.63
L-PYSE-4232-S1R	308	42	32	1	26.9	0.78
L-PYSE-4238-S1R	344	42	38	1	31.9	0.92
L-PYSE-4244-S1R	378	42	44	1	37.0	1.07
L-PYSE-4250-S1R	415	42	50	1	42.0	1.22
L-PYSE-4256-S1R	448	42	56	1	47.0	1.36
L-PYSE-4262-S1R	484	42	62	1	52.1	1.51
L-PYSE-4268-S1R	521	42	68	1	57.1	1.65
L-PYSE-4274-S1R	557	42	74	1	62.2	1.80
L-PYSE-5026-S1R	303	50	26	1	26.0	0.75
L-PYSE-5032-S1R	347	50	32	1	32.0	0.93
L-PYSE-5038-S1R	386	50	38	1	38.0	1.10
L-PYSE-5044-S1R	427	50	44	1	44.0	1.27
L-PYSE-5050-S1R	471	50	50	1	50.0	1.45
L-PYSE-5056-S1R	511	50	56	1	56.0	1.62
L-PYSE-5062-S1R	553	50	62	1	62.0	1.79
L-PYSE-5068-S1R	595	50	68	1	68.0	1.97
L-PYSE-5074-S1R	634	50	74	1	74.0	2.14

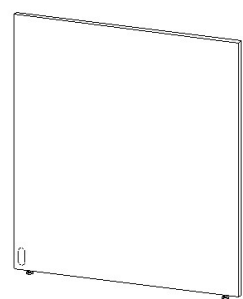

Single Span End Solid Gallery Panel with Power Cutout

What's Included:

One (1) 1"thick laminate gallery panel, two (2) gallery panel top brackets

How to Specify:

Refer to laminate cards for laminate selections

Choose option for power cut out or no power cut out

Options:

Height: 34", 42", 50"

Width: 26", 32", 38", 44", 50", 56", 62", 68", 74"

Laminate color

Power cut out, No power cut out

Notes:

Gallery panels come with pre-drilled holes on each side and bottom notch for wire routing

Gallery panels must be used between two standard fabric or laminate panels

Gallery panels must be the same height or lower than the connecting standard fabric or laminate panel

Code	Price	H	W	D	Weight (lb.)	Volume (ft ³)
left hand						
L-PCSE-3426-S1L	245	34	26	1	17.7	0.51
L-PCSE-3432-S1L	273	34	32	1	21.8	0.63
L-PCSE-3438-S1L	301	34	38	1	25.8	0.75
L-PCSE-3444-S1L	329	34	44	1	29.9	0.87
L-PCSE-3450-S1L	359	34	50	1	34.0	0.98
L-PCSE-3456-S1L	388	34	56	1	38.1	1.10
L-PCSE-3462-S1L	418	34	62	1	42.2	1.22
L-PCSE-3468-S1L	445	34	68	1	46.2	1.34
L-PCSE-3474-S1L	475	34	74	1	50.3	1.46
L-PCSE-4226-S1L	273	42	26	1	21.8	0.63
L-PCSE-4232-S1L	308	42	32	1	26.9	0.78
L-PCSE-4238-S1L	344	42	38	1	31.9	0.92
L-PCSE-4244-S1L	378	42	44	1	37.0	1.07
L-PCSE-4250-S1L	415	42	50	1	42.0	1.22
L-PCSE-4256-S1L	448	42	56	1	47.0	1.36

Code	Price	H	W	D	Weight (lb.)	Volume (ft ³)
L-PCSE-4262-S1L	484	42	62	1	52.1	1.51
L-PCSE-4268-S1L	521	42	68	1	57.1	1.65
L-PCSE-4274-S1L	557	42	74	1	62.2	1.80
L-PCSE-5026-S1L	303	50	26	1	26.0	0.75
L-PCSE-5032-S1L	347	50	32	1	32.0	0.93
L-PCSE-5038-S1L	386	50	38	1	38.0	1.10
L-PCSE-5044-S1L	427	50	44	1	44.0	1.27
L-PCSE-5050-S1L	471	50	50	1	50.0	1.45
L-PCSE-5056-S1L	511	50	56	1	56.0	1.62
L-PCSE-5062-S1L	553	50	62	1	62.0	1.79
L-PCSE-5068-S1L	595	50	68	1	68.0	1.97
L-PCSE-5074-S1L	634	50	74	1	74.0	2.14
right hand						
L-PCSE-3426-S1R	245	34	26	1	17.7	0.51
L-PCSE-3432-S1R	273	34	32	1	21.8	0.63
L-PCSE-3438-S1R	301	34	38	1	25.8	0.75
L-PCSE-3444-S1R	329	34	44	1	29.9	0.87
L-PCSE-3450-S1R	359	34	50	1	34.0	0.98
L-PCSE-3456-S1R	388	34	56	1	38.1	1.10
L-PCSE-3462-S1R	418	34	62	1	42.2	1.22
L-PCSE-3468-S1R	445	34	68	1	46.2	1.34
L-PCSE-3474-S1R	475	34	74	1	50.3	1.46
L-PCSE-4226-S1R	273	42	26	1	21.8	0.63
L-PCSE-4232-S1R	308	42	32	1	26.9	0.78
L-PCSE-4238-S1R	344	42	38	1	31.9	0.92
L-PCSE-4244-S1R	378	42	44	1	37.0	1.07
L-PCSE-4250-S1R	415	42	50	1	42.0	1.22
L-PCSE-4256-S1R	448	42	56	1	47.0	1.36
L-PCSE-4262-S1R	484	42	62	1	52.1	1.51
L-PCSE-4268-S1R	521	42	68	1	57.1	1.65
L-PCSE-4274-S1R	557	42	74	1	62.2	1.80
L-PCSE-5026-S1R	303	50	26	1	26.0	0.75
L-PCSE-5032-S1R	347	50	32	1	32.0	0.93
L-PCSE-5038-S1R	386	50	38	1	38.0	1.10
L-PCSE-5044-S1R	427	50	44	1	44.0	1.27
L-PCSE-5050-S1R	471	50	50	1	50.0	1.45
L-PCSE-5056-S1R	511	50	56	1	56.0	1.62
L-PCSE-5062-S1R	553	50	62	1	62.0	1.79
L-PCSE-5068-S1R	595	50	68	1	68.0	1.97
L-PCSE-5074-S1R	634	50	74	1	74.0	2.14

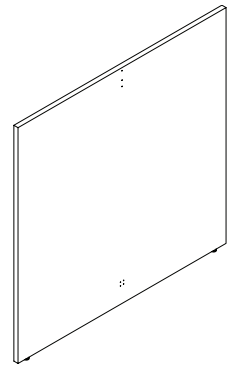

Double Span End
Solid Gallery Panel
No Power Cutout

Single piece

What's Included:

X"-X": One (1) 1"thick laminate gallery panel, two (2) gallery panel top brackets

X"-X": Two (2) 1"thick laminate gallery panel, four (4) gallery panel top brackets

How to Specify:

Refer to laminate cards for laminate selections

Choose option for power cut out or no power cut out

Notes:

Gallery panels come with pre-drilled holes on each side and bottom notch for wire routing

Gallery panels must be used between two standard fabric or laminate panels

Gallery panels must be the same height or lower than the connecting standard fabric or laminate panel

Options:

Height: 34", 42", 50"

Width: 26", 32", 38", 44", 50", 56", 62", 68", 74"

Laminate color

Power cut out, no power cut out

Code	Price	H	W	D	Weight (lb.)	Volume (ft ³)
single piece						
L-PYSE-3442-D1	320	34	42	1	28.6	0.83
L-PYSE-3450-D1	359	34	50	1	34.0	0.98
L-PYSE-3462-D1	418	34	62	1	42.2	1.22
L-PYSE-3474-D1	475	34	74	1	50.3	1.46
L-PYSE-3486-D1	533	34	86	1	58.5	1.69
L-PYSE-4242-D1	369	42	42	1	35.3	1.02
L-PYSE-4250-D1	415	42	50	1	42.0	1.22
L-PYSE-4262-D1	484	42	62	1	52.1	1.51
L-PYSE-4274-D1	557	42	74	1	62.2	1.80
L-PYSE-4286-D1	626	42	86	1	72.2	2.09
L-PYSE-5042-D1	415	50	42	1	42.0	1.22
L-PYSE-5050-D1	471	50	50	1	50.0	1.45
L-PYSE-5062-D1	553	50	62	1	62.0	1.79
L-PYSE-5074-D1	634	50	74	1	74.0	2.14
L-PYSE-5086-D1	720	50	86	1	86.0	2.49
2 pieces						
L-PYSE-3498-D2	736	34	98	1	66.6	1.93
L-PYSE-4298-D2	846	42	98	1	82.3	2.38
L-PYSE-5098-D2	956	50	98	1	98.0	2.84
L-PYSE-34110-D2	796	34	110	1	74.8	2.16
L-PYSE-34122-D2	854	34	122	1	83.0	2.40
L-PYSE-34134-D2	909	34	134	1	91.1	2.64
L-PYSE-34146-D2	969	34	146	1	99.3	2.87
L-PYSE-42110-D2	917	42	110	1	92.4	2.67
L-PYSE-42122-D2	986	42	122	1	102.5	2.97
L-PYSE-42134-D2	1058	42	134	1	112.6	3.26
L-PYSE-42146-D2	1130	42	146	1	122.6	3.55
L-PYSE-50110-D2	1038	50	110	1	110.0	3.18
L-PYSE-50122-D2	1122	50	122	1	122.0	3.53
L-PYSE-50134-D2	1207	50	134	1	134.0	3.88
L-PYSE-50146-D2	1289	50	146	1	146.0	4.22

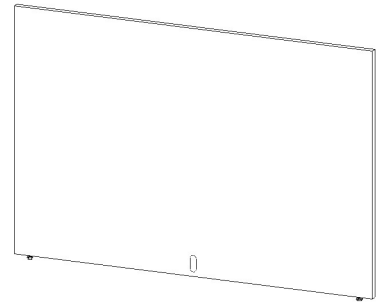

Single piece

Double Span End Solid Gallery Panel with Power Cutout

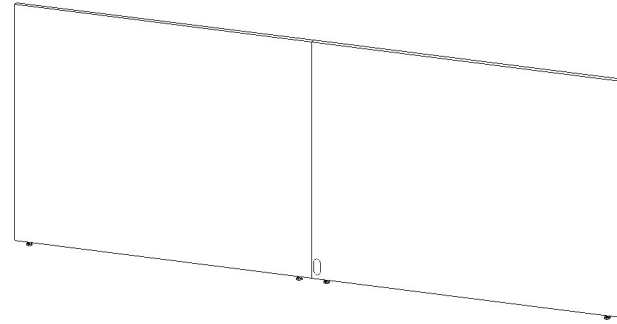

2 pieces

What's Included:

X"-X": One (1) 1"thick laminate gallery panel, two (2) gallery panel top brackets

X"-X": Two (2) 1"thick laminate gallery panel, four (4) gallery panel top brackets

How to Specify:

Refer to laminate cards for laminate selections

Choose option for power cut out or no power cut out

Notes:

Gallery panels come with pre-drilled holes on each side and bottom notch for wire routing

Gallery panels must be used between two standard fabric or laminate panels

Gallery panels must be the same height or lower than the connecting standard fabric or laminate panel

Options:

Height: 34", 42", 50"

Width: 26", 32", 38", 44", 50", 56", 62", 68", 74"

Laminate color

Power cut out, no power cut out

Code	Price	H	W	D	Weight (lb.)	Volume (ft ³)
single piece						
L-PCSE-3442-D1	320	34	42	1	28.6	0.80
L-PCSE-3450-D1	359	34	50	1	34.0	1.00
L-PCSE-3462-D1	418	34	62	1	42.2	1.20
L-PCSE-3474-D1	475	34	74	1	50.3	1.50
L-PCSE-3486-D1	533	34	86	1	58.5	1.70
L-PCSE-4242-D1	369	42	42	1	35.3	1.00
L-PCSE-4250-D1	415	42	50	1	42.0	1.20
L-PCSE-4262-D1	484	42	62	1	52.1	1.50
L-PCSE-4274-D1	557	42	74	1	62.2	1.80
L-PCSE-4286-D1	626	42	86	1	72.2	2.10
L-PCSE-5042-D1	415	50	42	1	42.0	1.20
L-PCSE-5050-D1	471	50	50	1	50.0	1.40
L-PCSE-5062-D1	553	50	62	1	62.0	1.80
L-PCSE-5074-D1	634	50	74	1	74.0	2.10
L-PCSE-5086-D1	720	50	86	1	86.0	2.50
2 pieces						
L-PCSE-3498-D2	736	34	98	1	66.6	1.90
L-PCSE-34110-D2	796	34	110	1	82.3	2.40
L-PCSE-34122-D2	854	34	122	1	98.0	2.80
L-PCSE-34134-D2	909	34	134	1	74.8	2.20
L-PCSE-34146-D2	969	34	146	1	83.0	2.40
L-PCSE-4298-D2	846	42	98	1	91.1	2.60
L-PCSE-42110-D2	917	42	110	1	99.3	2.90
L-PCSE-42122-D2	986	42	122	1	92.4	2.70
L-PCSE-42134-D2	1058	42	134	1	102.5	3.00
L-PCSE-42146-D2	1130	42	146	1	112.6	3.30
L-PCSE-5098-D2	956	50	98	1	122.6	3.50
L-PCSE-50110-D2	1038	50	110	1	110.0	3.20
L-PCSE-50122-D2	1122	50	122	1	122.0	3.50
L-PCSE-50134-D2	1207	50	134	1	134.0	3.90
L-PCSE-50146-D2	1289	50	146	1	146.0	4.20

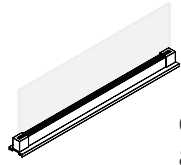

Glass Frameless Blade for Standard and Elevated Panels

Double span panel top mounted privacy screen can be placed across the width of two equal sized panels

What's Included:

One (1) tempered glass piece, One (1) channel extrusion, Two (2) end caps, One (1) top trim

How to Specify:

Refer to metal finish card for metal finish options

Notes:

One (1) glass piece can span the width of one or two panels up to 72"W

Glass is tempered

Options:

Height: 8", 16", 20"

Width: 24", 30", 36", 42", 48", 54", 60", 66", 72"

Clear, Frosted

Code	Price	H	W	D	Weight (lb.)	Volume (ft ³)
Glass screen - Clear						
L-VG-P-0824-C	473	8	24	0.75		
L-VG-P-0830-C	500	8	30	0.75		
L-VG-P-0836-C	547	8	36	0.75		
L-VG-P-0842-C	585	8	42	0.75		
L-VG-P-0848-C	590	8	48	0.75		
L-VG-P-0854-C	637	8	54	0.75		
L-VG-P-0860-C	647	8	60	0.75		
L-VG-P-0866-C	694	8	66	0.75		
L-VG-P-0872-C	700	8	72	0.75		
L-VG-P-1624-C	513	16	24	0.75		
L-VG-P-1630-C	545	16	30	0.75		
L-VG-P-1636-C	595	16	36	0.75		
L-VG-P-1642-C	636	16	42	0.75		
L-VG-P-1648-C	644	16	48	0.75		
L-VG-P-1654-C	694	16	54	0.75		
L-VG-P-1660-C	698	16	60	0.75		

Code	Price	H	W	D	Weight (lb.)	Volume (ft ³)
L-VG-P-1666-C	732	16	66	0.75		
L-VG-P-1672-C	761	16	72	0.75		
L-VG-P-2024-C	548	20	24	0.75		
L-VG-P-2030-C	588	20	30	0.75		
L-VG-P-2036-C	663	20	36	0.75		
L-VG-P-2042-C	706	20	42	0.75		
L-VG-P-2048-C	710	20	48	0.75		
L-VG-P-2054-C	761	20	54	0.75		
L-VG-P-2060-C	770	20	60	0.75		
L-VG-P-2066-C	811	20	66	0.75		
L-VG-P-2072-C	825	20	72	0.75		

Code	Price	H	W	D	Weight (lb.)	Volume (ft ³)
Glass screen - Frosted						
L-VG-P-0824-F	613	8	24	0.75		
L-VG-P-0830-F	649	8	30	0.75		
L-VG-P-0836-F	710	8	36	0.75		
L-VG-P-0842-F	761	8	42	0.75		
L-VG-P-0848-F	768	8	48	0.75		
L-VG-P-0854-F	829	8	54	0.75		
L-VG-P-0860-F	835	8	60	0.75		
L-VG-P-0866-F	893	8	66	0.75		
L-VG-P-0872-F	909	8	72	0.75		
L-VG-P-1624-F	668	16	24	0.75		
L-VG-P-1630-F	707	16	30	0.75		
L-VG-P-1636-F	773	16	36	0.75		
L-VG-P-1642-F	827	16	42	0.75		
L-VG-P-1648-F	835	16	48	0.75		
L-VG-P-1654-F	902	16	54	0.75		
L-VG-P-1660-F	907	16	60	0.75		
L-VG-P-1666-F	970	16	66	0.75		
L-VG-P-1672-F	989	16	72	0.75		
L-VG-P-2024-F	711	20	24	0.75		
L-VG-P-2030-F	765	20	30	0.75		
L-VG-P-2036-F	861	20	36	0.75		
L-VG-P-2042-F	917	20	42	0.75		
L-VG-P-2048-F	922	20	48	0.75		
L-VG-P-2054-F	989	20	54	0.75		
L-VG-P-2060-F	1001	20	60	0.75		
L-VG-P-2066-F	1055	20	66	0.75		
L-VG-P-2072-F	1073	20	72	0.75		

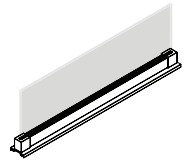

Acrylic Frameless Blade for Standard and Elevated Panels

What's Included:

One (1) acrylic piece, One (1) channel extrusion, Two (2) end caps, One (1) top trim

How to Specify:

Refer to metal finish card for metal finish options

Options:

Height: 8", 16"

Width: 24", 30", 36", 42", 48", 54", 60", 66", 72"

Clear, Frosted

Notes:

One (1) acrylic piece can span the width of one or two panels up to 72"W

Code	Price	H	W	D	Weight (lb.)	Volume (ft ³)
Acrylic screen - Frosted						
L-VA-P-0824-F	613	8	24	0.75		
L-VA-P-0830-F	649	8	30	0.75		
L-VA-P-0836-F	710	8	36	0.75		
L-VA-P-0842-F	761	8	42	0.75		
L-VA-P-0848-F	768	8	48	0.75		
L-VA-P-0854-F	829	8	54	0.75		
L-VA-P-0860-F	835	8	60	0.75		
L-VA-P-0866-F	893	8	66	0.75		
L-VA-P-0872-F	909	8	72	0.75		
L-VA-P-1624-F	668	16	24	0.75		
L-VA-P-1630-F	707	16	30	0.75		
L-VA-P-1636-F	773	16	36	0.75		
L-VA-P-1642-F	827	16	42	0.75		
L-VA-P-1648-F	835	16	48	0.75		
L-VA-P-1654-F	902	16	54	0.75		
L-VA-P-1660-F	907	16	60	0.75		
L-VA-P-1666-F	970	16	66	0.75		
L-VA-P-1672-F	989	16	72	0.75		

Code	Price	H	W	D	Weight (lb.)	Volume (ft ³)
Acrylic screen - Clear						
L-VA-P-0824-C	473	8	24	0.75		
L-VA-P-0830-C	500	8	30	0.75		
L-VA-P-0836-C	547	8	36	0.75		
L-VA-P-0842-C	585	8	42	0.75		
L-VA-P-0848-C	590	8	48	0.75		
L-VA-P-0854-C	637	8	54	0.75		
L-VA-P-0860-C	644	8	60	0.75		
L-VA-P-0866-C	694	16	66	0.75		
L-VA-P-0872-C	700	16	72	0.75		
L-VA-P-1624-C	513	16	24	0.75		
L-VA-P-1630-C	545	16	30	0.75		
L-VA-P-1636-C	595	16	36	0.75		
L-VA-P-1642-C	636	16	42	0.75		
L-VA-P-1648-C	644	16	48	0.75		
L-VA-P-1654-C	694	16	54	0.75		
L-VA-P-1660-C	698	16	60	0.75		
L-VA-P-1666-C	732	16	66	0.75		
L-VA-P-1672-C	761	16	72	0.75		

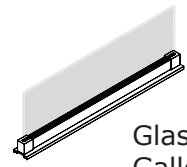

Glass Frameless Blade for Gallery Panels

What's Included:

One (1) tempered glass piece, One (1) accessory rail channel extrusion, Two (2) end caps

How to Specify:

Refer to metal finish card for metal finish options

Notes:

One (1) glass piece can span the width of one or two panels up to 72"W

Glass is tempered

Accessory rail channel extrusion can accommodate all Tayco accessories except for the paper sorter

Options:

Height: 8", 16"

Width: 24", 30", 36", 42", 48", 54", 60"

Clear, Frosted

Code	Price	H	W	D	Weight (lb.)	Volume (ft ³)
Glass screen - Frosted						
L-VG-Y-0824-F	697	8	24	0.75	5.0	0.08
L-VG-Y-0830-F	729	8	30	0.75	6.0	0.10
L-VG-Y-0836-F	790	8	36	0.75	7.0	0.13
L-VG-Y-0842-F	843	8	42	0.75	8.0	0.15
L-VG-Y-0848-F	848	8	48	0.75	10.0	0.17
L-VG-Y-0854-F	907	8	54	0.75	11.0	0.19
L-VG-Y-0860-F	913	8	60	0.75	12.0	0.21
L-VG-Y-1624-F	748	16	24	0.75	10.0	0.17
L-VG-Y-1630-F	788	16	30	0.75	12.0	0.21
L-VG-Y-1636-F	851	16	36	0.75	14.0	0.25
L-VG-Y-1642-F	906	16	42	0.75	17.0	0.29
L-VG-Y-1648-F	913	16	48	0.75	19.0	0.33
L-VG-Y-1654-F	979	16	54	0.75	22.0	0.38
L-VG-Y-1660-F	985	16	60	0.75	24.0	0.42

Code	Price	H	W	D	Weight (lb.)	Volume (ft ³)
Glass screen - Clear						
L-VG-Y-0824-C	603	8	30	0.75	6.0	0.10
L-VG-Y-0830-C	636	8	36	0.75	7.0	0.13
L-VG-Y-0836-C	697	8	42	0.75	8.0	0.15
L-VG-Y-0842-C	749	8	48	0.75	10.0	0.17
L-VG-Y-0848-C	755	8	54	0.75	11.0	0.19
L-VG-Y-0854-C	814	8	60	0.75	12.0	0.21
L-VG-Y-0860-C	819	16	24	0.75	10.0	0.17
L-VG-Y-1624-C	655	16	30	0.75	12.0	0.21
L-VG-Y-1630-C	694	16	36	0.75	14.0	0.25
L-VG-Y-1636-C	758	16	42	0.75	17.0	0.29
L-VG-Y-1642-C	813	16	48	0.75	19.0	0.33
L-VG-Y-1648-C	819	16	54	0.75	22.0	0.38
L-VG-Y-1654-C	885	16	60	0.75	24.0	0.42
L-VG-Y-1660-C	892	16	60	0.75	24.0	0.42

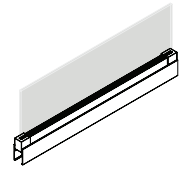

Acrylic Frameless Blade for Gallery Panels

What's Included:

One (1) acrylic piece, One (1) accessory rail channel extrusion, Two (2) end caps

How to Specify:

Refer to metal finish card for metal finish options

Notes:

One (1) acrylic piece can span the width of one or two panels up to 72"W

Accessory rail channel extrusion can accommodate all Tayco accessories except for the paper sorter

Options:

Height:	8", 16"
Width:	24", 30", 36", 42", 48", 54", 60"
Clear, Frosted	

Code	Price	H	W	D	Weight (lb.)	Volume (ft ³)
Acrylic screen - Frosted						
L-VA-Y-0824-F	697	8	24	0.75	4.0	0.08
L-VA-Y-0830-F	729	8	30	0.75	5.0	0.10
L-VA-Y-0836-F	790	8	36	0.75	5.0	0.13
L-VA-Y-0842-F	843	8	42	0.75	6.0	0.15
L-VA-Y-0848-F	848	8	48	0.75	7.0	0.17
L-VA-Y-0854-F	907	8	54	0.75	8.0	0.19
L-VA-Y-0860-F	913	8	60	0.75	9.0	0.21
L-VA-Y-1624-F	748	16	24	0.75	7.0	0.17
L-VA-Y-1630-F	788	16	30	0.75	9.0	0.21
L-VA-Y-1636-F	851	16	36	0.75	11.0	0.25
L-VA-Y-1642-F	906	16	42	0.75	13.0	0.29
L-VA-Y-1648-F	913	16	48	0.75	14.0	0.33
L-VA-Y-1654-F	979	16	54	0.75	16.0	0.38
L-VA-Y-1660-F	985	16	60	0.75	18.0	0.42

Code	Price	H	W	D	Weight (lb.)	Volume (ft ³)
Acrylic screen - Clear						
L-VA-Y-0824-C	603	8	24	0.75	4.0	0.08
L-VA-Y-0830-C	636	8	30	0.75	5.0	0.10
L-VA-Y-0836-C	697	8	36	0.75	5.0	0.13
L-VA-Y-0842-C	749	8	42	0.75	6.0	0.15
L-VA-Y-0848-C	755	8	48	0.75	7.0	0.17
L-VA-Y-0854-C	814	8	54	0.75	8.0	0.19
L-VA-Y-0860-C	819	8	60	0.75	9.0	0.21
L-VA-Y-1624-C	655	16	24	0.75	7.0	0.17
L-VA-Y-1630-C	694	16	30	0.75	9.0	0.21
L-VA-Y-1636-C	758	16	36	0.75	11.0	0.25
L-VA-Y-1642-C	813	16	42	0.75	13.0	0.29
L-VA-Y-1648-C	819	16	48	0.75	14.0	0.33
L-VA-Y-1654-C	885	16	54	0.75	16.0	0.38
L-VA-Y-1660-C	892	16	60	0.75	18.0	0.42

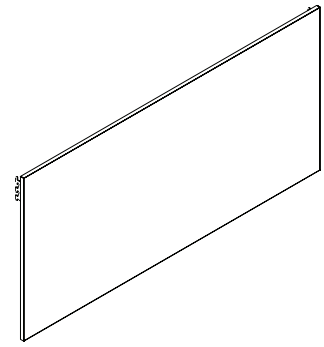

Panel Mounted Whiteboard

What's Included:

One (1) whiteboard, Two (2) slotted channel brackets

How to Specify:

Specify width of whiteboard to match the width of the panel
Choose White, Black, Silver, Charcoal for bracket color

Options:

Height: 15"

Width: 24", 30", 36", 42", 48", 54", 60"

Notes:

Panel Mounted Whiteboard is compatible with fabric and laminate panels only

Code	Price	H	W	D	Weight (lb.)	Volume (ft ³)
L-AWPO-1524	260	15	24	0.75	3.7	
L-AWPO-1530	291	15	30	0.75	4.9	
L-AWPO-1536	323	15	36	0.75	6.2	
L-AWPO-1542	353	15	42	0.75	7.5	
L-AWPO-1548	386	15	48	0.75	8.7	
L-AWPO-1554	419	15	54	0.75	10.0	
L-AWPO-1560	448	15	60	0.75	11.2	

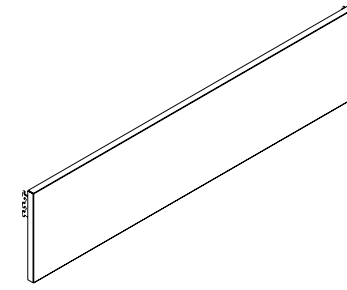

Panel Mounted Tackboard

What's Included:

One (1) tackboard, Two (2) slotted channel brackets

How to Specify:

Specify width of tackboard to match the width of the panel
Refer to panel fabric cards for fabric selections
Choose White, Black, Silver, Charcoal for bracket color

Options:

Height: 7", 15"

Width: 24", 30", 36", 42", 48", 54", 60"

Notes:

Panel Mounted Tackboard is compatible with fabric and laminate panels only

Code	Price	H	W	D	Weight (lb.)	Volume (ft ³)
L-ATPO-0724	165	7	24	0.75	1.9	
L-ATPO-0730	173	7	30	0.75	2.4	
L-ATPO-0736	183	7	36	0.75	3.1	
L-ATPO-0742	191	7	42	0.75	3.7	
L-ATPO-0748	197	7	48	0.75	4.4	
L-ATPO-0754	204	7	54	0.75	5.0	
L-ATPO-0760	211	7	60	0.75	5.6	
L-ATPO-1524	204	15	24	0.75	4.0	
L-ATPO-1530	222	15	30	0.75	4.9	
L-ATPO-1536	236	15	36	0.75	6.2	
L-ATPO-1542	251	15	42	0.75	7.5	
L-ATPO-1548	270	15	48	0.75	8.7	
L-ATPO-1554	284	15	54	0.75	10.0	
L-ATPO-1560	299	15	60	0.75	11.2	

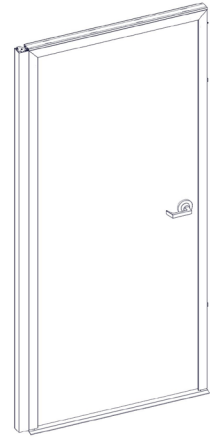

Hinged Door

What's Included:

Hinged Door laminate available in white and black

How to Specify:

Options:

Height: 82"

Width: 36", 42",

Left handed, Right handed

Straight connection, 90 degree connection, 3-way connection and 4-way connection

Notes:

Code	Price	H	W	D	Weight (lb.)	Volume (ft ³)
Straight connection						
L-PD00-8236-L	3222	82	36			
L-PD00-8236-R	3222	82	36			
L-PD00-8242-L	3283	82	42			
L-PD00-8242-R	3283	82	42			
3-way connection						
L-PD00-8236-L-3W	3847	82	36			
L-PD00-8236-R-3W	3847	82	36			
L-PD00-8242-L-3W	3908	82	42			
L-PD00-8242-R-3W	3908	82	42			
4-way connection						
L-PD00-8236-L-4W	3592	82	36			
L-PD00-8236-R-4W	3592	82	36			
L-PD00-8242-L-4W	3654	82	42			
L-PD00-8242-R-4W	3654	82	42			
90 degree connection						
L-PD00-8236-L-90	3662	82	36			
L-PD00-8236-R-90	3662	82	36			
L-PD00-8242-L-90	3723	82	42			
L-PD00-8242-R-90	3723	82	42			

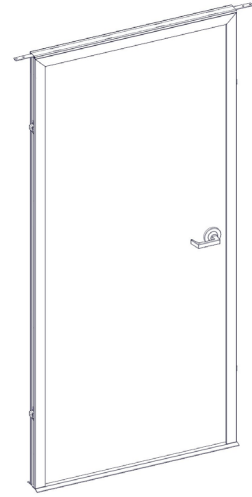

Sliding Door - Acrylic

What's Included:

Sliding door acrylic available in white and black

How to Specify:

Notes:

Options:

Height:	66"
Bracket Width:	30", 36", 42",
Door Width:	30", 36", 42", 48", 54", 60"
Left handed, Right handed	
Clear, Frosted, Fluted	

Code	Price	H	W	D	Weight (lb.)	Volume (ft ³)
Clear Acrylic - left hand						
L-PDSC-663030-L	2163	66	30			
L-PDSC-663036-L	2176	66	36			
L-PDSC-663042-L	2183	66	42			
L-PDSC-663048-L	2189	66	48			
L-PDSC-663054-L	2195	66	54			
L-PDSC-663060-L	2200	66	60			
L-PDSC-663636-L	2172	66	36			
L-PDSC-663642-L	2184	66	42			
L-PDSC-663648-L	2190	66	48			
L-PDSC-663654-L	2196	66	54			
L-PDSC-663660-L	2201	66	60			
L-PDSC-664242-L	2178	66	42			
L-PDSC-664248-L	2191	66	48			
L-PDSC-664254-L	2196	66	54			
L-PDSC-664260-L	2202	66	60			
Clear Acrylic - right hand						
L-PDSC-663030-R	2163	66	30			
L-PDSC-663036-R	2176	66	36			
L-PDSC-663042-R	2183	66	42			
L-PDSC-663048-R	2189	66	48			
L-PDSC-663054-R	2195	66	54			
L-PDSC-663060-R	#N/A	66	60			
L-PDSC-663636-R	2172	66	36			
L-PDSC-663642-R	2184	66	42			
L-PDSC-663648-R	2190	66	48			
L-PDSC-663654-R	2196	66	54			
L-PDSC-663660-R	2201	66	60			
L-PDSC-664242-R	2178	66	42			
L-PDSC-664248-R	2191	66	48			
L-PDSC-664254-R	2196	66	54			
L-PDSC-664260-R	2202	66	60			

Code	Price	H	W	D	Weight (lb.)	Volume (ft ³)
Frosted Acrylic - left hand						
L-PDSF-663030-L	2382	66	30			
L-PDSF-663036-L	2394	66	36			
L-PDSF-663042-L	2401	66	42			
L-PDSF-663048-L	2406	66	48			
L-PDSF-663054-L	2412	66	54			
L-PDSF-663060-L	2419	66	60			
L-PDSF-663636-L	2390	66	36			
L-PDSF-663642-L	2402	66	42			
L-PDSF-663648-L	2408	66	48			
L-PDSF-663654-L	2413	66	54			
L-PDSF-663660-L	2421	66	60			
L-PDSF-664242-L	2398	66	42			
L-PDSF-664248-L	2409	66	48			
L-PDSF-664254-L	2414	66	54			
L-PDSF-664260-L	2422	66	60			
Frosted Acrylic - right hand						
L-PDSF-663030-R	2382	66	30			
L-PDSF-663036-R	2394	66	36			
L-PDSF-663042-R	2401	66	42			
L-PDSF-663048-R	2406	66	48			
L-PDSF-663054-R	2412	66	54			
L-PDSF-663060-R	2419	66	60			
L-PDSF-663636-R	2390	66	36			
L-PDSF-663642-R	2402	66	42			
L-PDSF-663648-R	2408	66	48			
L-PDSF-663654-R	2413	66	54			
L-PDSF-663660-R	2421	66	60			
L-PDSF-664242-R	2398	66	42			
L-PDSF-664248-R	2409	66	48			
L-PDSF-664254-R	2414	66	54			
L-PDSF-664260-R	2422	66	60			

Code	Price	H	W	D	Weight (lb.)	Volume (ft ³)
Fluted acrylic - left hand						
L-PDSL-663030-L	2163	66	30			
L-PDSL-663036-L	2176	66	36			
L-PDSL-663042-L	2183	66	42			
L-PDSL-663048-L	2189	66	48			
L-PDSL-663054-L	2195	66	54			
L-PDSL-663060-L	2200	66	60			
L-PDSL-663636-L	2172	66	36			
L-PDSL-663642-L	2184	66	42			
L-PDSL-663648-L	2190	66	48			
L-PDSL-663654-L	2196	66	54			
L-PDSL-663660-L	2201	66	60			
L-PDSL-664242-L	2178	66	42			
L-PDSL-664248-L	2191	66	48			
L-PDSL-664254-L	2196	66	54			
L-PDSL-664260-L	2202	66	60			
Fluted acrylic - right hand						
L-PDSL-663030-R	2163	66	30			
L-PDSL-663036-R	2176	66	36			
L-PDSL-663042-R	2183	66	42			
L-PDSL-663048-R	2189	66	48			
L-PDSL-663054-R	2195	66	54			
L-PDSL-663060-R	2200	66	60			
L-PDSL-663636-R	2172	66	36			
L-PDSL-663642-R	2184	66	42			
L-PDSL-663648-R	2190	66	48			
L-PDSL-663654-R	2196	66	54			
L-PDSL-663660-R	2201	66	60			
L-PDSL-664242-R	2178	66	42			
L-PDSL-664248-R	2191	66	48			
L-PDSL-664254-R	2196	66	54			
L-PDSL-664260-R	2202	66	60			



Switch USA Pricebook
November 2024

Connections & Trims

Connections & Trims

2-Way Connection	118
3-Way T Connection	119
4-Way X Connection	120
Top Cap	121
Full Height End Trim	122
Partial Height End Trim	123
Full Height T Filler	124
Partial Height T Filler	125
90 Degree Filler-Full Height	126
90 Degree Filler- Partial Height	127
Straight Filler	128
Gallery Panel Filler	129
Adjustable Wall Connector	130

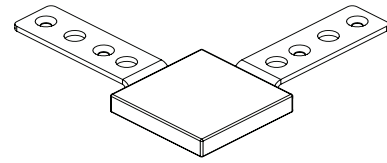

2-Way 90 degree Connection

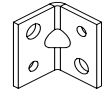

What's Included:

One (1) type A or type B straight or 90 degree connection bracket, accompanying screws

How to Specify:

Refer to page X for connection type application guide

Code	Price	H	W	D	Weight (lb.)	Volume (ft ³)
2-Way Straight Connection						
L-HC2W-180-A	21	1	2	3	0.0	0.00
L-HC2W-180-B	18	1	2	3	0.0	0.00
2-Way 90 degree Connection						
L-HC2W-90-A	49	1	2	3	0.0	0.00
L-HC2W-90-B	49	1	2	3	0.0	0.00

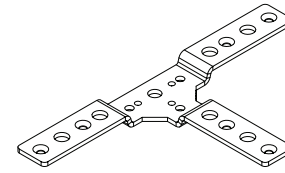

L-HC3W-A

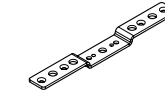

L-HC3W-B

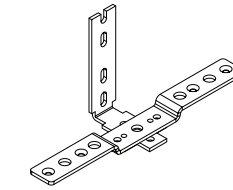

L-HC3W-C

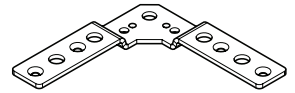

L-HC3W-D

What's Included:

One (1) type A or type B straight or 90 degree connection bracket, accompanying screws

How to Specify:

Refer to page X for connection type application guide

Notes:

Code	Price	H	W	D	Weight (lb.)	Volume (ft ³)
3 Way T Connectors						
L-HC3W-A	85	1	2	3	0.0	0.00
L-HC3W-B	111	1	2	3	0.0	0.00
L-HC3W-C	81	1	2	3	0.0	0.00
L-HC3W-D	104	1	2	3	0.0	0.00

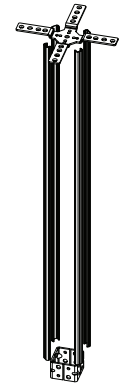

L-HC4W-A

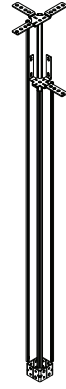

L-HC4W-B

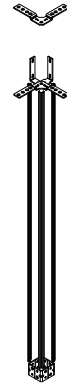

L-HC4W-C

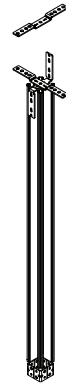

L-HC4W-D

What's Included:

One (1) type A, B, C or D 4-Way X connection bracket, accompanying screws

How to Specify:

Refer to page X for connection type application guide

Notes:

Code	Price	H	W	D	Weight (lb.)	Volume (ft ³)
4 way connectors						
L-HC4W-A	137	1	2	3	0.0	0.00
L-HC4W-B	173	1	2	3	0.0	0.00
L-HC4W-C	155	1	2	3	0.0	0.00
L-HC4W-D	161	1	2	3	0.0	0.00

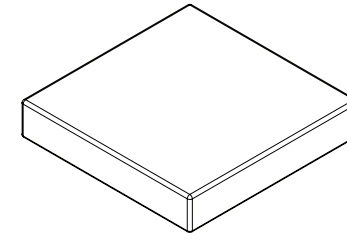

What's Included:

One (1) Top Cap

How to Specify:

Choose White, Black, Silver, Charcoal for Top Cap

Options:

Width: 2"

Depth: 2"

Notes:

Code	Price	H	W	D	Weight (lb.)	Volume (ft ³)
L-HUFC-02	9	1	2	2	0.0	0.00

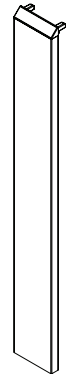

Standard

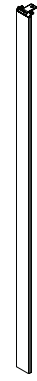

with coat hook

What's Included:

One (1) Full Height End Trim

How to Specify:

Choose White, Black, Silver, Charcoal for Full Height End Trim Colour

Options:

Height: 34", 42", 50", 66", 82"

Width: 2"

Standard, Coat Hook

Notes:

Code	Price	H	W	D	Weight (lb.)	Volume (ft ³)
standard						
L-HETF-34	55	34	2	1	0.7	0.04
L-HETF-42	64	42	2	1	0.8	0.05
L-HETF-50	75	50	2	1	1.0	0.06
L-HETF-66	90	66	2	1	1.3	0.08
L-HETF-82	179	82	2	2	1.3	0.19
with coat hook						
L-HETF-34-CH	71	34	2	1	0.7	0.04
L-HETF-42-CH	82	42	2	1	0.8	0.05
L-HETF-50-CH	98	50	2	1	1.0	0.06
L-HETF-66-CH	119	66	2	1	1.3	0.08



What's Included:

One (1) Partial Height End Trim

How to Specify:

Choose White, Black, Silver, Charcoal for Partial Height End Trim Colour

Options:

Height: 8", 16", 24", 32", 40", 48"

Width: 2"

Notes:

Code	Price	H	W	D	Weight (lb.)	Volume (ft ³)
L-HETP-08	44	8	2	1	0.2	0.01
L-HETP-16	49	16	2	1	0.3	0.02
L-HETP-24	64	24	2	1	0.5	0.03
L-HETP-32	77	32	2	1	0.6	0.04
L-HETP-40	135	40	2	1	0.7	0.05
L-HETP-48	147	48	2	1	0.8	0.06



Full Height T Filler

What's Included:

One (1) Full Height T Filler

How to Specify:

Choose White, Black, Silver, Charcoal for Full Height T Filler

Options:

Height: 34", 42", 50", 66", 82"
 Width: 2"

Notes:

Code	Price	H	W	D	Weight (lb.)	Volume (ft ³)
L-HFTR-34	196	34	2	1	0.7	0.04
L-HFTR-42	196	42	2	1	0.8	0.05
L-HFTR-50	203	50	2	1	1.0	0.06
L-HFTR-66	203	66	2	1	1.3	0.08
L-HFTR-82	338	82	2	1	1.6	0.09

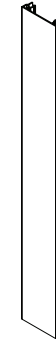

Partial Height T Filler

What's Included:

One (1) Partial Height T Filler

How to Specify:

Choose White, Black, Silver, Charcoal for Partial Height T Filler

Options:

Height: 8", 16", 24", 32", 40", 48"
 Width: 2"

Notes:

Code	Price	H	W	D	Weight (lb.)	Volume (ft ³)
L-HFTP-08	149	8	2	1	0.2	0.01
L-HFTP-16	149	16	2	1	0.3	0.02
L-HFTP-24	157	24	2	1	0.5	0.03
L-HFTP-32	157	32	2	1	0.6	0.04
L-HFTP-40	216	40	2	1	0.7	0.05

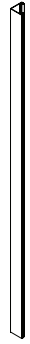

Full Height 90 Degree Filler

What's Included:

One (1) Full Height 90 Degree Filler

How to Specify:

Choose White, Black, Silver, Charcoal for Full Height 90 Degree Filler

Options:

Height: 34", 42", 50", 66", 82"
 Width: 2"

Notes:

Code	Price	H	W	D	Weight (lb.)	Volume (ft ³)
L-HFNR-34	160	34	2	1	0.7	0.04
L-HFNR-42	170	42	2	1	0.7	0.05
L-HFNR-50	181	50	2	1	1.0	0.06
L-HFNR-66	194	66	2	1	1.3	0.08
L-HFNR-82	338	82	2	1	1.6	0.09



Partial Height 90 Degree Filler

What's Included:

One (1) Partial Height 90 Degree Filler

How to Specify:

Choose White, Black, Silver, Charcoal for Partial Height 90 Degree Filler

Options:

Height: 8", 16", 24", 32", 40", 48"
 Width: 2"

Notes:

Code	Price	H	W	D	Weight (lb.)	Volume (ft ³)
L-HFNP-08	66	8	2	1	0.2	0.01
L-HFNP-16	115	16	2	1	0.3	0.02
L-HFNP-24	125	24	2	1	0.5	0.03
L-HFNP-32	171	32	2	1	0.6	0.04
L-HFNP-40	216	40	2	1	0.7	0.05
L-HFNP-48	234	48	2	1	0.8	0.05

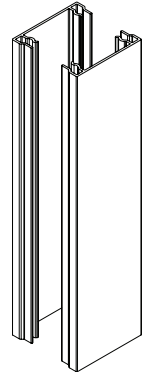

What's Included:

Partial Height Straight Filler

How to Specify:

Choose White, Black, Silver, Charcoal for Partial Height Straight Filler

Options:

Height: 8", 16", 24", 32", 40", 48"
 Width: 2"

Notes:

Code	Price	H	W	D	Weight (lb.)	Volume (ft ³)
L-HFSP-08	49	8	2	1	0.2	0.01
L-HFSP-16	83	16	2	1	0.3	0.02
L-HFSP-24	91	24	2	1	0.5	0.03
L-HFSP-32	94	32	2	1	0.6	0.04
L-HFSP-40	216	40	2	1	0.8	0.05
L-HFSP-48	234	48	2	1	1.0	0.06

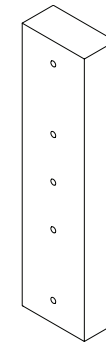

Partial Height Gallery Panel Filler

What's Included:

One (1) Partial Height Gallery Panel Filler

How to Specify:

Gallery Panel Filler matches laminate finish chosen on Gallery Panel

Options:

Height: 8", 16", 24", 32", 40", 48"
 Width: 2"
 Thickness: 1"

Notes:

Code	Price	H	W	D	Weight (lb.)	Volume (ft ³)
L-HYP-08	77	8	1	1	0.1	0.00
L-HYP-16	81	16	1	1	0.2	0.01
L-HYP-24	102	24	1	1	0.2	0.01
L-HYP-32	125	32	1	1	0.3	0.02
L-HYP-40	216	40	1	1	0.4	0.03
L-HYP-48	234	48	1	1	0.6	0.04



138



mount 4



mount 6

Code	Price	H	W	D	Weight (lb.)	Volume (ft ³)
mount 2						
L-HW2-34	142	34	2	2	1.4	0.08
L-HW2-42	165	42	2	2	1.7	0.10
L-HW2-50	192	50	2	2	2.0	0.12
L-HW2-66	237	66	2	2	2.6	0.15
L-HW2-82	289	82	2	2	3.2	0.18
mount 4						
L-HW4-34	159	34	2	4	2.7	0.16
L-HW4-42	185	42	2	4	3.4	0.19
L-HW4-50	208	50	2	4	4.0	0.23
L-HW4-66	258	66	2	4	5.3	0.31
L-HW4-82	315	82	2	4	6.6	0.40
mount 6						
L-HW6-34	181	34	2	6	4.1	0.24
L-HW6-42	203	42	2	6	5.0	0.29
L-HW6-50	228	50	2	6	6.0	0.35
L-HW6-66	275	66	2	6	7.9	0.46
L-HW6-82	338	82	2	6	9.8	0.57



What's Included:

Spline for Switch panels

How to Specify:

Specify black, white, silver or charcoal

Notes:

Splines are sold in pairs and will come in 82"H lengths that can be cut to size on-site.

All 2-way 90 degree, 3-way T, and 4-way X connections will still come automatically with the splines.

Code	Price	H	W	D	Weight (lb.)	Volume (ft ³)
L-XSPL-S-82	206	82				



Switch USA Pricebook
November 2024

Worksurfaces

Worksurface

<u>Straight /w grommet</u>	134
<u>Straight Worksurface w/o Grommet</u>	136
<u>Straight Worksurface w/ Wire Play</u>	140
<u>5-Sided w Grommet</u>	144
<u>Straight Worksurface with Wire Play</u>	146
<u>Unitized w/ Grommet</u>	148
<u>Unitized w/ Wire Play</u>	150
<u>Transaction Top</u>	152

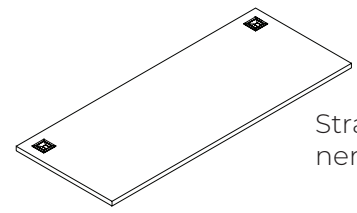

Straight Workspace with Grommet5-Sided Corner

What's Included:

- One (1) workspace
- 24"-48" - One (1) grommet cover for centre grommet
- 54"-96" - Two (2) grommet covers for grommet on each end

Notes:

- 24"-48" - One (1) grommet hole in the centre of the workspace
- 54"-96" - Two (2) grommet holes on each end of the workspace

How to Specify:

Refer to laminate card for laminate options

Options:

Width:	24", 30", 36", 42", 48", 54", 60", 66", 72", 78", 84", 90", 96"
Depth:	20", 24", 30"
Thickness:	1"

Code	Price	H	W	D	Weight (lb.)	Volume (ft³)
L-WS0G-2420	260	24	20	1	9.6	0.28
L-WS0G-3020	299	30	20	1	12.0	0.35
L-WS0G-3620	308	36	20	1	14.4	0.42
L-WS0G-4220	348	42	20	1	16.8	0.49
L-WS0G-4820	371	48	20	1	19.2	0.56
L-WS0G-5420	471	54	20	1	21.6	0.62
L-WS0G-6020	489	60	20	1	24.0	0.69
L-WS0G-6620	547	66	20	1	26.4	0.76
L-WS0G-7220	573	72	20	1	28.8	0.83
L-WS0G-7820	622	78	20	1	31.2	0.90
L-WS0G-8420	663	84	20	1	33.6	0.97
L-WS0G-9020	762	90	20	1	36.0	1.04
L-WS0G-9620	796	96	20	1	38.4	1.11
L-WS0G-2424	260	24	24	1	11.5	0.33

Code	Price	H	W	D	Weight (lb.)	Volume (ft³)
L-WS0G-3024	299	30	24	1	14.4	0.42
L-WS0G-3624	308	36	24	1	17.3	0.50
L-WS0G-4224	348	42	24	1	20.2	0.58
L-WS0G-4824	371	48	24	1	23.0	0.67
L-WS0G-5424	471	54	24	1	25.9	0.75
L-WS0G-6024	489	60	24	1	28.8	0.83
L-WS0G-6624	547	66	24	1	31.7	0.92
L-WS0G-7224	573	72	24	1	34.6	1.00
L-WS0G-7824	622	78	24	1	37.4	1.08
L-WS0G-8424	663	84	24	1	40.3	1.17
L-WS0G-9024	762	90	24	1	43.2	1.25
L-WS0G-9624	796	96	24	1	46.1	1.33
L-WS0G-2430	299	24	30	1	14.4	0.42
L-WS0G-3030	348	30	30	1	18.0	0.52
L-WS0G-3630	373	36	30	1	21.6	0.62
L-WS0G-4230	407	42	30	1	25.2	0.73
L-WS0G-4830	439	48	30	1	28.8	0.83
L-WS0G-5430	489	54	30	1	32.4	0.94
L-WS0G-6030	519	60	30	1	36.0	1.04
L-WS0G-6630	590	66	30	1	39.6	1.15
L-WS0G-7230	608	72	30	1	43.2	1.25
L-WS0G-7830	661	78	30	1	46.8	1.35
L-WS0G-8430	712	84	30	1	50.4	1.46
L-WS0G-9030	845	90	30	1	54.0	1.56
L-WS0G-9630	876	96	30	1	57.6	1.67

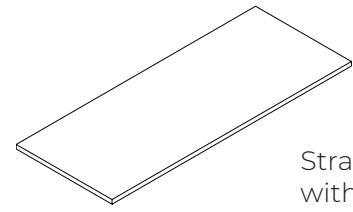

Straight Worksurface without Full Depth without Grommet

What's Included:

One (1) worksurface

How to Specify:

Refer to laminate card for laminate options

Notes:

Worksurface is full depth to sit flush against panel with no grommet

Options:

Width:	24", 30", 36", 42", 48", 54", 60", 66", 72", 78", 84", 90", 96"
Depth:	20", 24", 30"
Thickness:	1"

Code	Price	Height	Depth	Thickness	Weight (lb.)	Volume (ft ³)
Straight Worksurface without Full Depth without Grommet						
L-WS00-2320	222	23	20	1	9.2	0.27
L-WS00-2420	222	24	20	1	9.6	0.28
L-WS00-2920	270	29	20	1	11.6	0.34
L-WS00-3020	270	30	20	1	12.0	0.35
L-WS00-3520	285	35	20	1	14.0	0.41
L-WS00-3620	285	36	20	1	14.4	0.42
L-WS00-4120	315	41	20	1	16.4	0.47
L-WS00-4220	315	42	20	1	16.8	0.49
L-WS00-4720	348	47	20	1	18.8	0.54
L-WS00-4820	348	48	20	1	19.2	0.56
L-WS00-5320	425	53	20	1	21.2	0.61

Code	Price	Height	Depth	Thickness	Weight (lb.)	Volume (ft ³)
L-WS00-5420	425	54	20	1	21.6	0.62
L-WS00-5920	425	59	20	1	23.6	0.68
L-WS00-6020	425	60	20	1	24.0	0.69
L-WS00-6520	480	65	20	1	26.0	0.75
L-WS00-6620	480	66	20	1	26.4	0.76
L-WS00-7120	521	71	20	1	28.4	0.82
L-WS00-7220	521	72	20	1	28.8	0.83
L-WS00-7620	552	76	20	1	30.4	0.88
L-WS00-7720	552	77	20	1	30.8	0.89
L-WS00-7820	552	78	20	1	31.2	0.90
L-WS00-8220	600	82	20	1	32.8	0.95
L-WS00-8320	600	83	20	1	33.2	0.96
L-WS00-8420	600	84	20	1	33.6	0.97
L-WS00-8820	630	88	20	1	35.2	1.02
L-WS00-8920	630	89	20	1	35.6	1.03
L-WS00-9020	630	90	20	1	36.0	1.04
L-WS00-9420	694	94	20	1	37.6	1.09
L-WS00-9520	694	95	20	1	38.0	1.10
L-WS00-9620	694	96	20	1	38.4	1.11
L-WS00-2324	222	23	24	1	11.0	0.32
L-WS00-2424	222	24	24	1	11.5	0.33
L-WS00-2924	270	29	24	1	13.9	0.40
L-WS00-3024	270	30	24	1	14.4	0.42
L-WS00-3524	285	35	24	1	16.8	0.49
L-WS00-3624	285	36	24	1	17.3	0.50
L-WS00-4124	315	41	24	1	19.7	0.57

[2 of 4] continued on next page

Worksurface continued [3 of 4]

Code	Price	Height	Depth	Thickness	Weight (lb.)	Volume (ft ³)
L-WS00-4224	315	42	24	1	20.2	0.58
L-WS00-4724	348	47	24	1	22.6	0.65
L-WS00-4824	348	48	24	1	23.0	0.67
L-WS00-5324	425	53	24	1	25.4	0.74
L-WS00-5424	425	54	24	1	25.9	0.75
L-WS00-5924	425	59	24	1	28.3	0.82
L-WS00-6024	425	60	24	1	28.8	0.83
L-WS00-6524	480	65	24	1	31.2	0.90
L-WS00-6624	480	66	24	1	31.7	0.92
L-WS00-7124	521	71	24	1	34.1	0.99
L-WS00-7224	521	72	24	1	34.6	1.00
L-WS00-7624	552	76	24	1	36.5	1.06
L-WS00-7724	552	77	24	1	37.0	1.07
L-WS00-7824	552	78	24	1	37.4	1.08
L-WS00-8224	600	82	24	1	39.4	1.14
L-WS00-8324	600	83	24	1	39.8	1.15
L-WS00-8424	600	84	24	1	40.3	1.17
L-WS00-8824	630	88	24	1	42.2	1.22
L-WS00-8924	630	89	24	1	42.7	1.24
L-WS00-9024	630	90	24	1	43.2	1.25
L-WS00-9424	694	94	24	1	45.1	1.31
L-WS00-9524	694	95	24	1	45.6	1.32
L-WS00-9624	694	96	24	1	46.1	1.33
L-WS00-2330	270	23	30	1	13.8	0.40
L-WS00-2430	270	24	30	1	14.4	0.42
L-WS00-2930	315	29	30	1	17.4	0.50

Worksurface continued [4 of 4]

Code	Price	Height	Depth	Thickness	Weight (lb.)	Volume (ft ³)
L-WS00-3030	315	30	30	1	18.0	0.52
L-WS00-3530	352	35	30	1	21.0	0.61
L-WS00-3630	352	36	30	1	21.6	0.62
L-WS00-4130	384	41	30	1	24.6	0.71
L-WS00-4230	384	42	30	1	25.2	0.73
L-WS00-4730	415	47	30	1	28.2	0.82
L-WS00-4830	415	48	30	1	28.8	0.83
L-WS00-5330	471	53	30	1	31.8	0.92
L-WS00-5430	471	54	30	1	32.4	0.94
L-WS00-5930	496	59	30	1	35.4	1.02
L-WS00-6030	496	60	30	1	36.0	1.04
L-WS00-6530	570	65	30	1	39.0	1.13
L-WS00-6630	570	66	30	1	39.6	1.15
L-WS00-7130	584	71	30	1	42.6	1.23
L-WS00-7230	584	72	30	1	43.2	1.25
L-WS00-7630	637	76	30	1	45.6	1.32
L-WS00-7730	637	77	30	1	46.2	1.34
L-WS00-7830	637	78	30	1	46.8	1.35
L-WS00-8230	693	82	30	1	49.2	1.42
L-WS00-8330	693	83	30	1	49.8	1.44
L-WS00-8430	693	84	30	1	50.4	1.46
L-WS00-8830	790	88	30	1	52.8	1.53
L-WS00-8930	790	89	30	1	53.4	1.55
L-WS00-9030	790	90	30	1	54.0	1.56
L-WS00-9430	857	94	30	1	56.4	1.63
L-WS00-9530	857	95	30	1	57.0	1.65
L-WS00-9630	857	96	30	1	57.6	1.67

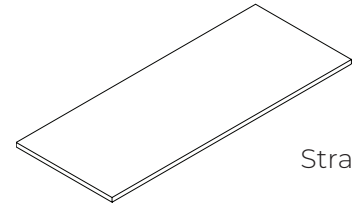

Straight Workspace with 1" Wire Play

What's Included:

One (1) workspace

How to Specify:

Refer to laminate card for laminate options

Notes:

Workspace sits 1" from the panel to allow for wire routing. No grommet is included with this workspace

Options:

Width: 23", 24", 29", 30", 35", 36", 41", 42", 47", 48", 53", 54", 59", 60", 65", 66", 71", 72", 77", 78", 83", 84", 89", 90", 95", 96"

Depth: 19", 20", 23", 24", 29", 30"

Thickness: 1"

Code	Price	Height	Depth	Thickness	Weight (lb.)	Volume (ft ³)
Straight Workspace with 1" Wire Play						
L-WS00-2319	222	23	19	1	8.7	0.25
L-WS00-2419	222	24	19	1	9.1	0.26
L-WS00-2919	270	29	19	1	11.0	0.32
L-WS00-3019	270	30	19	1	11.4	0.33
L-WS00-3519	285	35	19	1	13.3	0.38
L-WS00-3619	285	36	19	1	13.7	0.40
L-WS00-4119	315	41	19	1	15.6	0.45
L-WS00-4219	315	42	19	1	16.0	0.46
L-WS00-4719	348	47	19	1	17.9	0.52
L-WS00-4819	348	48	19	1	18.2	0.53
L-WS00-5319	425	53	19	1	20.1	0.58
L-WS00-5419	425	54	19	1	20.5	0.59

Code	Price	Height	Depth	Thickness	Weight (lb.)	Volume (ft ³)
L-WS00-5919	425	59	19	1	22.4	0.65
L-WS00-6019	425	60	19	1	22.8	0.66
L-WS00-6519	480	65	19	1	24.7	0.71
L-WS00-6619	480	66	19	1	25.1	0.73
L-WS00-7119	521	71	19	1	27.0	0.78
L-WS00-7219	521	72	19	1	27.4	0.79
L-WS00-7619	552	76	19	1	28.9	0.84
L-WS00-7719	552	77	19	1	29.3	0.85
L-WS00-7819	552	78	19	1	29.6	0.86
L-WS00-8219	600	82	19	1	31.2	0.90
L-WS00-8319	600	83	19	1	31.5	0.91
L-WS00-8419	600	84	19	1	31.9	0.92
L-WS00-8819	630	88	19	1	33.4	0.97
L-WS00-8919	630	89	19	1	33.8	0.98
L-WS00-9019	630	90	19	1	34.2	0.99
L-WS00-9419	694	94	19	1	35.7	1.03
L-WS00-9519	694	95	19	1	36.1	1.04
L-WS00-9619	694	96	19	1	36.5	1.06
L-WS00-2323	222	23	23	1	10.6	0.31
L-WS00-2423	222	24	23	1	11.0	0.32
L-WS00-2923	270	29	23	1	13.3	0.39
L-WS00-3023	270	30	23	1	13.8	0.40
L-WS00-3523	285	35	23	1	16.1	0.47
L-WS00-3623	285	36	23	1	16.6	0.48
L-WS00-4123	315	41	23	1	18.9	0.55
L-WS00-4223	315	42	23	1	19.3	0.56
L-WS00-4723	348	47	23	1	21.6	0.63

[2 of 4] continued on next page

Worksurface continued [3 of 4]

Code	Price	Height	Depth	Thickness	Weight (lb.)	Volume (ft ³)
L-WS00-4823	348	48	23	1	22.1	0.64
L-WS00-5323	425	53	23	1	24.4	0.71
L-WS00-5423	425	54	23	1	24.8	0.72
L-WS00-5923	425	59	23	1	27.1	0.79
L-WS00-6023	425	60	23	1	27.6	0.80
L-WS00-6523	480	65	23	1	29.9	0.87
L-WS00-6623	480	66	23	1	30.4	0.88
L-WS00-7123	521	71	23	1	32.7	0.95
L-WS00-7223	521	72	23	1	33.1	0.96
L-WS00-7623	552	76	23	1	35.0	1.01
L-WS00-7723	552	77	23	1	35.4	1.02
L-WS00-7823	552	78	23	1	35.9	1.04
L-WS00-8223	600	82	23	1	37.7	1.09
L-WS00-8323	600	83	23	1	38.2	1.10
L-WS00-8423	600	84	23	1	38.6	1.12
L-WS00-8823	630	88	23	1	40.5	1.17
L-WS00-8923	630	89	23	1	40.9	1.18
L-WS00-9023	630	90	23	1	41.4	1.20
L-WS00-9423	694	94	23	1	43.2	1.25
L-WS00-9523	694	95	23	1	43.7	1.26
L-WS00-9623	694	96	23	1	44.2	1.28
L-WS00-2329	270	23	29	1	13.3	0.39
L-WS00-2429	270	24	29	1	13.9	0.40
L-WS00-2929	315	29	29	1	16.8	0.49
L-WS00-3029	315	30	29	1	17.4	0.50
L-WS00-3529	352	35	29	1	20.3	0.59
L-WS00-3629	352	36	29	1	20.9	0.60
L-WS00-4129	384	41	29	1	23.8	0.69

Worksurface continued [4 of 4]

Code	Price	Height	Depth	Thickness	Weight (lb.)	Volume (ft ³)
L-WS00-4229	384	42	29	1	24.4	0.70
L-WS00-4729	415	47	29	1	27.3	0.79
L-WS00-4829	415	48	29	1	27.8	0.81
L-WS00-5329	471	53	29	1	30.7	0.89
L-WS00-5429	471	54	29	1	31.3	0.91
L-WS00-5929	496	59	29	1	34.2	0.99
L-WS00-6029	496	60	29	1	34.8	1.01
L-WS00-6529	570	65	29	1	37.7	1.09
L-WS00-6629	570	66	29	1	38.3	1.11
L-WS00-7129	584	71	29	1	41.2	1.19
L-WS00-7229	584	72	29	1	41.8	1.21
L-WS00-7629	637	76	29	1	44.1	1.28
L-WS00-7729	637	77	29	1	44.7	1.29
L-WS00-7829	637	78	29	1	45.2	1.31
L-WS00-8229	693	82	29	1	47.6	1.38
L-WS00-8329	693	83	29	1	48.1	1.39
L-WS00-8429	693	84	29	1	48.7	1.41
L-WS00-8829	790	88	29	1	51.0	1.48
L-WS00-8929	790	89	29	1	51.6	1.49
L-WS00-9029	790	90	29	1	52.2	1.51
L-WS00-9429	857	94	29	1	54.5	1.58
L-WS00-9529	857	95	29	1	55.1	1.59
L-WS00-9629	857	96	29	1	55.7	1.61

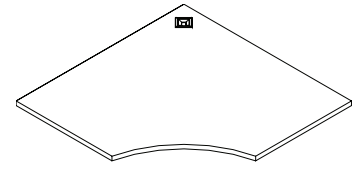

Curved 5-Sided Workspace with Grommet

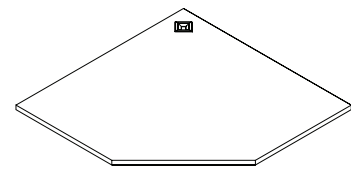

Straight 5-Sided Workspace with Grommet

What's Included:

One (1) workspace, One (1) grommet

How to Specify:

Refer to laminate card for laminate options

Notes:

Workspace sits 1" from the panel to allow for wire routing. No grommet is included with this workspace

Surface has a curved front

Options:

Side A*:	36", 42", 48"
Side B:	24", 30"
Thickness:	1"
Straight, Curved Front	
Grommet Type & Colour: Square (Silver, Black, White), Oval (Silver, Black)	

*36" on side A only available in 24" on side B

Code	Price	Height	Depth	Thickness	Weight (lb.)	Volume (ft ³)
curved front with grommet						
L-W5CG-3624	456	36	24	1	30.0	0.50
L-W5CG-4224	551	42	24	1	33.0	0.58
L-W5CG-4824	661	48	24	1	36.0	0.67
L-W5CG-4230	551	42	30	1	35.0	0.73
L-W5CG-4830	661	48	30	1	38.0	0.83
straight front with grommet						
L-W5SG-3624	456	36	24	1	30.0	0.50
L-W5SG-4224	551	42	24	1	33.0	0.58
L-W5SG-4824	661	48	24	1	36.0	0.67
L-W5SG-4230	551	42	30	1	35.0	0.73
L-W5SG-4830	661	48	30	1	38.0	0.83

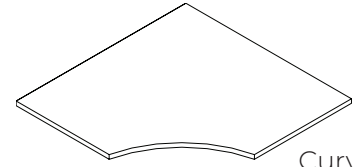

Curved 5-Sided Workspace with 1" Wire Play

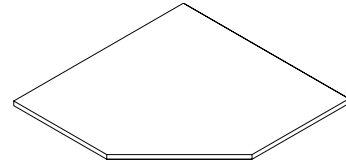

Straight 5-Sided Workspace with 1" Wire Play

What's Included:

One (1) workspace

How to Specify:

Refer to laminate card for laminate options

Options:

Side A & C*: 35", 36", 41", 42", 47", 48"

Side B & D: 23", 24", 29", 30"

Thickness: 1"

Straight, Curved Front

*35" & 36" on side A & C only available in 23" & 24" on side B & D

Notes:

Workspace sits 1" from the panel to allow for wire routing. No grommet is included with this workspace

Code	Price	Height	Depth	Thickness	Weight (lb.)	Volume (ft ³)
Left hand curved front						
L-W5C0-3624-L	456	36	24	1	30.0	0.50
L-W5C0-4224-L	551	42	24	1	33.0	0.58
L-W5C0-4824-L	661	48	24	1	36.0	0.67
L-W5C0-4230-L	551	42	30	1	35.0	0.73
L-W5C0-4830-L	661	48	30	1	38.0	0.83
Right hand curved front						
L-W5C0-3624-R	456	36	24	1	30.0	0.50
L-W5C0-4224-R	551	42	24	1	33.0	0.58
L-W5C0-4824-R	661	48	24	1	36.0	0.67
L-W5C0-4230-R	551	42	30	1	35.0	0.73
L-W5C0-4830-R	661	48	30	1	38.0	0.83
Double curved front						
L-W5C0-3523-D	456	35	23	1	30.0	0.47
L-W5C0-4123-D	551	41	23	1	33.0	0.55
L-W5C0-4723-D	661	47	23	1	36.0	0.63
L-W5C0-4129-D	551	41	29	1	35.0	0.69
L-W5C0-4729-D	661	47	29	1	38.0	0.79

Code	Price	Height	Depth	Thickness	Weight (lb.)	Volume (ft ³)
Left hand straight front						
L-W5S0-3624-L	456	36	24	1	30.0	0.50
L-W5S0-4224-L	551	42	24	1	33.0	0.58
L-W5S0-4824-L	661	48	24	1	36.0	0.67
L-W5S0-4230-L	551	42	30	1	35.0	0.73
L-W5S0-4830-L	661	48	30	1	38.0	0.83
Right hand straight front						
L-W5S0-3624-R	456	36	24	1	30.0	0.50
L-W5S0-4224-R	551	42	24	1	33.0	0.58
L-W5S0-4824-R	661	48	24	1	36.0	0.67
L-W5S0-4230-R	551	42	30	1	35.0	0.73
L-W5S0-4830-R	661	48	30	1	38.0	0.83
Double straight front						
L-W5S0-3523-D	456	35	23	1	30.0	0.47
L-W5S0-4123-D	551	41	23	1	33.0	0.55
L-W5S0-4723-D	661	47	23	1	36.0	0.63
L-W5S0-4129-D	551	41	29	1	35.0	0.69
L-W5S0-4729-D	661	47	29	1	38.0	0.79

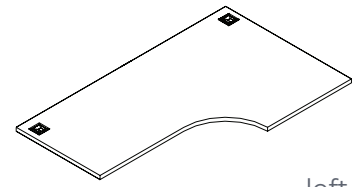

left hand shown with grommet

What's Included:

One (1) workspace, Two(2) grommets

How to Specify:

Refer to laminate card for laminate options

Notes:

Surface has a curved front

Options:

Side A:	36"
Side B:	24"
Side C:	54", 60", 66", 72", 78", 84", 90", 96"
Thickness:	1"
Left Hand, Right Hand	
Grommet Type & Color: Square (Silver, Black, White), Oval (Silver, Black)	

Code	Price	Height	Depth	Thickness	Weight (lb.)	Volume (ft ³)
Left hand with grommet						
L-WUCG-543624-L	657	54	36	1	24.9	1.12
L-WUCG-603624-L	694	60	36	1	26.9	1.25
L-WUCG-663624-L	769	66	36	1	28.9	1.38
L-WUCG-723624-L	817	72	36	1	30.9	1.50
L-WUCG-783624-L	883	78	36	1	32.9	1.62
L-WUCG-843624-L	943	84	36	1	34.9	1.75
L-WUCG-903624-L	1086	90	36	1	36.9	1.88
L-WUCG-963624-L	1137	96	36	1	38.9	2.00
Right hand with grommet						
L-WUCG-543624-R	657	54	36	1	24.9	1.12
L-WUCG-603624-R	694	60	36	1	26.9	1.25
L-WUCG-663624-R	769	66	36	1	28.9	1.38
L-WUCG-723624-R	817	72	36	1	30.9	1.50
L-WUCG-783624-R	883	78	36	1	32.9	1.62
L-WUCG-843624-R	943	84	36	1	34.9	1.75
L-WUCG-903624-R	1086	90	36	1	36.9	1.88
L-WUCG-963624-R	1137	96	36	1	38.9	2.00

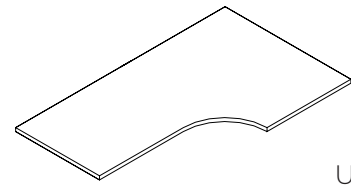

Unitized Workspace with 1" Wire Play

What's Included:

One (1) workspace

How to Specify:

Refer to laminate card for laminate options

Notes:

Workspace sits 1" from the panel to allow for wire routing. No grommet is included with this workspace

Surface has a curved front

Options:

Side A:	53", 54", 59", 60", 65", 66", 71", 72", 77", 78", 83", 84", 89", 90", 95", 96"
Side B:	23", 24"
Side C:	35", 36"
Side D:	23", 24"

Code	Price	Height	Depth	Thickness	Weight (lb)	Volume (ft ³)
Left hand						
L-WUC0-543524-L	657	54	35	1	24.9	1.09
L-WUC0-603524-L	694	60	35	1	26.9	1.22
L-WUC0-663524-L	769	66	35	1	28.9	1.34
L-WUC0-723524-L	817	72	35	1	30.9	1.46
L-WUC0-783524-L	883	78	35	1	32.9	1.58
L-WUC0-843524-L	943	84	35	1	34.9	1.70
L-WUC0-903524-L	1086	90	35	1	36.9	1.82
L-WUC0-963524-L	1137	96	35	1	38.9	1.94
L-WUC0-533624-L	657	53	36	1	24.9	1.10
L-WUC0-593624-L	694	59	36	1	26.9	1.23
L-WUC0-653624-L	769	65	36	1	28.9	1.35
L-WUC0-713624-L	817	71	36	1	30.9	1.48
L-WUC0-773624-L	883	77	36	1	32.9	1.60
L-WUC0-833624-L	943	83	36	1	34.9	1.73
L-WUC0-893624-L	1086	89	36	1	36.9	1.85

Code	Price	Height	Depth	Thickness	Weight (lb)	Volume (ft ³)
L-WUC0-953624-L	1137	95	36	1	38.9	1.98
L-WUC0-533523-L	657	53	35	1	24.9	1.07
L-WUC0-593523-L	694	59	35	1	26.9	1.20
L-WUC0-653523-L	769	65	35	1	28.9	1.32
L-WUC0-713523-L	817	71	35	1	30.9	1.44
L-WUC0-773523-L	883	77	35	1	32.9	1.56
L-WUC0-833523-L	943	83	35	1	34.9	1.68
L-WUC0-893523-L	1086	89	35	1	36.9	1.80
L-WUC0-953523-L	1137	95	35	1	38.9	1.92
Right hand						
L-WUC0-543524-R	657	54	35	1	24.9	1.09
L-WUC0-603524-R	694	60	35	1	26.9	1.22
L-WUC0-663524-R	769	66	35	1	28.9	1.34
L-WUC0-723524-R	817	72	35	1	30.9	1.46
L-WUC0-783524-R	883	78	35	1	32.9	1.58
L-WUC0-843524-R	943	84	35	1	34.9	1.70
L-WUC0-903524-R	1086	90	35	1	36.9	1.82
L-WUC0-963524-R	1137	96	35	1	38.9	1.94
L-WUC0-533624-R	657	53	36	1	24.9	1.10
L-WUC0-593624-R	694	59	36	1	26.9	1.23
L-WUC0-653624-R	769	65	36	1	28.9	1.35
L-WUC0-713624-R	817	71	36	1	30.9	1.48
L-WUC0-773624-R	883	77	36	1	32.9	1.60
L-WUC0-833624-R	943	83	36	1	34.9	1.73
L-WUC0-893624-R	1086	89	36	1	36.9	1.85
L-WUC0-953624-R	1137	95	36	1	38.9	1.98
L-WUC0-533523-R	657	53	35	1	24.9	1.07
L-WUC0-593523-R	694	59	35	1	26.9	1.20
L-WUC0-653523-R	769	65	35	1	28.9	1.32
L-WUC0-713523-R	817	71	35	1	30.9	1.44
L-WUC0-773523-R	883	77	35	1	32.9	1.56
L-WUC0-833523-R	943	83	35	1	34.9	1.68
L-WUC0-893523-R	1086	89	35	1	36.9	1.80
L-WUC0-953523-R	1137	95	35	1	38.9	1.92

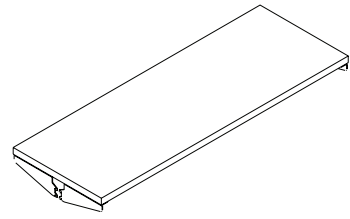

What's Included:

One (1) transaction top, Four (4) cantilever brackets

How to Specify:

Match the transaction top to the corresponding panel width

Refer to laminate card for laminate options

Choose White, Black, Silver, Charcoal for cantilever color

Notes:

Options:

Width: 24", 30", 36", 42", 48", 54", 60"

Depth: 15"

Thickness: 1"

Cantilever Paint Colour: Silver, White, Black, Charcoal

Code	Price	H	W	D	Weight (lb.)	Volume (ft ³)
L-WTT-2415	271	24	15	1	5.8	0.21
L-WTT-3015	289	30	15	1	7.2	0.26
L-WTT-3615	301	36	15	1	8.6	0.31
L-WTT-4215	318	42	15	1	10.1	0.36
L-WTT-4815	329	48	15	1	11.5	0.42
L-WTT-5415	350	54	15	1	13.0	0.47
L-WTT-6015	361	60	15	1	14.4	0.52



Switch USA Pricebook
November 2024

Supports

Supports

Ladder Gable	156
Standard Panel	156
Gallery Panel	158
Freestanding Panel	160
Laminate Gable	161
Standard Panel	161
Gallery Panel	162
Freestanding	163
Wrap Gable	164
Standard Panel	164
Gallery Panel	165
Tech Drop	166
Cantilever	167
Standard Panel	167
Gallery Panel	168
Standard Panel Mount Corner Bracket	170
Flush Plates	171
Storage Support Bracket	172
Fixed Credenza Support Bracket	173
90 Degree Storage Bracket	174
Horizontal Surface Support	175

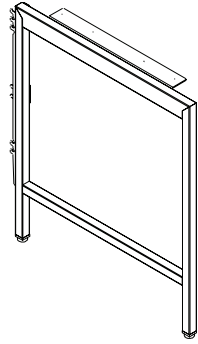

Standard Panel Ladder Gable

What's Included:

One (1) ladder gable, one (1) standard panel mount bracket, (1) surface to gable connector

How to Specify:

Choose White, Black, Silver, Charcoal for ladder gable colour

Notes:

Ladder Gable can be used with worksurface with grommet, worksurface without grommet, worksurface for 1" wire play

Mid gable is used at the surface joint

Options:

Heights*: 25", 28"

Depth: 20", 24", 30"

Ladder Gable Paint Colour:: Silver, White, Black, Charcoal

End gable: (Left hand, right hand) or mid gable

*25" high to be used to Tech Drop surface

Code	Price	H	W	D	Weight (lb.)	Volume (ft ³)
Left hand						
L-HOEG-P-2520-L	349	25	20	2	10.0	0.58
L-HOEG-P-2524-L	352	25	24	2	12.0	0.69
L-HOEG-P-2530-L	388	25	30	2	15.0	0.87
L-HOEG-P-2820-L	353	28	20	2	11.2	0.65
L-HOEG-P-2824-L	361	28	24	2	13.4	0.78
L-HOEG-P-2830-L	375	28	30	2	16.8	0.97
Right hand						
L-HOEG-P-2520-R	349	25	20	2	10.0	0.58
L-HOEG-P-2524-R	352	25	24	2	12.0	0.69
L-HOEG-P-2530-R	388	25	30	2	15.0	0.87
L-HOEG-P-2820-R	353	28	20	2	11.2	0.65
L-HOEG-P-2824-R	361	28	24	2	13.4	0.78
Mid						
L-HOMG-P-2520	349	25	20	2	10.0	0.58
L-HOMG-P-2524	352	25	24	2	12.0	0.69
L-HOMG-P-2530	388	25	30	2	15.0	0.87
L-HOMG-P-2820	353	28	20	2	11.2	0.65
L-HOMG-P-2824	361	28	24	2	13.4	0.78
L-HOMG-P-2830	375	28	30	2	16.8	0.97

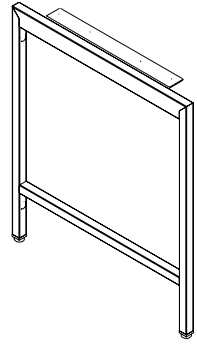

Gallery Panel Ladder Gable

What's Included:

One (1) ladder gable, one (1) gallery panel mount bracket, (1) surface to gable connector

How to Specify:

Choose White, Black, Silver, Charcoal for ladder gable colour

Notes:

Ladder Gable can be used with worksurface with grommet, worksurface without grommet, worksurface for 1" wire play

Mid gable is used at the surface joint

Options:

Heights*: 25", 28"

Depth: 20", 24", 30"

Ladder Gable Paint Colour:: Silver, White, Black, Charcoal

End gable: (Left hand, right hand) or mid gable

*25" high to be used to Tech Drop surface

Code	Price	H	W	D	Weight (lb.)	Volume (ft ³)
Left hand						
L-HOEG-Y-2520-L	349	25	20	2	10.0	0.58
L-HOEG-Y-2524-L	352	25	24	2	12.0	0.69
L-HOEG-Y-2530-L	388	25	30	2	15.0	0.87
L-HOEG-Y-2820-L	353	28	20	2	11.2	0.65
L-HOEG-Y-2824-L	361	28	24	2	13.4	0.78
L-HOEG-Y-2830-L	375	28	30	2	16.8	0.97
Right hand						
L-HOEG-Y-2520-R	349	25	20	2	10.0	0.58
L-HOEG-Y-2524-R	352	25	24	2	12.0	0.69
L-HOEG-Y-2530-R	388	25	30	2	15.0	0.87
L-HOEG-Y-2820-R	353	28	20	2	11.2	0.65
L-HOEG-Y-2824-R	361	28	24	2	13.4	0.78
L-HOEG-Y-2830-R	375	28	30	2	16.8	0.97
Mid						
L-HOMG-Y-2520	349	25	20	2	10.0	0.58
L-HOMG-Y-2524	352	25	24	2	12.0	0.69
L-HOMG-Y-2530	388	25	30	2	15.0	0.87
L-HOMG-Y-2820	353	28	20	2	11.2	0.65
L-HOMG-Y-2824	361	28	24	2	13.4	0.78
L-HOMG-Y-2830	375	28	30	2	16.8	0.97

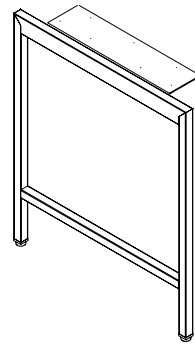

Freestanding

What's Included:

One (1) 90 degree bracket

How to Specify:

Available in black only

Notes:

90 degree bracket is used to connect a worksurface to a gallery panel

Options:

Heights*: 25", 28"

Depth: 20", 24", 30"

Ladder Gable Paint Colour:: Silver, White, Black, Charcoal

End gable: (Left hand, right hand)

*25" high to be used to Tech Drop surface

Code	Price	H	W	D	Weight (lb.)	Volume (ft ³)
Freestanding						
L-HOEG-S-2520	349	25	20	2	10.0	0.58
L-HOEG-S-2524	352	25	24	2	12.0	0.69
L-HOEG-S-2530	388	25	30	2	15.0	0.87
L-HOEG-S-2820	353	28	20	2	11.2	0.65
L-HOEG-S-2824	361	28	24	2	13.4	0.78
L-HOEG-S-2830	375	28	30	2	16.8	0.97

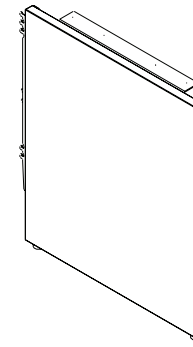

Standard Panel Laminate Gable

What's Included:

One (1) ladder gable, one (1) standard panel mount bracket, (1) surface to gable connector

How to Specify:

Laminate Gable Paint Colour: Silver, White, Black, Charcoal

Laminate Gable Laminate Colour: Refer to laminate card for laminate options

End gable (Left hand, right hand)

Options:

Heights*: 25", 28"

Depth: 20", 24", 30"

*25" high to be used to Tech Drop surface

Notes:

Ladder Gable can be used with worksurface with grommet, worksurface without grommet, worksurface for 1" wire play

Code	Price	H	W	D	Weight (lb.)	Volume (ft ³)
Left hand						
L-HCEG-P-2520-L	228	25	20	2	10.0	0.58
L-HCEG-P-2524-L	247	25	24	2	12.0	0.69
L-HCEG-P-2530-L	270	25	30	2	15.0	0.87
L-HCEG-P-2812-L	211	28	12	2	10.0	0.39
L-HCEG-P-2820-L	238	28	20	2	11.2	0.65
L-HCEG-P-2824-L	258	28	24	2	13.4	0.78
L-HCEG-P-2830-L	282	28	30	2	16.8	0.97
Right hand						
L-HCEG-P-2520-R	228	25	20	2	10.0	0.58
L-HCEG-P-2524-R	247	25	24	2	12.0	0.69
L-HCEG-P-2530-R	270	25	30	2	15.0	0.87
L-HCEG-P-2812-R	211	28	12	2	10.0	0.39
L-HCEG-P-2820-R	238	28	20	2	11.2	0.65
L-HCEG-P-2824-R	258	28	24	2	13.4	0.78
L-HCEG-P-2830-R	282	28	30	2	16.8	0.97

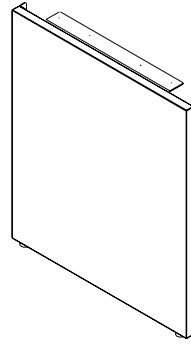

Gallery Panel
Laminate Gable

What's Included:

One (1) ladder gable, one (1) gallery panel mount bracket, (1) surface to gable connector

How to Specify:

Laminate Gable Paint Colour: Silver, White, Black, Charcoal

Laminate Gable Laminate Colour: Refer to laminate card for laminate options

End gable (Left hand, right hand)

Options:

Heights*: 25", 28"

Depth: 20", 24", 30"

*25" high to be used to Tech Drop surface

Notes:

Ladder Gable can be used with worksurface with grommet, worksurface without grommet, worksurface for 1" wire play

Code	Price	H	W	D	Weight (lb.)	Volume (ft ³)
Left hand						
L-HCEG-Y-2520-L	224	25	20	2	10.0	0.58
L-HCEG-Y-2524-L	237	25	24	2	12.0	0.69
L-HCEG-Y-2530-L	261	25	30	2	15.0	0.87
L-HCEG-Y-2812-L	203	28	12	2	11.2	0.39
L-HCEG-Y-2820-L	233	28	20	2	11.2	0.65
L-HCEG-Y-2824-L	249	28	24	2	13.4	0.78
L-HCEG-Y-2830-L	274	28	30	2	16.8	0.97
Right hand						
L-HCEG-Y-2520-R	224	25	20	2	10.0	0.58
L-HCEG-Y-2524-R	237	25	24	2	12.0	0.69
L-HCEG-Y-2530-R	261	25	30	2	15.0	0.87
L-HCEG-Y-2812-R	203	28	12	2	11.2	0.39
L-HCEG-Y-2820-R	233	28	20	2	11.2	0.65
L-HCEG-Y-2824-R	249	28	24	2	13.4	0.78
L-HCEG-Y-2830-R	274	28	30	2	16.8	0.97

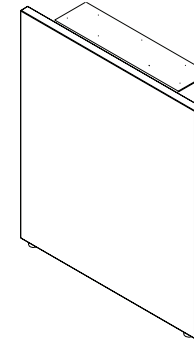

Freestanding Laminate Gable

What's Included:

One (1) ladder gable, (1) surface to gable connector

How to Specify:

Laminate Gable Paint Colour: Silver, White, Black, Charcoal

Laminate Gable Laminate Colour: Refer to laminate card for laminate options

Options:

Heights*: 25", 28"

Depth: 20", 24", 30"

*25" is used with the 20" deep surface

Notes:

Laminate Gable can be used with worksurface with grommet, worksurface without grommet, worksurface for 1" wire play

Freestanding gable is used when one side of the surface is connected to a panel and the other is open

Code	Price	H	W	D	Weight (lb.)	Volume (ft ³)
L-HCEG-S-2520	238	25	20	2	10.0	0.58
L-HCEG-S-2524	253	25	24	2	12.0	0.69
L-HCEG-S-2530	278	25	30	2	15.0	0.87
L-HCEG-S-2820	249	28	20	2	11.2	0.65
L-HCEG-S-2824	270	28	24	2	13.4	0.78
L-HCEG-S-2830	294	28	30	2	16.8	0.97

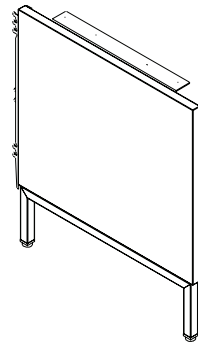

Standard Panel
Wrap Laminate Gable

What's Included:

One (1) wrap gable, one (1) standard panel mount bracket, (1) surface to gable connector

How to Specify:

Laminate Gable Paint Colour: Silver, White, Black, Charcoal

Laminate Gable Laminate Colour: Refer to laminate card for laminate options

End gable (Left hand, right hand)

Options:

Heights*: 25", 28"

Depth: 20", 24", 30"

*25" high to be used to Tech Drop surface

Notes:

Laminate Gable can be used with worksurface with grommet, worksurface without grommet, worksurface for 1" wire play

Freestanding gable is used when one side of the surface is connected to a panel and the other is open

Code	Price	H	W	D	Weight (lb.)	Volume (ft ³)
Left hand						
L-HWEG-P-2520-L	391	25	20	2	10.0	0.58
L-HWEG-P-2524-L	403	25	24	2	12.0	0.69
L-HWEG-P-2530-L	445	25	30	2	15.0	0.87
L-HWEG-P-2820-L	401	28	20	2	11.2	0.65
L-HWEG-P-2824-L	415	28	24	2	13.4	0.78
L-HWEG-P-2830-L	460	28	30	2	16.8	0.97
Right hand						
L-HWEG-P-2520-R	391	25	20	2	10.0	0.58
L-HWEG-P-2524-R	403	25	24	2	12.0	0.69
L-HWEG-P-2530-R	445	25	30	2	15.0	0.87
L-HWEG-P-2820-R	401	28	20	2	11.2	0.65
L-HWEG-P-2824-R	415	28	24	2	13.4	0.78
L-HWEG-P-2830-R	460	28	30	2	16.8	0.97

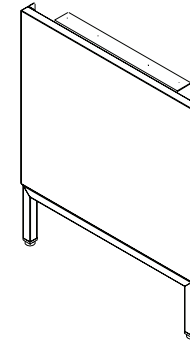

Gallery Panel
Wrap Laminate Gable

What's Included:

One (1) wrap gable, one (1) gallery panel mount bracket, (1) surface to gable connector

How to Specify:

Laminate Gable Paint Colour: Silver, White, Black, Charcoal

Laminate Gable Laminate Colour: Refer to laminate card for laminate options

End gable (Left hand, right hand)

Options:

Heights*: 25", 28"

Depth: 20", 24", 30"

*25" high to be used to Tech Drop surface

Notes:

Laminate Gable can be used with worksurface with grommet, worksurface without grommet, worksurface for 1" wire play

Freestanding gable is used when one side of the surface is connected to a panel and the other is open

Code	Price	H	W	D	Weight (lb.)	Volume (ft ³)
Left hand						
L-HWEG-Y-2520-L	394	25	20	2	10.0	0.58
L-HWEG-Y-2524-L	403	25	24	2	12.0	0.69
L-HWEG-Y-2530-L	445	25	30	2	15.0	0.87
L-HWEG-Y-2820-L	401	28	20	2	11.2	0.65
L-HWEG-Y-2824-L	415	28	24	2	13.4	0.78
L-HWEG-Y-2830-L	461	28	30	2	16.8	0.97
Right hand						
L-HWEG-Y-2520-R	394	25	20	2	10.0	0.58
L-HWEG-Y-2524-R	403	25	24	2	12.0	0.69
L-HWEG-Y-2530-R	445	25	30	2	15.0	0.87
L-HWEG-Y-2820-R	401	28	20	2	11.2	0.65
L-HWEG-Y-2824-R	415	28	24	2	13.4	0.78
L-HWEG-Y-2830-R	461	28	30	2	16.8	0.97

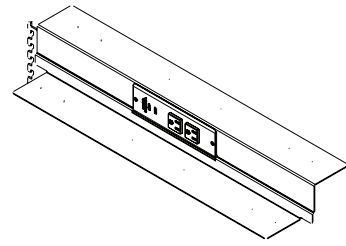

Standard Panel Tech Drop

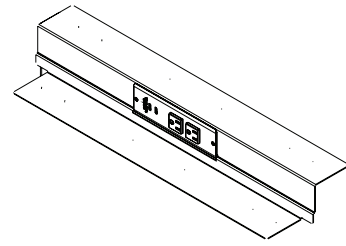

Gallery Panel Tech Drop

What's Included:

One (1) tech drop, one (1) power module with two (2) AC outlets and two (2) USB-A outlets, one (1) panel connector hardware

How to Specify:

Choose White, Black, Silver, Charcoal for Tech Drop

Left, right

Options:

Heights: 3"

Depth*: 19", 23"

*19" is used with the 20" deep surface

Notes:

Tech drop offers a 3" drop between main surface and return surface

Tech drop must be mounted to the panel

Code	Price	H	W	D	Weight (lb.)	Volume (ft ³)
Standard Panel Tech Drop - left hand						
L-HSSE-P-19-L	331	3	19.875	4	6.3	0.14
L-HSSE-P-23-L	339	3	23.875	4	7.7	0.17
Standard Panel Tech Drop - right hand						
L-HSSE-P-19-R	331	3	19.875	4	6.3	0.14
L-HSSE-P-23-R	339	3	23.875	4	7.7	0.17
Gallery Panel Tech Drop - left hand						
L-HSSE-Y-19-L	335	3	19.875	4	6.3	0.14
L-HSSE-Y-23-L	343	3	23.875	4	7.7	0.17
Gallery Panel Tech Drop - right hand						
L-HSSE-Y-19-R	335	3	19.875	4	6.3	0.14
L-HSSE-Y-23-R	343	3	23.875	4	7.7	0.17

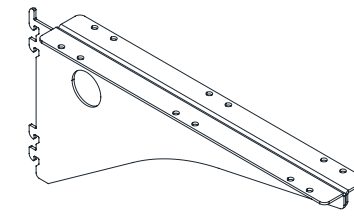

Standard Panel Mounted Cantilever Arm

What's Included:

One (1) standard panel mounted cantilever arm

How to Specify:

Left, right, mid

Options:

Depth: 16", 22"

Notes:

Cantilever available in black only

Code	Price	H	W	D	Weight (lb.)	Volume (ft ³)
intermediate						
L-CCAB-P-16	60	8	16	2	2.6	0.15
L-CCAB-P-22	67	8	22	2	3.5	0.21
left hand						
L-CCAB-P-16-L	60	8	16	1.5	1.9	0.11
L-CCAB-P-22-L	67	8	22	1.5	2.6	0.15
right hand						
L-CCAB-P-16-R	60	8	16	1.5	1.9	0.11
L-CCAB-P-22-R	67	8	22	1.5	2.6	0.15

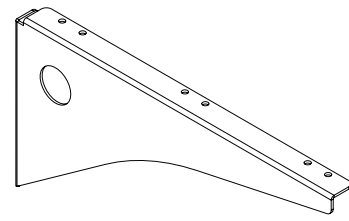

Gallery Panel Mounted Cantilever Arm

What's Included:

One (1) gallery panel mounted cantilever arm

How to Specify:

Left, right, mid

Options:

Depth: 16", 22"

Notes:

Cantilever available in black only

Code	Price	H	W	D	Weight (lb.)	Volume (ft ³)
intermediate						
L-CCAB-Y-16	60	8	16	2	2.6	0.15
L-CCAB-Y-22	67	8	22	2	3.5	0.21
left hand						
L-CCAB-Y-16-L	60	8	16	1.5	1.9	0.11
L-CCAB-Y-22-L	67	8	22	1.5	2.6	0.15
right hand						
L-CCAB-Y-16-R	60	8	16	1.5	1.9	0.11
L-CCAB-Y-22-R	67	8	22	1.5	2.6	0.15

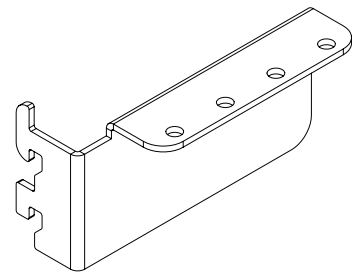

L-HCB
left hand shown

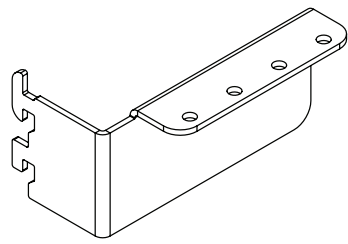

L-HCB1
left hand shown

What's Included:

One (1) standard panel mounted corner bracket

How to Specify:

Left, right
Full depth surface, surface with 1" wire play

Notes:

Worksurface with 1" wire play requires 1" offset bracket

Corner bracket available in black only

Options:

Code	Price	H	W	D	Weight (lb.)	Volume (ft ³)
L-HCB-P-L	8	3	4	2	0.1	0.01
L-HCB1-P-L	15	3	4	2	0.1	0.01
L-HCB-P-R	8	3	4	2	0.1	0.01
L-HCB1-P-R	15	3	4	2	0.1	0.01

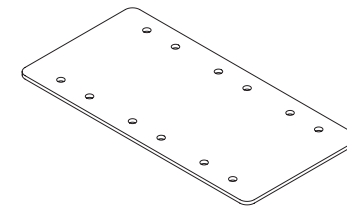

What's Included:

One (1) flush plate

How to Specify:

Flush Plate Paint Colour: Silver only

Notes:

Flush plate is used at surface joint to connect two surfaces together

Options:

Width: 5.5"

Depth: 3"

Code	Price	H	W	D	Weight (lb.)	Volume (ft ³)
L-PWW	42	3	5.5	0.125	1.0	0.00

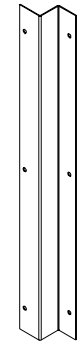

for standard panel



for gallery panel

What's Included:

panel to storage support bracket

How to Specify:

Available in white, black, charcoal, and silver

Notes:

Storage support bracket is used to connect off-modular storage to a surface

24" bracket is used to close 1" gap between storage and panel

30" bracket is used to close 7" gap between storage and panel

Options:

Width: 1", 7"

Code	Price	H	W	Weight (lb.)	Volume (ft ³)
for standard panel - left hand					
L-HPSP-24-L	48	28	1	8.6	0.69
L-HPSP-30-L	89	28	1	10.7	0.87
for standard panel -right hand					
L-HPSP-24-R	48	28	1	8.6	0.69
L-HPSP-30-R	89	28	1	10.7	0.87
for gallery panel					
L-HPGP-24	60	28	1	8.6	0.69
L-HPGP-30	125	28	1	10.7	0.87

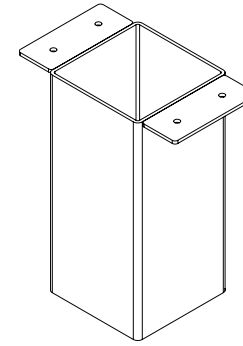

What's Included:

One (1) 90 degree bracket

How to Specify:

Flush Plate Paint Colour: Silver, White, Black, Charcoal

Options:

Height: 8.5"

Width: 4"

Depth: 4"

Notes:

Code	Price	H	W	D	Weight (lb.)	Volume (ft ³)
L-HCFM6	173	6.375	7	4	6	0.14

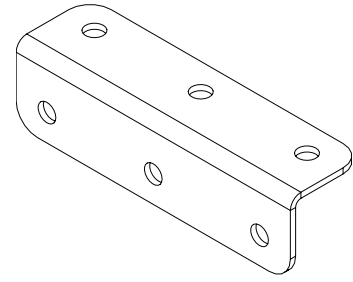

What's Included:

One (1) 90 degree bracket

How to Specify:

Available in black only

Notes:

90 degree bracket is used to connect a worksurface to a gallery panel

24" deep surface: two (2) brackets
30" deep surface: three (3) brackets

Options:

Depth: 3"

Code	Price	Specifications	Weight (lb.)	Volume (ft ³)
L-HSSB	3	3", 6 Holes	0.5	0.09
L-HSSB-24	8	For 24"Deep	2.2	0.09
L-HSSB-30	13	For 30"Deep	3.0	0.09

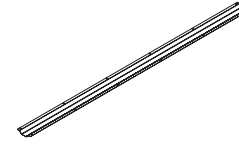

What's Included:

Horizontal Surface Support, installation hardware.

How to Specify:

The horizontal surface support is available only in silver.

Options:

width 51, 57, 63, 69, 75

Notes:

The horizontal surface support is used to support worksurfaces 54-inches and longer.

This item is mounted to the underside of a worksurface.

Code	Price	W (in)	Weight (lb)	Volume (ft ³)
L-CH00-54	71	51	4	0.05
L-CH00-60	77	57	4.5	0.05
L-CH00-66	82	63	5	0.06
L-CH00-72	86	69	5.5	0.06
L-CH00-78	91	75	6	0.07



Switch USA Pricebook
November 2024
Electrics

Electrics

Power Module	178
Power & Data	179
Connector Harness	180
Male to Female Extension Harness	182
New York Junction Box	183
Chicago Electrical Box	184
Wire Manager	185
Communication Kit	186
Conversion Kit	187

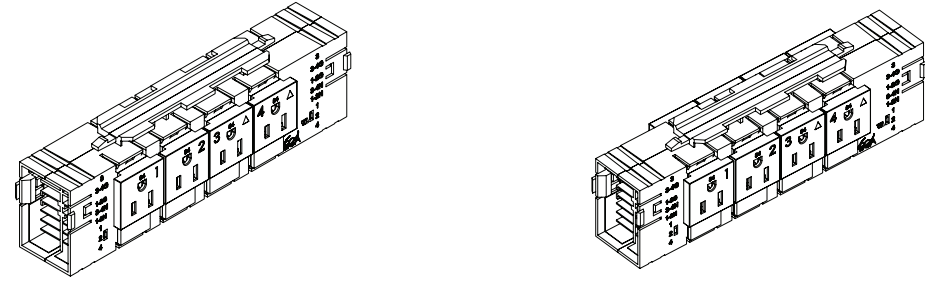

What's Included:

One (1) single power module with four (4) ac outlets or one (1) double sided power module with eight (8) ac outlets (four on each side)

How to Specify:

Available in grey only
Single sided, double sided

Options:

Width: 8"

Notes:

Power modules are installed in the center cut out power capable panels only

Double sided power module has four (4) ac outlets on each side

Refer to Switch electrical specification guide for more information

Code	Price	H	W	D	Weight (lb.)	Volume (ft ³)
single sided						
L-EM84-S	212	3	6	3	1.7	0.03
double sided						
L-EM84-D	339	3	6	3	2.0	0.03

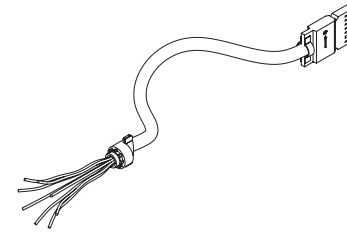

What's Included:

One (1) open wire starter harness

How to Specify:

Available in grey only
Single sided, double sided

Options:

Length: 72", 168"

Notes:

Switch electrical system is rated for 20 amps

Tayco recommends up to 8 workstations hardwired to one power source

Code	Price	L	D	Weight (lb.)	Volume (ft ³)
L-ES84-072-0	315	72	0.75	2.6	0.40
L-ES84-168-0	396	168	0.75	5.1	0.50

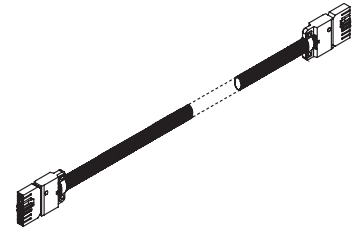

What's Included:

One (1) connector harness

How to Specify:

Available in grey only

Single sided, double sided

Options:

Length: 22"-181" in 3" increments

Notes:

Connector harness is used to connect two power modules together

Refer to installation guide for connector harness length calculation

Code	Price	Length	D	Weight (lb.)	Volume (ft ³)
L-EH84-22	160	22	0.75	0.6	0.20
L-EH84-25	165	25	0.75	0.7	0.20
L-EH84-28	170	28	0.75	0.8	0.20
L-EH84-31	176	31	0.75	0.8	0.20
L-EH84-34	183	34	0.75	0.9	0.20
L-EH84-37	188	37	0.75	1.0	0.20
L-EH84-40	196	40	0.75	1.1	0.20
L-EH84-43	201	43	0.75	1.2	0.20
L-EH84-46	204	46	0.75	1.3	0.20
L-EH84-49	210	49	0.75	1.5	0.20
L-EH84-52	215	52	0.75	1.5	0.20
L-EH84-55	225	55	0.75	1.6	0.20
L-EH84-58	228	58	0.75	1.7	0.20
L-EH84-61	234	61	0.75	1.8	0.20
L-EH84-64	238	64	0.75	1.9	0.20
L-EH84-67	247	67	0.75	1.9	0.20
L-EH84-70	250	70	0.75	2.0	0.20
L-EH84-73	259	73	0.75	2.0	0.20
L-EH84-76	264	76	0.75	2.0	0.20
L-EH84-79	270	79	0.75	2.1	0.20
L-EH84-82	274	82	0.75	2.1	0.20
L-EH84-85	278	85	0.75	2.4	0.20
L-EH84-88	285	88	0.75	2.4	0.20
L-EH84-91	291	91	0.75	2.4	0.20

Power & Data continued

Code	Price	Length	D	Weight (lb.)	Volume (ft ³)
L-EH84-94	297	94	0.75	2.5	0.20
L-EH84-97	303	97	0.75	2.5	0.20
L-EH84-100	308	100	0.75	2.7	0.20
L-EH84-103	314	103	0.75	2.7	0.20
L-EH84-106	320	106	0.75	2.9	0.20
L-EH84-109	327	109	0.75	2.9	0.20
L-EH84-112	331	112	0.75	3.0	0.20
L-EH84-115	338	115	0.75	3.0	0.20
L-EH84-118	344	118	0.75	3.2	0.20
L-EH84-121	349	121	0.75	3.4	0.20
L-EH84-124	353	124	0.75	3.4	0.20
L-EH84-127	362	127	0.75	3.5	0.20
L-EH84-130	369	130	0.75	3.5	0.20
L-EH84-133	372	133	0.75	3.4	0.20
L-EH84-136	377	136	0.75	3.7	0.20
L-EH84-139	384	139	0.75	3.9	0.20
L-EH84-142	388	142	0.75	3.9	0.20
L-EH84-145	397	145	0.75	3.9	0.20
L-EH84-148	528	148	0.75	3.9	0.20
L-EH84-151	535	151	0.75	4.2	0.20
L-EH84-154	541	154	0.75	4.3	0.20
L-EH84-157	547	157	0.75	4.4	0.20
L-EH84-160	552	160	0.75	4.4	0.20
L-EH84-163	557	163	0.75	4.5	0.20
L-EH84-166	563	166	0.75	4.6	0.20
L-EH84-169	570	169	0.75	4.7	0.20
L-EH84-172	575	172	0.75	4.8	0.20
L-EH84-175	581	175	0.75	4.8	0.20
L-EH84-178	585	178	0.75	4.9	0.20
L-EH84-181	592	181	0.75	5.0	0.20

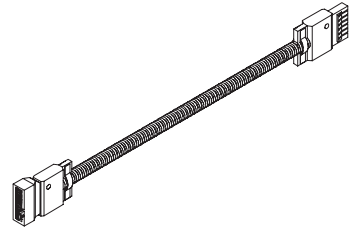

What's Included:

One (1) male to female extension harness

How to Specify:

Available in grey only
Single sided, double sided

Options:

Length: 44",122"

Notes:

Male to female extension harness is used to extend length of the starter harness

Code	Price	Length	D	Weight (lb.)
L-E8FM-044	204	44	0.75	0.3
L-E8FM-122	353	122	0.75	0.6

What's Included:

Panels 24", 30", 36" wide: One (1) New York junction box

Panels 42" or wider: One (1) New York junction box with single or double power module

How to Specify:

Panels 24", 30", 36" wide: Specify junction box without power module. Power module and starter harness must be specified speratley

Panels 42" or wider: Specify single or double power module with junction box

Options:

Junction Box width: 9"

Junction Box with power module width: 18"

Notes:

Male to female extension harness is used to extend length of the starter harness

Code	Price	Length	D	Weight (lb.)
L-NY84-004-D	712			
L-NY84-004-S	581			
L-NYEJ-84	202			

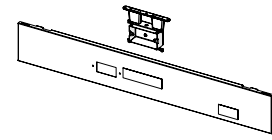

Single sided

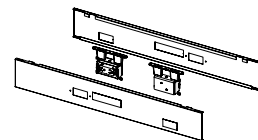

Double sided

What's Included:

Single Sided: One (1) electrical box with two (2) ac outlets and one (1) panel raceway

Double Sided: Two (2) single sided electrical boxes each with two (2) ac outlets and two (2) panel raceways

How to Specify:

Select corresponding size to match the panel width

Options:

Width: 30", 36", 42", 48", 54", 60", 72"

Notes:

Junction box is located on the left hand side of the panel

Code	Price	Length	D	Weight (lb.)
Single Sided				
L-JB0X-30-S	335			
L-JB0X-36-S	335			
L-JB0X-42-S	335			
L-JB0X-48-S	335			
L-JB0X-54-S	335			
L-JB0X-60-S	335			
Double Sided				
L-JB0X-30-D	667			
L-JB0X-36-D	667			
L-JB0X-42-D	667			
L-JB0X-48-D	667			
L-JB0X-54-D	667			
L-JB0X-60-D	667			



for 3 way connection(3W)



for 4 way connection(4W)



For 90 Degree Connection (N)

What's Included:

One (1) power pole, chosen mounting hardware

How to Specify:

Specify type based on panel connection: 90 degree, 3-way T, 4 way X and gallery panel mount

90 degree, 3-way T and 4-way X must be used with same height connecting panels

Use gallery panel mount type at the end of a run

Notes:

Options:

Connector type height: 96", 120"

Gallery panel height: 144"

Code	Price	H	W	D	Weight (lb.)	Volume (ft ³)
standard panel						
L-EP-P-120-3W	471	120	2	2	2.0	0.28
L-EP-P-120-4W	471	120	2	2	2.0	0.28
L-EP-P-120-N	471	120	2	2	2.0	0.28
L-EP-P-96-3W	423	96	2	2	1.5	0.22
L-EP-P-96-4W	423	96	2	2	1.5	0.22
L-EP-P-96-N	423	96	2	2	2.0	0.22
gallery panel						
L-EP-Y-144	582	144	2	2	2.0	0.33

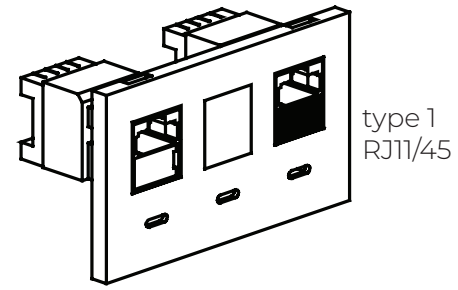

type 1
RJ11/45

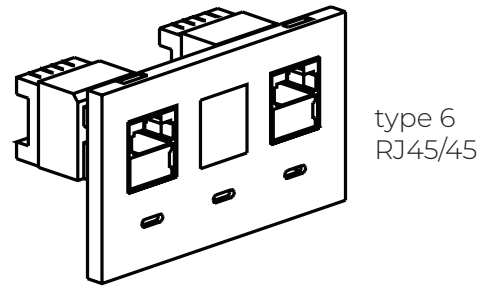

type 6
RJ45/45

What's Included:

One (1) data plate with three (3) openings and chosen combination of RJ11/RJ45

How to Specify:

Specify RJ11 for phone connection
Specify RJ45 for data connection

Notes:

Data is placed on the right hand side of the cutout in the panel raceway

Options:

Panel cutout width: 2 3/4"

Panel cutout height: 1 3/8"

Code	Price	H	W	D	Weight (lb.)	Volume (ft ³)
type 1						
L-ECK1	153	2	4	1	0.2	0.00
type 6						
L-ECK6	153	2	4	1	0.2	0.00

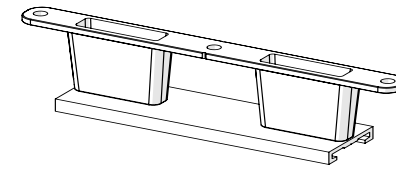

Non-Power Capable to Power Capable Panel Conversion Kit

What's Included:

One (1) power module mounting bracket

How to Specify:

Specify RJ11 for phone connection
Specify RJ45 for data connection

Notes:

Used to convert a non-power capable panel to a power capable panel

To be placed in the of the non-power capable panel raceway to convert to a power capable

Power module to be specified seperately

Options:

Code	Price	Weight (lb.)	Volume (ft ³)
RI-0300	24		



Switch USA Pricebook
November 2024
Storage

Storage

Pedestals	190
Underdesk Pedestal	190
Mobile	191
Upholstered Seat Pad	192
Lateral File	193
Underdesk	193
Freestanding	194
Credenza	195
Open Lateral	195
Storage Tower	196
Wardrobe Tower	197
Combo Tower	198
w/ Front Access	198
w/ Side Access	200
Panel Mounted Overheads - Cabinet	202
Flipper	202
Hinged Door	203
Shared	204
Cubby	206
Metal Shelf	207

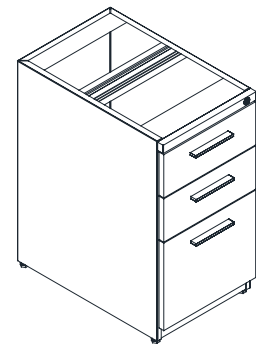

box/box/file

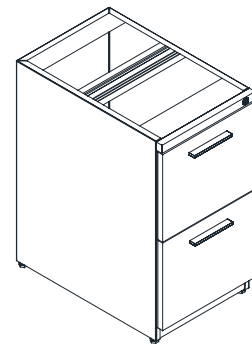

file/file

What's Included:

One (1) box/box/file or one (1) file/file underdesk pedestal

How to Specify:

Pedestal type: box/box/file, file/file

Notes:

Pedestal brackets must be ordered separately

Locks can be keyed alike or random

Options:

Height: 28"

Width: 16"

Depth: 23", 29"

Code	Price	H	W	D	Weight (lb.)	Volume (ft ³)
box/box/file						
L-FPBU-281623	890	28	16	23	64.4	5.96
L-FPBU-281629	920	28	16	29	81.2	7.52
file/file						
L-FPFU-281623	824	28	16	23	64.4	5.96
L-FPFU-281629	858	28	16	29	81.2	7.52

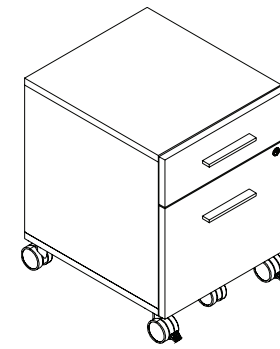

box/ file/no cushion

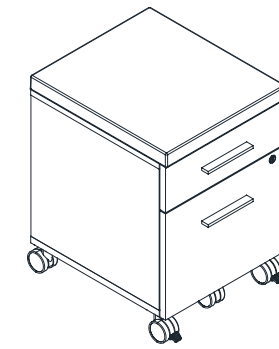

box/file w/ cushion

What's Included:

One (1) box/file mobile pedestal or one (1) box/file mobile pedestal with cushion, five (5) lockable casters

How to Specify:

With or without cushion

Refer to seating fabric card for cushion fabric selection

Choose handle type and finish

Choose depth

Choose silver or white for caster finish

Notes:

Locks can be keyed alike or random

Options:

Height: 21" without cushion, 22" with cushion

Width: 16"

Depth: 18"

Code	Price	H	W	D	Weight (lb.)	Volume (ft ³)
box/file/no cushion						
L-FPL0-211618	907	21	16	18	43.2	3.50
box/file w/ cushion						
L-FPLS-221618	1044	22	16	18	45.3	3.67

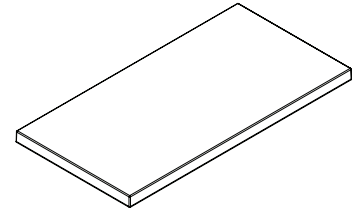

What's Included:

One (1) upholstered seat pad

How to Specify:

Refer to seating fabric card for fabric selection

Notes:

Options:

Height:	1"
Width:	24", 30", 36", 48", 60", 72"
Depth:	18"

Code	Price	H	W	D	Weight (lb.)	Volume (ft ³)
L-PAD-1824	303	24	24	2	2.4	0.67
L-PAD-1830	344	24	30	2	3.0	0.83
L-PAD-1836	385	24	36	2	3.6	1.00
L-PAD-1848	474	24	48	2	4.8	1.33
L-PAD-1860	558	24	60	2	6.0	1.67
L-PAD-1872	647	24	72	2	7.2	2.00

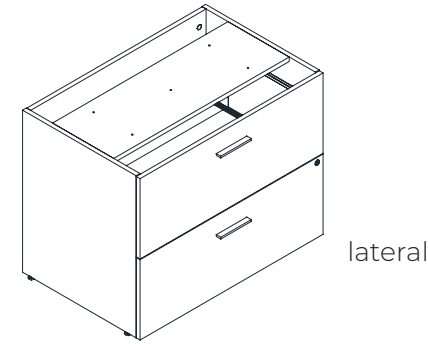

What's Included:

One (1) two drawer underdesk lateral filing cabinet, each drawer is equipped with (2) bars for front to back filing

How to Specify:

Refer to laminate card for laminate selection
 Choose handle type and finish
 Choose depth

Notes:

Lateral brackets must be ordered separately
 Locks can be keyed alike or random

Options:

Height:	28"
Width:	30", 36"
Depth:	23", 29"

Code	Price	H	W	D	Weight (lb.)	Volume (ft ³)
underdesk 2 Drawer						
L-FL2U-283023	1132	28	30	23	107.3	11.18
L-FL2U-283029	1166	28	30	29	135.3	14.10
L-FL2U-283623	1222	28	36	23	128.8	13.42
L-FL2U-283629	1256	28	36	29	162.4	16.92

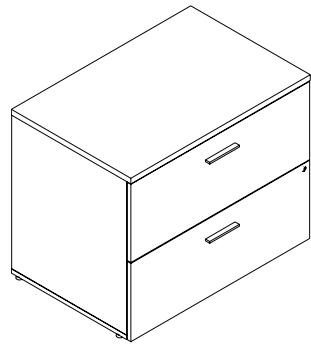

2 Drawer

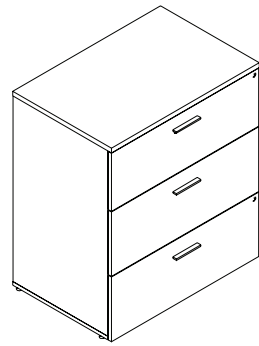

3 drawer

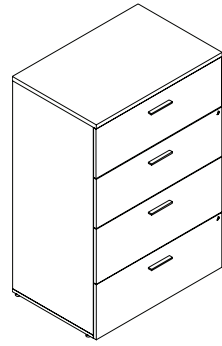

4 drawer

What's Included:

One (1) two drawer, three drawer or four drawer freestanding lateral filing cabinet with finished top, each drawer is equipped with (2) bars for front to back filing

How to Specify:

- Refer to laminate card for laminate selection
- Choose two drawer, three drawer or four drawers
- Choose handle type and finish
- Choose silver or white for caster finish

Options:

Height: 29" for 2 drawer, 42" for 3 drawer, 54" for 4 drawer

Width: 30", 36"

Depth: 24"

Code	Price	H	W	D	Weight (lb.)	Volume (ft ³)
2 Drawer						
L-FL2F-293024	1396	29	30	24	116.0	12.08
L-FL2F-293624	1516	29	36	24	139.2	14.50
3 drawer						
L-FL3F-423024	1798	42	30	24	168.0	17.50
L-FL3F-423624	1942	42	36	24	201.6	21.00
4 drawer						
L-FL4F-543024	2179	54	30	24	216.0	22.50
L-FL4F-543624	2353	54	36	24	259.2	27.00

Notes:

Locks can be keyed alike or random

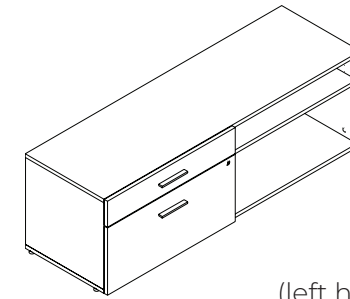

(left hand shown)

What's Included:

One (1) open lateral credenza, one (1) adjustable shelf for open cabinet

How to Specify:

- Choose right hand or left hand
- Refer to laminate card for laminate selection
- Choose handle type and finish

Options:

Height: 22"

Width: 48", 60", 72"

Depth: 18"

Notes:

- Locks can be keyed alike or random
- Right handed has lateral on right side
- Left handed has lateral on left side
- Can be used as a surface support credenza, with credenza fixed support specified separately

Code	Price	H	W	D	Weight (lb.)	Volume (ft ³)
Left hand						
L-CRCL-224818-L	1117	22	48	18	115.2	10.00
L-CRCL-226018-L	1233	22	60	18	144.0	12.50
L-CRCL-227218-L	1347	22	72	18	172.8	15.00
Right hand						
L-CRCL-226018-R	1233	22	60	18	144.0	12.50
L-CRCL-224818-R	1117	22	48	18	115.2	10.00
L-CRCL-227218-R	1347	22	72	18	172.8	15.00

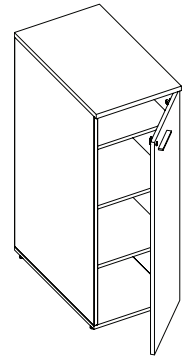

left hand shown

What's Included:

One (1) storage tower with one (1) adjustable shelf and (1) fixed shelf for 42" high or two (2) adjustable shelves and (1) fixed shelf for 50" high

How to Specify:

- Choose right hand or left hand
- Refer to laminate card for laminate selection
- Choose handle type and finish

Options:

Height:	42", 50"
Width:	18"
Depth:	24", 30"

Notes:

- Locks can be keyed alike or random
- Right handed has hinge on right side
- Left handed has hinge on left side

Code	Price	H	W	D	Weight (lb.)	Volume (ft ³)
Left hand						
L-FTSS-421824-L	1398	42	18	24	86.4	10.50
L-FTSS-421830-L	1424	42	18	30	108.0	13.13
L-FTSS-501824-L	1424	50	18	24	102.9	12.50
L-FTSS-501830-L	1441	50	18	30	128.6	15.63
Right hand						
L-FTSS-421824-R	1398	42	18	24	86.4	10.50
L-FTSS-421830-R	1424	42	18	30	108.0	13.13
L-FTSS-501824-R	1424	50	18	24	102.9	12.50
L-FTSS-501830-R	1441	50	18	30	128.6	15.63

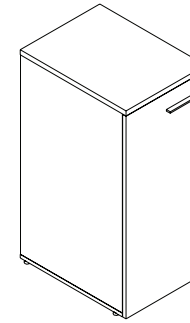

left hand shown

What's Included:

One (1) wardrobe tower, one (1) coat bar

How to Specify:

- Choose right hand or left hand
- Refer to laminate card for laminate selection
- Choose handle type and finish

Options:

Height:	42", 50"
Width:	18"
Depth:	24", 30"

Notes:

- Locks can be keyed alike or random
- Right handed has hinge on right side
- Left handed has hinge on left side

Code	Price	H	W	D	Weight (lb.)	Volume (ft ³)
Left hand						
L-FTCS-421824-L	1103	42	18	24	86.4	10.50
L-FTCS-421830-L	1175	42	18	30	108.0	13.13
L-FTCS-501824-L	1218	50	18	24	102.9	12.50
L-FTCS-501830-L	1298	50	18	30	128.6	15.63
Right hand						
L-FTCS-421824-R	1103	42	18	24	86.4	10.50
L-FTCS-421830-R	1175	42	18	30	108.0	13.13
L-FTCS-501824-R	1218	50	18	24	102.9	12.50
L-FTCS-501830-R	1298	50	18	30	128.6	15.63

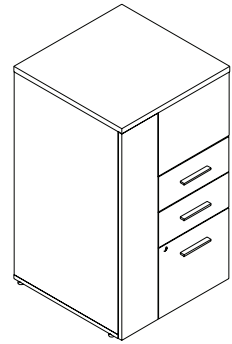

(left hand shown)

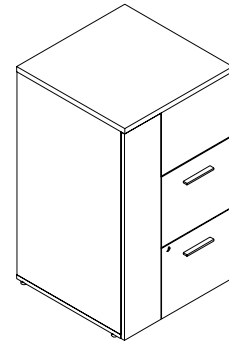

(left hand shown)

What's Included:

One (1) combo tower with front access, one (1) coat bar, one (1) adjustable shelf and (1) fixed shelf for 42" high or two (2) adjustable shelves and (1) fixed shelf for 50" high

How to Specify:

- Choose right hand or left hand
- Refer to laminate card for laminate selection
- Choose handle type and finish
- Choose box/box/file, file/file drawers

Notes:

- Locks can be keyed alike or random
- Right handed has door on right side
- Left handed has door on left side

Options:

Height:	42", 50"
Width:	24"
Depth:	24", 30"

Code	Price	H	W	D	Weight (lb.)	Volume (ft ³)
box/box/file pedestal -left hand						
L-CWTB-422424-L	2343	42	24	24	127.0	14.00
L-CWTB-422430-L	2375	42	24	30	159.0	18.00
L-CWTB-502424-L	2375	50	24	24	152.0	17.00
L-CWTB-502430-L	2404	50	24	30	189.0	21.00
box/box/file pedestal - right hand						
L-CWTB-422424-R	2343	42	24	24	127.0	14.00
L-CWTB-422430-R	2375	42	24	30	159.0	18.00
L-CWTB-502424-R	2375	50	24	24	152.0	17.00
L-CWTB-502430-R	2404	50	24	30	189.0	21.00
file/file pedestal - left hand						
L-CWTF-422424-L	2322	42	24	24	127.0	14.00
L-CWTF-422430-L	2322	42	24	30	159.0	18.00
L-CWTF-502424-L	2322	50	24	24	152.0	17.00
L-CWTF-422430-L	2322	42	24	30	159.0	18.00
file/file pedestal - right hand						
L-CWTF-422424-R	2322	42	24	24	127.0	14.00
L-CWTF-422430-R	2322	42	24	30	159.0	18.00
L-CWTF-502424-R	2322	50	24	24	152.0	17.00
L-CWTF-502430-R	2322	50	24	30	189.0	21.00

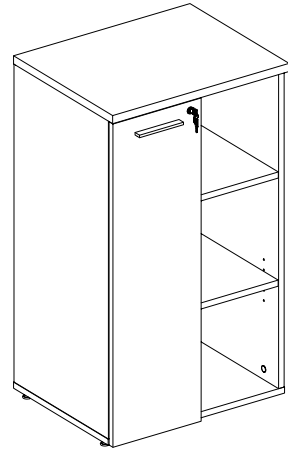

left hand shown

What's Included:

One (1) combo tower with side access, one (1) coat bar, (1) box/box/file or (1) file/file drawers, (1) cubby for 42" high or two (2) cubbies for 50" high

How to Specify:

- Choose right hand or left hand
- Refer to laminate card for laminate selection
- Choose handle type and finish
- Choose box/box/file, file/file drawers

Notes:

- Locks can be keyed alike or random
- Right handed has door on right side
- Left handed has door on left side

Options:

Height:	42", 50"
Width:	24"
Depth:	18.75", 24", 30"

Code	Price	H	W	D	Weight (lb.)	Volume (ft ³)
Left Hand						
L-FTCO-422418-L	1139	41	24	18.75	85.0	11.00
L-FTCO-422424-L	1266	41	24	24	101.0	14.00
L-FTCO-422430-L	1420	41	24	30	121.0	17.00
L-FTCO-502418-L	1313	49	24	18.75	97.0	13.00
L-FTCO-502424-L	1458	49	24	24	115.0	16.00
L-FTCO-502430-L	1636	49	24	30	138.0	21.00
Right hand						
L-FTCO-422418-R	1139	41	24	18.75	85.0	11.00
L-FTCO-422424-R	1266	41	24	24	101.0	14.00
L-FTCO-422430-R	1420	41	24	30	121.0	17.00
L-FTCO-502418-R	1313	49	24	18.75	97.0	13.00
L-FTCO-502424-R	1458	49	24	24	115.0	16.00

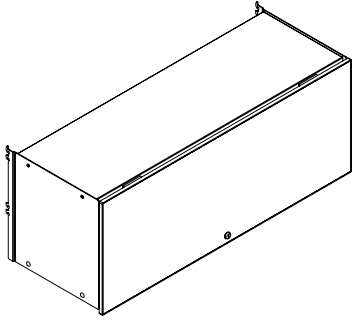

What's Included:

One (1) flipper cabinet

How to Specify:

Choose metal or laminate face

Choose white, black, silver, charcoal for metal face and body

Refer to laminate card for laminate face options

Notes:

Locks can be keyed alike or random

Flipper cabinet slides are easy-down pneumatic

Options:

Height*: 16"

Width: 30", 36", 42", 48", 54", 60"

Depth**: 15"

* Internal cabinet height is 13"

** Internal cabinet depth is 13"

Code	Price	H	W	D	Weight (lb.)	Volume (ft ³)
laminate face w/pneumatic slides						
L-SPFL-1530-P	599	16	30	15	32.7	4.17
L-SPFL-1536-P	603	16	36	15	39.3	5.00
L-SPFL-1542-P	625	16	42	15	45.8	5.83
L-SPFL-1548-P	631	16	48	15	52.4	6.67
L-SPFL-1554-P	655	16	54	15	58.9	7.50
L-SPFL-1560-P	661	16	60	15	65.5	8.33
metal face w/pneumatic slides						
L-SPFM-1530-P	610	16	30	15	32.7	4.17
L-SPFM-1536-P	627	16	36	15	39.3	5.00
L-SPFM-1542-P	647	16	42	15	45.8	5.83
L-SPFM-1548-P	668	16	48	15	52.4	6.67
L-SPFM-1554-P	683	16	54	15	58.9	7.50
L-SPFM-1560-P	705	16	60	15	65.5	8.33

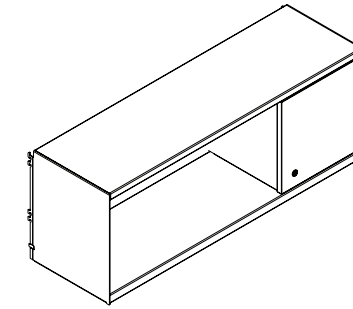
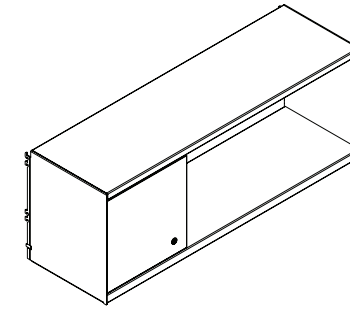

What's Included:

One (1) hinged cabinet, one (1) 12" wide hinged door

How to Specify:

Choose white, black, silver, charcoal for metal body

Refer to laminate card for laminate face options

Door on right or left side

Notes:

Locks can be keyed alike or random

OL refers to open on left side

LO refers to open on right side

Options:

Height*: 16"

Width: 36", 42", 48", 54", 60"

Depth**: 12"

* Internal cabinet height is 13"

** Internal cabinet depth is 12"

Code	Price	H	W	D	Weight (lb.)	Volume (ft ³)
closed/open						
L-SPLO-1536	861	16	36	15	43.2	5.00
L-SPLO-1542	920	16	42	15	50.4	5.83
L-SPLO-1548	941	16	48	15	57.6	6.67
L-SPLO-1554	1008	16	54	15	64.8	7.50
L-SPLO-1560	1023	16	60	15	72.0	8.33
open/closed						
L-SPOL-1536	861	16	36	15	43.2	5.00
L-SPOL-1542	920	16	42	15	50.4	5.83
L-SPOL-1548	941	16	48	15	57.6	6.67
L-SPOL-1554	1008	16	54	15	64.8	7.50
L-SPOL-1560	1023	16	60	15	72.0	8.33

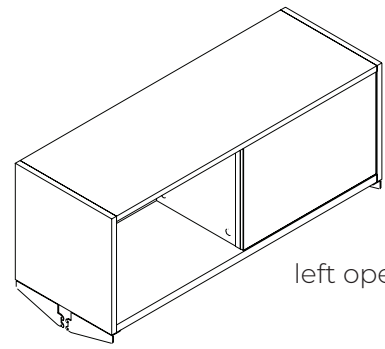

left open/right tackboard

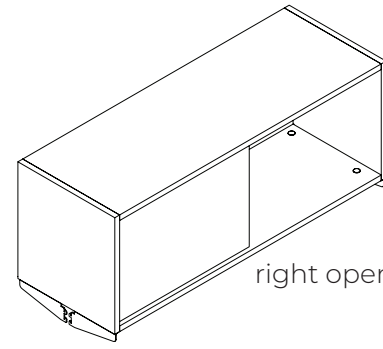

right open/ left melamine

What's Included:

One (1) shared cabinet, (1) tackboard if tackboard option is selected, four (4) panel mount cantilevers for up to 60"W or six (6) panel mount cantilevers for 66", 72"W

How to Specify:

- Choose white, black, silver, charcoal for cantilever
- Refer to laminate card for laminate face options
- Refer to panel fabric card for tackboard fabric options

Notes:

- OM refers to open on left side
- MO refers to open on right side
- OT refers to open on left side with tackboard on right side
- TO refers to open on right side with tackboard on left side

Options:

Height*:	16"
Width:	36", 42", 48", 54", 60", 66", 72
Depth**:	15"

* Internal cabinet height is 13" ** Internal cabinet depth is 13.5"

Code	Price	H	W	D	Weight (lb.)	Volume (ft ³)
left open/right tackboard						
L-STOT-161536	739	16	36	15	43.2	5.00
L-STOT-161542	786	16	42	15	50.4	5.83
L-STOT-161548	831	16	48	15	57.6	6.67
L-STOT-161554	877	16	54	15	64.8	7.50
L-STOT-161560	922	16	60	15	72.0	8.33
L-STOT-161566	970	16	66	15	79.2	9.17
L-STOT-161572	1018	16	72	15	86.4	10.00
right open/ left tackboard						
L-STTO-161536	739	16	36	15	43.2	5.00
L-STTO-161542	786	16	42	15	50.4	5.83
L-STTO-161548	831	16	48	15	57.6	6.67
L-STTO-161554	877	16	54	15	64.8	7.50
L-STTO-161560	922	16	60	15	72.0	8.33
L-STTO-161566	970	16	66	15	79.2	9.17
L-STTO-161572	1018	16	72	15	86.4	10.00

Code	Price	H	W	D	Weight (lb.)	Volume (ft ³)
right open/left melamine						
L-STMO-161536	556	16	36	15	43.2	5.00
L-STMO-161542	599	16	42	15	50.4	5.83
L-STMO-161548	637	16	48	15	57.6	6.67
L-STMO-161554	682	16	54	15	64.8	7.50
L-STMO-161560	724	16	60	15	72.0	8.33
L-STMO-161566	767	16	66	15	79.2	9.17
L-STMO-161572	812	16	72	15	86.4	10.00
left open/right melamine						
L-STOM-161536	556	16	36	15	43.2	5.00
L-STOM-161542	599	16	42	15	50.4	5.83
L-STOM-161548	637	16	48	15	57.6	6.67
L-STOM-161554	682	16	54	15	64.8	7.50
L-STOM-161560	724	16	60	15	72.0	8.33
L-STOM-161566	767	16	66	15	79.2	9.17
L-STOM-161572	812	16	72	15	86.4	10.00

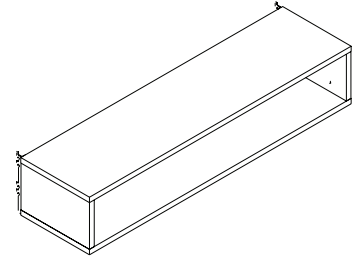

What's Included:

One (1) open cubby, two (2) mounting brackets

How to Specify:

Refer to laminate card for laminate face options

Notes:

Options:

Height*:	8"
Width:	24", 30", 36", 42", 48"
Depth**:	11"

* Internal cabinet height is 6.5"

** Internal cabinet depth is 11"

Code	Price	H	W	D	Weight (lb.)	Volume (ft ³)
L-SCS-081124	328	8	24	15	24.0	1.67
L-SCS-081130	343	8	30	15	27.0	2.08
L-SCS-081136	358	8	36	15	30.0	2.50
L-SCS-081142	373	8	42	15	33.0	2.92
L-SCS-081148	389	8	48	15	36.0	3.33

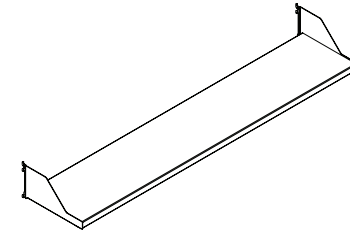

What's Included:

One (1) metal shelf

How to Specify:

Choose white, black, silver, charcoal for metal shelf

Notes:

Options:

Height:	6"
Width:	30", 36", 42", 48", 54", 60"
Depth:	12"

Code	Price	H	W	D	Weight (lb.)	Volume (ft ³)
L-SOOM-1230	321	2	30	12	14.4	0.42
L-SOOM-1236	338	2	36	12	17.3	0.50
L-SOOM-1242	351	2	42	12	20.2	0.58
L-SOOM-1248	363	2	48	12	23.0	0.67
L-SOOM-1254	377	2	54	12	25.9	0.75
L-SOOM-1260	391	2	60	12	28.8	0.83



Switch USA Pricebook
November 2024
Accessories

Accessories

Cable manager	210
Desktop Power Module	211
Tasklight	212
Monitor Arm	213
Keyboard Tray	214
Work Organizers	215
Accessory Rail	216
Pencil Tray	217

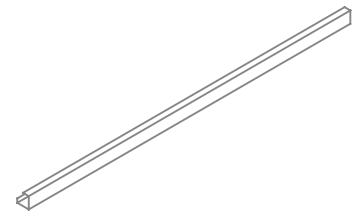

What's Included:

One (1) cable manager

How to Specify:

Available in black only

Dimensions:

length 12", 18", 24", 30", 36", 42", 48", 54", 60", 66", 72"

Notes:

Code	Price	H	W	D	Weight (lb.)	Volume (ft ³)
L-EWHB-12	8	1.5	12	1.5	0.2	0.02
L-EWHB-18	11	1.5	18	1.5	0.3	0.02
L-EWHB-24	14	1.5	24	1.5	0.4	0.03
L-EWHB-30	18	1.5	30	1.5	0.5	0.04
L-EWHB-36	22	1.5	36	1.5	0.6	0.05
L-EWHB-42	26	1.5	42	1.5	0.7	0.05
L-EWHB-48	29	1.5	48	1.5	0.8	0.06
L-EWHB-54	32	1.5	54	1.5	0.9	0.07
L-EWHB-60	36	1.5	60	1.5	1.0	0.08
L-EWHB-66	40	1.5	66	1.5	1.1	0.09
L-EWHB-72	42	1.5	72	1.5	1.2	0.09

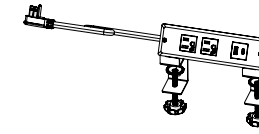

What's Included:

Clamp mount desktop power module equipped with two ac outlets, one USB A and one USB C charging ports, and one (1) three prong cord

How to Specify:

Can be used on freestanding surface or surface with 1" wireplay if connected to a panel

Available in black only

Dimensions:

Cord length: 120"

Power Module Width: 8"

Notes:

Clamp requires 1 3/4" x 8 1/8" undersurface clearance

Code	Price	H	W	D	Weight (lb.)	Volume (ft ³)
V-EMW-2AC	183	6	4	3	1.0	0.04

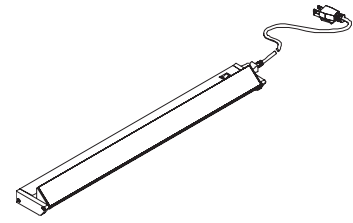

What's Included:

One (1) fluorescent task light

How to Specify:

One size smaller than the width of the overhead

Available in silver only

Dimensions:

Length: 24", 36", 48"

Notes:

Task light can be mounted to metal or laminate overheads

Task light mounts to metal overheads using supplied magnets

Code	Price	H	W	D	Weight (lb.)	Volume (ft ³)
V-ELU-24	302	3	24	1	9.5	0.04
V-ELU-36	340	3	36	1	13.7	0.06
V-ELU-48	427	3	48	1	17.9	0.08

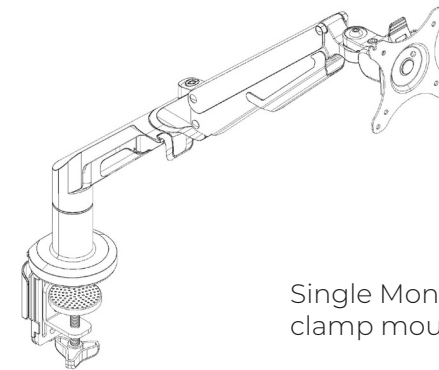

Single Monitor Arm - clamp mount

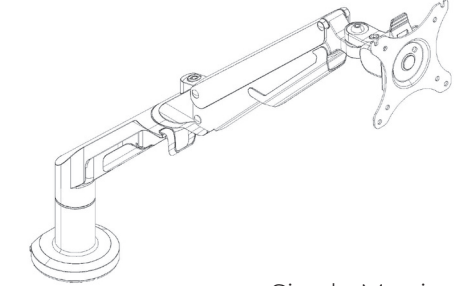

Single Monitor Arm - grommet mount

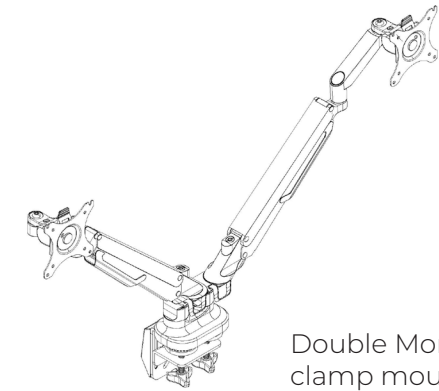

Double Monitor Arm - clamp mount

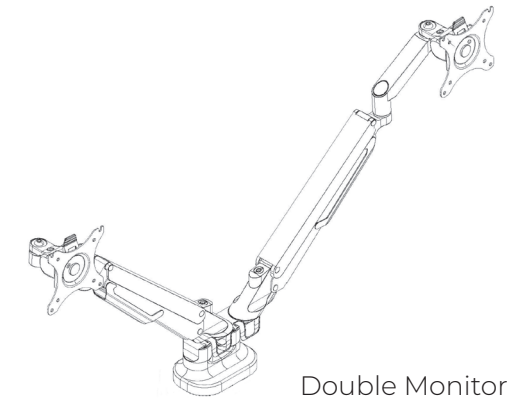

Double Monitor Arm - grommet mount

What's Included:

One monitor arm and installation hardware for both clamp and grommet mount

How to Specify:

- Specify type

Notes:

Available in silver only

Single Monitor Arm

- Screen Size - 17"-36"
- Load Capacity - 6.6-26.4lbs/3-12kg
- Tilt Range - -90 degrees - -15 degrees

Dual Monitor Arm

- Screen Size - 17"-32"
- Load Capacity - 4.4-19.8lbs/2-9kg
- Tilt Range - -90 degrees - -15 degrees

Dimensions:

Vesa: 75x75 and 100x100

Code	Price
Monitor Arm - Single Mount	
V-AFMA-01	374
Monitor Arm - Double Mount	
V-AFMA-02	624

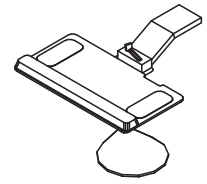

Articulating Keyboard Tray w/Mouse Tray

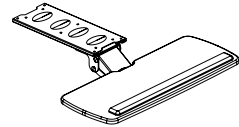

Articulating Keyboard Tray

What's Included:

Keyboard Tray, installation hardware.

How to Specify:

Specify laminate color for retractable keyboard. The vinyl trim color will default to match the laminate color unless otherwise specified. See the laminate finish card for details.

For articulating keyboard with mouse, right or left hand must be specified.

The articulating keyboards are available only in black.

Notes:

Keyboard trays provide adjustable ergonomic support for individuals in multi-task environments

Options:

Finish: laminate colors (retractable keyboard only)

Hand: **R** right **L** left (for adjustable keyboard with mouse only)

Code	Price	H	W	D	Volume (ft ³)	Weight (lb)
Articulating Keyboard Tray w/Mouse Tray						
V-KAS0-2011-L	629	0	20	11	0	3
V-KAS0-2011-R	629	0	20	11	0	3
Articulating Keyboard Tray						
V-KASX-2510	380	0	25	10	0	15

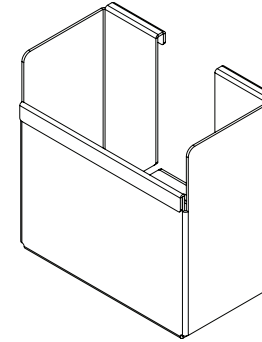

pencil holder

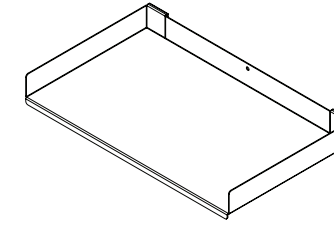

paper tray - legal

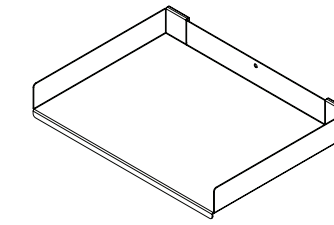

paper tray - letter

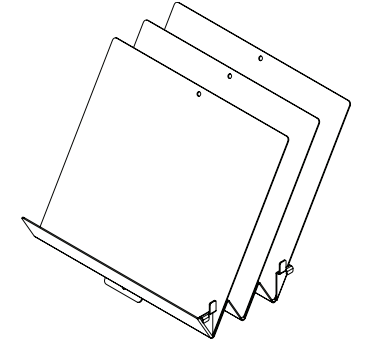

document sorter

What's Included:

One (1) paper tray or one (1) paper holder or one (1) paper sorter

How to Specify:

Refer to metal paint card for metal paint colors

Notes:

Dimensions:

Code	Price	H	W	D	Weight (lb.)	Volume (ft ³)
pen holder						
L-AAP0	115	6	4	2	0.3	
paper tray - legal						
L-AAP-13	142	11	13	1	3.2	
paper tray - letter						
L-AAP-9	123	11	9	1	2.1	
paper sorter						
L-AAS	218	10	10	10	3.2	

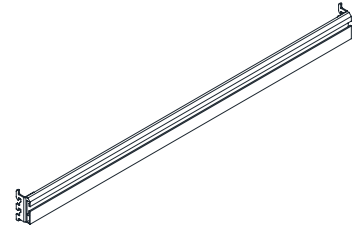

What's Included:

One (1) panel mount or wall mount accessory rail

How to Specify:

Panel mount, wall mount

Choose black, silver, white or charcoal for accessory rail color

Notes:

Dimensions:

Width: 24", 30", 36", 42", 48", 54", 60"

Code	Price	H	W	D	Weight (lb.)	Volume (ft ³)
Panel Mounted						
L-AR-24	195	3	24	0.75	0.8	
L-AR-30	202	3	30	0.75	0.9	
L-AR-36	208	3	36	0.75	1.0	
L-AR-42	218	3	42	0.75	1.0	
L-AR-48	227	3	48	0.75	1.1	
L-AR-54	235	3	54	0.75	1.2	
L-AR-60	245	3	60	0.75	1.3	
Wall Mounted						
L-AR-24-W	195	3	24	0.75	0.8	
L-AR-30-W	202	3	30	0.75	0.9	
L-AR-36-W	208	3	36	0.75	1.0	
L-AR-42-W	218	3	42	0.75	1.0	
L-AR-48-W	227	3	48	0.75	1.1	
L-AR-54-W	235	3	54	0.75	1.2	
L-AR-60-W	245	3	60	0.75	1.3	

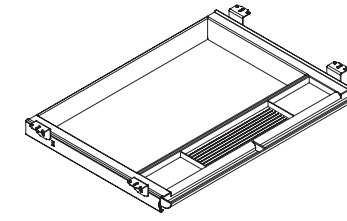

What's Included:

One (1) pencil tray

How to Specify:

Available in black only

Notes:

Available in black only

Dimensions:

Width: 24"

Depth: 16"

Code	Price	H	W	D	Weight (lb.)	Volume (ft ³)
V-ADPP	88	14	21	2	1.8	0.34