

tayco®

USA
Shield Pricebook
May 2024

Contents

Caution	5
Scene Shield	6
U-Shape Shield w/ Clamp	8
U-Shape Raised Shield w/ Clamp	10
U-Shape Shield w/ Bracket	12
Scene Post	17
U-Shape Raised Shield w/ Bracket	18
Single Shield w/ Clamp	20
Single Raised Shield w/ Clamp	22
Single Shield w/ Bracket	24
Single Raised Shield w/ Bracket	26
Shield - End-to-End	28
Raised Shield - End-to-End	30
Shield - End-to-Shared	32
Raised Shield - End-to-Shared	34
Shield - Shared-to-Shared	36
Raised Shield - Shared-to-Shared	38
Post Extended Shield	40
Extended Shield	42

Splits Shield	44
Freestanding Splits Shield	46
Visitor Shield	48
Clear Acrylic Shield	49
Frameless Blade	50
Panel Mounted Shield	52
Freestanding Shield	54
w/ Stationary Wing Base	56
Gallery Shield	58
Freestanding w/ Stationary D-Feet	60
Stationary Skate Feet	62
Mobile Roller Skate Feet	64
Indent w/Stationary Skate Feet	66
Indent w/Mobile Roller Skate Feet	68
Caddy Shield	70
Sanitization Cabinet	72

Load Bottom Drawer First

- Operate one drawer at a time
- Units may tip if loaded incorrectly
- Units should be attached to a wall or other furniture to reduce tipping hazard
- Always load the heaviest files in the bottom drawer

Heavy Load

- Some products must be anchored to wall to ensure stability & safety.
- It is the owner and installers responsibility to ensure that the wall type and construction is of sufficient strength to carry the loads of any wall mounted products and their contents.
- Failure of the wall and anchors to support all imposed loads may result in property damage and/or personal injury.
- Tayco can provide size and empty weight of its products only. As wall blocking is considered a building construction process, Tayco cannot provide recommendations in this respect and cannot be responsible for damage or injury that may occur as a result of improper installation and/or blocking.

Instability Hazard

Mobile items on casters such as flip top, personal and movable tables of any type and storage items of any type may present an instability hazard if not secured correctly while in use or in storage. Flip top tables or training tables of any type, are inherently more unstable when folded. Tayco provides the following guidelines & warnings when using mobile products:

- Lock casters immediately after moving. Do not leave the casters unlocked when in use or in storage.
- Motion may increase the instability of any item with casters. If the wheels hit an obstruction the table's forward momentum often causes overturn, especially if the item is not equipped with wheel extensions. Exercise strong caution while moving these items.
- Use caution when abrupt level changes in the floor are present (such as a doorway or room threshold) as caster failure or tipping may result.
- Do not stand, sit or lean on mobile items for support. They are not intended for this use and personal injury or property damage may result.
- Mobile units that feature height adjustable elements must be lowered to the minimum compressed height when moving to prevent instability. It is also recommended the user remove all computer equipment or other accessories to prevent possible weight imbalance or damage to equipment.
- Failure to follow the guidelines above may result in property damage or personal injury.



USA
Shield Pricebook
May 2024
Scene Shield

Scene Shield

<u>U-Shape Shield w/ Clamp</u>	8
<u>U-Shape Raised Shield w/ Clamp</u>	10
<u>U-Shape Shield w/ Bracket</u>	12
<u>Scene Post</u>	17
<u>U-Shape Raised Shield w/ Bracket</u>	18
<u>Single Shield w/ Clamp</u>	20
<u>Single Raised Shield w/ Clamp</u>	22
<u>Single Shield w/ Bracket</u>	24
<u>Single Raised Shield w/ Bracket</u>	26
<u>Shield - End-to-End</u>	28
<u>Raised Shield - End-to-End</u>	30
<u>Shield - End-to-Shared</u>	32
<u>Raised Shield - End-to-Shared</u>	34
<u>Shield - Shared-to-Shared</u>	36
<u>Raised Shield - Shared-to-Shared</u>	38
<u>Post Extended Shield</u>	40
<u>Extended Shield</u>	42

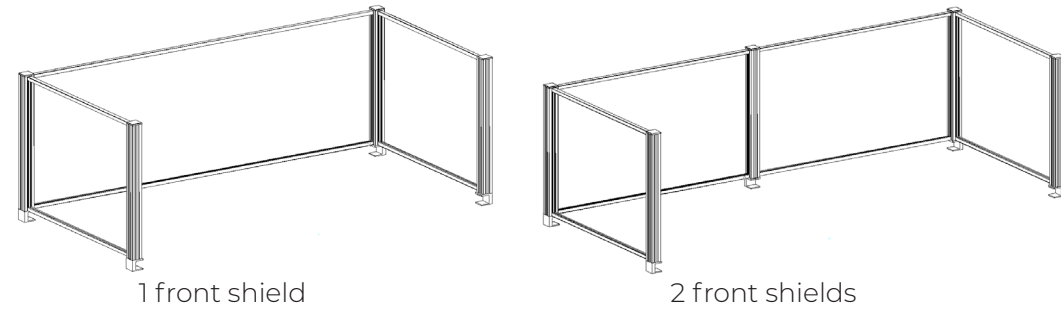

What's Included:

36"W-60"W:

- 4 Scene posts with 4 clamps
- 1 front shield and 2 side shields to create a u-shape
- 3 sets of horizontal retainers

66"W-72":

- 5 Scene posts with 5 clamps
- 2 front shield and 2 side shields to create a u-shape
- 4 sets of horizontal retainers

How to Specify:

Specify based on width and depth of the worksurface the shield will be fastened to

Notes:

Attached to surface with a clamp and does not require drilling into the surface

Clamp mount is clamped onto the worksurface and requires 1.5" of clearance

Acrylic is 3/16" thick

Options:

Depth: 30" _____

Widths: 48", 54", 60", 66", 72" _____

Heights: 24" _____

Shield finish _____

Metal post & retainer paint finish _____

Clear Acrylic

Code	Price	Height (in)	Depth (in)	Width (in)
W-SC-U-243048-C	\$1312	24	30	48
W-SC-U-243054-C	\$1336	24	30	54
W-SC-U-243060-C	\$1359	24	30	60
W-SC-U-243066-C	\$1573	24	30	66
W-SC-U-243072-C	\$1595	24	30	72

Frosted Acrylic

Code	Price	Height (in)	Depth (in)	Width (in)
W-SC-U-243048-F	\$1681	24	30	48
W-SC-U-243054-F	\$1726	24	30	54
W-SC-U-243060-F	\$1769	24	30	60
W-SC-U-243066-F	\$1998	24	30	66
W-SC-U-243072-F	\$2041	24	30	72

Laminate

Code	Price	Height (in)	Depth (in)	Width (in)
W-SC-U-243048-L	\$1460	24	30	48
W-SC-U-243054-L	\$1477	24	30	54
W-SC-U-243066-L	\$1759	24	30	66
W-SC-U-243072-L	\$1774	24	30	72

P.E.T. Acoustic Board

Code	Price	Height (in)	Depth (in)	Width (in)
W-SC-U-243048-P	\$2133	24	30	48
W-SC-U-243054-P	\$2134	24	30	54
W-SC-U-243060-P	\$2137	24	30	60
W-SC-U-243066-P	\$2519	24	30	66
W-SC-U-243072-P	\$2526	24	30	72

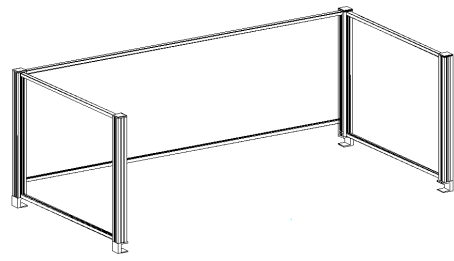

1 front shield

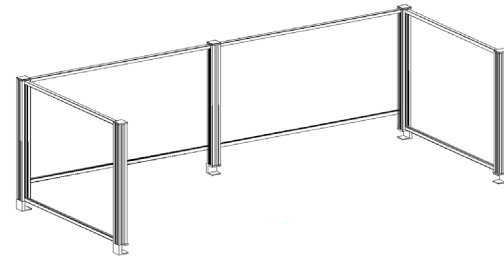

2 front shields

What's Included:

36"W-60"W:

- 4 Scene posts with 4 clamps
- 1 front shield and 2 side shields to create a u-shape
- 3 sets of horizontal retainers

66"W-72":

- 5 Scene posts with 5 clamps
- 2 front shield and 2 side shields to create a u-shape
- 4 sets of horizontal retainers

How to Specify:

Specify based on width and depth of the worksurface the shield will be fastened to

Notes:

Attached to surface with a clamp and does not require drilling into the surface

Clamp mount is clamped onto the worksurface and requires 1.5" of clearance

Front of shield is raised 4" off the worksurface

Shield finish available in clear acrylic only

Acrylic is 3/16" thick

Standard Options:

Depth: 30"

Widths: 48", 54", 60, 66, 72

Heights: 24"

Metal post & retainer paint finish

Clear Acrylic

Code	Price	Height (in)	Depth (in)	Width (in)
W-SC-R-243048-C	\$1312	24	30	48
W-SC-R-243054-C	\$1336	24	30	54
W-SC-R-243060-C	\$1359	24	30	60
W-SC-R-243066-C	\$1573	24	30	66
W-SC-R-243072-C	\$1595	24	30	72

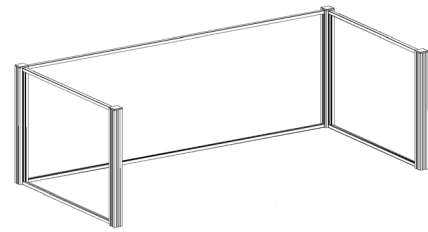

1 front shield

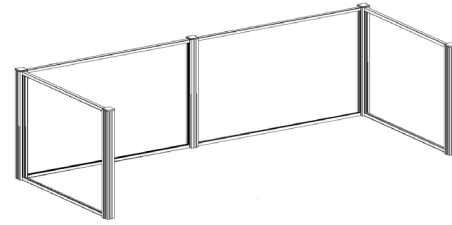

2 front shields

What's Included:

34"W-60"W:

- 4 Scene posts with 4 flat brackets
- 1 front shield and 2 side shields to create a u-shape
- 3 sets of horizontal retainers

64"W-72":

- 5 Scene posts with 5 flat brackets
- 2 front shield and 2 side shields to create a u-shape
- 4 sets of horizontal retainers

How to Specify:

Specify based on width and depth of the worksurface the shield will be fastened to

Integrated Options:

Depth: 23", 29"

Widths: 34", 40", 46", 52", 58", 64", 70"

Heights: 24"

Shield finish

Metal post & retainer paint finish

Notes:

Attached to surface with a bracket and requires drilling into the surface

23"D and 29" D are for integrated Height Adjustable Tables. A 1" pinch point on two sides and the front have been taken into account.

Acrylic is 3/16" thick

Standard Options:

Depth: 24", 30"

Widths at 24"D: 36", 42", 48", 54", 60", 66", 72"

Widths at 30"D: 48", 54", 60"

Heights: 24"

Shield finish

Metal post & retainer paint finish

Clear Acrylic

Code	Price	Height (in)	Depth (in)	Width (in)
W-SB-U-242334-C	\$1204	24	23	34
W-SB-U-242340-C	\$1227	24	23	40
W-SB-U-242346-C	\$1252	24	23	46
W-SB-U-242352-C	\$1272	24	23	52
W-SB-U-242358-C	\$1296	24	23	58
W-SB-U-242364-C	\$1482	24	23	64
W-SB-U-242370-C	\$1496	24	23	70
W-SB-U-242436-C	\$1220	24	24	36
W-SB-U-242442-C	\$1243	24	24	42
W-SB-U-242448-C	\$1267	24	24	48
W-SB-U-242454-C	\$1291	24	24	54
W-SB-U-242460-C	\$1312	24	24	60
W-SB-U-242466-C	\$1520	24	24	66
W-SB-U-242472-C	\$1542	24	24	72
W-SB-U-242934-C	\$1252	24	29	34
W-SB-U-242940-C	\$1272	24	29	40
W-SB-U-242946-C	\$1296	24	29	46
W-SB-U-242952-C	\$1319	24	29	52
W-SB-U-242958-C	\$1343	24	29	58
W-SB-U-242964-C	\$1555	24	29	64
W-SB-U-242970-C	\$1578	24	29	70
W-SB-U-243036-C	\$1267	24	30	36
W-SB-U-243042-C	\$1291	24	30	42
W-SB-U-243048-C	\$1312	24	30	48
W-SB-U-243054-C	\$1336	24	30	54
W-SB-U-243060-C	\$1359	24	30	60
W-SB-U-243066-C	\$1573	24	30	66
W-SB-U-243072-C	\$1595	24	30	72

Frosted Acrylic

Code	Price	Height (in)	Depth (in)	Width (in)
W-SB-U-242340-F	\$1523	24	23	40
W-SB-U-242346-F	\$1566	24	23	46
W-SB-U-242352-F	\$1611	24	23	52
W-SB-U-242358-F	\$1653	24	23	58
W-SB-U-242364-F	\$1889	24	23	64
W-SB-U-242370-F	\$1932	24	23	70
W-SB-U-242436-F	\$1507	24	24	36
W-SB-U-242442-F	\$1552	24	24	42
W-SB-U-242448-F	\$1593	24	24	48
W-SB-U-242454-F	\$1639	24	24	54
W-SB-U-242460-F	\$1681	24	24	60
W-SB-U-242466-F	\$1901	24	24	66
W-SB-U-242472-F	\$1948	24	24	72
W-SB-U-242934-F	\$1566	24	29	34
W-SB-U-242940-F	\$1611	24	29	40
W-SB-U-242946-F	\$1653	24	29	46
W-SB-U-242952-F	\$1697	24	29	52
W-SB-U-242958-F	\$1739	24	29	58
W-SB-U-242964-F	\$1980	24	29	64
W-SB-U-242970-F	\$2031	24	29	70
W-SB-U-243036-F	\$1593	24	30	36
W-SB-U-243042-F	\$1639	24	30	42
W-SB-U-243048-F	\$1681	24	30	48
W-SB-U-243054-F	\$1726	24	30	54
W-SB-U-243060-F	\$1769	24	30	60
W-SB-U-243066-F	\$1998	24	30	66
W-SB-U-243072-F	\$2041	24	30	72

Laminate

Code	Price	Height (in)	Depth (in)	Width (in)
W-SB-U-242334-L	\$1379	24	23	34
W-SB-U-242340-L	\$1398	24	23	40
W-SB-U-242346-L	\$1414	24	23	46
W-SB-U-242352-L	\$1431	24	23	52
W-SB-U-242358-L	\$1447	24	23	58
W-SB-U-242364-L	\$1716	24	23	64
W-SB-U-242370-L	\$1728	24	23	70
W-SB-U-242436-L	\$1388	24	24	36
W-SB-U-242442-L	\$1409	24	24	42
W-SB-U-242448-L	\$1425	24	24	48
W-SB-U-242454-L	\$1441	24	24	54
W-SB-U-242460-L	\$1460	24	24	60
W-SB-U-242466-L	\$1721	24	24	66
W-SB-U-242472-L	\$1733	24	24	72
W-SB-U-242934-L	\$1414	24	29	34
W-SB-U-242940-L	\$1431	24	29	40
W-SB-U-242946-L	\$1447	24	29	46
W-SB-U-242952-L	\$1466	24	29	52
W-SB-U-242958-L	\$1482	24	29	58
W-SB-U-242964-L	\$1751	24	29	64
W-SB-U-242970-L	\$1774	24	29	70
W-SB-U-243036-L	\$1425	24	30	36
W-SB-U-243042-L	\$1441	24	30	42
W-SB-U-243048-L	\$1460	24	30	48
W-SB-U-243054-L	\$1477	24	30	54
W-SB-U-243060-L	\$1492	24	30	60
W-SB-U-243066-L	\$1759	24	30	66
W-SB-U-243072-L	\$1774	24	30	72

P.E.T. Acoustic Board

Code	Price	Height (in)	Depth (in)	Width (in)
W-SB-U-242334-P	\$1931	24	23	34
W-SB-U-242340-P	\$1932	24	23	40
W-SB-U-242346-P	\$1936	24	23	46
W-SB-U-242352-P	\$2128	24	23	52
W-SB-U-242358-P	\$2132	24	23	58
W-SB-U-242364-P	\$2502	24	23	64
W-SB-U-242370-P	\$2519	24	23	70
W-SB-U-242436-P	##N/A	24	24	36
W-SB-U-242442-P	##N/A	24	24	42
W-SB-U-242448-P	##N/A	24	24	48
W-SB-U-242454-P	##N/A	24	24	54
W-SB-U-242460-P	##N/A	24	24	60
W-SB-U-242466-P	##N/A	24	24	66
W-SB-U-242472-P	##N/A	24	24	72
W-SB-U-242934-P	##N/A	24	29	34
W-SB-U-242940-P	##N/A	24	29	40
W-SB-U-242946-P	##N/A	24	29	46
W-SB-U-242952-P	##N/A	24	29	52
W-SB-U-242958-P	##N/A	24	29	58
W-SB-U-242964-P	##N/A	24	29	64
W-SB-U-242970-P	##N/A	24	29	70
W-SB-U-243054-C	\$1336	24	30	54
W-SB-U-243060-C	\$1359	24	30	60
W-SB-U-243066-C	\$1573	24	30	66
W-SB-U-243072-C	\$1595	24	30	72



standard scene post



post w/ clamp



post w/ bracket



post w/ four way connection bracket

What's Included:

- 1 Scene post
- Mounting hardware

How to Specify:

Specify by mounting type

Notes:

- Direct mount is fastened through the underside of the worksurface
- Flat bracket mount is fastened through the top of the worksurface
- Clamp mount is clamped onto the worksurface and requires 1.5" of clearance
- W-PS-24-C clamp mount accommodates 1" - 1 1/4" thick surface
- W-PS-24-CT clamp mount accommodates 1 1/4" - 1 5/8" thick surface

Options:

- Height: 24"
- Mounting hardware
- Metal post paint finish

Code	Price	Height (in)
W-PS-24	\$90	24
W-PS-24-B	\$127	24
W-PS-24-C	\$127	24
W-PS-24-B-4	\$143	24
W-PS-24-CT	\$137	24

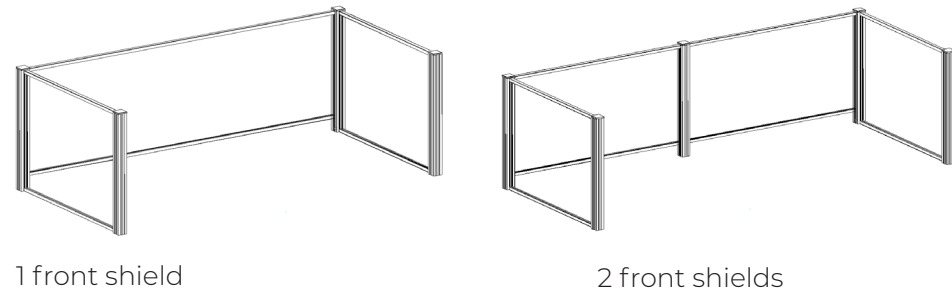

What's Included:

34"W-60"W:

- 4 Scene posts with 4 flat brackets
- 1 front shield and 2 side shields to create a u-shape
- 3 sets of horizontal retainers

64"W-72":

- 5 Scene posts with 5 flat brackets
- 2 front shield and 2 side shields to create a u-shape
- 4 sets of horizontal retainers

How to Specify:

Specify based on width and depth of the worksurface the shield will be fastened to

Specify regular or cropped width

Integrated Options

Depth: 24", 30"

Width: 34", 40", 52", 58", 64", 70"

Heights: 24"

Metal post & retainer paint finish

Notes:

Attached to surface with a clamp and does not require drilling into the surface

Shield can be placed along the width or the depth of the worksurface

Cropped width is 2" shorter

Clamp mount is clamped onto the worksurface and requires 1.5" of clearance

Front shield is raised 4" off the worksurface

Available in clear acrylic only

Acrylic is 3/16" thick

Standard Width Options:

Depth: 24", 30"

Widths: 36", 42", 48", 54", 60", 66", 72"

Heights: 24"

Metal post & retainer paint finish

Clear Acrylic

Code	Price	Height (in)	Depth (in)	Width (in)
W-SB-R-242334-C	\$1204	24	23	34
W-SB-R-242340-C	\$1227	24	23	40
W-SB-R-242346-C	\$1252	24	23	46
W-SB-R-242352-C	\$1272	24	23	52
W-SB-R-242358-C	\$1296	24	23	58
W-SB-R-242364-C	\$1482	24	23	64
W-SB-R-242370-C	\$1496	24	23	70
W-SB-R-242934-C	\$1252	24	29	34
W-SB-R-242940-C	\$1272	24	29	40
W-SB-R-242946-C	\$1296	24	29	46
W-SB-R-242952-C	\$1319	24	29	52
W-SB-R-242958-C	\$1343	24	29	58
W-SB-R-242964-C	\$1555	24	29	64
W-SB-R-242970-C	\$1578	24	29	70
W-SB-R-242436-C	\$1220	24	24	36
W-SB-R-242442-C	\$1243	24	24	42
W-SB-R-242448-C	\$1267	24	24	48
W-SB-R-242454-C	\$1291	24	24	54
W-SB-R-242460-C	\$1312	24	24	60
W-SB-R-242466-C	\$1520	24	24	66
W-SB-R-242472-C	\$1542	24	24	72
W-SB-R-243036-C	\$1267	24	30	36
W-SB-R-243042-C	\$1291	24	30	42
W-SB-R-243048-C	\$1312	24	30	48
W-SB-R-243054-C	\$1336	24	30	54
W-SB-R-243060-C	\$1359	24	30	60
W-SB-R-243066-C	\$1573	24	30	66
W-SB-R-243072-C	\$1595	24	30	72

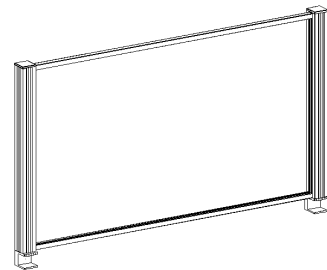

1 front shield

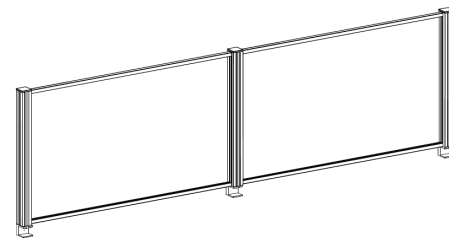

2 front shields

What's Included:

24"W-60"W:

- 2 Scene posts with 2 clamps
- 1 front shield
- 1 set of horizontal retainers

66"W-72":

- 3 Scene posts with 3 clamps
- 2 front shields
- 2 sets of horizontal retainers

How to Specify:

Specify based on width and depth of the worksurface the shield will be fastened to

Standard Width Options:

Widths: 24", 30", 36", 42", 48", 54", 60", 66", 72"

Heights: 24"

Shield finish

Metal post & retainer paint finish

Notes:

Attached to surface with a clamp and does not require drilling into the surface

Shield can be placed along the width or the depth of the worksurface

Clamp mount is clamped onto the worksurface and requires 1.5" of clearance

Acrylic is 3/16" thick

Clear Acrylic

Code	Price	Height (in)	Width (in)
W-SC-S-2424-C	\$557	24	24
W-SC-S-2430-C	\$563	24	30
W-SC-S-2436-C	\$586	24	36
W-SC-S-2442-C	\$611	24	42
W-SC-S-2448-C	\$632	24	48
W-SC-S-2454-C	\$654	24	54
W-SC-S-2460-C	\$681	24	60
W-SC-S-2466-C	\$702	24	66
W-SC-S-2472-C	\$738	24	72

Frosted Acrylic

Code	Price	Height (in)	Width (in)
W-SC-S-2424-F	\$675	24	24
W-SC-S-2430-F	\$690	24	30
W-SC-S-2436-F	\$712	24	36
W-SC-S-2442-F	\$755	24	42
W-SC-S-2448-F	\$797	24	48
W-SC-S-2454-F	\$842	24	54
W-SC-S-2460-F	\$885	24	60
W-SC-S-2466-F	\$924	24	66
W-SC-S-2472-F	\$986	24	72

Laminate

Code	Price	Height (in)	Width (in)
W-SC-S-2424-L	\$661	24	24
W-SC-S-2430-L	\$667	24	30
W-SC-S-2436-L	\$685	24	36
W-SC-S-2442-L	\$701	24	42
W-SC-S-2448-L	\$718	24	48
W-SC-S-2454-L	\$735	24	54
W-SC-S-2460-L	\$753	24	60
W-SC-S-2466-L	\$781	24	66
W-SC-S-2472-L	\$811	24	72

P.E.T. Acoustic Board

Code	Price	Height (in)	Width (in)
W-SC-S-2424-P	\$1064	24	24
W-SC-S-2430-P	##N/A	24	30
W-SC-S-2436-P	##N/A	24	36
W-SC-S-2442-P	##N/A	24	42
W-SC-S-2448-P	\$1204	24	48
W-SC-S-2454-P	##N/A	24	54
W-SC-S-2460-P	\$1425	24	60
W-SC-S-2466-P	\$1553	24	66
W-SC-S-2472-P	\$1567	24	72

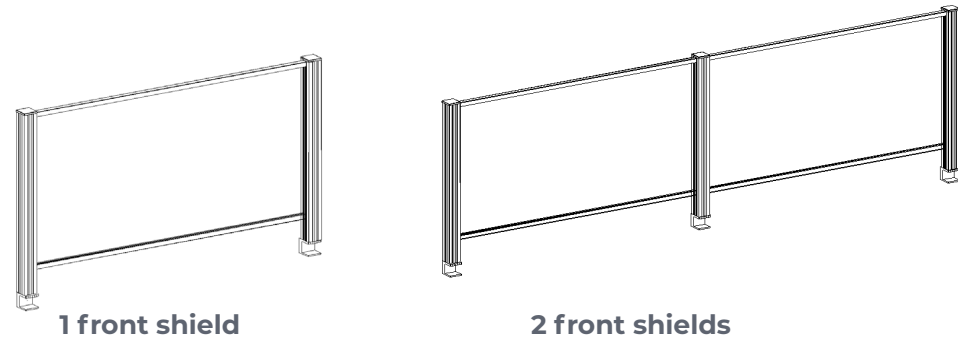

What's Included:

24"W-60"W:

- 2 Scene posts with 2 clamps
- 1 front shield
- 1 set of horizontal retainers

66"W-72":

- 3 Scene posts with 3 clamps
- 2 front shields
- 2 sets of horizontal retainers

Notes:

Attached to surface with a clamp and does not require drilling into the surface

Shield can be placed along the width or the depth of the worksurface

Clamp mount is clamped onto the worksurface and requires 1.5" of clearance

Shield is raised 4" above the worksurface

Available in clear acrylic only

Acrylic is 3/16" thick

How to Specify:

Specify based on width and depth of the worksurface the shield will be fastened to

Standard Width Options:

Widths: 24", 30", 36", 42", 48", 54", 60", 66", 72"

Heights: 24"

Metal post & retainer paint finish

Clear Acrylic

Code	Price	Height (in)	Width (in)	Weight
W-SC-R-2424-C	557	24	24	9.51
W-SC-R-2430-C	563	24	30	9.97
W-SC-R-2436-C	586	24	36	10.7
W-SC-R-2442-C	611	24	42	11.88
W-SC-R-2448-C	632	24	48	12.94
W-SC-R-2454-C	654	24	54	13.97
W-SC-R-2460-C	681	24	60	14.97
W-SC-R-2466-C	702	24	66	15.9
W-SC-R-2472-C	738	24	72	16.5

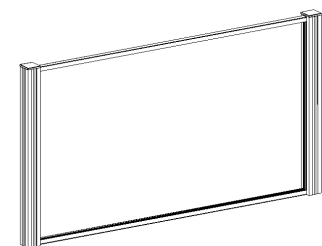

1 front shield

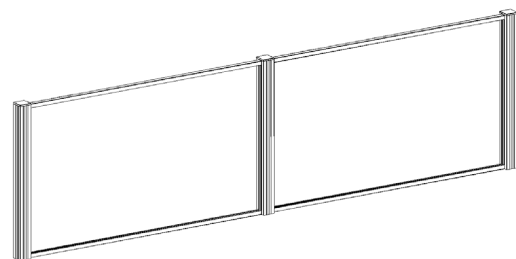

2 front shields

What's Included:

- 24"W-60"W:
- 2 Scene posts with 2 flat brackets
 - 1 front shield
 - 1 set of horizontal retainers
- 64"W-72":
- 3 Scene posts with 3 flat brackets
 - 2 front shields
 - 2 sets of horizontal retainers

How to Specify:

Specify based on width and depth of the worksurface the shield will be fastened to
Specify regular or cropped width

Notes:

Attached to surface with a bracket and requires drilling into the surface
Shield can be placed along the width or the depth of the worksurface
Acrylic is 3/16" thick

Integrated Width Options:

Width: 34", 40", 52", 58", 64", 70"
Heights: 24"
Shield finish
Metal post & retainer paint finish

Standard Width Options:

Widths: 24", 30", 36", 42", 48", 54", 60", 66", 72"
Heights: 24"
Shield finish
Metal post & retainer paint finish

Clear Acrylic

Code	Price	Height (in)	Width (in)
W-SB-S-2424-C	\$557	24	24
W-SB-S-2430-C	\$563	24	30
W-SB-S-2434-C	\$579	24	34
W-SB-S-2436-C	\$586	24	36
W-SB-S-2440-C	\$602	24	40
W-SB-S-2442-C	\$611	24	42
W-SB-S-2446-C	\$626	24	46
W-SB-S-2448-C	\$632	24	48
W-SB-S-2452-C	\$649	24	52
W-SB-S-2454-C	\$654	24	54
W-SB-S-2458-C	\$671	24	58
W-SB-S-2460-C	\$681	24	60
W-SB-S-2464-C	\$690	24	64
W-SB-S-2466-C	\$702	24	66
W-SB-S-2470-C	\$726	24	70
W-SB-S-2472-C	\$738	24	72

Laminate

Code	Price	Height (in)	Width (in)
W-SB-S-2424-L	\$661	24	24
W-SB-S-2430-L	\$667	24	30
W-SB-S-2434-L	\$679	24	34
W-SB-S-2436-L	\$685	24	36
W-SB-S-2440-L	\$694	24	40
W-SB-S-2442-L	\$701	24	42
W-SB-S-2446-L	\$713	24	46
W-SB-S-2448-L	\$718	24	48
W-SB-S-2452-L	\$729	24	52
W-SB-S-2454-L	\$735	24	54
W-SB-S-2458-L	\$745	24	58
W-SB-S-2460-L	\$753	24	60
W-SB-S-2464-L	\$757	24	64
W-SB-S-2466-L	\$781	24	66
W-SB-S-2470-L	\$793	24	70
W-SB-S-2472-L	\$811	24	72

Frosted Acrylic

Code	Price	Height (in)	Width (in)
W-SB-S-2424-F	\$675	24	24
W-SB-S-2430-F	\$690	24	30
W-SB-S-2434-F	\$695	24	34
W-SB-S-2436-F	\$712	24	36
W-SB-S-2440-F	\$739	24	40
W-SB-S-2442-F	\$755	24	42
W-SB-S-2446-F	\$782	24	46
W-SB-S-2448-F	\$797	24	48
W-SB-S-2452-F	\$828	24	52
W-SB-S-2454-F	\$842	24	54
W-SB-S-2458-F	\$870	24	58
W-SB-S-2460-F	\$885	24	60
W-SB-S-2464-F	\$911	24	64
W-SB-S-2466-F	\$924	24	66
W-SB-S-2470-F	\$953	24	70
W-SB-S-2472-F	\$986	24	72

P.E.T. Acoustic Board

Code	Price	Height (in)	Width (in)
W-SB-S-2424-P	\$1064	24	24
W-SB-S-2430-P	\$1111	24	30
W-SB-S-2434-P	\$1200	24	34
W-SB-S-2436-P	\$1201	24	36
W-SB-S-2440-P	\$1202	24	40
W-SB-S-2442-P	\$1203	24	42
W-SB-S-2446-P	\$1204	24	46
W-SB-S-2448-P	\$1204	24	48
W-SB-S-2452-P	\$1421	24	52
W-SB-S-2454-P	\$1421	24	54
W-SB-S-2458-P	\$1423	24	58
W-SB-S-2460-P	\$1425	24	60
W-SB-S-2464-P	\$1549	24	64
W-SB-S-2466-P	\$1553	24	66
W-SB-S-2470-P	\$1560	24	70
W-SB-S-2472-P	\$1567	24	72

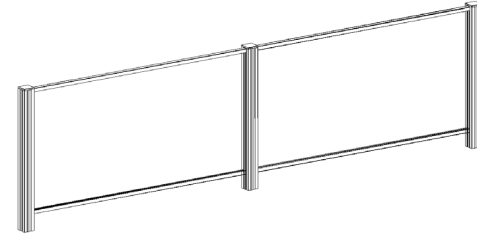
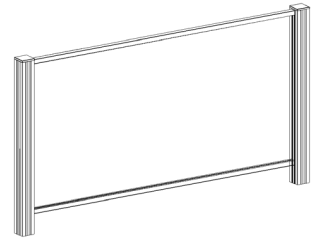

1 front shield

2 front shields

What's Included:

24"W-60"W:

- 2 Scene posts with 2 flat brackets
- 1 front shield
- 1 set of horizontal retainers

64"W-72":

- 3 Scene posts with 3 flat brackets
- 2 front shields
- 2 sets of horizontal retainers

How to Specify:

Specify based on width and depth of the worksurface the shield will be fastened to
Specify regular or cropped width

Notes:

Attached to surface with a clamp and does not require drilling into the surface

Shield can be placed along the width or the depth of the worksurface

Raised shield sits 4" above worksurface

Cropped width is 2" shorter

Clamp mount is clamped onto the worksurface and requires 1.5" of clearance

Available in clear acrylic only

Acrylic is 3/16" thick

Integrated Width Options:

Width: 34", 40", 52", 58", 64", 70"

Heights: 24"

Metal post & retainer paint finish

Standard Width Options:

Widths: 24", 30", 36", 42", 48", 54", 60", 66", 72"

Heights: 24"

Metal post & retainer paint finish

Clear Acrylic

Code	Price	Height (in)	Width (in)
W-SB-R-2424-C	\$557	24	24
W-SB-R-2430-C	\$563	24	30
W-SB-R-2434-C	\$579	24	34
W-SB-R-2436-C	\$586	24	36
W-SB-R-2440-C	\$602	24	40
W-SB-R-2442-C	\$611	24	42
W-SB-R-2446-C	\$626	24	46
W-SB-R-2448-C	\$632	24	48
W-SB-R-2452-C	\$649	24	52
W-SB-R-2454-C	\$654	24	54
W-SB-R-2458-C	\$671	24	58
W-SB-R-2460-C	\$681	24	60
W-SB-R-2464-C	\$690	24	64
W-SB-R-2466-C	\$702	24	66
W-SB-R-2470-C	\$726	24	70
W-SB-R-2472-C	\$738	24	72

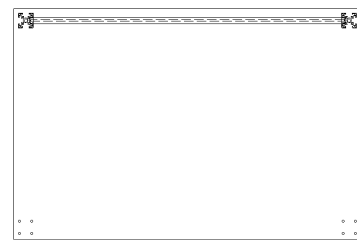
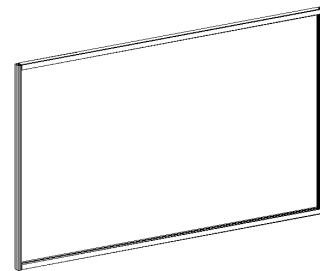

What's Included:

- 1 shield
- 1 set of horizontal retainers

How to Specify:

Specify by width of the worksurface
 End-to-End runs from one edge of the surface to the other

Notes:

Acrylic is 3/16" thick

Options:

- Height: 24"
- Width: 23", 24", 29", 30", 34", 36", 40", 42", 46", 52", 54", 58", 60"
- Shield finish
- Horizontal retainer paint finish

Clear Acrylic

Code	Price	Height (in)	Width (in)
W-SEE-2423-C	\$214	24	23
W-SEE-2424-C	\$218	24	24
W-SEE-2429-C	\$265	24	29
W-SEE-2430-C	\$270	24	30
W-SEE-2434-C	\$311	24	34
W-SEE-2436-C	\$319	24	36
W-SEE-2440-C	\$361	24	40
W-SEE-2442-C	\$383	24	42
W-SEE-2446-C	\$444	24	46
W-SEE-2448-C	\$466	24	48
W-SEE-2452-C	\$475	24	52
W-SEE-2454-C	\$482	24	54
W-SEE-2458-C	\$509	24	58
W-SEE-2460-C	\$554	24	60

Frosted Acrylic

Code	Price	Height (in)	Width (in)
W-SEE-2423-F	\$240	24	23
W-SEE-2424-F	\$243	24	24
W-SEE-2429-F	\$295	24	29
W-SEE-2430-F	\$300	24	30
W-SEE-2434-F	\$348	24	34
W-SEE-2436-F	\$354	24	36
W-SEE-2440-F	\$401	24	40
W-SEE-2442-F	\$426	24	42
W-SEE-2446-F	\$492	24	46
W-SEE-2448-F	\$515	24	48
W-SEE-2452-F	\$526	24	52
W-SEE-2454-F	\$537	24	54
W-SEE-2458-F	\$563	24	58
W-SEE-2460-F	\$617	24	60

Laminate

Code	Price	Height (in)	Width (in)
W-SEE-2423-L	\$196	24	23
W-SEE-2424-L	\$202	24	24
W-SEE-2429-L	\$240	24	29
W-SEE-2430-L	\$243	24	30
W-SEE-2434-L	\$282	24	34
W-SEE-2436-L	\$312	24	36
W-SEE-2440-L	\$329	24	40
W-SEE-2442-L	\$353	24	42
W-SEE-2446-L	\$364	24	46
W-SEE-2448-L	\$371	24	48
W-SEE-2452-L	\$385	24	52
W-SEE-2454-L	\$419	24	54
W-SEE-2458-L	\$426	24	58
W-SEE-2460-L	\$462	24	60

P.E.T. Acoustic Board

Code	Price	Height (in)	Width (in)
W-SEE-2423-P	\$803	24	23
W-SEE-2424-P	\$803	24	24
W-SEE-2429-P	\$849	24	29
W-SEE-2430-P	\$849	24	30
W-SEE-2434-P	\$939	24	34
W-SEE-2436-P	\$940	24	36
W-SEE-2440-P	\$941	24	40
W-SEE-2442-P	\$943	24	42
W-SEE-2446-P	\$946	24	46
W-SEE-2448-P	\$947	24	48
W-SEE-2452-P	\$1209	24	52
W-SEE-2454-P	\$1211	24	54
W-SEE-2458-P	\$1213	24	58
W-SEE-2460-P	\$1213	24	60

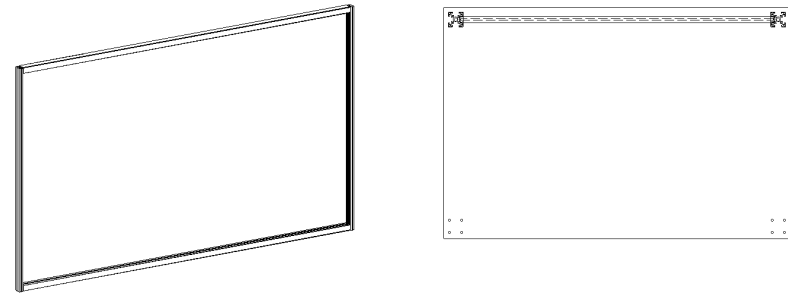

What's Included:

- 1 shield
- 1 set of horizontal retainers

How to Specify:

- Specify by width of the worksurface
- End-to-End runs from one edge of the surface to the other

Notes:

- Shield sits 4" above the worksurface
- Available in clear acrylic only
- Acrylic is 3/16" thick

Options:

- Height: 24"
- Width: 23", 24", 29", 30", 34", 36", 40", 42", 46", 52", 54", 58", 60"
- Horizontal retainer paint finish

Clear Acrylic

Code	Price	Height (in)	Width (in)
W-SEE-2423-C-R	\$214	24	23
W-SEE-2424-C-R	\$218	24	24
W-SEE-2429-C-R	\$265	24	29
W-SEE-2430-C-R	\$270	24	30
W-SEE-2434-C-R	\$311	24	34
W-SEE-2436-C-R	\$319	24	36
W-SEE-2440-C-R	\$361	24	40
W-SEE-2442-C-R	\$383	24	42
W-SEE-2446-C-R	\$444	24	46
W-SEE-2448-C-R	\$466	24	48
W-SEE-2452-C-R	\$475	24	52
W-SEE-2454-C-R	\$482	24	54
W-SEE-2458-C-R	\$509	24	58
W-SEE-2460-C-R	\$554	24	60

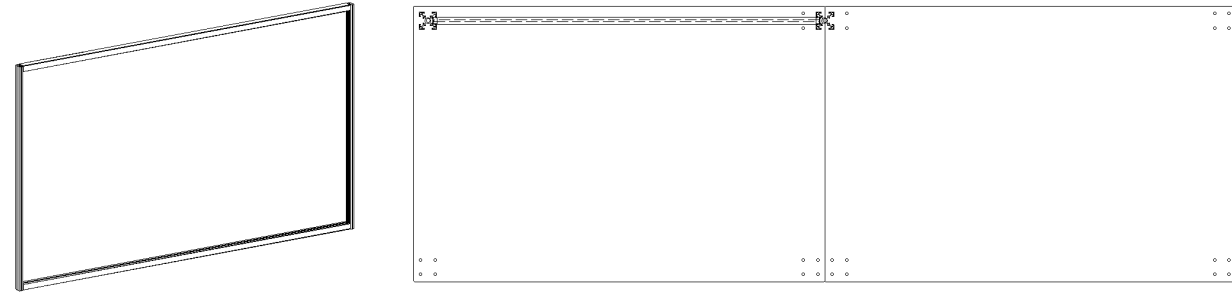

What's Included:

- 1 shield
- 1 set of horizontal retainers

How to Specify:

Specify by width of the worksurface
 End-to-Shared runs from one edge of the worksurface to a shared worksurface post

Notes:

Acrylic is 3/16" thick

Options:

- Height: 24"
- Width: 24", 30", 32", 33", 35", 36", 42", 48", 54", 60"
- Shield finish
- Horizontal retainer paint finish

Clear Acrylic

Code	Price	Height (in)	Width (in)
W-SES-2424-C	\$	24	0.13
W-SES-2430-C	\$	24	0
W-SES-2432-C	\$	24	0
W-SES-2433-C	\$	24	0
W-SES-2435-C	\$	24	0
W-SES-2436-C	\$	24	0.13
W-SES-2442-C	\$	24	0.13
W-SES-2448-C	\$	24	0
W-SES-2454-C	\$	24	0
W-SES-2460-C	\$	24	0

Frosted Acrylic

Code	Price	Height (in)	Width (in)
W-SES-2424-F	\$	24	0.13
W-SES-2430-F	\$	24	0.13
W-SES-2432-F	\$	24	0.13
W-SES-2433-F	\$	24	0.13
W-SES-2435-F	\$	24	0.13
W-SES-2436-F	\$	24	0.13
W-SES-2442-F	\$	24	0
W-SES-2448-F	\$	24	0.13
W-SES-2454-F	\$	24	0.13
W-SES-2460-F	\$	24	0.13

Laminate

Code	Price	Height (in)	Width (in)
W-SES-2424-L	\$	24	0.11
W-SES-2430-L	\$	24	0.11
W-SES-2432-L	\$	24	0.11
W-SES-2433-L	\$	24	0.11
W-SES-2435-L	\$	24	0.11
W-SES-2436-L	\$	24	0.11
W-SES-2442-L	\$	24	0.11
W-SES-2448-L	\$	24	0.11
W-SES-2454-L	\$	24	0.11
W-SES-2460-L	\$	24	0.11

P.E.T. Acoustic Board

Code	Price	Height (in)	Width (in)
W-SES-2424-P	\$	24	0.11
W-SES-2430-P	\$	24	0.11
W-SES-2432-P	\$	24	0.11
W-SES-2433-P	\$	24	0.11
W-SES-2435-P	\$	24	0.11
W-SES-2436-P	\$	24	0.11
W-SES-2442-P	\$	24	0
W-SES-2448-P	\$	24	0.11
W-SES-2454-P	\$	24	0.11
W-SES-2460-P	\$	24	0.11

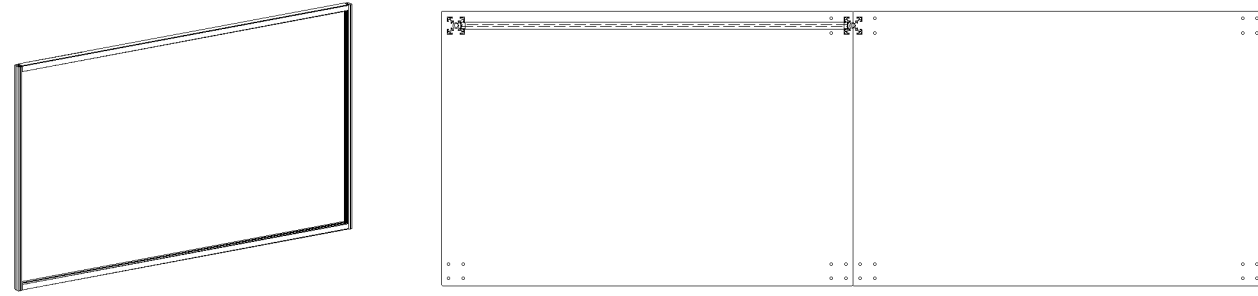

What's Included:

- 1 shield
- 1 set of horizontal retainers

How to Specify:

- Specify by width of the worksurface
- End-to-Shared runs from one edge of the worksurface to a shared worksurface post

Notes:

- Shield sits 4" above worksurface
- Available in clear acrylic only
- Acrylic is 3/16" thick

Options:

- Height: 24"
- Width: 24", 30", 32", 33", 35", 36", 42", 48", 54", 60"
- Horizontal retainer paint finish

Clear Acrylic

Code	Price	Height (in)	Width (in)
W-SES-2424-C-R	\$218	24	24
W-SES-2430-C-R	\$270	24	30
W-SES-2432-C-R	\$300	24	32
W-SES-2433-C-R	\$306	24	33
W-SES-2435-C-R	\$316	24	35
W-SES-2436-C-R	\$319	24	36
W-SES-2442-C-R	\$383	24	42
W-SES-2448-C-R	\$466	24	48
W-SES-2454-C-R	\$482	24	54
W-SES-2460-C-R	\$554	24	60

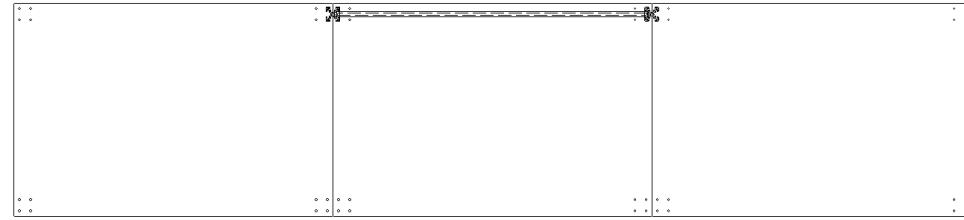
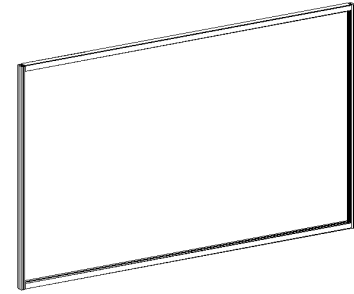

What's Included:

- 1 shield
- 1 set of horizontal retainers

How to Specify:

- Specify by width of the worksurface
- Shared-to-Shared runs from one shared post to the other

Notes:

Acrylic is 3/16" thick

Options:

- Height: 24"
- Width: 24", 30", 36", 42", 48", 54", 60"
- Shield finish
- Horizontal retainer paint finish

Clear Acrylic

Code	Price	Height (in)	Width (in)
W-SSS-2424-C	\$218	24	24
W-SSS-2430-C	\$270	24	30
W-SSS-2436-C	\$319	24	36
W-SSS-2442-C	\$383	24	42
W-SSS-2448-C	\$466	24	48
W-SSS-2454-C	\$482	24	54
W-SSS-2460-C	\$554	24	60

Frosted Acrylic

Code	Price	Height (in)	Width (in)
W-SSS-2424-F	\$243	24	24
W-SSS-2430-F	\$300	24	30
W-SSS-2436-F	\$354	24	36
W-SSS-2442-F	\$426	24	42
W-SSS-2448-F	\$515	24	48
W-SSS-2454-F	\$537	24	54
W-SSS-2460-F	\$617	24	60

Laminate

Code	Price	Height (in)	Width (in)
W-SSS-2424-L	\$202	24	24
W-SSS-2430-L	\$243	24	30
W-SSS-2436-L	\$312	24	36
W-SSS-2442-L	\$353	24	42
W-SSS-2448-L	\$371	24	48
W-SSS-2454-L	\$419	24	54
W-SSS-2460-L	\$462	24	60

P.E.T. Acoustic Board

Code	Price	Height (in)	Width (in)
W-SSS-2424-P	\$846	24	24
W-SSS-2430-P	\$849	24	30
W-SSS-2436-P	\$940	24	36
W-SSS-2442-P	\$943	24	42
W-SSS-2448-P	\$947	24	48
W-SSS-2454-P	\$1211	24	54
W-SSS-2460-P	\$1213	24	60

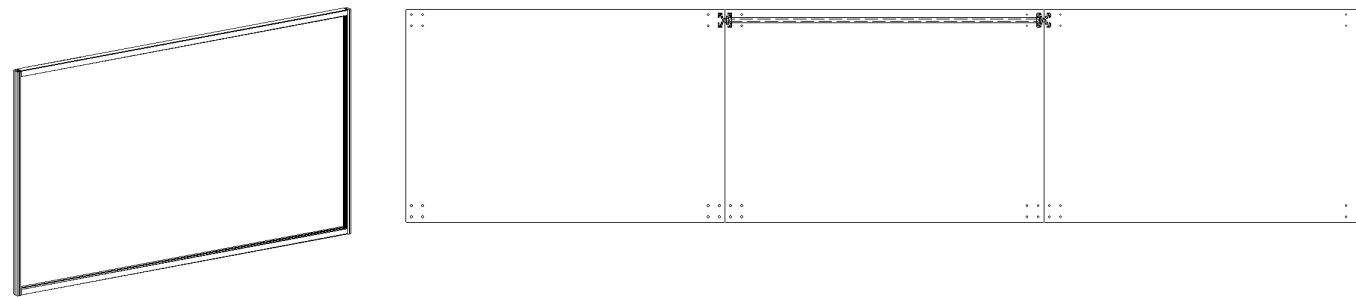

What's Included:

- 1 shield
- 1 set of horizontal retainers

How to Specify:

- Specify by width of the worksurface
- Shared-to-Shared runs from one shared post to the other

Notes:

- Shield sits 4" above worksurface
- Available in clear acrylic only
- Acrylic is 3/16" thick

Options:

- Height: 24"
- Width: 24", 30", 36", 42", 48", 54", 60"
- Horizontal retainer paint finish

Clear Acrylic

Code	Price	Height (in)	Width (in)
W-SSS-2424-C-R	\$218	24	24
W-SSS-2430-C-R	\$270	24	30
W-SSS-2436-C-R	\$319	24	36
W-SSS-2442-C-R	\$383	24	42
W-SSS-2448-C-R	\$466	24	48
W-SSS-2454-C-R	\$482	24	54
W-SSS-2460-C-R	\$554	24	60

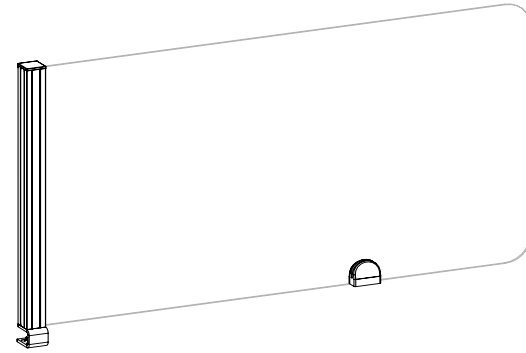

What's Included:

- 1 post with mounting hardware
- 1 shield
- 1 desk top acrylic clamp

How to Specify:

Specify by post mounting type

Notes:

- 24"W and 30"W sits flush with the worksurface depth of the same size
- 36"W is used for 24"D surface with 12" overhang
- 42"W is used for 30"D surface with 12" overhang
- Maximum overhang 12" from the worksurface
- Clamp mount post needs 1.5" clearance
- Desk top acrylic clamps are offered in brushed chrome only
- Acrylic is 3/16" thick

Options:

- Height: 24"
- Width: 24", 30", 36", 42"
- Post mounting type: clamp post or flush mount bracket post
- Shield finish
- Metal post paint finish

Clamp Post - Clear Acrylic

Code	Price	Height (in)	Width (in)
W-SC-E-2424-C	\$614	24	24
W-SC-E-2430-C	\$767	24	30
W-SC-E-2436-C	\$773	24	36
W-SC-E-2442-C	\$779	24	42

Clamp Post - Frosted Acrylic

Code	Price	Height (in)	Width (in)
W-SC-E-2424-F	\$726	24	24
W-SC-E-2430-F	\$862	24	30
W-SC-E-2436-F	\$870	24	36
W-SC-E-2442-F	\$882	24	42

Flush Mount Bracket Post - Clear Acrylic

Code	Price	Height (in)	Width (in)
W-SB-E-2424-C	\$601	24	24
W-SB-E-2430-C	\$750	24	30
W-SB-E-2436-C	\$757	24	36
W-SB-E-2442-C	\$769	24	42

Flush Mount Bracket Post - Frosted Acrylic

Code	Price	Height (in)	Width (in)
W-SB-E-2424-F	\$714	24	24
W-SB-E-2430-F	\$862	24	30
W-SB-E-2436-F	\$866	24	36
W-SB-E-2442-F	\$870	24	42

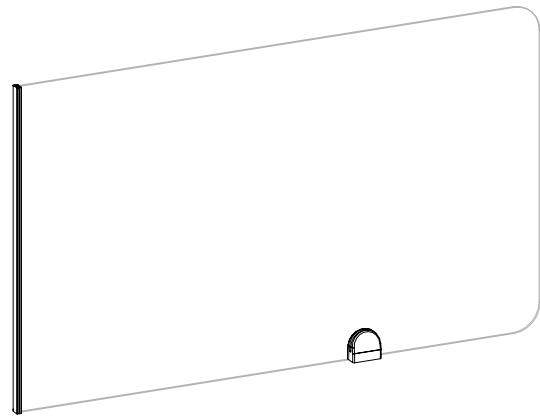

What's Included:

- 1 shield
- 1 desk top acrylic clamp

How to Specify:

Specify by size of the worksurface the shield will be clamped to

Notes:

- Fits with existing 24"H Scene post (not included)
- 24"W and 30"W sits flush with the worksurface depth of the same size
- 36"W is used for 24"D surface with 12" overhang
- 42"W is used for 30"D surface with 12" overhang
- Maximum overhang is 12" from the worksurface
- Clamp mount post needs 1.5" clearance
- Desk top acrylic clamps are offered in brushed chrome only
- Acrylic is 3/16" thick

Options:

- Height: 24"

- Width: 24", 30", 36", 42"

- Shield finish

Clear Acrylic

Code	Price	Height (in)	Width (in)
W-SN-E-2424-C	\$459	24	24
W-SN-E-2430-C	\$557	24	30
W-SN-E-2436-C	\$563	24	36
W-SN-E-2442-C	\$566	24	42

Frosted Acrylic

Code	Price	Height (in)	Width (in)
W-SN-E-2424-F	\$513	24	24
W-SN-E-2430-F	\$652	24	30
W-SN-E-2436-F	\$661	24	36
W-SN-E-2442-F	\$664	24	42



USA
Shield Pricebook
May 2024
Splits Shield

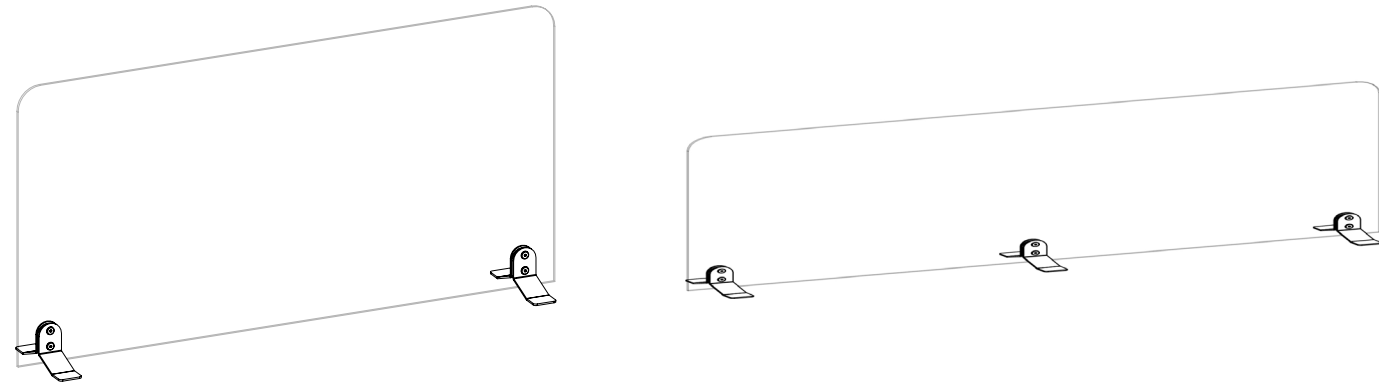

What's Included:

- 18"W-48"W:
1 shield with 4 freestanding split feet
- 54"W-60"W:
1 shield with 6 freestanding split feet

Notes:

- Split feet require a 9" clearance
- Shield is raised by 3/4"
- Available in clear or frosted acrylic or P.E.T. Acoustic Board only
- Acrylic is 1/4" thick

How to Specify:

Specify required size based on size of the worksurface shield will sit on

Options:

- Widths: 18", 24", 30", 36", 42", 48", 54", 60"
- Heights: 24"
- Shield finish
- Metal split feet paint finish

Clear Acrylic

Code	Price	Height (in)	Width (in)
W-SF-P-2418-C	\$624	24	18
W-SF-P-2424-C	\$624	24	24
W-SF-P-2430-C	\$718	24	30
W-SF-P-2436-C	\$720	24	36
W-SF-P-2442-C	\$725	24	42
W-SF-P-2448-C	\$729	24	48
W-SF-P-2454-C	\$900	24	54
W-SF-P-2460-C	\$911	24	60

Frosted Acrylic

Code	Price	Height (in)	Width (in)
W-SF-P-2418-F	\$675	24	18
W-SF-P-2424-F	\$675	24	24
W-SF-P-2430-F	\$809	24	30
W-SF-P-2436-F	\$818	24	36
W-SF-P-2442-F	\$826	24	42
W-SF-P-2448-F	\$834	24	48
W-SF-P-2454-F	\$1050	24	54
W-SF-P-2460-F	\$1072	24	60

P.E.T. Acoustic Board

Code	Price	Height (in)	Width (in)
W-SF-P-2418-P	\$809	24	18
W-SF-P-2424-P	\$809	24	24
W-SF-P-2430-P	\$923	24	30
W-SF-P-2436-P	\$931	24	36
W-SF-P-2442-P	\$939	24	42
W-SF-P-2448-P	\$946	24	48
W-SF-P-2454-P	\$1319	24	54
W-SF-P-2460-P	\$1326	24	60



USA
Shield Pricebook
May 2024
Visitor Shield

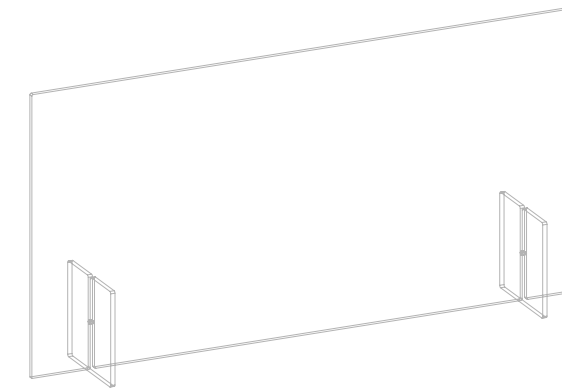

What's Included:

1 clear acrylic visitor shield

How to Specify:

Specify required size by choosing the size of shield based on the size of the area you want to cover

Notes:

- Freestanding
- Shield is raised by 3/4"
- Available with a pass through option
- Opening 12"Wx4"H on the widest part
- Acrylic is 3/8" thick
- Available in clear acrylic only

Options:

Widths: 30", 36", 42", 48"

Depths: 8"

Heights: 24"

With or without pass through

No Pass Through

Code	Price	Height (in)	Depth (in)	Width (in)
W-SV-N-2430-C	\$540	24	8	30
W-SV-N-2436-C	\$639	24	8	36
W-SV-N-2442-C	\$773	24	8	42
W-SV-N-2448-C	\$790	24	8	48

Pass Through

Code	Price	Height (in)	Depth (in)	Width (in)
W-SV-H-2430-C	\$569	24	8	30
W-SV-H-2436-C	\$668	24	8	36
W-SV-H-2442-C	\$802	24	8	42
W-SV-H-2448-C	\$818	24	8	48



USA
Shield Pricebook
May 2024
Frameless Blade

Frameless Blade

Panel Mounted Shield

52

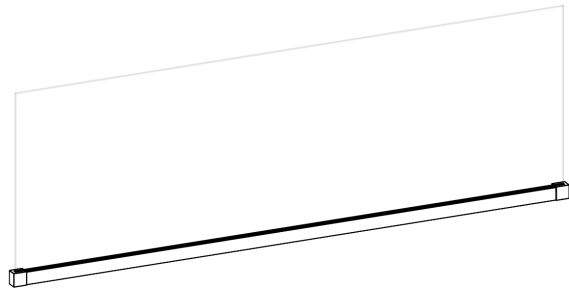

What's Included:

- 1 shield
- 1 extrusion
- 2 end caps

How to Specify:

Notes:

Options:

Widths: 18", 24", 36", 42", 48", 54", 60", 72"

Heights: 16", 20"

Shield finish

Metal paint finish

Clear Glass

Code	Price	Height (in)	Width (in)
W-VG-P-1618-C	\$504	16	18
W-VG-P-1624-C	\$528	16	24
W-VG-P-1630-C	\$561	16	30
W-VG-P-1636-C	\$614	16	36
W-VG-P-1642-C	\$654	16	42
W-VG-P-1648-C	\$664	16	48
W-VG-P-1654-C	\$714	16	54
W-VG-P-1660-C	\$719	16	60
W-VG-P-1672-C	\$784	16	72
W-VG-P-2018-C	\$533	20	18
W-VG-P-2024-C	\$564	20	24
W-VG-P-2030-C	\$607	20	30
W-VG-P-2036-C	\$683	20	36
W-VG-P-2042-C	\$727	20	42
W-VG-P-2048-C	\$731	20	48
W-VG-P-2054-C	\$784	20	54
W-VG-P-2060-C	\$794	20	60
W-VG-P-2072-C	\$851	20	72

P.E.T. Acoustic Board

Code	Price	Height (in)	Width (in)
W-V0-P-1618-P	\$459	16	18
W-V0-P-1624-P	\$488	16	24
W-V0-P-1630-P	\$524	16	30
W-V0-P-1636-P	\$587	16	36
W-V0-P-1642-P	\$750	16	42
W-V0-P-1648-P	\$757	16	48
W-V0-P-1654-P	\$828	16	54
W-V0-P-1660-P	\$866	16	60
W-V0-P-1672-P	\$916	16	72
W-V0-P-2018-P	\$477	20	18
W-V0-P-2024-P	\$531	20	24
W-V0-P-2030-P	\$582	20	30
W-V0-P-2036-P	\$794	20	36
W-V0-P-2042-P	\$838	20	42
W-V0-P-2048-P	\$844	20	48
W-V0-P-2054-P	\$906	20	54
W-V0-P-2060-P	\$936	20	60
W-V0-P-2072-P	\$984	20	72

Frosted Glass

Code	Price	Height (in)	Width (in)
W-VG-P-1618-F	\$654	16	18
W-VG-P-1624-F	\$688	16	24
W-VG-P-1630-F	\$729	16	30
W-VG-P-1636-F	\$795	16	36
W-VG-P-1642-F	\$853	16	42
W-VG-P-1648-F	\$860	16	48
W-VG-P-1654-F	\$929	16	54
W-VG-P-1660-F	\$935	16	60
W-VG-P-1672-F	\$1018	16	72
W-VG-P-2018-F	\$694	20	18
W-VG-P-2024-F	\$732	20	24
W-VG-P-2030-F	\$790	20	30
W-VG-P-2036-F	\$886	20	36
W-VG-P-2042-F	\$944	20	42
W-VG-P-2048-F	\$949	20	48
W-VG-P-2054-F	\$1018	20	54
W-VG-P-2060-F	\$1034	20	60
W-VG-P-2072-F	\$1105	20	72

Frosted Acrylic

Code	Price	Height (in)	Width (in)
W-VA-P-1618-F	\$654	16	18
W-VA-P-1624-F	\$688	16	24
W-VA-P-1630-F	\$729	16	30
W-VA-P-1636-F	\$795	16	36
W-VA-P-1642-F	\$853	16	42
W-VA-P-1648-F	\$860	16	48
W-VA-P-1654-F	\$929	16	54
W-VA-P-1660-F	\$935	16	60
W-VA-P-1672-F	\$1018	16	72

Clear Acrylic

Code	Price	Height (in)	Width (in)
W-VA-P-1618-C	\$504	16	18
W-VA-P-1624-C	\$528	16	24
W-VA-P-1630-C	\$561	16	30
W-VA-P-1636-C	\$614	16	36
W-VA-P-1642-C	\$654	16	42
W-VA-P-1648-C	\$664	16	48
W-VA-P-1654-C	\$714	16	54
W-VA-P-1660-C	\$719	16	60
W-VA-P-1672-C	\$784	16	72



USA
Shield Pricebook
May 2024

Freestanding Shield

Freestanding Shield

w/ Stationary Wing Base

56

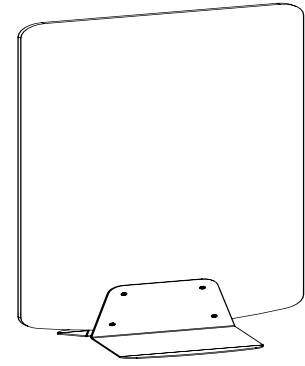

What's Included:

- 1 gallery shield
- 1 base

How to Specify:

Notes:

Requires 21" clearance for base

Options:

Widths: 36", 42", 48"

Heights: 61", 66", 69", 72", 78"

Shield finish

Metal paint finish

Laminate

Code	Price	Height (in)	Width (in)
W-GM-F-6136-L	\$1267	61	36
W-GM-F-6142-L	\$1271	61	42
W-GM-F-6148-L	\$1277	61	48
W-GM-F-6636-L	\$1277	66	36
W-GM-F-6642-L	\$1283	66	42
W-GM-F-6648-L	\$1290	66	48
W-GM-F-6936-L	\$1307	69	36
W-GM-F-6942-L	\$1312	69	42
W-GM-F-6948-L	\$1318	69	48
W-GM-F-7236-L	\$1307	72	36
W-GM-F-7242-L	\$1312	72	42
W-GM-F-7248-L	\$1318	72	48
W-GM-F-7836-L	\$1307	78	36
W-GM-F-7842-L	\$1312	78	42
W-GM-F-7848-L	\$1318	78	48

Whiteboard

Code	Price	Height (in)	Width (in)
W-GM-F-7236-W	\$2381	72	36
W-GM-F-7242-W	\$2386	72	42
W-GM-F-7248-W	\$2393	72	48



USA
Shield Pricebook
May 2024
Gallery Shield

Gallery Shield

<u>Freestanding w/ Stationary D-Feet</u>	60
<u>Stationary Skate Feet</u>	62
<u>Mobile Roller Skate Feet</u>	64
<u>Indent w/Stationary Skate Feet</u>	66
<u>Indent w/Mobile Roller Skate Feet</u>	68

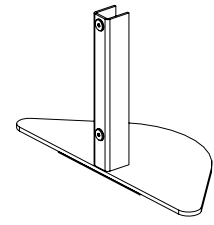

D-foot

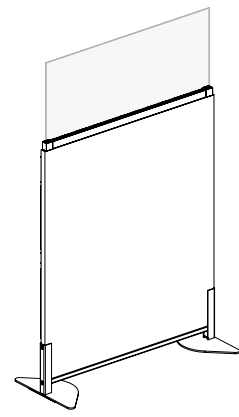

Acrylic

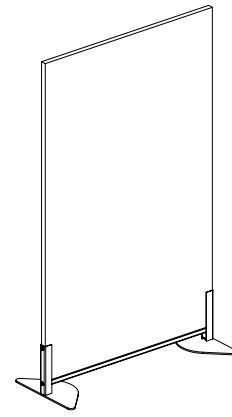

Laminate

What's Included:

- 1" thick laminate Gallery Shield
- 16" acrylic blade
- 2 stationary D-feet
- 2 u-channels
- 1 bottom brace
- 1 acrylic blade channel
- 2 blade end caps

Notes:

Acrylic portion is always 16" high
15-1/8" clearance for feet

Options:

Height: 61", 66", 69", 72"

Width: 36", 42", 48"

Metal paint finish

Laminate finish

Acrylic finish

Whiteboard finish

Whiteboard

Code	Price	Height (in)	Width (in)	Depth (in)	Weight (lb)	Volume (ft ³)
W-GD-F-6136-W	2272	61	36	1	29.28	1.17
W-GD-F-6142-W	2626	61	42	1	34.16	1.37
W-GD-F-6148-W	2627	61	48	1	39.04	1.56
W-GD-F-6636-W	2293	66	36	1	31.68	1.27
W-GD-F-6642-W	2627	66	42	1	36.96	1.48
W-GD-F-6648-W	2628	66	48	1	42.24	1.69
W-GD-F-6936-W	2304	69	36	1	33.12	1.32
W-GD-F-6942-W	2628	69	42	1	38.64	1.55
W-GD-F-6948-W	2630	69	48	1	44.16	1.77
W-GD-F-7236-W	2316	72	36	1	34.56	1.38
W-GD-F-7242-W	2628	72	42	1	40.32	1.61
W-GD-F-7248-W	2631	72	48	1	46.08	1.84

Clear Acrylic

Code	Price	Height (in)	Width (in)
W-GD-F-6136-C	1955	61	36
W-GD-F-6142-C	2329	61	42
W-GD-F-6148-C	2335	61	48
W-GD-F-6636-C	1975	66	36
W-GD-F-6642-C	2330	66	42
W-GD-F-6648-C	2338	66	48
W-GD-F-6936-C	1986	69	36
W-GD-F-6942-C	2331	69	42
W-GD-F-6948-C	2342	69	48
W-GD-F-7236-C	1998	72	36
W-GD-F-7242-C	2331	72	42
W-GD-F-7248-C	2342	72	48

Frosted Acrylic

Code	Price	Height (in)	Width (in)
W-GD-F-6136-F	2048	61	36
W-GD-F-6142-F	2420	61	42
W-GD-F-6148-F	2426	61	48
W-GD-F-6636-F	2065	66	36
W-GD-F-6642-F	2421	66	42
W-GD-F-6648-F	2427	66	48
W-GD-F-6936-F	2075	69	36
W-GD-F-6942-F	2421	69	42
W-GD-F-6948-F	2428	69	48
W-GD-F-7236-F	2088	72	36
W-GD-F-7242-F	2422	72	42
W-GD-F-7248-F	2433	72	48

Laminate

Code	Price	Height (in)	Width (in)
W-GD-F-6136-L	1309	61	36
W-GD-F-6142-L	1664	61	42
W-GD-F-6148-L	1665	61	48
W-GD-F-6636-L	1330	66	36
W-GD-F-6642-L	1665	66	42
W-GD-F-6648-L	1666	66	48
W-GD-F-6936-L	1342	69	36
W-GD-F-6942-L	1666	69	42
W-GD-F-6948-L	1667	69	48
W-GD-F-7236-L	1354	72	36
W-GD-F-7242-L	1666	72	42
W-GD-F-7248-L	1668	72	48

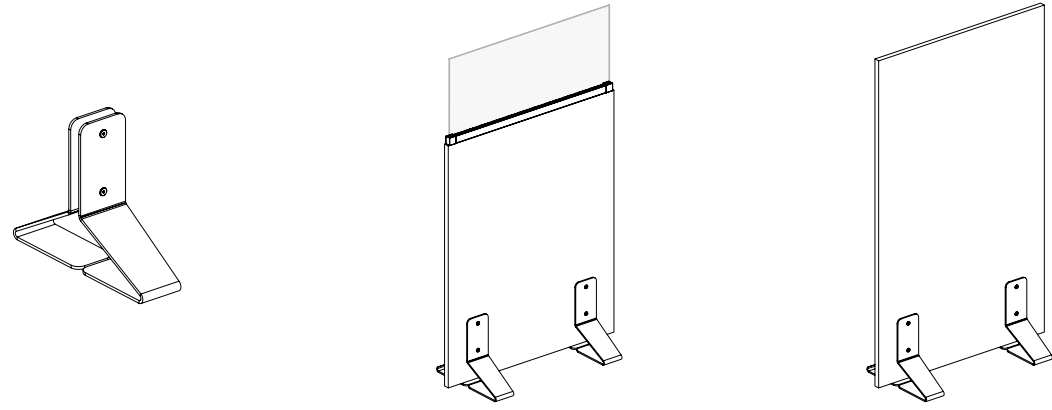

Skate foot

Acrylic

Laminate

What's Included:

- 1" thick laminate Gallery Shield
- 16" acrylic blade
- 4 stationary SKATE feet
- 1 acrylic blade channel
- 2 blade end caps

Notes:

Acrylic portion is always 16" High
18-1/4" clearance for feet

Options:

Height: 61", 66", 69", 72"

Width: 36", 42", 48"

Metal paint finish

Laminate finish

Acrylic finish

Whiteboard finish

Whiteboard

Code	Price	Height (in)	Width (in)	Depth (in)	Weight (lb)	Volume (ft ³)
W-GH-F-6136-W	2155	61	36	1	29.28	1.17
W-GH-F-6142-W	2505	61	42	1	34.16	1.37
W-GH-F-6148-W	2508	61	48	1	39.04	1.56
W-GH-F-6636-W	1945	66	36	1	31.68	1.27
W-GH-F-6642-W	2506	66	42	1	36.96	1.48
W-GH-F-6648-W	2509	66	48	1	42.24	1.69
W-GH-F-6936-W	1946	69	36	1	33.12	1.32
W-GH-F-6942-W	2508	69	42	1	38.64	1.55
W-GH-F-6948-W	2509	69	48	1	44.16	1.77
W-GH-F-7236-W	1946	72	36	1	34.56	1.38
W-GH-F-7242-W	2509	72	42	1	40.32	1.61
W-GH-F-7248-W	2510	72	48	1	46.08	1.84

Clear Acrylic

Code	Price	Height (in)	Width (in)
W-GH-F-6136-C	1781	61	36
W-GH-F-6142-C	2147	61	42
W-GH-F-6148-C	2155	61	48
W-GH-F-6636-C	1796	66	36
W-GH-F-6642-C	2149	66	42
W-GH-F-6648-C	2156	66	48
W-GH-F-6936-C	1808	69	36
W-GH-F-6942-C	2150	69	42
W-GH-F-6948-C	2157	69	48
W-GH-F-7236-C	1822	72	36
W-GH-F-7242-C	2152	72	42
W-GH-F-7248-C	2157	72	48

Frosted Acrylic

Code	Price	Height (in)	Width (in)
W-GH-F-6136-F	1870	61	36
W-GH-F-6142-F	2239	61	42
W-GH-F-6148-F	2245	61	48
W-GH-F-6636-F	1888	66	36
W-GH-F-6642-F	2240	66	42
W-GH-F-6648-F	2246	66	48
W-GH-F-6936-F	1901	69	36
W-GH-F-6942-F	2240	69	42
W-GH-F-6948-F	2247	69	48
W-GH-F-7236-F	1911	72	36
W-GH-F-7242-F	2241	72	42
W-GH-F-7248-F	2249	72	48

Laminate

Code	Price	Height (in)	Width (in)
W-GH-F-6136-L	1193	61	36
W-GH-F-6142-L	1542	61	42
W-GH-F-6148-L	1547	61	48
W-GH-F-6636-L	983	66	36
W-GH-F-6642-L	1543	66	42
W-GH-F-6648-L	1548	66	48
W-GH-F-6936-L	984	69	36
W-GH-F-6942-L	1547	69	42
W-GH-F-6948-L	1548	69	48
W-GH-F-7236-L	984	72	36
W-GH-F-7242-L	1548	72	42
W-GH-F-7248-L	1549	72	48

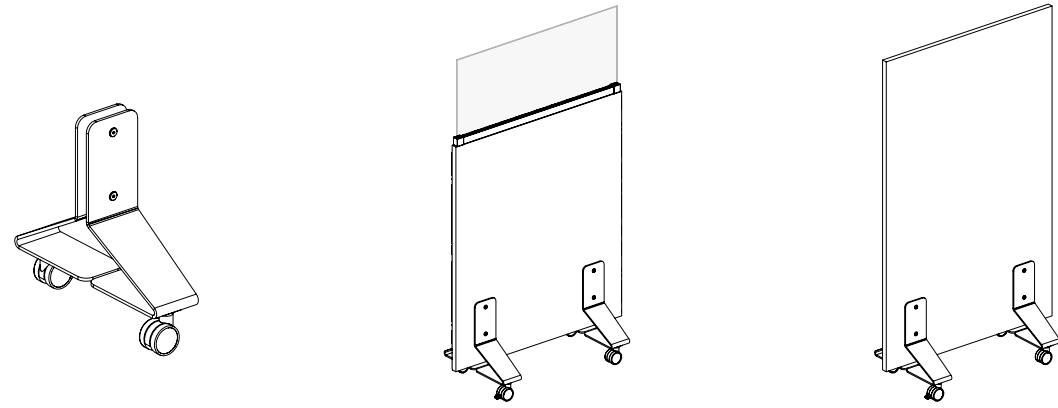

Roller Skate foot

Acrylic

Laminate

What's Included:

- Acrylic
 - 1" thick laminate Gallery Shield
 - 16" acrylic blade
 - 4 mobile Roller Skate feet
 - 1 acrylic blade channel
 - 2 blade end caps
- Laminate
 - 1" thick laminate Gallery Shield
 - 4 mobile Roller Skate feet

Notes:

Acrylic portion is 16" High
 18-1/4" clearance for feet
 75mm lockable casters

Options:

Height: 61", 66", 69", 72"

Width: 36", 42", 48"

Metal paint finish

Laminate finish

Acrylic finish

Whiteboard finish

Whiteboard

Code	Price	Height (in)	Width (in)	Depth (in)	Weight (lb)	Volume (ft³)
W-GH-M-6136-W	2381	61	36	1	29.28	1.17
W-GH-M-6142-W	2730	61	42	1	34.16	1.37
W-GH-M-6148-W	2731	61	48	1	39.04	1.56
W-GH-M-6636-W	2399	66	36	1	31.68	1.27
W-GH-M-6642-W	2731	66	42	1	36.96	1.48
W-GH-M-6648-W	2732	66	48	1	42.24	1.69
W-GH-M-6936-W	2412	69	36	1	33.12	1.32
W-GH-M-6942-W	2732	69	42	1	38.64	1.55
W-GH-M-6948-W	2735	69	48	1	44.16	1.77
W-GH-M-7236-W	2422	72	36	1	34.56	1.38
W-GH-M-7242-W	2732	72	42	1	40.32	1.61
W-GH-M-7248-W	2736	72	48	1	46.08	1.84

Clear Acrylic

Code	Price	Height (in)	Width (in)
W-GH-M-6136-C	2000	61	36
W-GH-M-6142-C	2371	61	42
W-GH-M-6148-C	2378	61	48
W-GH-M-6636-C	2021	66	36
W-GH-M-6642-C	2373	66	42
W-GH-M-6648-C	2382	66	48
W-GH-M-6936-C	2033	69	36
W-GH-M-6942-C	2374	69	42
W-GH-M-6948-C	2382	69	48
W-GH-M-7236-C	2048	72	36
W-GH-M-7242-C	2374	72	42
W-GH-M-7248-C	2383	72	48

Frosted Acrylic

Code	Price	Height (in)	Width (in)
W-GH-M-6136-F	2094	61	36
W-GH-M-6142-F	2461	61	42
W-GH-M-6148-F	2472	61	48
W-GH-M-6636-F	2114	66	36
W-GH-M-6642-F	2463	66	42
W-GH-M-6648-F	2473	66	48
W-GH-M-6936-F	2124	69	36
W-GH-M-6942-F	2465	69	42
W-GH-M-6948-F	2474	69	48
W-GH-M-7236-F	2137	72	36
W-GH-M-7242-F	2468	72	42
W-GH-M-7248-F	2475	72	48

Laminate

Code	Price	Height (in)	Width (in)
W-GH-M-6136-L	1419	61	36
W-GH-M-6142-L	1768	61	42
W-GH-M-6148-L	1769	61	48
W-GH-M-6636-L	1436	66	36
W-GH-M-6642-L	1769	66	42
W-GH-M-6648-L	1770	66	48
W-GH-M-6936-L	1449	69	36
W-GH-M-6942-L	1770	69	42
W-GH-M-6948-L	1772	69	48
W-GH-M-7236-L	1460	72	36
W-GH-M-7242-L	1770	72	42
W-GH-M-7248-L	1773	72	48

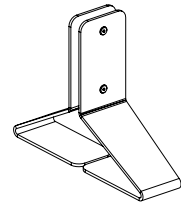

Skate foot

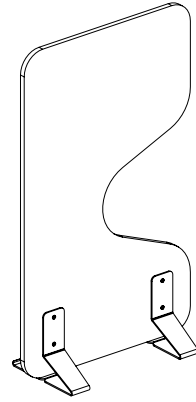

Laminate/Whiteboard

What's Included:

- 1" thick Indent Gallery Shield
- 4 stationary SKATE feet

Notes:

18-1/4" Clearance for feet
 Indent 25"Depth x 19" High, starts 16" off the floor

Options:

Height: 61", 66", 69", 72"

Width: 42", 48"

Metal paint finish

Laminate finish

Whiteboard finish

Laminate

Code	Price	Height (in)	Width (in)
W-GI-F-6142-L	1645	61	42
W-GI-F-6148-L	1650	61	48
W-GI-F-6642-L	1650	66	42
W-GI-F-6648-L	1653	66	48
W-GI-F-6942-L	1650	69	42
W-GI-F-6948-L	1654	69	48
W-GI-F-7242-L	1653	72	42
W-GI-F-7248-L	1654	72	48

Whiteboard

Code	Price	Height (in)	Width (in)
W-GI-F-6136-W	2312	61	36
W-GI-F-6142-W	2681	61	42
W-GI-F-6148-W	2682	61	48
W-GI-F-6636-W	2360	66	36
W-GI-F-6642-W	2682	66	42
W-GI-F-6648-W	2684	66	48
W-GI-F-6936-W	2385	69	36
W-GI-F-6942-W	2683	69	42
W-GI-F-6948-W	2684	69	48
W-GI-F-7236-W	2412	72	36
W-GI-F-7242-W	2684	72	42
W-GI-F-7248-W	2685	72	48

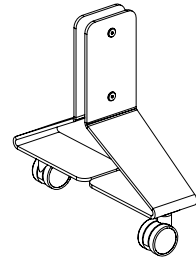

Roller Skate foot

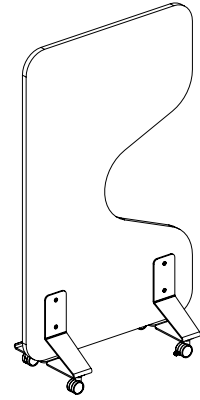

Laminate/Whiteboard

What's Included:

- 1" thick Indent Shield
- 4 mobile Roller Skate feet

Notes:

18-1/4" Clearance for feet
 Indent 25"Dx19"H, starts 16" off the floor
 75mm lockable casters

Options:

Height: 61", 66", 69", 72"

Width: 42", 48"

Metal paint finish

Laminate finish

Whiteboard finish

Laminate

Code	Price	Height (in)	Width (in)
W-GI-M-6142-L	1873	61	42
W-GI-M-6148-L	1875	61	48
W-GI-M-6642-L	1874	66	42
W-GI-M-6648-L	1876	66	48
W-GI-M-6942-L	1875	69	42
W-GI-M-6948-L	1876	69	48
W-GI-M-7242-L	1876	72	42
W-GI-M-7248-L	1877	72	48

Whiteboard

Code	Price	Height (in)	Width (in)
W-GI-M-6136-W	2543	61	36
W-GI-M-6142-W	2905	61	42
W-GI-M-6148-W	2907	61	48
W-GI-M-6636-W	2586	66	36
W-GI-M-6642-W	2907	66	42
W-GI-M-6648-W	2910	66	48
W-GI-M-6936-W	2612	69	36
W-GI-M-6942-W	2910	69	42
W-GI-M-6948-W	2911	69	48
W-GI-M-7236-W	2633	72	36
W-GI-M-7242-W	2910	72	42
W-GI-M-7248-W	2912	72	48

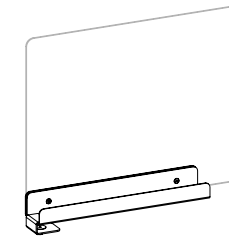

Clear acrylic

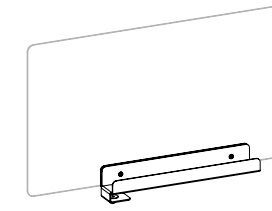

Frosted acrylic

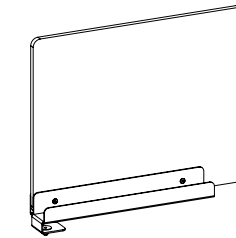

Laminate

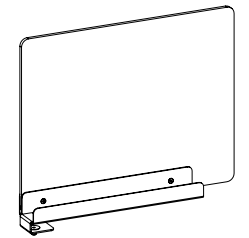

Pet Felt

What's Included:

Acrylic, Laminate or PET Caddy Base

How to Specify:

- 24" for 24" surface
- 30" for 30" surface
- 36" for 24" surface with 12" extension
- 42" for 30" surface with 12" overhang

Options:

- Height: 24"
- Depth: 24", 30", 36", 42" with 24" base

Notes:

- For 1" thick worksurface
- Maximum 12" extension
- Caddy base is 24"D on all sizes
- Shield is non-handed
- Front is secured with a clamp, back with two-way tape

USA
Shield Pricebook
May 2024
Caddy Shield

Code	Price	Height (in)	Depth (in)
CLEAR ACRYLIC			
W-SJ-D-2424-C	\$ 885	24	24
W-SJ-D-2430-C	\$ 1047	24	30
W-SJ-D-2436-C	\$ 1098	24	36
W-SJ-D-2442-C	\$ 1151	24	42
LAMINATE			
W-SJ-D-2424-L	\$ 935	24	24
W-SJ-D-2430-L	\$ 1103	24	30
W-SJ-D-2436-L	\$ 1159	24	36
W-SJ-D-2442-L	\$ 1215	24	42

Code	Price	Height (in)	Depth (in)
FROSTED ACRYLIC			
W-SJ-D-2424-F	\$ 994	24	24
W-SJ-D-2430-F	\$ 1256	24	30
W-SJ-D-2436-F	\$ 1343	24	36
W-SJ-D-2442-F	\$ 1429	24	42
PET FELT			
W-SJ-D-2424-P	\$ 1049	24	24
W-SJ-D-2430-P	\$ 1158	24	30
W-SJ-D-2436-P	\$ 1385	24	36
W-SJ-D-2442-P	\$ 1385	24	42



USA
Shield Pricebook
May 2024
Sanitization Cabinet

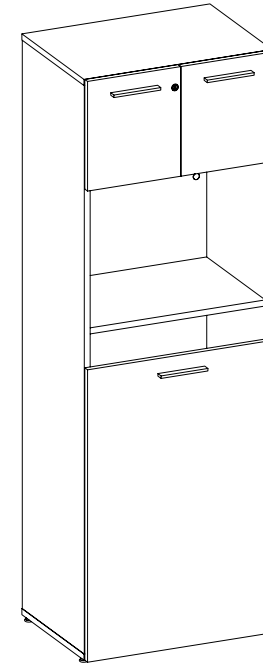

What's Included:

Sanitization Station with Bottom Adjustable Shelf Mask/Glove Dispenser

How to Specify:

LH or RH Door

Notes:

Bottom adjustable shelf accommodates shorter bins
Mask/Glove Dispenser Can hold 2

Options:

Height: 72"

Depth: 18"

Width: 24"

Standard handle options except for McKay

Code	Price	Height (in)	Depth (in)	Width (in)
Sanitization Station				
W-11-Z-721824-L	\$ 1924	72	18	24
W-11-Z-721824-R	\$ 1924	72	18	24