

tayco®

Metro Pricebook

October 2024

contents

Caution	7
Overview	8
Statement of Line	13
Step-by-step order placement	31
Straight Desk	32
straight executive	34
straight professional	36
straight partial modesty executive	38
straight partial modesty professional	40
straight full recessed modesty executive	42
straight full recessed modesty professional	44
arc full recessed modesty executive	46
arc full recessed modesty professional	47
Tables	48
D-table executive	50
D-table professional	51
J-table executive	52
J-table professional	53
P-table executive	54
P-table professional	55
F-table executive	56
F-table professional	57
U-table executive	58
U-table professional	59
C-table executive	60
C-table professional	61
Corners	62
straight front corner full modesty executive	64
straight front corner full modesty professional	65
straight front corner partial modesty executive	66
straight front corner partial modesty professional	67
straight front corner full modesty no gables executive	68

straight front corner full modesty no gables professional	69
curved front corner full modesty executive	70
curved front corner full modesty professional	71
curved front corner partial modesty executive	72
curved front corner partial modesty professional	73
curved front corner full modesty no gables executive	74
curved front corner full modesty no gables professional	75
Unitized Desks	76
curved front w/full modesties, full and partial gables executive	78
curved front w/full modesties, full and partial gables professional	79
curved front w/full modesties, no gables executive	80
curved front w/full modesties, no gables professional	81
curved front w/partial modesty executive	82
curved front w/ partial modesties professional	83
Bridges	84
bowed bridge full modesty executive	86
bowed bridge full modesty professional	87
bowed bridge partial modesty executive	88
bowed bridge partial modesty professional	89
Returns	90
straight return full modesty executive	92
straight return full modesty professional	94
straight return partial modesty executive	96
straight return partial modesty professional	98
double lateral file executive	102
double lateral file professional	103
double storage cabinet executive	104
double storage cabinet professional	105
lateral file and storage cabinet executive	106
lateral file and storage cabinet professional	107
lateral file and storage cabinet executive	108
lateral file and storage cabinet professional	109
tops executive	110
tops professional	111
open w door executive	112
open w door professional	112

Supports	114
intermediate support	116
cantilever	117
reinforcement bar	118
Filing & Storage	120
pedestals	122
pedestals w/ seat cushion	124
underdesk storage cabinet	125
underdesk combo pedestal BBF & FF	126
underdesk 2-drawer lateral file	127
freestanding storage cabinet executive	128
freestanding storage cabinet professional	129
freestanding combo pedestal BBF & FF executive	130
freestanding combo pedestal BBF & FF professional	131
freestanding 2-drawer lateral file executive	132
freestanding 2-drawer lateral file professional	133
freestanding 3-drawer lateral file executive	134
freestanding 3-drawer lateral file professional	135
freestanding 4-drawer lateral file executive	136
freestanding 4-drawer lateral file professional	137
freestanding storage tower executive	138
freestanding storage tower professional	139
freestanding combo storage tower BBF executive	140
freestanding combo storage tower BBF professional	141
freestanding combo storage tower FF executive	142
freestanding combo storage tower FF professional	143
freestanding wardrobe storage tower executive	144
freestanding wardrobe storage tower professional	145
freestanding storage tower double door executive	146
freestanding storage tower double door professional	147
freestanding combo lateral storage double door executive	148
freestanding combo lateral storage double door professional	149
freestanding combo lateral storage glazed double door executive	150
freestanding combo lateral storage glazed double door professional	151
bookcase executive	152
bookcase professional	154

Overhead Storage	156
open hutch executive	158
open hutch professional	159
hinged door hutch executive	160
hinged door hutch professional	161
glazed door hutch executive	162
glazed door hutch professional	163
open hutch w/ pidgeon holes executive	164
open hutch w/ pidgeon holes professional	165
hinged door hutch w/ pidgeon holes executive	166
hinged door hutch w/ pidgeon holes professional	167
wall mounted hinged door hutch executive	168
wall mounted hinged door hutch professional	169
wall mounted glazed door hutch executive	170
wall mounted glazed door hutch professional	171
Tabletops	172
1.5" Straight Tabletop w/ Grommet executive	174
1" Straight Tabletop w/ Grommet professional	176
1.5" Straight Tabletop - no grommets executive	178
1" Straight Tabletop - no grommets professional	180
1.5" D-Tabletop executive	182
1" D-Tabletop professional	183
1.5" O-Tabletop executive	184
1" O-Tabletop professional	185
Bases	186
cross base	188
post support base	189
open metal gable	190
Reception Unit	192
executive	194
professional	195
Service Write Up Desk	196
w/ Straight Front Countertop executive	198
w/ Straight Front Countertop professional	199
w/ Arc Countertop executive	200
w/ Arc Countertop professional	201

Coffee & End Tables	202
coffee and end table executive	204
coffee and end table professional	205
Conference	206
table top	208
straight tabletop	208
straight tabletop w/power and data	210
boat-shaped tabletop	212
boat-shaped tabletop w/power and data	214
racetrack tabletop	216
racetrack tabletop w/power and data	218
tapered tabletop	220
tapered tabletop w/ power and data	221
table base	222
gable & modesty base	222
elliptical base	226
table base configuration	230
options	231
Ellora Grommet add-ons	231
filing and storage	232
serving cabinet	232
storage cabinet w/shelves	233
combo cabinet w/storage & lateral files	234
double door cabinet w/shelves	235
combo cabinet	236
storage cabinet w/coat bar and shelves	237
presentation tools	238
whiteboard cabinet	238
computer desk	239
Accessories	240
keyboard tray	242
tackboard for hutch	243
pencil drawer	244
task light	245
monitor arm	246
wire manager	247

Caution

Load Bottom Drawer First

- Operate one drawer at a time
- Units may tip if loaded incorrectly
- Units should be attached to a wall or other furniture to reduce tipping hazard
- Always load the heaviest files in the bottom drawer

Heavy Load

- Some products must be anchored to wall to ensure stability & safety.
- It is the owner and installers responsibility to ensure that the wall type and construction is of sufficient strength to carry the loads of any wall mounted products and their contents.
- Failure of the wall and anchors to support all imposed loads may result in property damage and/or personal injury.
- Tayco can provide size and empty weight of its products only. As wall blocking is considered a building construction process, Tayco cannot provide recommendations in this respect and cannot be responsible for damage or injury that may occur as a result of improper installation and/or blocking.

Instability Hazard

Mobile items on casters such as flip top, personal and movable tables of any type and storage items of any type may present an instability hazard if not secured correctly while in use or in storage. Flip top tables or training tables of any type, are inherently more unstable when folded. Tayco provides the following guidelines & warnings when using mobile products:

- Lock casters immediately after moving. Do not leave the casters unlocked when in use or in storage.
- Motion may increase the instability of any item with casters. If the wheels hit an obstruction the table's forward momentum often causes overturn, especially if the item is not equipped with wheel extensions. Exercise strong caution while moving these items.
- Use caution when abrupt level changes in the floor are present (such as a doorway or room threshold) as caster failure or tipping may result.
- Do not stand, sit or lean on mobile items for support. They are not intended for this use and personal injury or property damage may result.
- Mobile units that feature height adjustable elements must be lowered to the minimum compressed height when moving to prevent instability. It is also recommended the user remove all computer equipment or other accessories to prevent possible weight imbalance or damage to equipment.
- Failure to follow the guidelines above may result in property damage or personal injury.

Overview

Tayco introduces Metro, a full line of case goods and conference furniture.

Metro is divided into three distinct product groups for ease of specifying: Executive, Professional and Conference. The prefix of the product code indicates the product group.

- T – Metro Executive
- TL – Metro Professional
- TB – Metro Conference

Metro Executive and Professional series contain the building blocks for the CEO's office, a flexible team environment or a welcoming reception area. An abundance of freestanding storage towers are available for places to hang your coat, file important papers or store personal items. Whether you need to create an impression, save space or encourage collaboration, Metro does it all.

Metro Conference can be formal or casual, a place for working meetings, video-conferencing or large presentations. It customizes to your needs through a wide selection of sizes and mix-and-match table shapes and base styles. Cabinetry has been made larger to match the proportions of the conference room. Accessory items such as audiovisual cabinets, mobile media centers, lecterns, whiteboards and serving cabinets round out the line.

Metro Executive and Conference feature 1.5"-thick worksurfaces, hutch and freestanding storage tops. These items also have a choice of Straight or Gothic trim styles. Metro Professional has 1"-thick worksurfaces, hutch tops, filing and storage tops with a straight 2-mm vinyl edge.

desks, returns, bridges and credenzas

Desks are available with a choice of recessed or flush modesties. Metro desks, end gables and modesties are made with 45 lb./cubic foot density industrial-grade composite wood core, finished on both sides. Many pieces are available with partial or full modesties. Partial modesties (12"H) should be ordered only for pieces located next to a wall. Otherwise, full modesties should be used.

pedestals

All pedestal drawers are outfitted with full extension slides. Drawers can be easily removed by releasing the small catches on either side of the slide. Pedestals come standard with locks. One lock will lock both file drawers in a file/file pedestal and one box drawer and the file drawer in the box/box/file pedestal. File drawers will accommodate legal- or letter-size documents.

freestanding storage and combo cabinets

Various combination filing and storage units provide a place to hang a coat, store personal items and documents to suit any individual's needs.

intermediate gable supports

Some configurations require the use of an intermediate gable support. This support must be ordered separately. The situations requiring an intermediate gable support are:

- > For use under surfaces 60" wide or greater where there is no filing or storage to support the worksurface (see picture 1). This applies to Metro Professional only. The intermediate support is not necessary for Metro Executive configurations, unless a hutch is placed over a bridge or return surface (see picture 2).

surfaces 60" wide or greater

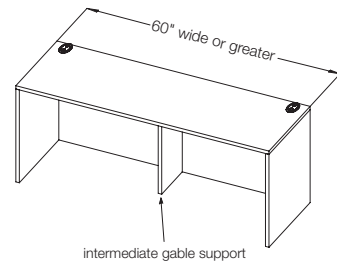

picture 1

under surfaces with a hutch

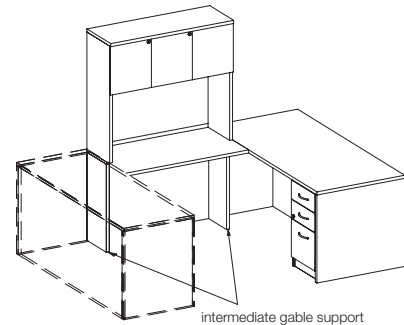

picture 2

- > Under return surfaces where the return meets the primary desk or Peninsula table. This applies to Metro Professional only.

The 12" wide intermediary gable is for 21"- and 24"-deep surfaces and the 18"-wide intermediate gable is used with 30"- and 36"-deep worksurfaces.

universal gable support

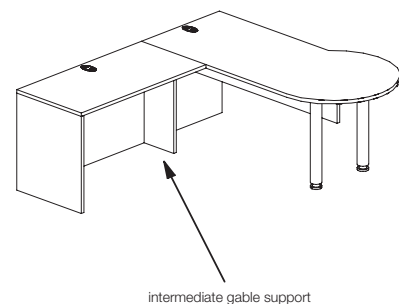

picture 3

accessories

Computer accessories include flat-screen monitor arms, articulating keyboard trays and CPU holders.

Heavy-duty flat-screen monitor arms adjust to the user while storing wires within the arm. The monitor mounting plate meets VESA standards to accommodate most monitors. Monitor arms can be grommet- or clamp-mounted to the worksurface. Articulating and retractable keyboard trays and mobile or underdesk-mounted CPU holders complete the workstation.

Hutch-mounted tackboards can be finished in any Tayco standard fabric to match the office decor. The conference room whiteboard comes standard with a dry erase board and two fabric-wrapped tackboards.

Standard task lights are available in two sizes and come with vertical wire management. An optional task light is available.

hutches and cabinets

Hutch and cabinet doors come in a choice of classic laminate or aluminum-framed frosted acrylic. Hutches with laminate doors always come standard with locking doors.

Hutches come open or closed, with or without pigeonholes and a flexible apron for wire management. Optional hutch mounted tackboards finished in any of Tayco fabrics can be ordered to complete the look.

coffee and end tables

Metro coffee and end tables coordinate with reception units and are available with or without a fixed shelf.

bookcases

Straight and radius bookcases have height-adjustable shelves with the exception of any desk-height shelves. They are fixed to add structural stability to the bookcase.

handle details

Six handle options are available in choice of colors. Melbourne is the standard handle option unless otherwise specified on your Purchase Order. All Executive and Professional handles are 5" long.

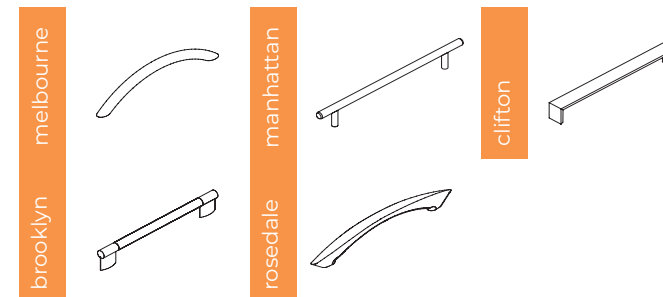

default vinyl color selections

Each laminate comes with matching vinyl trim color unless otherwise specified on your purchase order. Refer to the laminate finish card for details.

edge profile

Metro Executive, Professional and Conference is available in a straight edge profile.



Straight profile is available in:

- > Executive
- > Professional
- > Conference

decorative trim placement

Generally the decorative trim is placed on the exposed surface edge.
 Straight trim is applied to surface edges that are placed next to a wall or another surface.

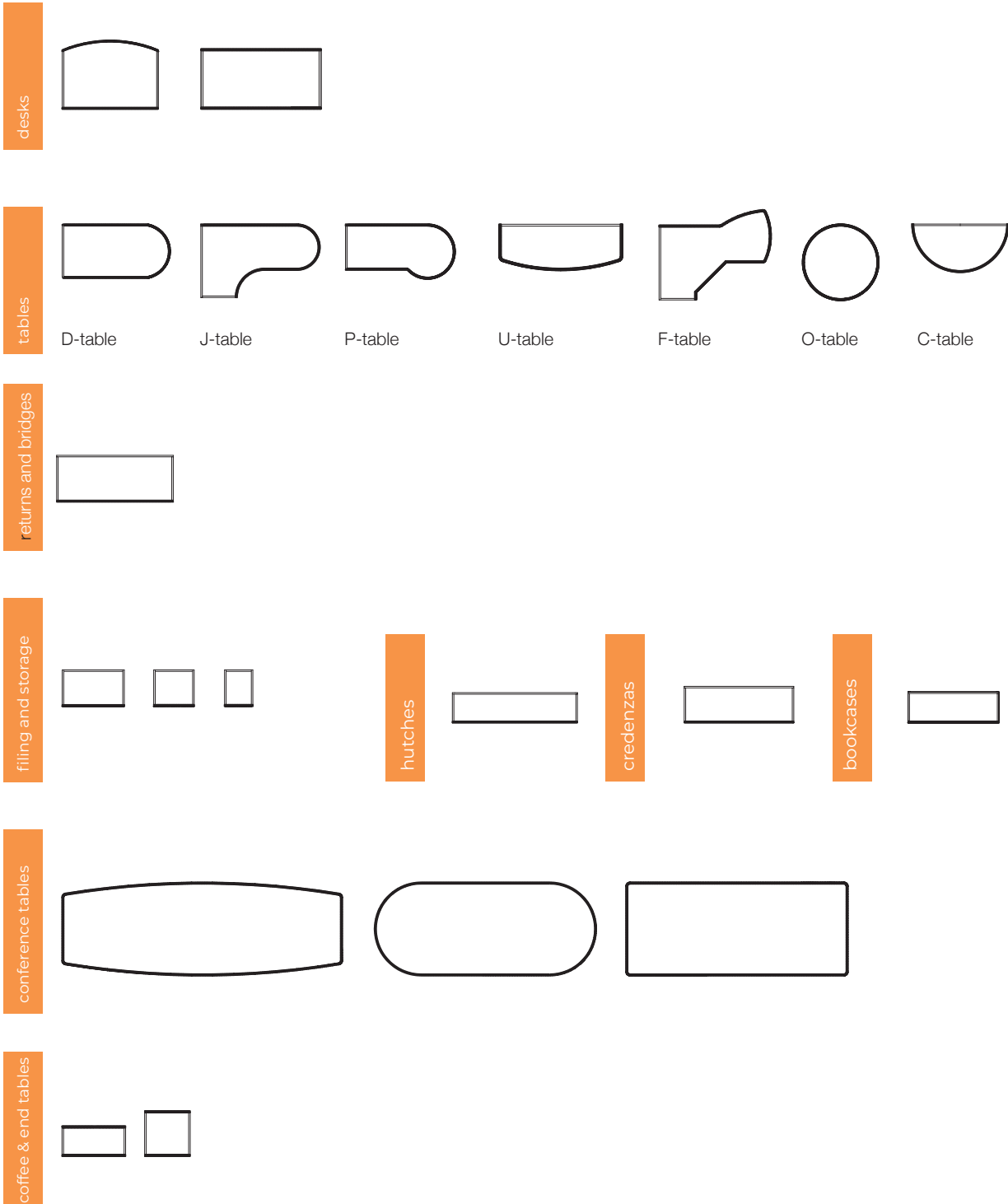

grain direction

Horizontal Surfaces

When ordering a directional laminate, the grain will run the direction of the width of the worksurface (excluding bridge surfaces), hutch or storage top. Grain on bridge modesty runs vertically so the grain will run the same direction on the entire suite.

Vertical Surfaces

Directional laminates run vertically on vertical surfaces such as cabinet doors, pedestal drawer fronts and gables, as well as all cabinet, lateral file and pedestal kick-plates. The grain runs horizontally across the width of modesty panels.

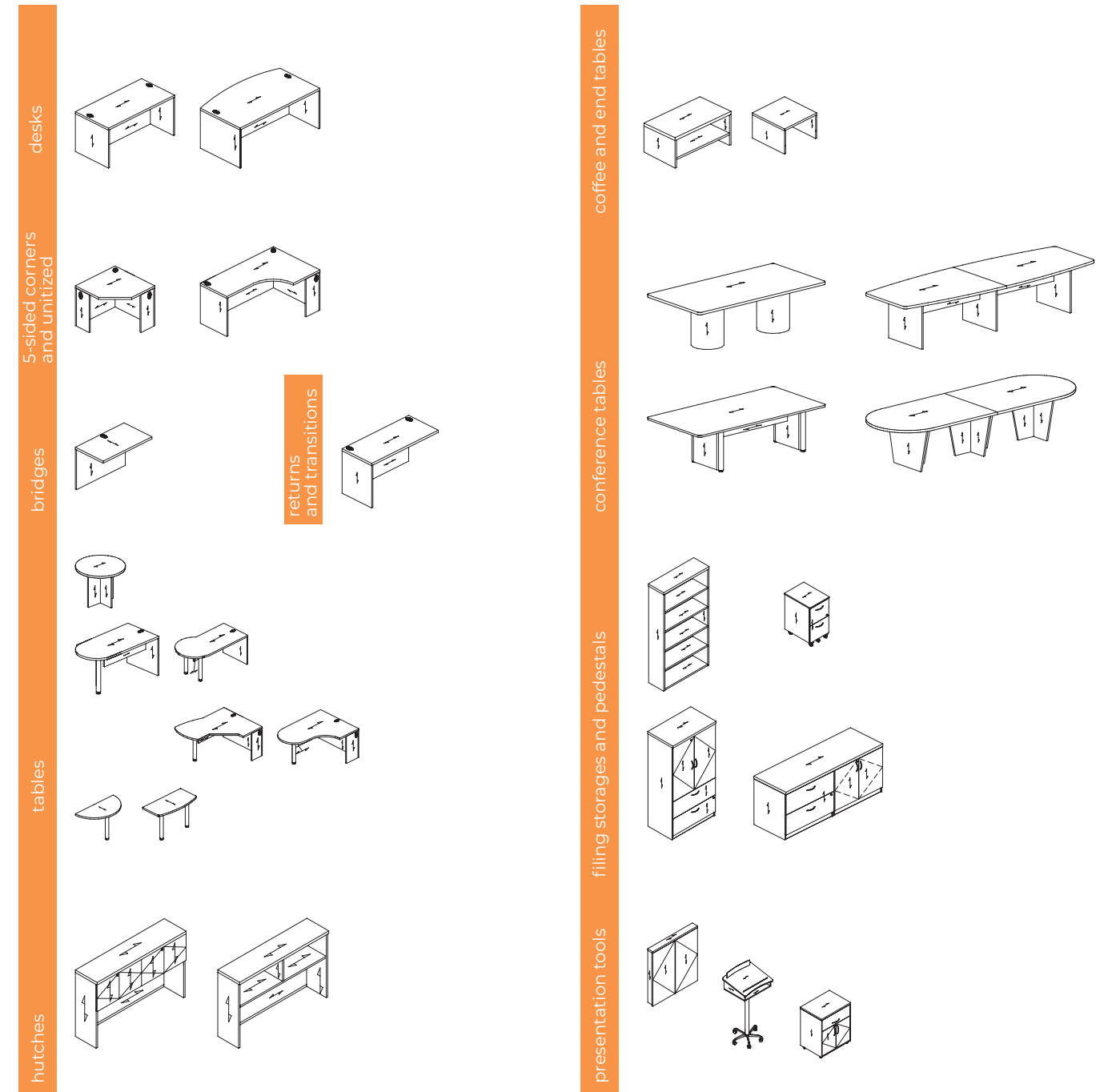

Note: Boardroom tables with tops comprised of 2 or more pieces will not have a consistent grain pattern.

filing options

Pedestal file drawers can accommodate letter- or legal-size documents. Letter-size papers can be filed either front to back or side to side. Lateral drawers can accommodate front to back or side to side filing of legal- or letter-size documents.

Disclaimer: Please note that lateral file drawers are intended for filing letter and legal size paper front to back or side to side only. For details and weight restrictions please contact customer service.

lateral file drawers

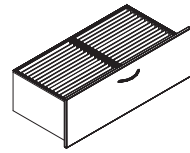

Lateral File Drawer (36W & 42W)
Legal filing – front to back
Underdesk: 15"
Freestanding: 15"

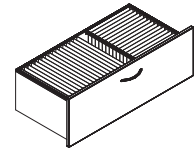

Lateral File Drawer (36W & 42W)
Legal filing – side to side
Letter filing – front to back
Underdesk: 15"
Freestanding: 15"

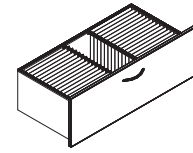

Lateral File Drawer (30W, 36W & 42W)
Letter filing – front to back
Underdesk: 15"
Freestanding: 15"

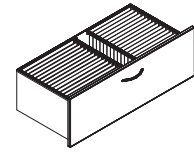

Lateral File Drawer (36W & 42W)
Letter & legal filing – front to back
Underdesk: 15"
Freestanding: 15"

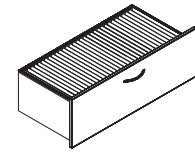

Lateral File Drawer (30W, 36W & 42W)
Legal filing – side to side
Underdesk:
30W-25½"
36W-31½"
42W-37½"

Freestanding:
30W-25½"
36W-31½"
42W-37½"

box drawer

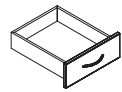

Box Drawer
Box Height: 3"
Box Depth: 15"
Box Width: 12"

file drawers

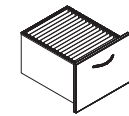

File Drawer
Letter filing – front to back
Underdesk: 15"
Freestanding: 15"

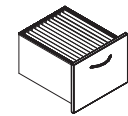

File Drawer
Legal filing – side to side
Underdesk: 12"
Freestanding: 12"

grommets

Grommets are available in black or silver to coordinate with furniture.

Black is the standard grommet option unless otherwise specified on your Purchase Order.

Components Including Grommets

- > Peninsula tables
- > Arc desks with pedestals
- > Straight desks with recessed modesties and pedestals

Straight desks with flush modesties and without pedestals

- > Returns without pedestals
- > 24" deep returns with pedestal
- > 30" deep returns with pedestal
- > 24" deep desks with flush modesties and pedestals
- > 30" deep desks with flush modesties and pedestals
- > 36" deep desks with flush modesties and pedestals
- > Bridges
- > Straight transition worksurfaces
- > 5-sided corner worksurfaces
- > Unitized desks
- > Reception units

Components Available With or Without Grommets

- > Arc desks without pedestals
- > Straight desks with recessed modesties and without pedestals

Components Without Grommets

- > Credenzas
- > 21" deep desks with pedestal
- > 21" deep returns with pedestal
- > "U" and "C" Tables

Grommet Placement

Surfaces up to and including 48" wide have one grommet located at back center of the surface. Surfaces 54" wide and wider have two grommets at either side of the back of the surface.

Statement of Line

Professional Desks

1" Thick Desks

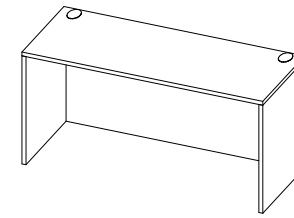

TL-TSOG
Straight w/ Full Modesty
W: 30"- 96"
D: 21"- 30"
H: 29"

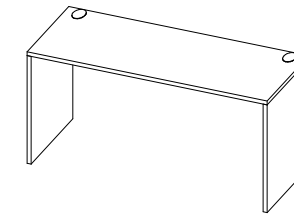

TL-TSOZ
Straight w/ Partial Modesty
W: 30"- 96"
D: 21"- 30"
H: 29"

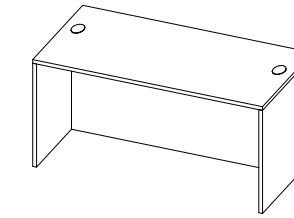

TL-TSRG
Straight w/ Full Recessed Modesty
W: 60"- 96"
D: 30"- 36"
H: 29"

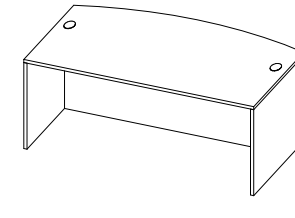

TL-TARG
Arc w/ Full Recessed Modesty
W: 72"- 96"
D: 36"
H: 29"

Professional Tables

1" Thick

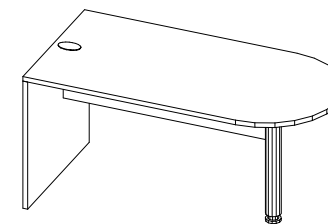

TL-TD0G
D-Table
W: 60"- 84"
D: 30"-36"
H: 29"

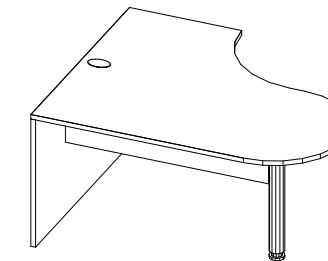

TL-TJ0G-L / TL-TJ0G-R
J-Table (Left Hand shown)
W: 60"- 84"
D: 24"
H: 29"

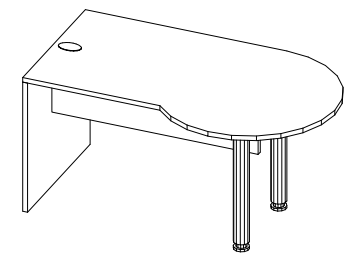

TL-TP0G-L / TL-TP0G-R
P-Table (Left Hand shown)
W: 60"- 84"
D: 30"
H: 29"

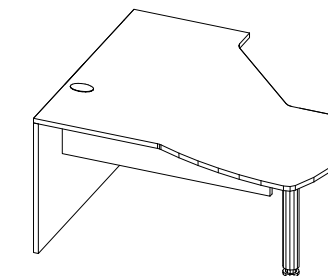

TL-TFSG-L / TL-TFSG-R
F-Table (Left Hand shown)
W: 60"- 84"
D: 24"
H: 29"

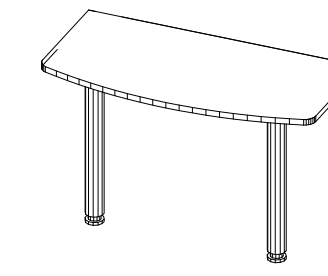

TL-WEU0
U-Table
W: 42"- 60"
D: 24"
H: 29"

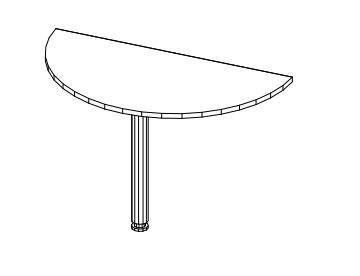

TL-TC00
C-Table
W: 42"- 60"
D: 21"-30"
H: 29"

Executive Desks

1.5" Thick Desks

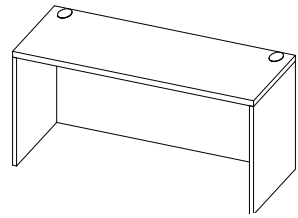

T-TSOG
Straight w/ Full Modesty
W: 30"- 96"
D: 21"- 30"
H: 29.5"

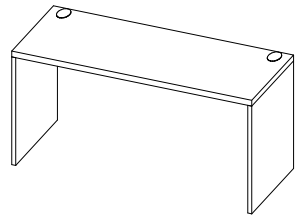

T-TSOZ
Straight w/ Partial Modesty
W: 30"- 96"
D: 21"-30"
H: 29.5"

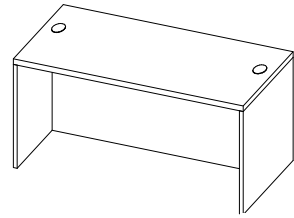

T-TSRG
Straight w/ Full Recessed Modesty
W: 60"- 96"
D: 30"-36"
H: 29.5"

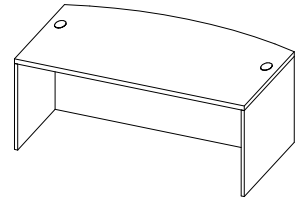

T-TARG
Arc w/ Full Recessed Modesty
W: 72"- 96"
D: 36"
H: 29.5"

Executive Tables

1.5" Thick

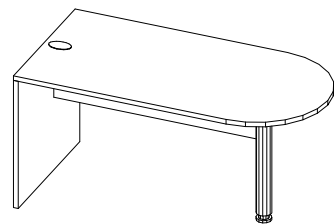

T-TD0G
D-Table
W: 60"- 84"
D: 30"- 36"
H: 29.5"

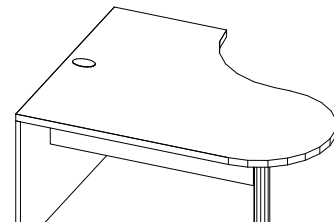

T-TJ0G-L / T-TJ0G-R
J-Table (Left Hand shown)
W: 60"- 84"
D: 24"
H: 29.5"

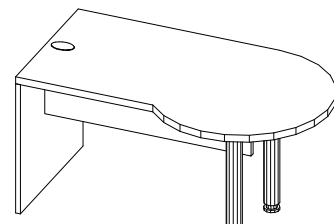

T-TP0G-L / T-TP0G-R
P-Table (Left Hand shown)
W: 60"- 84"
D: 30"
H: 29.5"

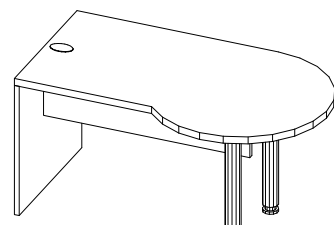

T-TFSG-L / T-TFSG-R
F-Table (Left Hand shown)
W: 60"- 84"
D: 24"
H: 29.5"

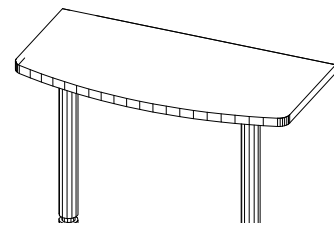

T-WEU0
U-Table
W: 42"- 60"
D: 24"
H: 29.5"

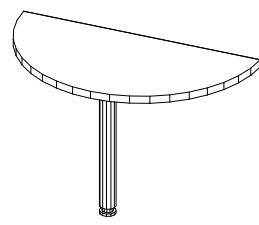

T-TC00
C-Table
W: 42"- 60"
D: 21"-30"
H: 29.5"

Professional Corners

1" Thick

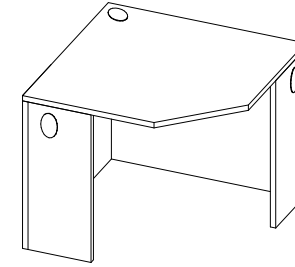

TL-W5S0
Straight Front
Full Modesty w/ Intermediate Gable
W: 36"- 42"
D: 21"- 24"
H: 29"

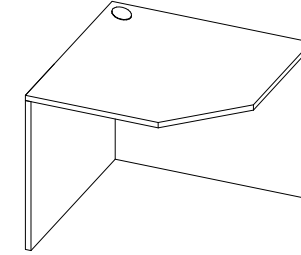

TL-W5S0-N
Straight Front
Full Modesty/ No Intermediate Gable
W: 36"- 42"
D: 21"- 24"
H: 29"

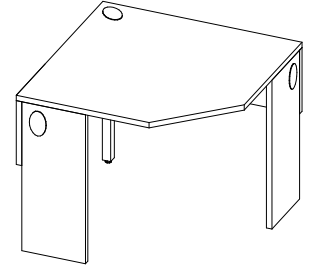

TL-W5S0-P
Straight Front
Partial Modesty w/ Intermediate Gable
W: 36"- 42"
D: 21"- 24"
H: 29"

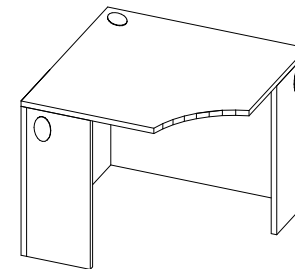

TL-W5C0
Curve Front
Full Modesty w/ Intermediate Gable
W: 36"- 42"
D: 21"- 24"
H: 29"

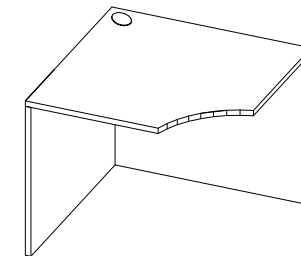

TL-W5C0-N
Curve Front
Full Modesty/ No Intermediate Gable
W: 36"- 42"
D: 21"- 24"
H: 29"

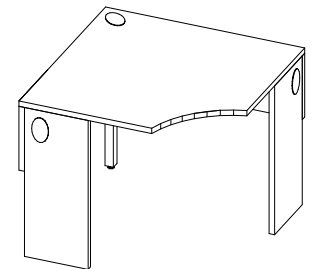

TL-W5C0-P
Curve Front
Partial Modesty w/ Intermediate Gable
W: 36"- 42"
D: 21"- 24"
H: 29"

Professional Unitized Desks

1" Thick

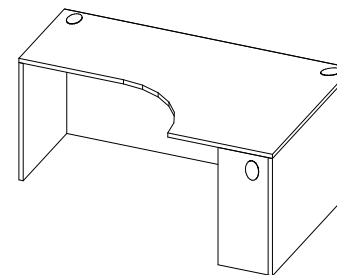

TL-UC4G-L / TL-UC4G-R
Unitized Desk (Left Hand shown)
Full Modesty w/ Intermediate Gable
W: 66"- 72"
D: 39"- 42"
Other D: 21" - 24"
H: 29"

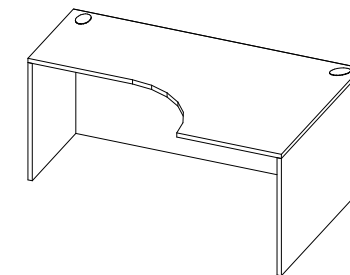

TL-UC4G-L-N / TL-UC4G-R-N
Unitized Desk - (Left Hand shown)
Full Modesty/ No Intermediate Gable
W: 66"- 72"
D: 39"- 42"
Other D: 21" - 24"
H: 29"

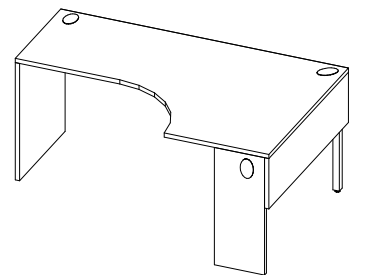

TL-UC4Z-L / TL-UC4G-R
Unitized Desk (Left Hand shown)
Partial Modesty w/ Intermediate Gable
W: 66"- 72"
D: 39"- 42"
Other D: 21" - 24"
H: 29"

Executive Corners

1.5" Thick

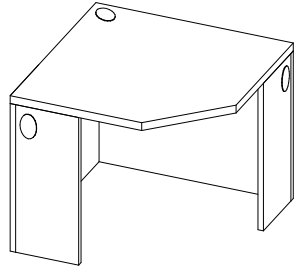

T-W5S0
Straight Front
Full Modesty w/ Intermediate Gable
W: 36" - 42"
D: 21" - 24"
H: 29.5"

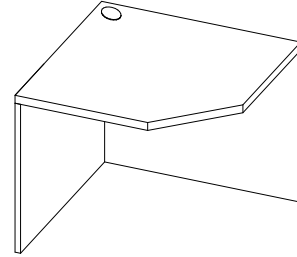

T-W5S0-N
Straight Front
Full Modesty/ No Intermediate Gable
W: 36" - 42"
D: 21" - 24"
H: 29.5"

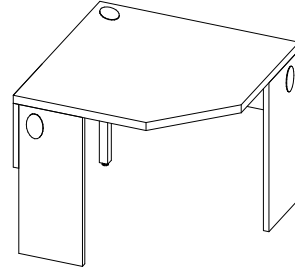

T-W5S0-P
Straight Front
Partial Modesty w/ Intermediate Gable
W: 36" - 42"
D: 21" - 24"
H: 29.5"

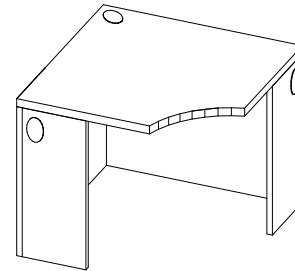

T-W5C0
Curve Front
Full Modesty w/ Intermediate Gable
W: 36" - 42"
D: 21" - 24"
H: 29.5"

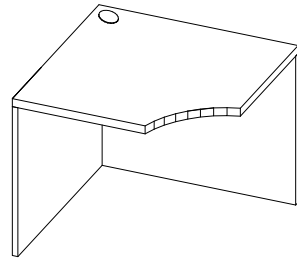

T-W5C0-N
Curve Front
Full Modesty/ No Intermediate Gable
W: 36" - 42"
D: 21" - 24"
H: 29.5"

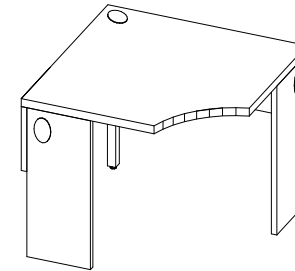

T-W5C0-P
Curve Front
Partial Modesty w/ Intermediate Gable
W: 36" - 42"
D: 21" - 24"
H: 29.5"

Executive Unitized Desks

1.5" Thick

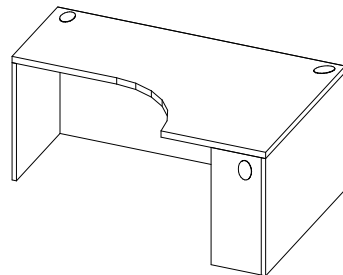

T-UC4G-L / T-UC4G-R
Unitized Desk (Left Hand shown)
Full Modesty w/ Intermediate Gable
W: 66" - 72"
D: 39" - 42"
Other D: 21" - 24"
H: 29.5"

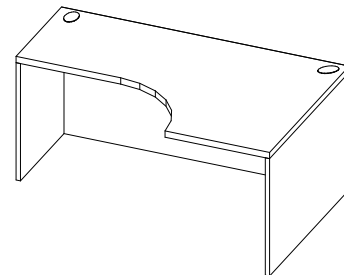

T-UC4G-L-N / T-UC4G-R-N
Unitized Desk (Left Hand shown)
Full Modesty/ No Intermediate Gable
W: 66" - 72"
D: 39" - 42"
Other D: 21" - 24"
H: 29.5"

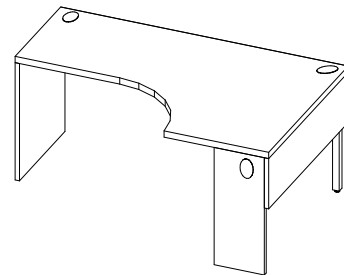

T-UC4Z-L / T-UC4G-R
Unitized Desk (Left Hand shown)
Partial Modesty w/ Intermediate Gable
W: 66" - 72"
D: 39" - 42"
Other D: 21" - 24"
H: 29.5"

Professional Bridges

1" Thick

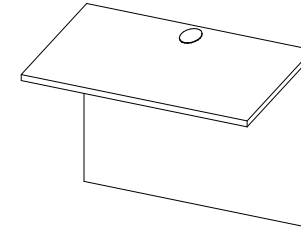

TL-BS0G
Straight w/ Full Modesty
W: 30" - 48"
D: 21" - 24"
H: 29"

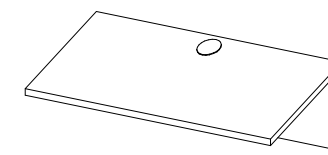

TL-BS0Z
Straight w/ Partial Modesty
W: 30" - 48"
D: 21" - 24"
H: 29"

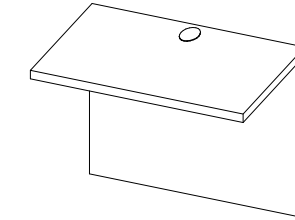

T-BS0G
Straight w/ Full Modesty
W: 30" - 48"
D: 21" - 24"
H: 29.5"

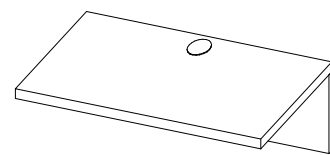

T-BS0Z
Straight w/ Partial Modesty
W: 30" - 48"
D: 21" - 24"
H: 29.5"

Professional Returns

1" Thick

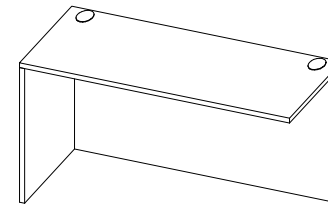

TL-WS1G-L / TL-WS1G-R
Straight w/ Full Modesty
(Left Hand shown)
W: 24" - 60"
D: 21" - 30"
H: 29"

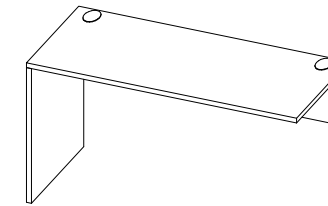

TL-WS1Z-L / TL-WS1Z-R
Straight w/ Partial Modesty
(Left Hand shown)
W: 24" - 60"
D: 21" - 30"
H: 29"

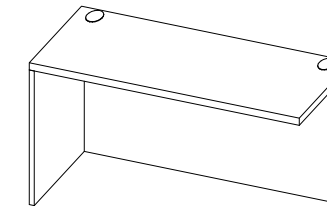

T-WS1G-L / T-WS1G-R
Straight w/ Full Modesty
(Left Hand shown)
W: 24" - 60"
D: 21" - 30"
H: 29.5"

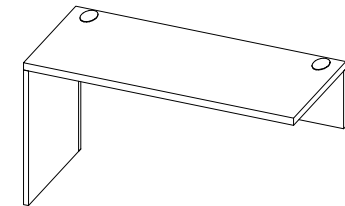

T-WS1Z-L / T-WS1Z-R
Straight w/ Partial Modesty
(Left Hand shown)
W: 24" - 60"
D: 21" - 30"
H: 29.5"

Credenza Top

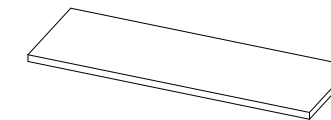

T-WSS0
1.5" Thick Credenza Top
W: 60" - 84"
D: 21"

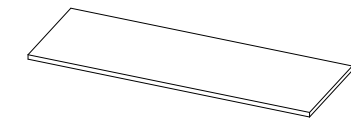

TL-WSS0
1" Thick Credenza Top
W: 60" - 84"
D: 21"

Professional Credenzas

1" Thick

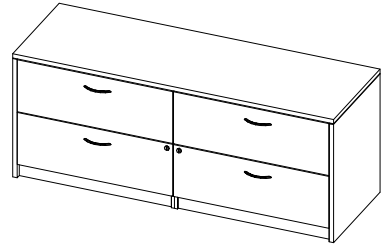

TL-CRLL
Credenza w/ Double Lateral
Files
W: 72"
D: 21" - 24"
H: 29"

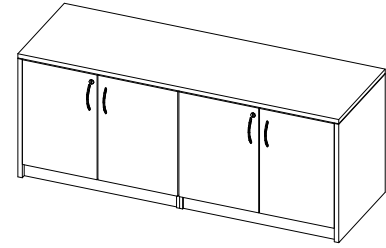

TL-CRSS
Credenza w/ Double Stor-
age Files
W: 72"
D: 21" - 24"
H: 29"

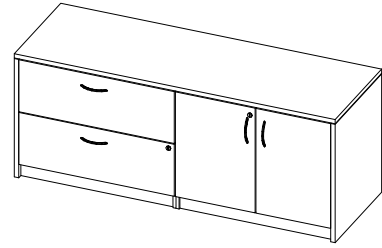

TL-CRLS
Credenza w/ Lateral File LH,
Storage Cabinet RH
W: 72"
D: 21" - 24"
H: 29"

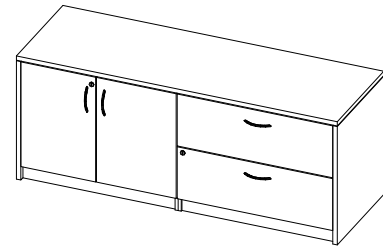

TL-CRSL
Credenza w/ Storage Cabi-
net LH,
Lateral File RH
W: 72"
D: 21" - 24"
H: 29"

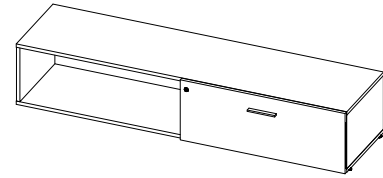

U-CRCL-L / U-CRCL-R
Open Credenza w/ Door
W: 72"
D: 18"
H: 15"

Executive Credenzas

1.5" Thick Top

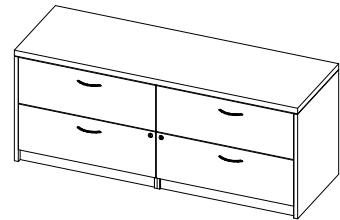

T-CRLL
Credenza w/ Double Lateral
Files
W: 72"
D: 21" - 24"
H: 29.5"

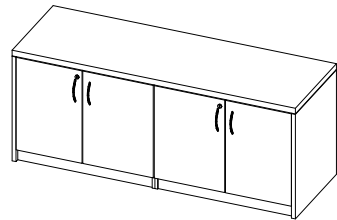

T-CRSS
Credenza w/ Double Stor-
age Files
W: 72"
D: 21" - 24"
H: 29.5"

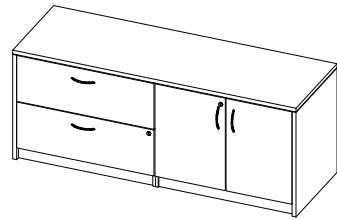

T-CRLS
Credenza w/ Lateral
File LH,
Storage Cabinet RH
W: 72"
D: 21" - 24"
H: 29.5"

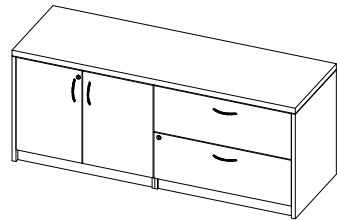

T-CRSL
Credenza w/ Storage Cabi-
net LH,
Lateral File RH
W: 72"
D: 21" - 24"
H: 29.5"

Supports

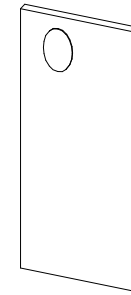

T-CGUO
Intermediate Gable Support
W: 12" - 18"
D: 1"
H: 28"

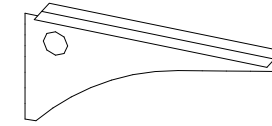

K-CCAB
Center Cantilever Support
W: 16" - 22"

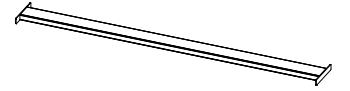

U-HRBO
Reinforcement Bar
W: 27" - 90"

Pedestals

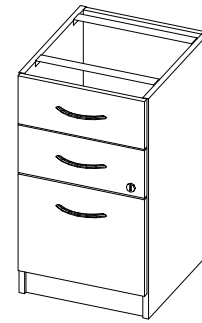

T-FPBU
Underdesk Box/Box/File
W: 16"
D: 18" - 24"
H: 28"

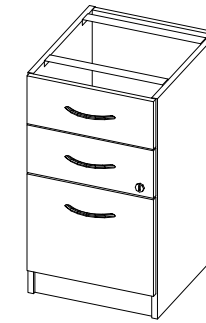

T-FPBU-X
Underdesk Box/Box/File
Full Back
W: 16"
D: 18" - 24"
H: 28"

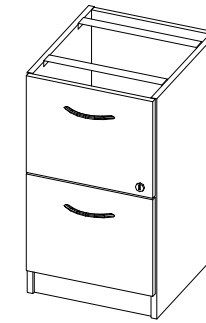

T-FPFU
Underdesk File/File
W: 16"
D: 18" - 24"
H: 28"

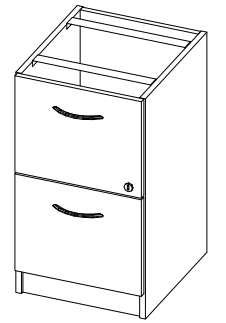

T-FPFU-X
Underdesk File/File
Full Back
W: 16"
D: 18" - 24"
H: 28"



T-FPSU
Suspended Box/File
W: 16"
D: 18"
H: 16"

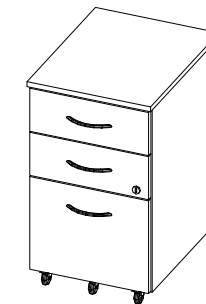

T-FPBM
Mobile Box/Box/File
W: 16"
D: 21"
H: 28"

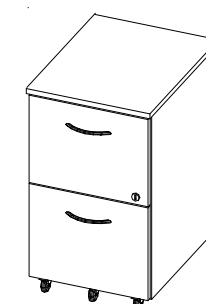

T-FPFM
Mobile File/File
W: 16"
D: 21"
H: 28"

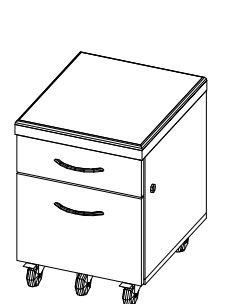

T-1030
Mobile Box/File w/ Seat
Cushion
W: 16"
D: 18"
H: 23"

Filing & Storage
Professional & Executive

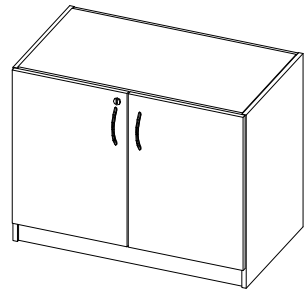

T-FSUO
Underdesk Storage Cabinet
W: 30" - 42"
D: 20" - 21"
H: 28"

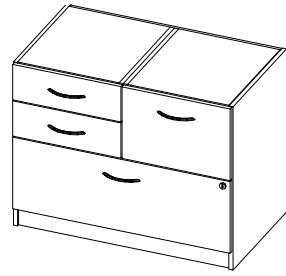

T-FPJU-L / T-FPJU-R
Underdesk Combo Pedestal
w/Box/Box/File and File/File
LH/ RH (LH shown)
W: 36"
D: 20" - 21"
H: 28"

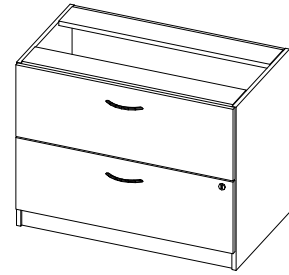

T-FL2U
Underdesk 2-Drawer Lat-
eral File
W: 30" - 42"
D: 20" - 21"
H: 28"

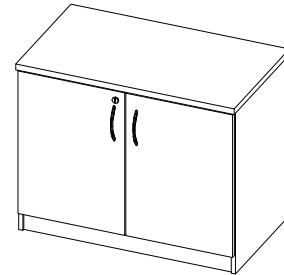

T-FSFO
1.5" Freestanding Storage
Cabinet
W: 30" - 42"
D: 21"
H: 29.5"

Professional Filing & Storage
1" Thick



TL-FL2F
Freestanding 2-Drawer Lateral File
W: 30" - 42"
D: 21"
H: 29"

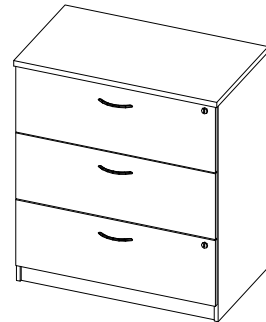

TL-FL3F
Freestanding 3-Drawer Lateral File
W: 30" - 36"
D: 21"
H: 40"

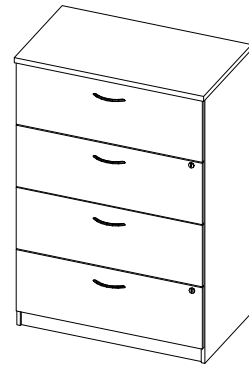

TL-FL4F
Freestanding 4-Drawer Lateral File
W: 30" - 36"
D: 21"
H: 52"

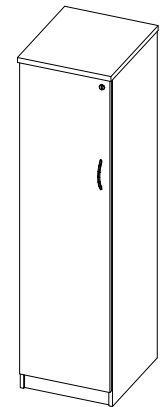

TL-FSDS-L / TL-FSDS-R
Storage Cabinet w/
Shelves
(Left Hand shown)
W: 18"
D: 21"
H: 67"

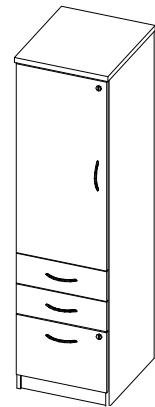

TL-FCSB-L / TL-FCSB-R
Combo Cabinet w/Storage
and Box/Box/File
(Left Hand shown)
W: 18"
D: 21"
H: 67"

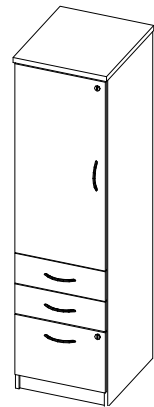

TL-FCSF-L / TL-FCSF-R
Combo Cabinet w/
Storage and File/File
(Left Hand shown)
W: 18"
D: 21"
H: 67"

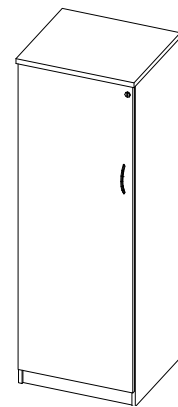

TL-FSDC-L / TL-FSDC-R
Storage Cabinet w/ Coat
Bar and Shelves
(Left Hand shown)
W: 24"
D: 21"
H: 67"

Professional Filing & Storage
1" Thick

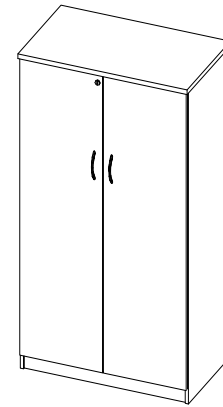

TL-FSDS
Double Door Storage
Cabinet
w/ Shelves
W: 36"
D: 21"
H: 67"

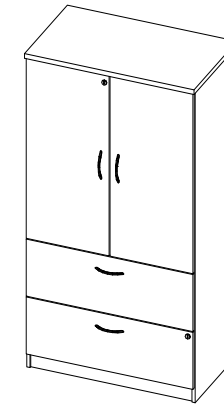

TL-FCSL
Combo Cabinet w/Storage
and Lateral File
W: 36"
D: 21"
H: 67"

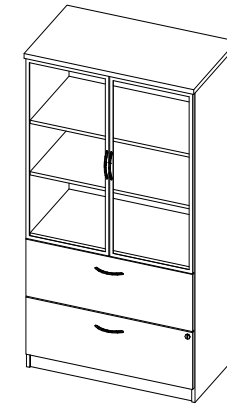

TL-FCSL-G
Combo Cabinet w/Storage,
Lateral File, Glazed Double
Doors
W: 36"
D: 21"
H: 67"

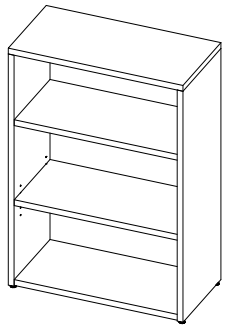

TL-SBOX
Bookcase
W: 24" - 42"
D: 12"/ 15"/ 21"
H: 29"/ 42"/ 54"/ 67"/ 77"

Executive Filing & Storage
1.5" Thick

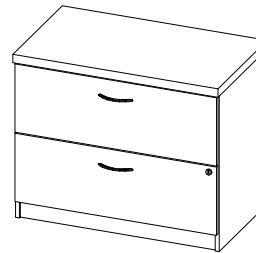

T-FL2F
Freestanding 2-Drawer Lateral File
W: 30" - 42"
D: 21"
H: 29.5"

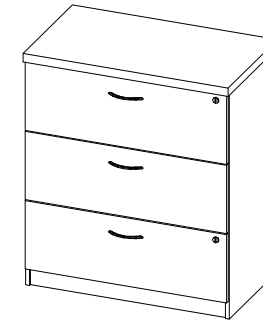

T-FL3F
Freestanding 3-Drawer Lateral File
W: 30" - 36"
D: 21"
H: 40.5"

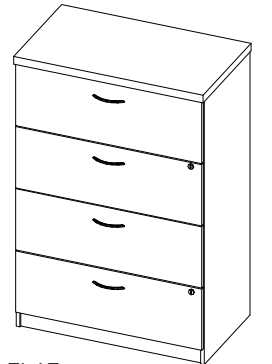

T-FL4F
Freestanding 4-Drawer Lateral File
W: 30" - 36"
D: 21"
H: 52.5"

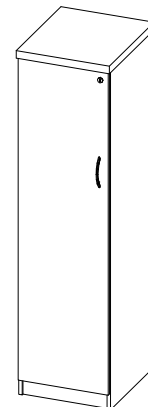

T-FSDS-L / T-FSDS-R
Storage Cabinet w/ Shelves
(Left Hand shown)
W: 18"
D: 21"
H: 68"

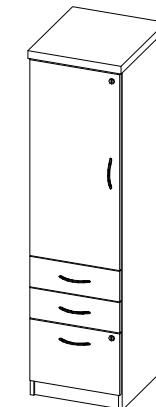

T-FCSB-L / T-FCSB-R
Combo Cabinet w/Storage
and Box/Box/File
(Left Hand shown)
W: 18"
D: 21"
H: 68"

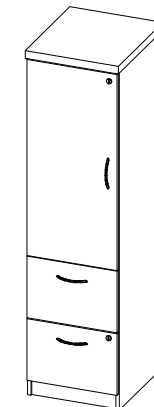

T-FCSF-L / T-FCSF-R
Combo Cabinet w/Storage
and File/File
(Left Hand shown)
W: 18"
D: 21"
H: 68"

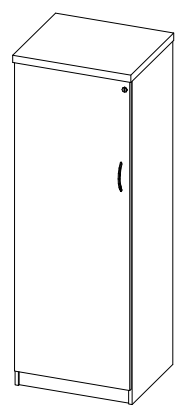

T-FSDC-L / T-FSDC-R
Storage Cabinet w/ Coat Bar
and Shelves
(Left Hand shown)
W: 24"
D: 21"
H: 68"

Executive Filing & Storage

1.5" Thick

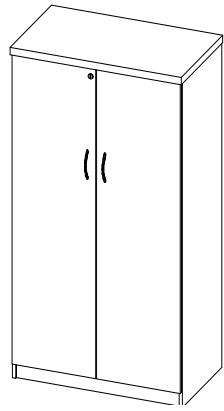

T-FSDS
Double Door Storage Cabinet
w/ Shelves
W: 36"
D: 21"
H: 68"

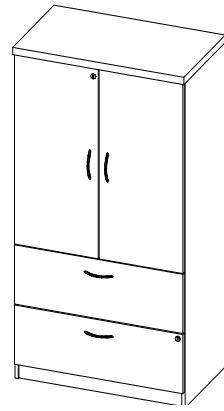

T-FCSL
Combo Cabinet w/Storage
and Lateral File
W: 36"
D: 21"
H: 68"

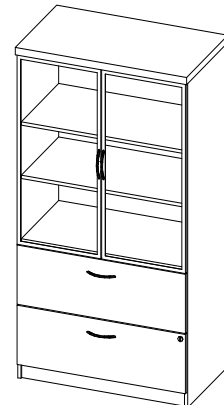

T-FCSL-G
Combo Cabinet w/Storage,
Lateral File. Glazed Double
Doors
W: 36"
D: 21"
H: 68"

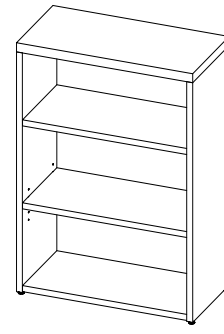

T-SBOX
Bookcase
W: 24" - 42"
D: 12"/15"/21"
H: 29"/42"/54"/68"/78"

Professional Overhead Storage

1" Thick

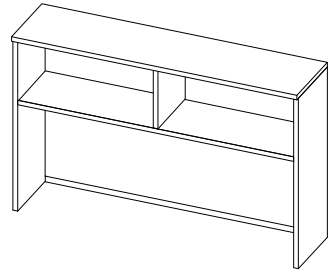

TL-SH00
Open Hutch
W: 30" - 84"
D: 15"
H: 38.5"

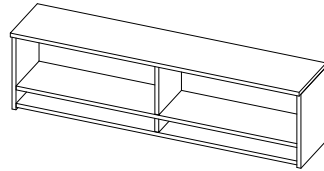

TL-SHOS
Wall Mounted Open Hutch
W: 72"
D: 15.5"
H: 20.19"

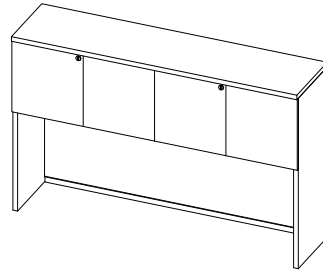

TL-SHH0
Hinged Door Hutch
W: 30" - 84"
D: 15"
H: 38.5"

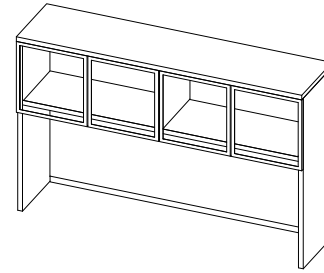

TL-SHH0-G
Hinged Door Hutch w/ Acrylic
Doors
W: 30" - 84"
D: 15"
H: 38.5"

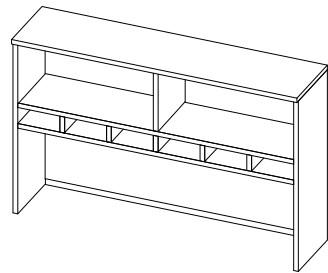

TL-SHOP
Open Hutch w/ Pigeon Holes
W: 30" - 84"
D: 15"
H: 38.5"

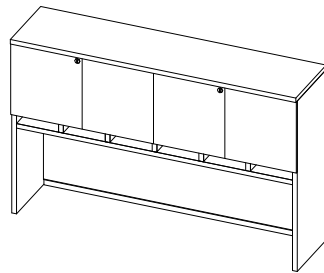

TL-SHHP-L
Hinged Door Hutch w/ Pigeon
Holes
W: 30" - 84"
D: 15"
H: 38.5"

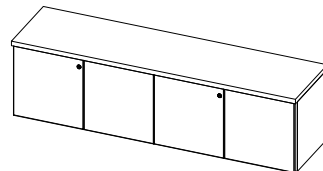

TL-SHHW-L
Wall Mounted Hinged Door
Hutch
W: 30" - 72"
D: 15"
H: 16.5"

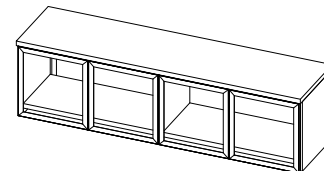

TL-SHHW-G
Wall Mounted Hinged Door
Hutch w/ Acrylic Doors
W: 30" - 72"
D: 15"
H: 16.5"

Executive Overhead Storage

1.5" Thick

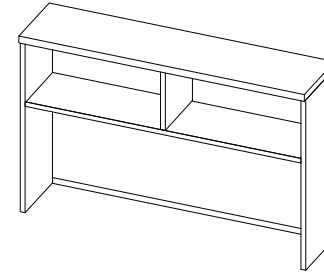

T-SH00
Open Hutch
W: 30" - 84"
D: 15"
H: 38.5"

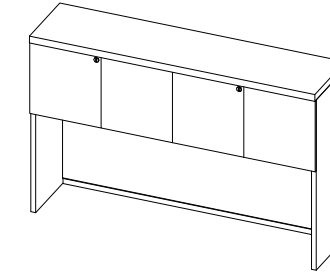

T-SHH0
Hinged Door Hutch
W: 30" - 84"
D: 15"
H: 38.5"

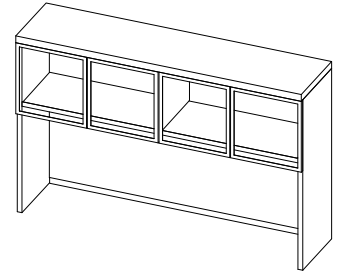

T-SHH0-G
Hinged Door Hutch w/ Acrylic
Doors
W: 30" - 84"
D: 15"
H: 38.5"

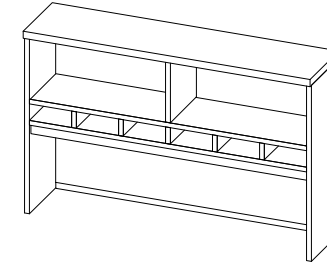

T-SHOP
Open Hutch w/ Pigeon Holes
W: 30" - 84"
D: 15"
H: 38.5"

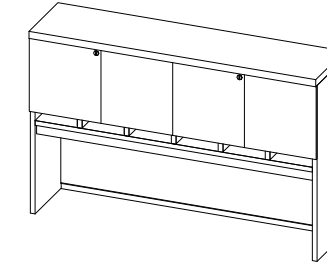

T-SHHP-L
Hinged Door Hutch w/ Pigeon
Holes
W: 30" - 84"
D: 15"
H: 38.5"

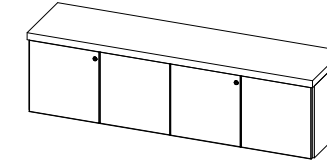

T-SHHW-L
Wall Mounted Hinged Door
Hutch
W: 30" - 72"
D: 15"
H: 16.5"

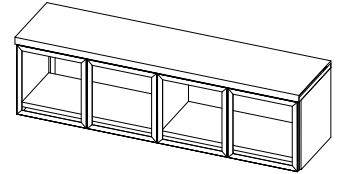

T-SHHW-G
Wall Mounted Hinged Door
Hutch w/ Acrylic Doors
W: 30" - 72"
D: 15"
H: 16.5"

Professional Table Tops

1" Thick

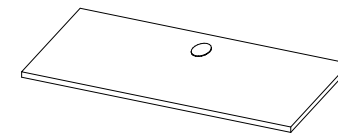

U-WS0G
Straight Tabletop w/ Grom-
met
W: 18" - 96"
D: 18" - 36"

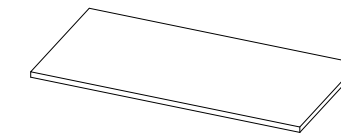

U-WS0N
Straight Tabletop - No Grom-
met
W: 18" - 96"
D: 18" - 36"

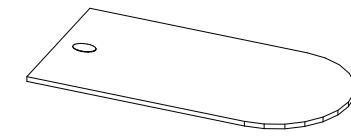

U-WDTG
D-Tabletop
W: 60" - 84"
D: 24" - 36"

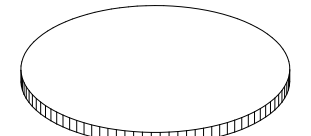

TL-WOXX
O-Tabletop
W: 24" - 60"
D: 24" - 60"

Executive Table Tops

1.5" Thick

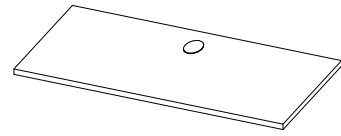

U-WSOG
Straight Tabletop w/ Grom-
met
W: 18" - 96"
D: 18" - 36"

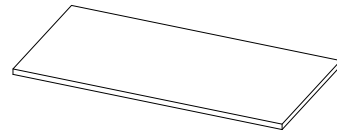

U-WSON
Straight Tabletop - No Grom-
met
W: 18" - 96"
D: 18" - 36"

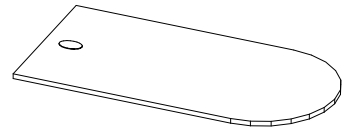

U-WDTG
D-Tabletop
W: 60" - 84"
D: 24" - 36"

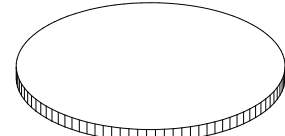

TL-WOXX
O-Tabletop
W: 24" - 60"
D: 24" - 60"

Bases

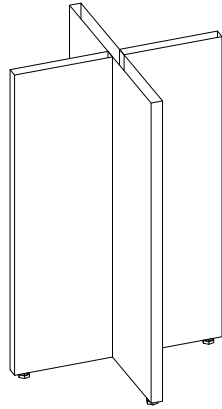

T-B6
Cross Base
W: 18" - 48"
D: 18" - 48"
H: 28"

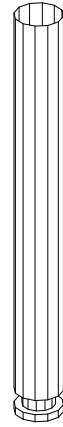

TB-BASE-1
Post Support Base
W: 3"
D: 3"
H: 28"

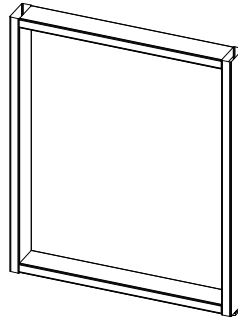

U-CG0M
Open Metal Gable
W: 12" - 36"
D: 3"
H: 28"/13.81"

Professional Reception Unit

1" Thick

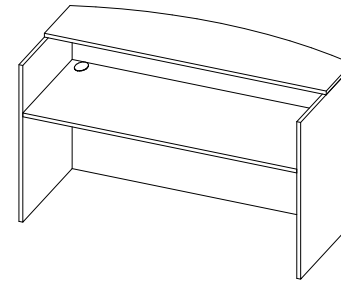

TL-RCOG
Reception Unit w/ Countertop
W: 72"
D: 30"
H: 43"

Executive Reception Unit

1.5" Thick

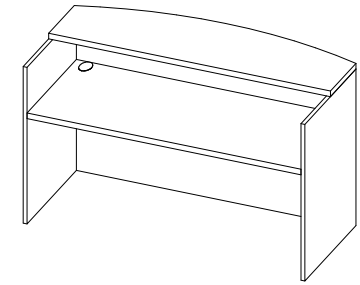

T-RCOG
Reception Unit w/ Countertop
W: 72"
D: 30"
H: 43"

Professional Service Write Up Desk

1" Thick

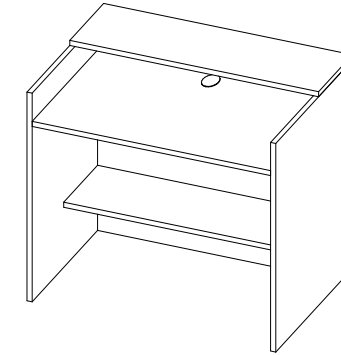

TL-RCWG-S
Service Write Up Desk w/ Straight
Countertop
W: 30 - 84"
D: 30"
H: 43"

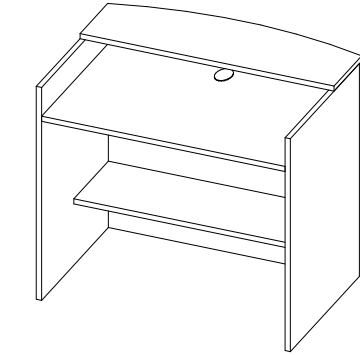

TL-RCWG-A
Service Write Up Desk w/ Arc Counter-
top
W: 30 - 84"
D: 30"
H: 43"

Executive Service Write Up Desk

1.5" Thick

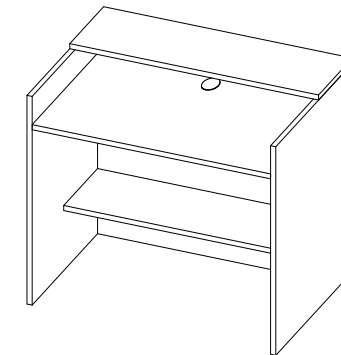

T-RCWG-S
Service Write Up Desk w/ Straight
Countertop
W: 30 - 84"
D: 30"
H: 43"

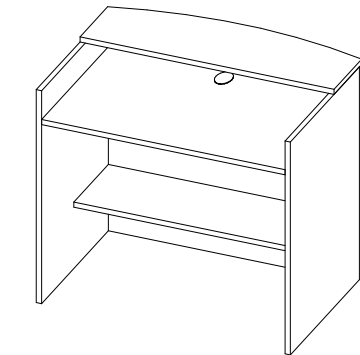

T-RCWG-A
Service Write Up Desk w/ Arc Counter-
top
W: 30 - 84"
D: 30"
H: 43"

Professional Coffee & End Table

1" Thick

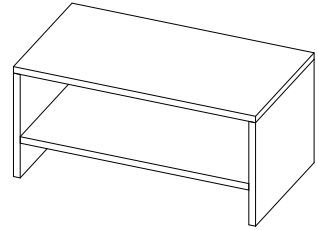

TL-TCTO
Coffee Table
W: 36" - 48"
D: 20"
H: 17"

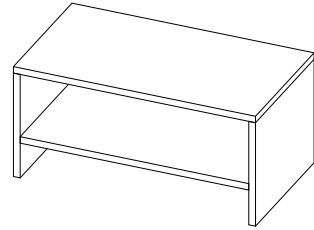

TL-TCTS
Coffee Table with Fixed
Shelf
W: 36"
D: 20"
H: 17"

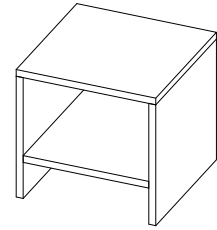

TL-TCTO
End Table
W: 20" - 30"
D: 20" - 30"
H: 19"

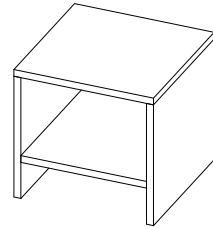

TL-TCTS
End Table with Fixed
Shelf
W: 20" - 30"
D: 20" - 30"
H: 19"

Executive Coffee & End Table

1.5" Thick

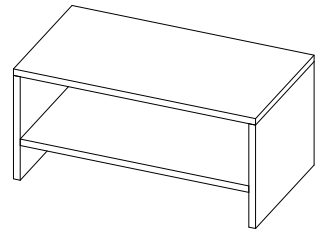

T-TCTO
Coffee Table
W: 36" - 48"
D: 20"
H: 17.5"

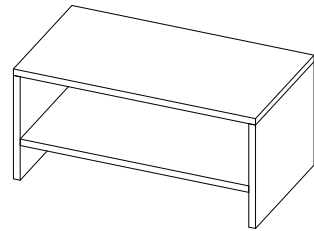

T-TCTS
Coffee Table with Fixed
Shelf
W: 36"
D: 20"
H: 17.5"

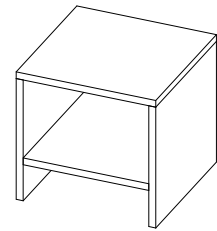

T-TCTO
End Table
W: 20" - 30"
D: 20" - 30"
H: 19.5"

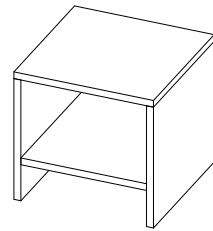

T-TCTS
End Table with Fixed
Shelf
W: 20" - 30"
D: 20" - 30"
H: 19.5"

Conference Table Tops

1.5" Thick

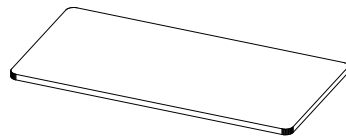

TB-MSSX
Straight Tabletop
W: 72" - 240"
D: 36" - 60"

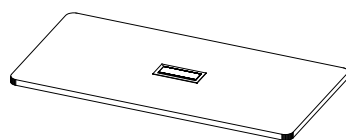

TB-MSSP
Straight Tabletop with
Power
W: 72" - 240"
D: 36" - 60"

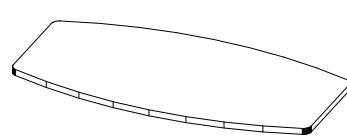

TB-MBBX
Boat-Shaped Tabletop
W: 72" - 240"
D: 36" - 60"

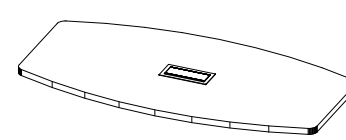

TB-MBBP
Boat-Shaped Tabletop with
Power
W: 72" - 240"
D: 36" - 60"

Conference Table Tops

1.5" Thick

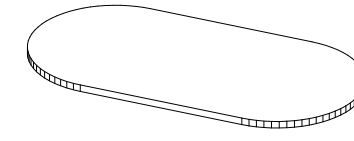

TB-MRRX
Racetrack Tabletop
W: 72" - 240"
D: 36" - 60"

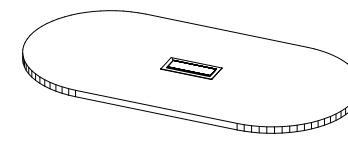

TB-MRRP
Racetrack Tabletop with
Power
W: 72" - 240"
D: 36" - 60"

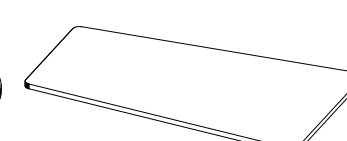

TB-MTTX
Tapered Tabletop
W: 84" - 240"
D: 48" - 78"

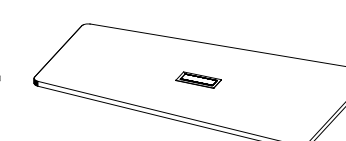

TB-MTTP
Tapered Tabletop with
Power
W: 84" - 240"
D: 48" - 78"

Conference Gable & Modesty Base

1.5" Thick

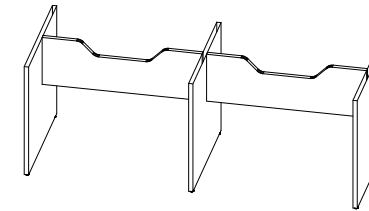

TB-B4
Gable Base for Straight/Boat
Tabletop
W: 42" - 60"
D: 21" - 240"
H: 28"

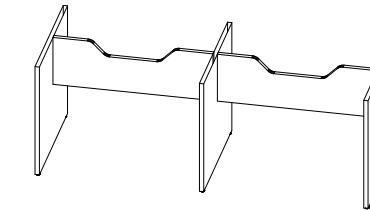

TB-B4-R
Gable Base for Racetrack
Tabletop
W: 48" - 60"
D: 84" - 240"
H: 28"

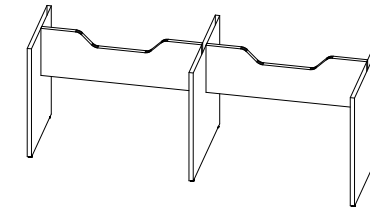

TB-B4-T
Gable Base for Tapered
Tabletop
W: 48" - 78"
D: 84" - 240"
H: 28"

Conference Elliptical Base

1.5" Thick

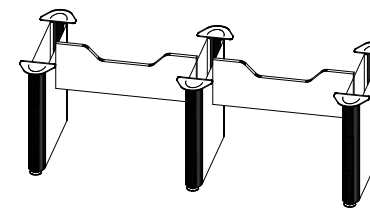

TB-B5
Elliptical Base for
Straight/Boat Tabletop
W: 36" - 60"
D: 72" - 204"
H: 28"

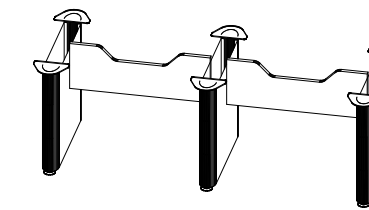

TB-B5-R
Elliptical Base for Race-
track Tabletop
W: 48" - 60"
D: 84" - 204"
H: 28"

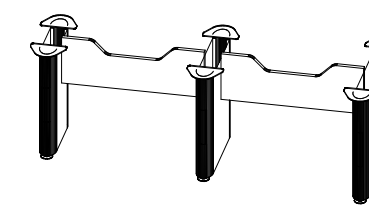

TB-B5-T
Elliptical Base for Tapered
Tabletop
W: 48" - 60"
D: 84" - 204"
H: 28"

Ellora Grommet Add-ons

Options



T-RJ45



T-RJ11



T-HDMI



T-VGA



T-STEREO

Conference Filing and Storage

1.5" Thick

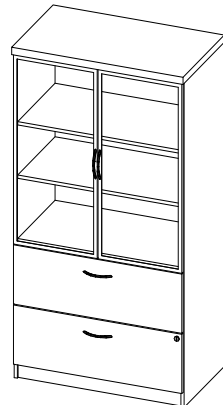

TB-FCSL-G
Combo Cabinet with Storage, Lateral Files and Acrylic Doors
W: 36"
D: 21"
H: 78"

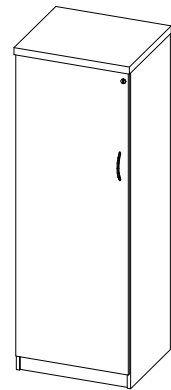

TB-FSDC-L / TB-FSDC-R
Storage Cabinet with Coat Bar and Shelves (Left Hand shown)
W: 24"
D: 21"
H: 78"

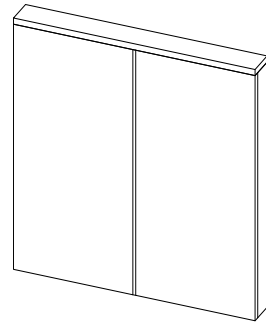

TB-VB00
Whiteboard Cabinet
W: 48"
D: 5.6"
H: 51"

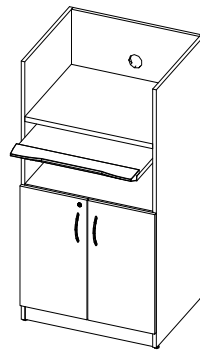

U-TCDS
1" Computer Desk with 1.5" Top
W: 28"
D: 24"
H: 54"

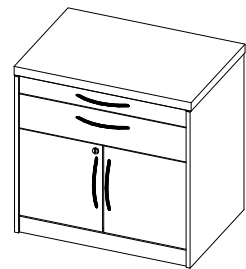

TB-FCS0
Serving Cabinet
W: 30" - 36"
D: 21"
H: 29.5"

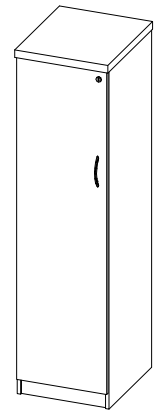

TB-FSDS-L / TB-FSDS-R
Storage Cabinet with Shelves (Left Hand shown)
W: 18"
D: 21"
H: 78"

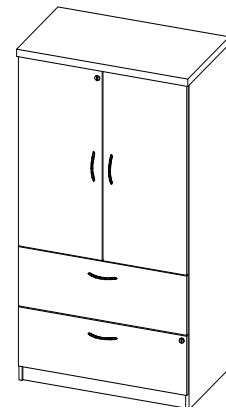

TB-FCSL
Combo Cabinet with Storage and Lateral Files
W: 36"
D: 21"
H: 78"

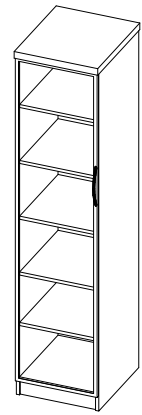

TB-FSDS-LG / TB-FSDS-RG
Storage Cabinet with Shelves and Acrylic Doors (Left Hand shown)
W: 18"
D: 21"
H: 78"

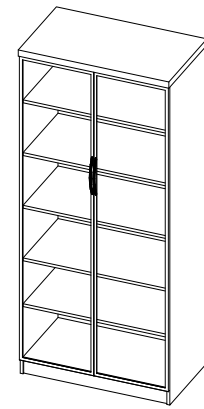

TB-FSDS-G
Double Door Storage Cabinet with Shelves and Acrylic Doors
W: 36"
D: 21"
H: 78"

Accessories

Keyboard

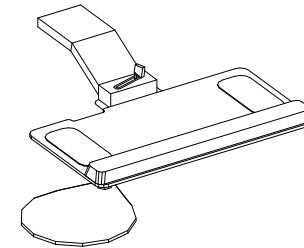

V-KASO-L / V-KASO-R
Articulating Keyboard Tray with Mouse Tray
W: 20"
D: 11"

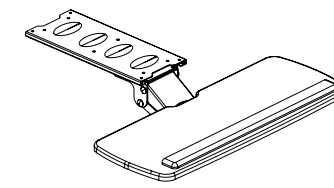

V-KASX
Articulating Keyboard Tray
W: 25"
D: 10"

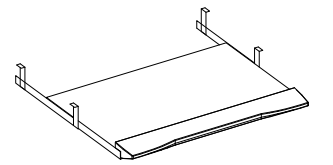

V-KRS0
Retractable Laminate Keyboard Tray
W: 25"
D: 16"

Tackboard for Hutch

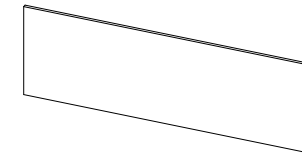

V-ATH0
14" H Tackboard for Hutch with Pigeon Holes
W: 27" - 81"
D: 0.5"
H: 14"

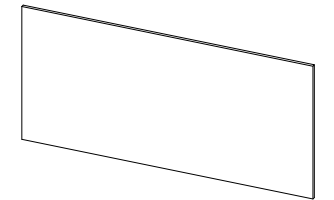

V-ATH0
21" H Tackboard for Hutch without Pigeon Holes
W: 27" - 81"
D: 0.5"
H: 21"

Pencil Drawer

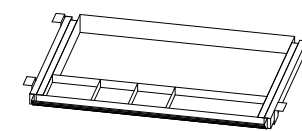

V-ADPP
Plastic Pencil Drawer
W: 21"
D: 16"
H: 2.8"

Tasklight



V-ELU
Task Light
W: 24"/36"

Monitor Arm

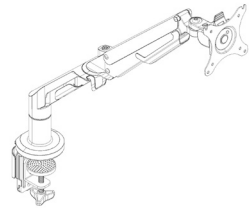

V-AFMA-01
Monitor Arm -
Single Mount

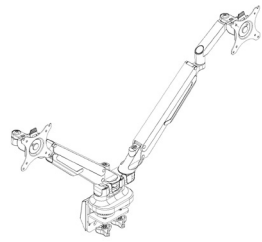

V-AFMA-02
Monitor Arm -
Double Mount

CPU Holder

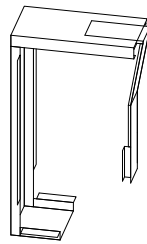

V-ACPU
CPU Holder - Fixed Mount
W: 8.5"
D: 11.5"
H: 18"

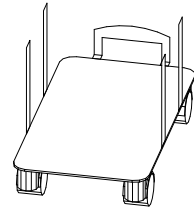

V-ACPU-M
CPU Holder - Mobile
W: 15.5"
D: 9"
H: 4.3"

Wire Manager

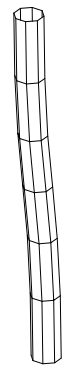

V-EE00
Vertical Wire Manager
W: 4"
D: 4"
H: 28"

step-by-step order placement

1. purchase order number
2. quantity
3. product codes and descriptions
4. finishes
5. options
6. provide a drawing or Tayco quotation number
7. shipping address, on-site contact name and phone number
8. shipping instructions
9. confirm access to elevators, loading dock, etc.
10. requested ship date/installation date
11. submit a completed Tayco installation checklist if Tayco is installing the furniture
12. discount, net price and freight charges
13. keep Tayco order numbers on file for reference when placing additional orders



Metro Pricebook
October 2024
Straight Desk

straight

Executive

<u>straight</u>	34
<u>straight partial modesty</u>	38
<u>straight full recessed modesty</u>	42
<u>arc full recessed modesty</u>	46

Professional

<u>straight</u>	36
<u>straight partial modesty</u>	40
<u>straight full recessed modesty</u>	44
<u>arc full recessed modesty</u>	47

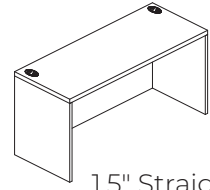

1.5" Straight Desk/Full Modesty

How to Specify:

Each laminate comes with matching vinyl trim color unless otherwise specified on your purchase order. Refer to the laminate finish card for details.

Notes:

Options:

laminate color

edge profile

grommet color

How to Order and Read your Code:

T or TL **TSOG** **60** **21**
 product line item width depth

Code	Price	H	W	D	Volume (ft ³)	Weight (lb)
T-TS0G-6021	946	29.5	60	21	21.51	122.55
T-TS0G-6621	997	29.5	66	21	23.66	131.97
T-TS0G-7221	1037	29.5	72	21	25.81	141.39
T-TS0G-7821	1082	29.5	78	21	27.96	150.81
T-TS0G-8421	1144	29.5	84	21	30.11	160.23
T-TS0G-9021	1315	29.5	90	21	32.27	169.65
T-TS0G-9621	1315	29.5	96	21	34.42	179.07
T-TS0G-3024	754	29.5	30	24	12.29	92.02
T-TS0G-3624	800	29.5	36	24	14.75	111.14
T-TS0G-4224	834	29.5	42	24	17.21	130.26
T-TS0G-4824	883	29.5	48	24	19.67	149.38
T-TS0G-5424	934	29.5	54	24	22.13	168.5
T-TS0G-6024	986	29.5	60	24	24.58	187.62
T-TS0G-6624	1037	29.5	66	24	27.04	206.74
T-TS0G-7224	1075	29.5	72	24	29.5	225.86
T-TS0G-7824	1128	29.5	78	24	31.96	244.98
T-TS0G-8424	1188	29.5	84	24	34.42	264.1
T-TS0G-9024	1513	29.5	90	24	36.88	283.22
T-TS0G-9624	1513	29.5	96	24	39.33	302.34
T-TS0G-3030	793	29.5	30	30	15.36	99.05
T-TS0G-3630	855	29.5	36	30	18.44	110.58
T-TS0G-4230	905	29.5	42	30	21.51	122.11
T-TS0G-4830	965	29.5	48	30	24.58	133.64
T-TS0G-5430	1037	29.5	54	30	27.66	145.17
T-TS0G-6030	1082	29.5	60	30	30.73	156.7
T-TS0G-6630	1128	29.5	66	30	33.8	168.23
T-TS0G-7230	1172	29.5	72	30	36.88	179.76
T-TS0G-7830	1246	29.5	78	30	39.95	191.29
T-TS0G-8430	1307	29.5	84	30	43.02	202.82
T-TS0G-9030	1555	29.5	90	30	46.09	214.35
T-TS0G-9630	1597	29.5	96	30	49.17	225.88

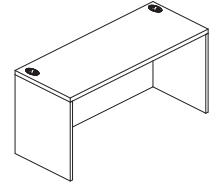

1" Straight Desk w/Full Modesty

How to Specify:

Each laminate comes with matching vinyl trim color unless otherwise specified on your purchase order. Refer to the laminate finish card for details.

Notes:

Options:

laminate color

grommet color

Code	Price	H	W	D	Volume (ft ³)	Weight (lb)
TL-TS0G-6021	872	29	60	21	21.15	107.7
TL-TS0G-6621	922	29	66	21	23.26	117.12
TL-TS0G-7221	957	29	72	21	25.38	126.54
TL-TS0G-7821	1005	29	78	21	27.49	135.96
TL-TS0G-8421	1061	29	84	21	29.6	145.38
TL-TS0G-9021	1152	29	90	21	31.72	154.8
TL-TS0G-9621	1152	29	96	21	33.83	164.22
TL-TS0G-3024	697	29	30	24	12.08	77.17
TL-TS0G-3624	745	29	36	24	14.5	96.29
TL-TS0G-4224	773	29	42	24	16.92	115.41
TL-TS0G-4824	817	29	48	24	19.33	134.53
TL-TS0G-5424	863	29	54	24	21.75	153.65
TL-TS0G-6024	911	29	60	24	24.17	172.77
TL-TS0G-6624	957	29	66	24	26.58	191.89
TL-TS0G-7224	997	29	72	24	29	211.01
TL-TS0G-7824	1041	29	78	24	31.42	230.13
TL-TS0G-8424	1098	29	84	24	33.83	249.25
TL-TS0G-9024	1382	29	90	24	36.25	268.37
TL-TS0G-9624	1445	29	96	24	38.67	287.49
TL-TS0G-3030	736	29	30	30	15.1	84.2
TL-TS0G-3630	792	29	36	30	18.13	95.73
TL-TS0G-4230	838	29	42	30	21.15	107.26
TL-TS0G-4830	896	29	48	30	24.17	118.79
TL-TS0G-5430	956	29	54	30	27.19	130.32
TL-TS0G-6030	1005	29	60	30	30.21	141.85
TL-TS0G-6630	1041	29	66	30	33.23	153.38
TL-TS0G-7230	1085	29	72	30	36.25	164.91
TL-TS0G-7830	1150	29	78	30	39.27	176.44
TL-TS0G-8430	1211	29	84	30	42.29	187.97
TL-TS0G-9030	1425	29	90	30	45.31	199.5
TL-TS0G-9630	1501	29	96	30	48.33	211.03

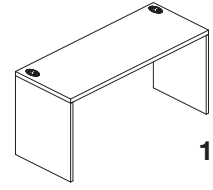

1.5" Straight Desk w/Partial Modesty

How to Specify:

Each laminate comes with matching vinyl trim color unless otherwise specified on your purchase order. Refer to the laminate finish card for details.

Notes:

Partial modesties are 12"H.

Options:

laminate color

edge profile

grommet color

Code	Price	H	W	D	Volume (ft ³)	Weight (lb)
T-TS0Z-6021	946	29.5	60	21	21.51	97.81
T-TS0Z-6621	997	29.5	66	21	23.66	104.54
T-TS0Z-7221	1037	29.5	72	21	25.81	111.27
T-TS0Z-7821	1082	29.5	78	21	27.96	118
T-TS0Z-8421	1144	29.5	84	21	30.11	124.73
T-TS0Z-9021	1315	29.5	90	21	32.27	131.46
T-TS0Z-9621	1592	29.5	96	21	34.42	138.19
T-TS0Z-3024	754	29.5	30	24	12.29	71.33
T-TS0Z-3624	800	29.5	36	24	14.75	78.75
T-TS0Z-4224	834	29.5	42	24	17.21	86.17
T-TS0Z-4824	883	29.5	48	24	19.67	93.59
T-TS0Z-5424	934	29.5	54	24	22.13	101.01
T-TS0Z-6024	986	29.5	60	24	24.58	108.43
T-TS0Z-6624	1037	29.5	66	24	27.04	115.85
T-TS0Z-7224	1075	29.5	72	24	29.5	123.27
T-TS0Z-7824	1128	29.5	78	24	31.96	130.69
T-TS0Z-8424	1188	29.5	84	24	34.42	138.11
T-TS0Z-9024	1382	29.5	90	24	36.88	145.53
T-TS0Z-9624	1671	29.5	96	24	39.33	152.95
T-TS0Z-3030	793	29.5	30	30	15.36	75.35
T-TS0Z-3630	855	29.5	36	30	18.44	83.98
T-TS0Z-4230	905	29.5	42	30	21.51	92.6
T-TS0Z-4830	965	29.5	48	30	24.58	101.23
T-TS0Z-5430	1037	29.5	54	30	27.66	109.85
T-TS0Z-6030	1082	29.5	60	30	30.73	118.48
T-TS0Z-6630	1128	29.5	66	30	33.8	127.1
T-TS0Z-7230	1172	29.5	72	30	36.88	135.73
T-TS0Z-7830	1246	29.5	78	30	39.95	144.35
T-TS0Z-8430	1307	29.5	84	30	43.02	152.98
T-TS0Z-9030	1572	29.5	90	30	46.09	161.6
T-TS0Z-9630	1671	29.5	96	30	49.17	170.23

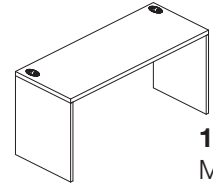

1" Straight Desk w/Partial Modesty

How to Specify:

Each laminate comes with matching vinyl trim color unless otherwise specified on your purchase order. Refer to the laminate finish card for details.

Notes:

Partial modesties are 12"H.

Options:

laminate color

grommet color

Code	Price	H	W	D	Volume (ft ³)	Weight (lb)
TL-TS0Z-6021	872	29	60	21	21.15	81.41
TL-TS0Z-6621	922	29	66	21	23.26	86.6
TL-TS0Z-7221	957	29	72	21	25.38	91.79
TL-TS0Z-7821	1005	29	78	21	27.49	96.98
TL-TS0Z-8421	1061	29	84	21	29.6	102.17
TL-TS0Z-9021	1152	29	90	21	31.72	107.36
TL-TS0Z-9621	1236	29	96	21	33.83	112.55
TL-TS0Z-3024	697	29	30	24	12.08	61.95
TL-TS0Z-3624	745	29	36	24	14.5	67.5
TL-TS0Z-4224	773	29	42	24	16.92	73.05
TL-TS0Z-4824	817	29	48	24	19.33	78.6
TL-TS0Z-5424	863	29	54	24	21.75	84.15
TL-TS0Z-6024	911	29	60	24	24.17	89.7
TL-TS0Z-6624	957	29	66	24	26.58	95.25
TL-TS0Z-7224	997	29	72	24	29	100.8
TL-TS0Z-7824	1041	29	78	24	31.42	106.35
TL-TS0Z-8424	1098	29	84	24	33.83	111.9
TL-TS0Z-9024	1382	29	90	24	36.25	117.45
TL-TS0Z-9624	1445	29	96	24	38.67	123
TL-TS0Z-3030	736	29	30	30	15.1	63.48
TL-TS0Z-3630	792	29	36	30	18.13	69.97
TL-TS0Z-4230	838	29	42	30	21.15	76.46
TL-TS0Z-4830	896	29	48	30	24.17	82.95
TL-TS0Z-5430	956	29	54	30	27.19	89.44
TL-TS0Z-6030	1005	29	60	30	30.21	95.93
TL-TS0Z-6630	1041	29	66	30	33.23	102.42
TL-TS0Z-7230	1085	29	72	30	36.25	108.91
TL-TS0Z-7830	1150	29	78	30	39.27	115.4
TL-TS0Z-8430	1211	29	84	30	42.29	121.89
TL-TS0Z-9030	1402	29	90	30	45.31	128.38
TL-TS0Z-9630	1501	29	96	30	48.33	134.87

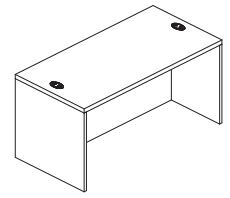

1.5" Straight Desk w/Recessed Full Modesty and Grommets

How to Specify:

Each laminate comes with matching vinyl trim color unless otherwise specified on your purchase order. Refer to the laminate finish card for details.

Options:

laminate color

edge profile

grommet color

Notes:

Recessed modesty:

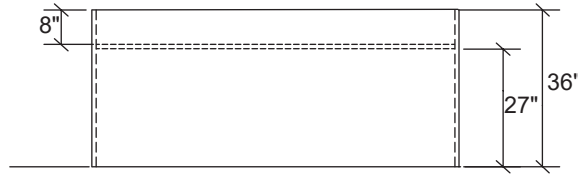

Code	Price	H	W	D	Volume (ft ³)	Weight (lb)
T-TSRG-6030	1103	29.5	60	30	30.73	156.7
T-TSRG-6630	1144	29.5	66	30	33.8	168.23
T-TSRG-7230	1197	29.5	72	30	36.88	179.76
T-TSRG-7830	1266	29.5	78	30	39.95	191.29
T-TSRG-8430	1326	29.5	84	30	43.02	202.82
T-TSRG-9030	1620	29.5	90	30	46.09	214.35
T-TSRG-9630	1688	29.5	96	30	49.17	225.88
T-TSRG-6036	1278	29.5	60	36	36.88	178.2
T-TSRG-6636	1326	29.5	66	36	40.56	190.8
T-TSRG-7236	1377	29.5	72	36	44.25	203.4
T-TSRG-7836	1437	29.5	78	36	47.94	216
T-TSRG-8436	1489	29.5	84	36	51.63	228.6
T-TSRG-9036	1704	29.5	90	36	55.31	241.2
T-TSRG-9636	1777	29.5	96	36	59	253.8

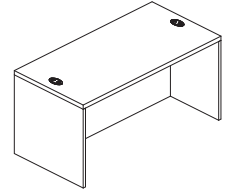

1" Straight Desk w/Recessed Full Modesty and Grommets

How to Specify:

Each laminate comes with matching vinyl trim color unless otherwise specified on your purchase order. Refer to the laminate finish card for details.

Notes:

Recessed modesty:

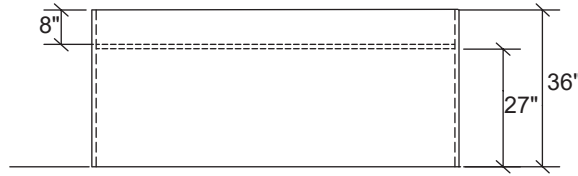

Options:

laminate color

grommet color

Code	Price	H	W	D	Volume (ft ³)	Weight (lb)
TL-TSRG-6030	1022	29	60	30	30.21	137.93
TL-TSRG-6630	1061	29	66	30	33.23	149.46
TL-TSRG-7230	1108	29	72	30	36.25	160.99
TL-TSRG-7830	1169	29	78	30	39.27	172.52
TL-TSRG-8430	1227	29	84	30	42.29	184.05
TL-TSRG-9030	1447	29	90	30	45.31	195.58
TL-TSRG-9630	1565	29	96	30	48.33	207.11
TL-TSRG-6036	1184	29	60	36	36.25	150.3
TL-TSRG-6636	1227	29	66	36	39.88	160.2
TL-TSRG-7236	1274	29	72	36	43.5	170.1
TL-TSRG-7836	1330	29	78	36	47.13	180
TL-TSRG-8436	1379	29	84	36	50.75	189.9
TL-TSRG-9036	1522	29	90	36	54.38	199.8
TL-TSRG-9636	1651	29	96	36	58	209.7

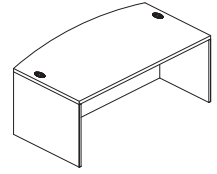

1.5" Arc Desk w/Recessed Full Modesty and Grommets

How to Specify:

Each laminate comes with matching vinyl trim color unless otherwise specified on your purchase order. Refer to the laminate finish card for details.

Options:

laminate color

edge profile

grommet color

Notes:

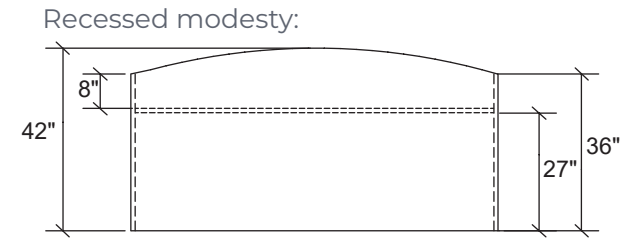

Code	Price	H	W	D	Volume (ft ³)	Weight (lb)
T-TARG-7236	1597	29.5	72	36	44.25	216.17
T-TARG-7836	1671	29.5	78	36	47.94	230.43
T-TARG-8436	1745	29.5	84	36	51.63	244.69
T-TARG-9036	1845	29.5	90	36	55.31	258.95
T-TARG-9636	1936	29.5	96	36	59	273.21

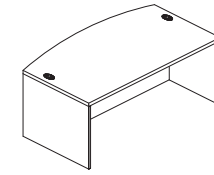

1" Arc Desk w/Recessed Full Modesty and Grommets

How to Specify:

Each laminate comes with matching vinyl trim color unless otherwise specified on your purchase order. Refer to the laminate finish card for details.

Options:

laminate color

grommet color

Notes:

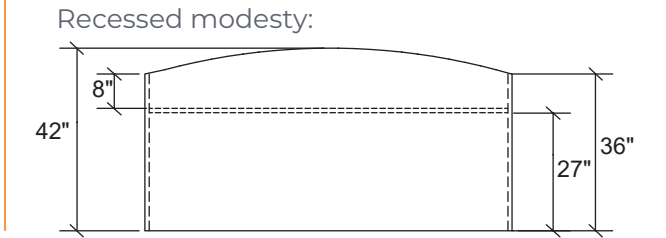

Code	Price	H	W	D	Volume (ft ³)	Weight (lb)
TL-TARG-7236	1485	29	72	36	43.5	178.09
TL-TARG-7836	1559	29	78	36	47.13	188.84
TL-TARG-8436	1636	29	84	36	50.75	199.59
TL-TARG-9036	1704	29	90	36	54.38	210.34
TL-TARG-9636	1777	29	96	36	58	221.09



Metro Pricebook
October 2024
Tables

Executive

<u>D-table</u>	50
<u>J-table</u>	52
<u>P-table</u>	54
<u>F-table</u>	56
<u>U-table</u>	58
<u>C-table</u>	60

Professional

<u>D-table</u>	51
<u>J-table</u>	53
<u>P-table</u>	55
<u>F-table</u>	57
<u>U-table</u>	59
<u>C-table</u>	61

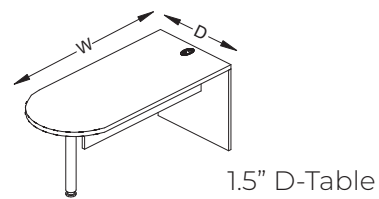

How to Specify:

Each laminate comes with matching vinyl trim color unless otherwise specified on your purchase order. Refer to the laminate finish card for details.

Options:

- laminate color

- edge profile

- grommet color

- metal color (for post support)

Notes:

36\"/>

How to Order and Read your Code:

T or TL	TD0G	60	30
product line	item	width	depth

Code	Price	H	W	D	Volume (ft ³)	Weight (lb)
T-TD0G-6030	1319	29.5	60	30	30.73	108.29
T-TD0G-6630	1361	29.5	66	30	33.8	117.27
T-TD0G-7230	1408	29.5	72	30	36.88	126.25
T-TD0G-7830	1450	29.5	78	30	39.95	135.23
T-TD0G-8430	1492	29.5	84	30	43.02	144.21
T-TD0G-6036	1415	29.5	60	36	36.88	131.34
T-TD0G-6636	1471	29.5	66	36	40.56	141.76
T-TD0G-7236	1502	29.5	72	36	44.25	152.18
T-TD0G-7836	1542	29.5	78	36	47.94	162.6
T-TD0G-8436	1587	29.5	84	36	51.63	173.02

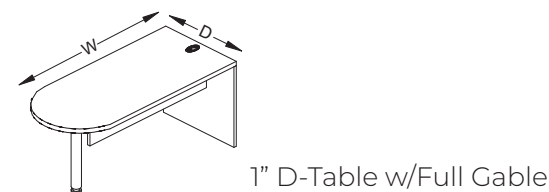

How to Specify:

Each laminate comes with matching vinyl trim color unless otherwise specified on your purchase order. Refer to the laminate finish card for details.

Options:

- laminate color

- grommet color

- metal color (for post support)

Notes:

36\"/>

Code	Price	H	W	D	Volume (ft ³)	Weight (lb)
TL-TD0G-6030	1081	29	60	30	30.21	86.48
TL-TD0G-6630	1128	29	66	30	33.23	92.95
TL-TD0G-7230	1168	29	72	30	36.25	99.42
TL-TD0G-7830	1211	29	78	30	39.27	105.9
TL-TD0G-8430	1257	29	84	30	42.29	112.38
TL-TD0G-6036	1180	29	60	36	36.25	107.18
TL-TD0G-6636	1232	29	66	36	39.88	115.76
TL-TD0G-7236	1266	29	72	36	43.5	124.34
TL-TD0G-7836	1308	29	78	36	47.13	132.92
TL-TD0G-8436	1354	29	84	36	50.75	141.5

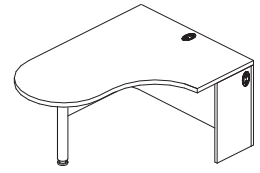

1.5" J-Table, LH Shown

How to Specify:

Each laminate comes with matching vinyl trim color unless otherwise specified on your purchase order. Refer to the laminate finish card for details.

Notes:

Options:

- laminate color

- edge profile

- grommet color

- metal color (for post support)

Code	Price	H	W	D	Volume (ft ³)	Weight (lb)
Left Hand						
T-TJ0G-604824-L	1738	29.5	60	24	24.58	149.48
T-TJ0G-664824-L	1854	29.5	66	24	27.04	158.56
T-TJ0G-724824-L	1948	29.5	72	24	29.5	167.64
T-TJ0G-784824-L	2050	29.5	78	24	31.96	176.72
T-TJ0G-844824-L	2147	29.5	84	24	34.42	185.8
Right Hand						
T-TJ0G-604824-R	1738	29.5	60	24	24.58	149.48
T-TJ0G-664824-R	1854	29.5	66	24	27.04	158.56
T-TJ0G-724824-R	1948	29.5	72	24	29.5	167.64
T-TJ0G-784824-R	2050	29.5	78	24	31.96	176.72
T-TJ0G-844824-R	2147	29.5	84	24	34.42	185.8

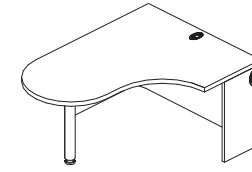

1" J-Table, LH Shown

How to Specify:

Each laminate comes with matching vinyl trim color unless otherwise specified on your purchase order. Refer to the laminate finish card for details.

Notes:

36"D D-tables include two post supports.

Options:

- laminate color

- grommet color

- metal color (for post support)

Code	Price	H	W	D	Volume (ft ³)	Weight (lb)
Left Hand						
TL-TJ0G-604824L	1621	29	60	24	24.17	120.67
TL-TJ0G-664824L	1739	29	66	24	26.58	127.15
TL-TJ0G-724824L	1833	29	72	24	29	133.63
TL-TJ0G-784824L	1937	29	78	24	31.42	140.11
TL-TJ0G-844824L	2031	29	84	24	33.83	146.59
Right Hand						
TL-TJ0G-604824R	1621	29	60	24	24.17	120.67
TL-TJ0G-664824R	1739	29	66	24	26.58	127.15
TL-TJ0G-724824R	1833	29	72	24	29	133.63
TL-TJ0G-784824R	1937	29	78	24	31.42	140.11
TL-TJ0G-844824R	2031	29	84	24	33.83	146.59

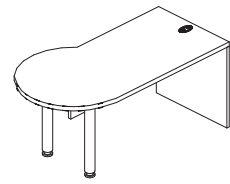

1.5" P-Table, LH Shown

How to Specify:

Each laminate comes with matching vinyl trim color unless otherwise specified on your purchase order. Refer to the laminate finish card for details.

Notes:

Options:

- laminate color

- edge profile

- grommet color

- metal color (for post support)

Code	Price	H	W	D	Volume (ft ³)	Weight (lb)
Left Hand						
T-TP0G-6030-L	1597	29.5	60	30	30.73	119.92
T-TP0G-6630-L	1671	29.5	66	30	33.8	128.78
T-TP0G-7230-L	1727	29.5	72	30	36.88	137.64
T-TP0G-7830-L	1796	29.5	78	30	39.95	146.5
T-TP0G-8430-L	1860	29.5	84	30	43.02	155.36
Right Hand						
T-TP0G-6030-R	1597	29.5	60	30	30.73	119.92
T-TP0G-6630-R	1671	29.5	66	30	33.8	128.78
T-TP0G-7230-R	1727	29.5	72	30	36.88	137.64
T-TP0G-7830-R	1796	29.5	78	30	39.95	146.5
T-TP0G-8430-R	1860	29.5	84	30	43.02	155.36

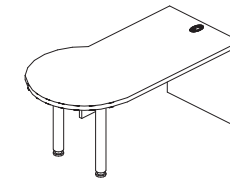

1" P-Table, LH Shown

How to Specify:

Each laminate comes with matching vinyl trim color unless otherwise specified on your purchase order. Refer to the laminate finish card for details.

Notes:

36"D D-tables include two post supports.

Options:

- laminate color

- grommet color

- metal color (for post support)

Code	Price	H	W	D	Volume (ft ³)	Weight (lb)
Left Hand						
TL-TP0G-6030-L	1485	29	60	30	30.21	96.51
TL-TP0G-6630-L	1559	29	66	30	33.23	103.34
TL-TP0G-7230-L	1613	29	72	30	36.25	110.17
TL-TP0G-7830-L	1683	29	78	30	39.27	117
TL-TP0G-8430-L	1746	29	84	30	42.29	123.83
Right Hand						
TL-TP0G-6030-R	1485	29	60	30	30.21	96.51
TL-TP0G-6630-R	1559	29	66	30	33.23	103.34
TL-TP0G-7230-R	1613	29	72	30	36.25	110.17
TL-TP0G-7830-R	1683	29	78	30	39.27	117
TL-TP0G-8430-R	1746	29	84	30	42.29	123.83

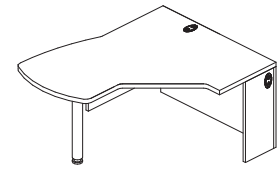

1.5" F-Table, LH Shown

How to Specify:

Each laminate comes with matching vinyl trim color unless otherwise specified on your purchase order. Refer to the laminate finish card for details.

Notes:

Options:

- laminate color

- edge profile

- grommet color

- metal color (for post support)

Code	Price	H	W	D	Volume (ft ³)	Weight (lb)
Left Hand						
T-TFSG-604824-L	2044	29.5	60	24	24.58	152.9
T-TFSG-664824-L	2087	29.5	66	24	27.04	161.05
T-TFSG-724824-L	2131	29.5	72	24	29.5	169.2
T-TFSG-784824-L	2171	29.5	78	24	31.96	177.35
T-TFSG-844824-L	2215	29.5	84	24	34.42	185.5
Right Hand						
T-TFSG-604824-R	2044	29.5	60	24	24.58	152.9
T-TFSG-664824-R	2087	29.5	66	24	27.04	161.05
T-TFSG-724824-R	2131	29.5	72	24	29.5	169.2
T-TFSG-784824-R	2171	29.5	78	24	31.96	177.35
T-TFSG-844824-R	2215	29.5	84	24	34.42	185.5

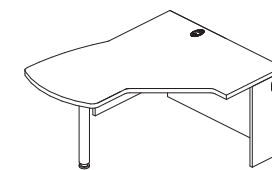

1" F-Table, LH Shown

How to Specify:

Each laminate comes with matching vinyl trim color unless otherwise specified on your purchase order. Refer to the laminate finish card for details.

Notes:

Options:

- laminate color

- grommet color

- metal color (for post support)

Code	Price	H	W	D	Volume (ft ³)	Weight (lb)
Left Hand						
TL-TFSG-604824L	1979	29	60	24	24.17	123.35
TL-TFSG-664824L	2012	29	66	24	26.58	129.35
TL-TFSG-724824L	2048	29	72	24	29	135.35
TL-TFSG-784824L	2083	29	78	24	31.42	141.35
TL-TFSG-844824L	2118	29	84	24	33.83	147.35
Right Hand						
TL-TFSG-604824R	1979	29	60	24	24.17	123.35
TL-TFSG-664824R	2012	29	66	24	26.58	129.35
TL-TFSG-724824R	2048	29	72	24	29	135.35
TL-TFSG-784824R	2083	29	78	24	31.42	141.35
TL-TFSG-844824R	2118	29	84	24	33.83	147.35

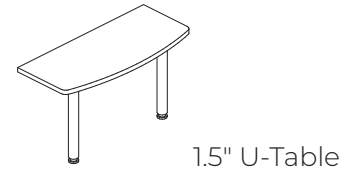

How to Specify:

Each laminate comes with matching vinyl trim color unless otherwise specified on your purchase order. Refer to the laminate finish card for details.

Notes:

Options:

- laminate color

- edge profile

- metal color (for post support)

Code	Price	H	W	D	Volume (ft ³)	Weight (lb)
T-WEU0-4224	976	29.5	42	24	17.21	51.19
T-WEU0-4824	1009	29.5	48	24	19.67	56.54
T-WEU0-6024	1190	29.5	60	24	24.58	61.88

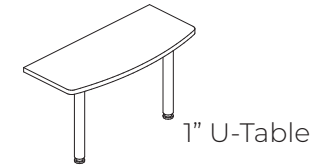

How to Specify:

Each laminate comes with matching vinyl trim color unless otherwise specified on your purchase order. Refer to the laminate finish card for details.

Notes:

Options:

- laminate color

- metal color (for post support)

Code	Price	H	W	D	Volume (ft ³)	Weight (lb)
TL-WEU0-4224	843	29	42	24	16.92	38.79
TL-WEU0-4824	876	29	48	24	19.33	42.36
TL-WEU0-6024	1057	29	60	24	24.17	45.92

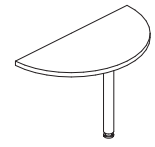

1.5" C-Table

How to Specify:

Each laminate comes with matching vinyl trim color unless otherwise specified on your purchase order. Refer to the laminate finish card for details.

Notes:

Options:

laminate color

edge profile

metal color (for post support)

Code	Price	H	W	D	Volume (ft ³)	Weight (lb)
T-TC00-4221	703	29.5	42	21	15.06	34
T-TC00-4824	809	29.5	48	24	19.67	42.1
T-TC00-6030	911	29.5	60	30	30.73	50

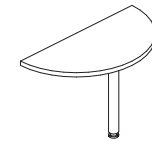

1" C-Table

How to Specify:

Each laminate comes with matching vinyl trim color unless otherwise specified on your purchase order. Refer to the laminate finish card for details.

Notes:

Options:

laminate color

metal color (for post support)

Code	Price	H	W	D	Volume (ft ³)	Weight (lb)
TL-TC00-4221	654	29	42	21	14.8	25
TL-TC00-4824	757	29	48	24	19.33	30.56
TL-TC00-6030	862	29	60	30	30.21	36.12



Metro Pricebook
October 2024
Corners

corners

Executive

straight front corner

<u>full modesty</u>	64
<u>partial modesty</u>	66
<u>full modesty no gables</u>	68

curved front corner

<u>full modesty</u>	70
<u>partial modesty</u>	72
<u>full modesty no gables</u>	74

Professional

straight front corner

<u>full modesty</u>	65
<u>partial modesty</u>	67
<u>full modesty no gables</u>	69

curved front corner

<u>full modesty</u>	71
<u>partial modesty</u>	73
<u>full modesty no gables</u>	75

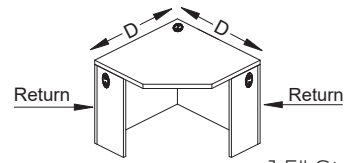

1.5" Straight Front Corner Worksurface
w/Full Modesties

How to Specify:

Each laminate comes with matching vinyl trim color unless otherwise specified on your purchase order. Refer to the laminate finish card for details.

Options:

laminate color

edge profile

grommet color

How to Order and Read your Code:

T or TL	W5S0	36	21
product line	item	depth	return size

Code	Price	H	D	Return	Volume (ft ³)	Weight (lb)
T-W5S0-3621	1082	29.5	36	21	12.91	114.3
T-W5S0-3624	1082	29.5	36	24	14.75	116.21
T-W5S0-4221	1274	29.5	42	21	15.06	137.24
T-W5S0-4224	1274	29.5	42	24	17.21	139.52

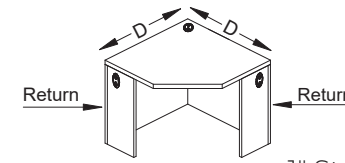

1" Straight Front Corner Worksurface
w/Full Modesties

How to Specify:

Each laminate comes with matching vinyl trim color unless otherwise specified on your purchase order. Refer to the laminate finish card for details.

Options:

laminate color

grommet color

Code	Price	H	D	Return	Volume (ft ³)	Weight (lb)
TL-W5S0-3621	1005	29	36	21	12.69	99.2
TL-W5S0-3624	1005	29	36	24	14.5	100.27
TL-W5S0-4221	1181	29	42	21	14.8	117.14
TL-W5S0-4224	1181	29	42	24	16.92	118.66

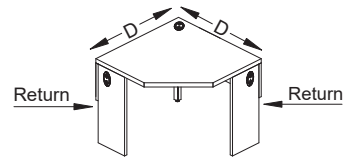

1.5" Straight Front Corner Worksurface
w/Partial Modesties and Post

How to Specify:

Each laminate comes with matching vinyl trim color unless otherwise specified on your purchase order. Refer to the laminate finish card for details.

Notes:

Partial modesties are 12"H.

Options:

- laminate color

- edge profile

- grommet color

- metal color (for post support)

Code	Price	H	D	Return	Volume (ft ³)	Weight (lb)
T-W5S0-3621-P	1082	29.5	36	21	12.91	84.74
T-W5S0-3624-P	1082	29.5	36	24	14.75	86.65
T-W5S0-4221-P	1274	29.5	42	21	15.06	102.88
T-W5S0-4224-P	1274	29.5	42	24	17.21	105.16

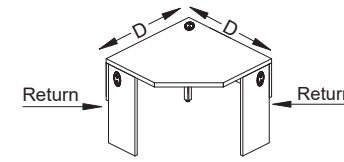

1" Straight Front Corner Worksurface
w/Partial Modesties and Post

How to Specify:

Each laminate comes with matching vinyl trim color unless otherwise specified on your purchase order. Refer to the laminate finish card for details.

Notes:

Partial modesties are 12"H.

Options:

- laminate color

- grommet color

- metal color (for post support)

Code	Price	H	D	Return	Volume (ft ³)	Weight (lb)
TL-W5S0-3621-P	1005	29	36	21	12.69	69.94
TL-W5S0-3624-P	1005	29	36	24	14.5	70.71
TL-W5S0-4221-P	1181	29	42	21	14.8	82.78
TL-W5S0-4224-P	1181	29	42	24	16.92	84.3

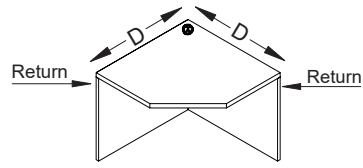

1.5" Straight Front Corner Worksurface
w/Full Modesties, No Gables

How to Specify:

Each laminate comes with matching vinyl trim color unless otherwise specified on your purchase order. Refer to the laminate finish card for details.

Options:

laminate color

edge profile

grommet color

Code	Price	H	D	Return	Volume (ft ³)	Weight (lb)
T-W5S0-3621-N	793	29.5	36	21	12.91	114.3
T-W5S0-3624-N	793	29.5	36	24	14.75	116.21
T-W5S0-4221-N	987	29.5	42	21	15.06	137.24
T-W5S0-4224-N	987	29.5	42	24	17.21	139.52

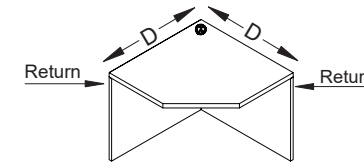

1" Straight Front Corner Worksurface
w/Full Modesties, No Gables

How to Specify:

Each laminate comes with matching vinyl trim color unless otherwise specified on your purchase order. Refer to the laminate finish card for details.

Options:

laminate color

grommet color

Code	Price	H	D	Return	Volume (ft ³)	Weight (lb)
TL-W5S0-3621-N	716	29.5	36	21	12.91	99.2
TL-W5S0-3624-N	716	29.5	36	24	14.75	100.27
TL-W5S0-4221-N	894	29.5	42	21	15.06	117.14
TL-W5S0-4224-N	894	29.5	42	24	17.21	118.66

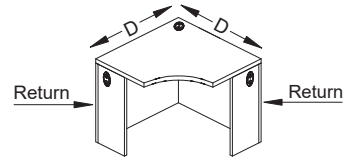

1.5" Curved Front Corner Worksurface
w/Full Modesties

How to Specify:

Each laminate comes with matching vinyl trim color unless otherwise specified on your purchase order. Refer to the laminate finish card for details.

Options:

laminare color

edge profile

grommet color

Code	Price	H	D	Return	Volume (ft ³)	Weight (lb)
T-W5C0-3621	1082	29.5	36	21	12.91	112.21
T-W5C0-3624	1082	29.5	36	24	14.75	114.6
T-W5C0-4221	1274	29.5	42	21	15.06	132.52
T-W5C0-4224	1274	29.5	42	24	17.21	136.12

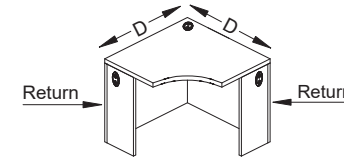

1" Curved Front Corner Worksurface
w/Full Modesties

How to Specify:

Each laminate comes with matching vinyl trim color unless otherwise specified on your purchase order. Refer to the laminate finish card for details.

Options:

laminare color

grommet color

Code	Price	H	D	Return	Volume (ft ³)	Weight (lb)
TL-W5C0-3621	1005	29	36	21	12.69	97.54
TL-W5C0-3624	1005	29	36	24	14.5	98.3
TL-W5C0-4221	1181	29	42	21	14.8	113.86
TL-W5C0-4224	1181	29	42	24	16.92	116.26

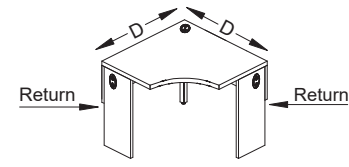

1.5" Curved Front Corner Worksurface
w/Partial Modesties and Post

How to Specify:

Each laminate comes with matching vinyl trim color unless otherwise specified on your purchase order. Refer to the laminate finish card for details.

Notes:

Partial modesties are 12"H.

Options:

laminate color

edge profile

grommet color

metal color (for post support)

Code	Price	H	D	Return	Volume (ft ³)	Weight (lb)
T-W5C0-3621-P	1082	29.5	36	21	12.91	82.62
T-W5C0-3624-P	1082	29.5	36	24	14.75	85.1
T-W5C0-4221-P	1274	29.5	42	21	15.06	94.27
T-W5C0-4224-P	1274	29.5	42	24	17.21	97.87

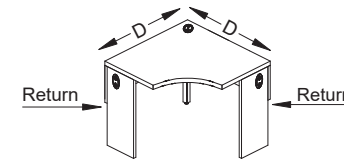

1" Curved Front Corner Worksurface
w/Partial Modesties and Post

How to Specify:

Each laminate comes with matching vinyl trim color unless otherwise specified on your purchase order. Refer to the laminate finish card for details.

Notes:

Partial modesties are 12"H.

Options:

laminate color

grommet color

metal color (for post support)

Code	Price	H	D	Return	Volume (ft ³)	Weight (lb)
TL-W5C0-3621-P	1005	29	36	21	12.69	67.98
TL-W5C0-3624-P	1005	29	36	24	14.5	68.74
TL-W5C0-4221-P	1181	29	42	21	14.8	75.61
TL-W5C0-4224-P	1181	29	42	24	16.92	78.01

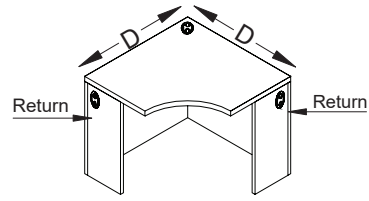

1.5" Curved Front Corner Worksurface
w/Full Modesties, No Gables

How to Specify:

Each laminate comes with matching vinyl trim color unless otherwise specified on your purchase order. Refer to the laminate finish card for details.

Options:

- laminates color _____
- edge profile _____
- grommet color _____

Code	Price	H	D	Return	Volume (ft ³)	Weight (lb)
T-W5C0-3621-N	793	29.5	36	21	12.91	112.21
T-W5C0-3624-N	793	29.5	36	24	14.75	114.6
T-W5C0-4221-N	987	29.5	42	21	15.06	132.52
T-W5C0-4224-N	987	29.5	42	24	17.21	136.12

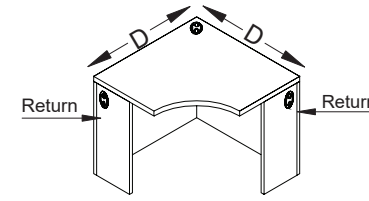

1" Curved Corner Worksurface
w/Full Modesties, No Gables

How to Specify:

Each laminate comes with matching vinyl trim color unless otherwise specified on your purchase order. Refer to the laminate finish card for details.

Options:

- laminates color _____
- grommet color _____

Code	Price	H	D	Return	Volume (ft ³)	Weight (lb)
TL-W5C0-3621-N	716	29.5	36	21	12.91	97.54
TL-W5C0-3624-N	716	29.5	36	24	14.75	98.3
TL-W5C0-4221-N	894	29.5	42	21	15.06	113.66
TL-W5C0-4224-N	894	29.5	42	24	17.21	116.26



Metro Pricebook
October 2024
Unitized Desks

unitized desks

Executive

<u>w/full modesties, full and partial gables</u>	78
<u>w/full modesties, no gables</u>	80
<u>w/partial modesty</u>	82

Professional

<u>w/full modesties, full and partial gables</u>	79
<u>w/full modesties, no gables</u>	81
<u>w/ partial modesties</u>	83

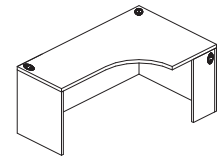

1.5" Curved Front Unitized Desk w/Full Modesties, Full and Partial Gables, LH Shown

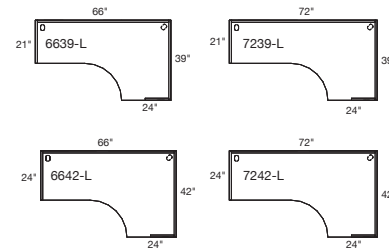

How to Specify:

Each laminate comes with matching vinyl trim color unless otherwise specified on your purchase order. Refer to the laminate finish card for details.

Notes:

Options:

- laminate color

- edge profile

- grommet color

Code	Price	H	W	D	Volume (ft ³)	Weight (lb)
T-UC4G-6639-L	1668	29.5	66	39	43.94	146.65
T-UC4G-7239-L	1777	29.5	72	39	47.94	181.17
T-UC4G-6639-R	1668	29.5	66	39	43.94	146.65
T-UC4G-7239-R	1777	29.5	72	39	47.94	181.17
T-UC4G-6642-L	1738	29.5	66	42	47.32	184.39
T-UC4G-7242-L	2083	29.5	72	42	51.63	194.16
T-UC4G-6642-R	1738	29.5	66	42	47.32	184.39
T-UC4G-7242-R	2083	29.5	72	42	51.63	194.16

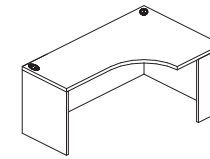

1" Curved Front Unitized Desk w/Full Modesties, Full and Partial Gables, LH Shown

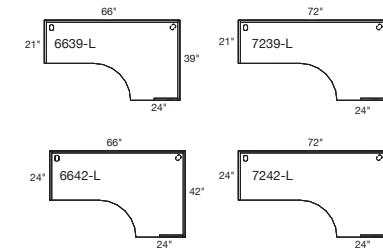

How to Specify:

Each laminate comes with matching vinyl trim color unless otherwise specified on your purchase order. Refer to the laminate finish card for details.

Notes:

Options:

- laminate color

- grommet color

Code	Price	H	W	D	Volume (ft ³)	Weight (lb)
TL-UC4G-6639-L	1547	29	66	39	43.2	120.6
TL-UC4G-7239-L	1645	29	72	39	47.13	153.9
TL-UC4G-6639-R	1547	29	66	39	43.2	120.6
TL-UC4G-7239-R	1645	29	72	39	47.13	153.9
TL-UC4G-6642-L	1610	29	66	42	46.52	161.1
TL-UC4G-7242-L	1931	29	72	42	50.75	170.55
TL-UC4G-6642-R	1610	29	66	42	46.52	161.1
TL-UC4G-7242-R	1931	29	72	42	50.75	170.55

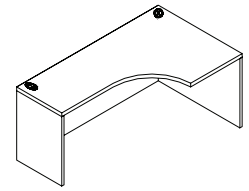

1.5" Curved Front Unitized Desk
w/Full Modesties, No Gables
LH Shown

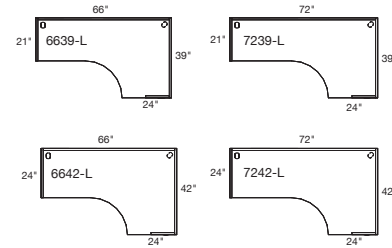

How to Specify:

Each laminate comes with matching vinyl trim color unless otherwise specified on your purchase order. Refer to the laminate finish card for details.

Notes:

Options:

- laminate color

- edge profile

- grommet color

Code	Price	H	W	D	Volume (ft ³)	Weight (lb)
T-UC4G-6639-L-N	1526	29.5	66	39	43.94	146.65
T-UC4G-7239-L-N	1636	29.5	72	39	47.94	181.17
T-UC4G-6639-R-N	1526	29.5	66	39	43.94	146.65
T-UC4G-7239-R-N	1636	29.5	72	39	47.94	181.17
T-UC4G-6642-L-N	1592	29.5	66	42	47.32	184.39
T-UC4G-7242-L-N	1938	29.5	72	42	51.63	194.16
T-UC4G-6642-R-N	1592	29.5	66	42	47.32	184.39
T-UC4G-7242-R-N	1938	29.5	72	42	51.63	194.16

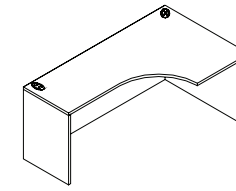

1" Curved Front Unitized Desk
w/Full Modesties, No Gables
LH Shown

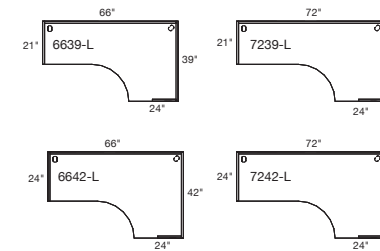

How to Specify:

Each laminate comes with matching vinyl trim color unless otherwise specified on your purchase order. Refer to the laminate finish card for details.

Notes:

Options:

- laminate color

- grommet color

Code	Price	H	W	D	Volume (ft ³)	Weight (lb)
TL-UC4G-6639-L-N	1402	29.5	66	39	43.94	120.6
TL-UC4G-7239-L-N	1502	29.5	72	39	47.94	153.9
TL-UC4G-6639-R-N	1402	29.5	66	39	43.94	120.6
TL-UC4G-7239-R-N	1502	29.5	72	39	47.94	153.9
TL-UC4G-6642-L-N	1462	29.5	66	42	47.32	161.1
TL-UC4G-7242-L-N	1783	29.5	72	42	51.63	170.55
TL-UC4G-6642-R-N	1462	29.5	66	42	47.32	161.1
TL-UC4G-7242-R-N	1783	29.5	72	42	51.63	170.55

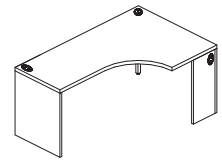

1.5" Curved Front Unitized Desk w/Partial Modesties, Full and Partial Gables, LH Shown

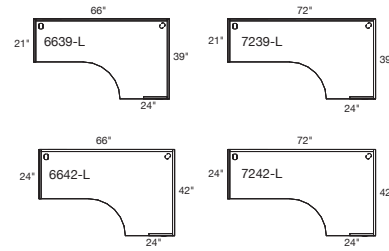

How to Specify:

Each laminate comes with matching vinyl trim color unless otherwise specified on your purchase order. Refer to the laminate finish card for details.

Notes:

Partial modesties are 12"H.

Options:

- laminate color

- edge profile

- grommet color

- metal color (for post support)

Code	Price	H	W	D	Volume (ft ³)	Weight (lb)
T-UC4Z-6639-L	1668	29.5	66	39	43.94	104.04
T-UC4Z-7239-L	1777	29.5	72	39	47.94	110.22
T-UC4Z-6639-R	1668	29.5	66	39	43.94	104.04
T-UC4Z-7239-R	1777	29.5	72	39	47.94	110.22
T-UC4Z-6642-L	1738	29.5	66	42	47.32	137.95
T-UC4Z-7242-L	2083	29.5	72	42	51.63	149.72
T-UC4Z-6642-R	1738	29.5	66	42	47.32	137.95
T-UC4Z-7242-R	2083	29.5	72	42	51.63	149.72

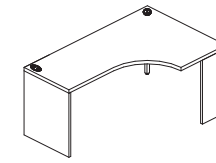

1" Curved Front Unitized Desk w/Partial Modesties, Full and Partial Gables, LH Shown

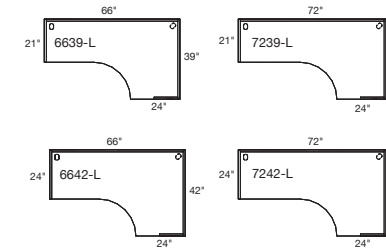

How to Specify:

Each laminate comes with matching vinyl trim color unless otherwise specified on your purchase order. Refer to the laminate finish card for details.

Notes:

Partial modesties are 12"H.

Options:

- laminate color

- grommet color

- metal color (for post support)

Code	Price	H	W	D	Volume (ft ³)	Weight (lb)
TL-UC4Z-6639-L	1547	29	66	39	43.2	99.79
TL-UC4Z-7239-L	1645	29	72	39	47.13	108.77
TL-UC4Z-6639-R	1547	29	66	39	43.2	99.79
TL-UC4Z-7239-R	1645	29	72	39	47.13	108.77
TL-UC4Z-6642-L	1610	29	66	42	46.52	114.66
TL-UC4Z-7242-L	1931	29	72	42	50.75	126.11
TL-UC4Z-6642-R	1610	29	66	42	46.52	114.66
TL-UC4Z-7242-R	1931	29	72	42	50.75	126.11



Metro Pricebook
October 2024
Bridges

bridges

Executive

bowed bridge

full modesty 86

partial modesty 88

Professional

bowed bridge

full modesty 87

partial modesty 89

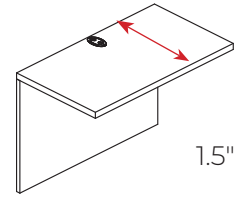

1.5" Straight Bridge w/Full Modesty

How to Specify:

Each laminate comes with matching vinyl trim color unless otherwise specified on your purchase order. Refer to the laminate finish card for details.

Notes:

Options:

laminate color

edge profile

grommet color

Code	Price	H	W	D	Volume (ft ³)	Weight (lb)
T-BS0G-3021	502	29.5	30	21	10.76	46.17
T-BS0G-3621	541	29.5	36	21	12.91	55.5
T-BS0G-4221	603	29.5	42	21	15.06	64.83
T-BS0G-4821	641	29.5	48	21	17.21	74.16
T-BS0G-3024	525	29.5	30	24	12.29	49.5
T-BS0G-3624	564	29.5	36	24	14.75	60
T-BS0G-4224	625	29.5	42	24	17.21	70.5
T-BS0G-4824	703	29.5	48	24	19.67	81

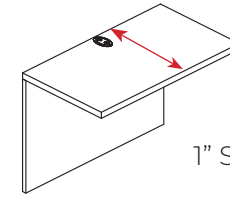

1" Straight Bridge w/Full Modesty

How to Specify:

Each laminate comes with matching vinyl trim color unless otherwise specified on your purchase order. Refer to the laminate finish card for details.

Notes:

Options:

laminate color

grommet color

Code	Price	H	W	D	Volume (ft ³)	Weight (lb)
TL-BS0G-3021	474	29	30	21	10.57	38
TL-BS0G-3621	511	29	36	21	12.69	45.78
TL-BS0G-4221	568	29	42	21	14.8	53.56
TL-BS0G-4821	607	29	48	21	16.92	61.34
TL-BS0G-3024	496	29	30	24	12.08	40.35
TL-BS0G-3624	531	29	36	24	14.5	48.6
TL-BS0G-4224	586	29	42	24	16.92	56.85
TL-BS0G-4824	665	29	48	24	19.33	65.1

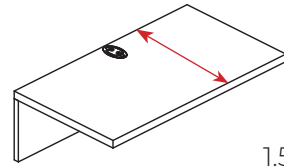

1.5" Straight Bridge w/Partial Modesty

How to Specify:

Each laminate comes with matching vinyl trim color unless otherwise specified on your purchase order. Refer to the laminate finish card for details.

Notes:

Partial modesties are 12"H.

Options:

laminate color

edge profile

grommet color

Code	Price	H	W	D	Volume (ft ³)	Weight (lb)
T-BS0Z-3021	502	29.5	30	21	10.76	33.67
T-BS0Z-3621	541	29.5	36	21	12.91	43
T-BS0Z-4221	603	29.5	42	21	15.06	52.33
T-BS0Z-4821	641	29.5	48	21	17.21	61.66
T-BS0Z-3024	525	29.5	30	24	12.29	33.3
T-BS0Z-3624	564	29.5	36	24	14.75	43.8
T-BS0Z-4224	625	29.5	42	24	17.21	54.3
T-BS0Z-4824	703	29.5	48	24	19.67	64.8

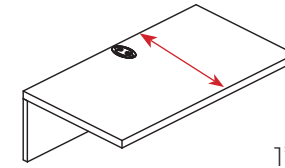

1" Straight Bridge w/Partial Modesty

How to Specify:

Each laminate comes with matching vinyl trim color unless otherwise specified on your purchase order. Refer to the laminate finish card for details.

Notes:

Partial modesties are 12"H.

Options:

laminate color

grommet color

Code	Price	H	W	D	Volume (ft ³)	Weight (lb)
TL-BS0Z-3021	474	29	30	21	10.57	25.4
TL-BS0Z-3621	511	29	36	21	12.69	33.18
TL-BS0Z-4221	568	29	42	21	14.8	40.96
TL-BS0Z-4821	607	29	48	21	16.92	48.74
TL-BS0Z-3024	496	29	30	24	12.08	27.75
TL-BS0Z-3624	531	29	36	24	14.5	36
TL-BS0Z-4224	586	29	42	24	16.92	44.25
TL-BS0Z-4824	665	29	48	24	19.33	52.5



Metro Pricebook
October 2024
Returns

returns

Executive

straight return full modesty 92

straight return partial modesty 96

Professional

straight return full modesty 94

straight return partial modesty 98

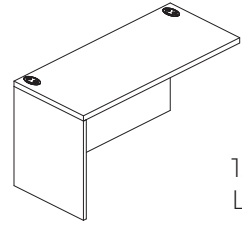

1.5" Straight Return w/Full Modesty, LH Shown

How to Specify:

Each laminate comes with matching vinyl trim color unless otherwise specified on your purchase order. Refer to the laminate finish card for details.

Notes:

1 grommet for width 48" or less
2 grommets for width 54" and wider

Options:

laminate color

edge profile

grommet color

Code	Price	H	W	D	Volume (ft ³)	Weight (lb)
T-WS1G-2421-L	736	29.5	24	21	8.6	51.3
T-WS1G-3021-L	745	29.5	30	21	10.76	60.74
T-WS1G-3621-L	756	29.5	36	21	12.91	70.18
T-WS1G-4221-L	770	29.5	42	21	15.06	79.62
T-WS1G-4821-L	811	29.5	48	21	17.21	89.06
T-WS1G-5421-L	851	29.5	54	21	19.36	98.5
T-WS1G-6021-L	897	29.5	60	21	21.51	107.94
T-WS1G-2421-R	736	29.5	24	21	8.6	51.3
T-WS1G-3021-R	745	29.5	30	21	10.76	60.74
T-WS1G-3621-R	756	29.5	36	21	12.91	70.18
T-WS1G-4221-R	770	29.5	42	21	15.06	79.62
T-WS1G-4821-R	811	29.5	48	21	17.21	89.06
T-WS1G-5421-R	851	29.5	54	21	19.36	98.5
T-WS1G-6021-R	897	29.5	60	21	21.51	107.94
T-WS1G-2424-L	745	29.5	24	24	9.83	56.65
T-WS1G-3024-L	756	29.5	30	24	12.29	65.92
T-WS1G-3624-L	770	29.5	36	24	14.75	75.19
T-WS1G-4224-L	790	29.5	42	24	17.21	84.46
T-WS1G-4824-L	831	29.5	48	24	19.67	93.73
T-WS1G-5424-L	872	29.5	54	24	22.13	103
T-WS1G-6024-L	918	29.5	60	24	24.58	112.27
T-WS1G-2424-R	745	29.5	24	24	9.83	56.65
T-WS1G-3024-R	756	29.5	30	24	12.29	65.92
T-WS1G-3624-R	770	29.5	36	24	14.75	75.19
T-WS1G-4224-R	790	29.5	42	24	17.21	84.46
T-WS1G-4824-R	831	29.5	48	24	19.67	93.73
T-WS1G-5424-R	872	29.5	54	24	22.13	103
T-WS1G-6024-R	918	29.5	60	24	24.58	112.27
T-WS1G-2430-L	811	29.5	24	30	12.29	66.42
T-WS1G-3030-L	831	29.5	30	30	15.36	77.42
T-WS1G-3630-L	862	29.5	36	30	18.44	88.42
T-WS1G-4230-L	897	29.5	42	30	21.51	99.42
T-WS1G-4830-L	925	29.5	48	30	24.58	110.42
T-WS1G-5430-L	957	29.5	54	30	27.66	121.42
T-WS1G-6030-L	1011	29.5	60	30	30.73	132.42
T-WS1G-2430-R	811	29.5	24	30	12.29	66.42
T-WS1G-3030-R	831	29.5	30	30	15.36	77.42
T-WS1G-3630-R	862	29.5	36	30	18.44	88.42
T-WS1G-4230-R	897	29.5	42	30	21.51	99.42
T-WS1G-4830-R	925	29.5	48	30	24.58	110.42
T-WS1G-5430-R	957	29.5	54	30	27.66	121.42
T-WS1G-6030-R	1011	29.5	60	30	30.73	132.42

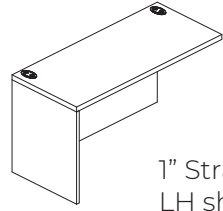

1" Straight return w/Full Modesty
LH shown

How to Specify:

Each laminate comes with matching vinyl trim color unless otherwise specified on your purchase order. Refer to the laminate finish card for details.

Notes:

1 grommet for width 48" or less
2 grommets for width 54" and wider

Options:

laminate color

grommet color

Code	Price	H	W	D	Volume (ft ³)	Weight (lb)
TL-WS1G-2421-L	603	29	24	21	8.46	45
TL-WS1G-3021-L	613	29	30	21	10.57	52.4
TL-WS1G-3621-L	625	29	36	21	12.69	59.8
TL-WS1G-4221-L	633	29	42	21	14.8	67.2
TL-WS1G-4821-L	676	29	48	21	16.92	74.6
TL-WS1G-5421-L	719	29	54	21	19.03	82
TL-WS1G-6021-L	759	29	60	21	21.15	89.4
TL-WS1G-2421-R	603	29	24	21	8.46	45
TL-WS1G-3021-R	613	29	30	21	10.57	52.4
TL-WS1G-3621-R	625	29	36	21	12.69	59.8
TL-WS1G-4221-R	633	29	42	21	14.8	67.2
TL-WS1G-4821-R	676	29	48	21	16.92	74.6
TL-WS1G-5421-R	719	29	54	21	19.03	82
TL-WS1G-6021-R	759	29	60	21	21.15	89.4
TL-WS1G-2424-L	613	29	24	24	9.67	48.75
TL-WS1G-3024-L	625	29	30	24	12.08	56.55
TL-WS1G-3624-L	633	29	36	24	14.5	64.35
TL-WS1G-4224-L	655	29	42	24	16.92	72.15
TL-WS1G-4824-L	696	29	48	24	19.33	79.95
TL-WS1G-5424-L	741	29	54	24	21.75	87.75
TL-WS1G-6024-L	783	29	60	24	24.17	95.55
TL-WS1G-2424-R	613	29	24	24	9.67	48.75
TL-WS1G-3024-R	625	29	30	24	12.08	56.55
TL-WS1G-3624-R	633	29	36	24	14.5	64.35
TL-WS1G-4224-R	655	29	42	24	16.92	72.15
TL-WS1G-4824-R	696	29	48	24	19.33	79.95
TL-WS1G-5424-R	741	29	54	24	21.75	87.75
TL-WS1G-6024-R	783	29	60	24	24.17	95.55
TL-WS1G-2430-L	676	29	24	30	12.08	56.7
TL-WS1G-3030-L	696	29	30	30	15.1	65.73
TL-WS1G-3630-L	730	29	36	30	18.13	74.76
TL-WS1G-4230-L	759	29	42	30	21.15	83.79
TL-WS1G-4830-L	793	29	48	30	24.17	92.82
TL-WS1G-5430-L	828	29	54	30	27.19	101.85
TL-WS1G-6030-L	881	29	60	30	30.21	110.88
TL-WS1G-2430-R	676	29	24	30	12.08	56.7
TL-WS1G-3030-R	696	29	30	30	15.1	65.73
TL-WS1G-3630-R	730	29	36	30	18.13	74.76
TL-WS1G-4230-R	759	29	42	30	21.15	83.79
TL-WS1G-4830-R	793	29	48	30	24.17	92.82
TL-WS1G-5430-R	828	29	54	30	27.19	101.85
TL-WS1G-6030-R	881	29	60	30	30.21	110.88

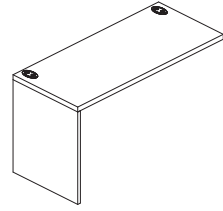

1.5" Straight Return w/Partial Modesty, LH Shown

How to Specify:

Each laminate comes with matching vinyl trim color unless otherwise specified on your purchase order. Refer to the laminate finish card for details.

Notes:

Partial modesties are 12"H
 1 grommet for width 48" or less
 2 grommets for width 54" and wider

Options:

laminate color

edge profile

grommet color

Code	Price	H	W	D	Volume (ft ³)	Weight (lb)
T-WS1Z-2421-L	736	29.5	24	21	8.6	41.4
T-WS1Z-3021-L	745	29.5	30	21	10.76	48.66
T-WS1Z-3621-L	756	29.5	36	21	12.91	58.1
T-WS1Z-4221-L	770	29.5	42	21	15.06	67.54
T-WS1Z-4821-L	811	29.5	48	21	17.21	76.98
T-WS1Z-5421-L	851	29.5	54	21	19.36	86.42
T-WS1Z-6021-L	897	29.5	60	21	21.51	95.86
T-WS1Z-2421-R	736	29.5	24	21	8.6	41.4
T-WS1Z-3021-R	745	29.5	30	21	10.76	48.66
T-WS1Z-3621-R	756	29.5	36	21	12.91	58.1
T-WS1Z-4221-R	770	29.5	42	21	15.06	67.54
T-WS1Z-4821-R	811	29.5	48	21	17.21	76.98
T-WS1Z-5421-R	851	29.5	54	21	19.36	86.42
T-WS1Z-6021-R	897	29.5	60	21	21.51	95.86
T-WS1Z-2424-L	745	29.5	24	24	9.83	46.35
T-WS1Z-3024-L	756	29.5	30	24	12.29	55.62
T-WS1Z-3624-L	770	29.5	36	24	14.75	64.89
T-WS1Z-4224-L	790	29.5	42	24	17.21	74.16
T-WS1Z-4824-L	831	29.5	48	24	19.67	83.43
T-WS1Z-5424-L	872	29.5	54	24	22.13	92.7
T-WS1Z-6024-L	918	29.5	60	24	24.58	101.97
T-WS1Z-2424-R	745	29.5	24	24	9.83	46.35
T-WS1Z-3024-R	756	29.5	30	24	12.29	55.62
T-WS1Z-3624-R	770	29.5	36	24	14.75	64.89
T-WS1Z-4224-R	790	29.5	42	24	17.21	74.16
T-WS1Z-4824-R	831	29.5	48	24	19.67	83.43
T-WS1Z-5424-R	872	29.5	54	24	22.13	92.7
T-WS1Z-6024-R	918	29.5	60	24	24.58	101.97
T-WS1Z-2430-L	811	29.5	24	30	12.29	58.5
T-WS1Z-3030-L	831	29.5	30	30	15.36	69.5
T-WS1Z-3630-L	862	29.5	36	30	18.44	80.5
T-WS1Z-4230-L	897	29.5	42	30	21.51	91.5
T-WS1Z-4830-L	925	29.5	48	30	24.58	102.5
T-WS1Z-5430-L	957	29.5	54	30	27.66	113.5
T-WS1Z-6030-L	1011	29.5	60	30	30.73	124.5
T-WS1Z-2430-R	811	29.5	24	30	12.29	58.5
T-WS1Z-3030-R	831	29.5	30	30	15.36	69.5
T-WS1Z-3630-R	862	29.5	36	30	18.44	80.5
T-WS1Z-4230-R	897	29.5	42	30	21.51	91.5
T-WS1Z-4830-R	925	29.5	48	30	24.58	102.5
T-WS1Z-5430-R	957	29.5	54	30	27.66	113.5
T-WS1Z-6030-R	1011	29.5	60	30	30.73	124.5

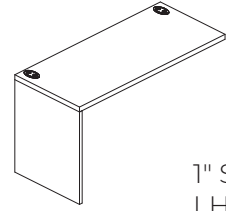

1" Straight Return w/partial Modesty, LH Shown

How to Specify:

Each laminate comes with matching vinyl trim color unless otherwise specified on your purchase order. Refer to the laminate finish card for details.

Notes:

Partial modesties are 12"H
 1 grommet for width 48" or less
 2 grommets for width 54" and wider

Options:

laminate color

grommet color

Code	Price	H	W	D	Volume (ft ³)	Weight (lb)
TL-WS1Z-2421-L	603	29	24	21	8.46	35.1
TL-WS1Z-3021-L	613	29	30	21	10.57	42.5
TL-WS1Z-3621-L	625	29	36	21	12.69	49.9
TL-WS1Z-4221-L	633	29	42	21	14.8	57.3
TL-WS1Z-4821-L	676	29	48	21	16.92	64.7
TL-WS1Z-5421-L	719	29	54	21	19.03	72.1
TL-WS1Z-6021-L	759	29	60	21	21.15	79.5
TL-WS1Z-2421-R	603	29	24	21	8.46	35.1
TL-WS1Z-3021-R	613	29	30	21	10.57	42.5
TL-WS1Z-3621-R	625	29	36	21	12.69	49.9
TL-WS1Z-4221-R	633	29	42	21	14.8	57.3
TL-WS1Z-4821-R	676	29	48	21	16.92	64.7
TL-WS1Z-5421-R	719	29	54	21	19.03	72.1
TL-WS1Z-6021-R	759	29	60	21	21.15	79.5
TL-WS1Z-2424-L	613	29	24	24	9.67	36.9
TL-WS1Z-3024-L	625	29	30	24	12.08	44.7
TL-WS1Z-3624-L	633	29	36	24	14.5	52.5
TL-WS1Z-4224-L	655	29	42	24	16.92	60.3
TL-WS1Z-4824-L	696	29	48	24	19.33	68.1
TL-WS1Z-5424-L	741	29	54	24	21.75	75.9
TL-WS1Z-6024-L	783	29	60	24	24.17	83.7
TL-WS1Z-2424-R	613	29	24	24	9.67	36.9
TL-WS1Z-3024-R	625	29	30	24	12.08	44.7
TL-WS1Z-3624-R	633	29	36	24	14.5	52.5
TL-WS1Z-4224-R	655	29	42	24	16.92	60.3
TL-WS1Z-4824-R	696	29	48	24	19.33	68.1
TL-WS1Z-5424-R	741	29	54	24	21.75	75.9
TL-WS1Z-6024-R	783	29	60	24	24.17	83.7
TL-WS1Z-2430-L	676	29	24	30	12.08	49.35
TL-WS1Z-3030-L	696	29	30	30	15.1	58.38
TL-WS1Z-3630-L	730	29	36	30	18.13	67.41
TL-WS1Z-4230-L	759	29	42	30	21.15	76.44
TL-WS1Z-4830-L	793	29	48	30	24.17	85.47
TL-WS1Z-5430-L	828	29	54	30	27.19	94.5
TL-WS1Z-6030-L	881	29	60	30	30.21	103.53
TL-WS1Z-2430-R	676	29	24	30	12.08	49.35
TL-WS1Z-3030-R	696	29	30	30	15.1	58.38
TL-WS1Z-3630-R	730	29	36	30	18.13	67.41
TL-WS1Z-4230-R	759	29	42	30	21.15	76.44
TL-WS1Z-4830-R	793	29	48	30	24.17	85.47
TL-WS1Z-5430-R	828	29	54	30	27.19	94.5
TL-WS1Z-6030-R	881	29	60	30	30.21	103.53



Metro Pricebook
October 2024
Credenzas

credenzas

Executive

<u>double lateral file</u>	102
<u>double storage cabinet</u>	104
<u>lateral file and storage cabinet</u>	106
<u>lateral file and storage cabinet</u>	108
<u>tops</u>	110

Professional

<u>double lateral file</u>	103
<u>double storage cabinet</u>	105
<u>lateral file and storage cabinet</u>	107
<u>lateral file and storage cabinet</u>	109
<u>tops</u>	111
<u>open w door</u>	112

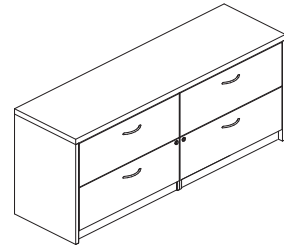

1.5" Credenza w/Double Lateral Files

How to Specify:

Each laminate comes with matching vinyl trim color unless otherwise specified on your purchase order. Refer to the laminate finish card for details.

Notes:

Options:

laminate color

edge profile

handle color

handle style

Code	Price	H	W	D	Volume (ft ³)	Weight (lb)
T-CRLL-7221	2650	29.5	72	21	25.81	232.65
T-CRLL-7224	2813	29.5	72	24	29.5	250.64

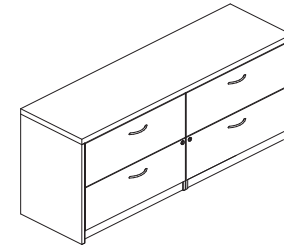

1" Credenza w/Double Lateral Files

How to Specify:

Each laminate comes with matching vinyl trim color unless otherwise specified on your purchase order. Refer to the laminate finish card for details.

Notes:

Options:

laminate color

handle color

handle style

Code	Price	H	W	D	Volume (ft ³)	Weight (lb)
TL-CRLL-7221	2502	29	72	21	25.38	205.87
TL-CRLL-7224	2651	29	72	24	29	220

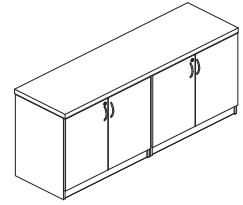

1.5" Credenza w/Double Storage Cabinets

How to Specify:

Each laminate comes with matching vinyl trim color unless otherwise specified on your purchase order. Refer to the laminate finish card for details.

Notes:

Cabinets and laterals include locks and keys.

Options:

laminate color

edge profile

handle color

handle style

Code	Price	H	W	D	Volume (ft ³)	Weight (lb)
T-CRSS-7221	2068	29.5	72	21	25.81	267
T-CRSS-7224	2210	29.5	72	24	29.5	272

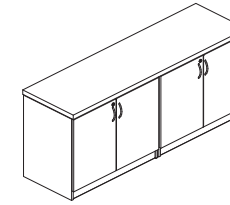

1" Credenza w/Double Storage Cabinets

How to Specify:

Each laminate comes with matching vinyl trim color unless otherwise specified on your purchase order. Refer to the laminate finish card for details.

Notes:

Cabinets and laterals include locks and keys.

Options:

laminate color

handle color

handle style

Code	Price	H	W	D	Volume (ft ³)	Weight (lb)
TL-CRSS-7221	1951	29	72	21	25.38	225.45
TL-CRSS-7224	2086	29	72	24	29	236.26

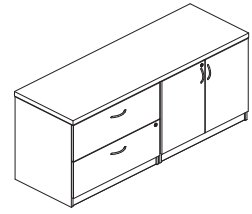

1.5" Credenza w/Lateral File on Left-Hand Side, Storage Cabinet on Right-Hand Side

How to Specify:

Each laminate comes with matching vinyl trim color unless otherwise specified on your purchase order. Refer to the laminate finish card for details.

Notes:

Cabinets and laterals include locks and keys.

Options:

laminate color

edge profile

handle color

handle style

Code	Price	H	W	D	Volume (ft ³)	Weight (lb)
T-CRLS-7221	2389	29.5	72	21	25.81	229.05
T-CRLS-7224	2590	29.5	72	24	29.5	247.04

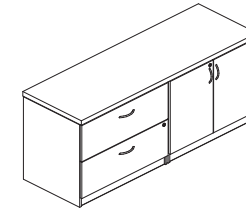

1" Credenza w/Lateral File on Left-Hand Side, Storage Cabinet on Right-Hand Side

How to Specify:

Each laminate comes with matching vinyl trim color unless otherwise specified on your purchase order. Refer to the laminate finish card for details.

Notes:

Cabinets and laterals include locks and keys.

Options:

laminate color

handle color

handle style

Code	Price	H	W	D	Volume (ft ³)	Weight (lb)
TL-CRLS-7221	2257	29	72	21	25.38	211.03
TL-CRLS-7224	2440	29	72	24	29	222.74

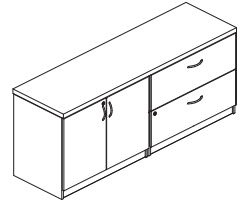

1.5" Credenza w/Storage Cabinet on Left-Hand Side, Lateral File on Right-Hand Side

How to Specify:

Each laminate comes with matching vinyl trim color unless otherwise specified on your purchase order. Refer to the laminate finish card for details.

Notes:

Cabinets and laterals include locks and keys.

Options:

laminate color

edge profile

handle color

handle style

Code	Price	H	W	D	Volume (ft ³)	Weight (lb)
T-CRSL-7221	2389	29.5	72	21	25.81	229.05
T-CRSL-7224	2590	29.5	72	24	29.5	247.04

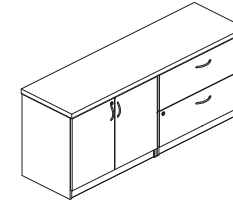

1" Credenza w/Storage Cabinet on Left-Hand Side, Lateral File on Right-Hand Side

How to Specify:

Each laminate comes with matching vinyl trim color unless otherwise specified on your purchase order. Refer to the laminate finish card for details.

Notes:

Cabinets and laterals include locks and keys.

Options:

laminate color

handle color

handle style

Code	Price	H	W	D	Volume (ft ³)	Weight (lb)
TL-CRSL-7221	2257	29	72	21	25.38	211.03
TL-CRSL-7224	2440	29	72	24	29	222.74

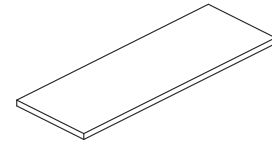

1.5" Credenza Top

How to Specify:

Each laminate comes with matching vinyl trim color unless otherwise specified on your purchase order. Refer to the laminate finish card for details.

Notes:

Options:

laminate color

edge profile

handle color

handle style

Code	Price	H	W	D	Volume (ft ³)	Weight (lb)
T-WSS0-6021	427	1.5	60	21	1.09	49.21
T-WSS0-6621	470	1.5	66	21	1.2	54.14
T-WSS0-7221	492	1.5	72	21	1.31	59.07
T-WSS0-7821	533	1.5	78	21	1.42	64
T-WSS0-8421	575	1.5	84	21	1.53	68.93

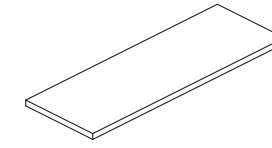

1" Credenza Top

How to Specify:

Each laminate comes with matching vinyl trim color unless otherwise specified on your purchase order. Refer to the laminate finish card for details.

Notes:

Options:

laminate color

handle color

handle style

Code	Price	H	W	D	Volume (ft ³)	Weight (lb)
TL-WSS0-6021	382	1	60	21	0.73	32.81
TL-WSS0-6621	419	1	66	21	0.8	36.09
TL-WSS0-7221	439	1	72	21	0.88	39.37
TL-WSS0-7821	475	1	78	21	0.95	42.65
TL-WSS0-8421	512	1	84	21	1.02	45.93

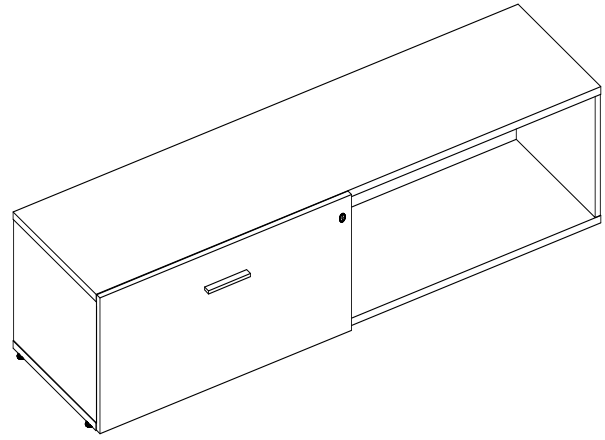

How to Specify:

Each laminate comes with matching vinyl trim color unless otherwise specified on your purchase order. Refer to the laminate finish card for details.

Notes:

Cabinets and laterals include locks and keys.

Options:

laminate color

edge profile

handle color

handle style

Code	Price	H	W	D	Volume (ft ³)	Weight (lb)
U-CRCL-157218-L	1975	14.19	72	19.13	93.91	11.31
U-CRCL-157218-R	1975	14.19	72	19.13	93.91	11.31



Metro Pricebook
October 2024
Supports

supports

Executive & Professional

<u>intermediate support</u>	116
<u>cantilever</u>	117
<u>reinforcement bar</u>	118



Intermediate Gable Support

How to Specify:

Each laminate comes with matching vinyl trim color unless otherwise specified on your purchase order. Refer to the laminate finish card for details.

Notes:

Options:

- laminate color

- grommet color

Code	Price	H	W	D	Volume (ft ³)	Weight (lb)
T-CGU0-12	201	28	12	1	0.19	8.75
T-CGU0-18	214	28	18	1	0.29	13.12

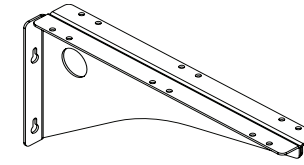

Center Cantilever Support

How to Specify:

Cantilevers are used to join 2 desks w/full modesty. Intermediate gable is required instead of cantilever when hatch sits on top of a desk.

Notes:

Options:

- cantilever available in black only

Code	Price	H	W	D	Volume (ft ³)	Weight (lb)
K-CCAB-16	105	0	16	0	3	0.1
K-CCAB-22	113	0	22	0	3	0.1

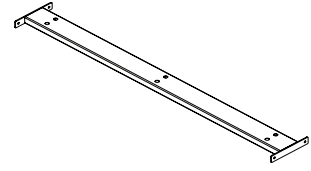

Reinforcement Bar

How to Specify:

Options:

metal support color

Code	Price	H	W	D	Volume (ft ³)	Weight (lb)
U-HRB0-27	191	1	27	6	0.2	2.5
U-HRB0-30	196	1	30	6	0.24	2.25
U-HRB0-33	201	1	33	6	0.28	2.5
U-HRB0-36	207	1	36	6	0.32	2.75
U-HRB0-39	210	1	39	6	0.36	3
U-HRB0-42	214	1	42	6	0.4	3.25
U-HRB0-45	218	1	45	6	0.44	3.5
U-HRB0-48	222	1	48	6	0.48	3.75
U-HRB0-51	231	1	51	6	0.52	4
U-HRB0-54	234	1	54	6	0.56	4.25
U-HRB0-57	241	1	57	6	0.6	4.5
U-HRB0-60	244	1	60	6	0.64	4.75
U-HRB0-63	248	1	63	6	0.68	5
U-HRB0-66	266	1	66	6	0.72	5.25
U-HRB0-69	271	1	69	6	0.76	5.5
U-HRB0-72	290	1	72	6	0.8	5.75
U-HRB0-75	300	1	75	6	0.84	6
U-HRB0-78	312	1	78	6	0.88	6.25
U-HRB0-81	325	1	81	6	0.92	6.5
U-HRB0-84	340	1	84	6	0.96	6.75
U-HRB0-87	354	1	87	6	1	7
U-HRB0-90	368	1	90	6	1.04	7.25



Metro Pricebook
October 2024

Filing & Storage

filing and storage

Executive & Professional

pedestals	122
pedestals w/ seat cushion	124
underdesk storage cabinet	125
underdesk combo pedestal BBF & FF	126
underdesk 2-drawer lateral file	127

Executive

freestanding storage cabinet	128
freestanding combo pedestal BBF & FF	130
freestanding 2-drawer lateral file	132
freestanding 3-drawer lateral file	134
freestanding 4-drawer lateral file	136
freestanding storage tower	138
freestanding combo storage tower BBF	140
freestanding combo storage tower FF	142
freestanding wardrobe storage tower	144
freestanding storage tower double door	146
freestanding combo lateral storage double door	148
freestanding combo lateral storage glazed double door	150
bookcase	152

Professional

freestanding storage cabinet	129
freestanding combo pedestal BBF & FF	131
freestanding 2-drawer lateral file	133
freestanding 3-drawer lateral file	135
freestanding 4-drawer lateral file	137
freestanding storage tower	139
freestanding combo storage tower BBF	141
freestanding combo storage tower FF	143
freestanding wardrobe storage tower	145
freestanding storage tower double door	147
freestanding combo lateral storage double door	149
freestanding combo lateral storage glazed double door	151
bookcase	154

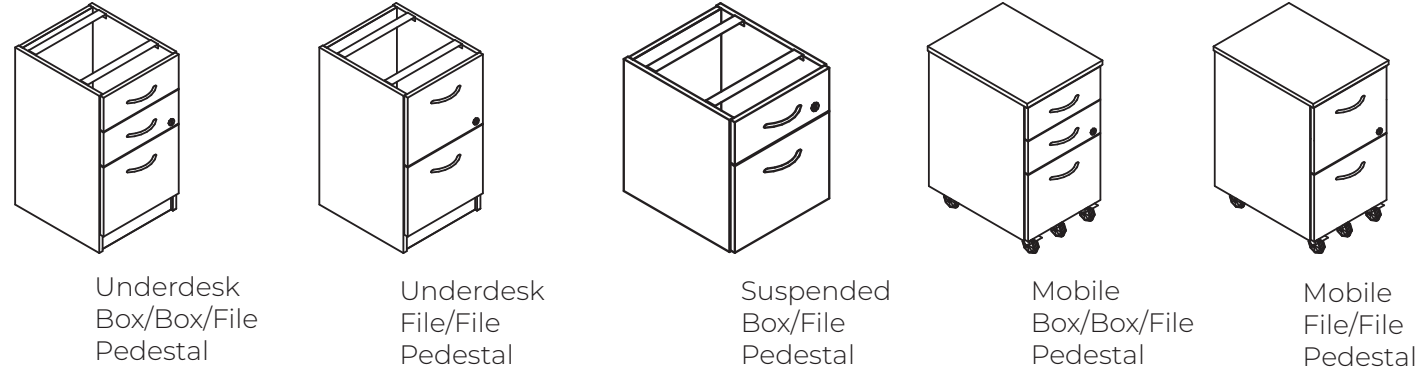

How to Specify:

Each laminate comes with matching vinyl trim color unless otherwise specified on your purchase order. Refer to the laminate finish card for details.

Notes:

Pedestals include lock and keys.

Options:

laminate color _____

handle color _____

handle style _____

back full back

Code	Price	H	W	D	Volume (ft ³)	Weight (lb)
Underdesk Box/Box/File Pedestal						
T-FPBU-1618	923	28	16	18	4.67	55
T-FPBU-1624	987	28	16	24	6.22	55
T-FPBU-1618-X	1011	28	16	18	4.67	55
T-FPBU-1624-X	1145	28	16	24	6.22	55
Underdesk File/File Pedestal						
T-FPFU-1618	923	28	16	18	4.67	55
T-FPFU-1624	987	28	16	24	6.22	55
T-FPFU-1618-X	1011	28	16	18	4.67	55
T-FPFU-1624-X	1145	28	16	24	6.22	55
Suspended Box/File Pedestal						
T-FPSU-1618	655	16	16	18	2.67	44
Mobile Box/Box/File Pedestal						
T-FPBM-1621	1213	28	16	21	5.44	74
Mobile File/File Pedestal						
T-FPFM-1621	1213	28	16	21	5.44	68

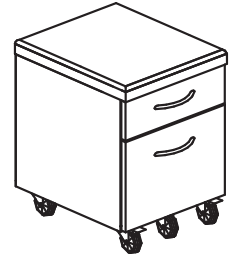

Mobile Box/File Pedestal w/
Upholstered Seat Cushion

How to Specify:

Each laminate comes with matching vinyl trim color unless otherwise specified on your purchase order. Refer to the laminate finish card for details.

Notes:

Pedestals include lock and keys.

Options:

laminate color

handle color

handle style

fabric color (for upholstered seat cushion, refer to seating fabric cards)

CODE	PRICE	H	W	D	VOLUME (FT ³)	WEIGHT (LB)
Mobile Box/File Pedestal w/Upholstered Seat Cushion						
T-1030-1618	1480	21	16	18	6.88	55

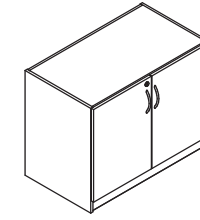

Underdesk Storage
Cabinet

How to Specify:

Each laminate comes with matching vinyl trim color unless otherwise specified on your purchase order. Refer to the laminate finish card for details.

Notes:

Cabinets and lateral files include lock and keys.

Options:

laminate color

handle color

handle style

Code	Price	H	W	D	Volume (ft ³)	Weight (lb)
T-FSU0-3020	1132	28	30	20	9.72	88
T-FSU0-3620	1226	28	36	20	11.67	102
T-FSU0-4220	1319	28	42	20	13.61	117
T-FSU0-3021	1132	28	30	21	10.21	92
T-FSU0-3621	1226	28	36	21	12.25	107
T-FSU0-4221	1319	28	42	21	14.29	122

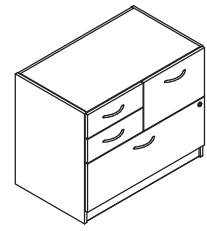

Underdesk Combo Pedestal
w/Box/Box/File and File/File,
LH Shown

How to Specify:

Each laminate comes with matching vinyl trim color unless otherwise specified on your purchase order. Refer to the laminate finish card for details.

Notes:

Cabinets and lateral files include lock and keys.

Options:

laminate color

handle color

handle style

Code	Price	H	W	D	Volume (ft ³)	Weight (lb)
T-FPJU-3620-L	1785	28	36	20	11.67	121
T-FPJU-3621-L	1785	28	36	21	12.25	122
T-FPJU-3620-R	1785	28	36	20	11.67	121
T-FPJU-3621-R	1785	28	36	21	12.25	122

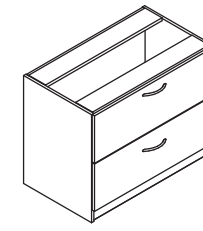

Underdesk 2-Drawer
Lateral File

How to Specify:

Each laminate comes with matching vinyl trim color unless otherwise specified on your purchase order. Refer to the laminate finish card for details.

Notes:

Cabinets and lateral files include lock and keys.

Options:

laminate color

handle color

handle style

Code	Price	H	W	D	Volume (ft ³)	Weight (lb)
T-FL2U-3020	1460	28	30	20	9.72	82.06
T-FL2U-3620	1513	28	36	20	11.67	86.64
T-FL2U-4220	1597	28	42	20	13.61	89.35
T-FL2U-3021	1460	28	30	21	10.21	84.6
T-FL2U-3621	1513	28	36	21	12.25	88.02
T-FL2U-4221	1597	28	42	21	14.29	91.44

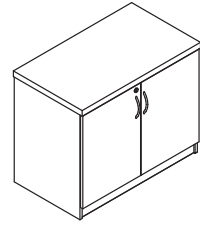

1.5" Freestanding Storage Cabinet

How to Specify:

Each laminate comes with matching vinyl trim color unless otherwise specified on your purchase order. Refer to the laminate finish card for details.

Notes:

Cabinets and lateral files include lock and keys.

Options:

laminate color

edge profile (for freestanding cabinet)

handle color

handle style

Code	Price	H	W	D	Volume (ft ³)	Weight (lb)
T-FSF0-3021	1246	29.5	30	21	10.76	98
T-FSF0-3621	1336	29.5	36	21	12.91	111
T-FSF0-4221	1427	29.5	42	21	15.06	124

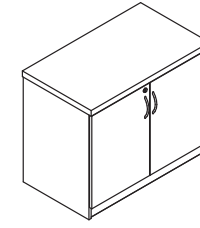

1" Freestanding Storage Cabinet

How to Specify:

Each laminate comes with matching vinyl trim color unless otherwise specified on your purchase order. Refer to the laminate finish card for details.

Notes:

Cabinets and lateral files include lock and keys.

Options:

laminate color

edge profile (for freestanding cabinet)

handle color

handle style

Code	Price	H	W	D	Volume (ft ³)	Weight (lb)
TL-FSF0-3021	1190	29	30	21	10.57	88
TL-FSF0-3621	1283	29	36	21	12.69	97
TL-FSF0-4221	1374	29	42	21	14.8	106

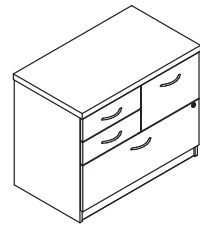

1.5" Freestanding Combo Pedestal w/Box/Box/File and File/File, LH Shown

How to Specify:

Each laminate comes with matching vinyl trim color unless otherwise specified on your purchase order. Refer to the laminate finish card for details.

Notes:

Cabinets and lateral files include lock and keys.

Options:

laminate color

edge profile (for freestanding cabinet)

handle color

handle style

Code	Price	H	W	D	Volume (ft ³)	Weight (lb)
T-FPJF-3621-L	1869	29.5	36	21	12.91	130
T-FPJF-3621-R	1869	29.5	36	21	12.91	130

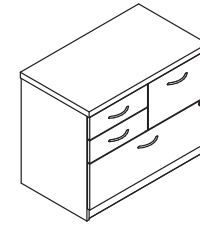

1" Freestanding Combo Pedestal w/Box/Box/File and File/File, LH Shown

How to Specify:

Each laminate comes with matching vinyl trim color unless otherwise specified on your purchase order. Refer to the laminate finish card for details.

Notes:

Cabinets and lateral files include lock and keys.

Options:

laminate color

handle color

handle style

Code	Price	H	W	D	Volume (ft ³)	Weight (lb)
TL-FPJF-3621-L	1830	29	36	21	12.69	130
TL-FPJF-3621-R	1830	29	36	21	12.69	130

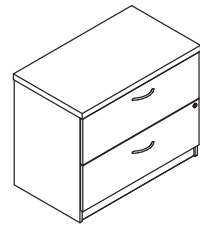

1.5" Freestanding 2-Drawer Lateral File

How to Specify:

Each laminate comes with matching vinyl trim color unless otherwise specified on your purchase order. Refer to the laminate finish card for details.

Notes:

Cabinets and lateral files include lock and keys.

Options:

- laminate color

- edge profile (for freestanding cabinet)

- handle color

- handle style

Code	Price	H	W	D	Volume (ft ³)	Weight (lb)
T-FL2F-3021	1559	29.5	30	21	10.76	108.9
T-FL2F-3621	1610	29.5	36	21	12.91	117.27
T-FL2F-4221	1688	29.5	42	21	15.06	125.64

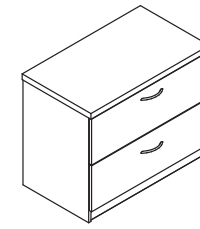

1" Freestanding 2-Drawer Lateral File

How to Specify:

Each laminate comes with matching vinyl trim color unless otherwise specified on your purchase order. Refer to the laminate finish card for details.

Notes:

Cabinets and lateral files include lock and keys.

Options:

- laminate color

- handle color

- handle style

Code	Price	H	W	D	Volume (ft ³)	Weight (lb)
TL-FL2F-3021	1511	29	30	21	10.57	92.7
TL-FL2F-3621	1560	29	36	21	12.69	107.1
TL-FL2F-4221	1643	29	42	21	14.8	121.5

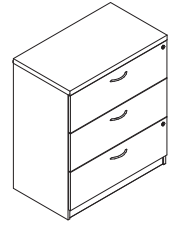

1.5" Freestanding 3-Drawer Lateral File

How to Specify:

Each laminate comes with matching vinyl trim color unless otherwise specified on your purchase order. Refer to the laminate finish card for details.

Notes:

Cabinets and lateral files include lock and keys.

Options:

laminate color

edge profile (for freestanding cabinet)

handle color

handle style

Code	Price	H	W	D	Volume (ft ³)	Weight (lb)
T-FL3F-3021	1938	40.5	30	21	14.77	145
T-FL3F-3621	2021	40.5	36	21	17.72	154.96

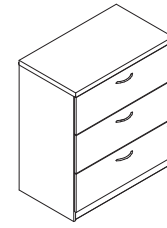

1" Freestanding 3-Drawer Lateral File

How to Specify:

Each laminate comes with matching vinyl trim color unless otherwise specified on your purchase order. Refer to the laminate finish card for details.

Notes:

Cabinets and lateral files include lock and keys.

Options:

laminate color

handle color

handle style

Code	Price	H	W	D	Volume (ft ³)	Weight (lb)
TL-FL3F-3021	1702	40	30	21	14.58	136.5
TL-FL3F-3621	1785	40	36	21	17.5	144.25

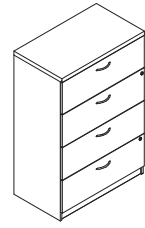

1.5" Freestanding 4-Drawer Lateral File

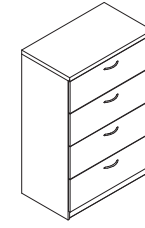

1" Freestanding 4-Drawer Lateral File

How to Specify:

Notes:

Each laminate comes with matching vinyl trim color unless otherwise specified on your purchase order. Refer to the laminate finish card for details.

Cabinets and lateral files include lock and keys.

Options:

laminate color

edge profile (for freestanding cabinet)

handle color

handle style

How to Specify:

Notes:

Each laminate comes with matching vinyl trim color unless otherwise specified on your purchase order. Refer to the laminate finish card for details.

Cabinets and lateral files include lock and keys.

Options:

laminate color

handle color

handle style

Code	Price	H	W	D	Volume (ft ³)	Weight (lb)
T-FL4F-3021	2537	52.5	30	21	19.14	171.3
T-FL4F-3621	2619	52.5	36	21	22.97	183.24

Code	Price	H	W	D	Volume (ft ³)	Weight (lb)
TL-FL4F-3021	2298	52	30	21	18.96	153.1
TL-FL4F-3621	2382	52	36	21	22.75	162.98

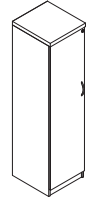

1.5" Storage Cabinet w/Shelves,
LH Shown

How to Specify:

Each laminate comes with matching vinyl trim color unless otherwise specified on your purchase order. Refer to the laminate finish card for details.

Notes:

Cabinets and lateral files include lock and keys.

Options:

laminate color

edge profile

handle color

handle style

Code	Price	H	W	D	Volume (ft ³)	Weight (lb)
T-FSDS-1821-L	1382	68	18	21	14.88	133.65
T-FSDS-1821-R	1382	68	18	21	14.88	133.65

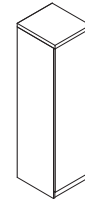

1" Storage Cabinet w/Shelves,
LH Shown

How to Specify:

Each laminate comes with matching vinyl trim color unless otherwise specified on your purchase order. Refer to the laminate finish card for details.

Notes:

Cabinets and lateral files include lock and keys.

Options:

laminate color

handle color

handle style

Code	Price	H	W	D	Volume (ft ³)	Weight (lb)
TL-FSDS-1821-L	1326	67	18	21	14.66	128.7
TL-FSDS-1821-R	1326	67	18	21	14.66	128.7

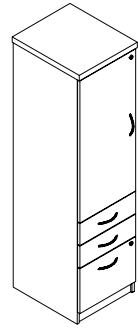

1.5" Combo Cabinet w/Storage and Box/Box/File,

How to Specify:

Each laminate comes with matching vinyl trim color unless otherwise specified on your purchase order. Refer to the laminate finish card for details.

Notes:

Cabinets and lateral files include lock and keys.

Options:

laminate color

edge profile

handle color

handle style

Code	Price	H	W	D	Volume (ft ³)	Weight (lb)
T-FCSB-1821-L	2171	68	18	21	14.88	168
T-FCSB-1821-R	2171	68	18	21	14.88	168

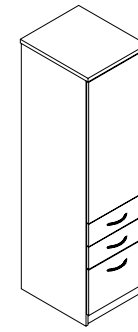

1" Combo Cabinet w/Storage and Box/Box/File,

How to Specify:

Each laminate comes with matching vinyl trim color unless otherwise specified on your purchase order. Refer to the laminate finish card for details.

Notes:

Cabinets and lateral files include lock and keys.

Options:

laminate color

handle color

handle style

Code	Price	H	W	D	Volume (ft ³)	Weight (lb)
TL-FCSB-1821-L	1936	67	18	21	14.66	163
TL-FCSB-1821-R	1936	67	18	21	14.66	163



1.5" Combo Cabinet w/Storage and File/File, LH Shown

How to Specify:

Each laminate comes with matching vinyl trim color unless otherwise specified on your purchase order. Refer to the laminate finish card for details.

Notes:

Cabinets and lateral files include lock and keys.

Options:

laminate color

edge profile

handle color

handle style

Code	Price	H	W	D	Volume (ft ³)	Weight (lb)
T-FCSF-1821-L	2171	68	18	21	14.88	162
T-FCSF-1821-R	2171	68	18	21	14.88	162



1" Combo Cabinet w/Storage and File/File, LH Shown

How to Specify:

Each laminate comes with matching vinyl trim color unless otherwise specified on your purchase order. Refer to the laminate finish card for details.

Notes:

Cabinets and lateral files include lock and keys.

Options:

laminate color

handle color

handle style

Code	Price	H	W	D	Volume (ft ³)	Weight (lb)
TL-FCSF-1821-L	1936	67	18	21	14.66	129
TL-FCSF-1821-R	1936	67	18	21	14.66	129

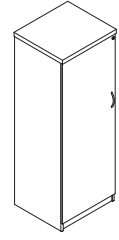

1.5" Storage Cabinet w/Coat Bar and Shelves,

How to Specify:

Each laminate comes with matching vinyl trim color unless otherwise specified on your purchase order. Refer to the laminate finish card for details.

Notes:

Cabinets and lateral files include lock and keys.

Options:

laminate color

edge profile

handle color

handle style

Code	Price	H	W	D	Volume (ft ³)	Weight (lb)
T-FSDC-2421-L	1490	68	24	21	19.83	179.64
T-FSDC-2421-R	1490	68	24	21	19.83	179.64

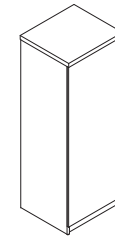

1" Storage Cabinet w/Coat Bar and Shelves,

How to Specify:

Each laminate comes with matching vinyl trim color unless otherwise specified on your purchase order. Refer to the laminate finish card for details.

Notes:

Cabinets and lateral files include lock and keys.

Options:

laminate color

handle color

handle style

Code	Price	H	W	D	Volume (ft ³)	Weight (lb)
TL-FSDC-2421-L	1434	67	24	21	19.54	169.95
TL-FSDC-2421-R	1434	67	24	21	19.54	169.95

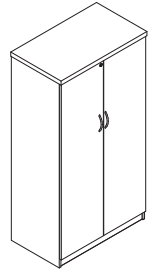

1.5" Double Door Storage Cabinet w/Shelves

How to Specify:

Each laminate comes with matching vinyl trim color unless otherwise specified on your purchase order. Refer to the laminate finish card for details.

Notes:

Cabinets and lateral files include lock and keys.

Options:

laminate color

edge profile

handle color

handle style

Code	Price	H	W	D	Volume (ft ³)	Weight (lb)
T-FSDS-3021	2098	68	30	21	25	196
T-FSDS-3621	2171	68	36	21	29.75	204.96

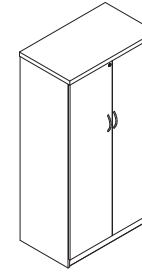

1" Double Door Storage Cabinet w/Shelves

How to Specify:

Each laminate comes with matching vinyl trim color unless otherwise specified on your purchase order. Refer to the laminate finish card for details.

Notes:

Cabinets and lateral files include lock and keys.

Options:

laminate color

handle color

handle style

Code	Price	H	W	D	Volume (ft ³)	Weight (lb)
TL-FSDS-3021	1946	67	30	21	24	180
TL-FSDS-3621	2020	67	36	21	29.31	195.39

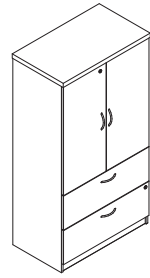

1.5" Combo Cabinet w/Storage and Lateral File

How to Specify:

Each laminate comes with matching vinyl trim color unless otherwise specified on your purchase order. Refer to the laminate finish card for details.

Notes:

Cabinets and lateral files include lock and keys.

Options:

- laminate color _____
- edge profile _____
- handle color _____
- handle style _____

Code	Price	H	W	D	Volume (ft ³)	Weight (lb)
T-FCSL-3621	2577	68	36	21	29.75	260.82

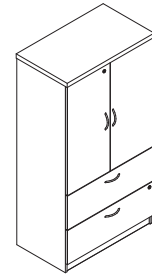

1" Combo Cabinet w/Storage and Lateral File

How to Specify:

Each laminate comes with matching vinyl trim color unless otherwise specified on your purchase order. Refer to the laminate finish card for details.

Notes:

Cabinets and lateral files include lock and keys.

Options:

- laminate color _____
- handle color _____
- handle style _____

Code	Price	H	W	D	Volume (ft ³)	Weight (lb)
TL-FCSL-3621	2342	67	36	21	29.31	251.25

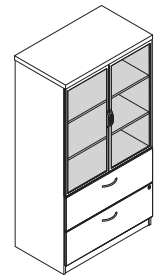

1.5" Combo Cabinet w/Storage, Lateral File

How to Specify:

Each laminate comes with matching vinyl trim color unless otherwise specified on your purchase order. Refer to the laminate finish card for details.

Notes:

Only laminate drawers include lock and keys.

Options:

- _____ laminate color
- _____ edge profile
- _____ metal color (for acrylic door frame)
- _____ handle color
- _____ handle style

Code	Price	H	W	D	Volume (ft ³)	Weight (lb)
T-FCSL-3621-G	4151	68	36	21	29.75	222.62

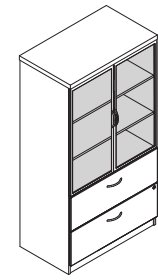

1" Combo Cabinet w/Storage, Lateral File

How to Specify:

Each laminate comes with matching vinyl trim color unless otherwise specified on your purchase order. Refer to the laminate finish card for details.

Notes:

Only laminate drawers include lock and keys.

Options:

- _____ laminate color
- _____ metal color (for acrylic door frame)
- _____ handle color
- _____ handle style

Code	Price	H	W	D	Volume (ft ³)	Weight (lb)
TL-FCSL-3621-G	3928	67	36	21	29.31	213.05

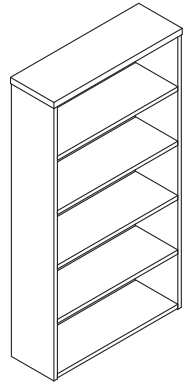

1.5" bookcase

How to Specify:

Each laminate comes with matching vinyl trim color unless otherwise specified on your purchase order. Refer to the laminate finish card for details.

Notes:

Book cases have adjustable shelves and one fixed shelf at desk height.

All bookcases come with a solid laminate back in matching color.

Number of shelves includes shelf on bottom of bookcase.

Options:

laminate color

Code	Price	H	W	D	Volume (ft ³)	Weight (lb)	# of Shelves
12" Deep							
T-SB0X-292412	669	29	24	12	4.8	51.61	2H
T-SB0X-293012	736	29	30	12	6	60.72	2H
T-SB0X-293612	800	29	36	12	7.3	69.83	2H
T-SB0X-294212	866	29	42	12	8.5	78.93	2H
T-SB0X-422412	836	42	24	12	7	70.73	3H
T-SB0X-423012	911	42	30	12	8.8	82.94	3H
T-SB0X-423612	990	42	36	12	10.5	95.14	3H
T-SB0X-424212	1068	42	42	12	12.3	107.35	3H
T-SB0X-542412	983	54	24	12	9	88.85	4H
T-SB0X-543012	1072	54	30	12	11.3	104.04	4H
T-SB0X-543612	1166	54	36	12	13.5	119.23	4H
T-SB0X-544212	1257	54	42	12	15.8	134.42	4H
T-SB0X-682412	1141	68	24	12	11.3	108.38	5H
T-SB0X-683012	1251	68	30	12	14.2	126.79	5H
T-SB0X-683612	1362	68	36	12	17	145.19	5H
T-SB0X-684212	1473	68	42	12	19.8	163.59	5H
T-SB0X-782412	1286	78	24	12	13	124.48	6H
T-SB0X-783012	1412	78	30	12	16.3	145.65	6H
T-SB0X-783612	1541	78	36	12	19.5	166.81	6H
T-SB0X-784212	1667	78	42	12	22.8	187.98	6H
15" Deep							
T-SB0X-292415	756	29	24	15	6	61.91	2H
T-SB0X-293015	829	29	30	15	7.6	72.59	2H
T-SB0X-293615	901	29	36	15	9.1	83.26	2H
T-SB0X-294215	976	29	42	15	10.6	93.94	2H
T-SB0X-422415	939	42	24	15	8.8	84.62	3H
T-SB0X-423015	1027	42	30	15	10.9	98.84	3H
T-SB0X-423615	1115	42	36	15	13.1	113.06	3H
T-SB0X-424215	1202	42	42	15	15.3	127.28	3H
T-SB0X-542415	1103	54	24	15	11.3	106.17	4H
T-SB0X-543015	1204	54	30	15	14.1	123.82	4H
T-SB0X-543615	1313	54	36	15	16.9	141.48	4H
T-SB0X-544215	1414	54	42	15	19.7	159.13	4H
T-SB0X-682415	1283	68	24	15	14.2	129.29	5H
T-SB0X-683015	1407	68	30	15	17.7	150.6	5H
T-SB0X-683615	1534	68	36	15	21.3	171.91	5H
T-SB0X-684215	1658	68	42	15	24.8	193.23	5H
T-SB0X-782415	1447	78	24	15	16.3	149.27	6H
T-SB0X-783015	1588	78	30	15	20.3	173.79	6H
T-SB0X-783615	1733	78	36	15	24.4	198.32	6H
T-SB0X-784215	1876	78	42	15	28.4	222.84	6H

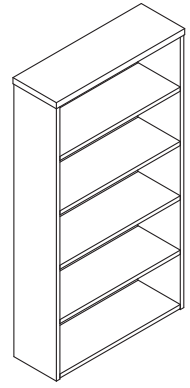

1" bookcase

12" or 15" Deep

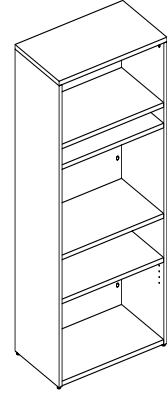

21" Deep

How to Specify:

Each laminate comes with matching vinyl trim color unless otherwise specified on your purchase order. Refer to the laminate finish card for details.

Notes:

Book cases have adjustable shelves and one fixed shelf at desk height.

All bookcases come with a solid laminate back in matching color.

Number of shelves includes shelf on bottom of bookcase.

Options:

laminate color

edge profile

Code	Price	H	W	D	Volume (ft ³)	Weight (lb)	# of Shelves
12" Deep							
TL-SB0X-292412	618	29	24	12	4.8	48.03	2H
TL-SB0X-293012	684	29	30	12	6	56.24	2H
TL-SB0X-293612	746	29	36	12	7.3	64.45	2H
TL-SB0X-294212	812	29	42	12	8.5	72.66	2H
TL-SB0X-422412	790	42	24	12	7	67.15	3H
TL-SB0X-423012	866	42	30	12	8.8	78.46	3H
TL-SB0X-423612	946	42	36	12	10.5	89.77	3H
TL-SB0X-424212	1022	42	42	12	12.3	101.08	3H
TL-SB0X-542412	928	54	24	12	9	85.27	4H
TL-SB0X-543012	1024	54	30	12	11.3	99.56	4H
TL-SB0X-543612	1119	54	36	12	13.5	113.86	4H
TL-SB0X-544212	1219	54	42	12	15.8	128.15	4H
TL-SB0X-672412	1085	67	24	12	11.2	104.8	5H
TL-SB0X-673012	1203	67	30	12	14	122.31	5H
TL-SB0X-673612	1321	67	36	12	16.8	139.81	5H
TL-SB0X-674212	1437	67	42	12	19.5	157.32	5H
TL-SB0X-772412	1232	77	24	12	12.8	120.9	6H
TL-SB0X-773012	1361	77	30	12	16	141.17	6H
TL-SB0X-773612	1491	77	36	12	19.3	161.44	6H
TL-SB0X-774212	1623	77	42	12	22.5	181.7	6H
15" Deep							
TL-SB0X-292415	694	29	24	15	6	57.43	2H
TL-SB0X-293015	770	29	30	15	7.6	66.99	2H
TL-SB0X-293615	842	29	36	15	9.1	76.54	2H
TL-SB0X-294215	916	29	42	15	10.6	86.1	2H
TL-SB0X-422415	886	42	24	15	8.8	80.14	3H
TL-SB0X-423015	976	42	30	15	10.9	93.24	3H
TL-SB0X-423615	1061	42	36	15	13.1	106.34	3H
TL-SB0X-424215	1149	42	42	15	15.3	119.44	3H
TL-SB0X-542415	1042	54	24	15	11.3	101.69	4H
TL-SB0X-543015	1152	54	30	15	14.1	118.23	4H
TL-SB0X-543615	1261	54	36	15	16.9	134.76	4H
TL-SB0X-544215	1372	54	42	15	19.7	151.3	4H
TL-SB0X-672415	1221	67	24	15	14	124.81	5H
TL-SB0X-673015	1355	67	30	15	17.4	145	5H
TL-SB0X-673615	1487	67	36	15	20.9	165.19	5H
TL-SB0X-674215	1619	67	42	15	24.4	185.39	5H
TL-SB0X-772415	1384	77	24	15	16	144.04	6H
TL-SB0X-773015	1531	77	30	15	20.1	167.45	6H
TL-SB0X-773615	1679	77	36	15	24.1	190.85	6H
TL-SB0X-774215	1829	77	42	15	28.1	214.25	6H
21" Deep							
TL-SB0S-673621	2355	67.38	36	21	29.48	151.94	4H



Metro Pricebook
October 2024

Overhead Storage

overhead storage

Executive

<u>open hutch</u>	156
<u>hinged door hutch</u>	158
<u>glazed door hutch</u>	160
<u>open hutch w/ pidgeon holes</u>	162
<u>hinged door hutch w/ pidgeon holes</u>	164
<u>wall mounted hinged door hutch</u>	166
<u>wall mounted glazed door hutch</u>	168

Professional

<u>open hutch</u>	157
<u>hinged door hutch</u>	159
<u>glazed door hutch</u>	161
<u>open hutch w/ pidgeon holes</u>	163
<u>hinged door hutch w/ pidgeon holes</u>	165
<u>wall mounted hinged door hutch</u>	167
<u>wall mounted glazed door hutch</u>	169

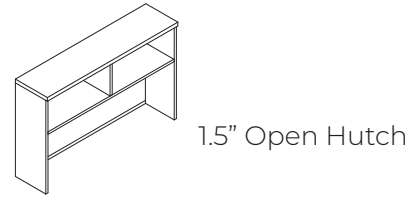

How to Specify:

Each laminate comes with matching vinyl trim color unless otherwise specified on your purchase order. Refer to the laminate finish card for details.

Notes:

Number of Openings and Doors per Hutch										
width(in)	30	36	42	48	54	60	66	72	78	84
openings	1	1	2	2	2	2	2	2	2	2

Options:

- laminate color

- edge profile

- metal color (for acrylic door frames)

- acrylic color (for doors)

Code	Price	H	W	D	Volume (ft ³)	Weight (lb)
T-SH00-1530	745	39	30	15	10.16	75.62
T-SH00-1536	862	39	36	15	12.19	84.86
T-SH00-1542	897	39	42	15	14.22	94.1
T-SH00-1548	990	39	48	15	16.25	103.34
T-SH00-1554	1075	39	54	15	18.28	112.58
T-SH00-1560	1163	39	60	15	20.31	121.82
T-SH00-1566	1236	39	66	15	22.34	131.06
T-SH00-1572	1330	39	72	15	24.38	140.3
T-SH00-1578	1408	39	78	15	26.41	149.54
T-SH00-1584	1490	39	84	15	28.44	158.78

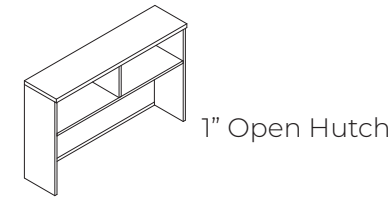

How to Specify:

Each laminate comes with matching vinyl trim color unless otherwise specified on your purchase order. Refer to the laminate finish card for details.

Notes:

Number of Openings and Doors per Hutch										
width(in)	30	36	42	48	54	60	66	72	78	84
openings	1	1	2	2	2	2	2	2	2	2

Options:

- laminate color

- metal color (for acrylic door frames)

- acrylic color (for doors)

Code	Price	H	W	D	Volume (ft ³)	Weight (lb)
TL-SH00-1530	613	38.5	30	15	16.08	69.79
TL-SH00-1536	730	38.5	36	15	18.91	79.03
TL-SH00-1542	759	38.5	42	15	21.75	88.27
TL-SH00-1548	859	38.5	48	15	24.59	97.51
TL-SH00-1554	943	38.5	54	15	27.42	106.75
TL-SH00-1560	1029	38.5	60	15	30.26	115.99
TL-SH00-1566	1103	38.5	66	15	33.1	125.23
TL-SH00-1572	1201	38.5	72	15	35.93	134.47
TL-SH00-1578	1272	38.5	78	15	38.77	143.71
TL-SH00-1584	1359	38.5	84	15	41.61	152.95

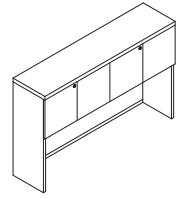

1.5" Hinged-Door Hutch

How to Specify:

Each laminate comes with matching vinyl trim color unless otherwise specified on your purchase order. Refer to the laminate finish card for details.

Notes:

Number of Openings and Doors per Hutch										
width(in)	30	36	42	48	54	60	66	72	78	84
openings	1	1	2	2	2	2	2	2	2	2
doors	2	2	3	3	3	4	4	4	4	4

Laminate doors include locks and keys.

Options:

laminate color

edge profile

Code	Price	H	W	D	Volume (ft ³)	Weight (lb)
T-SHH0-1530-L	1146	39	30	15	10.16	85.07
T-SHH0-1536-L	1211	39	36	15	12.19	94.31
T-SHH0-1542-L	1382	39	42	15	14.22	103.55
T-SHH0-1548-L	1502	39	48	15	16.25	117.51
T-SHH0-1554-L	1631	39	54	15	18.28	126.75
T-SHH0-1560-L	1738	39	60	15	20.31	140.72
T-SHH0-1566-L	1843	39	66	15	22.34	149.96
T-SHH0-1572-L	1938	39	72	15	24.38	159.2
T-SHH0-1578-L	2033	39	78	15	26.41	168.44
T-SHH0-1584-L	2108	39	84	15	28.44	177.68

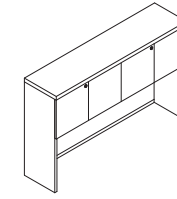

1" Hinged-Door Hutch

How to Specify:

Each laminate comes with matching vinyl trim color unless otherwise specified on your purchase order. Refer to the laminate finish card for details.

Notes:

Number of Openings and Doors per Hutch										
width(in)	30	36	42	48	54	60	66	72	78	84
openings	1	1	2	2	2	2	2	2	2	2
doors	2	2	3	3	3	4	4	4	4	4

Laminate doors include locks and keys.

Options:

laminate color

metal color (for acrylic door frames)

Code	Price	H	W	D	Volume (ft ³)	Weight (lb)
TL-SHH0-1530-L	1026	38.5	30	15	16.08	79.24
TL-SHH0-1536-L	1081	38.5	36	15	18.91	88.48
TL-SHH0-1542-L	1236	38.5	42	15	21.75	102.44
TL-SHH0-1548-L	1339	38.5	48	15	24.59	111.68
TL-SHH0-1554-L	1458	38.5	54	15	27.42	120.92
TL-SHH0-1560-L	1549	38.5	60	15	30.26	134.89
TL-SHH0-1566-L	1644	38.5	66	15	33.1	144.13
TL-SHH0-1572-L	1729	38.5	72	15	35.93	153.37
TL-SHH0-1578-L	1817	38.5	78	15	38.77	162.61
TL-SHH0-1584-L	1884	38.5	84	15	41.61	171.85

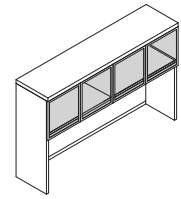

1.5" Hinged-Door Hutch w/Acrylic Doors

How to Specify:

Each laminate comes with matching vinyl trim color unless otherwise specified on your purchase order. Refer to the laminate finish card for details.

Notes:

Number of Openings and Doors per Hutch										
width(in)	30	36	42	48	54	60	66	72	78	84
openings	1	1	2	2	2	2	2	2	2	2
doors	2	2	3	3	3	4	4	4	4	4

Acrylic doors do not have locks

Options:

laminate color

edge profile

metal color (for acrylic door frames)

acrylic color (for doors)

Code	Price	H	W	D	Volume (ft ³)	Weight (lb)
T-SHH0-1530-G	1843	39	30	15	10.16	88.22
T-SHH0-1536-G	1990	39	36	15	12.19	96.56
T-SHH0-1542-G	2132	39	42	15	14.22	105.8
T-SHH0-1548-G	2643	39	48	15	16.25	122.24
T-SHH0-1554-G	2799	39	54	15	18.28	131.48
T-SHH0-1560-G	3291	39	60	15	20.31	147.92
T-SHH0-1566-G	3356	39	66	15	22.34	157.16
T-SHH0-1572-G	3505	39	72	15	24.38	166.4
T-SHH0-1578-G	3611	39	78	15	26.41	175.64
T-SHH0-1584-G	3706	39	84	15	28.44	184.88

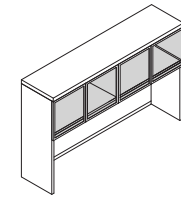

1" Hinged-Door Hutch w/Acrylic Doors

How to Specify:

Each laminate comes with matching vinyl trim color unless otherwise specified on your purchase order. Refer to the laminate finish card for details.

Notes:

Number of Openings and Doors per Hutch										
width(in)	30	36	42	48	54	60	66	72	78	84
openings	1	1	2	2	2	2	2	2	2	2
doors	2	2	3	3	3	4	4	4	4	4

Acrylic doors do not have locks and keys.

Options:

laminate color

metal color (for acrylic door frames)

acrylic color (for doors)

Code	Price	H	W	D	Volume (ft ³)	Weight (lb)
TL-SHH0-1530-G	1608	38.5	30	15	16.08	82.39
TL-SHH0-1536-G	1752	38.5	36	15	18.91	91.63
TL-SHH0-1542-G	1893	38.5	42	15	21.75	107.17
TL-SHH0-1548-G	2403	38.5	48	15	24.59	116.41
TL-SHH0-1554-G	2565	38.5	54	15	27.42	125.65
TL-SHH0-1560-G	3054	38.5	60	15	30.26	142.09
TL-SHH0-1566-G	3117	38.5	66	15	33.1	151.33
TL-SHH0-1572-G	3267	38.5	72	15	35.93	160.57
TL-SHH0-1578-G	3372	38.5	78	15	38.77	169.81
TL-SHH0-1584-G	3470	38.5	84	15	41.61	179.05

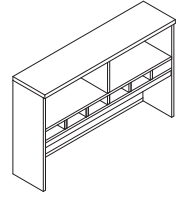

1.5" Open Hutch w/Pigeonholes

How to Specify:

Each laminate comes with matching vinyl trim color unless otherwise specified on your purchase order. Refer to the laminate finish card for details.

Notes:

Number of Openings and Doors per Hutch										
width(in)	30	36	42	48	54	60	66	72	78	84
openings	1	1	2	2	2	2	2	2	2	2
# of pigeon holes	3	3	4	4	5	6	6	7	8	8

Options:

laminate color

edge profile

Code	Price	H	W	D	Volume (ft ³)	Weight (lb)
T-SHOP-1530	1041	39	30	15	10.16	87.77
T-SHOP-1536	1203	39	36	15	12.19	97.01
T-SHOP-1542	1246	39	42	15	14.22	111.69
T-SHOP-1548	1382	39	48	15	16.25	120.93
T-SHOP-1554	1502	39	54	15	18.28	135.58
T-SHOP-1560	1619	39	60	15	20.31	148.2
T-SHOP-1566	1727	39	66	15	22.34	157.44
T-SHOP-1572	1863	39	72	15	24.38	170.74
T-SHOP-1578	1959	39	78	15	26.41	183.36
T-SHOP-1584	2087	39	84	15	28.44	195.99

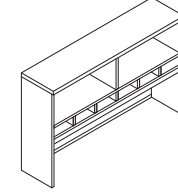

1" Open Hutch w/Pigeonholes

How to Specify:

Each laminate comes with matching vinyl trim color unless otherwise specified on your purchase order. Refer to the laminate finish card for details.

Notes:

Number of Openings and Doors per Hutch										
width(in)	30	36	42	48	54	60	66	72	78	84
openings	1	1	2	2	2	2	2	2	2	2
# of pigeon holes	3	3	4	4	5	6	6	7	8	8

Options:

laminate color

Code	Price	H	W	D	Volume (ft ³)	Weight (lb)
TL-SHOP-1530	806	38.5	30	15	16.08	81.94
TL-SHOP-1536	966	38.5	36	15	18.91	91.18
TL-SHOP-1542	1009	38.5	42	15	21.75	105.86
TL-SHOP-1548	1145	38.5	48	15	24.59	115.1
TL-SHOP-1554	1266	38.5	54	15	27.42	129.75
TL-SHOP-1560	1380	38.5	60	15	30.26	142.37
TL-SHOP-1566	1489	38.5	66	15	33.1	151.61
TL-SHOP-1572	1630	38.5	72	15	35.93	164.91
TL-SHOP-1578	1723	38.5	78	15	38.77	177.53
TL-SHOP-1584	1852	38.5	84	15	41.61	190.16

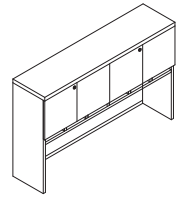

1.5" Hinged-Door Hutch w/Pigeonholes

How to Specify:

Each laminate comes with matching vinyl trim color unless otherwise specified on your purchase order. Refer to the laminate finish card for details.

Notes:

Number of Openings and Doors per Hutch										
width(in)	30	36	42	48	54	60	66	72	78	84
openings	1	1	2	2	2	2	2	2	2	2
# of pigeon holes	3	3	4	4	5	6	6	7	8	8

Options:

laminate color

edge profile

Code	Price	H	W	D	Volume (ft ³)	Weight (lb)
T-SHHP-1530-L	1415	39	30	15	10.16	97.22
T-SHHP-1536-L	1507	39	36	15	12.19	106.46
T-SHHP-1542-L	1706	39	42	15	14.22	121.14
T-SHHP-1548-L	1869	39	48	15	16.25	135.1
T-SHHP-1554-L	2030	39	54	15	18.28	149.75
T-SHHP-1560-L	2157	39	60	15	20.31	167.1
T-SHHP-1566-L	2228	39	66	15	22.34	176.34
T-SHHP-1572-L	2369	39	72	15	24.38	189.64
T-SHHP-1578-L	2472	39	78	15	26.41	202.26
T-SHHP-1584-L	2569	39	84	15	28.44	214.89

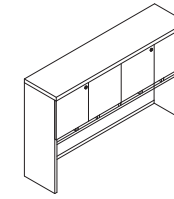

1" Hinged-Door Hutch w/Pigeonholes

How to Specify:

Each laminate comes with matching vinyl trim color unless otherwise specified on your purchase order. Refer to the laminate finish card for details.

Notes:

Number of Openings and Doors per Hutch										
width(in)	30	36	42	48	54	60	66	72	78	84
openings	1	1	2	2	2	2	2	2	2	2
# of pigeon holes	3	3	4	4	5	6	6	7	8	8

Options:

laminate color

metal color (for acrylic door frame)

Code	Price	H	W	D	Volume (ft ³)	Weight (lb)
TL-SHHP-1530-L	1180	38.5	30	15	16.08	91.39
TL-SHHP-1536-L	1270	38.5	36	15	18.91	100.63
TL-SHHP-1542-L	1472	38.5	42	15	21.75	120.03
TL-SHHP-1548-L	1636	38.5	48	15	24.59	129.27
TL-SHHP-1554-L	1794	38.5	54	15	27.42	143.92
TL-SHHP-1560-L	1925	38.5	60	15	30.26	161.27
TL-SHHP-1566-L	1992	38.5	66	15	33.1	170.51
TL-SHHP-1572-L	2137	38.5	72	15	35.93	183.81
TL-SHHP-1578-L	2236	38.5	78	15	38.77	196.43
TL-SHHP-1584-L	2333	38.5	84	15	41.61	209.06

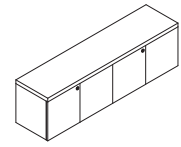

1.5" Wall-Mounted Hinged-Door Hutch

How to Specify:

Each laminate comes with matching vinyl trim color unless otherwise specified on your purchase order. Refer to the laminate finish card for details.

Notes:

Number of Openings and Doors per Hutch										
width(in)	30	36	42	48	54	60	66	72	78	84
openings	1	1	2	2	2	2	2	2	2	2
doors	2	2	3	3	3	4	4	4	4	4

Laminate doors include locks and keys.

Install wall-mounted overheads directly onto permanent studs. Please refer to installation instructions.

Options:

laminate color

edge profile

Code	Price	H	W	D	Volume (ft ³)	Weight (lb)
T-SHHW-1530-L	819	17	30	15	4.43	46.9
T-SHHW-1536-L	869	17	36	15	5.31	52.99
T-SHHW-1542-L	970	17	42	15	6.2	59.08
T-SHHW-1548-L	1022	17	48	15	7.08	65.17
T-SHHW-1554-L	1070	17	54	15	7.97	71.26
T-SHHW-1560-L	1169	17	60	15	8.85	77.35
T-SHHW-1566-L	1219	17	66	15	9.74	83.44
T-SHHW-1572-L	1270	17	72	15	10.63	89.53

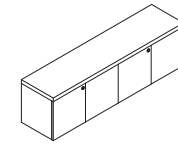

1" Wall-Mounted Hinged-Door Hutch

How to Specify:

Each laminate comes with matching vinyl trim color unless otherwise specified on your purchase order. Refer to the laminate finish card for details.

Notes:

Number of Openings and Doors per Hutch										
width(in)	30	36	42	48	54	60	66	72	78	84
openings	1	1	2	2	2	2	2	2	2	2
doors	2	2	3	3	3	4	4	4	4	4

Laminate doors include locks and keys.

Install wall-mounted overheads directly onto permanent studs. Please refer to installation instructions.

Options:

laminate color

Code	Price	H	W	D	Volume (ft ³)	Weight (lb)
TL-SHHW-1530-L	784	16.5	30	15	7.67	42.05
TL-SHHW-1536-L	829	16.5	36	15	9.02	46.84
TL-SHHW-1542-L	922	16.5	42	15	10.37	51.63
TL-SHHW-1548-L	962	16.5	48	15	11.72	56.42
TL-SHHW-1554-L	1007	16.5	54	15	13.07	61.21
TL-SHHW-1560-L	1100	16.5	60	15	14.43	66
TL-SHHW-1566-L	1143	16.5	66	15	15.78	70.79
TL-SHHW-1572-L	1188	16.5	72	15	17.13	75.58

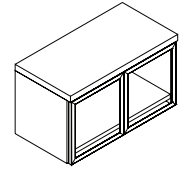

1.5" Wall-Mounted Hinged-Door Hutch w/Acrylic Doors

How to Specify:

Each laminate comes with matching vinyl trim color unless otherwise specified on your purchase order. Refer to the laminate finish card for details.

Notes:

Number of Openings and Doors per Hutch										
width(in)	30	36	42	48	54	60	66	72	78	84
openings	1	1	2	2	2	2	2	2	2	2
doors	2	2	3	3	3	4	4	4	4	4

Acrylic doors do not have locks and keys.

Install wall-mounted overheads directly onto permanent studs. Please refer to installation instructions.

Options:

laminate color

edge profile

metal color (for acrylic door frame)

acrylic color (door)

Code	Price	H	W	D	Volume (ft ³)	Weight (lb)
T-SHHW-1530-G	1572	17	30	15	4.43	46.9
T-SHHW-1536-G	1700	17	36	15	5.31	52.99
T-SHHW-1542-G	1966	17	42	15	6.2	59.08
T-SHHW-1548-G	2094	17	48	15	7.08	65.17
T-SHHW-1554-G	2274	17	54	15	7.97	71.26
T-SHHW-1560-G	2555	17	60	15	8.85	77.35
T-SHHW-1566-G	2681	17	66	15	9.74	83.44
T-SHHW-1572-G	2811	17	72	15	10.63	89.53

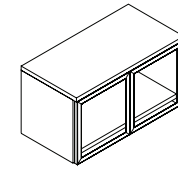

1" Wall-Mounted Hinged-Door Hutch w/Acrylic Doors

How to Specify:

Each laminate comes with matching vinyl trim color unless otherwise specified on your purchase order. Refer to the laminate finish card for details.

Notes:

Number of Openings and Doors per Hutch										
width(in)	30	36	42	48	54	60	66	72	78	84
openings	1	1	2	2	2	2	2	2	2	2
doors	2	2	3	3	3	4	4	4	4	4

Acrylic doors do not have locks and keys.

Install wall-mounted overheads directly onto permanent studs. Please refer to installation instructions.

Options:

laminate color

metal color (for acrylic door frame)

acrylic color (door)

Code	Price	H	W	D	Volume (ft ³)	Weight (lb)
TL-SHHW-1530-G	1534	16.5	30	15	7.67	42.05
TL-SHHW-1536-G	1657	16.5	36	15	9.02	46.84
TL-SHHW-1542-G	1913	16.5	42	15	10.37	51.63
TL-SHHW-1548-G	2038	16.5	48	15	11.72	56.42
TL-SHHW-1554-G	2210	16.5	54	15	13.07	61.21
TL-SHHW-1560-G	2484	16.5	60	15	14.43	66
TL-SHHW-1566-G	2604	16.5	66	15	15.78	70.79
TL-SHHW-1572-G	2727	16.5	72	15	17.13	75.58



Metro Pricebook
October 2024
Tabletops

tabletops

Executive

<u>1.5" Straight Tabletop w/ Grommet</u>	172
<u>1.5" Straight Tabletop - no grommets</u>	176
<u>1.5" D-Tabletop</u>	180
<u>1.5" O-Tabletop</u>	182

Professional

<u>1" Straight Tabletop w/ Grommet</u>	174
<u>1" Straight Tabletop - no grommets</u>	178
<u>1" D-Tabletop</u>	181
<u>1" O-Tabletop</u>	183

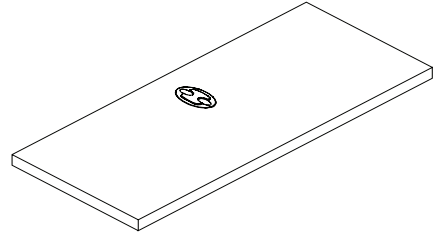

1.5" Straight Tabletop w/ Grommet

How to Specify:

Each laminate comes with matching vinyl trim color unless otherwise specified on your purchase order. Refer to the laminate finish card for details.

Notes:

1 grommet for width 48" or less
2 grommets for width 54" and wider

Options:

laminate color

edge profile

grommet color

Code	Price	H	W	D	Volume (ft ³)	Weight (lb)
UT-WS0G-1818	350	1.5	18	18	0.28	9.96
UT-WS0G-2418	370	1.5	24	18	0.38	14.28
UT-WS0G-3018	395	1.5	30	18	0.47	18.6
UT-WS0G-3618	414	1.5	36	18	0.56	22.92
UT-WS0G-4218	470	1.5	42	18	0.66	27.24
UT-WS0G-4818	496	1.5	48	18	0.75	31.56
UT-WS0G-5418	585	1.5	54	18	0.84	35.88
UT-WS0G-6018	638	1.5	60	18	0.94	40.2
UT-WS0G-6618	730	1.5	66	18	1.03	44.52
UT-WS0G-7218	772	1.5	72	18	1.13	48.84
UT-WS0G-7818	837	1.5	78	18	1.22	53.16
UT-WS0G-8418	905	1.5	84	18	1.31	57.48
UT-WS0G-9018	1034	1.5	90	18	1.41	61.8
UT-WS0G-9618	1114	1.5	96	18	1.5	66.12
UT-WS0G-1824	381	1.5	18	24	0.38	12.96
UT-WS0G-2424	401	1.5	24	24	0.5	17.28
UT-WS0G-3024	426	1.5	30	24	0.63	21.6
UT-WS0G-3624	438	1.5	36	24	0.75	25.92
UT-WS0G-4224	512	1.5	42	24	0.88	30.24
UT-WS0G-4824	550	1.5	48	24	1	34.56
UT-WS0G-5424	666	1.5	54	24	1.13	38.88

Code	Price	H	W	D	Volume (ft ³)	Weight (lb)
UT-WS0G-6024	697	1.5	60	24	1.25	43.2
UT-WS0G-6624	777	1.5	66	24	1.38	47.52
UT-WS0G-7224	811	1.5	72	24	1.5	51.84
UT-WS0G-7824	882	1.5	78	24	1.63	56.16
UT-WS0G-8424	952	1.5	84	24	1.75	60.48
UT-WS0G-9024	1084	1.5	90	24	1.88	64.8
UT-WS0G-9624	1170	1.5	96	24	2	69.12
UT-WS0G-1830	395	1.5	18	30	0.47	16.2
UT-WS0G-2430	426	1.5	24	30	0.63	21.6
UT-WS0G-3030	500	1.5	30	30	0.78	27
UT-WS0G-3630	531	1.5	36	30	0.94	32.4
UT-WS0G-4230	573	1.5	42	30	1.09	37.8
UT-WS0G-4830	620	1.5	48	30	1.25	43.2
UT-WS0G-5430	694	1.5	54	30	1.41	48.6
UT-WS0G-6030	736	1.5	60	30	1.56	54
UT-WS0G-6630	838	1.5	66	30	1.72	59.4
UT-WS0G-7230	859	1.5	72	30	1.88	64.8
UT-WS0G-7830	936	1.5	78	30	2.03	70.2
UT-WS0G-8430	1011	1.5	84	30	2.19	75.6
UT-WS0G-9030	1149	1.5	90	30	2.34	81
UT-WS0G-9630	1246	1.5	96	30	2.5	86.4
UT-WS0G-1836	414	1.5	18	36	0.56	19.44
UT-WS0G-2436	479	1.5	24	36	0.75	25.92
UT-WS0G-3036	531	1.5	30	36	0.94	32.4
UT-WS0G-3636	550	1.5	36	36	1.13	38.88
UT-WS0G-4236	598	1.5	42	36	1.31	45.36
UT-WS0G-4836	646	1.5	48	36	1.5	51.84
UT-WS0G-5436	721	1.5	54	36	1.69	58.32
UT-WS0G-6036	770	1.5	60	36	1.88	64.8
UT-WS0G-6636	876	1.5	66	36	2.06	71.28
UT-WS0G-7236	900	1.5	72	36	2.25	77.76
UT-WS0G-7836	978	1.5	78	36	2.44	84.24
UT-WS0G-8436	1057	1.5	84	36	2.63	90.72
UT-WS0G-9036	1202	1.5	90	36	2.81	97.2
UT-WS0G-9636	1294	1.5	96	36	3	103.68

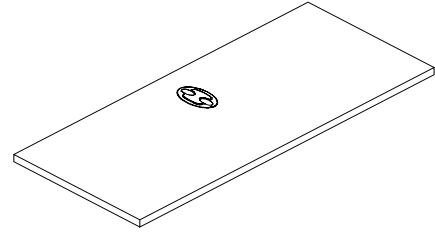

1" Straight Tabletop w/ Grommet

How to Specify:

Each laminate comes with matching vinyl trim color unless otherwise specified on your purchase order. Refer to the laminate finish card for details.

Notes:

1 grommet for width 48" or less
2 grommets for width 54" and wider

Options:

laminate color

grommet color

Code	Price	H	W	D	Volume (ft ³)	Weight (lb)
U-WS0G-1818	261	1	18	18	0.19	6.64
U-WS0G-2418	275	1	24	18	0.25	9.52
U-WS0G-3018	295	1	30	18	0.31	12.4
U-WS0G-3618	305	1	36	18	0.38	15.28
U-WS0G-4218	348	1	42	18	0.44	18.16
U-WS0G-4818	364	1	48	18	0.5	21.04
U-WS0G-5418	435	1	54	18	0.57	23.92
U-WS0G-6018	473	1	60	18	0.63	26.8
U-WS0G-6618	537	1	66	18	0.69	29.68
U-WS0G-7218	572	1	72	18	0.75	32.56
U-WS0G-7818	619	1	78	18	0.82	35.44
U-WS0G-8418	669	1	84	18	0.88	38.32
U-WS0G-9018	760	1	90	18	0.94	41.2
U-WS0G-9618	826	1	96	18	1	44.08
U-WS0G-1824	280	1	18	24	0.25	8.64
U-WS0G-2424	296	1	24	24	0.33	11.52
U-WS0G-3024	316	1	30	24	0.41	14.4
U-WS0G-3624	324	1	36	24	0.5	17.28
U-WS0G-4224	381	1	42	24	0.59	20.16
U-WS0G-4824	409	1	48	24	0.67	23.04
U-WS0G-5424	492	1	54	24	0.75	25.92
U-WS0G-6024	514	1	60	24	0.83	28.8

Code	Price	H	W	D	Volume (ft ³)	Weight (lb)
U-WS0G-6624	575	1	66	24	0.92	31.68
U-WS0G-7224	601	1	72	24	1	34.56
U-WS0G-7824	652	1	78	24	1.09	37.44
U-WS0G-8424	706	1	84	24	1.17	40.32
U-WS0G-9024	800	1	90	24	1.25	43.2
U-WS0G-9624	869	1	96	24	1.33	46.08
U-WS0G-1830	295	1	18	30	0.31	10.8
U-WS0G-2430	316	1	24	30	0.42	14.4
U-WS0G-3030	370	1	30	30	0.52	18
U-WS0G-3630	389	1	36	30	0.63	21.6
U-WS0G-4230	426	1	42	30	0.73	25.2
U-WS0G-4830	459	1	48	30	0.83	28.8
U-WS0G-5430	513	1	54	30	0.94	32.4
U-WS0G-6030	544	1	60	30	1.04	36
U-WS0G-6630	620	1	66	30	1.15	39.6
U-WS0G-7230	637	1	72	30	1.25	43.2
U-WS0G-7830	692	1	78	30	1.36	46.8
U-WS0G-8430	746	1	84	30	1.46	50.4
U-WS0G-9030	851	1	90	30	1.57	54
U-WS0G-9630	921	1	96	30	1.67	57.6
U-WS0G-1836	305	1	18	36	0.37	12.96
U-WS0G-2436	359	1	24	36	0.5	17.28
U-WS0G-3036	389	1	30	36	0.62	21.6
U-WS0G-3636	409	1	36	36	0.75	25.92
U-WS0G-4236	443	1	42	36	0.88	30.24
U-WS0G-4836	479	1	48	36	1	34.56
U-WS0G-5436	536	1	54	36	1.13	38.88
U-WS0G-6036	568	1	60	36	1.25	43.2
U-WS0G-6636	646	1	66	36	1.38	47.52
U-WS0G-7236	666	1	72	36	1.5	51.84
U-WS0G-7836	721	1	78	36	1.63	56.16
U-WS0G-8436	783	1	84	36	1.75	60.48
U-WS0G-9036	894	1	90	36	1.88	64.8
U-WS0G-9636	957	1	96	36	2	69.12

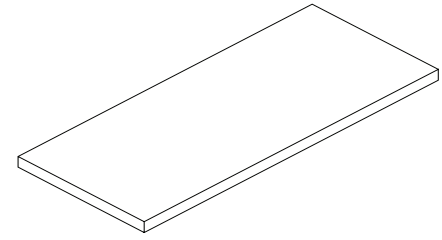

1.5" Straight Tabletop

How to Specify:

Each laminate comes with matching vinyl trim color unless otherwise specified on your purchase order. Refer to the laminate finish card for details.

Notes:

Options:

laminate color

edge profile

Code	Price	H	W	D	Volume (ft ³)	Weight (lb)
UT-WS0N-1818	319	1.5	18	18	0.28	9.96
UT-WS0N-2418	336	1.5	24	18	0.38	14.28
UT-WS0N-3018	363	1.5	30	18	0.47	18.6
UT-WS0N-3618	382	1.5	36	18	0.56	22.92
UT-WS0N-4218	438	1.5	42	18	0.66	27.24
UT-WS0N-4818	461	1.5	48	18	0.75	31.56
UT-WS0N-5418	561	1.5	54	18	0.84	35.88
UT-WS0N-6018	610	1.5	60	18	0.94	40.2
UT-WS0N-6618	694	1.5	66	18	1.03	44.52
UT-WS0N-7218	738	1.5	72	18	1.13	48.84
UT-WS0N-7818	800	1.5	78	18	1.22	53.16
UT-WS0N-8418	872	1.5	84	18	1.31	57.48
UT-WS0N-9018	1001	1.5	90	18	1.41	61.8
UT-WS0N-9618	1079	1.5	96	18	1.5	66.12
UT-WS0N-1824	349	1.5	18	24	0.38	12.96
UT-WS0N-2424	366	1.5	24	24	0.5	17.28
UT-WS0N-3024	389	1.5	30	24	0.63	21.6
UT-WS0N-3624	407	1.5	36	24	0.75	25.92
UT-WS0N-4224	479	1.5	42	24	0.88	30.24
UT-WS0N-4824	522	1.5	48	24	1	34.56
UT-WS0N-5424	632	1.5	54	24	1.13	38.88
UT-WS0N-6024	667	1.5	60	24	1.25	43.2

Code	Price	H	W	D	Volume (ft ³)	Weight (lb)
UT-WS0N-6624	742	1.5	66	24	1.38	47.52
UT-WS0N-7224	779	1.5	72	24	1.5	51.84
UT-WS0N-7824	849	1.5	78	24	1.63	56.16
UT-WS0N-8424	921	1.5	84	24	1.75	60.48
UT-WS0N-9024	1053	1.5	90	24	1.88	64.8
UT-WS0N-9624	1143	1.5	96	24	2	69.12
UT-WS0N-1830	361	1.5	18	30	0.47	16.2
UT-WS0N-2430	389	1.5	24	30	0.63	21.6
UT-WS0N-3030	470	1.5	30	30	0.78	27
UT-WS0N-3630	500	1.5	36	30	0.94	32.4
UT-WS0N-4230	540	1.5	42	30	1.09	37.8
UT-WS0N-4830	585	1.5	48	30	1.25	43.2
UT-WS0N-5430	666	1.5	54	30	1.41	48.6
UT-WS0N-6030	703	1.5	60	30	1.56	54
UT-WS0N-6630	803	1.5	66	30	1.72	59.4
UT-WS0N-7230	831	1.5	72	30	1.88	64.8
UT-WS0N-7830	905	1.5	78	30	2.03	70.2
UT-WS0N-8430	983	1.5	84	30	2.19	75.6
UT-WS0N-9030	1117	1.5	90	30	2.34	81
UT-WS0N-9630	1209	1.5	96	30	2.5	86.4
UT-WS0N-1836	381	1.5	18	36	0.56	19.44
UT-WS0N-2436	445	1.5	24	36	0.75	25.92
UT-WS0N-3036	500	1.5	30	36	0.94	32.4
UT-WS0N-3636	520	1.5	36	36	1.13	38.88
UT-WS0N-4236	567	1.5	42	36	1.31	45.36
UT-WS0N-4836	613	1.5	48	36	1.5	51.84
UT-WS0N-5436	694	1.5	54	36	1.69	58.32
UT-WS0N-6036	735	1.5	60	36	1.88	64.8
UT-WS0N-6636	843	1.5	66	36	2.06	71.28
UT-WS0N-7236	871	1.5	72	36	2.25	77.76
UT-WS0N-7836	946	1.5	78	36	2.44	84.24
UT-WS0N-8436	1026	1.5	84	36	2.63	90.72
UT-WS0N-9036	1168	1.5	90	36	2.81	97.2
UT-WS0N-9636	1260	1.5	96	36	3	103.68

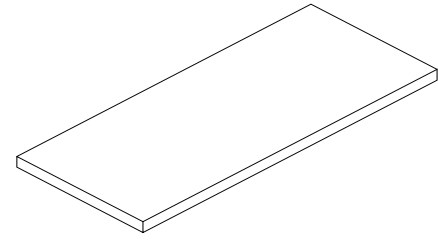

1" Straight Tabletop

How to Specify:

Each laminate comes with matching vinyl trim color unless otherwise specified on your purchase order. Refer to the laminate finish card for details.

Notes:

Options:

laminate color

Code	Price	H	W	D	Volume (ft ³)	Weight (lb)
U-WS0N-1818	237	1	18	18	0.19	6.64
U-WS0N-2418	248	1	24	18	0.25	9.52
U-WS0N-3018	271	1	30	18	0.31	12.4
U-WS0N-3618	281	1	36	18	0.38	15.28
U-WS0N-4218	324	1	42	18	0.44	18.16
U-WS0N-4818	340	1	48	18	0.5	21.04
U-WS0N-5418	412	1	54	18	0.57	23.92
U-WS0N-6018	451	1	60	18	0.63	26.8
U-WS0N-6618	513	1	66	18	0.69	29.68
U-WS0N-7218	546	1	72	18	0.75	32.56
U-WS0N-7818	597	1	78	18	0.82	35.44
U-WS0N-8418	644	1	84	18	0.88	38.32
U-WS0N-9018	741	1	90	18	0.94	41.2
U-WS0N-9618	799	1	96	18	1	44.08
U-WS0N-1824	259	1	18	24	0.25	8.64
U-WS0N-2424	272	1	24	24	0.33	11.52
U-WS0N-3024	294	1	30	24	0.41	14.4
U-WS0N-3624	299	1	36	24	0.5	17.28
U-WS0N-4224	359	1	42	24	0.59	20.16
U-WS0N-4824	385	1	48	24	0.67	23.04
U-WS0N-5424	470	1	54	24	0.75	25.92
U-WS0N-6024	496	1	60	24	0.83	28.8
U-WS0N-6624	548	1	66	24	0.92	31.68
U-WS0N-7224	576	1	72	24	1	34.56
U-WS0N-7824	631	1	78	24	1.09	37.44

Code	Price	H	W	D	Volume (ft ³)	Weight (lb)
U-WS0N-8424	683	1	84	24	1.17	40.32
U-WS0N-9024	782	1	90	24	1.25	43.2
U-WS0N-9624	846	1	96	24	1.33	46.08
U-WS0N-6624	548	1	66	24	0.92	31.68
U-WS0N-7224	576	1	72	24	1	34.56
U-WS0N-7824	631	1	78	24	1.09	37.44
U-WS0N-8424	683	1	84	24	1.17	40.32
U-WS0N-9024	782	1	90	24	1.25	43.2
U-WS0N-9624	846	1	96	24	1.33	46.08
U-WS0N-1830	270	1	18	30	0.31	10.8
U-WS0N-2430	294	1	24	30	0.42	14.4
U-WS0N-3030	348	1	30	30	0.52	18
U-WS0N-3630	370	1	36	30	0.63	21.6
U-WS0N-4230	403	1	42	30	0.73	25.2
U-WS0N-4830	435	1	48	30	0.83	28.8
U-WS0N-5430	492	1	54	30	0.94	32.4
U-WS0N-6030	520	1	60	30	1.04	36
U-WS0N-6630	598	1	66	30	1.15	39.6
U-WS0N-7230	614	1	72	30	1.25	43.2
U-WS0N-7830	669	1	78	30	1.36	46.8
U-WS0N-8430	726	1	84	30	1.46	50.4
U-WS0N-9030	831	1	90	30	1.57	54
U-WS0N-9630	899	1	96	30	1.68	57.6
U-WS0N-1836	284	1	18	36	0.37	12.96
U-WS0N-2436	336	1	24	36	0.5	17.28
U-WS0N-3036	370	1	30	36	0.62	21.6
U-WS0N-3636	386	1	36	36	0.75	25.92
U-WS0N-4236	419	1	42	36	0.88	30.24
U-WS0N-4836	457	1	48	36	1	34.56
U-WS0N-5436	513	1	54	36	1.13	38.88
U-WS0N-6036	547	1	60	36	1.25	43.2
U-WS0N-6636	626	1	66	36	1.38	47.52
U-WS0N-7236	642	1	72	36	1.5	51.84
U-WS0N-7836	697	1	78	36	1.63	56.16
U-WS0N-8436	759	1	84	36	1.75	60.48
U-WS0N-9036	869	1	90	36	1.88	64.8
U-WS0N-9636	936	1	96	36	2	69.12

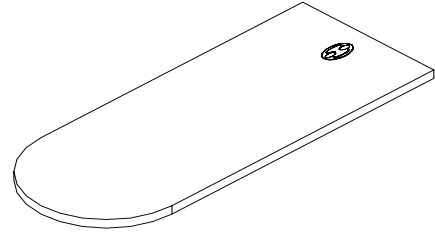

How to Specify:

Each laminate comes with matching vinyl trim color unless otherwise specified on your purchase order. Refer to the laminate finish card for details.

Options:

laminate color

edge profile

grommet color

Code	Price	H	W	D	Volume (ft³)	Weight (lb)
UT-WDTG-6024	869	1.5	60	24	1.25	41.18
UT-WDTG-6624	1021	1.5	66	24	1.38	45.35
UT-WDTG-7224	1100	1.5	72	24	1.5	49.51
UT-WDTG-7824	1268	1.5	78	24	1.63	53.67
UT-WDTG-8424	1328	1.5	84	24	1.75	57.83
UT-WDTG-6030	959	1.5	60	30	1.56	47.45
UT-WDTG-6630	1128	1.5	66	30	1.72	52.31
UT-WDTG-7230	1216	1.5	72	30	1.88	57.17
UT-WDTG-7830	1406	1.5	78	30	2.03	62.03
UT-WDTG-8430	1473	1.5	84	30	2.19	66.89
UT-WDTG-6036	1057	1.5	60	36	1.88	58.61
UT-WDTG-6636	1238	1.5	66	36	2.06	64.16
UT-WDTG-7236	1331	1.5	72	36	2.25	69.71
UT-WDTG-7836	1536	1.5	78	36	2.44	75.26
UT-WDTG-8436	1617	1.5	84	36	2.63	80.81

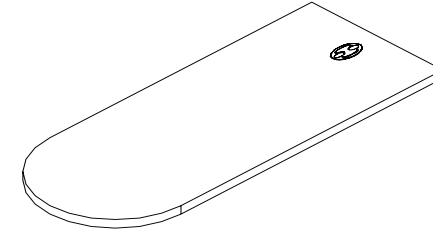

How to Specify:

Each laminate comes with matching vinyl trim color unless otherwise specified on your purchase order. Refer to the laminate finish card for details.

Options:

laminate color

grommet color

Code	Price	H	W	D	Volume (ft³)	Weight (lb)
U-WDTG-6024	721	1	60	24	0.83	27.46
U-WDTG-6624	849	1	66	24	0.92	30.23
U-WDTG-7224	881	1	72	24	1	33.01
U-WDTG-7824	1059	1	78	24	1.09	35.78
U-WDTG-8424	1111	1	84	24	1.17	38.56
U-WDTG-6030	799	1	60	30	1.04	31.64
U-WDTG-6630	941	1	66	30	1.15	34.88
U-WDTG-7230	1013	1	72	30	1.25	38.11
U-WDTG-7830	1168	1	78	30	1.36	41.35
U-WDTG-8430	1226	1	84	30	1.46	44.59
U-WDTG-6036	877	1	60	36	1.25	39.07
U-WDTG-6636	1037	1	66	36	1.38	42.77
U-WDTG-7236	1114	1	72	36	1.5	46.47
U-WDTG-7836	1280	1	78	36	1.63	50.17
U-WDTG-8436	1349	1	84	36	1.75	53.87

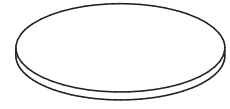

How to Specify:

Each laminate comes with matching vinyl trim color unless otherwise specified on your purchase order. Refer to the laminate finish card for details.

Options:

laminate color

edge profile (for o-tabletop)

Code	Price	H	W	D	Volume (ft ³)	Weight (lb)
T-WOXX-24	474	1.5	24	24	0.5	32.4
T-WOXX-30	474	1.5	30	30	0.78	40.5
T-WOXX-36	474	1.5	36	36	1.13	39.76
T-WOXX-42	607	1.5	42	42	1.53	54.11
T-WOXX-48	685	1.5	48	48	2	70.68
T-WOXX-54	770	1.5	54	54	2.53	72.9
T-WOXX-60	851	1.5	60	60	3.13	81

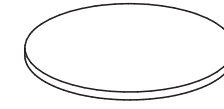

How to Specify:

Each laminate comes with matching vinyl trim color unless otherwise specified on your purchase order. Refer to the laminate finish card for details.

laminate color

Code	Price	H	W	D	Volume (ft ³)	Weight (lb)
TL-WOXX-24	379	1	24	24	1.2	32.4
TL-WOXX-30	409	1	30	30	1.5	40.5
TL-WOXX-36	449	1	36	36	4.63	26.5
TL-WOXX-42	573	1	42	42	6.12	36.07
TL-WOXX-48	642	1	48	48	7.82	47.12
TL-WOXX-54	721	1	54	54	2.7	72.9
TL-WOXX-60	793	1	60	60	3	81



Metro Pricebook
October 2024

Bases

bases

<u>cross base</u>	186
<u>post support base</u>	187
<u>open metal gable</u>	188

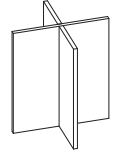

Cross base

Notes:

4 post supports required for each o-tabletop.

Options:

laminat color

Code	Price	H	W	D	Volume (ft ³)	Weight (lb)
T-B6-30	438	28	18	18	7.63	24.99
T-B6-36	438	28	24	24	14.52	33.64
T-B6-42	454	28	30	30	21.41	42.29
T-B6-48	484	28	36	36	29.63	49.23
T-B6-54	498	28	42	42	37.85	56.17
T-B6-60	525	28	48	48	46.07	63.11



Post Support Base

Notes:

4 post supports required for each o-tabletop.

Options:

metal color (for post support)

Code	Price	H	W	D	Volume (ft ³)	Weight (lb)
TB-BASE-1	381	28	3	3	0.85	7

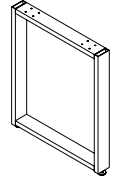

Open Metal Gable

Options:

metal color (for gables)

Code	Price	H	W	D	Volume (ft ³)	Weight (lb)
U-CG0M-12	395	28	12	0.3	0.58	6
U-CG0M-18	449	28	18	0.4	0.88	10
U-CG0M-21	474	28	21	0.45	1.02	12
U-CG0M-24	501	28	24	0.5	1.17	14
U-CG0M-30	557	28	30	0.6	1.46	18
U-CG0M-36	610	28	36	0.7	1.75	22
U-CG0M-1813	286	13	18	0.4		5
U-CG0M-2413	354	13	24	0.4		7
U-CG0M-3013	361	13	30	0.4		9
U-CG0M-3613	400	13	36	0.4		11



Metro Pricebook
October 2024
Reception Unit

reception unit

executive 192

professional 193

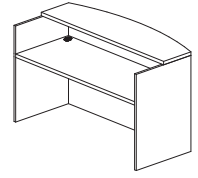

1.5" Reception Unit w/Countertop

How to Specify:

Each laminate comes with matching vinyl trim color unless otherwise specified on your purchase order. Refer to the laminate finish card for details.

Options:

laminate color

edge profile

grommet color

Code	Price	H	W	D	Volume (ft ³)	Weight (lb)
T-RC0G-7230	2237	43.5	72	30	54.38	272.25

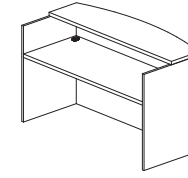

1" Reception Unit w/Countertop

How to Specify:

Each laminate comes with matching vinyl trim color unless otherwise specified on your purchase order. Refer to the laminate finish card for details.

Options:

laminate color

grommet color

Code	Price	H	W	D	Volume (ft ³)	Weight (lb)
TL-RC0G-7230	1997	43	72	30	53.75	228.15



Metro Pricebook
October 2024

Service Write Up Desk

service write up desk

Executive

w/ Straight Front Countertop 196

w/ Arc Countertop 198

Professional

w/ Straight Front Countertop 197

w/ Arc Countertop 199

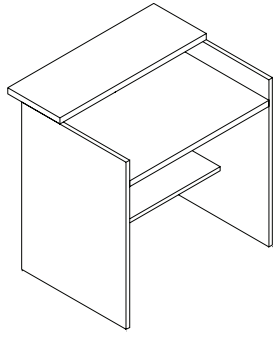

1.5" Service Write Up Desk w/ Straight Countertop

How to Specify:

Each laminate comes with matching vinyl trim color unless otherwise specified on your purchase order. Refer to the laminate finish card for details.

Options:

laminate color

edge profile

Code	Price	H	W	D	Volume (ft ³)	Weight (lb)
T-RCWG-3030-S	1741	43	30	30	25.46	94
T-RCWG-3630-S	1833	43	36	30	30.55	97
T-RCWG-4230-S	1938	43	42	30	35.64	100
T-RCWG-4830-S	2038	43	48	30	40.73	103
T-RCWG-5430-S	2118	43	54	30	45.82	106
T-RCWG-6030-S	2201	43	60	30	50.91	109
T-RCWG-6630-S	2280	43	66	30	56	112
T-RCWG-7230-S	2397	43	72	30	61.09	115
T-RCWG-7830-S	2505	43	78	30	66.18	118
T-RCWG-8430-S	2609	43	84	30	71.28	121

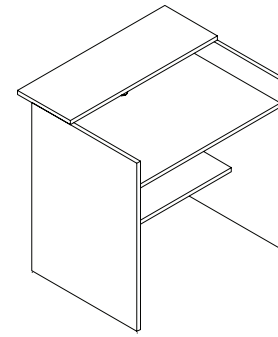

1" Service Write Up Desk w/ Straight Countertop

How to Specify:

Each laminate comes with matching vinyl trim color unless otherwise specified on your purchase order. Refer to the laminate finish card for details.

Options:

laminate color

Code	Price	H	W	D	Volume (ft ³)	Weight (lb)
TL-RCWG-3030-S	1625	43	30	30	22.4	88
TL-RCWG-3630-S	1741	43	36	30	26.88	91
TL-RCWG-4230-S	1822	43	42	30	31.35	94
TL-RCWG-4830-S	1902	43	48	30	35.83	97
TL-RCWG-5430-S	1985	43	54	30	40.31	100
TL-RCWG-6030-S	2065	43	60	30	44.79	103
TL-RCWG-6630-S	2147	43	66	30	49.27	106
TL-RCWG-7230-S	2261	43	72	30	53.75	109
TL-RCWG-7830-S	2410	43	78	30	58.23	112
TL-RCWG-8430-S	2493	43	84	30	62.71	115

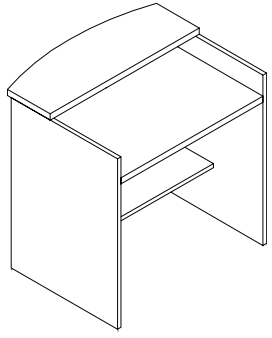

1.5" Service Write Up Desk w/ Arc Countertop

How to Specify:

Each laminate comes with matching vinyl trim color unless otherwise specified on your purchase order. Refer to the laminate finish card for details.

Options:

laminate color

edge profile

Code	Price	H	W	D	Volume (ft ³)	Weight (lb)
T-RCWG-3030-A	1948	43	30	30	25.46	94
T-RCWG-3630-A	2010	43	36	30	30.55	97
T-RCWG-4230-A	2101	43	42	30	35.64	100
T-RCWG-4830-A	2202	43	48	30	40.73	103
T-RCWG-5430-A	2230	43	54	30	45.82	106
T-RCWG-6030-A	2438	43	60	30	50.91	109
T-RCWG-6630-A	2519	43	66	30	56	112
T-RCWG-7230-A	2615	43	72	30	61.09	115
T-RCWG-7830-A	2764	43	78	30	66.18	118
T-RCWG-8430-A	2868	43	84	30	71.28	121

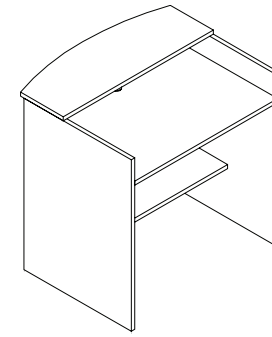

1" Service Write Up Desk w/ Arc Countertop

How to Specify:

Each laminate comes with matching vinyl trim color unless otherwise specified on your purchase order. Refer to the laminate finish card for details.

Options:

laminate color

Code	Price	H	W	D	Volume (ft ³)	Weight (lb)
TL-RCWG-3030-A	1749	43	30	30	22.4	88
TL-RCWG-3630-A	1830	43	36	30	26.88	91
TL-RCWG-4230-A	1910	43	42	30	31.35	94
TL-RCWG-4830-A	1991	43	48	30	35.83	97
TL-RCWG-5430-A	2073	43	54	30	40.31	100
TL-RCWG-6030-A	2171	43	60	30	44.79	103
TL-RCWG-6630-A	2236	43	66	30	49.27	106
TL-RCWG-7230-A	2351	43	72	30	53.75	109
TL-RCWG-7830-A	2493	43	78	30	58.23	112
TL-RCWG-8430-A	2615	43	84	30	62.71	115



Metro Pricebook
October 2024

Coffee & End Tables

coffee and end tables

Executive

coffee and end table 202

Professional

coffee and end table 203

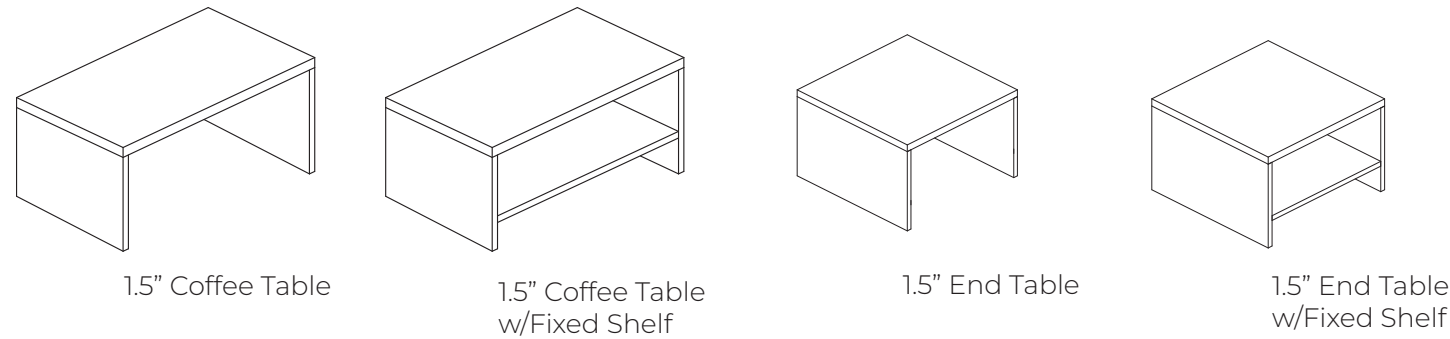

How to Specify:

Each laminate comes with matching vinyl trim color unless otherwise specified on your purchase order. Refer to the laminate finish card for details.

Options:

laminate color

edge profile

Code	Price	H	W	D	Volume (ft ³)	Weight (lb)
Coffee Table						
T-TCT0-362017	470	17.5	36	20	7.29	48.6
T-TCT0-422017	501	17.5	42	20	8.51	53.93
T-TCT0-482017	541	17.5	48	20	9.72	59.26
Coffee Table w/Fixed Shelf						
T-TCTS-362017	575	17.5	36	20	7.29	66.3
T-TCTS-422017	607	17.5	42	20	8.51	74.25
T-TCTS-482017	649	17.5	48	20	9.72	82.2
End Table						
T-TCT0-202019	438	19.5	20	20	4.51	35.7
T-TCT0-242419	492	19.5	24	24	6.5	47.03
T-TCT0-303019	607	19.5	30	30	10.16	58.36
End Table w/Fixed Shelf						
T-TCTS-202019	541	19.5	20	20	4.51	51.36
T-TCTS-242419	598	19.5	24	24	6.5	62.87
T-TCTS-303019	714	19.5	30	30	10.16	78.65

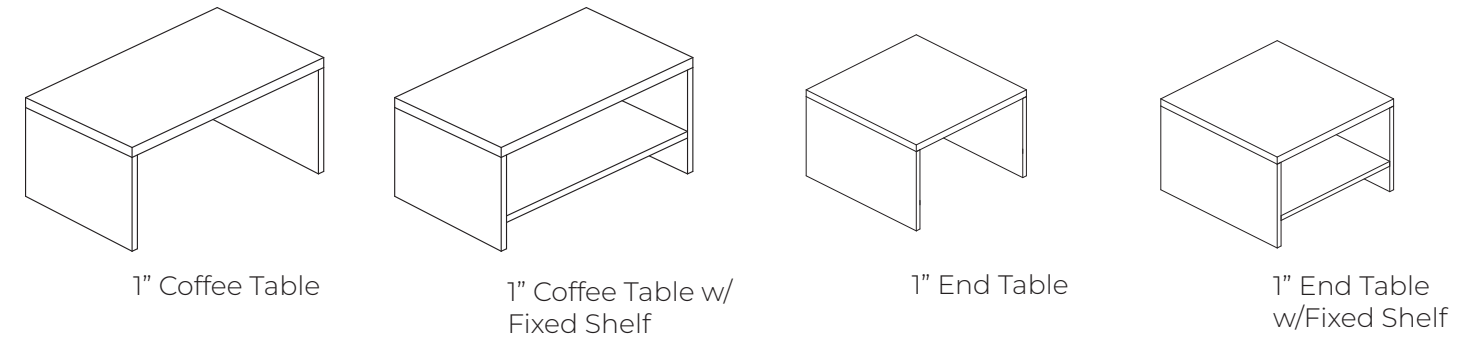

How to Specify:

Each laminate comes with matching vinyl trim color unless otherwise specified on your purchase order. Refer to the laminate finish card for details.

Options:

laminate color

Code	Price	H	W	D	Volume (ft ³)	Weight (lb)
Coffee Table						
TL-TCT0-362017	421	17	36	20	7.08	39.45
TL-TCT0-422017	453	17	42	20	8.26	43.02
TL-TCT0-482017	497	17	48	20	9.44	46.59
Coffee Table w/Fixed Shelf						
TL-TCTS-362017	528	17	36	20	7.08	56.7
TL-TCTS-362017	528	17	36	20	7.08	56.7
TL-TCTS-362017	528	17	36	20	7.08	56.7
End Table						
TL-TCT0-202019	387	19	20	20	4.4	30.66
TL-TCT0-242419	444	19	24	24	6.33	39.3
TL-TCT0-303019	562	19	30	30	9.9	47.94
End Table w/Fixed Shelf						
TL-TCTS-202019	497	19	20	20	4.4	40.03
TL-TCTS-242419	548	19	24	24	6.33	53.05
TL-TCTS-303019	666	19	30	30	9.9	69.81



Metro Pricebook
October 2024
Conference

conference

table top	208
straight tabletop	208
straight tabletop w/power and data	210
boat-shaped tabletop	212
boat-shaped tabletop w/power and data	214
racetrack tabletop	216
racetrack tabletop w/power and data	218
tapered tabletop	220
tapered tabletop w/ power and data	221
table base	222
gable & modesty base	222
elliptical base	226
table base configuration	230
options	231
Ellora Grommet add-ons	231
filing and storage	232
serving cabinet	232
storage cabinet w/shelves	233
combo cabinet w/storage & lateral files	234
double door cabinet w/shelves	235
combo cabinet	236
storage cabinet w/coat bar and shelves	237
presentation tools	238
whiteboard cabinet	238
computer desk	239

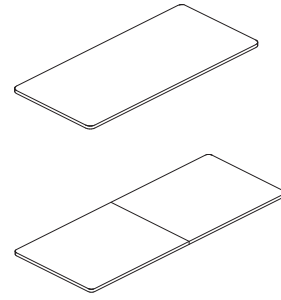

1.5" Straight Tabletop

How to Specify:

Each laminate comes with matching vinyl trim color unless otherwise specified on your purchase order. Refer to the laminate finish card for details.

Notes:

Tabletops 72"-96"W are configured in one-piece top.

Tabletops 108"-192"W are configured in two-piece tops.

Tabletops 204"-240"W are configured in three-piece tops.

Options:

laminate color

edge profile

Code	Price	H	W	D	Volume (ft ³)	Weight (lb)
TB-MSSX-7236	791	1.5	72	36	2.25	89.91
TB-MSSX-7242	990	1.5	72	42	2.62	104.92
TB-MSSX-8436	909	1.5	84	36	2.62	104.92
TB-MSSX-8442	1076	1.5	84	42	3.06	122.43
TB-MSSX-8448	1146	1.5	84	48	3.5	139.93
TB-MSSX-9636	992	1.5	96	36	3	119.93
TB-MSSX-9642	1164	1.5	96	42	3.5	139.93
TB-MSSX-9648	1203	1.5	96	48	4	159.94
TB-MSSX-10848	1441	1.5	108	48	4.49	179.76
TB-MSSX-10854	1704	1.5	108	54	5.05	202.27
TB-MSSX-10860	1733	1.5	108	60	5.62	224.78
TB-MSSX-12048	1575	1.5	120	48	4.99	199.77
TB-MSSX-12054	1861	1.5	120	54	5.62	224.78
TB-MSSX-12060	1890	1.5	120	60	6.24	249.79
TB-MSSX-13248	1706	1.5	132	48	5.49	219.78
TB-MSSX-13254	2020	1.5	132	54	6.18	247.29

Code	Price	H	W	D	Volume (ft ³)	Weight (lb)
TB-MSSX-13260	2050	1.5	132	60	6.87	274.8
TB-MSSX-14448	1839	1.5	144	48	5.99	239.78
TB-MSSX-14454	2180	1.5	144	54	6.74	269.8
TB-MSSX-14460	2210	1.5	144	60	7.49	299.81
TB-MSSX-15648	1975	1.5	156	48	6.49	259.69
TB-MSSX-15654	2342	1.5	156	54	7.3	292.3
TB-MSSX-15660	2369	1.5	156	60	8.12	324.82
TB-MSSX-16848	2312	1.5	168	48	6.99	279.8
TB-MSSX-16854	2498	1.5	168	54	7.87	314.81
TB-MSSX-16860	2527	1.5	168	60	8.74	349.83
TB-MSSX-18048	2345	1.5	180	48	7.49	299.81
TB-MSSX-18054	2657	1.5	180	54	8.43	337.32
TB-MSSX-18060	2689	1.5	180	60	9.37	374.84
TB-MSSX-19248	2371	1.5	192	48	7.99	319.82
TB-MSSX-19254	2819	1.5	192	54	8.99	359.83
TB-MSSX-19260	2846	1.5	192	60	9.99	399.85
TB-MSSX-20448	2631	1.5	204	48	8.49	339.63
TB-MSSX-20454	3116	1.5	204	54	9.55	382.15
TB-MSSX-20460	3159	1.5	204	60	10.61	424.67
TB-MSSX-21648	2762	1.5	216	48	8.99	359.64
TB-MSSX-21654	3274	1.5	216	54	10.11	404.66
TB-MSSX-21660	3319	1.5	216	60	11.24	449.68
TB-MSSX-22848	2896	1.5	228	48	9.49	379.65
TB-MSSX-22854	3434	1.5	228	54	10.67	427.17
TB-MSSX-22860	3477	1.5	228	60	11.86	474.69
TB-MSSX-24048	3237	1.5	240	48	9.99	399.66
TB-MSSX-24054	3592	1.5	240	54	11.24	449.68
TB-MSSX-24060	3637	1.5	240	60	12.49	499.7
TB-MSSX-22860	3477	1.5	228	60	11.86	474.69
TB-MSSX-24048	3237	1.5	240	48	9.99	399.66
TB-MSSX-24054	3592	1.5	240	54	11.24	449.68
TB-MSSX-24060	3637	1.5	240	60	12.49	499.7

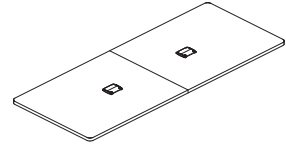

1.5" Straight Tabletop w/Power and Data

How to Specify:

Each laminate comes with matching vinyl trim color unless otherwise specified on your purchase order. Refer to the laminate finish card for details.

Notes:

Tabletops 72"-96"W are configured in one-piece top.
 Tabletops 108"-192"W are configured in two-piece tops.
 Tabletops 204"-240"W are configured in three-piece tops.
 Single-piece tabletops are equipped with one power and data grommet, two-piece tabletops are equipped with two power and data grommets, and three-piece tabletops are equipped with three power and data grommets.
 Two power and dual USB-A receptacles with 3 open slots to accommodate RJ11, RJ45, HDMI, VGA or Stereo. Items for 3 open slots must be specified and purchased separately.
 Boardroom tables with tops comprised of 2 or more pieces will not have a consistent grain pattern.

Options:

laminate color

edge profile

grommet color (for tabletops with power and data)

Code	Price	H	W	D	Volume (ft ³)	Weight (lb)
TB-MSSP-7236	1882	1.5	72	36	2.2	87.99
TB-MSSP-7242	2082	1.5	72	42	2.57	102.99
TB-MSSP-8436	2002	1.5	84	36	2.57	102.99
TB-MSSP-8442	2168	1.5	84	42	3.01	120.5
TB-MSSP-8448	2240	1.5	84	48	3.45	138.01
TB-MSSP-9636	2086	1.5	96	36	2.95	118
TB-MSSP-9642	2257	1.5	96	42	3.45	138.01
TB-MSSP-9648	2296	1.5	96	48	3.95	158.01
TB-MSSP-10848	3625	1.5	108	48	4.43	178.17
TB-MSSP-10854	3889	1.5	108	54	4.49	200.68
TB-MSSP-10860	3919	1.5	108	60	5.56	223.19
TB-MSSP-12048	3757	1.5	120	48	4.93	198.18
TB-MSSP-12054	4047	1.5	120	54	5.56	223.19
TB-MSSP-12060	4074	1.5	120	60	6.18	248.2
TB-MSSP-13248	3890	1.5	132	48	5.43	218.19

Code	Price	H	W	D	Volume (ft ³)	Weight (lb)
TB-MSSP-13254	4205	1.5	132	54	6.12	245.7
TB-MSSP-13260	4232	1.5	132	60	6.81	273.21
TB-MSSP-14448	4024	1.5	144	48	5.93	238.19
TB-MSSP-14454	4364	1.5	144	54	6.68	268.21
TB-MSSP-14460	4394	1.5	144	60	7.43	298.22
TB-MSSP-15648	4157	1.5	156	48	6.43	258.2
TB-MSSP-15654	4523	1.5	156	54	7.24	290.72
TB-MSSP-15660	4554	1.5	156	60	8.06	323.23
TB-MSSP-16848	4499	1.5	168	48	6.93	278.21
TB-MSSP-16854	4682	1.5	168	54	7.81	313.22
TB-MSSP-16860	4712	1.5	168	60	8.68	348.24
TB-MSSP-18048	4526	1.5	180	48	7.43	298.22
TB-MSSP-18054	4840	1.5	180	54	8.37	335.73
TB-MSSP-18060	4871	1.5	180	60	9.31	373.25
TB-MSSP-19248	4557	1.5	192	48	7.93	318.23
TB-MSSP-19254	5001	1.5	192	54	8.93	358.24
TB-MSSP-19260	5029	1.5	192	60	9.93	398.26
TB-MSSP-20448	5904	1.5	204	48	8.4	337.25
TB-MSSP-20454	6392	1.5	204	54	9.46	379.77
TB-MSSP-20460	6435	1.5	204	60	10.52	422.28
TB-MSSP-21648	6038	1.5	216	48	8.9	357.26
TB-MSSP-21654	6551	1.5	216	54	10.02	402.28
TB-MSSP-21660	6592	1.5	216	60	11.15	447.29
TB-MSSP-22848	6169	1.5	228	48	9.4	377.27
TB-MSSP-22854	6709	1.5	228	54	10.58	424.79
TB-MSSP-22860	6751	1.5	228	60	11.77	472.3
TB-MSSP-24048	6513	1.5	240	48	9.9	397.27
TB-MSSP-24054	6869	1.5	240	54	11.15	447.29
TB-MSSP-24060	6911	1.5	240	60	12.4	497.31



1.5" Boat-Shaped Tabletop

How to Specify:

Each laminate comes with matching vinyl trim color unless otherwise specified on your purchase order. Refer to the laminate finish card for details.

Notes:

- Tabletops 72"-96"W are configured in one-piece top.
- Tabletops 108"-192"W are configured in two-piece tops.
- Tabletops 204"-240"W are configured in three-piece tops.

Options:

laminate color

edge profile

Code	Price	H	W	D	Volume (ft ³)	Weight (lb)
TB-MBBX-7236	791	1.5	72	36	2	80.81
TB-MBBX-7242	990	1.5	72	42	2.38	95.09
TB-MBBX-8436	909	1.5	84	36	2.33	93.4
TB-MBBX-8442	1076	1.5	84	42	2.77	110.91
TB-MBBX-8448	1146	1.5	84	48	3.21	128.42
TB-MBBX-9636	992	1.5	96	36	2.67	106.72
TB-MBBX-9642	1164	1.5	96	42	3.17	126.73
TB-MBBX-9648	1203	1.5	96	48	3.67	146.74
TB-MBBX-10848	1441	1.5	108	48	4.12	164.78
TB-MBBX-10854	1704	1.5	108	54	4.68	187.3
TB-MBBX-10860	1733	1.5	108	60	5.24	209.8
TB-MBBX-12048	1575	1.5	120	48	4.58	183.12
TB-MBBX-12054	1861	1.5	120	54	5.2	208.12
TB-MBBX-12060	1890	1.5	120	60	5.82	233.14
TB-MBBX-13248	1706	1.5	132	48	5.04	201.44
TB-MBBX-13254	2020	1.5	132	54	5.72	228.96

Code	Price	H	W	D	Volume (ft ³)	Weight (lb)
TB-MBBX-13260	2050	1.5	132	60	6.4	256.46
TB-MBBX-14448	1839	1.5	144	48	5.5	219.78
TB-MBBX-14454	2180	1.5	144	54	6.24	249.8
TB-MBBX-14460	2210	1.5	144	60	7	279.8
TB-MBBX-15648	1975	1.5	156	48	5.96	238.12
TB-MBBX-15654	2342	1.5	156	54	6.76	270.62
TB-MBBX-15660	2369	1.5	156	60	7.58	303.14
TB-MBBX-16848	2312	1.5	168	48	6.4	256.44
TB-MBBX-16854	2498	1.5	168	54	7.28	291.48
TB-MBBX-16860	2527	1.5	168	60	8.16	326.48
TB-MBBX-18048	2345	1.5	180	48	6.86	274.78
TB-MBBX-18054	2657	1.5	180	54	7.8	313.8
TB-MBBX-18060	2689	1.5	180	60	8.74	349.82
TB-MBBX-19248	2371	1.5	192	48	7.32	293.12
TB-MBBX-19254	2819	1.5	192	54	8.32	333.14
TB-MBBX-19260	2846	1.5	192	60	9.32	373.16
TB-MBBX-20448	2631	1.5	204	48	7.78	344.36
TB-MBBX-20454	3116	1.5	204	54	8.84	353.87
TB-MBBX-20460	3159	1.5	204	60	9.9	396.39
TB-MBBX-21648	2762	1.5	216	48	8.24	329.69
TB-MBBX-21654	3274	1.5	216	54	9.36	374.71
TB-MBBX-21660	3319	1.5	216	60	10.49	419.73
TB-MBBX-22848	2896	1.5	228	48	8.7	348.03
TB-MBBX-22854	3434	1.5	228	54	9.88	395.55
TB-MBBX-22860	3477	1.5	228	60	11.07	443.07
TB-MBBX-24048	3237	1.5	240	48	9.15	366.37
TB-MBBX-24054	3592	1.5	240	54	6.1	416.39
TB-MBBX-24060	3637	1.5	240	60	11.65	466.41



1.5" Boat-Shaped Tabletop w/Power and Data

How to Specify:

Each laminate comes with matching vinyl trim color unless otherwise specified on your purchase order. Refer to the laminate finish card for details.

Notes:

Tabletops 72"-96"W are configured in one-piece top.

Tabletops 108"-192"W are configured in two-piece tops.

Tabletops 204"-240"W are configured in three-piece tops.

Single-piece tabletops are equipped with one power and data grommet, two-piece tabletops are equipped with two power and data grommets, and three-piece tabletops are equipped with three power and data grommets.

Two power and dual USB-A receptacles with 3 open slots to accommodate RJ11, RJ45, HDMI, VGA or Stereo. Items for 3 open slots must be specified and purchased separately.

Boardroom tables with tops comprised of 2 or more pieces will not have a consistent grain pattern.

Options:

laminate color

edge profile

grommet color (for tabletops with power and data)

Code	Price	H	W	D	Volume (ft ³)	Weight (lb)
TB-MBBP-7236	1882	1.5	72	36	1.95	78.15
TB-MBBP-7242	2082	1.5	72	42	2.33	93.16
TB-MBBP-8436	2002	1.5	84	36	2.29	91.47
TB-MBBP-8442	2168	1.5	84	42	2.72	108.98
TB-MBBP-8448	2240	1.5	84	48	3.16	126.49
TB-MBBP-9636	2086	1.5	96	36	2.62	104.8
TB-MBBP-9642	2257	1.5	96	42	3.12	124.8
TB-MBBP-9648	2296	1.5	96	48	3.62	144.81
TB-MBBP-10848	3625	1.5	108	48	4.02	160.92
TB-MBBP-10854	3889	1.5	108	54	4.58	183.44
TB-MBBP-10860	3919	1.5	108	60	5.14	205.94
TB-MBBP-12048	3757	1.5	120	48	4.48	179.26
TB-MBBP-12054	4047	1.5	120	54	5.1	204.26

Code	Price	H	W	D	Volume (ft ³)	Weight (lb)
TB-MBBP-12060	4074	1.5	120	60	5.72	229.28
TB-MBBP-13248	3890	1.5	132	48	4.94	197.6
TB-MBBP-13254	4205	1.5	132	54	5.62	225.1
TB-MBBP-13260	4232	1.5	132	60	6.32	252.62
TB-MBBP-14448	4024	1.5	144	48	5.4	215.92
TB-MBBP-14454	4364	1.5	144	54	6.14	245.94
TB-MBBP-14460	4394	1.5	144	60	6.9	275.94
TB-MBBP-15648	4157	1.5	156	48	5.86	234.26
TB-MBBP-15654	4523	1.5	156	54	6.66	266.78
TB-MBBP-15660	4554	1.5	156	60	7.48	299.28
TB-MBBP-16848	4499	1.5	168	48	6.32	252.6
TB-MBBP-16854	4682	1.5	168	54	7.18	287.6
TB-MBBP-16860	4712	1.5	168	60	8.06	322.62
TB-MBBP-18048	4526	1.5	180	48	6.78	270.92
TB-MBBP-18054	4840	1.5	180	54	7.7	308.44
TB-MBBP-18060	4871	1.5	180	60	8.64	345.96
TB-MBBP-19248	4557	1.5	192	48	7.22	289.26
TB-MBBP-19254	5001	1.5	192	54	8.22	329.28
TB-MBBP-19260	5029	1.5	192	60	9.22	369.3
TB-MBBP-20448	5904	1.5	204	48	7.69	308.97
TB-MBBP-20454	6392	1.5	204	54	8.75	351.49
TB-MBBP-20460	6435	1.5	204	60	9.81	394.01
TB-MBBP-21648	6038	1.5	216	48	8.15	327.31
TB-MBBP-21654	6551	1.5	216	54	9.27	373.33
TB-MBBP-21660	6592	1.5	216	60	10.4	417.35
TB-MBBP-22848	6169	1.5	228	48	8.61	345.65
TB-MBBP-22854	6709	1.5	228	54	9.4	393.17
TB-MBBP-22860	6751	1.5	228	60	10.98	440.69
TB-MBBP-24048	6513	1.5	240	48	9.06	363.99
TB-MBBP-24054	6869	1.5	240	54	10.31	414.01
TB-MBBP-24060	6911	1.5	240	60	11.56	464.03

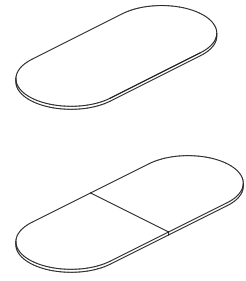

1.5" Racetrack Tabletop

How to Specify:

Each laminate comes with matching vinyl trim color unless otherwise specified on your purchase order. Refer to the laminate finish card for details.

Notes:

- Tabletops 72"-96"W are configured in one-piece top.
- Tabletops 108"-192"W are configured in two-piece tops.
- Tabletops 204"-240"W are configured in three-piece tops.

Options:

- laminate color
- edge profile

Code	Price	H	W	D	Volume (ft ³)	Weight (lb)
TB-MRRX-7236	791	1.5	72	36	2.01	80.37
TB-MRRX-7242	990	1.5	72	42	2.3	91.89
TB-MRRX-8436	909	1.5	84	36	2.38	95.38
TB-MRRX-8442	1076	1.5	84	42	2.73	109.4
TB-MRRX-8448	1146	1.5	84	48	3.07	122.88
TB-MRRX-9636	992	1.5	96	36	2.76	110.38
TB-MRRX-9642	1164	1.5	96	42	3.17	126.9
TB-MRRX-9648	1203	1.5	96	48	3.57	142.89
TB-MRRX-10848	1441	1.5	108	48	4.06	162.62
TB-MRRX-10854	1704	1.5	108	54	4.52	180.56
TB-MRRX-10860	1733	1.5	108	60	4.94	197.96
TB-MRRX-12048	1575	1.5	120	48	4.56	182.6
TB-MRRX-12054	1861	1.5	120	54	5.08	203.06

Code	Price	H	W	D	Volume (ft ³)	Weight (lb)
TB-MRRX-12060	1890	1.5	120	60	5.58	222.98
TB-MRRX-13248	1706	1.5	132	48	5.06	202.62
TB-MRRX-13254	2020	1.5	132	54	5.64	225.58
TB-MRRX-13260	2050	1.5	132	60	6.2	247.98
TB-MRRX-14448	1839	1.5	144	48	5.56	222.64
TB-MRRX-14454	2180	1.5	144	54	6.2	248.08
TB-MRRX-14460	2210	1.5	144	60	6.82	273
TB-MRRX-15648	1975	1.5	156	48	6.06	242.64
TB-MRRX-15654	2342	1.5	156	54	6.76	270.6
TB-MRRX-15660	2369	1.5	156	60	7.44	298.02
TB-MRRX-16848	2312	1.5	168	48	6.56	262.66
TB-MRRX-16854	2498	1.5	168	54	7.32	293.1
TB-MRRX-16860	2527	1.5	168	60	8.08	323.02
TB-MRRX-18048	2345	1.5	180	48	7.06	282.66
TB-MRRX-18054	2657	1.5	180	54	7.88	315.62
TB-MRRX-18060	2689	1.5	180	60	8.7	348.04
TB-MRRX-19248	2371	1.5	192	48	7.56	302.66
TB-MRRX-19254	2819	1.5	192	54	8.44	338.12
TB-MRRX-19260	2846	1.5	192	60	9.32	373.04
TB-MRRX-20448	2631	1.5	204	48	8.06	322.58
TB-MRRX-20454	3116	1.5	204	54	9.01	360.53
TB-MRRX-20460	3159	1.5	204	60	9.94	397.95
TB-MRRX-21648	2762	1.5	216	48	8.56	342.59
TB-MRRX-21654	3274	1.5	216	54	9.57	383.04
TB-MRRX-21660	3319	1.5	216	60	10.56	422.97
TB-MRRX-22848	2896	1.5	228	48	9.06	362.59
TB-MRRX-22854	3434	1.5	228	54	10.13	405.55
TB-MRRX-22860	3477	1.5	228	60	11.19	447.97
TB-MRRX-24048	3237	1.5	240	48	9.56	382.6
TB-MRRX-24054	3592	1.5	240	54	10.7	428.06
TB-MRRX-24060	3637	1.5	240	60	11.82	472.98



1.5" Racetrack Tabletop w/Power and Data

How to Specify:

Each laminate comes with matching vinyl trim color unless otherwise specified on your purchase order. Refer to the laminate finish card for details.

Notes:

Tabletops 72"-96"W are configured in one-piece top.

Tabletops 108"-192"W are configured in two-piece tops.

Tabletops 204"-240"W are configured in three-piece tops.

Single-piece tabletops are equipped with one power and data grommet, two-piece tabletops are equipped with two power and data grommets, and three-piece tabletops are equipped with three power and data grommets.

Two power and dual USB-A receptacles with 3 open slots to accommodate RJ11, RJ45, HDMI, VGA or Stereo. Items for 3 open slots must be specified and purchased separately.

Boardroom tables with tops comprised of 2 or more pieces will not have a consistent grain pattern.

Options:

laminate color

edge profile

grommet color (for tabletops with power and data)

Code	Price	H	W	D	Volume (ft ³)	Weight (lb)
TB-MRRP-7236	1882	1.5	72	36	1.96	78.44
TB-MRRP-7242	2082	1.5	72	42	2.25	89.96
TB-MRRP-8436	2002	1.5	84	36	2.34	93.45
TB-MRRP-8442	2168	1.5	84	42	2.69	107.47
TB-MRRP-8448	2240	1.5	84	48	3.02	120.95
TB-MRRP-9636	2086	1.5	96	36	2.71	108.46
TB-MRRP-9642	2257	1.5	96	42	3.12	124.98
TB-MRRP-9648	2296	1.5	96	48	3.52	140.96
TB-MRRP-10848	3625	1.5	108	48	3.96	158.76
TB-MRRP-10854	3889	1.5	108	54	4.42	176.7
TB-MRRP-10860	3919	1.5	108	60	4.86	194.12
TB-MRRP-12048	3757	1.5	120	48	4.46	178.76
TB-MRRP-12054	4047	1.5	120	54	4.98	199.22

Code	Price	H	W	D	Volume (ft ³)	Weight (lb)
TB-MRRP-12060	4074	1.5	120	60	5.48	219.12
TB-MRRP-13248	3890	1.5	132	48	4.96	198.78
TB-MRRP-13254	4205	1.5	132	54	5.54	221.72
TB-MRRP-13260	4232	1.5	132	60	6.1	244.14
TB-MRRP-14448	4024	1.5	144	48	5.46	218.78
TB-MRRP-14454	4364	1.5	144	54	6.1	244.24
TB-MRRP-14460	4394	1.5	144	60	6.72	269.14
TB-MRRP-15648	4157	1.5	156	48	5.96	238.78
TB-MRRP-15654	4523	1.5	156	54	6.66	266.74
TB-MRRP-15660	4554	1.5	156	60	7.36	294.16
TB-MRRP-16848	4499	1.5	168	48	6.46	258.8
TB-MRRP-16854	4682	1.5	168	54	7.22	289.24
TB-MRRP-16860	4712	1.5	168	60	7.98	319.16
TB-MRRP-18048	4526	1.5	180	48	6.96	278.8
TB-MRRP-18054	4840	1.5	180	54	7.8	311.76
TB-MRRP-18060	4871	1.5	180	60	8.6	344.18
TB-MRRP-19248	4557	1.5	192	48	7.46	298.82
TB-MRRP-19254	5001	1.5	192	54	8.36	334.24
TB-MRRP-19260	5029	1.5	192	60	9.22	369.18
TB-MRRP-20448	5904	1.5	204	48	7.97	320.19
TB-MRRP-20454	6392	1.5	204	54	8.92	358.15
TB-MRRP-20460	6435	1.5	204	60	9.85	395.57
TB-MRRP-21648	6038	1.5	216	48	8.47	340.2
TB-MRRP-21654	6551	1.5	216	54	9.48	380.66
TB-MRRP-21660	6592	1.5	216	60	10.48	420.58
TB-MRRP-22848	6169	1.5	228	48	8.97	360.21
TB-MRRP-22854	6709	1.5	228	54	10.04	403.17
TB-MRRP-22860	6751	1.5	228	60	11.1	445.59
TB-MRRP-24048	6513	1.5	240	48	9.47	380.22
TB-MRRP-24054	6869	1.5	240	54	10.61	425.68
TB-MRRP-24060	6911	1.5	240	60	11.73	470.6

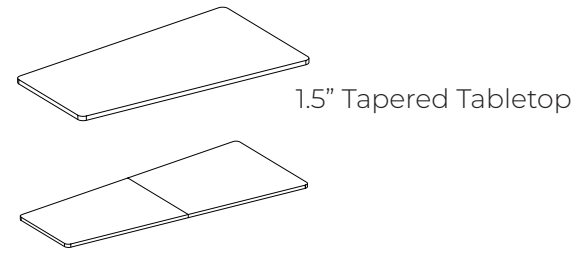

1.5" Tapered Tabletop

How to Specify:

Each laminate comes with matching vinyl trim color unless otherwise specified on your purchase order. Refer to the laminate finish card for details.

Notes:

- Tabletops 72"-96"W are configured in one-piece top.
- Tabletops 108"-192"W are configured in two-piece tops.
- Tabletops 204"-240"W are configured in three-piece tops.

Options:

- laminate color
- edge profile
- grommet color (for tabletops with power and data)

Code	Price	H	W	D	Volume (ft ³)	Weight (lb)
TB-MTTX-844836	1151	1.5	84	48	3.06	122.43
TB-MTTX-964836	1180	1.5	96	48	3.5	139.93
TB-MTTX-1085436	1681	1.5	108	54	4.21	168.5
TB-MTTX-1086042	1710	1.5	108	60	4.77	191.01
TB-MTTX-1205436	1839	1.5	120	54	4.68	187.26
TB-MTTX-1206042	1869	1.5	120	60	5.3	212.27
TB-MTTX-1326042	2028	1.5	132	60	5.84	233.53
TB-MTTX-1446042	2189	1.5	144	60	6.37	254.79
TB-MTTX-1326648	2203	1.5	132	66	6.52	260.85
TB-MTTX-1447254	2562	1.5	144	72	7.86	314.62
TB-MTTX-1687254	3051	1.5	168	72	9.17	367.14
TB-MTTX-1927860	3653	1.5	192	78	11.48	459.49
TB-MTTX-2167860	4327	1.5	216	78	12.92	517.01
TB-MTTX-2406048	3553	1.5	240	60	11.23	449.49



1.5" Tapered Tabletop w/Power and Data

How to Specify:

Each laminate comes with matching vinyl trim color unless otherwise specified on your purchase order. Refer to the laminate finish card for details.

Notes:

- Tabletops 72"-96"W are configured in one-piece top.
- Tabletops 108"-192"W are configured in two-piece tops.
- Tabletops 204"-240"W are configured in three-piece tops.
- Single-piece tabletops are equipped with one power and data grommet, two-piece tabletops are equipped with two power and data grommets, and three-piece tabletops are equipped with three power and data grommets.
- Two power and dual USB-A receptacles with 3 open slots to accommodate RJ11, RJ45, HDMI, VGA or Stereo. Items for 3 open slots must be specified and purchased separately.
- Boardroom tables with tops comprised of 2 or more pieces will not have a consistent grain pattern.

Options:

- laminate color
- edge profile
- grommet color (for tabletops with power and data)

Code	Price	H	W	D	Volume (ft ³)	Weight (lb)
TB-MTTP-1085436	3862	1.5	108	54	4.15	166.91
TB-MTTP-1086042	3893	1.5	108	60	4.71	189.42
TB-MTTP-1205436	4022	1.5	120	54	4.62	185.67
TB-MTTP-1206042	4050	1.5	120	60	5.24	210.68
TB-MTTP-1326042	4221	1.5	132	60	5.78	231.94
TB-MTTP-1446042	4369	1.5	144	60	6.31	253.2
TB-MTTP-844836	2242	1.5	84	48	3.01	120.53
TB-MTTP-964836	2272	1.5	96	48	3.45	138
TB-MTTP-1326648	4385	1.5	132	66	6.46	259.26
TB-MTTP-1447254	4744	1.5	144	72	7.8	313.03
TB-MTTP-1687254	5230	1.5	168	72	9.11	365.55
TB-MTTP-1927860	6927	1.5	192	78	11.39	457.11
TB-MTTP-2167860	7601	1.5	216	78	12.83	514.63
TB-MTTP-2406048	6827	1.5	240	60	11.14	447.1



Notes:

Refer to page 230 for base configuration requirements for selected tabletops

Options:

laminate color

metal color (for post support base)

for Straight/Boat Tabletops

Code	Price	H	W	D	Volume (ft ³)	Weight (lb)
TB-B4-7236	537	28	42	21	14.29	41.45
TB-B4-7242	537	28	42	24	16.33	52.15
TB-B4-8436	537	28	54	21	18.38	44.55
TB-B4-8442	550	28	54	24	21	55.89
TB-B4-8448	601	28	42	84	1.27	51.53
TB-B4-9636	550	28	30	96	1.07	43.54
TB-B4-9642	581	28	36	96	1.16	47.38
TB-B4-9648	651	28	66	30	32.08	63.75
TB-B4-10848	919	28	77	30	37.43	67.75
TB-B4-10854	1010	28	54	108	2.18	88.49
TB-B4-10860	1098	28	60	108	2.47	100
TB-B4-12048	956	28	89	30	43.26	71.99
TB-B4-12054	1049	28	54	120	2.26	91.82
TB-B4-12060	1138	28	60	120	2.55	103.34
TB-B4-13248	995	28	101	30	49.1	76.23
TB-B4-13254	1087	28	54	132	2.35	95.16
TB-B4-13260	1172	28	60	132	2.63	106.67
TB-B4-14448	1040	28	113	30	54.93	80.47

Code	Price	H	W	D	Volume (ft ³)	Weight (lb)
TB-B4-14454	1132	28	54	144	2.43	98.88
TB-B4-14460	1219	28	60	144	2.72	110.4
TB-B4-15648	1079	28	48	156	2.23	90.7
TB-B4-15654	1168	28	54	156	2.51	102.22
TB-B4-15660	1257	28	60	156	2.8	113.73
TB-B4-16848	1117	28	48	168	2.31	94.04
TB-B4-16854	1208	28	54	168	2.6	105.55
TB-B4-16860	1295	28	60	168	2.89	117.07
TB-B4-18048	1155	28	48	180	2.39	97.37
TB-B4-18054	1248	28	54	180	2.59	108.98
TB-B4-18060	1336	28	60	180	2.97	120.4
TB-B4-19248	1194	28	48	192	2.48	100.71
TB-B4-19254	1286	28	54	192	2.76	112.22
TB-B4-19260	1374	28	60	192	3.05	123.74
TB-B4-20448	1462	28	48	204	3	122.06
TB-B4-20454	1586	28	54	204	3.39	137.42
TB-B4-20460	1700	28	60	204	3.77	152.77
TB-B4-21648	1505	28	48	216	3.09	125.79
TB-B4-21654	1629	28	54	216	3.47	141.14
TB-B4-21660	1742	28	60	216	3.85	156.5
TB-B4-22848	1547	28	48	228	3.17	129.13
TB-B4-22854	1667	28	54	228	3.55	144.48
TB-B4-22860	1782	28	60	228	3.98	159.84
TB-B4-24048	1585	28	48	240	3.25	132.46
TB-B4-24054	1706	28	54	240	3.64	147.81
TB-B4-24060	1822	28	60	240	4.02	163.17

for Racetrack Top

Code	Price	H	W	D	Volume (ft ³)	Weight (lb)
TB-B4-8448R	587	28	48	84	1.24	50.41
TB-B4-9648R	630	28	48	96	1.33	53.95
TB-B4-10848R	905	28	48	108	1.86	75.86
TB-B4-10854R	984	28	54	108	2.12	86.26
TB-B4-10860R	1059	28	60	108	2.38	96.67
TB-B4-12048R	943	28	48	120	1.95	79.19
TB-B4-12054R	1021	28	54	120	2.21	89.6
TB-B4-12060R	1098	28	60	120	2.47	100
TB-B4-13248R	984	28	48	132	2.03	82.53
TB-B4-13254R	1060	28	54	132	2.29	92.93
TB-B4-13260R	1138	28	60	132	2.55	103.34
TB-B4-14448R	1026	28	48	144	2.12	86.26
TB-B4-14454R	1103	28	54	144	2.38	96.66
TB-B4-14460R	1177	28	60	144	2.63	106.67
TB-B4-15648R	1062	28	48	156	2.2	89.59
TB-B4-15654R	1143	28	54	156	2.46	99.99
TB-B4-15660R	1219	28	60	156	2.72	110.4
TB-B4-16848R	1103	28	48	168	2.28	92.92
TB-B4-16854R	1181	28	54	168	2.54	103.33
TB-B4-16860R	1257	28	60	168	2.8	113.73
TB-B4-18048R	1143	28	48	180	2.37	96.26
TB-B4-18054R	1221	28	54	180	2.63	106.66
TB-B4-18060R	1295	28	60	180	2.89	117.07
TB-B4-19248R	1180	28	48	192	2.48	99.59
TB-B4-19254R	1258	28	54	192	2.71	110
TB-B4-19260R	1336	28	60	192	2.97	120.4
TB-B4-20448R	1448	28	48	204	2.95	120.97
TB-B4-20454R	1559	28	54	204	3.33	135.19
TB-B4-20460R	1659	28	60	204	3.69	149.44
TB-B4-21648R	1491	28	48	216	3.06	124.68
TB-B4-21654R	1600	28	54	216	3.41	138.92
TB-B4-21660R	1703	28	60	216	3.77	152.77
TB-B4-22848R	1529	28	48	228	3.14	128.01
TB-B4-22854R	1641	28	54	228	3.5	142.26
TB-B4-22860R	1742	28	60	228	3.85	156.5
TB-B4-24048R	1570	28	48	240	3.23	131.35
TB-B4-24054R	1680	28	54	240	3.58	145.59
TB-B4-24060R	1782	28	60	240	3.94	159.83

for Tapered Tabletop

Code	Price	H	W	D	Volume (ft ³)	Weight (lb)
TB-B4-844836T	559	28	48	84	1.13	45.77
TB-B4-964836T	597	28	48	96	1.21	19.3
TB-B4-1085436T	902	28	54	108	1.81	73.77
TB-B4-1205436T	941	28	54	120	1.9	77.11
TB-B4-1086042T	976	28	60	108	2.04	82.73
TB-B4-1206042T	1013	28	60	120	2.12	86.06
TB-B4-1326042T	1052	28	60	132	2.2	89.4
TB-B4-1326648T	1582	28	66	132	2.47	100.56
TB-B4-1447254T	1735	28	72	144	2.65	108
TB-B4-1687254T	1841	28	72	168	2.83	115.44
TB-B4-1927860T	2171	28	78	192	3.01	122.88
TB-B4-2167860T	2253	28	78	216	5.22	211.32
TB-B4-2406048T	1966	28	60	240	4.19	170.01

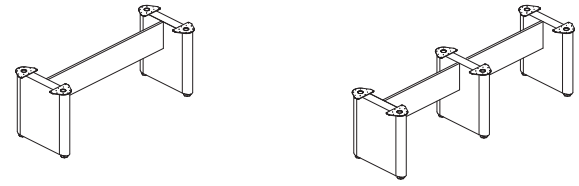

Elliptical Base

Notes:

Refer to page [230](#) for base configuration requirements for selected tabletops

Options:

laminate color

metal color

for Tapered Tabletop

Code	Price	H	W	D	Volume (ft ³)	Weight (lb)
TB-B5-844836T	1555	28	48	84	1.09	66.33
TB-B5-964836T	1593	28	48	96	1.17	69.86
TB-B5-1085436T	2351	28	54	108	1.81	106.9
TB-B5-1086042T	2495	28	60	108	2.21	123.15
TB-B5-1205436T	2387	28	54	120	1.89	110.23
TB-B5-1206042T	2529	28	60	120	2.3	126.49
TB-B5-1326042T	2567	28	60	132	2.38	129.82
TB-B5-1326648T	2695	28	66	132	2.46	133.15
TB-B5-1446042T	2609	28	60	144	2.54	133.5
TB-B5-1447254T	3622	28	72	144	2.7	134.2
TB-B5-1687254T	3877	28	72	168	2.86	134.9
TB-B5-1927860T	4440	28	78	192	3.02	135.6
TB-B5-2167860T	4720	28	78	216	3.97	205.04
TB-B5-2406048T	4486	28	60	240	4.13	212.1

for Racetrack Tabletop

Code	Price	H	W	D	Volume (ft ³)	Weight (lb)
TB-B5-8448R	1575	28	48	84	1.19	70.64
TB-B5-9648R	1613	28	48	96	1.28	74.17
TB-B5-10848R	2377	28	48	108	1.78	105.79
TB-B5-10854R	2453	28	54	108	2.16	120.93
TB-B5-10860R	2583	28	60	108	2.54	136.08
TB-B5-12048R	2415	28	48	120	1.86	109.12
TB-B5-12054R	2490	28	54	120	2.24	124.27
TB-B5-12060R	2621	28	60	120	2.62	139.41
TB-B5-13248R	2451	28	48	132	1.95	112.45
TB-B5-13254R	2525	28	54	132	2.33	127.6
TB-B5-13260R	2657	28	60	132	2.7	142.75
TB-B5-14448R	2397	28	48	144	2.03	116.18
TB-B5-14454R	2484	28	54	144	2.41	130.93
TB-B5-14460R	2693	28	60	144	2.79	146.08
TB-B5-15648R	2526	28	48	156	2.12	119.52
TB-B5-15654R	2601	28	54	156	2.49	134.66
TB-B5-15660R	2733	28	60	156	2.87	149.81
TB-B5-16848R	2563	28	48	168	2.2	122.85
TB-B5-16854R	2637	28	54	168	2.58	138
TB-B5-16860R	2771	28	60	168	2.96	153.14
TB-B5-18048R	2599	28	48	180	2.28	126.19
TB-B5-18054R	2672	28	54	180	2.66	141.33
TB-B5-18060R	2801	28	60	180	3.04	156.48
TB-B5-19248R	2634	28	48	192	2.37	129.52
TB-B5-19254R	2709	28	54	192	2.74	144.67
TB-B5-19260R	2844	28	60	192	3.12	159.81
TB-B5-20448R	3998	28	48	204	2.85	160.58
TB-B5-20454R	4096	28	54	204	3.37	181.14
TB-B5-20460R	4271	28	60	204	3.88	201.71
TB-B5-21648R	3921	28	48	216	2.94	164.31
TB-B5-21654R	4041	28	54	216	3.45	184.48
TB-B5-21660R	4329	28	60	216	3.97	205.04
TB-B5-22848R	4112	28	48	228	3.02	167.64
TB-B5-22854R	4208	28	54	228	3.54	188.2
TB-B5-22860R	4382	28	60	228	4.05	208.77
TB-B5-24048R	4164	28	48	240	3.11	170.97
TB-B5-24054R	4265	28	54	240	3.62	191.54
TB-B5-24060R	4437	28	60	240	4.13	212.1

for Straight/Boat Tabletops

Code	Price	H	W	D	Volume (ft ³)	Weight (lb)
TB-B5-7236	1415	28	36	72	0.87	57.58
TB-B5-7242	1465	28	42	72	1	63
TB-B5-8436	1450	28	36	84	0.95	60.91
TB-B5-8442	1501	28	42	84	1.09	66.33
TB-B5-8448	1587	28	84	48	1.22	71.75
TB-B5-9636	1489	28	36	96	1.03	64.45
TB-B5-9642	1538	28	42	96	1.17	69.86
TB-B5-9648	1624	28	48	96	1.3	75.3
TB-B5-10848	2388	28	48	108	1.81	106.9
TB-B5-10854	2478	28	54	108	2.21	123.15
TB-B5-10860	2621	28	60	108	2.62	139.41
TB-B5-12048	2425	28	48	120	1.89	110.23
TB-B5-12054	2514	28	54	120	2.3	126.49
TB-B5-12060	2657	28	60	120	2.7	142.75
TB-B5-13248	2460	28	48	132	1.97	113.57
TB-B5-13254	2549	28	54	132	2.38	129.82
TB-B5-13260	2693	28	60	132	2.79	146.08
TB-B5-14448	2502	28	48	144	2.06	117.29
TB-B5-14454	2589	28	54	144	2.47	133.55
TB-B5-14460	2733	28	60	144	2.87	149.81
TB-B5-15648	2539	28	48	156	2.14	120.63
TB-B5-15654	2627	28	54	156	2.55	136.88
TB-B5-15660	2771	28	60	156	2.96	153.14
TB-B5-16848	2569	28	48	168	2.23	123.96
TB-B5-16854	2658	28	54	168	2.63	140.22

Code	Price	H	W	D	Volume (ft ³)	Weight (lb)
TB-B5-16860	2801	28	60	168	3.04	156.48
TB-B5-18048	2611	28	48	180	2.31	127.3
TB-B5-18054	2697	28	54	180	2.72	143.55
TB-B5-18060	2844	28	60	180	3.12	159.81
TB-B5-19248	2645	28	48	192	2.39	130.63
TB-B5-19254	2733	28	54	192	2.8	146.89
TB-B5-19260	2880	28	60	192	3.21	163.15
TB-B5-20448	4013	28	48	204	2.88	161.69
TB-B5-20454	4134	28	54	204	3.42	183.37
TB-B5-20460	4326	28	60	204	3.97	205.04

Tabletop Sizes **Post Support**



72" x 36"	4
84" x 36"	4
72" x 42"	4
84" x 42"	4
96" x 48"	4



108" x 48"	6
120" x 48"	6
132" x 48"	6
144" x 48"	6



T-RJ45



T-RJ11



T-VGA



T-STEREO

Code	Price
T-RJ45	202
T-RJ11	77
T-HDMI	196
T-VGA	244
T-STEREO	51

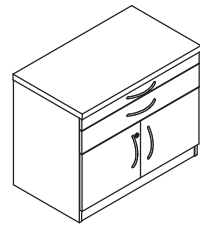

1.5" Serving Cabinet

How to Specify:

Each laminate comes with matching vinyl trim color unless otherwise specified on your purchase order. Refer to the laminate finish card for details.

Notes:

Cabinets and lateral files include lock and keys.

Options:

laminate color

edge profile

handle color

handle style

Code	Price	H	W	D	Volume (ft ³)	Weight (lb)
TB-FCS0-3021	1612	29.5	30	21	16.48	110.08
TB-FCS0-3621	2179	29.5	36	21	19.39	123.75



1.5" Storage Cabinet w/Shelves, LH Shown

How to Specify:

Each laminate comes with matching vinyl trim color unless otherwise specified on your purchase order. Refer to the laminate finish card for details.

Notes:

Cabinets and lateral files include lock and keys.

Options:

laminate color

edge profile

handle color

handle style

Code	Price	H	W	D	Volume (ft ³)	Weight (lb)
TB-FSDS-1821-L	1456	78	18	21	26.1	146.7
TB-FSDS-1821-R	1456	78	18	21	26.1	146.7

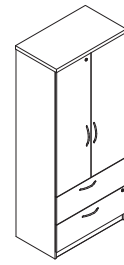

1.5" Combo Cabinet w/Storage and Lateral Files

How to Specify:

Each laminate comes with matching vinyl trim color unless otherwise specified on your purchase order. Refer to the laminate finish card for details.

Notes:

Cabinets and lateral files include lock and keys.

Options:

- laminate color _____
- edge profile _____
- handle color _____
- handle style _____

Code	Price	H	W	D	Volume (ft ³)	Weight (lb)
TB-FCSL-3621	2708	78	36	21	47.45	279.9

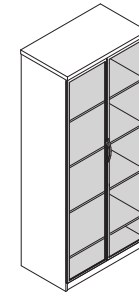

1.5" Double Door Storage Cabinet w/Shelves and Acrylic Doors

How to Specify:

Each laminate comes with matching vinyl trim color unless otherwise specified on your purchase order. Refer to the laminate finish card for details.

Notes:

Options:

- laminate color _____
- edge profile _____
- handle color _____
- handle style _____
- metal color (for doors) _____
- acrylic color (for doors) _____

Code	Price	H	W	D	Volume (ft ³)	Weight (lb)
TB-FSDS-3621-G	3882	78	36	21	47.45	225.45

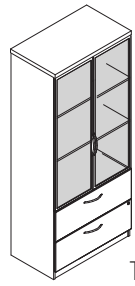

1.5" Combo Cabinet w/Storage, Lateral Files and Acrylic Doors

How to Specify:

Each laminate comes with matching vinyl trim color unless otherwise specified on your purchase order. Refer to the laminate finish card for details.

Notes:

There are no locks for acrylic doors.

Options:

- laminate color

- edge profile

- handle color

- handle style

- metal color (for acrylic doors)

- acrylic color (for acrylic doors)

Code	Price	H	W	D	Volume (ft ³)	Weight (lb)
TB-FCSL-3621-G	4361	78	36	21	47.45	278.1

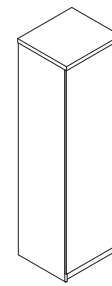

1.5" Storage Cabinet w/Coat Bar and Shelves, LH Shown

How to Specify:

Each laminate comes with matching vinyl trim color unless otherwise specified on your purchase order. Refer to the laminate finish card for details.

Notes:

Cabinets and lateral files include lock and keys.

Options:

- laminate color

- edge profile

- handle color

- handle style

Code	Price	H	W	D	Volume (ft ³)	Weight (lb)
TB-FSDC-2421-L	1567	78	24	21	13.22	194.4
TB-FSDC-2421-R	1567	78	24	21	13.22	194.4

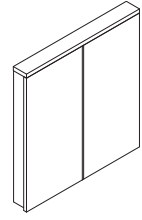

1.5" Whiteboard Cabinet

How to Specify:

Each laminate comes with matching vinyl trim color unless otherwise specified on your purchase order. Refer to the laminate finish card for details.

Options:

- laminate color

- edge profile (for whiteboard cabinet and mobile media center)

- tackboard fabric (for whiteboard cabinet)

Code	Price	H	W	D	Volume (ft ³)	Weight (lb)
TB-VB00-4850	1704	51	48	5.6	7.93	112.95

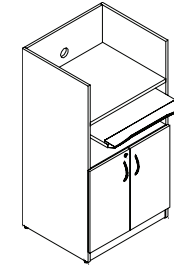

1" Computer Desk with 1.5" top

How to Specify:

Each laminate comes with matching vinyl trim color unless otherwise specified on your purchase order. Refer to the laminate finish card for details.

Options:

- laminate color

- edge profile

- handle color

- handle style

- grommet color

Notes:

Comes with locks for cabinets.

Code	Price	H	W	D	Volume (ft ³)	Weight (lb)
U-TCDS-542824	4014	54	28	24	21	80



Metro Pricebook
October 2024
Accessories

accessories

<u>keyboard tray</u>	242
<u>tackboard for hutch</u>	243
<u>pencil drawer</u>	244
<u>task light</u>	245
<u>monitor arm</u>	246
<u>wire manager</u>	247

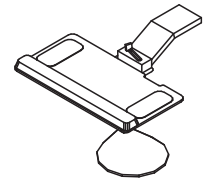

Articulating Keyboard Tray w/Mouse Tray

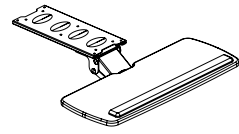

Articulating Keyboard Tray

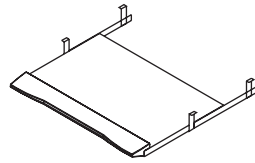

Retractable Laminate Keyboard Tray

What's Included:

Keyboard Tray, installation hardware.

How to Specify:

Specify laminate color for retractable keyboard. The vinyl trim color will default to match the laminate color unless otherwise specified. See the laminate finish card for details.

For articulating keyboard with mouse, right or left hand must be specified.

The articulating keyboards are available only in black.

Notes:

Keyboard trays provide adjustable ergonomic support for individuals in multi-task environments

Options:

Finish: laminate colors (retractable keyboard only)

Hand: **R** right **L** left (for adjustable keyboard with mouse only)

Code	Price	H	W	D	Volume (ft ³)	Weight (lb)
Articulating Keyboard Tray w/Mouse Tray						
V-KAS0-2011-L	629	0	20	11	0	3
V-KAS0-2011-R	629	0	20	11	0	3
Articulating Keyboard Tray						
V-KASX-2510	403	0	25	10	0	15
Retractable Laminate Keyboard Tray						
V-KRS0-2516	264	0	25	16	0	12

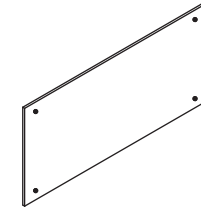

14"H Tackboard for Hutch w/Pigeonholes

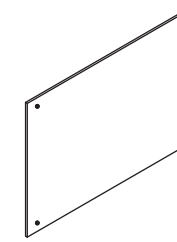

21"H Tackboard for Hutch without Pigeonholes

Options:

fabric color (for tackboard)

Code	Price	H	W	D	Volume (ft ³)	Weight (lb)
14"H Tackboard for Hutch w/Pigeonholes						
V-ATH0-1427	223	14	27	0.5	0.81	1.7
V-ATH0-1433	235	14	33	0.5	0.96	2.1
V-ATH0-1439	244	14	39	0.5	1.12	2.5
V-ATH0-1445	255	14	45	0.5	1.28	2.9
V-ATH0-1451	265	14	51	0.5	1.43	3.3
V-ATH0-1457	270	14	57	0.5	1.59	3.7
V-ATH0-1463	282	14	63	0.5	1.74	4.1
V-ATH0-1469	295	14	69	0.5	1.9	4.5
V-ATH0-1475	323	14	75	0.5	2.06	4.9
V-ATH0-1481	370	14	81	0.5	2.21	5.4
21"H Tackboard for Hutch without Pigeonholes						
V-ATH0-2127	307	21	27	0.5	1.12	2.7
V-ATH0-2133	322	21	33	0.5	1.34	3.1
V-ATH0-2139	353	21	39	0.5	1.56	3.5
V-ATH0-2145	383	21	45	0.5	1.77	3.9
V-ATH0-2151	416	21	51	0.5	1.99	4.3
V-ATH0-2157	458	21	57	0.5	2.21	4.7
V-ATH0-2163	501	21	63	0.5	2.42	5.1
V-ATH0-2169	559	21	69	0.5	2.64	5.5
V-ATH0-2175	575	21	75	0.5	2.86	5.9
V-ATH0-2181	598	21	81	0.5	3.07	6.3

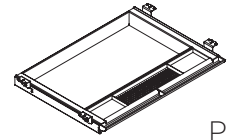

Plastic Pencil Drawer

Notes:

Plastic Pencil Drawers are available in black only.

Code	Price	H	W	D	Volume (ft ³)	Weight (lb)
V-ADPP	88	2.8	21	16	0.62	2

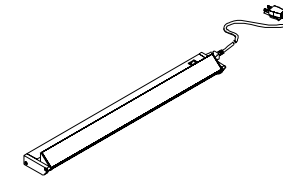

Task Light

Notes:

Task light comes in black finish.

Code	Price	H	W	D	Volume (ft ³)	Weight (lb)
V-ELU-24	302	0	24.53	0	0	9.5
V-ELU-36	340	0	36.39	0	0	13.7
V-ELU-48	427	0	48.15	0.15	0	17.9

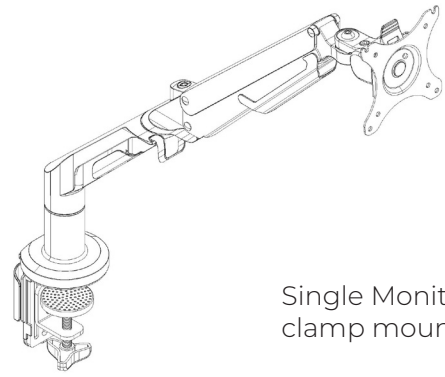

Single Monitor Arm - clamp mount

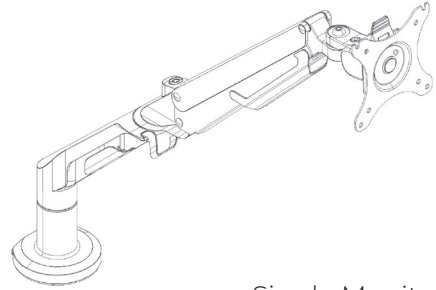

Single Monitor Arm - grommet mount

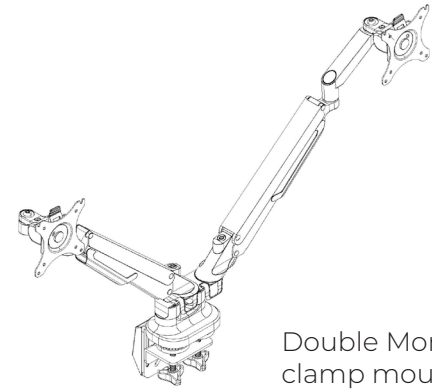

Double Monitor Arm - clamp mount

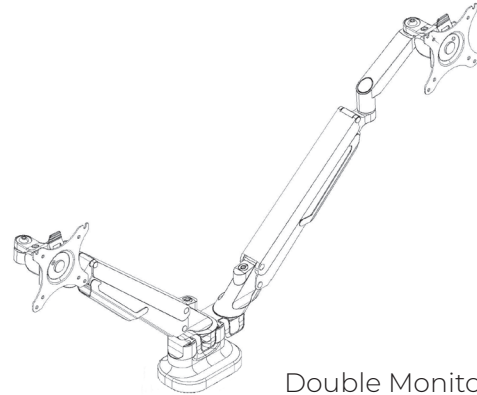

Double Monitor Arm - grommet mount

What's Included:

One monitor arm and installation hardware for both clamp and grommet mount

How to Specify:

- Specify type

Dimensions:

Vesa: 75x75 and 100x100

Code	Price
Monitor Arm - Single Mount	
V-AFMA-01	374
Monitor Arm - Double Mount	
V-AFMA-02	624

Notes:

Available in silver only

Single Monitor Arm

- Screen Size - 17"-36"
- Load Capacity - 6.6-26.4lbs/3-12kg
- Tilt Range - -90 degrees - -15 degrees

Dual Monitor Arm

- Screen Size - 17"-32"
- Load Capacity - 4.4-19.8lbs/2-9kg
- Tilt Range - -90 degrees - -15 degrees



Vertical Wire Manager

Notes:

Wire manager is available in silver only.

Code	Price	H	W	D	Volume (ft ³)	Weight (lb)
V-EE00	318	28	4	4	0.25	1