

tayco®

Switch Canada
Pricebook
June 2026

Contents

Statement of Line	vi
Space Division	vi
Worksurface & Supports	viii
Connections & Trims	x
Storage	xi
Electrics	xii
Accessories	xii
Segment Types	xiii
Caution	xiv
Application Guidelines	xv
Types of Surfaces	xv
Gallery Panel Planning	xvi
Connection Types - Panel Doors	xvii
Connection Types - Sliding Doors	xviii
Connection Types - Fillers	xix
Wire Play Planning	xxi
Panels	2
Standard Panel - Monolithic	4
Non Powered Capable	4
Powered Capable	8
Standard - Glazed	12
Non Powered	12
Powered	28
Elevated - Monolithic	44
Elevated - Glazed	48
Gallery - Woodgrain	64
Horizontal Grain	64
Vertical Grain	76
Gallery - Solid	88
Frameless Blade	100
Standard & Elevated Panel Mounted Glass	100
Standard & Elevated Panel Mounted Acrylic	102
Gallery Panel Mounted Glass	104
Gallery Panel Mounted Acrylic	106

Panel Mounted Add Ons	108
Whiteboard	108
Tackboard	109
Doors	110
Hinged	110
Sliding	112
Connections & Trims	116
2-Way Connection	118
3-Way T Connection	119
4-Way X Connection	120
Top Cap	121
Full Height End Trim	122
Partial Height End Trim	123
Full Height T Filler	124
Partial Height T Filler	125
90 Degree Filler-Full Height	126
90 Degree Filler- Partial Height	127
Straight Filler	128
Gallery Panel Filler	129
Adjustable Wall Connector	130
Worksurfaces	132
Straight w/ grommet	134
Straight Worksurface w/o Grommet	136
Straight Worksurface w/ Wire Play	140
5-sided w/ Grommet	144
5-sided Worksurface w/Wire Play	146
Unitized w/ Grommet	148
Unitized w/ Wire Play	150
Transaction Top	152

Contents

Supports 154

Ladder Gable	156
Standard Panel	156
Gallery Panel	158
Freestanding Ladder Gable	160
Laminate Gable	161
Standard Panel	161
Gallery Panel	162
Freestanding	163
Worksurface Supports	164
Standard Panel	164
Gallery Panel	165
Tech Drop	166
Cantilever	167
Standard Panel	167
Gallery Panel	168
Standard Panel Mount Corner Bracket	170
Worksurface Supports	171
Storage	172
Fixed Credenza Support Bracket	173
90 Degree Storage Bracket	174
Horizontal Surface Support	175

Electrics 176

Power Module	178
Starter Harness	179
Connector Harness	180
Male to Female Extension Harness	182
New York Junction Box	183
Chicago Electrical Box	184
Power Pole	185
Communication Kit	186
Conversion Kit	187

Storage	188
Pedestals	190
Underdesk Pedestal	190
Mobile	191
Upholstered Seat Pad	192
Lateral File	193
Underdesk	193
Freestanding	194
Credenza	195
Open Lateral	195
Storage Tower	196
Wardrobe Tower	197
Combo Tower	198
w/ Front Access	198
w/ Side Access	200
Panel Mounted Overheads - Cabinet	202
Flipper	202
Hinged Door	203
Shared	204
Cubby	206
Metal Shelf	207
Accessories	208
Desktop Power Module	210
Tasklight	211
Monitor Arm	212
Keyboard Tray	213
Work Organizers	214
Accessory Rail	215
Pencil Tray	216

Statement of Line

Space Division

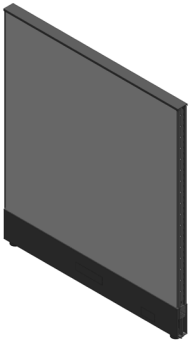

L-PPF0
Standard Fabric Panel
H: 34", 42", 50", 66", 82"
W: 24" - 72"
*66"H available up to 60"W
*82"H available up to 48"W



L-PPL0
Standard Laminate Panel
H: 34", 42", 50", 66", 82"
W: 24" - 48"
*82"H available up to 36"W



L-PPFCA/LPPFCG
L-PPFFA/L-PPFFG
Standard Segmented Fabric Panel
H: 34", 42", 50", 66", 82"
W: 24" - 60"
*82"H available up to 48"W



L-PPLCA/LPPLCG
L-PPLFA/L-PPLFG
Standard Segmented Laminate Panel
H: 34", 42", 50", 66", 82"
W: 24" - 60"
*82"H available up to 36"W

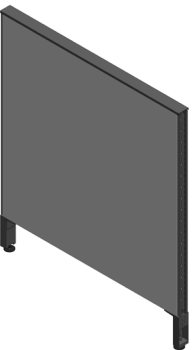

L-PEF0
Elevated Fabric Panel
H: 34", 42", 50", 66", 82"
W: 24" - 72"
*66"H available up to 60"W
*82"H available up to 48"W



L-PEL0
Elevated Laminate Panel
H: 34", 42", 50", 66", 82"
W: 24" - 48"
*82"H available up to 36"W

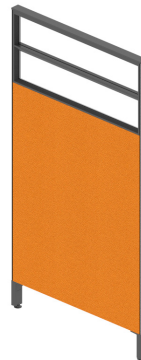

L-PEFCA/LPEFCG
L-PEFFA/L-PEFFG
Elevated Glazed Fabric Panel
H: 34", 42", 50", 66", 82"
W: 24" - 60"
*82"H available up to 48"W



L-PELCA/LPELCG
L-PELFA/L-PELFG
Elevated Glazed Laminate Panel
H: 34", 42", 50", 66", 82"
W: 24" - 60"
*82"H available up to 36"W

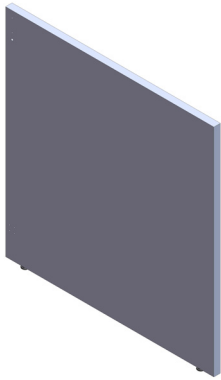

L-PYSE-S1/ L-PYSM-S1
Solid Single
Gallery Panel
H: 34", 42", 50"
W: 26" - 74"



L-PYGE-S1/L-PYSM-S1
Woodgrain Single
Gallery Panel
H: 34", 42", 50"
W: 26" - 56"



L-PD00
Hinge Door
H: 82"
W: 36", 42"

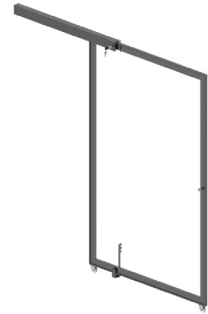

L-PDS
Sliding Door
H: 66"
W: 30", 36", 42"

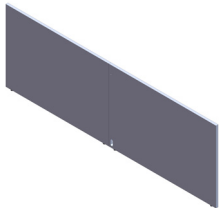

L-PYSE-D1/D2/ L-PYSM-D1/D2
Solid Double Gallery Panel
H: 34", 42", 50"
W: 42" - 146"



L-PYGE-01/02/ L-PYGM-D1/D2
Woodgrain Double Gallery
Panel
H: 34", 42", 50"
W: 42" - 110"

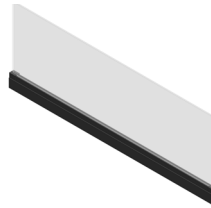

L-VG-P/ L-VA-P
Frameless Glass Standard
Panel Mount
H: 8", 16", 20"
W: 24" - 72"

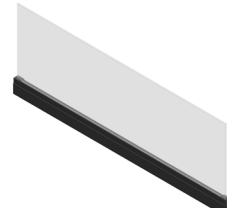

L-VG-Y/ L-VA-Y
Frameless Glass Gallery
Panel Mount
H: 8", 16"
W: 24" - 60"

Worksurface & Supports



L-HCB
Corner Bracket
H: 3"
W: 4"

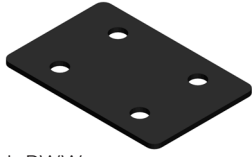

L-PWW
Mending Plate
D: 4"
W: 6"

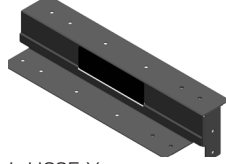

L-HSSE-Y
Return Support Gallery
Panel Mount with Power
H: 3"
W: 24", 30"

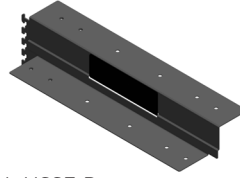

L-HSSE-P
Return Support Standard
Mount with Power
H: 3"
W: 24", 30"

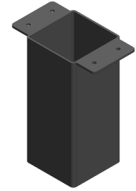

L-HCFM
Credenza Support
H: 6"
W: 4"



L-CCAB
Cantilever
H: 8"
D: 16", 22"

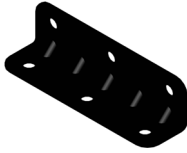

L-HSSB
Storage Support Bracket
H: 3"
D: 1"



L-WTT
Transaction Top
D: 15"
W: 24" - 60"



L-WS00
Straight Worksurface
W: 24" - 96"
D: 20", 24", 30"



L-WS00
Straight Worksurface with
Cropped Depth
W: 23" - 96"
D: 19" - 30"



L-WS0G
Straight Worksurface with
Grommets
W: 24" - 96"
D: 20", 24", 30"



L-WS00
5 Corner Curved Worksurface
with Grommet
A: 36" - 48"
B: 36" - 48"
C: 24" - 30"
D: 24" - 30"



5 Corner Curved Worksurface
with Double Hand Cropped
Depth
A: 35" - 47"
B: 35" - 47"
C: 23" - 39"
D: 23" - 29"



5 Corner Curved Worksurface
with Left Hand Cropped
Depth
A: 36" - 48"
B: 35" - 47"
C: 23" - 39"
D: 24" - 30"

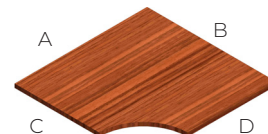

5 Corner Curved Worksurface
with Right Hand Cropped
Depth
A: 35" - 47"
B: 36" - 48"
C: 24" - 30"
D: 23" - 29"



5 Corner Straight Worksurface
with Grommet
A: 36" - 48"
B: 36" - 48"
C: 24" - 30"
D: 24" - 30"



5 Corner Straight Worksurface
with Double Hand Cropped
Depth
A: 35" - 47"
B: 35" - 47"
C: 23" - 39"
D: 23" - 29"

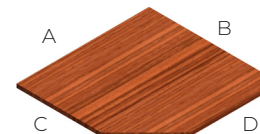

5 Corner Straight Worksurface
with Left Hand Cropped
Depth
A: 36" - 48"
B: 35" - 47"
C: 23" - 39"
D: 24" - 30"



5 Corner Straight Worksurface
with Right Hand Cropped
Depth
A: 35" - 47"
B: 36" - 48"
C: 24" - 30"
D: 23" - 29"



L-WUCG
Unitized Curved Worksurface
with Grommets
A: 36"
B: 54" - 96"
C: 24"
D: 24"
RH Shown

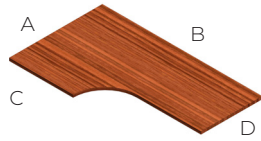

L-WUCO
Unitized Curved Worksurface
with Side A Cropped Depth
A: 35"
B: 54" - 96"
C: 24"
D: 23"
RH Shown

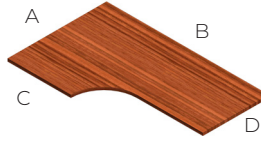

Unitized Curved Worksurface
with Side B Cropped Depth
A: 36"
B: 53" - 95"
C: 23"
D: 24"
RH Shown

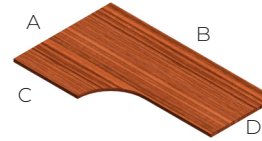

Unitized Curved Work-
surface with Side A & B
Cropped Depth
A: 35"
B: 53" - 95"
C: 23"
D: 23"
RH Shown



L-HOEG/ L-HOMG
Ladder Leg
H: 25", 28"
D: 20", 24", 30"



L-HCEG
Laminate Gable Leg
H: 25", 28"
D: 20", 24", 30"



L-HWEG
Wrap Gable
H: 25", 28"
D: 20", 24", 30"



L-HPGP/ L-HPSP
Pedestal to Panel
Bracket
H: 28"
W: 1", 7"

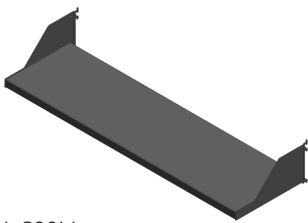

L-S00M
Steel Shelf
H: 6"
W: 30" - 60"
D: 12"

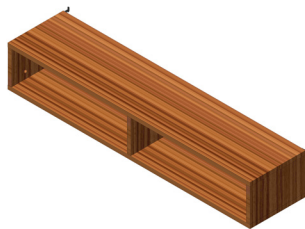

L-SCS
Cubby
H: 8"
W: 24" - 48"
D: 11"

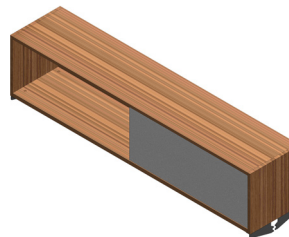

L-STOT/ L-STTO
Shared Overhead with Tack-
board
H: 16"
W: 36" - 72"
D: 15"



L-STMO/ L-STOM
Shared Overhead
H: 16"
W: 36" - 72"
D: 15"



L-SPLO/ L-SPOL
Split Overhead Cabinet
H: 16"
W: 36" - 60"
D: 12"

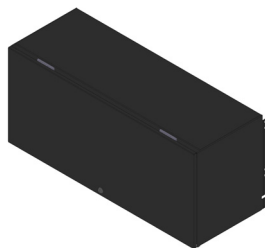

L-SPFL/ L-SPFM
Flipper Cabinet
H: 16"
W: 30" - 60"
D: 14"



L-FL2F
2D Freestanding Lateral
H: 29"
W: 30", 36"
D: 24"



L-FL3F
3D Freestanding
Lateral
H: 42"
W: 30", 36"
D: 24"



L-FL4F
4D Freestanding
Lateral
H: 54"
W: 30", 36"
D: 24"

Connections & Trims



L-HETF
Standard End Trim
H: 34", 42", 50", 66", 82"
W: 2"



L-HETF-CH
End Trim with Coat Hook
H: 34", 42", 50", 66"
W: 2"

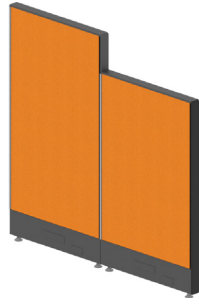

L-HETP
End Trim (Partial)
H: 8", 16", 24", 32", 40", 48"
W: 2"

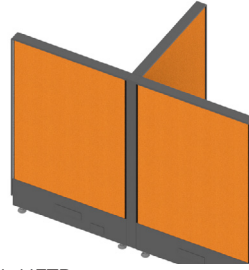

L-HFTR
T Filler (Full)
H: 34", 42", 50", 66", 82"
W: 2"

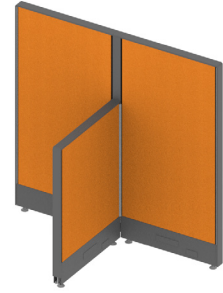

L-HFTP
T Filler (Partial)
H: 8", 16", 24", 32", 40", 48"
W: 2"

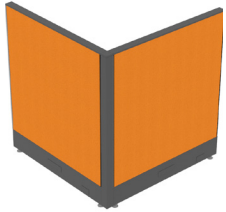

L-HFNR
90 Degree Filler (Full)
H: 34", 42", 50", 66", 82"
W: 2"

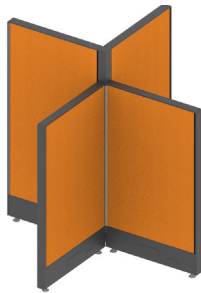

L-HFNP
90 Degree Filler (Partial)
H: 8", 16", 24", 32", 40", 48"
W: 2"



L-HFSP
Strait Filler (Partial)
H: 8", 16", 24", 32", 40", 48"
W: 2"



L-HW2/ L-HW4/ L-HW6
Wall Connector
H: 34", 42", 50", 66", 82"
W: 2", 4", 6"



L-HYP
Gallery Panel Filler
H: 8", 16", 24", 32", 40", 48"
W: 1"



L-HC2W-90-A
90 Degree A Panel Connector



L-HC2W-90-B
90 Degree B Panel Connector



L-HC2W-180-A
180 Degree A Panel Connector



L-HC2W-180-B
180 Degree B Panel Connector

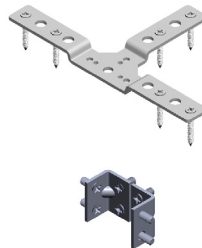

L-HC3W-A
3 Way A Panel Connector

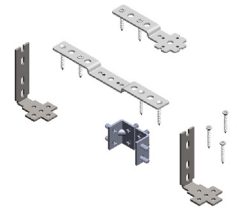

L-HC3W-B
3 Way B Panel Connector

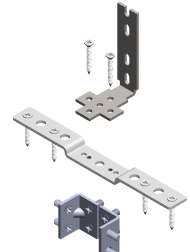

L-HC3W-C
3 Way C Panel Connector

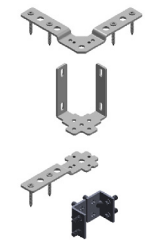

L-HC3W-D
3 Way D Panel Connector

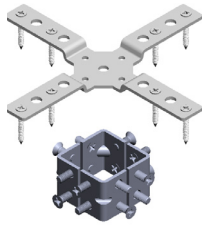

L-HC4W-A
4 Way A Panel Connector



L-HC4W-B
4 Way B Panel Connector

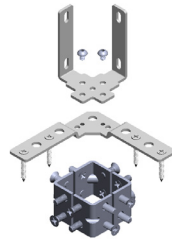

L-HC4W-C
4 Way C Panel Connector



L-HC4W-D
4 Way D Panel Connector

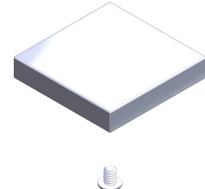

L-HUFC-02
Top Cap
H: 2"
W: 2"

Storage

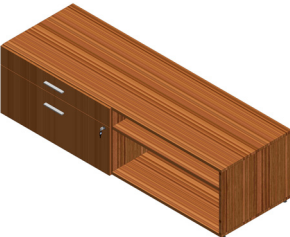

L-CRCL
Credenza
H: 20"
W: 48" - 72"
D: 18"



L-FL2U
2D Underdesk Lateral
H: 28"
W: 30", 36"
D: 23", 29"



L-FPBU
BBF Underdesk Pedestal
H: 28"
W: 16"
D: 23", 29"



L-FPFU
FF Underdesk Pedestal
H: 28"
W: 16"
D: 23", 29"



L-FPLO
BF Mobile Pedestal
H: 21"
W: 16"
D: 18"



L-FPLS
BF Mobile Pedestal with cushion
H: 22"
W: 16"
D: 18"

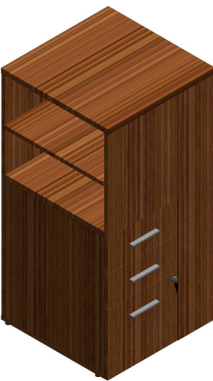

L-CWTB
Combination Storage Tower
H: 42", 50"
W: 24"
D: 24", 30"



L-CWTF
Combination Storage Tower
H: 42", 50"
W: 24"
D: 24", 30"



L-FTSS
Standard Storage Tower
H: 42", 50"
W: 18"
D: 24", 30"



L-FTCS
Wardrobe Tower
H: 42", 50"
W: 18"
D: 24", 30"

Electrics

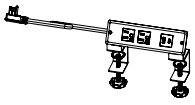

V-EMW-2AC
Clamp Mount Desktop
Power Module
L: 6"



V-EWHB
Horizontal Cable Manager
H: 1.5"
W: 12" - 72"



L-EP-P/ L-EP-Y
Power Pole
H: 96", 120", 144"
W: 2"



L-ES84
Starter
L: 72", 168"



L-EH84
Connector Harness
L: 22"-181"



L-E8FM
M/F Connector
L: 44", 122"

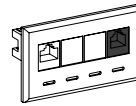

L-ECK1
Data/Com

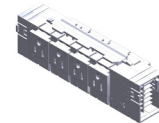

L-EM84
Power Module

Accessories



L-AR
Accessory Rail
H: 3"
W: 24" - 60"

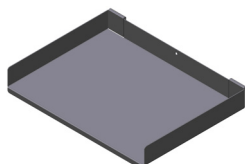

L-APP
Paper Tray
L: 11"
W: 9" - 13"

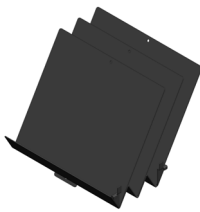

L-AAS
3 Division Paper Sorter
H: 11"
W: 10"
D: 10"



L-AAPO
Pen Holder
H: 4"
W: 4"
D: 2"

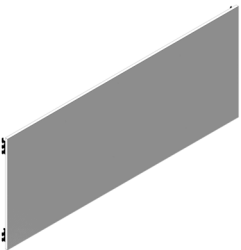

L-ATPO
Tackboard
H: 7", 15"
W: 24" - 60"

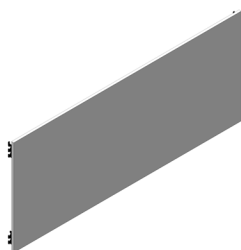

L-AWPO
Whiteboard
H: 15"
W: 24" - 60"

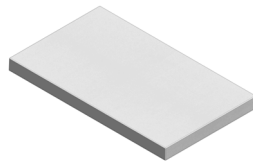

L-PAD
Upholstered Pad
L: 18"
W: 24" - 72"



V-AFMA-02
Dual Monitor Arm

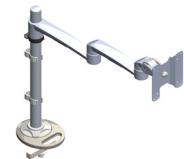

V-AFMA-01
Monitor Arm

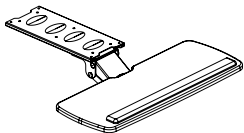

V-KASX
Keyboard Tray

Segment Types

Standard Panel

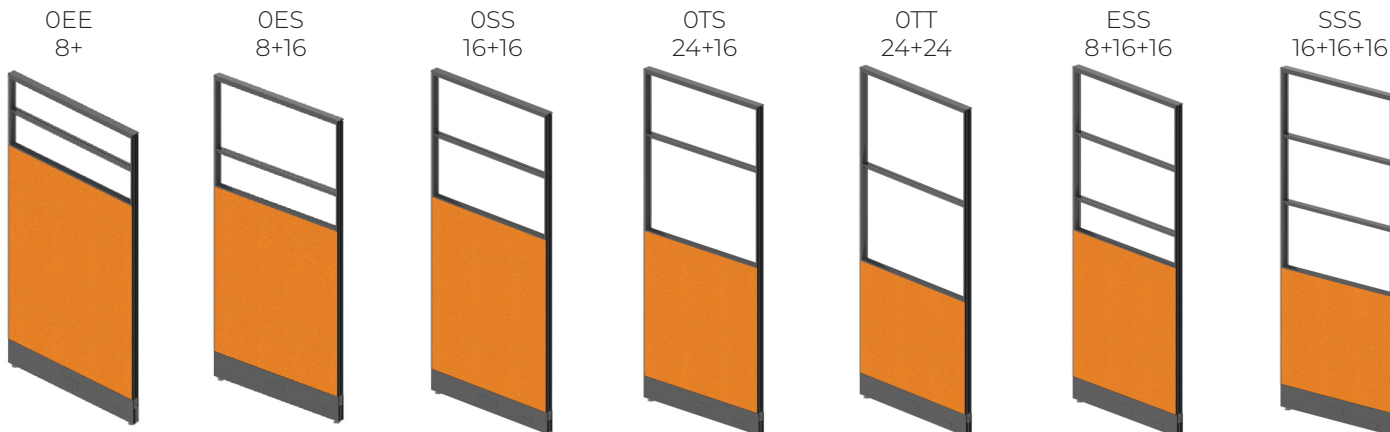

Elevated Panel

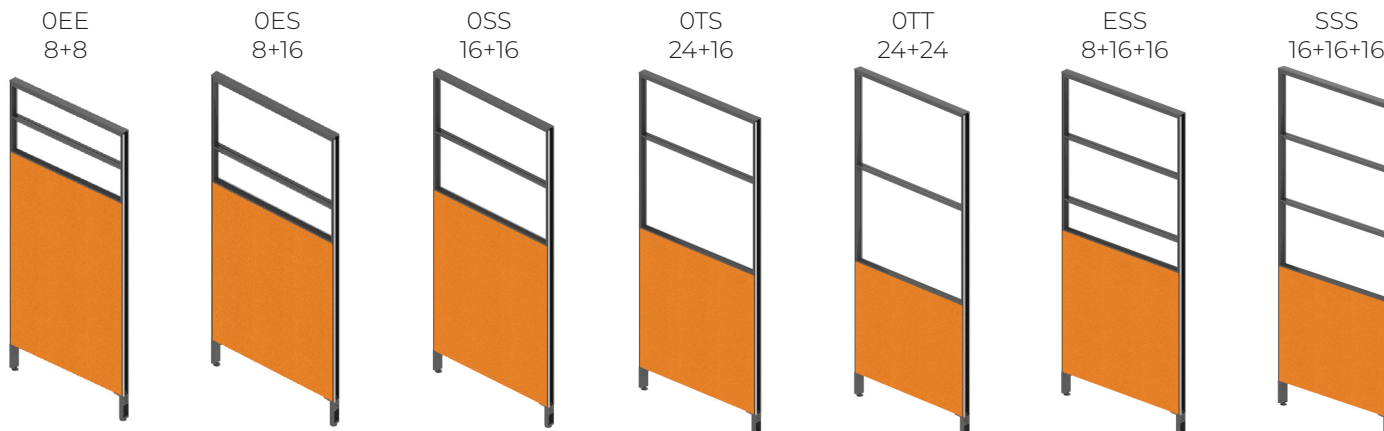

Caution

Load Bottom Drawer First

- Operate one drawer at a time
- Units may tip if loaded incorrectly
- Units should be attached to a wall or other furniture to reduce tipping hazard
- Always load the heaviest files in the bottom drawer

Heavy Load

- Some products must be anchored to wall to ensure stability & safety.
- It is the owner and installers responsibility to ensure that the wall type and construction is of sufficient strength to carry the loads of any wall mounted products and their contents.
- Failure of the wall and anchors to support all imposed loads may result in property damage and/or personal injury.
- Tayco can provide size and empty weight of its products only. As wall blocking is considered a building construction process, Tayco cannot provide recommendations in this respect and cannot be responsible for damage or injury that may occur as a result of improper installation and/or blocking.

Instability Hazard

Mobile items on casters such as flip top, personal and movable tables of any type and storage items of any type may present an instability hazard if not secured correctly while in use or in storage. Flip top tables or training tables of any type, are inherently more unstable when folded. Tayco provides the following guidelines & warnings when using mobile products:

- Lock casters immediately after moving. Do not leave the casters unlocked when in use or in storage.
- Motion may increase the instability of any item with casters. If the wheels hit an obstruction the table's forward momentum often causes overturn, especially if the item is not equipped with wheel extensions. Exercise strong caution while moving these items.
- Use caution when abrupt level changes in the floor are present (such as a doorway or room threshold) as caster failure or tipping may result.
- Do not stand, sit or lean on mobile items for support. They are not intended for this use and personal injury or property damage may result.
- Mobile units that feature height adjustable elements must be lowered to the minimum compressed height when moving to prevent instability. It is also recommended the user remove all computer equipment or other accessories to prevent possible weight imbalance or damage to equipment.
- Failure to follow the guidelines above may result in property damage or personal injury.

Types of Surfaces

no grommet

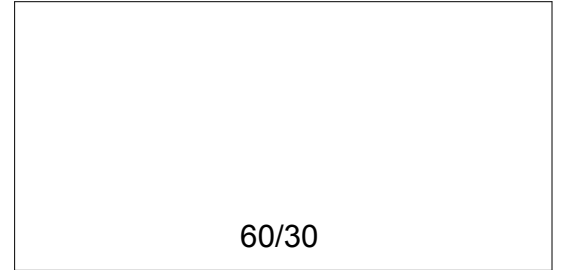
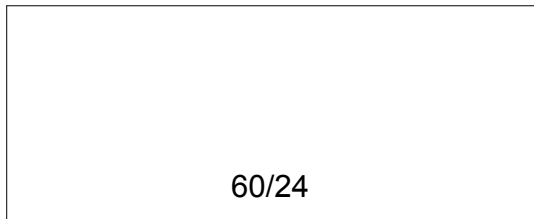

with grommet

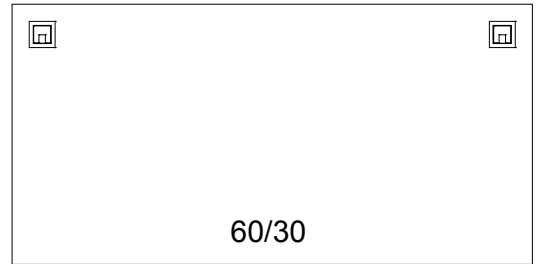
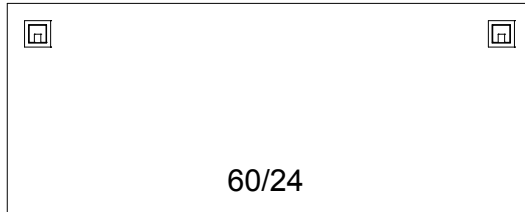

wireplay

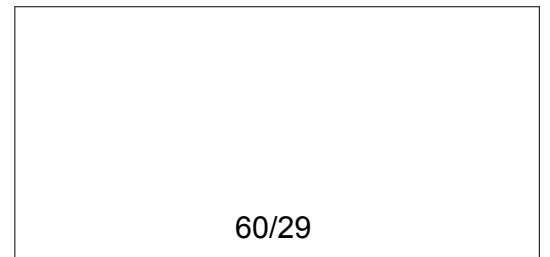
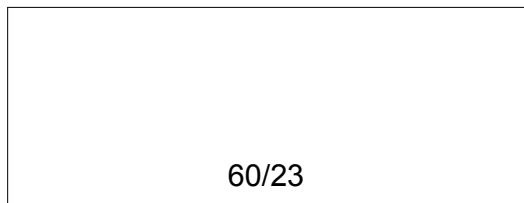

Gallery Panel Planning

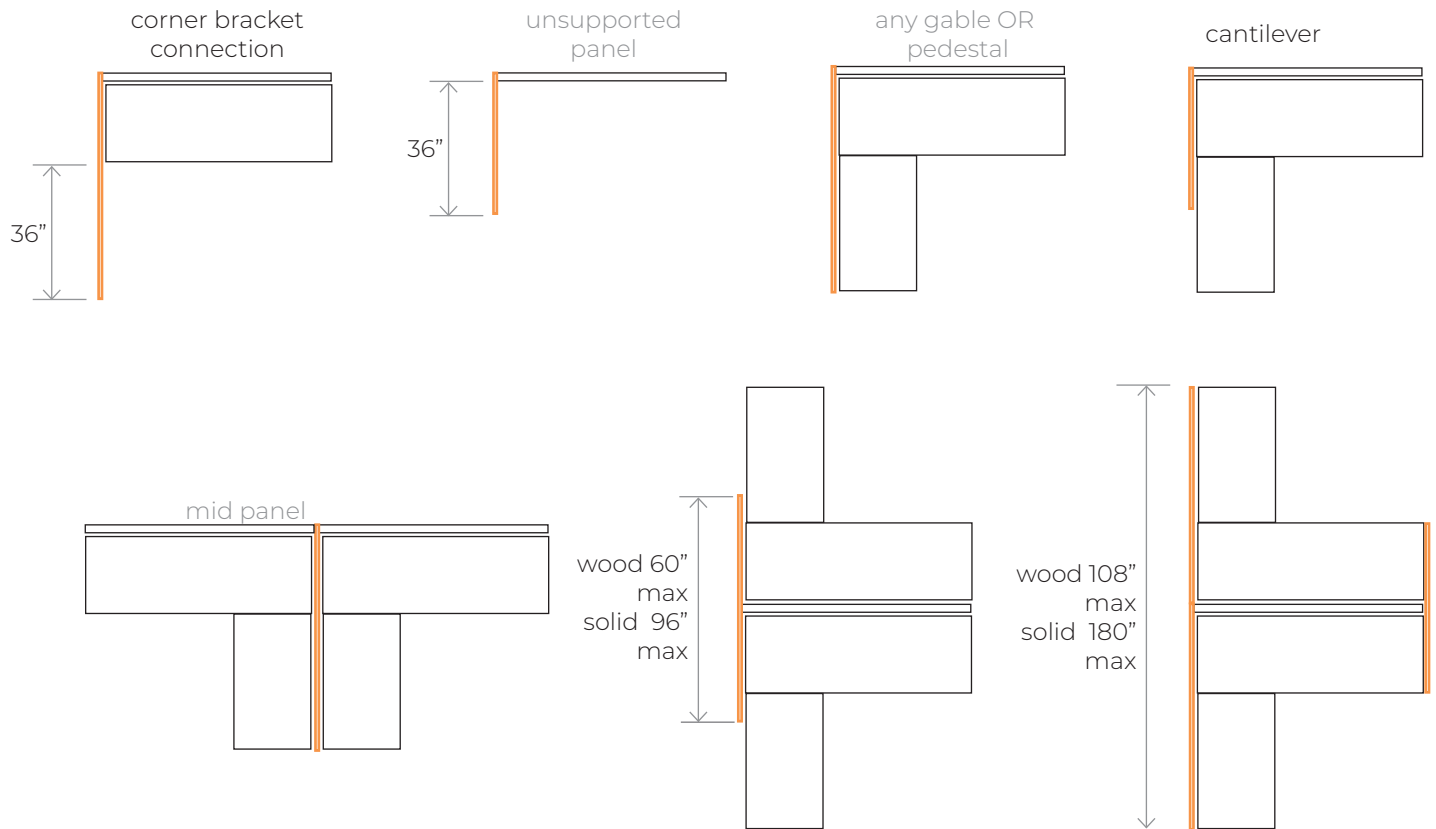

Connection Types - Panel Doors

2-Way 90° Connection

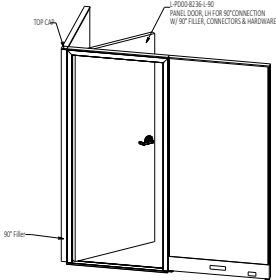
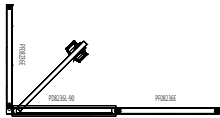

2-Way 180° Connection

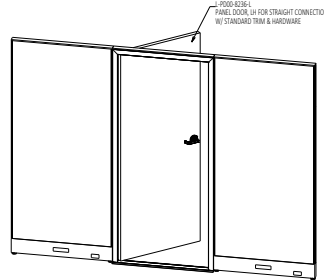
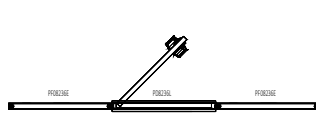

3-Way Connection, 1 Door

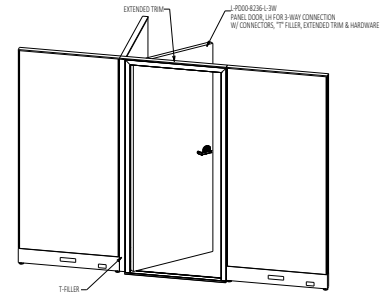
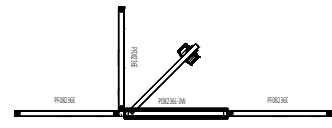

3-Way Connection, 2 Doors

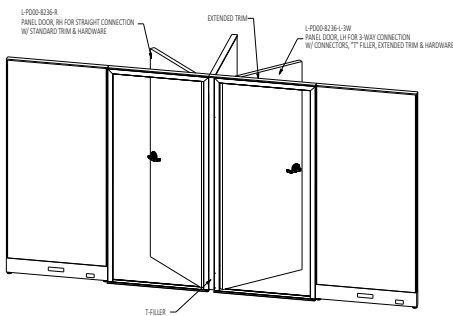
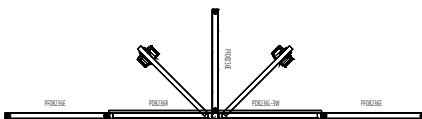

4-Way Connection, 1 Door

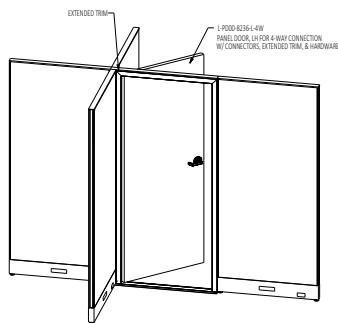
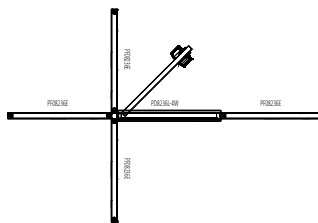

4-Way Connection, 2 Doors

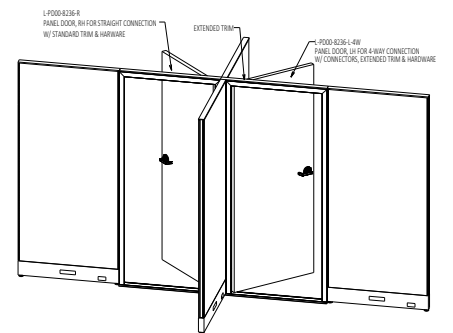
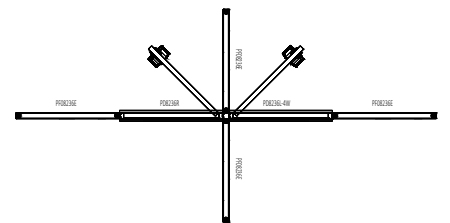

Connection Types - Sliding Doors

2-Way 90° Connection

2-Way 180° Connection

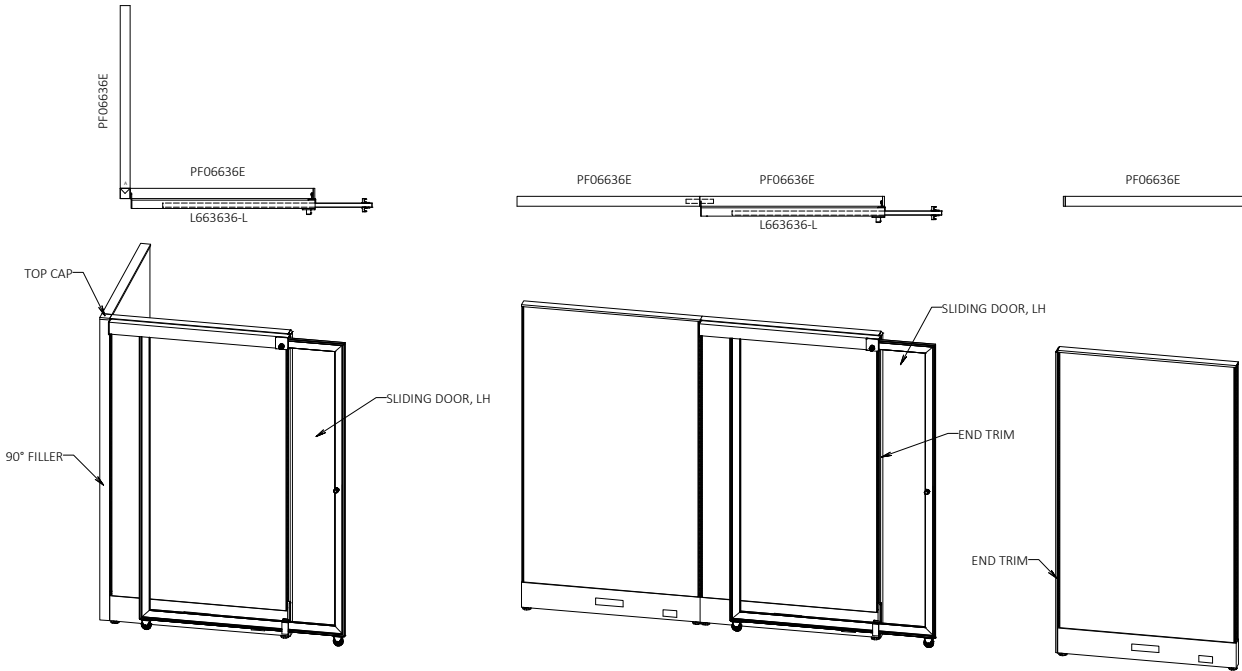

3-Way Connection, 1 Door

3-Way Connection, 2 Doors

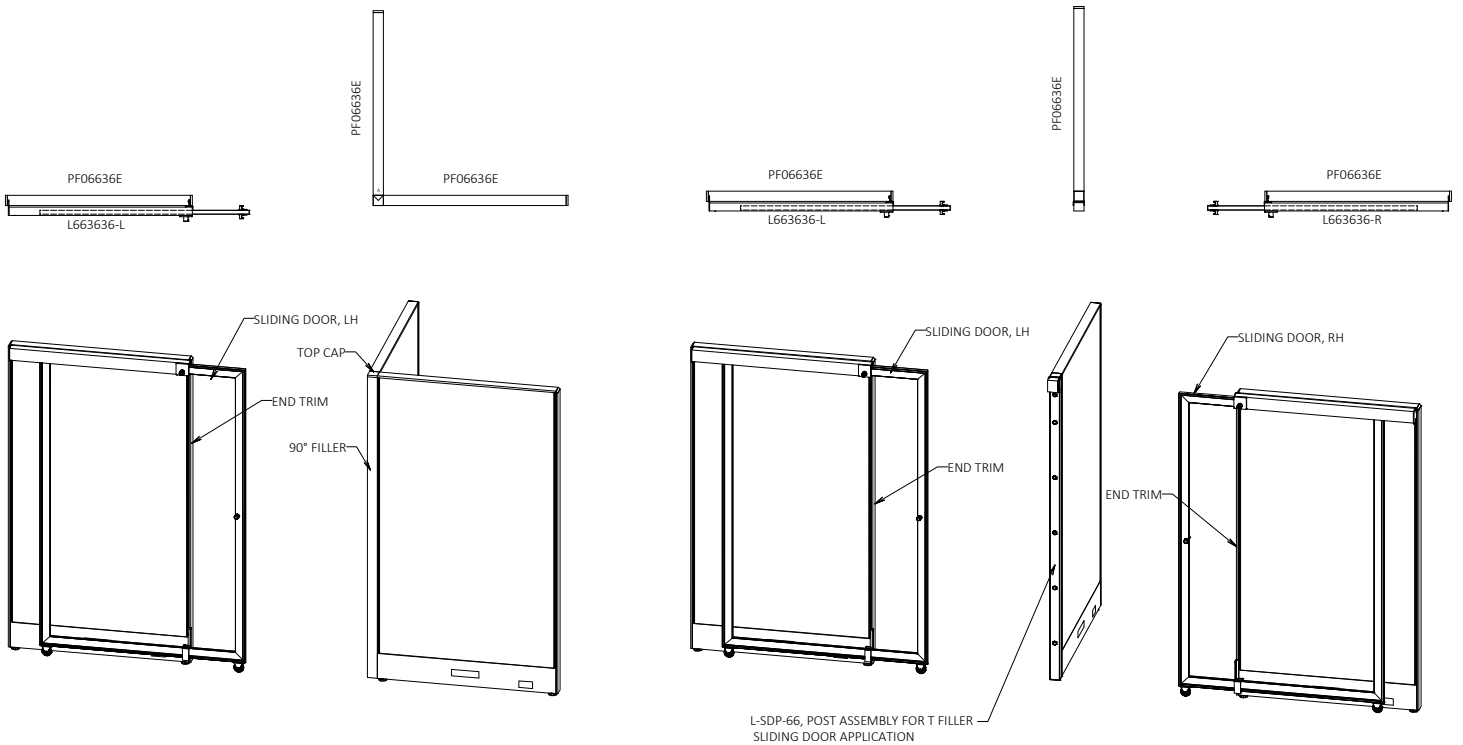

Connection Types - Fillers

2-Way 90° Connection

Type A Connection

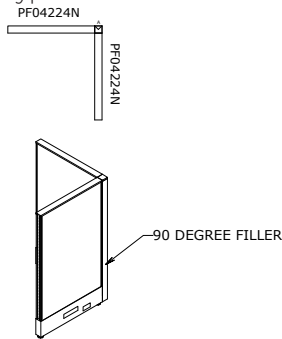

Type B Connection

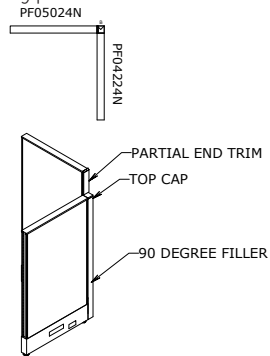

2-Way 180° Connection

Type A Connection

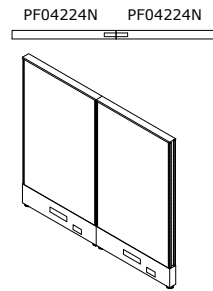

Type B Connection

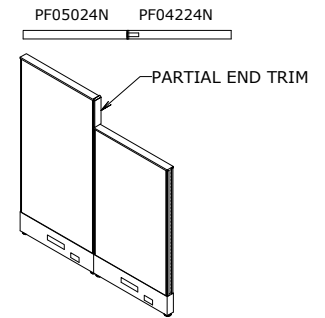

3-Way Connection

Type A Connection

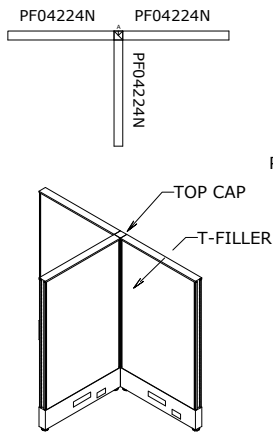

Type B Connection

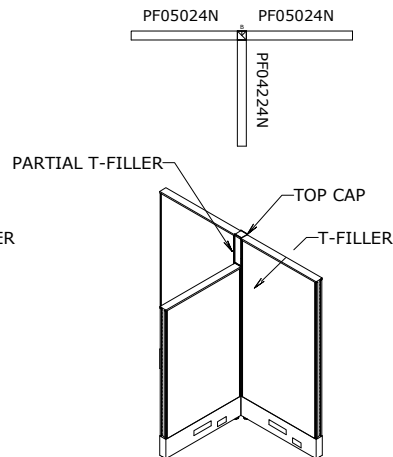

Type C Connection

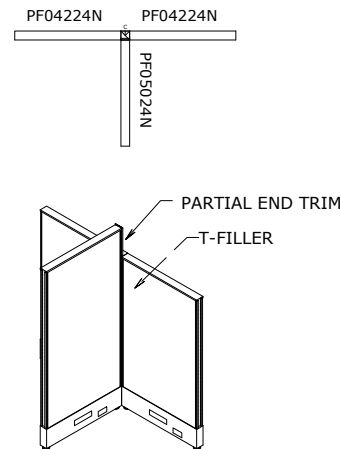

Type D Connection

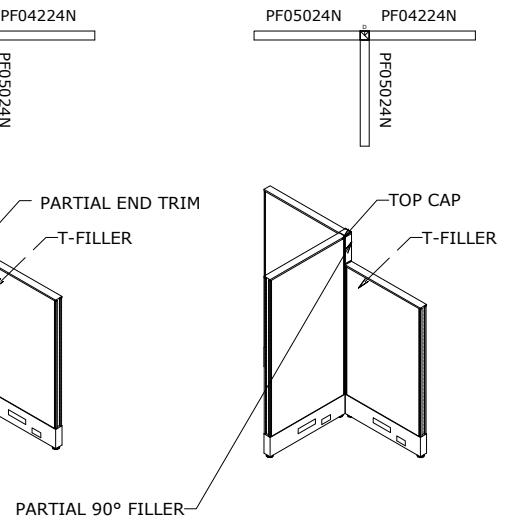

4-Way Connection

Type A Connection

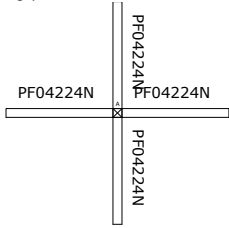

Type B Connection

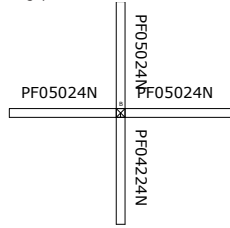

Type C Connection

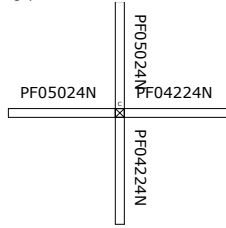

Type D Connection

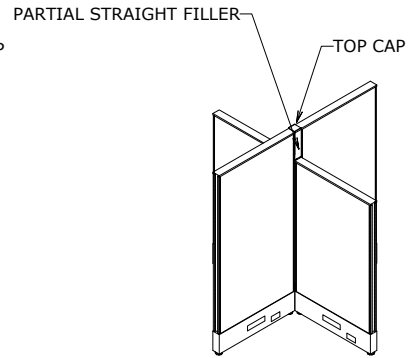
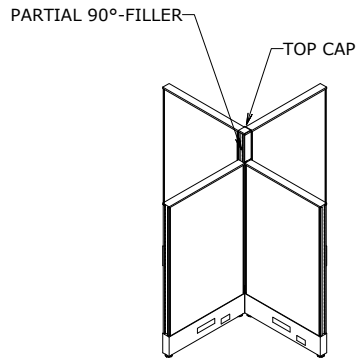
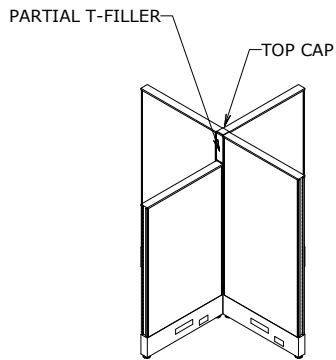
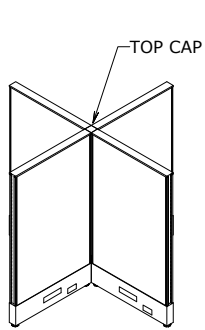
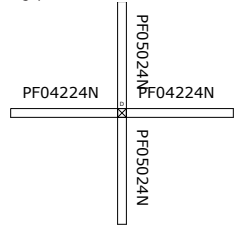

Wire Play Planning

1" wire play along spine

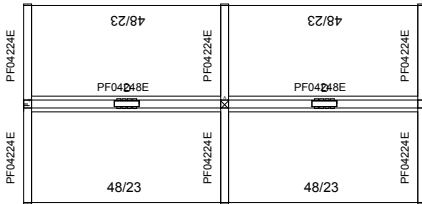

1" wire play along spine

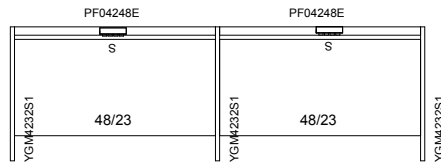

1" wire play along all surfaces

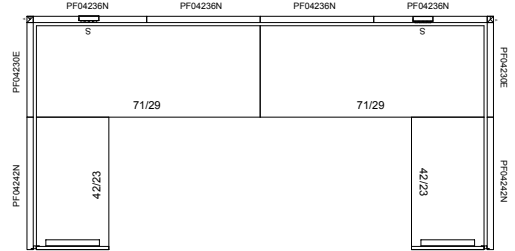

1" wire play along all surfaces

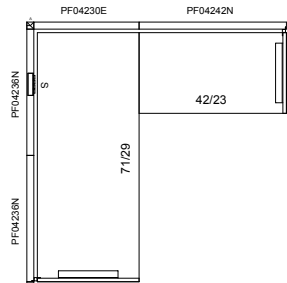

1" wire play along return

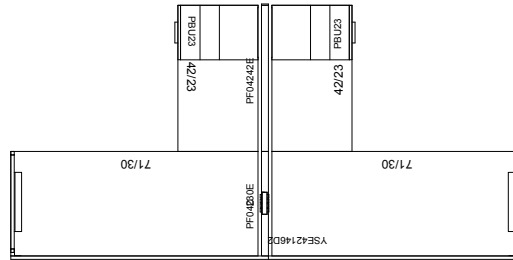

1" wire play along spine

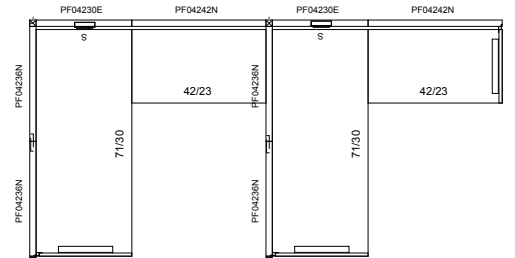

1" wire play along spine and
worksurface

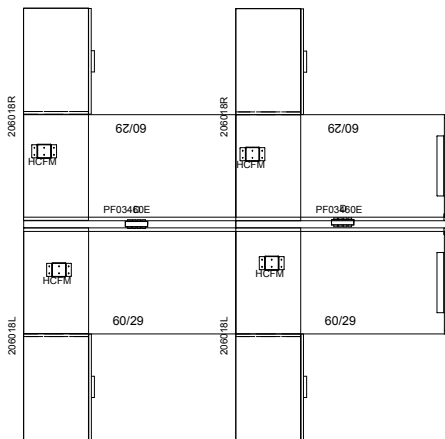

1" wire play along spine and
worksurface

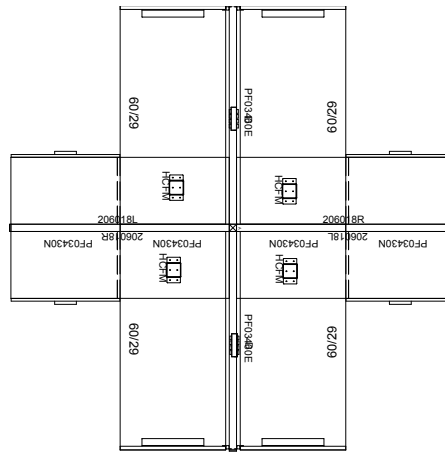



Switch Canada Pricebook
June 2026

Panels

Standard Panel - Monolithic	4	Gallery - Woodgrain	64
Non Powered Capable	4	Horizontal Grain	64
Fabric	4	Single Span Middle	64
Laminate	6	Double Span Middle	66
Powered Capable	8	Single Span End /No Cutout	68
Fabric	8	Single Span End/w Cutout	70
Laminate	10	Double Span End /No Cutout	72
Standard - Glazed	12	Double Span End/w Cutout	74
Non Powered	12	Vertical Grain	76
Fabric/Clear Acrylic	12	Single Span Middle	76
Fabric/Frosted Acrylic	14	Double Span Middle	78
Fabric/Clear Glass	16	Single Span End /No Cutout	80
Fabric/Frosted Glass	18	Single Span End /w Cutout	82
Laminate/Clear Acrylic	20	Double Span End/No Cutout	84
Laminate/Frosted Acrylic	22	Double Span End /w Cutout	86
Laminate/Clear Glass	24	Gallery - Solid	88
Laminate/Frosted Glass	26	Single Span Middle	88
Powered	28	Double Span Middle	90
Fabric/Clear Acrylic	28	Single Span End /No Cutout	92
Fabric/Frosted Acrylic	30	Single Span End /w Cutout	94
Fabric/Clear Glass	32	Double Span End/No Cutout	96
Fabric/Frosted Glass	34	Double Span End /w Cutout	98
Laminate/Clear Acrylic	36	Frameless Blade	100
Laminate/Frosted Acrylic	38	Standard & Elevated	
Laminate/Clear Glass	40	Panel Mounted Glass	100
Laminate/Frosted Glass	42	Standard & Elevated	
Elevated - Monolithic	44	Panel Mounted Acrylic	102
Fabric	44	Gallery Panel Mounted Glass	104
Laminate	46	Gallery Panel Mounted Acrylic	106
Elevated - Glazed	48	Panel Mounted Add Ons	108
Fabric/Clear Acrylic	48	Whiteboard	108
Fabric/Frosted Acrylic	50	Tackboard	109
Fabric/Clear Glass	52	Doors	110
Fabric/Frosted Glass	54	Hinged	110
Laminate/Clear Acrylic	56	Sliding	112
Laminate/Frosted Acrylic	58	Clear Acrylic	113
Laminate/Clear Glass	60	Frosted Acrylic	114
Laminate/Frosted Glass	62	Fluted Acrylic	115

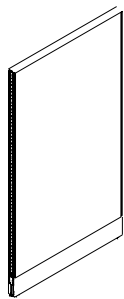

Standard Monolithic
Non-Powered Fabric Panel

What's Included:

One (1) 2" thick fabric panel with
1" incremented slotted channels,
Two (2) raceway covers,
One (1) top trim

How to Specify:

Refer to panel fabric cards for fabric selections
Choose White, Black, Silver, Charcoal for Panel
Frame colour

Notes:

Non-power capable panel.
Can be used in run with power-capable
panels and allows wires to pass through.
Panels are non tackable. For tackable
option see Panel Add-On section.
Fabric Upcharge
Grade 2 - \$216 per panel,
Grade 3 - \$266 per panel

Options:

Height*: 34", 42", 50", 66", 82"

Width: 24", 30", 36", 42", 48", 54", 60", 66", 72"

Fabric

Metal Powder Coat Paint: White, Black, Silver, Charcoal

*34" high - 50" high available up to 72" wide, 66" high available up to 60" wide, 82" high available up to 48" wide

Code	Price	H	W	D	Weight (lb.)	Volume (ft ³)
L-PPF0-3424-N	643	34	24	2	16.32	0.94
L-PPF0-3430-N	687	34	30	2	20.40	1.18
L-PPF0-3436-N	782	34	36	2	24.48	1.42
L-PPF0-3442-N	821	34	42	2	28.56	1.65
L-PPF0-3448-N	857	34	48	2	32.64	1.89
L-PPF0-3454-N	899	34	54	2	36.72	2.13
L-PPF0-3460-N	933	34	60	2	40.80	2.36
L-PPF0-3466-N	1344	34	66	2		
L-PPF0-3472-N	1429	34	72	2		

Code	Price	H	W	D	Weight (lb.)	Volume (ft ³)
L-PPF0-4224-N	643	42	24	2	20.16	1.17
L-PPF0-4230-N	687	42	30	2	25.20	1.46
L-PPF0-4236-N	782	42	36	2	30.24	1.75
L-PPF0-4242-N	821	42	42	2	35.28	2.04
L-PPF0-4248-N	857	42	48	2	40.32	2.33
L-PPF0-4254-N	899	42	54	2	45.36	2.63
L-PPF0-4260-N	933	42	60	2	50.40	2.92
L-PPF0-4266-N	1344	42	66	2		
L-PPF0-4272-N	1429	42	72	2		
L-PPF0-5024-N	673	50	24	2	24.00	1.39
L-PPF0-5030-N	714	50	30	2	30.00	1.74
L-PPF0-5036-N	796	50	36	2	36.00	2.08
L-PPF0-5042-N	857	50	42	2	42.00	2.43
L-PPF0-5048-N	907	50	48	2	48.00	2.78
L-PPF0-5054-N	952	50	54	2	54.00	3.13
L-PPF0-5060-N	989	50	60	2	60.00	3.47
L-PPF0-5066-N	1384	50	66	2		
L-PPF0-5072-N	1460	50	72	2		
L-PPF0-6624-N	738	66	24	2	31.68	1.83
L-PPF0-6630-N	804	66	30	2	39.60	2.29
L-PPF0-6636-N	863	66	36	2	47.52	2.75
L-PPF0-6642-N	923	66	42	2	55.44	3.21
L-PPF0-6648-N	981	66	48	2	63.36	3.67
L-PPF0-6654-N	1046	66	54	2	71.28	4.13
L-PPF0-6660-N	1104	66	60	2	79.20	4.58
L-PPF0-8224-N	1071	82	24	2		
L-PPF0-8230-N	1149	82	30	2		
L-PPF0-8236-N	1392	82	36	2		
L-PPF0-8242-N	1465	82	42	2		
L-PPF0-8248-N	1540	82	48	2		



Standard Monolithic
Non-Powered Laminate
Panel

What's Included:

One (1) 2" thick laminate panel with
1" incremented slotted channels,
Two (2) raceway covers,
One (1) top trim

How to Specify:

Refer to laminate cards for laminate
selections Choose White, Black, Silver, Charcoal
for Panel Frame colour

Notes:

Non-power capable panel.
Can be used in run with power-capable
panels and allows wires to pass through.
Panels are non tackable. For tackable
option see Panel Add-On section.

Options:

Height*: 34", 42", 50", 66", 82"

Width: 24", 30", 36", 42", 48"

Fabric

Metal Powder Coat Paint: White, Black, Silver, Charcoal

*82" high available up to 36" wide

Code	Price	H	W	D	Weight (lb.)	Volume (ft ³)
L-PPL0-3424-N	738	34	24	2	16.32	0.94
L-PPL0-3430-N	800	34	30	2	20.40	1.18
L-PPL0-3436-N	862	34	36	2	24.48	1.42
L-PPL0-3442-N	933	34	42	2	28.56	1.65
L-PPL0-3448-N	1004	34	48	2	32.64	1.89
L-PPL0-4224-N	789	42	24	2	20.16	1.17
L-PPL0-4230-N	852	42	30	2	25.20	1.46
L-PPL0-4236-N	911	42	36	2	30.24	1.75
L-PPL0-4242-N	1006	42	42	2	35.28	2.04
L-PPL0-4248-N	1053	42	48	2	40.32	2.33
L-PPL0-5024-N	867	50	24	2	24.00	1.39
L-PPL0-5030-N	937	50	30	2	30.00	1.74
L-PPL0-5036-N	1007	50	36	2	36.00	2.08
L-PPL0-5042-N	1151	50	42	2	42.00	2.43
L-PPL0-5048-N	1184	50	48	2	48.00	2.78
L-PPL0-6624-N	970	66	24	2	31.68	1.83
L-PPL0-6630-N	1058	66	30	2	39.60	2.29
L-PPL0-6636-N	1148	66	36	2	47.52	2.75
L-PPL0-6642-N	1319	66	42	2	55.44	3.21
L-PPL0-6648-N	1358	66	48	2	63.36	3.67
L-PPL0-8224-N	1196	82	24	2		
L-PPL0-8230-N	1214	82	30	2		
L-PPL0-8236-N	1522	82	36	2		

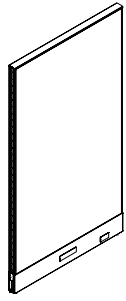

Standard Monolithic
Powered Fabric Panel

What's Included:

One (1) 2" thick fabric panel with 1" incremented slotted channels, Two (2) raceway covers, One (1) top trim

How to Specify:

Refer to panel fabric cards for fabric selections
Choose White, Black, Silver, Charcoal for Panel Frame colour

Notes:

Power capable panel with bracket for power module.

Power module must be specified separately.

Panels are non tackable. For tackable option see Panel Add-On section.

Fabric Upcharge
Grade 2 - \$216 per panel,
Grade 3 - \$266 per panel

Options:

Height*: 34", 42", 50", 66", 82"

Width: 24", 30", 36", 42", 48", 54", 60", 66", 72"

Fabric

Metal Powder Coat Paint: White, Black, Silver, Charcoal

*34" high - 50" high available up to 72" wide, 66" high available up to 60" wide, 82" high available up to 48" wide

Code	Price	H	W	D	Weight (lb.)	Volume (ft ³)
L-PPF0-3424-E	675	34	24	2	16.32	0.94
L-PPF0-3430-E	713	34	30	2	20.40	1.18
L-PPF0-3436-E	809	34	36	2	24.48	1.42
L-PPF0-3442-E	852	34	42	2	28.56	1.65
L-PPF0-3448-E	883	34	48	2	32.64	1.89
L-PPF0-3454-E	928	34	54	2	36.72	2.13
L-PPF0-3460-E	962	34	60	2	40.80	2.36
L-PPF0-3466-E	1370	34	66	2		
L-PPF0-3472-E	1453	34	72	2		

Code	Price	H	W	D	Weight (lb.)	Volume (ft ³)
L-PPF0-4224-E	675	42	24	2	20.16	1.17
L-PPF0-4230-E	713	42	30	2	25.20	1.46
L-PPF0-4236-E	809	42	36	2	30.24	1.75
L-PPF0-4242-E	852	42	42	2	35.28	2.04
L-PPF0-4248-E	883	42	48	2	40.32	2.33
L-PPF0-4254-E	928	42	54	2	45.36	2.63
L-PPF0-4260-E	962	42	60	2	50.40	2.92
L-PPF0-4266-E	1370	42	66	2		
L-PPF0-4272-E	1453	42	72	2		
L-PPF0-5024-E	699	50	24	2	24.00	1.39
L-PPF0-5030-E	740	50	30	2	30.00	1.74
L-PPF0-5036-E	825	50	36	2	36.00	2.08
L-PPF0-5042-E	883	50	42	2	42.00	2.43
L-PPF0-5048-E	934	50	48	2	48.00	2.78
L-PPF0-5054-E	978	50	54	2	54.00	3.13
L-PPF0-5060-E	1016	50	60	2	60.00	3.47
L-PPF0-5066-E	1409	50	66	2		
L-PPF0-5072-E	1486	50	72	2		
L-PPF0-6624-E	766	66	24	2	31.68	1.83
L-PPF0-6630-E	831	66	30	2	39.60	2.29
L-PPF0-6636-E	889	66	36	2	47.52	2.75
L-PPF0-6642-E	950	66	42	2	55.44	3.21
L-PPF0-6648-E	1008	66	48	2	63.36	3.67
L-PPF0-6654-E	1071	66	54	2	71.28	4.13
L-PPF0-6660-E	1131	66	60	2	79.20	4.58
L-PPF0-8224-E	1119	82	24	2		
L-PPF0-8230-E	1197	82	30	2		
L-PPF0-8236-E	1438	82	36	2		
L-PPF0-8242-E	1513	82	42	2		
L-PPF0-8248-E	1588	82	48	2		



Standard Monolithic
Powered Laminate
Panel

What's Included:

One (1) 2" thick flaminite panel with
1" incremented slotted channels,
Two (2) raceway covers,
One (1) top trim

How to Specify:

Refer to laminate cards for laminate selections
Choose White, Black, Silver, Charcoal for Panel
Frame colour

Notes:

Power capable panel with bracket for
power module.
Power module must be specified
seperately.
Panels are non tackable. For tackable
option see Panel Add-On section.

Options:

Height*: 34", 42", 50", 66", 82"

Width: 24", 30", 36", 42", 48",

Laminate

Metal Powder Coat Paint: White, Black, Silver, Charcoal

*82"H available up to 36"W

Code	Price	H	W	D	Weight (lb.)	Volume (ft ³)
L-PPL0-3424-E	765	34	24	2	16.32	0.94
L-PPL0-3430-E	826	34	30	2	20.40	1.18
L-PPL0-3436-E	888	34	36	2	24.48	1.42
L-PPL0-3442-E	959	34	42	2	28.56	1.65
L-PPL0-3448-E	1030	34	48	2	32.64	1.89
L-PPL0-4224-E	814	42	24	2	20.16	1.17
L-PPL0-4230-E	876	42	30	2	25.20	1.46
L-PPL0-4236-E	937	42	36	2	30.24	1.75
L-PPL0-4242-E	1033	42	42	2	35.28	2.04
L-PPL0-4248-E	1081	42	48	2	40.32	2.33
L-PPL0-5024-E	892	50	24	2	24.00	1.39
L-PPL0-5030-E	965	50	30	2	30.00	1.74
L-PPL0-5036-E	1033	50	36	2	36.00	2.08
L-PPL0-5042-E	1182	50	42	2	42.00	2.43
L-PPL0-5048-E	1210	50	48	2	48.00	2.78
L-PPL0-6624-E	997	66	24	2	31.68	1.83
L-PPL0-6630-E	1088	66	30	2	39.60	2.29
L-PPL0-6636-E	1173	66	36	2	47.52	2.75
L-PPL0-6642-E	1344	66	42	2	55.44	3.21
L-PPL0-6648-E	1385	66	48	2	63.36	3.67
L-PPL0-8224-E	1211	82	24	2		
L-PPL0-8230-E	1230	82	30	2		
L-PPL0-8236-E	1548	82	36	2		

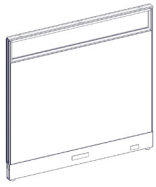

OOE-N
One 8" clear acrylic segment on top



OOS-N
One 16" clear acrylic segment on top

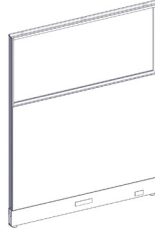

OOT-N
One 24" clear acrylic segment on top



OEE-N
Two 8" clear acrylic segments on top

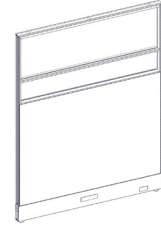

OES-N
One 8" & One 16" clear acrylic segment on top



OSS-N
Two 16" clear acrylic segments on top



OTS-N
One 24" & One 16" clear acrylic segment on top



OTT-N
Two 24" clear acrylic segments on top



ESS-N
One 8" & Two 16" clear acrylic segments on top



SSS-N
Three 16" clear acrylic segments on top

How to order and read your code

L - P P F C A - 42 24 - 0 0 E - N

product standard line

P= glazed
E = Elevated

F=Fabric
L=Laminate

C=Clear
F=Frosted
G=Glass

A=Acrylic height width

0 = No segment
E = 8 inch segment
S = 16 inch segment
T = 24 inch segment

N=Non powered
E=Powered

What's Included:

One (1) 2" thick fabric panel with 1" incremented slotted channels, Two (2) raceway covers, One (1) top trim

How to Specify:

Refer to panel fabric cards for fabric selections
Choose White, Black, Silver, Charcoal for Panel Frame colour

Notes:

Power capable panel with bracket for power module.
Power module must be specified separately.
Panels are non tackable. For tackable option see Panel Add-On section.
Fabric Upcharge
Grade 2 - \$216 per panel,
Grade 3 - \$266 per panel

Options:

Height*: 34", 42", 50", 66", 82"

Width: 24", 30", 36", 42", 48", 54", 60", 66", 72"

Fabric

Metal Powder Coat Paint: White, Black, Silver, Charcoal

*34" high - 50" high available up to 72" wide, 66" high available up to 60" wide, 82" high available up to 48" wide

Code	Price	H	W	D
One 8" clear acrylic segment on top				
L-PPFCA-4224-00E-N	1243	42	24	2
L-PPFCA-4230-00E-N	1328	42	30	2
L-PPFCA-4236-00E-N	1381	42	36	2
L-PPFCA-4242-00E-N	1436	42	42	2
L-PPFCA-4248-00E-N	1493	42	48	2
L-PPFCA-4254-00E-N	1585	42	54	2
L-PPFCA-4260-00E-N	1618	42	60	2
L-PPFCA-5024-00E-N	1243	50	24	2
L-PPFCA-5030-00E-N	1328	50	30	2
L-PPFCA-5036-00E-N	1381	50	36	2
L-PPFCA-5042-00E-N	1436	50	42	2
L-PPFCA-5048-00E-N	1493	50	48	2
L-PPFCA-5054-00E-N	1585	50	54	2
L-PPFCA-5060-00E-N	1618	50	60	2
One 16" clear acrylic segment on top				
L-PPFCA-5024-00S-N	1243	50	24	2
L-PPFCA-5030-00S-N	1328	50	30	2
L-PPFCA-5036-00S-N	1381	50	36	2
L-PPFCA-5042-00S-N	1436	50	42	2
L-PPFCA-5048-00S-N	1493	50	48	2
L-PPFCA-5054-00S-N	1585	50	54	2
L-PPFCA-5060-00S-N	1618	50	60	2
L-PPFCA-6624-00S-N	1372	66	24	2
L-PPFCA-6630-00S-N	1473	66	30	2
L-PPFCA-6636-00S-N	1564	66	36	2
L-PPFCA-6642-00S-N	1651	66	42	2
L-PPFCA-6648-00S-N	1730	66	48	2
L-PPFCA-6654-00S-N	1876	66	54	2
L-PPFCA-6660-00S-N	1913	66	60	2
L-PPFCA-8224-00S-N	1751	82	24	2
L-PPFCA-8230-00S-N	2030	82	30	2
L-PPFCA-8236-00S-N	2137	82	36	2
L-PPFCA-8242-00S-N	2188	82	42	2
L-PPFCA-8248-00S-N	2284	82	48	2
One 24" clear acrylic segment on top				
L-PPFCA-6624-00T-N	1372	66	24	2
L-PPFCA-6630-00T-N	1473	66	30	2
L-PPFCA-6636-00T-N	1564	66	36	2
L-PPFCA-6642-00T-N	1651	66	42	2
L-PPFCA-6648-00T-N	1730	66	48	2
L-PPFCA-6654-00T-N	1876	66	54	2
L-PPFCA-6660-00T-N	1913	66	60	2

Code	Price	H	W	D
Two 8" clear acrylic segments on top				
L-PPFCA-6624-0EE-N	1728	66	24	2
L-PPFCA-6630-0EE-N	1958	66	30	2
L-PPFCA-6636-0EE-N	2040	66	36	2
L-PPFCA-6642-0EE-N	2106	66	42	2
L-PPFCA-6648-0EE-N	2199	66	48	2
L-PPFCA-6654-0EE-N	2338	66	54	2
L-PPFCA-6660-0EE-N	2400	66	60	2
One 8" & One 16" clear acrylic segment on top				
L-PPFCA-6624-0ES-N	1688	66	24	2
L-PPFCA-6630-0ES-N	1910	66	30	2
L-PPFCA-6636-0ES-N	2003	66	36	2
L-PPFCA-6642-0ES-N	2103	66	42	2
L-PPFCA-6648-0ES-N	2204	66	48	2
L-PPFCA-6654-0ES-N	2311	66	54	2
L-PPFCA-6660-0ES-N	2361	66	60	2
Two 16" clear acrylic segments on top				
L-PPFCA-8224-0SS-N	1797	82	24	2
L-PPFCA-8230-0SS-N	2092	82	30	2
L-PPFCA-8236-0SS-N	2242	82	36	2
L-PPFCA-8242-0SS-N	2308	82	42	2
L-PPFCA-8248-0SS-N	2399	82	48	2
One 24" & One 16" clear acrylic segment on top				
L-PPFCA-8224-0TS-N	1790	82	24	2
L-PPFCA-8230-0TS-N	2051	82	30	2
L-PPFCA-8236-0TS-N	2137	82	36	2
L-PPFCA-8242-0TS-N	2201	82	42	2
L-PPFCA-8248-0TS-N	2425	82	48	2
Two 24" clear acrylic segments on top				
L-PPFCA-8224-0TT-N	1785	82	24	2
L-PPFCA-8230-0TT-N	2024	82	30	2
L-PPFCA-8236-0TT-N	2130	82	36	2
L-PPFCA-8242-0TT-N	2269	82	42	2
L-PPFCA-8248-0TT-N	2360	82	48	2
One 8" & Two 16" clear acrylic segments on top				
L-PPFCA-8224-ESS-N	1862	82	24	2
L-PPFCA-8230-ESS-N	2212	82	30	2
L-PPFCA-8236-ESS-N	2308	82	36	2
L-PPFCA-8242-ESS-N	2310	82	42	2
L-PPFCA-8248-ESS-N	2530	82	48	2
Three 16" clear acrylic segments on top				
L-PPFCA-8224-SSS-N	1893	82	24	2
L-PPFCA-8230-SSS-N	2144	82	30	2
L-PPFCA-8236-SSS-N	2340	82	36	2
L-PPFCA-8242-SSS-N	2419	82	42	2
L-PPFCA-8248-SSS-N	2521	82	48	2

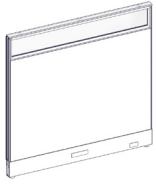

OOE-N
One 8" frosted acrylic segment on top



OOS-N
One 16" frosted acrylic segment on top



OOT-N
One 24" frosted acrylic segment on top



OEE-N
Two 8" frosted acrylic segments on top



OES-N
One 8" & One 16" frosted acrylic segment on top



OSS-N
Two 16" frosted acrylic segments on top



OTS-N
One 24" & One 16" frosted acrylic segment on top



OTT-N
Two 24" frosted acrylic segments on top



ESS-N
One 8" & Two 16" frosted acrylic segments on top



SSS-N
Three 16" frosted acrylic segments on top

How to order and read your code

L - P P F F A - 42 24 - 0 0 E - N

product line	standard	P= glazed E = Elevated	F=Fabric L=Laminate	C= Clear F=Frosted	A=Acrylic G=Glass	height	width	0 = No segment E = 8 inch segment S = 16 inch segment T = 24 inch segment	N=Non powered E=Powered
--------------	----------	---------------------------	------------------------	-----------------------	----------------------	--------	-------	--	----------------------------

What's Included:

One (1) 2" thick fabric panel with 1" incremented slotted channels, Two (2) raceway covers, One (1) top trim

How to Specify:

Refer to panel fabric cards for fabric selections
Choose White, Black, Silver, Charcoal for Panel Frame colour

Notes:

Power capable panel with bracket for power module.

Power module must be specified separately.

Panels are non tackable. For tackable option see Panel Add-On section.

Fabric Upcharge
Grade 2 - \$216 per panel,
Grade 3 - \$266 per panel

Options:

Height*: 34", 42", 50", 66", 82"

Width: 24", 30", 36", 42", 48", 54", 60", 66", 72"

Fabric

Metal Powder Coat Paint: White, Black, Silver, Charcoal

*34" high - 50" high available up to 72" wide, 66" high available up to 60" wide, 82" high available up to 48" wide

Code	Price	H	W	D
One 8" frosted acrylic segment on top				
L-PPFFA-4224-00E-N	1359	42	24	2
L-PPFFA-4230-00E-N	1444	42	30	2
L-PPFFA-4236-00E-N	1498	42	36	2
L-PPFFA-4242-00E-N	1551	42	42	2
L-PPFFA-4248-00E-N	1609	42	48	2
L-PPFFA-4254-00E-N	1699	42	54	2
L-PPFFA-4260-00E-N	1733	42	60	2
L-PPFFA-5024-00E-N	1359	50	24	2
L-PPFFA-5030-00E-N	1444	50	30	2
L-PPFFA-5036-00E-N	1498	50	36	2
L-PPFFA-5042-00E-N	1551	50	42	2
L-PPFFA-5048-00E-N	1609	50	48	2
L-PPFFA-5054-00E-N	1699	50	54	2
L-PPFFA-5060-00E-N	1733	50	60	2
One 16" frosted acrylic segment on top				
L-PPFFA-5024-00S-N	1359	50	24	2
L-PPFFA-5030-00S-N	1444	50	30	2
L-PPFFA-5036-00S-N	1498	50	36	2
L-PPFFA-5042-00S-N	1551	50	42	2
L-PPFFA-5048-00S-N	1609	50	48	2
L-PPFFA-5054-00S-N	1699	50	54	2
L-PPFFA-5060-00S-N	1733	50	60	2
L-PPFFA-6624-00S-N	1488	50	24	2
L-PPFFA-6630-00S-N	1589	50	30	2
L-PPFFA-6636-00S-N	1679	50	36	2
L-PPFFA-6642-00S-N	1769	50	42	2
L-PPFFA-6648-00S-N	1845	50	48	2
L-PPFFA-6654-00S-N	1993	50	54	2
L-PPFFA-6660-00S-N	2028	50	60	2
L-PPFFA-8224-00S-N	1792	82	24	2
L-PPFFA-8230-00S-N	2084	82	30	2
L-PPFFA-8236-00S-N	2204	82	36	2
L-PPFFA-8242-00S-N	2269	82	42	2
L-PPFFA-8248-00S-N	2367	82	48	2
One 24" frosted acrylic segment on top				
L-PPFFA-6624-00T-N	1488	66	24	2
L-PPFFA-6630-00T-N	1589	66	30	2
L-PPFFA-6636-00T-N	1679	66	36	2
L-PPFFA-6642-00T-N	1755	66	42	2
L-PPFFA-6648-00T-N	1830	66	48	2
L-PPFFA-6654-00T-N	1993	66	54	2
L-PPFFA-6660-00T-N	2028	66	60	2

Code	Price	H	W	D
Two 8" frosted acrylic segments on top				
L-PPFFA-6624-0EE-N	1802	66	24	2
L-PPFFA-6630-0EE-N	2055	66	30	2
L-PPFFA-6636-0EE-N	2168	66	36	2
L-PPFFA-6642-0EE-N	2232	66	42	2
L-PPFFA-6648-0EE-N	2345	66	48	2
L-PPFFA-6654-0EE-N	2439	66	54	2
L-PPFFA-6660-0EE-N	2503	66	60	2
One 8" & One 16" frosted acrylic segment on top				
L-PPFFA-6624-0ES-N	1749	66	24	2
L-PPFFA-6630-0ES-N	1991	66	30	2
L-PPFFA-6636-0ES-N	2104	66	36	2
L-PPFFA-6642-0ES-N	2225	66	42	2
L-PPFFA-6648-0ES-N	2328	66	48	2
L-PPFFA-6654-0ES-N	2448	66	54	2
L-PPFFA-6660-0ES-N	2520	66	60	2
Two 16" frosted acrylic segments on top				
L-PPFFA-8224-0SS-N	1685	82	24	2
L-PPFFA-8230-0SS-N	1926	82	30	2
L-PPFFA-8236-0SS-N	2022	82	36	2
L-PPFFA-8242-0SS-N	2095	82	42	2
L-PPFFA-8248-0SS-N	2173	82	48	2
One 24" & One 16" frosted acrylic segment on top				
L-PPFFA-8224-0TS-N	1912	82	24	2
L-PPFFA-8230-0TS-N	2217	82	30	2
L-PPFFA-8236-0TS-N	2298	82	36	2
L-PPFFA-8242-0TS-N	2402	82	42	2
L-PPFFA-8248-0TS-N	2668	82	48	2
Two 24" frosted acrylic segments on top				
L-PPFFA-8224-0TT-N	1906	82	24	2
L-PPFFA-8230-0TT-N	2188	82	30	2
L-PPFFA-8236-0TT-N	2328	82	36	2
L-PPFFA-8242-0TT-N	2512	82	42	2
L-PPFFA-8248-0TT-N	2606	82	48	2
One 8" & Two 16" frosted acrylic segments on top				
L-PPFFA-8224-ESS-N	1985	82	24	2
L-PPFFA-8230-ESS-N	2375	82	30	2
L-PPFFA-8236-ESS-N	2469	82	36	2
L-PPFFA-8242-ESS-N	2550	82	42	2
L-PPFFA-8248-ESS-N	2692	82	48	2
Three 16" frosted acrylic segments on top				
L-PPFFA-8224-SSS-N	2018	82	24	2
L-PPFFA-8230-SSS-N	2309	82	30	2
L-PPFFA-8236-SSS-N	2588	82	36	2
L-PPFFA-8242-SSS-N	2665	82	42	2
L-PPFFA-8248-SSS-N	2769	82	48	2

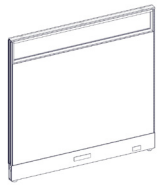

OOE-N
One 8" clear glass segment on top

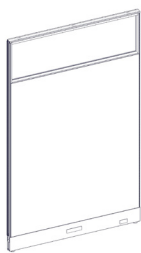

OOS-N
One 16" clear glass segment on top



OOT-N
One 24" clear glass segment on top



OEE-N
Two 8" clear glass segments on top

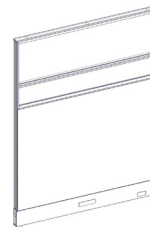

OES-N
One 8" & One 16" clear glass segment on top



OSS-N
Two 16" clear glass segments on top



OTS-N
One 24 & One 16" clear glass segment on top



OTT-N
Two 24" clear glass segments on top



ESS-N
One 8" & Two 16" clear glass segments on top



SSS-N
Three 16" clear glass segments on top

How to order and read your code

L - P P F C G - 42 24 - 0 0 E - N

product standard P= glazed F=Fabric C=Clear A=Acrylic height width 0 = No segment N=Non powered
line E = Elevated L=Laminate F=Frosted G=Glass E = 8 inch segment E=Powered
S = 16 inch segment
T = 24 inch segment

What's Included:

One (1) 2" thick fabric panel with 1" incremented slotted channels, Two (2) raceway covers, One (1) top trim

How to Specify:

Refer to panel fabric cards for fabric selections
Choose White, Black, Silver, Charcoal for Panel Frame colour

Notes:

Power capable panel with bracket for power module.
Power module must be specified separately.
Panels are non tackable. For tackable option see Panel Add-On section.
Fabric Upcharge
Grade 2 - \$216 per panel,
Grade 3 - \$266 per panel

Options:

Height*: 34", 42", 50", 66", 82"

Width: 24", 30", 36", 42", 48", 54", 60", 66", 72"

Fabric

Metal Powder Coat Paint: White, Black, Silver, Charcoal

*34" high - 50" high available up to 72" wide, 66" high available up to 60" wide, 82" high available up to 48" wide

Code	Price	H	W	D
One 8" clear glass segment on top				
L-PPFCG-4224-00E-N	1434	42	24	2
L-PPFCG-4230-00E-N	1523	42	30	2
L-PPFCG-4236-00E-N	1614	42	36	2
L-PPFCG-4242-00E-N	1703	42	42	2
L-PPFCG-4248-00E-N	1793	42	48	2
L-PPFCG-4254-00E-N	1882	42	54	2
L-PPFCG-4260-00E-N	1972	42	60	2
L-PPFCG-5024-00E-N	1434	50	24	2
L-PPFCG-5030-00E-N	1523	50	30	2
L-PPFCG-5036-00E-N	1614	50	36	2
L-PPFCG-5042-00E-N	1703	50	42	2
L-PPFCG-5048-00E-N	1793	50	48	2
L-PPFCG-5054-00E-N	1882	50	54	2
L-PPFCG-5060-00E-N	1972	50	60	2
One 16" clear glass segment on top				
L-PPFCG-5024-00S-N	1434	50	24	2
L-PPFCG-5030-00S-N	1523	50	30	2
L-PPFCG-5036-00S-N	1614	50	36	2
L-PPFCG-5042-00S-N	1703	50	42	2
L-PPFCG-5048-00S-N	1793	50	48	2
L-PPFCG-5054-00S-N	1882	50	54	2
L-PPFCG-5060-00S-N	1972	50	60	2
L-PPFCG-6624-00S-N	1493	66	24	2
L-PPFCG-6630-00S-N	1603	66	30	2
L-PPFCG-6636-00S-N	1719	66	36	2
L-PPFCG-6642-00S-N	1829	66	42	2
L-PPFCG-6648-00S-N	1945	66	48	2
L-PPFCG-6654-00S-N	2055	66	54	2
L-PPFCG-6660-00S-N	2167	66	60	2
L-PPFCG-8224-00S-N	1703	82	24	2
L-PPFCG-8230-00S-N	2011	82	30	2
L-PPFCG-8236-00S-N	2143	82	36	2
L-PPFCG-8242-00S-N	2214	82	42	2
L-PPFCG-8248-00S-N	2337	82	48	2
One 24" clear glass segment on top				
L-PPFCG-6624-00T-N	1493	66	24	2
L-PPFCG-6630-00T-N	1603	66	30	2
L-PPFCG-6636-00T-N	1719	66	36	2
L-PPFCG-6642-00T-N	1829	66	42	2
L-PPFCG-6648-00T-N	1945	66	48	2
L-PPFCG-6654-00T-N	2055	66	54	2
L-PPFCG-6660-00T-N	2167	66	60	2

Code	Price	H	W	D
Two 8" clear glass segments on top				
L-PPFCG-6624-0EE-N	1842	66	24	2
L-PPFCG-6630-0EE-N	2111	66	30	2
L-PPFCG-6636-0EE-N	2224	66	36	2
L-PPFCG-6642-0EE-N	2305	66	42	2
L-PPFCG-6648-0EE-N	2412	66	48	2
L-PPFCG-6654-0EE-N	2555	66	54	2
L-PPFCG-6660-0EE-N	2628	66	60	2
One 8" & One 16" clear glass segment on top				
L-PPFCG-6624-0ES-N	1794	66	24	2
L-PPFCG-6630-0ES-N	2031	66	30	2
L-PPFCG-6636-0ES-N	2147	66	36	2
L-PPFCG-6642-0ES-N	2255	66	42	2
L-PPFCG-6648-0ES-N	2388	66	48	2
L-PPFCG-6654-0ES-N	2541	66	54	2
L-PPFCG-6660-0ES-N	2623	66	60	2
Two 16" clear glass segments on top				
L-PPFCG-8224-0SS-N	1906	82	24	2
L-PPFCG-8230-0SS-N	2194	82	30	2
L-PPFCG-8236-0SS-N	2340	82	36	2
L-PPFCG-8242-0SS-N	2459	82	42	2
L-PPFCG-8248-0SS-N	2606	82	48	2
One 24" & One 16" clear glass segment on top				
L-PPFCG-8224-0TS-N	1892	82	24	2
L-PPFCG-8230-0TS-N	2156	82	30	2
L-PPFCG-8236-0TS-N	2302	82	36	2
L-PPFCG-8242-0TS-N	2433	82	42	2
L-PPFCG-8248-0TS-N	2596	82	48	2
Two 24" clear glass segments on top				
L-PPFCG-8224-0TT-N	1926	82	24	2
L-PPFCG-8230-0TT-N	2184	82	30	2
L-PPFCG-8236-0TT-N	2317	82	36	2
L-PPFCG-8242-0TT-N	2455	82	42	2
L-PPFCG-8248-0TT-N	2616	82	48	2
One 8" & Two 16" clear glass segments on top				
L-PPFCG-8224-ESS-N	2070	82	24	2
L-PPFCG-8230-ESS-N	2409	82	30	2
L-PPFCG-8236-ESS-N	2565	82	36	2
L-PPFCG-8242-ESS-N	2591	82	42	2
L-PPFCG-8248-ESS-N	2794	82	48	2
Three 16" clear glass segments on top				
L-PPFCG-8224-SSS-N	2112	82	24	2
L-PPFCG-8230-SSS-N	2360	82	30	2
L-PPFCG-8236-SSS-N	2521	82	36	2
L-PPFCG-8242-SSS-N	2678	82	42	2
L-PPFCG-8248-SSS-N	2859	82	48	2



OOE-N
One 8" frosted glass segment on top



OOS-N
One 16" frosted glass segment on top



OOT-N
One 24" frosted glass segment on top



OEE-N
Two 8" frosted glass segments on top



OES-N
One 8" & One 16" frosted glass segment on top



OSS-N
Two 16" frosted glass segments on top



OTS-N
One 24" & One 16" frosted glass segment on top



OTT-N
Two 24" frosted glass segments on top



ESS-N
One 8" & Two 16" frosted glass segments on top



SSS-N
Three 16" frosted glass segments on top

How to order and read your code

L - P P F F G - 42 24 - 00E - N

product line	standard	P= glazed E = Elevated	F=Fabric L=Laminate	C= Clear F=Frosted	A=Acrylic G=Glass	height	width	0 = No segment E = 8 inch segment S = 16 inch segment T = 24 inch segment	N=Non powered E=Powered
--------------	----------	---------------------------	------------------------	-----------------------	----------------------	--------	-------	--	----------------------------

What's Included:

One (1) 2" thick fabric panel with 1" incremented slotted channels, Two (2) raceway covers, One (1) top trim

How to Specify:

Refer to panel fabric cards for fabric selections
Choose White, Black, Silver, Charcoal for Panel Frame colour

Notes:

Power capable panel with bracket for power module.
Power module must be specified separately.
Panels are non tackable. For tackable option see Panel Add-On section.
Fabric Upcharge
Grade 2 - \$216 per panel,
Grade 3 - \$266 per panel

Options:

Height*: 34", 42", 50", 66", 82"

Width: 24", 30", 36", 42", 48", 54", 60", 66", 72"

Fabric

Metal Powder Coat Paint: White, Black, Silver, Charcoal

*34" high - 50" high available up to 72" wide, 66" high available up to 60" wide, 82" high available up to 48" wide

Code	Price	H	W	D
One 8" frosted glass segment on top				
L-PPFFG-4224-00E-N	1534	42	24	2
L-PPFFG-4230-00E-N	1640	42	30	2
L-PPFFG-4236-00E-N	1730	42	36	2
L-PPFFG-4242-00E-N	1819	42	42	2
L-PPFFG-4248-00E-N	1910	42	48	2
L-PPFFG-4254-00E-N	1999	42	54	2
L-PPFFG-4260-00E-N	2087	42	60	2
L-PPFFG-5024-00E-N	1550	50	24	2
L-PPFFG-5030-00E-N	1640	50	30	2
L-PPFFG-5036-00E-N	1730	50	36	2
L-PPFFG-5042-00E-N	1819	50	42	2
L-PPFFG-5048-00E-N	1910	50	48	2
L-PPFFG-5054-00E-N	1999	50	54	2
L-PPFFG-5060-00E-N	2087	50	60	2
One 16" frosted glass segment on top				
L-PPFFG-5024-00S-N	1550	50	24	2
L-PPFFG-5030-00S-N	1640	50	30	2
L-PPFFG-5036-00S-N	1730	50	36	2
L-PPFFG-5042-00S-N	1819	50	42	2
L-PPFFG-5048-00S-N	1910	50	48	2
L-PPFFG-5054-00S-N	1999	50	54	2
L-PPFFG-5060-00S-N	2087	50	60	2
L-PPFFG-6624-00S-N	1609	66	24	2
L-PPFFG-6630-00S-N	1720	66	30	2
L-PPFFG-6636-00S-N	1834	66	36	2
L-PPFFG-6642-00S-N	1946	66	42	2
L-PPFFG-6648-00S-N	2059	66	48	2
L-PPFFG-6654-00S-N	2171	66	54	2
L-PPFFG-6660-00S-N	2282	66	60	2
L-PPFFG-8224-00S-N	1803	82	24	2
L-PPFFG-8230-00S-N	2120	82	30	2
L-PPFFG-8236-00S-N	2273	82	36	2
L-PPFFG-8242-00S-N	2367	82	42	2
L-PPFFG-8248-00S-N	2512	82	48	2
One 24" frosted glass segment on top				
L-PPFFG-6624-00T-N	1609	66	24	2
L-PPFFG-6630-00T-N	1720	66	30	2
L-PPFFG-6636-00T-N	1834	66	36	2
L-PPFFG-6642-00T-N	1946	66	42	2
L-PPFFG-6648-00T-N	2059	66	48	2
L-PPFFG-6654-00T-N	2171	66	54	2
L-PPFFG-6660-00T-N	2282	66	60	2

Code	Price	H	W	D
Two 8" clear glass segments on top				
L-PPFFG-6624-0EE-N	2040	66	24	2
L-PPFFG-6630-0EE-N	2310	66	30	2
L-PPFFG-6636-0EE-N	2424	66	36	2
L-PPFFG-6642-0EE-N	2503	66	42	2
L-PPFFG-6648-0EE-N	2614	66	48	2
L-PPFFG-6654-0EE-N	2753	66	54	2
L-PPFFG-6660-0EE-N	2849	66	60	2
One 8" & One 16" frosted glass segment on top				
L-PPFFG-6624-0ES-N	1993	66	24	2
L-PPFFG-6630-0ES-N	2242	66	30	2
L-PPFFG-6636-0ES-N	2382	66	36	2
L-PPFFG-6642-0ES-N	2507	66	42	2
L-PPFFG-6648-0ES-N	2665	66	48	2
L-PPFFG-6654-0ES-N	2838	66	54	2
L-PPFFG-6660-0ES-N	2954	66	60	2
Two 16" frosted glass segments on top				
L-PPFFG-8224-0SS-N	2104	82	24	2
L-PPFFG-8230-0SS-N	2412	82	30	2
L-PPFFG-8236-0SS-N	2607	82	36	2
L-PPFFG-8242-0SS-N	2769	82	42	2
L-PPFFG-8248-0SS-N	2957	82	48	2
One 24" & One 16" frosted glass segment on top				
L-PPFFG-8224-0TS-N	2123	82	24	2
L-PPFFG-8230-0TS-N	2433	82	30	2
L-PPFFG-8236-0TS-N	2630	82	36	2
L-PPFFG-8242-0TS-N	2818	82	42	2
L-PPFFG-8248-0TS-N	3037	82	48	2
Two 24" frosted glass segments on top				
L-PPFFG-8224-0TT-N	2192	82	24	2
L-PPFFG-8230-0TT-N	2512	82	30	2
L-PPFFG-8236-0TT-N	2713	82	36	2
L-PPFFG-8242-0TT-N	2916	82	42	2
L-PPFFG-8248-0TT-N	3145	82	48	2
One 8" & Two 16" frosted glass segments on top				
L-PPFFG-8224-ESS-N	2367	82	24	2
L-PPFFG-8230-ESS-N	2727	82	30	2
L-PPFFG-8236-ESS-N	2928	82	36	2
L-PPFFG-8242-ESS-N	2998	82	42	2
L-PPFFG-8248-ESS-N	3246	82	48	2
Three 16" frosted glass segments on top				
L-PPFFG-8224-SSS-N	2410	82	24	2
L-PPFFG-8230-SSS-N	2691	82	30	2
L-PPFFG-8236-SSS-N	2918	82	36	2
L-PPFFG-8242-SSS-N	3140	82	42	2
L-PPFFG-8248-SSS-N	3389	82	48	2



OOE-N
One 8" clear acrylic segment on top



OOS-N
One 16" clear acrylic segment on top



OOT-N
One 24" clear acrylic segment on top

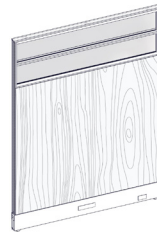

OEE-N
Two 8" clear acrylic segments on top

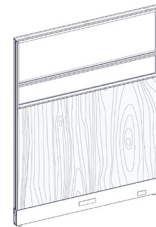

OES-N
One 8" & One 16" clear acrylic segment on top



OSS-N
Two 16" clear acrylic segments on top



OTS-N
One 24" & One 16" clear acrylic segment on top



OTT-N
Two 24" clear acrylic segments on top



ESS-N
One 8" & Two 16" clear acrylic segments on top



SSS-N
Three 16" clear acrylic segments on top

How to order and read your code

L - P P L C A - 42 24 - 0 0 E - N

product line	standard	P= glazed E = Elevated	F=Fabric L=Laminate	C= Clear F=Frosted	A=Acrylic G=Glass	height	width	0 = No segment E = 8 inch segment S = 16 inch segment T = 24 inch segment	N=Non powered E=Powered
--------------	----------	---------------------------	------------------------	-----------------------	----------------------	--------	-------	--	----------------------------

What's Included:

One (1) 2" thick laminate panel with 1" incremented slotted channels,
Two (2) raceway covers,
One (1) top trim

How to Specify:

Refer to laminate cards for laminate selections
Choose White, Black, Silver, Charcoal for Panel Frame colour

Notes:

Power capable panel with bracket for power module.
Power module must be specified separately.
Panels are non tackable. For tackable option see Panel Add-On section.

Options:

Height*: 34", 42", 50", 66", 82"

Width: 24", 30", 36", 42", 48",

Laminate

Metal Powder Coat Paint: White, Black, Silver, Charcoal

*82"H available up to 36"W

Code	Price	H	W	D
One 8" clear acrylic segment on top				
L-PPLCA-4224-00E-N	1311	42	24	2
L-PPLCA-4230-00E-N	1370	42	30	2
L-PPLCA-4236-00E-N	1433	42	36	2
L-PPLCA-4242-00E-N	1558	42	42	2
L-PPLCA-4248-00E-N	1590	42	48	2
L-PPLCA-5024-00E-N	1352	50	24	2
L-PPLCA-5030-00E-N	1414	50	30	2
L-PPLCA-5036-00E-N	1474	50	36	2
L-PPLCA-5042-00E-N	1628	50	42	2
L-PPLCA-5048-00E-N	1663	50	48	2
One 16" clear acrylic segment on top				
L-PPLCA-5024-00S-N	1364	50	24	2
L-PPLCA-5030-00S-N	1428	50	30	2
L-PPLCA-5036-00S-N	1493	50	36	2
L-PPLCA-5042-00S-N	1654	50	42	2
L-PPLCA-5048-00S-N	1692	50	48	2
L-PPLCA-6624-00S-N	1479	66	24	2
L-PPLCA-6630-00S-N	1566	66	30	2
L-PPLCA-6636-00S-N	1654	66	36	2
L-PPLCA-6642-00S-N	1876	66	42	2
L-PPLCA-6648-00S-N	1922	66	48	2
L-PPLCA-8224-00S-N	1829	82	24	2
L-PPLCA-8230-00S-N	1849	82	30	2
L-PPLCA-8236-00S-N	2463	82	36	2
One 24" clear acrylic segment on top				
L-PPLCA-6624-00T-N	1479	66	24	2
L-PPLCA-6630-00T-N	1586	66	30	2
L-PPLCA-6636-00T-N	1691	66	36	2
L-PPLCA-6642-00T-N	1876	66	42	2
L-PPLCA-6648-00T-N	1937	66	48	2

Code	Price	H	W	D
Two 8" clear acrylic segments on top				
L-PPLCA-6624-0EE-N	1596	66	24	2
L-PPLCA-6630-0EE-N	1616	66	30	2
L-PPLCA-6636-0EE-N	1950	66	36	2
L-PPLCA-6642-0EE-N	1996	66	42	2
L-PPLCA-6648-0EE-N	2060	66	48	2
One 8" & One 16" clear acrylic segment on top				
L-PPLCA-6624-0ES-N	1603	66	24	2
L-PPLCA-6630-0ES-N	1672	66	30	2
L-PPLCA-6636-0ES-N	2031	66	36	2
L-PPLCA-6642-0ES-N	2100	66	42	2
L-PPLCA-6648-0ES-N	2168	66	48	2
Two 16" clear acrylic segments on top				
L-PPLCA-8224-0SS-N	1667	82	24	2
L-PPLCA-8230-0SS-N	1751	82	30	2
L-PPLCA-8236-0SS-N	2152	82	36	2
One 24" & One 16" clear acrylic segment on top				
L-PPLCA-8224-0TS-N	1703	82	24	2
L-PPLCA-8230-0TS-N	1814	82	30	2
L-PPLCA-8236-0TS-N	2161	82	36	2
Two 24" clear acrylic segments on top				
L-PPLCA-8224-0TT-N	1630	82	24	2
L-PPLCA-8230-0TT-N	1727	82	30	2
L-PPLCA-8236-0TT-N	2026	82	36	2
One 8" & Two 16" clear acrylic segments on top				
L-PPLCA-8224-ESS-N	1778	82	24	2
L-PPLCA-8230-ESS-N	1972	82	30	2
L-PPLCA-8236-ESS-N	2333	82	36	2
Three 16" clear acrylic segments on top				
L-PPLCA-8224-SSS-N	1742	82	24	2
L-PPLCA-8230-SSS-N	1846	82	30	2
L-PPLCA-8236-SSS-N	2236	82	36	2



OOE-N
One 8" frosted acrylic segment on top



OOS-N
One 16" frosted acrylic segment on top



OOT-N
One 24" frosted acrylic segment on top



OEE-N
Two 8" frosted acrylic segments on top



OES-N
One 8" & One 16" frosted acrylic segment on top



OSS-N
Two 16" frosted acrylic segments on top



OTS-N
One 24" & One 16" frosted acrylic segment on top



OTT-N
Two 24" frosted acrylic segments on top



ESS-N
One 8" & Two 16" frosted acrylic segments on top



SSS-N
Three 16" frosted acrylic segments on top

How to order and read your code

L - P P L F A - 42 24 - 0 0 E - N

product line	standard	P= glazed E = Elevated	F=Fabric L=Laminate	C= Clear F=Frosted	A=Acrylic G=Glass	height	width	0 = No segment E = 8 inch segment S = 16 inch segment T = 24 inch segment	N=Non powered E=Powered
--------------	----------	---------------------------	------------------------	-----------------------	----------------------	--------	-------	--	----------------------------

What's Included:

One (1) 2" thick laminate panel with 1" incremented slotted channels,
Two (2) raceway covers,
One (1) top trim

How to Specify:

Refer to laminate cards for laminate selections
Choose White, Black, Silver, Charcoal for Panel Frame colour

Notes:

Power capable panel with bracket for power module.
Power module must be specified separately.
Panels are non tackable. For tackable option see Panel Add-On section.

Options:

Height*: 34", 42", 50", 66", 82"

Width: 24", 30", 36", 42", 48",

Laminate

Metal Powder Coat Paint: White, Black, Silver, Charcoal

*82"H available up to 36"W

Code	Price	H	W	D
One 8" frosted acrylic segment on top				
L-PPLFA-4224-00E-N	1428	42	24	2
L-PPLFA-4230-00E-N	1487	42	30	2
L-PPLFA-4236-00E-N	1549	42	36	2
L-PPLFA-4242-00E-N	1673	42	42	2
L-PPLFA-4248-00E-N	1706	42	48	2
L-PPLFA-5024-00E-N	1468	50	24	2
L-PPLFA-5030-00E-N	1529	50	30	2
L-PPLFA-5036-00E-N	1590	50	36	2
L-PPLFA-5042-00E-N	1745	50	42	2
L-PPLFA-5048-00E-N	1778	50	48	2
One 16" frosted acrylic segment on top				
L-PPLFA-5024-00S-N	1479	50	24	2
L-PPLFA-5030-00S-N	1543	50	30	2
L-PPLFA-5036-00S-N	1609	50	36	2
L-PPLFA-5042-00S-N	1770	50	42	2
L-PPLFA-5048-00S-N	1807	50	48	2
L-PPLFA-6624-00S-N	1596	66	24	2
L-PPLFA-6630-00S-N	1685	66	30	2
L-PPLFA-6636-00S-N	1770	66	36	2
L-PPLFA-6642-00S-N	1993	66	42	2
L-PPLFA-6648-00S-N	2038	66	48	2
L-PPLFA-8224-00S-N	1870	82	24	2
L-PPLFA-8230-00S-N	1905	82	30	2
L-PPLFA-8236-00S-N	2534	82	36	2
One 24" frosted acrylic segment on top				
L-PPLFA-6624-00T-N	1596	66	24	2
L-PPLFA-6630-00T-N	1701	66	30	2
L-PPLFA-6636-00T-N	1756	66	36	2
L-PPLFA-6642-00T-N	1993	66	42	2
L-PPLFA-6648-00T-N	2054	66	48	2

Code	Price	H	W	D
Two 8" frosted acrylic segments on top				
L-PPLFA-6624-0EE-N	1670	66	24	2
L-PPLFA-6630-0EE-N	1715	66	30	2
L-PPLFA-6636-0EE-N	2078	66	36	2
L-PPLFA-6642-0EE-N	2119	66	42	2
L-PPLFA-6648-0EE-N	2207	66	48	2
One 8" & One 16" frosted acrylic segment on top				
L-PPLFA-6624-0ES-N	1666	66	24	2
L-PPLFA-6630-0ES-N	1751	66	30	2
L-PPLFA-6636-0ES-N	2130	66	36	2
L-PPLFA-6642-0ES-N	2223	66	42	2
L-PPLFA-6648-0ES-N	2292	66	48	2
Two 16" frosted acrylic segments on top				
L-PPLFA-8224-0SS-N	1551	82	24	2
L-PPLFA-8230-0SS-N	1586	82	30	2
L-PPLFA-8236-0SS-N	1930	82	36	2
One 24" & One 16" frosted acrylic segment on top				
L-PPLFA-8224-0TS-N	1828	82	24	2
L-PPLFA-8230-0TS-N	1977	82	30	2
L-PPLFA-8236-0TS-N	2325	82	36	2
Two 24" frosted acrylic segments on top				
L-PPLFA-8224-0TT-N	1754	82	24	2
L-PPLFA-8230-0TT-N	1889	82	30	2
L-PPLFA-8236-0TT-N	2223	82	36	2
One 8" & Two 16" frosted acrylic segments on top				
L-PPLFA-8224-ESS-N	1901	82	24	2
L-PPLFA-8230-ESS-N	2137	82	30	2
L-PPLFA-8236-ESS-N	2496	82	36	2
Three 16" frosted acrylic segments on top				
L-PPLFA-8224-SSS-N	1863	82	24	2
L-PPLFA-8230-SSS-N	2011	82	30	2
L-PPLFA-8236-SSS-N	2481	82	36	2



OOE-N
One 8" clear glass segment on top



OOS-N
One 16" clear glass segment on top



OOT-N
One 24" clear glass segment on top



OEE-N
Two 8" clear glass segments on top



OES-N
One 8" & One 16" clear glass segment on top



OSS-N
Two 16" clear glass segments on top



OTS-N
One 24" & One 16" clear glass segment on top



OTT-N
Two 24" clear glass segments on top



ESS-N
One 8" & Two 16" clear glass segments on top



SSS-N
Three 16" clear glass segments on top

How to order and read your code

L - P P L C G - 42 24 - 0 0 E - N

product line	standard	P=glazed E=Elevated	F=Fabric L=Laminate	C=Clear F=Frosted	A=Acrylic G=Glass	height	width	0 = No segment E = 8 inch segment S = 16 inch segment T = 24 inch segment	N=Non powered E=Powered
--------------	----------	------------------------	------------------------	----------------------	----------------------	--------	-------	--	----------------------------

What's Included:

One (1) 2" thick laminate panel with 1" incremented slotted channels,
Two (2) raceway covers,
One (1) top trim

How to Specify:

Refer to laminate cards for laminate selections
Choose White, Black, Silver, Charcoal for Panel Frame colour

Notes:

Power capable panel with bracket for power module.
Power module must be specified separately.
Panels are non tackable. For tackable option see Panel Add-On section.

Options:

Height*: 34", 42", 50", 66", 82"

Width: 24", 30", 36", 42", 48",

Laminate

Metal Powder Coat Paint: White, Black, Silver, Charcoal

*82"H available up to 36"W

Code	Price	H	W	D
One 8" clear glass segment on top				
L-PPLCG-4224-00E-N	1422	42	24	2
L-PPLCG-4230-00E-N	1494	42	30	2
L-PPLCG-4236-00E-N	1564	42	36	2
L-PPLCG-4242-00E-N	1644	42	42	2
L-PPLCG-4248-00E-N	1723	42	48	2
L-PPLCG-5024-00E-N	1465	50	24	2
L-PPLCG-5030-00E-N	1534	50	30	2
L-PPLCG-5036-00E-N	1604	50	36	2
L-PPLCG-5042-00E-N	1686	50	42	2
L-PPLCG-5048-00E-N	1764	50	48	2
One 16" clear glass segment on top				
L-PPLCG-5024-00S-N	1555	50	24	2
L-PPLCG-5030-00S-N	1624	50	30	2
L-PPLCG-5036-00S-N	1693	50	36	2
L-PPLCG-5042-00S-N	1770	50	42	2
L-PPLCG-5048-00S-N	1853	50	48	2
L-PPLCG-6624-00S-N	1688	66	24	2
L-PPLCG-6630-00S-N	1776	66	30	2
L-PPLCG-6636-00S-N	1864	66	36	2
L-PPLCG-6642-00S-N	1972	66	42	2
L-PPLCG-6648-00S-N	2056	66	48	2
L-PPLCG-8224-00S-N	1782	82	24	2
L-PPLCG-8230-00S-N	1831	82	30	2
L-PPLCG-8236-00S-N	2470	82	36	2
One 24" clear glass segment on top				
L-PPLCG-6624-00T-N	1736	66	24	2
L-PPLCG-6630-00T-N	1825	66	30	2
L-PPLCG-6636-00T-N	1913	66	36	2
L-PPLCG-6642-00T-N	2030	66	42	2
L-PPLCG-6648-00T-N	2134	66	48	2

Code	Price	H	W	D
Two 8" clear glass segments on top				
L-PPLCG-6624-0EE-N	1709	66	24	2
L-PPLCG-6630-0EE-N	1769	66	30	2
L-PPLCG-6636-0EE-N	2134	66	36	2
L-PPLCG-6642-0EE-N	2192	66	42	2
L-PPLCG-6648-0EE-N	2275	66	48	2
One 8" & One 16" clear glass segment on top				
L-PPLCG-6624-0ES-N	1709	66	24	2
L-PPLCG-6630-0ES-N	1793	66	30	2
L-PPLCG-6636-0ES-N	2173	66	36	2
L-PPLCG-6642-0ES-N	2251	66	42	2
L-PPLCG-6648-0ES-N	2352	66	48	2
Two 16" clear glass segments on top				
L-PPLCG-8224-0SS-N	1772	82	24	2
L-PPLCG-8230-0SS-N	1853	82	30	2
L-PPLCG-8236-0SS-N	2255	82	36	2
One 24" & One 16" clear glass segment on top				
L-PPLCG-8224-0TS-N	1807	82	24	2
L-PPLCG-8230-0TS-N	1918	82	30	2
L-PPLCG-8236-0TS-N	2328	82	36	2
Two 24" clear glass segments on top				
L-PPLCG-8224-0TT-N	1771	82	24	2
L-PPLCG-8230-0TT-N	1887	82	30	2
L-PPLCG-8236-0TT-N	2212	82	36	2
One 8" & Two 16" clear glass segments on top				
L-PPLCG-8224-ESS-N	1985	82	24	2
L-PPLCG-8230-ESS-N	2169	82	30	2
L-PPLCG-8236-ESS-N	2591	82	36	2
Three 16" clear glass segments on top				
L-PPLCG-8224-SSS-N	1959	82	24	2
L-PPLCG-8230-SSS-N	2064	82	30	2
L-PPLCG-8236-SSS-N	2415	82	36	2



OOE-N
One 8" frosted glass segment on top



OOS-N
One 16" frosted glass segment on top



OOT-N
One 24" frosted glass segment on top

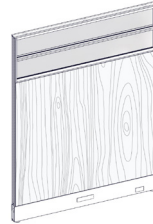

OEE-N
Two 8" frosted glass segments on top

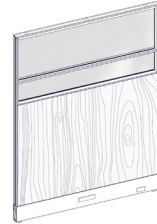

OES-N
One 8" & One 16" frosted glass segment on top



OSS-N
Two 16" frosted glass segments on top



OTS-N
One 24" & One 16" frosted glass segment on top



OTT-N
Two 24" frosted glass segments on top



ESS-N
One 8" & Two 16" frosted glass segments on top



SSS-N
Three 16" frosted glass segments on top

How to order and read your code

L - P P L F G - 42 24 - 0 0 E - N

product line	standard	P=glazed E=Elevated	F=Fabric L=Laminate	C=Clear F=Frosted	A=Acrylic G=Glass	height	width	0 = No segment E = 8 inch segment S = 16 inch segment T = 24 inch segment	N=Non powered E=Powered
--------------	----------	------------------------	------------------------	----------------------	----------------------	--------	-------	--	----------------------------

What's Included:

One (1) 2" thick laminate panel with 1" incremented slotted channels,
Two (2) raceway covers,
One (1) top trim

How to Specify:

Refer to laminate cards for laminate selections
Choose White, Black, Silver, Charcoal for Panel Frame colour

Notes:

Power capable panel with bracket for power module.
Power module must be specified separately.
Panels are non tackable. For tackable option see Panel Add-On section.

Options:

Height*: 34", 42", 50", 66", 82"

Width: 24", 30", 36", 42", 48",

Laminate

Metal Powder Coat Paint: White, Black, Silver, Charcoal

*82"H available up to 36"W

Code	Price	H	W	D
One 8" frosted glass segment on top				
L-PPLFG-4224-00E-N	1540	42	24	2
L-PPLFG-4230-00E-N	1612	42	30	2
L-PPLFG-4236-00E-N	1679	42	36	2
L-PPLFG-4242-00E-N	1760	42	42	2
L-PPLFG-4248-00E-N	1841	42	48	2
L-PPLFG-5024-00E-N	1581	50	24	2
L-PPLFG-5030-00E-N	1649	50	30	2
L-PPLFG-5036-00E-N	1721	50	36	2
L-PPLFG-5042-00E-N	1802	50	42	2
L-PPLFG-5048-00E-N	1879	50	48	2
One 16" frosted glass segment on top				
L-PPLFG-5024-00S-N	1672	50	24	2
L-PPLFG-5030-00S-N	1742	50	30	2
L-PPLFG-5036-00S-N	1810	50	36	2
L-PPLFG-5042-00S-N	1887	50	42	2
L-PPLFG-5048-00S-N	1970	50	48	2
L-PPLFG-6624-00S-N	1804	66	24	2
L-PPLFG-6630-00S-N	1892	66	30	2
L-PPLFG-6636-00S-N	1982	66	36	2
L-PPLFG-6642-00S-N	2087	66	42	2
L-PPLFG-6648-00S-N	2172	66	48	2
L-PPLFG-8224-00S-N	1879	82	24	2
L-PPLFG-8230-00S-N	1941	82	30	2
L-PPLFG-8236-00S-N	2603	82	36	2
One 24" frosted glass segment on top				
L-PPLFG-6624-00T-N	1853	66	24	2
L-PPLFG-6630-00T-N	1940	66	30	2
L-PPLFG-6636-00T-N	2028	66	36	2
L-PPLFG-6642-00T-N	2146	66	42	2
L-PPLFG-6648-00T-N	2251	66	48	2

Code	Price	H	W	D
Two 8" frosted glass segments on top				
L-PPLFG-6624-0EE-N	1908	66	24	2
L-PPLFG-6630-0EE-N	1970	66	30	2
L-PPLFG-6636-0EE-N	2333	66	36	2
L-PPLFG-6642-0EE-N	2388	66	42	2
L-PPLFG-6648-0EE-N	2475	66	48	2
One 8" & One 16" frosted glass segment on top				
L-PPLFG-6624-0ES-N	1908	66	24	2
L-PPLFG-6630-0ES-N	2001	66	30	2
L-PPLFG-6636-0ES-N	2408	66	36	2
L-PPLFG-6642-0ES-N	2504	66	42	2
L-PPLFG-6648-0ES-N	2628	66	48	2
Two 16" frosted glass segments on top				
L-PPLFG-8224-0SS-N	1973	82	24	2
L-PPLFG-8230-0SS-N	2073	82	30	2
L-PPLFG-8236-0SS-N	2516	82	36	2
One 24" & One 16" frosted glass segment on top				
L-PPLFG-8224-0TS-N	2040	82	24	2
L-PPLFG-8230-0TS-N	2194	82	30	2
L-PPLFG-8236-0TS-N	2657	82	36	2
Two 24" frosted glass segments on top				
L-PPLFG-8224-0TT-N	2038	82	24	2
L-PPLFG-8230-0TT-N	2218	82	30	2
L-PPLFG-8236-0TT-N	2608	82	36	2
One 8" & Two 16" frosted glass segments on top				
L-PPLFG-8224-ESS-N	2282	82	24	2
L-PPLFG-8230-ESS-N	2488	82	30	2
L-PPLFG-8236-ESS-N	2955	82	36	2
Three 16" frosted glass segments on top				
L-PPLFG-8224-SSS-N	2257	82	24	2
L-PPLFG-8230-SSS-N	2395	82	30	2
L-PPLFG-8236-SSS-N	2812	82	36	2

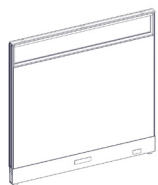

OOE-E
One 8" clear acrylic segment on top

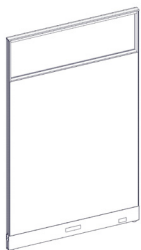

OOS-E
One 16" clear acrylic segment on top

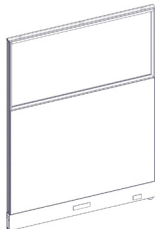

OOT-E
One 24" clear acrylic segment on top

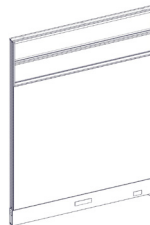

OEE-E
Two 8" clear acrylic segments on top

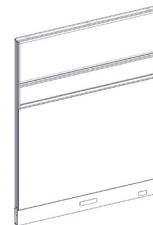

OES-E
One 8" & One 16" clear acrylic segment on top

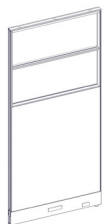

OSS-E
Two 16" clear acrylic segments on top



OTS-E
One 24" & One 16" clear acrylic segment on top



OTT-E
Two 24" clear acrylic segments on top



ESS-E
One 8" & Two 16" clear acrylic segments on top



SSS-E
Three 16" clear acrylic segments on top

How to order and read your code

L - P P F C A - 42 24 - 0 0 E - E

product line	standard	P= glazed E = Elevated	F=Fabric L=Laminate	C= Clear F=Frosted	A=Acrylic G=Glass	height	width	0 = No segment E = 8 inch segment S = 16 inch segment T = 24 inch segment	N=Non powered E=Powered
--------------	----------	---------------------------	------------------------	-----------------------	----------------------	--------	-------	--	----------------------------

What's Included:

One (1) 2" thick laminate panel with 1" incremented slotted channels,
Two (2) raceway covers,
One (1) top trim

How to Specify:

Refer to laminate cards for laminate selections
Choose White, Black, Silver, Charcoal for Panel Frame colour

Options:

Height*: 34", 42", 50", 66", 82"

Width: 24", 30", 36", 42", 48",

Laminate

Metal Powder Coat Paint: White, Black, Silver, Charcoal

*82"H available up to 36"W

Notes:

Power capable panel with bracket for power module.

Power module must be specified separately.

Panels are non tackable. For tackable option see Panel Add-On section.

Fabric Upcharge
Grade 2 - \$216 per panel,
Grade 3 - \$266 per panel

Code	Price	H	W	D
One 8" clear acrylic segment on top				
L-PPFCA-4224-00E-E	1272	42	24	2
L-PPFCA-4230-00E-E	1355	42	30	2
L-PPFCA-4236-00E-E	1408	42	36	2
L-PPFCA-4242-00E-E	1463	42	42	2
L-PPFCA-4248-00E-E	1519	42	48	2
L-PPFCA-4254-00E-E	1612	42	54	2
L-PPFCA-4260-00E-E	1647	42	60	2
L-PPFCA-5024-00E-E	1272	50	24	2
L-PPFCA-5030-00E-E	1355	50	30	2
L-PPFCA-5036-00E-E	1408	50	36	2
L-PPFCA-5042-00E-E	1463	50	42	2
L-PPFCA-5048-00E-E	1519	50	48	2
L-PPFCA-5054-00E-E	1612	50	54	2
L-PPFCA-5060-00E-E	1647	50	60	2
One 16" clear acrylic segment on top				
L-PPFCA-5024-00S-E	1272	50	24	2
L-PPFCA-5030-00S-E	1355	50	30	2
L-PPFCA-5036-00S-E	1408	50	36	2
L-PPFCA-5042-00S-E	1463	50	42	2
L-PPFCA-5048-00S-E	1519	50	48	2
L-PPFCA-5054-00S-E	1612	50	54	2
L-PPFCA-5060-00S-E	1647	50	60	2
L-PPFCA-6624-00S-E	1402	66	24	2
L-PPFCA-6630-00S-E	1500	66	30	2
L-PPFCA-6636-00S-E	1591	66	36	2
L-PPFCA-6642-00S-E	1682	66	42	2
L-PPFCA-6648-00S-E	1756	66	48	2
L-PPFCA-6654-00S-E	1904	66	54	2
L-PPFCA-6660-00S-E	1939	66	60	2
L-PPFCA-8224-00S-E	1766	82	24	2
L-PPFCA-8230-00S-E	2046	82	30	2
L-PPFCA-8236-00S-E	2152	82	36	2
L-PPFCA-8242-00S-E	2202	82	42	2
L-PPFCA-8248-00S-E	2300	82	48	2
One 24" clear acrylic segment on top				
L-PPFCA-6624-00T-E	1402	66	24	2
L-PPFCA-6630-00T-E	1500	66	30	2
L-PPFCA-6636-00T-E	1591	66	36	2
L-PPFCA-6642-00T-E	1682	66	42	2
L-PPFCA-6648-00T-E	1756	66	48	2
L-PPFCA-6654-00T-E	1904	66	54	2
L-PPFCA-6660-00T-E	1939	66	60	2

Code	Price	H	W	D
Two 8" clear acrylic segments on top				
L-PPFCA-6624-0EE-E	1744	66	24	2
L-PPFCA-6630-0EE-E	1973	66	30	2
L-PPFCA-6636-0EE-E	2055	66	36	2
L-PPFCA-6642-0EE-E	2123	66	42	2
L-PPFCA-6648-0EE-E	2216	66	48	2
L-PPFCA-6654-0EE-E	2353	66	54	2
L-PPFCA-6660-0EE-E	2415	66	60	2
One 8" & One 16" clear acrylic segment on top				
L-PPFCA-6624-0ES-E	1703	66	24	2
L-PPFCA-6630-0ES-E	1925	66	30	2
L-PPFCA-6636-0ES-E	2022	66	36	2
L-PPFCA-6642-0ES-E	2118	66	42	2
L-PPFCA-6648-0ES-E	2220	66	48	2
L-PPFCA-6654-0ES-E	2326	66	54	2
L-PPFCA-6660-0ES-E	2378	66	60	2
Two 16" clear acrylic segments on top				
L-PPFCA-8224-0SS-E	1814	82	24	2
L-PPFCA-8230-0SS-E	2106	82	30	2
L-PPFCA-8236-0SS-E	2257	82	36	2
L-PPFCA-8242-0SS-E	2322	82	42	2
L-PPFCA-8248-0SS-E	2413	82	48	2
One 24" & One 16" clear acrylic segment on top				
L-PPFCA-8224-0TS-E	1804	82	24	2
L-PPFCA-8230-0TS-E	2069	82	30	2
L-PPFCA-8236-0TS-E	2152	82	36	2
L-PPFCA-8242-0TS-E	2217	82	42	2
L-PPFCA-8248-0TS-E	2438	82	48	2
Two 24" clear acrylic segments on top				
L-PPFCA-8224-0TT-E	1799	82	24	2
L-PPFCA-8230-0TT-E	2038	82	30	2
L-PPFCA-8236-0TT-E	2146	82	36	2
L-PPFCA-8242-0TT-E	2284	82	42	2
L-PPFCA-8248-0TT-E	2376	82	48	2
One 8" & Two 16" clear acrylic segments on top				
L-PPFCA-8224-ESS-E	1876	82	24	2
L-PPFCA-8230-ESS-E	2227	82	30	2
L-PPFCA-8236-ESS-E	2322	82	36	2
L-PPFCA-8242-ESS-E	2325	82	42	2
L-PPFCA-8248-ESS-E	2546	82	48	2
Three 16" clear acrylic segments on top				
L-PPFCA-8224-SSS-E	1910	82	24	2
L-PPFCA-8230-SSS-E	2158	82	30	2
L-PPFCA-8236-SSS-E	2358	82	36	2
L-PPFCA-8242-SSS-E	2435	82	42	2
L-PPFCA-8248-SSS-E	2538	82	48	2

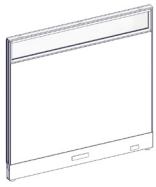

OOE-E
One 8" frosted acrylic segment on top

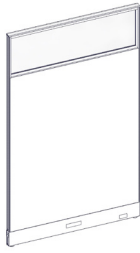

OOS-E
One 16" frosted acrylic segment on top



OOT-E
One 24" frosted acrylic segment on top



OEE-E
Two 8" frosted acrylic segments on top



OES-E
One 8" & One 16" frosted acrylic segment on top



OSS-E
Two 16" frosted acrylic segments on top



OTS-E
One 24" & One 16" frosted acrylic segment on top



OTT-E
Two 24" frosted acrylic segments on top



ESS-E
One 8" & Two 16" frosted acrylic segments on top



SSS-E
Three 16" frosted acrylic segments on top

How to order and read your code

L - P P F F A - 42 24 - 0 0 E - E

product standard P= glazed F=Fabric C= Clear A=Acrylic height width 0 = No segment N=Non powered
line E = Elevated L=Laminate F=Frosted G=Glass E = 8 inch segment E=Powered
S = 16 inch segment
T = 24 inch segment

What's Included:

One (1) 2" thick laminate panel with 1" incremented slotted channels,
Two (2) raceway covers,
One (1) top trim

How to Specify:

Refer to laminate cards for laminate selections
Choose White, Black, Silver, Charcoal for Panel Frame colour

Options:

Height*: 34", 42", 50", 66", 82"

Width: 24", 30", 36", 42", 48",

Laminate

Metal Powder Coat Paint: White, Black, Silver, Charcoal

*82"H available up to 36"W

Notes:

Power capable panel with bracket for power module.

Power module must be specified separately.

Panels are non tackable. For tackable option see Panel Add-On section.

Fabric Upcharge
Grade 2 - \$216 per panel,
Grade 3 - \$266 per panel

Code	Price	H	W	D
One 8" frosted acrylic segment on top				
L-PPFFA-4224-00E-E	1388	42	24	2
L-PPFFA-4230-00E-E	1472	42	30	2
L-PPFFA-4236-00E-E	1524	42	36	2
L-PPFFA-4242-00E-E	1578	42	42	2
L-PPFFA-4248-00E-E	1636	42	48	2
L-PPFFA-4254-00E-E	1727	42	54	2
L-PPFFA-4260-00E-E	1764	42	60	2
L-PPFFA-5024-00E-E	1388	50	24	2
L-PPFFA-5030-00E-E	1472	50	30	2
L-PPFFA-5036-00E-E	1524	50	36	2
L-PPFFA-5042-00E-E	1578	50	42	2
L-PPFFA-5048-00E-E	1636	50	48	2
L-PPFFA-5054-00E-E	1727	50	54	2
L-PPFFA-5060-00E-E	1764	50	60	2
One 16" frosted acrylic segment on top				
L-PPFFA-5024-00S-E	1388	50	24	2
L-PPFFA-5030-00S-E	1472	50	30	2
L-PPFFA-5036-00S-E	1524	50	36	2
L-PPFFA-5042-00S-E	1578	50	42	2
L-PPFFA-5048-00S-E	1636	50	48	2
L-PPFFA-5054-00S-E	1727	50	54	2
L-PPFFA-5060-00S-E	1764	50	60	2
L-PPFFA-6624-00S-E	1518	50	24	2
L-PPFFA-6630-00S-E	1616	50	30	2
L-PPFFA-6636-00S-E	1707	50	36	2
L-PPFFA-6642-00S-E	1797	50	42	2
L-PPFFA-6648-00S-E	1873	50	48	2
L-PPFFA-6654-00S-E	2021	50	54	2
L-PPFFA-6660-00S-E	2055	50	60	2
L-PPFFA-8224-00S-E	1806	82	24	2
L-PPFFA-8230-00S-E	2100	82	30	2
L-PPFFA-8236-00S-E	2220	82	36	2
L-PPFFA-8242-00S-E	2284	82	42	2
L-PPFFA-8248-00S-E	2383	82	48	2
One 24" frosted acrylic segment on top				
L-PPFFA-6624-00T-E	1518	66	24	2
L-PPFFA-6630-00T-E	1616	66	30	2
L-PPFFA-6636-00T-E	1707	66	36	2
L-PPFFA-6642-00T-E	1769	66	42	2
L-PPFFA-6648-00T-E	1845	66	48	2
L-PPFFA-6654-00T-E	2021	66	54	2
L-PPFFA-6660-00T-E	2055	66	60	2

Code	Price	H	W	D
Two 8" frosted acrylic segments on top				
L-PPFFA-6624-0EE-E	1816	66	24	2
L-PPFFA-6630-0EE-E	2072	66	30	2
L-PPFFA-6636-0EE-E	2184	66	36	2
L-PPFFA-6642-0EE-E	2248	66	42	2
L-PPFFA-6648-0EE-E	2360	66	48	2
L-PPFFA-6654-0EE-E	2456	66	54	2
L-PPFFA-6660-0EE-E	2517	66	60	2
One 8" & One 16" frosted acrylic segment on top				
L-PPFFA-6624-0ES-E	1765	66	24	2
L-PPFFA-6630-0ES-E	2005	66	30	2
L-PPFFA-6636-0ES-E	2119	66	36	2
L-PPFFA-6642-0ES-E	2242	66	42	2
L-PPFFA-6648-0ES-E	2344	66	48	2
L-PPFFA-6654-0ES-E	2461	66	54	2
L-PPFFA-6660-0ES-E	2536	66	60	2
Two 16" frosted acrylic segments on top				
L-PPFFA-8224-0SS-E	1698	82	24	2
L-PPFFA-8230-0SS-E	1941	82	30	2
L-PPFFA-8236-0SS-E	2035	82	36	2
L-PPFFA-8242-0SS-E	2108	82	42	2
L-PPFFA-8248-0SS-E	2191	82	48	2
One 24" & One 16" frosted acrylic segment on top				
L-PPFFA-8224-0TS-E	1926	82	24	2
L-PPFFA-8230-0TS-E	2231	82	30	2
L-PPFFA-8236-0TS-E	2313	82	36	2
L-PPFFA-8242-0TS-E	2419	82	42	2
L-PPFFA-8248-0TS-E	2685	82	48	2
Two 24" frosted acrylic segments on top				
L-PPFFA-8224-0TT-E	1922	82	24	2
L-PPFFA-8230-0TT-E	2202	82	30	2
L-PPFFA-8236-0TT-E	2344	82	36	2
L-PPFFA-8242-0TT-E	2529	82	42	2
L-PPFFA-8248-0TT-E	2621	82	48	2
One 8" & Two 16" frosted acrylic segments on top				
L-PPFFA-8224-ESS-E	2000	82	24	2
L-PPFFA-8230-ESS-E	2388	82	30	2
L-PPFFA-8236-ESS-E	2485	82	36	2
L-PPFFA-8242-ESS-E	2565	82	42	2
L-PPFFA-8248-ESS-E	2709	82	48	2
Three 16" frosted acrylic segments on top				
L-PPFFA-8224-SSS-E	2031	82	24	2
L-PPFFA-8230-SSS-E	2323	82	30	2
L-PPFFA-8236-SSS-E	2604	82	36	2
L-PPFFA-8242-SSS-E	2680	82	42	2
L-PPFFA-8248-SSS-E	2784	82	48	2

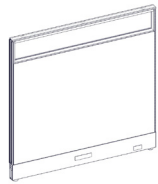

OOE-E
One 8" clear glass segment on top

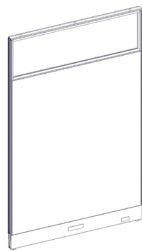

OOS-E
One 16" clear glass segment on top

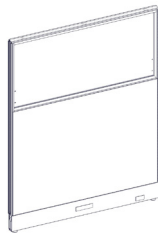

OOT-E
One 24" clear glass segment on top



OEE-E
Two 8" clear glass segments on top

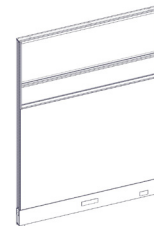

OES-E
One 8" & One 16" clear glass segment on top

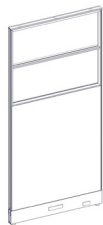

OSS-E
Two 16" clear glass segments on top



OTS-E
One 24" & One 16" clear glass segment on top



OTT-E
Two 24" clear glass segments on top



ESS-E
One 8" & Two 16" clear glass segments on top



SSS-E
Three 16" clear glass segments on top

How to order and read your code

L - P P F C G - 42 24 - 0 0 E - E

product line	standard	P= glazed E = Elevated	F=Fabric L=Laminate	C= Clear F=Frosted	A=Acrylic G=Glass	height	width	0 = No segment E = 8 inch segment S = 16 inch segment T = 24 inch segment	N=Non powered E=Powered
--------------	----------	---------------------------	------------------------	-----------------------	----------------------	--------	-------	--	----------------------------

What's Included:

One (1) 2" thick laminate panel with 1" incremented slotted channels,
Two (2) raceway covers,
One (1) top trim

How to Specify:

Refer to laminate cards for laminate selections
Choose White, Black, Silver, Charcoal for Panel Frame colour

Notes:

Power capable panel with bracket for power module.
Power module must be specified seperately.
Panels are non tackable. For tackable option see Panel Add-On section.
Fabric Upcharge
Grade 2 - \$216 per panel,
Grade 3 - \$266 per panel

Options:

Height*: 34", 42", 50", 66", 82"

Width: 24", 30", 36", 42", 48",

Laminate

Metal Powder Coat Paint: White, Black, Silver, Charcoal

*82"H available up to 36"W

Code	Price	H	W	D
One 8" clear glass segment on top				
L-PPFCG-4224-00E-E	1460	42	24	2
L-PPFCG-4230-00E-E	1551	42	30	2
L-PPFCG-4236-00E-E	1640	42	36	2
L-PPFCG-4242-00E-E	1787	42	42	2
L-PPFCG-4248-00E-E	1854	42	48	2
L-PPFCG-4254-00E-E	1910	42	54	2
L-PPFCG-4260-00E-E	1998	42	60	2
L-PPFCG-5024-00E-E	1460	50	24	2
L-PPFCG-5030-00E-E	1551	50	30	2
L-PPFCG-5036-00E-E	1640	50	36	2
L-PPFCG-5042-00E-E	1787	50	42	2
L-PPFCG-5048-00E-E	1854	50	48	2
L-PPFCG-5054-00E-E	1910	50	54	2
L-PPFCG-5060-00E-E	1998	50	60	2
One 16" clear glass segment on top				
L-PPFCG-5024-00S-E	1460	50	24	2
L-PPFCG-5030-00S-E	1551	50	30	2
L-PPFCG-5036-00S-E	1640	50	36	2
L-PPFCG-5042-00S-E	1787	50	42	2
L-PPFCG-5048-00S-E	1854	50	48	2
L-PPFCG-5054-00S-E	1910	50	54	2
L-PPFCG-5060-00S-E	1998	50	60	2
L-PPFCG-6624-00S-E	1519	66	24	2
L-PPFCG-6630-00S-E	1631	66	30	2
L-PPFCG-6636-00S-E	1744	66	36	2
L-PPFCG-6642-00S-E	1855	66	42	2
L-PPFCG-6648-00S-E	1970	66	48	2
L-PPFCG-6654-00S-E	2081	66	54	2
L-PPFCG-6660-00S-E	2195	66	60	2
L-PPFCG-8224-00S-E	1719	82	24	2
L-PPFCG-8230-00S-E	2027	82	30	2
L-PPFCG-8236-00S-E	2156	82	36	2
L-PPFCG-8242-00S-E	2228	82	42	2
L-PPFCG-8248-00S-E	2352	82	48	2
One 24" clear glass segment on top				
L-PPFCG-6624-00T-E	1519	66	24	2
L-PPFCG-6630-00T-E	1631	66	30	2
L-PPFCG-6636-00T-E	1744	66	36	2
L-PPFCG-6642-00T-E	1855	66	42	2
L-PPFCG-6648-00T-E	1970	66	48	2
L-PPFCG-6654-00T-E	2081	66	54	2
L-PPFCG-6660-00T-E	2195	66	60	2

Code	Price	H	W	D
Two 8" clear glass segments on top				
L-PPFCG-6624-0EE-E	1856	66	24	2
L-PPFCG-6630-0EE-E	2127	66	30	2
L-PPFCG-6636-0EE-E	2239	66	36	2
L-PPFCG-6642-0EE-E	2320	66	42	2
L-PPFCG-6648-0EE-E	2429	66	48	2
L-PPFCG-6654-0EE-E	2571	66	54	2
L-PPFCG-6660-0EE-E	2643	66	60	2
One 8" & One 16" clear glass segment on top				
L-PPFCG-6624-0ES-E	1810	66	24	2
L-PPFCG-6630-0ES-E	2047	66	30	2
L-PPFCG-6636-0ES-E	2163	66	36	2
L-PPFCG-6642-0ES-E	2269	66	42	2
L-PPFCG-6648-0ES-E	2403	66	48	2
L-PPFCG-6654-0ES-E	2555	66	54	2
L-PPFCG-6660-0ES-E	2637	66	60	2
Two 16" clear glass segments on top				
L-PPFCG-8224-0SS-E	1922	82	24	2
L-PPFCG-8230-0SS-E	2208	82	30	2
L-PPFCG-8236-0SS-E	2358	82	36	2
L-PPFCG-8242-0SS-E	2475	82	42	2
L-PPFCG-8248-0SS-E	2621	82	48	2
One 24" & One 16" clear glass segment on top				
L-PPFCG-8224-0TS-E	1908	82	24	2
L-PPFCG-8230-0TS-E	2172	82	30	2
L-PPFCG-8236-0TS-E	2317	82	36	2
L-PPFCG-8242-0TS-E	2450	82	42	2
L-PPFCG-8248-0TS-E	2612	82	48	2
Two 24" clear glass segments on top				
L-PPFCG-8224-0TT-E	1941	82	24	2
L-PPFCG-8230-0TT-E	2199	82	30	2
L-PPFCG-8236-0TT-E	2333	82	36	2
L-PPFCG-8242-0TT-E	2470	82	42	2
L-PPFCG-8248-0TT-E	2630	82	48	2
One 8" & Two 16" clear glass segments on top				
L-PPFCG-8224-ESS-E	2084	82	24	2
L-PPFCG-8230-ESS-E	2425	82	30	2
L-PPFCG-8236-ESS-E	2579	82	36	2
L-PPFCG-8242-ESS-E	2606	82	42	2
L-PPFCG-8248-ESS-E	2810	82	48	2
Three 16" clear glass segments on top				
L-PPFCG-8224-SSS-E	2128	82	24	2
L-PPFCG-8230-SSS-E	2376	82	30	2
L-PPFCG-8236-SSS-E	2538	82	36	2
L-PPFCG-8242-SSS-E	2693	82	42	2
L-PPFCG-8248-SSS-E	2877	82	48	2

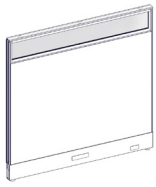

OOE-E
One 8" frosted glass segment on top

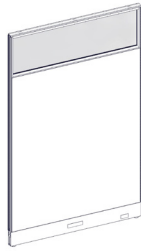

OOS-E
One 16" frosted glass segment on top



OOT-E
One 24" frosted glass segment on top



OEE-E
Two 8" frosted glass segments on top



OES-E
One 8" & One 16" frosted glass segment on top



OSS-E
Two 16" frosted glass segments on top



OTS-E
One 24" & One 16" frosted glass segment on top



OTT-E
Two 24" frosted glass segments on top



ESS-E
One 8" & Two 16" frosted glass segments on top



SSS-E
Three 16" frosted glass segments on top

How to order and read your code

L - P P F F G - 42 24 - 00E - E

product line standard P= glazed E = Elevated F=Fabric L=Laminate C= Clear F=Frosted A=Acrylic G=Glass height width 0 = No segment E = 8 inch segment S = 16 inch segment T = 24 inch segment N=Non powered E=Powered

What's Included:

One (1) 2" thick laminate panel with 1" incremented slotted channels,
Two (2) raceway covers,
One (1) top trim

How to Specify:

Refer to laminate cards for laminate selections
Choose White, Black, Silver, Charcoal for Panel Frame colour

Notes:

Power capable panel with bracket for power module.

Power module must be specified seperately.

Panels are non tackable. For tackable option see Panel Add-On section.

Fabric Upcharge
Grade 2 - \$216 per panel,
Grade 3 - \$266 per panel

Options:

Height*: 34", 42", 50", 66", 82"

Width: 24", 30", 36", 42", 48",

Laminate

Metal Powder Coat Paint: White, Black, Silver, Charcoal

*82"H available up to 36"W

Code	Price	H	W	D
One 8" frosted glass segment on top				
L-PPFFG-4224-00E-E	1575	42	24	2
L-PPFFG-4230-00E-E	1669	42	30	2
L-PPFFG-4236-00E-E	1756	42	36	2
L-PPFFG-4242-00E-E	1902	42	42	2
L-PPFFG-4248-00E-E	1971	42	48	2
L-PPFFG-4254-00E-E	2026	42	54	2
L-PPFFG-4260-00E-E	2115	42	60	2
L-PPFFG-5024-00E-E	1575	50	24	2
L-PPFFG-5030-00E-E	1669	50	30	2
L-PPFFG-5036-00E-E	1756	50	36	2
L-PPFFG-5042-00E-E	1902	50	42	2
L-PPFFG-5048-00E-E	1971	50	48	2
L-PPFFG-5054-00E-E	2026	50	54	2
L-PPFFG-5060-00E-E	2115	50	60	2
One 16" frosted glass segment on top				
L-PPFFG-5024-00S-E	1575	50	24	2
L-PPFFG-5030-00S-E	1669	50	30	2
L-PPFFG-5036-00S-E	1756	50	36	2
L-PPFFG-5042-00S-E	1902	50	42	2
L-PPFFG-5048-00S-E	1971	50	48	2
L-PPFFG-5054-00S-E	2026	50	54	2
L-PPFFG-5060-00S-E	2115	50	60	2
L-PPFFG-6624-00S-E	1636	66	24	2
L-PPFFG-6630-00S-E	1747	66	30	2
L-PPFFG-6636-00S-E	1860	66	36	2
L-PPFFG-6642-00S-E	1972	66	42	2
L-PPFFG-6648-00S-E	2084	66	48	2
L-PPFFG-6654-00S-E	2197	66	54	2
L-PPFFG-6660-00S-E	2311	66	60	2
L-PPFFG-8224-00S-E	1817	82	24	2
L-PPFFG-8230-00S-E	2140	82	30	2
L-PPFFG-8236-00S-E	2288	82	36	2
L-PPFFG-8242-00S-E	2383	82	42	2
L-PPFFG-8248-00S-E	2529	82	48	2
One 24" frosted glass segment on top				
L-PPFFG-6624-00T-E	1636	66	24	2
L-PPFFG-6630-00T-E	1747	66	30	2
L-PPFFG-6636-00T-E	1860	66	36	2
L-PPFFG-6642-00T-E	1972	66	42	2
L-PPFFG-6648-00T-E	2084	66	48	2
L-PPFFG-6654-00T-E	2197	66	54	2
L-PPFFG-6660-00T-E	2311	66	60	2

Code	Price	H	W	D
Two 8" frosted glass segments on top				
L-PPFFG-6624-0EE-E	2055	66	24	2
L-PPFFG-6630-0EE-E	2325	66	30	2
L-PPFFG-6636-0EE-E	2437	66	36	2
L-PPFFG-6642-0EE-E	2517	66	42	2
L-PPFFG-6648-0EE-E	2628	66	48	2
L-PPFFG-6654-0EE-E	2770	66	54	2
L-PPFFG-6660-0EE-E	2863	66	60	2
One 8" & One 16" frosted glass segment on top				
L-PPFFG-6624-0ES-E	2009	66	24	2
L-PPFFG-6630-0ES-E	2257	66	30	2
L-PPFFG-6636-0ES-E	2396	66	36	2
L-PPFFG-6642-0ES-E	2524	66	42	2
L-PPFFG-6648-0ES-E	2680	66	48	2
L-PPFFG-6654-0ES-E	2854	66	54	2
L-PPFFG-6660-0ES-E	2967	66	60	2
Two 16" frosted glass segments on top				
L-PPFFG-8224-0SS-E	2119	82	24	2
L-PPFFG-8230-0SS-E	2429	82	30	2
L-PPFFG-8236-0SS-E	2623	82	36	2
L-PPFFG-8242-0SS-E	2784	82	42	2
L-PPFFG-8248-0SS-E	2971	82	48	2
One 24" & One 16" frosted glass segment on top				
L-PPFFG-8224-0TS-E	2141	82	24	2
L-PPFFG-8230-0TS-E	2450	82	30	2
L-PPFFG-8236-0TS-E	2647	82	36	2
L-PPFFG-8242-0TS-E	2836	82	42	2
L-PPFFG-8248-0TS-E	3053	82	48	2
Two 24" frosted glass segments on top				
L-PPFFG-8224-0TT-E	2207	82	24	2
L-PPFFG-8230-0TT-E	2529	82	30	2
L-PPFFG-8236-0TT-E	2728	82	36	2
L-PPFFG-8242-0TT-E	2932	82	42	2
L-PPFFG-8248-0TT-E	3161	82	48	2
One 8" & Two 16" frosted glass segments on top				
L-PPFFG-8224-ESS-E	2383	82	24	2
L-PPFFG-8230-ESS-E	2742	82	30	2
L-PPFFG-8236-ESS-E	2942	82	36	2
L-PPFFG-8242-ESS-E	3012	82	42	2
L-PPFFG-8248-ESS-E	3261	82	48	2
Three 16" frosted glass segments on top				
L-PPFFG-8224-SSS-E	2426	82	24	2
L-PPFFG-8230-SSS-E	2705	82	30	2
L-PPFFG-8236-SSS-E	2933	82	36	2
L-PPFFG-8242-SSS-E	3157	82	42	2
L-PPFFG-8248-SSS-E	3403	82	48	2



OOE-E
One 8" clear acrylic segment on top



OOS-E
One 16" clear acrylic segment on top

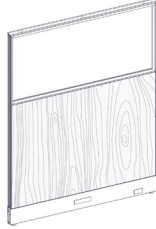

OOT-E
One 24" clear acrylic segment on top

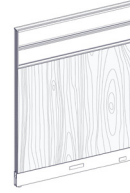

OEE-E
Two 8" clear acrylic segments on top

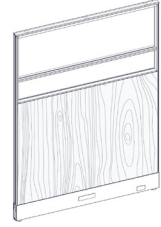

OES-E
One 8" & One 16" clear acrylic segment on top



OSS-E
Two 16" clear acrylic segments on top



OTS-E
One 24" & One 16" clear acrylic segment on top



OTT-E
Two 24" clear acrylic segments on top



ESS-E
One 8" & Two 16" clear acrylic segments on top



SSS-E
Three 16" clear acrylic segments on top

How to order and read your code

L - P P L C A - 42 24 - 0 0 E - E

product line	standard	P=glazed E=Elevated	F=Fabric L=Laminate	C=Clear F=Frosted	A=Acrylic G=Glass	height	width	0 = No segment E = 8 inch segment S = 16 inch segment T = 24 inch segment	N=Non powered E=Powered
--------------	----------	------------------------	------------------------	----------------------	----------------------	--------	-------	--	----------------------------

What's Included:

One (1) 2" thick laminate panel with 1" incremented slotted channels,
Two (2) raceway covers,
One (1) top trim

How to Specify:

Refer to laminate cards for laminate selections
Choose White, Black, Silver, Charcoal for Panel Frame colour

Notes:

Power capable panel with bracket for power module.
Power module must be specified separately.
Panels are non tackable. For tackable option see Panel Add-On section.

Options:

Height*: 34", 42", 50", 66", 82"

Width: 24", 30", 36", 42", 48",

Laminate

Metal Powder Coat Paint: White, Black, Silver, Charcoal

*82"H available up to 36"W

Code	Price	H	W	D
One 8" clear acrylic segment on top				
L-PPLCA-4224-00E-E	1336	42	24	2
L-PPLCA-4230-00E-E	1398	42	30	2
L-PPLCA-4236-00E-E	1458	42	36	2
L-PPLCA-4242-00E-E	1585	42	42	2
L-PPLCA-4248-00E-E	1599	42	48	2
L-PPLCA-5024-00E-E	1378	50	24	2
L-PPLCA-5030-00E-E	1438	50	30	2
L-PPLCA-5036-00E-E	1500	50	36	2
L-PPLCA-5042-00E-E	1651	50	42	2
L-PPLCA-5048-00E-E	1690	50	48	2
One 16" clear acrylic segment on top				
L-PPLCA-5024-00S-E	1391	50	24	2
L-PPLCA-5030-00S-E	1452	50	30	2
L-PPLCA-5036-00S-E	1519	50	36	2
L-PPLCA-5042-00S-E	1685	50	42	2
L-PPLCA-5048-00S-E	1721	50	48	2
L-PPLCA-6624-00S-E	1504	66	24	2
L-PPLCA-6630-00S-E	1592	66	30	2
L-PPLCA-6636-00S-E	1682	66	36	2
L-PPLCA-6642-00S-E	1904	66	42	2
L-PPLCA-6648-00S-E	1950	66	48	2
L-PPLCA-8224-00S-E	1844	82	24	2
L-PPLCA-8230-00S-E	1864	82	30	2
L-PPLCA-8236-00S-E	2480	82	36	2
One 24" clear acrylic segment on top				
L-PPLCA-6624-00T-E	1504	66	24	2
L-PPLCA-6630-00T-E	1613	66	30	2
L-PPLCA-6636-00T-E	1719	66	36	2
L-PPLCA-6642-00T-E	1904	66	42	2
L-PPLCA-6648-00T-E	1950	66	48	2

Code	Price	H	W	D
Two 8" clear acrylic segments on top				
L-PPLCA-6624-0EE-E	1613	66	24	2
L-PPLCA-6630-0EE-E	1631	66	30	2
L-PPLCA-6636-0EE-E	1964	66	36	2
L-PPLCA-6642-0EE-E	2010	66	42	2
L-PPLCA-6648-0EE-E	2076	66	48	2
One 8" & One 16" clear acrylic segment on top				
L-PPLCA-6624-0ES-E	1620	66	24	2
L-PPLCA-6630-0ES-E	1687	66	30	2
L-PPLCA-6636-0ES-E	2047	66	36	2
L-PPLCA-6642-0ES-E	2116	66	42	2
L-PPLCA-6648-0ES-E	2184	66	48	2
Two 16" clear acrylic segments on top				
L-PPLCA-8224-0SS-E	1682	82	24	2
L-PPLCA-8230-0SS-E	1766	82	30	2
L-PPLCA-8236-0SS-E	2167	82	36	2
One 24" & One 16" clear acrylic segment on top				
L-PPLCA-8224-0TS-E	1719	82	24	2
L-PPLCA-8230-0TS-E	1829	82	30	2
L-PPLCA-8236-0TS-E	2177	82	36	2
Two 24" clear acrylic segments on top				
L-PPLCA-8224-0TT-E	1646	82	24	2
L-PPLCA-8230-0TT-E	1743	82	30	2
L-PPLCA-8236-0TT-E	2042	82	36	2
One 8" & Two 16" clear acrylic segments on top				
L-PPLCA-8224-ESS-E	1793	82	24	2
L-PPLCA-8230-ESS-E	1986	82	30	2
L-PPLCA-8236-ESS-E	2347	82	36	2
Three 16" clear acrylic segments on top				
L-PPLCA-8224-SSS-E	1756	82	24	2
L-PPLCA-8230-SSS-E	1863	82	30	2
L-PPLCA-8236-SSS-E	2253	82	36	2



OOE-E
One 8" frosted glass segment on top



OOS-E
One 16" frosted glass segment on top



OOT-E
One 24" frosted glass segment on top

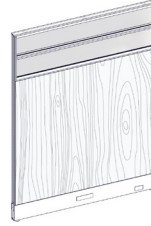

OEE-E
Two 8" frosted glass segments on top



OES-E
One 8" & One 16" frosted glass segment on top



OSS-E
Two 16" frosted glass segments on top



OTS-E
One 24" & One 16" frosted glass segment on top



OTT-E
Two 24" frosted glass segments on top



ESS-E
One 8" & Two 16" frosted glass segments on top



SSS-E
Three 16" frosted glass segments on top

How to order and read your code

L - P P L F A - 42 24 - 0 0 E - E

product line	standard	P= glazed E = Elevated	F=Fabric L=Laminate	C= Clear F=Frosted	A=Acrylic G=Glass	height	width	0 = No segment E = 8 inch segment S = 16 inch segment T = 24 inch segment	N=Non powered E=Powered
--------------	----------	---------------------------	------------------------	-----------------------	----------------------	--------	-------	--	----------------------------

What's Included:

One (1) 2" thick laminate panel with 1" incremented slotted channels,
Two (2) raceway covers,
One (1) top trim

How to Specify:

Refer to laminate cards for laminate selections
Choose White, Black, Silver, Charcoal for Panel Frame colour

Notes:

Power capable panel with bracket for power module.
Power module must be specified separately.
Panels are non tackable. For tackable option see Panel Add-On section.

Options:

Height*: 34", 42", 50", 66", 82"

Width: 24", 30", 36", 42", 48",

Laminate

Metal Powder Coat Paint: White, Black, Silver, Charcoal

*82"H available up to 36"W

Code	Price	H	W	D
One 8" frosted acrylic segment on top				
L-PPLFA-4224-00E-E	1452	42	24	2
L-PPLFA-4230-00E-E	1515	42	30	2
L-PPLFA-4236-00E-E	1574	42	36	2
L-PPLFA-4242-00E-E	1699	42	42	2
L-PPLFA-4248-00E-E	1716	42	48	2
L-PPLFA-5024-00E-E	1494	50	24	2
L-PPLFA-5030-00E-E	1555	50	30	2
L-PPLFA-5036-00E-E	1616	50	36	2
L-PPLFA-5042-00E-E	1769	50	42	2
L-PPLFA-5048-00E-E	1805	50	48	2
One 16" frosted acrylic segment on top				
L-PPLFA-5024-00S-E	1507	50	24	2
L-PPLFA-5030-00S-E	1570	50	30	2
L-PPLFA-5036-00S-E	1636	50	36	2
L-PPLFA-5042-00S-E	1799	50	42	2
L-PPLFA-5048-00S-E	1840	50	48	2
L-PPLFA-6624-00S-E	1621	66	24	2
L-PPLFA-6630-00S-E	1709	66	30	2
L-PPLFA-6636-00S-E	1797	66	36	2
L-PPLFA-6642-00S-E	2021	66	42	2
L-PPLFA-6648-00S-E	2068	66	48	2
L-PPLFA-8224-00S-E	1885	82	24	2
L-PPLFA-8230-00S-E	1921	82	30	2
L-PPLFA-8236-00S-E	2551	82	36	2
One 24" frosted acrylic segment on top				
L-PPLFA-6624-00T-E	1621	66	24	2
L-PPLFA-6630-00T-E	1728	66	30	2
L-PPLFA-6636-00T-E	1770	66	36	2
L-PPLFA-6642-00T-E	2021	66	42	2
L-PPLFA-6648-00T-E	2068	66	48	2

Code	Price	H	W	D
Two 8" frosted acrylic segments on top				
L-PPLFA-6624-0EE-E	1686	66	24	2
L-PPLFA-6630-0EE-E	1730	66	30	2
L-PPLFA-6636-0EE-E	2095	66	36	2
L-PPLFA-6642-0EE-E	2137	66	42	2
L-PPLFA-6648-0EE-E	2223	66	48	2
One 8" & One 16" frosted acrylic segment on top				
L-PPLFA-6624-0ES-E	1679	66	24	2
L-PPLFA-6630-0ES-E	1766	66	30	2
L-PPLFA-6636-0ES-E	2146	66	36	2
L-PPLFA-6642-0ES-E	2237	66	42	2
L-PPLFA-6648-0ES-E	2309	66	48	2
Two 16" frosted acrylic segments on top				
L-PPLFA-8224-0SS-E	1566	82	24	2
L-PPLFA-8230-0SS-E	1601	82	30	2
L-PPLFA-8236-0SS-E	1947	82	36	2
One 24" & One 16" frosted acrylic segment on top				
L-PPLFA-8224-0TS-E	1843	82	24	2
L-PPLFA-8230-0TS-E	1993	82	30	2
L-PPLFA-8236-0TS-E	2339	82	36	2
Two 24" frosted acrylic segments on top				
L-PPLFA-8224-0TT-E	1768	82	24	2
L-PPLFA-8230-0TT-E	1906	82	30	2
L-PPLFA-8236-0TT-E	2237	82	36	2
One 8" & Two 16" frosted acrylic segments on top				
L-PPLFA-8224-ESS-E	1915	82	24	2
L-PPLFA-8230-ESS-E	2152	82	30	2
L-PPLFA-8236-ESS-E	2510	82	36	2
Three 16" frosted acrylic segments on top				
L-PPLFA-8224-SSS-E	1878	82	24	2
L-PPLFA-8230-SSS-E	2027	82	30	2
L-PPLFA-8236-SSS-E	2498	82	36	2



OOE-E
One 8" clear glass segment on top



OOS-E
One 16" clear glass segment on top



OOT-E
One 24" clear glass segment on top



OEE-E
Two 8" clear glass segments on top

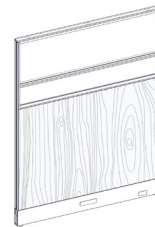

OES-E
One 8" & One 16" clear glass segment on top



OSS-E
Two 16" clear glass segments on top



OTS-E
One 24" & One 16" clear glass segment on top



OTT-E
Two 24" clear glass segments on top



ESS-E
One 8" & Two 16" clear glass segments on top



SSS-E
Three 16" clear glass segments on top

How to order and read your code

L - P P L C G - 42 24 - 0 0 E - E

product line	standard	P=glazed E=Elevated	F=Fabric L=Laminate	C=Clear F=Frosted	A=Acrylic G=Glass	height	width	0 = No segment E = 8 inch segment S = 16 inch segment T = 24 inch segment	N=Non powered E=Powered
--------------	----------	------------------------	------------------------	----------------------	----------------------	--------	-------	--	----------------------------

What's Included:

One (1) 2" thick laminate panel with 1" incremented slotted channels,
Two (2) raceway covers,
One (1) top trim

How to Specify:

Refer to laminate cards for laminate selections
Choose White, Black, Silver, Charcoal for Panel Frame colour

Options:

Height*: 34", 42", 50", 66", 82"

Width: 24", 30", 36", 42", 48",

Laminate

Metal Powder Coat Paint: White, Black, Silver, Charcoal

*82"H available up to 36"W

Notes:

Power capable panel with bracket for power module.

Power module must be specified separately.

Panels are non tackable. For tackable option see Panel Add-On section.

Code	Price	H	W	D
One 8" clear glass segment on top				
L-PPLCG-4224-00E-E	1937	42	24	2
L-PPLCG-4230-00E-E	1521	42	30	2
L-PPLCG-4236-00E-E	1590	42	36	2
L-PPLCG-4242-00E-E	1670	42	42	2
L-PPLCG-4248-00E-E	1749	42	48	2
L-PPLCG-5024-00E-E	1493	50	24	2
L-PPLCG-5030-00E-E	1563	50	30	2
L-PPLCG-5036-00E-E	1635	50	36	2
L-PPLCG-5042-00E-E	1713	50	42	2
L-PPLCG-5048-00E-E	1792	50	48	2
One 16" clear glass segment on top				
L-PPLCG-5024-00S-E	1578	50	24	2
L-PPLCG-5030-00S-E	1649	50	30	2
L-PPLCG-5036-00S-E	1721	50	36	2
L-PPLCG-5042-00S-E	1799	50	42	2
L-PPLCG-5048-00S-E	1879	50	48	2
L-PPLCG-6624-00S-E	1715	66	24	2
L-PPLCG-6630-00S-E	1802	66	30	2
L-PPLCG-6636-00S-E	1888	66	36	2
L-PPLCG-6642-00S-E	1999	66	42	2
L-PPLCG-6648-00S-E	2082	66	48	2
L-PPLCG-8224-00S-E	1796	82	24	2
L-PPLCG-8230-00S-E	1846	82	30	2
L-PPLCG-8236-00S-E	2486	82	36	2
One 24" clear glass segment on top				
L-PPLCG-6624-00T-E	1763	66	24	2
L-PPLCG-6630-00T-E	1850	66	30	2
L-PPLCG-6636-00T-E	1939	66	36	2
L-PPLCG-6642-00T-E	2057	66	42	2
L-PPLCG-6648-00T-E	2159	66	48	2

Code	Price	H	W	D
Two 8" clear glass segments on top				
L-PPLCG-6624-0EE-E	1725	66	24	2
L-PPLCG-6630-0EE-E	1787	66	30	2
L-PPLCG-6636-0EE-E	2149	66	36	2
L-PPLCG-6642-0EE-E	2207	66	42	2
L-PPLCG-6648-0EE-E	2292	66	48	2
One 8" & One 16" clear glass segment on top				
L-PPLCG-6624-0ES-E	1725	66	24	2
L-PPLCG-6630-0ES-E	1807	66	30	2
L-PPLCG-6636-0ES-E	2191	66	36	2
L-PPLCG-6642-0ES-E	2267	66	42	2
L-PPLCG-6648-0ES-E	2370	66	48	2
Two 16" clear glass segments on top				
L-PPLCG-8224-0SS-E	1791	82	24	2
L-PPLCG-8230-0SS-E	1868	82	30	2
L-PPLCG-8236-0SS-E	2269	82	36	2
One 24" & One 16" clear glass segment on top				
L-PPLCG-8224-0TS-E	1825	82	24	2
L-PPLCG-8230-0TS-E	1933	82	30	2
L-PPLCG-8236-0TS-E	2344	82	36	2
Two 24" clear glass segments on top				
L-PPLCG-8224-0TT-E	1790	82	24	2
L-PPLCG-8230-0TT-E	1904	82	30	2
L-PPLCG-8236-0TT-E	2227	82	36	2
One 8" & Two 16" clear glass segments on top				
L-PPLCG-8224-ESS-E	2000	82	24	2
L-PPLCG-8230-ESS-E	2185	82	30	2
L-PPLCG-8236-ESS-E	2606	82	36	2
Three 16" clear glass segments on top				
L-PPLCG-8224-SSS-E	1974	82	24	2
L-PPLCG-8230-SSS-E	2080	82	30	2
L-PPLCG-8236-SSS-E	2431	82	36	2



OOE-E
One 8" frosted glass segment on top



OOS-E
One 16" frosted glass segment on top



OOT-E
One 24" frosted glass segment on top



OEE-E
Two 8" frosted glass segments on top



OES-E
One 8" & One 16" frosted glass segment on top



OSS-E
Two 16" frosted glass segments on top



OTS-E
One 24" & One 16" frosted glass segment on top



OTT-E
Two 24" frosted glass segments on top



ESS-E
One 8" & Two 16" frosted glass segments on top



SSS-E
Three 16" frosted glass segments on top

How to order and read your code

L - P P L F G - 42 24 - 0 0 E - E

product line	standard	P= glazed E = Elevated	F=Fabric L=Laminate	C= Clear F=Frosted	A=Acrylic G=Glass	height	width	0 = No segment E = 8 inch segment S = 16 inch segment T = 24 inch segment	N=Non powered E=Powered
--------------	----------	---------------------------	------------------------	-----------------------	----------------------	--------	-------	--	----------------------------

What's Included:

One (1) 2" thick laminate panel with 1" incremented slotted channels,
Two (2) raceway covers,
One (1) top trim

How to Specify:

Refer to laminate cards for laminate selections
Choose White, Black, Silver, Charcoal for Panel Frame colour

Notes:

Power capable panel with bracket for power module.
Power module must be specified separately.
Panels are non tackable. For tackable option see Panel Add-On section.

Options:

Height*: 34", 42", 50", 66", 82"

Width: 24", 30", 36", 42", 48",

Laminate

Metal Powder Coat Paint: White, Black, Silver, Charcoal

*82"H available up to 36"W

Code	Price	H	W	D
One 8" frosted glass segment on top				
L-PPLFG-4224-00E-E	2054	42	24	2
L-PPLFG-4230-00E-E	1637	42	30	2
L-PPLFG-4236-00E-E	1706	42	36	2
L-PPLFG-4242-00E-E	1787	42	42	2
L-PPLFG-4248-00E-E	1866	42	48	2
L-PPLFG-5024-00E-E	1609	50	24	2
L-PPLFG-5030-00E-E	1678	50	30	2
L-PPLFG-5036-00E-E	1749	50	36	2
L-PPLFG-5042-00E-E	1829	50	42	2
L-PPLFG-5048-00E-E	1908	50	48	2
One 16" frosted glass segment on top				
L-PPLFG-5024-00S-E	1697	50	24	2
L-PPLFG-5030-00S-E	1766	50	30	2
L-PPLFG-5036-00S-E	1840	50	36	2
L-PPLFG-5042-00S-E	1915	50	42	2
L-PPLFG-5048-00S-E	1997	50	48	2
L-PPLFG-6624-00S-E	1830	66	24	2
L-PPLFG-6630-00S-E	1917	66	30	2
L-PPLFG-6636-00S-E	2003	66	36	2
L-PPLFG-6642-00S-E	2116	66	42	2
L-PPLFG-6648-00S-E	2199	66	48	2
L-PPLFG-8224-00S-E	1896	82	24	2
L-PPLFG-8230-00S-E	1958	82	30	2
L-PPLFG-8236-00S-E	2617	82	36	2
One 24" frosted glass segment on top				
L-PPLFG-6624-00T-E	1878	66	24	2
L-PPLFG-6630-00T-E	1966	66	30	2
L-PPLFG-6636-00T-E	2055	66	36	2
L-PPLFG-6642-00T-E	2173	66	42	2
L-PPLFG-6648-00T-E	2275	66	48	2

Code	Price	H	W	D
Two 8" frosted glass segments on top				
L-PPLFG-6624-0EE-E	1924	66	24	2
L-PPLFG-6630-0EE-E	1984	66	30	2
L-PPLFG-6636-0EE-E	2347	66	36	2
L-PPLFG-6642-0EE-E	2403	66	42	2
L-PPLFG-6648-0EE-E	2490	66	48	2
One 8" & One 16" frosted glass segment on top				
L-PPLFG-6624-0ES-E	1924	66	24	2
L-PPLFG-6630-0ES-E	2019	66	30	2
L-PPLFG-6636-0ES-E	2424	66	36	2
L-PPLFG-6642-0ES-E	2520	66	42	2
L-PPLFG-6648-0ES-E	2643	66	48	2
Two 16" frosted glass segments on top				
L-PPLFG-8224-0SS-E	1988	82	24	2
L-PPLFG-8230-0SS-E	2087	82	30	2
L-PPLFG-8236-0SS-E	2532	82	36	2
One 24" & One 16" frosted glass segment on top				
L-PPLFG-8224-0TS-E	2055	82	24	2
L-PPLFG-8230-0TS-E	2208	82	30	2
L-PPLFG-8236-0TS-E	2673	82	36	2
Two 24" frosted glass segments on top				
L-PPLFG-8224-0TT-E	2054	82	24	2
L-PPLFG-8230-0TT-E	2232	82	30	2
L-PPLFG-8236-0TT-E	2624	82	36	2
One 8" & Two 16" frosted glass segments on top				
L-PPLFG-8224-ESS-E	2298	82	24	2
L-PPLFG-8230-ESS-E	2504	82	30	2
L-PPLFG-8236-ESS-E	2969	82	36	2
Three 16" frosted glass segments on top				
L-PPLFG-8224-SSS-E	2272	82	24	2
L-PPLFG-8230-SSS-E	2410	82	30	2
L-PPLFG-8236-SSS-E	2829	82	36	2



Elevated Non-Powered
Fabric Panel

What's Included:

One (1) 2" thick fabric panel with
1" incremented slotted channels,
One (1) top trim

How to Specify:

Refer to panel fabric cards for fabric selections
Choose White, Black, Silver, Charcoal for Panel
Frame colour

Notes:

Non-power capable panel.
Can be used in run with power-capable
panels and allows wires to pass through.
Panels are non tackable. For tackable
option see Panel Add-On section.
Fabric Upcharge
Grade 2 - \$216 per panel,
Grade 3 - \$266 per panel

Options:

Height*: 34", 42", 50", 66", 82"

Width: 24", 30", 36", 42", 48", 54", 60", 66", 72"

Fabric

Metal Powder Coat Paint: White, Black, Silver, Charcoal

*34" high - 50" high available up to 72" wide, 66" high available up to 60" wide, 82" high available up to 48" wide

Code	Price	H	W	D	Weight (lb.)	Volume (ft ³)
L-PEF0-3424	675	34	24	2	14.84	0.94
L-PEF0-3430	713	34	30	2	18.55	1.18
L-PEF0-3436	809	34	36	2	22.26	1.42
L-PEF0-3442	852	34	42	2	25.96	1.65
L-PEF0-3448	883	34	48	2	29.67	1.89
L-PEF0-3454	921	34	54	2	33.38	2.13
L-PEF0-3460	962	34	60	2	37.09	2.36
L-PEF0-4224	675	42	24	2	18.33	1.17
L-PEF0-4230	713	42	30	2	22.91	1.46
L-PEF0-4236	809	42	36	2	27.49	1.75
L-PEF0-4242	852	42	42	2	32.07	2.04
L-PEF0-4248	883	42	48	2	36.66	2.33
L-PEF0-4254	928	42	54	2	41.24	2.63
L-PEF0-4260	962	42	60	2	45.82	2.92
L-PEF0-5024	726	50	24	2	21.82	1.39
L-PEF0-5030	766	50	30	2	27.27	1.74
L-PEF0-5036	851	50	36	2	32.73	2.08
L-PEF0-5042	906	50	42	2	38.18	2.43
L-PEF0-5048	964	50	48	2	43.64	2.78
L-PEF0-5054	1020	50	54	2	49.09	3.13
L-PEF0-5060	1058	50	60	2	54.55	3.47
L-PEF0-6624	766	66	24	2	28.80	1.83
L-PEF0-6630	831	66	30	2	36.00	2.29
L-PEF0-6636	889	66	36	2	43.20	2.75
L-PEF0-6642	950	66	42	2	50.40	3.21
L-PEF0-6648	1008	66	48	2	57.60	3.67
L-PEF0-6654	1071	66	54	2	64.80	4.13
L-PEF0-6660	1131	66	60	2	72.00	4.58
L-PEF0-8224	1071	82	24	2		
L-PEF0-8230	1149	82	30	2		
L-PEF0-8236	1392	82	36	2		
L-PEF0-8242	1465	82	42	2		
L-PEF0-8248	1540	82	48	2		

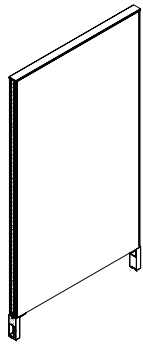

Elevated Monolithic
Non-powered
Laminate Panel

What's Included:

One (1) 2" thick laminate panel with
1" incremented slotted channels,
One (1) top trim

How to Specify:

Refer to laminate cards for laminate selections
Choose White, Black, Silver, Charcoal for Panel
Frame colour

Notes:

Non-power capable panel.
Can be used in run with power-capable
panels and allows wires to pass through.
Panels are non tackable. For tackable
option see Panel Add-On section.

Options:

Height*: 34", 42", 50", 66", 82"

Width: 24", 30", 36", 42", 48",

Laminate

Metal Powder Coat Paint: White, Black, Silver, Charcoal

*82"H available up to 36"W

Code	Price	H	W	D	Weight (lb.)	Volume (ft ³)
L-PELO-3424	738	34	24	2	14.84	0.94
L-PELO-3430	800	34	30	2	18.55	1.18
L-PELO-3436	862	34	36	2	22.26	1.42
L-PELO-3442	933	34	42	2	25.96	1.65
L-PELO-3448	1004	34	48	2	29.67	1.89
L-PELO-4224	789	42	24	2	18.33	1.17
L-PELO-4230	852	42	30	2	22.91	1.46
L-PELO-4236	911	42	36	2	27.49	1.75
L-PELO-4242	1006	42	42	2	32.07	2.04
L-PELO-4248	1053	42	48	2	36.66	2.33
L-PELO-5024	867	50	24	2	21.82	1.39
L-PELO-5030	937	50	30	2	27.27	1.74
L-PELO-5036	1007	50	36	2	32.73	2.08
L-PELO-5042	1151	50	42	2	38.18	2.43
L-PELO-5048	1184	50	48	2	43.64	2.78
L-PELO-6624	970	66	24	2	28.80	1.83
L-PELO-6630	1058	66	30	2	36.00	2.29
L-PELO-6636	1148	66	36	2	43.20	2.75
L-PELO-6642	1319	66	42	2	50.40	3.21
L-PELO-6648	1358	66	48	2	57.60	3.67
L-PELO-8224	1187	82	24	2		
L-PELO-8230	1195	82	30	2		
L-PELO-8236	1522	82	36	2		



OOE
One 8" clear acrylic segment on top

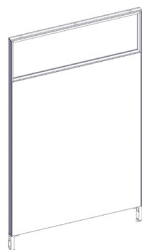

OOS
One 16" clear acrylic segment on top

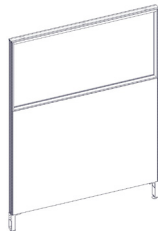

OOT
One 24" clear acrylic segment on top



OEE
Two 8" clear acrylic segments on top

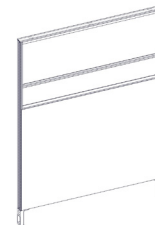

OES
One 8" & One 16" clear acrylic segment on top



OSS
Two 16" clear acrylic segments on top



OTS
One 24" & One 16" clear acrylic segment on top



OTT
Two 24" clear acrylic segments on top



ESS
One 8" & Two 16" clear acrylic segments on top



SSS
Three 16" clear acrylic segments on top

How to order and read your code

L - P E F C A - 42 24 - 0 0 E

product line	standard	P= glazed E = Elevated	F=Fabric L=Laminate	C= Clear F=Frosted	A=Acrylic G=Glass	height	width	0 = No segment E = 8 inch segment S = 16 inch segment T = 24 inch segment
--------------	----------	---------------------------	------------------------	-----------------------	----------------------	--------	-------	--

What's Included:

One (1) 2" thick fabric panel with glazed glass top and laminate bottom, also with 1" incremented slotted channels, One (1) top trim

How to Specify:

Refer to panel fabric cards for fabric selections
Choose White, Black, Silver, Charcoal for Panel Frame colour

Options:

Height*: 34", 42", 50", 66", 82"
Width: 24", 30", 36", 42", 48", 54", 60", 66", 72"
Fabric
Glass/Acrylic
Metal Powder Coat Paint: White, Black, Silver, Charcoal

Notes:

Non-power capable panel.
Can be used in run with power-capable panels and allows wires to pass through.
Panels are non tackable. For tackable option see Panel Add-On section.
Fabric Upcharge
Grade 2 - \$216 per panel,
Grade 3 - \$266 per panel

*34" high - 50" high available up to 72" wide, 66" high available up to 60" wide, 82" high available up to 48" wide

Code	Price	H	W	D
One 8" clear acrylic segment on top				
L-PEFCA-4224-00E	1218	42	24	2
L-PEFCA-4230-00E	1295	42	30	2
L-PEFCA-4236-00E	1355	42	36	2
L-PEFCA-4242-00E	1408	42	42	2
L-PEFCA-4248-00E	1463	42	48	2
L-PEFCA-4254-00E	1558	42	54	2
L-PEFCA-4260-00E	1591	42	60	2
L-PEFCA-5024-00E	1218	50	24	2
L-PEFCA-5030-00E	1295	50	30	2
L-PEFCA-5036-00E	1355	50	36	2
L-PEFCA-5042-00E	1408	50	42	2
L-PEFCA-5048-00E	1463	50	48	2
L-PEFCA-5054-00E	1558	50	54	2
L-PEFCA-5060-00E	1591	50	60	2
One 16" clear acrylic segment on top				
L-PEFCA-5024-00S	1218	50	24	2
L-PEFCA-5030-00S	1295	50	30	2
L-PEFCA-5036-00S	1355	50	36	2
L-PEFCA-5042-00S	1408	50	42	2
L-PEFCA-5048-00S	1463	50	48	2
L-PEFCA-5054-00S	1558	50	54	2
L-PEFCA-5060-00S	1591	50	60	2
L-PEFCA-6624-00S	1344	66	24	2
L-PEFCA-6630-00S	1446	66	30	2
L-PEFCA-6636-00S	1535	66	36	2
L-PEFCA-6642-00S	1628	66	42	2
L-PEFCA-6648-00S	1701	66	48	2
L-PEFCA-6654-00S	1846	66	54	2
L-PEFCA-6660-00S	1884	66	60	2
L-PEFCA-8224-00S	1743	82	24	2
L-PEFCA-8230-00S	2010	82	30	2
L-PEFCA-8236-00S	2103	82	36	2
L-PEFCA-8242-00S	2144	82	42	2
L-PEFCA-8248-00S	2230	82	48	2
One 24" clear acrylic segment on top				
L-PEFCA-6624-00T	1344	66	24	2
L-PEFCA-6630-00T	1446	66	30	2
L-PEFCA-6636-00T	1535	66	36	2
L-PEFCA-6642-00T	1628	66	42	2
L-PEFCA-6648-00T	1701	66	48	2
L-PEFCA-6654-00T	1846	66	54	2
L-PEFCA-6660-00T	1884	66	60	2

Code	Price	H	W	D
Two 8" clear acrylic segments on top				
L-PEFCA-6624-0EE	1719	66	24	2
L-PEFCA-6630-0EE	1937	66	30	2
L-PEFCA-6636-0EE	2009	66	36	2
L-PEFCA-6642-0EE	2068	66	42	2
L-PEFCA-6648-0EE	2144	66	48	2
L-PEFCA-6654-0EE	2272	66	54	2
L-PEFCA-6660-0EE	2323	66	60	2
One 8" & One 16" clear acrylic segment on top				
L-PEFCA-6624-0ES	1679	66	24	2
L-PEFCA-6630-0ES	1888	66	30	2
L-PEFCA-6636-0ES	1974	66	36	2
L-PEFCA-6642-0ES	2059	66	42	2
L-PEFCA-6648-0ES	2149	66	48	2
L-PEFCA-6654-0ES	2244	66	54	2
L-PEFCA-6660-0ES	2282	66	60	2
Two 16" clear acrylic segments on top				
L-PEFCA-8224-0SS	1791	82	24	2
L-PEFCA-8230-0SS	2073	82	30	2
L-PEFCA-8236-0SS	2211	82	36	2
L-PEFCA-8242-0SS	2262	82	42	2
L-PEFCA-8248-0SS	2344	82	48	2
One 24" & One 16" clear acrylic segment on top				
L-PEFCA-8224-0TS	1780	82	24	2
L-PEFCA-8230-0TS	2033	82	30	2
L-PEFCA-8236-0TS	2103	82	36	2
L-PEFCA-8242-0TS	2156	82	42	2
L-PEFCA-8248-0TS	2370	82	48	2
Two 24" clear acrylic segments on top				
L-PEFCA-8224-0TT	1772	82	24	2
L-PEFCA-8230-0TT	2001	82	30	2
L-PEFCA-8236-0TT	2100	82	36	2
L-PEFCA-8242-0TT	2225	82	42	2
L-PEFCA-8248-0TT	2305	82	48	2
One 8" & Two 16" clear acrylic segments on top				
L-PEFCA-8224-ESS	1854	82	24	2
L-PEFCA-8230-ESS	2192	82	30	2
L-PEFCA-8236-ESS	2273	82	36	2
L-PEFCA-8242-ESS	2267	82	42	2
L-PEFCA-8248-ESS	2475	82	48	2
Three 16" clear acrylic segments on top				
L-PEFCA-8224-SSS	1885	82	24	2
L-PEFCA-8230-SSS	2123	82	30	2
L-PEFCA-8236-SSS	2311	82	36	2
L-PEFCA-8242-SSS	2376	82	42	2
L-PEFCA-8248-SSS	2466	82	48	2

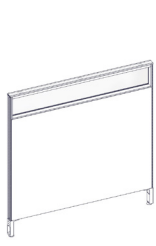

OOE
One 8" frosted acrylic segment on top



OOS
One 16" frosted acrylic segment on top



OOT
One 24" frosted acrylic segment on top

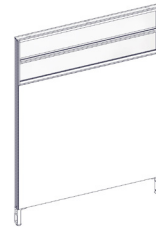

OEE
Two 8" frosted acrylic segments on top



OES
One 8" & One 16" frosted acrylic segment on top



OSS
Two 16" frosted acrylic segments on top



OTS
One 24" & One 16" frosted acrylic segment on top



OTT
Two 24" frosted acrylic segments on top



ESS
One 8" & Two 16" frosted acrylic segments on top



SSS
Three 16" frosted acrylic segments on top

How to order and read your code

L - P E F F A - 42 24 - 0 0 E

product line	standard	P= glazed E = Elevated	F=Fabric L=Laminate	C= Clear F=Frosted	A=Acrylic G=Glass	height	width	0 = No segment E = 8 inch segment S = 16 inch segment T = 24 inch segment
--------------	----------	---------------------------	------------------------	-----------------------	----------------------	--------	-------	--

What's Included:

One (1) 2" thick fabric panel with glazed glass top and laminate bottom, also with 1" incremented slotted channels, One (1) top trim

How to Specify:

Refer to panel fabric cards for fabric selections
Choose White, Black, Silver, Charcoal for Panel Frame colour

Options:

Height*: 34", 42", 50", 66", 82"
Width: 24", 30", 36", 42", 48", 54", 60", 66", 72"

Fabric

Glass/Acrylic

Metal Powder Coat Paint: White, Black, Silver, Charcoal

*34" high - 50" high available up to 72" wide, 66" high available up to 60" wide, 82" high available up to 48" wide

Notes:

Non-power capable panel.
Can be used in run with power-capable panels and allows wires to pass through.
Panels are non tackable. For tackable option see Panel Add-On section.
Fabric Upcharge
Grade 2 - \$216 per panel,
Grade 3 - \$266 per panel

Code	Price	H	W	D
One 8" frosted acrylic segment on top				
L-PEFFA-4224-00E	1334	42	24	2
L-PEFFA-4230-00E	1414	42	30	2
L-PEFFA-4236-00E	1472	42	36	2
L-PEFFA-4242-00E	1524	42	42	2
L-PEFFA-4248-00E	1578	42	48	2
L-PEFFA-4254-00E	1673	42	54	2
L-PEFFA-4260-00E	1707	42	60	2
L-PEFFA-5024-00E	1334	50	24	2
L-PEFFA-5030-00E	1414	50	30	2
L-PEFFA-5036-00E	1472	50	36	2
L-PEFFA-5042-00E	1524	50	42	2
L-PEFFA-5048-00E	1578	50	48	2
L-PEFFA-5054-00E	1673	50	54	2
L-PEFFA-5060-00E	1707	50	60	2
One 16" frosted acrylic segment on top				
L-PEFFA-5024-00S	1334	50	24	2
L-PEFFA-5030-00S	1414	50	30	2
L-PEFFA-5036-00S	1472	50	36	2
L-PEFFA-5042-00S	1524	50	42	2
L-PEFFA-5048-00S	1578	50	48	2
L-PEFFA-5054-00S	1673	50	54	2
L-PEFFA-5060-00S	1707	50	60	2
L-PEFFA-6624-00S	1461	66	24	2
L-PEFFA-6630-00S	1563	66	30	2
L-PEFFA-6636-00S	1650	66	36	2
L-PEFFA-6642-00S	1745	66	42	2
L-PEFFA-6648-00S	1817	66	48	2
L-PEFFA-6654-00S	1963	66	54	2
L-PEFFA-6660-00S	2000	66	60	2
L-PEFFA-8224-00S	1785	82	24	2
L-PEFFA-8230-00S	2064	82	30	2
L-PEFFA-8236-00S	2173	82	36	2
L-PEFFA-8242-00S	2225	82	42	2
L-PEFFA-8248-00S	2312	82	48	2
One 24" frosted acrylic segment on top				
L-PEFFA-6624-00T	1461	66	24	2
L-PEFFA-6630-00T	1563	66	30	2
L-PEFFA-6636-00T	1650	66	36	2
L-PEFFA-6642-00T	1745	66	42	2
L-PEFFA-6648-00T	1817	66	48	2
L-PEFFA-6654-00T	1963	66	54	2
L-PEFFA-6660-00T	2000	66	60	2

Code	Price	H	W	D
Two 8" frosted acrylic segments on top				
L-PEFFA-6624-0EE	1792	66	24	2
L-PEFFA-6630-0EE	2034	66	30	2
L-PEFFA-6636-0EE	2140	66	36	2
L-PEFFA-6642-0EE	2191	66	42	2
L-PEFFA-6648-0EE	2288	66	48	2
L-PEFFA-6654-0EE	2375	66	54	2
L-PEFFA-6660-0EE	2426	66	60	2
One 8" & One 16" frosted acrylic segment on top				
L-PEFFA-6624-0ES	1742	66	24	2
L-PEFFA-6630-0ES	1972	66	30	2
L-PEFFA-6636-0ES	2073	66	36	2
L-PEFFA-6642-0ES	2184	66	42	2
L-PEFFA-6648-0ES	2272	66	48	2
L-PEFFA-6654-0ES	2382	66	54	2
L-PEFFA-6660-0ES	2441	66	60	2
Two 16" frosted acrylic segments on top				
L-PEFFA-8224-0SS	1674	82	24	2
L-PEFFA-8230-0SS	1906	82	30	2
L-PEFFA-8236-0SS	1988	82	36	2
L-PEFFA-8242-0SS	2051	82	48	2
L-PEFFA-8248-0SS	2119	82	48	2
One 24" & One 16" frosted acrylic segment on top				
L-PEFFA-8224-0TS	1902	82	24	2
L-PEFFA-8230-0TS	2196	82	30	2
L-PEFFA-8236-0TS	2268	82	36	2
L-PEFFA-8242-0TS	2361	82	42	2
L-PEFFA-8248-0TS	2615	82	48	2
Two 24" frosted acrylic segments on top				
L-PEFFA-8224-0TT	1900	82	24	2
L-PEFFA-8230-0TT	2167	82	30	2
L-PEFFA-8236-0TT	2296	82	36	2
L-PEFFA-8242-0TT	2470	82	42	2
L-PEFFA-8248-0TT	2551	82	48	2
One 8" & Two 16" frosted acrylic segments on top				
L-PEFFA-8224-ESS	1976	82	24	2
L-PEFFA-8230-ESS	2353	82	30	2
L-PEFFA-8236-ESS	2437	82	36	2
L-PEFFA-8242-ESS	2504	82	42	2
L-PEFFA-8248-ESS	2637	82	48	2
Three 16" frosted acrylic segments on top				
L-PEFFA-8224-SSS	2009	82	24	2
L-PEFFA-8230-SSS	2286	82	30	2
L-PEFFA-8236-SSS	2555	82	36	2
L-PEFFA-8242-SSS	2621	82	36	2
L-PEFFA-8248-SSS	2712	82	48	2



OOE
One 8" clear glass segment on top

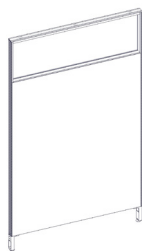

OOS
One 16" clear glass segment on top

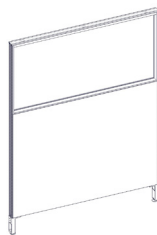

OOT
One 24" clear glass segment on top



OEE
Two 8" clear glass segments on top

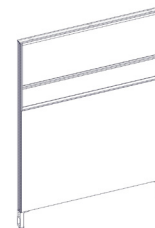

OES
One 8" & One 16" clear glass segment on top



OSS
Two 16" clear glass segments on top



OTS
One 24" & One 16" clear glass segment on top



OTT
Two 24" clear glass segments on top



ESS
One 8" & Two 16" clear glass segments on top



SSS
Three 16" clear glass segments on top

How to order and read your code

L - P E F C G - 42 24 - 0 0 E

product line	standard	P= glazed E = Elevated	F=Fabric L=Laminate	C= Clear F=Frosted	A=Acrylic G=Glass	height	width	0 = No segment E = 8 inch segment S = 16 inch segment T = 24 inch segment
--------------	----------	---------------------------	------------------------	-----------------------	----------------------	--------	-------	--

What's Included:

One (1) 2" thick fabric panel with glazed glass top and laminate bottom, also with 1" incremented slotted channels, One (1) top trim

How to Specify:

Refer to panel fabric cards for fabric selections
Choose White, Black, Silver, Charcoal for Panel Frame colour

Options:

Height*: 34", 42", 50", 66", 82"
Width: 24", 30", 36", 42", 48", 54", 60", 66", 72"

Fabric

Glass/Acrylic

Metal Powder Coat Paint: White, Black, Silver, Charcoal

*34" high - 50" high available up to 72" wide, 66" high available up to 60" wide, 82" high available up to 48" wide

Notes:

Non-power capable panel.
Can be used in run with power-capable panels and allows wires to pass through.
Panels are non tackable. For tackable option see Panel Add-On section.
Fabric Upcharge
Grade 2 - \$216 per panel,
Grade 3 - \$266 per panel

Code	Price	H	W	D
One 8" clear glass segment on top				
L-PEFCG-4224-00E	1434	42	24	2
L-PEFCG-4230-00E	1523	42	30	2
L-PEFCG-4236-00E	1614	42	36	2
L-PEFCG-4242-00E	1703	42	42	2
L-PEFCG-4248-00E	1793	42	48	2
L-PEFCG-4254-00E	1882	42	54	2
L-PEFCG-4260-00E	1972	42	60	2
L-PEFCG-5024-00E	1434	50	24	2
L-PEFCG-5030-00E	1523	50	30	2
L-PEFCG-5036-00E	1614	50	36	2
L-PEFCG-5042-00E	1703	50	42	2
L-PEFCG-5048-00E	1793	50	48	2
L-PEFCG-5054-00E	1882	50	54	2
L-PEFCG-5060-00E	1972	50	60	2
One 16" clear glass segment on top				
L-PEFCG-5024-00S	1434	50	24	2
L-PEFCG-5030-00S	1523	50	30	2
L-PEFCG-5036-00S	1614	50	36	2
L-PEFCG-5042-00S	1703	50	42	2
L-PEFCG-5048-00S	1793	50	48	2
L-PEFCG-5054-00S	1882	50	54	2
L-PEFCG-5060-00S	1972	50	60	2
L-PEFCG-6624-00S	1493	66	24	2
L-PEFCG-6630-00S	1603	66	30	2
L-PEFCG-6636-00S	1719	66	36	2
L-PEFCG-6642-00S	1829	66	42	2
L-PEFCG-6648-00S	1945	66	48	2
L-PEFCG-6654-00S	2055	66	54	2
L-PEFCG-6660-00S	2167	66	60	2
L-PEFCG-8224-00S	1693	82	24	2
L-PEFCG-8230-00S	1991	82	30	2
L-PEFCG-8236-00S	2111	82	36	2
L-PEFCG-8242-00S	2169	82	42	2
L-PEFCG-8248-00S	2281	82	48	2
One 24" clear glass segment on top				
L-PEFCG-6624-00T	1493	66	24	2
L-PEFCG-6630-00T	1603	66	30	2
L-PEFCG-6636-00T	1719	66	36	2
L-PEFCG-6642-00T	1829	66	42	2
L-PEFCG-6648-00T	1945	66	48	2
L-PEFCG-6654-00T	2055	66	54	2
L-PEFCG-6660-00T	2167	66	60	2

Code	Price	H	W	D
Two 8" clear glass segments on top				
L-PEFCG-6624-0EE	1833	66	24	2
L-PEFCG-6630-0EE	2091	66	30	2
L-PEFCG-6636-0EE	2192	66	36	2
L-PEFCG-6642-0EE	2261	66	42	2
L-PEFCG-6648-0EE	2359	66	48	2
L-PEFCG-6654-0EE	2488	66	54	2
L-PEFCG-6660-0EE	2552	66	60	2
One 8" & One 16" clear glass segment on top				
L-PEFCG-6624-0ES	1787	66	24	2
L-PEFCG-6630-0ES	2011	66	30	2
L-PEFCG-6636-0ES	2117	66	36	2
L-PEFCG-6642-0ES	2211	66	42	2
L-PEFCG-6648-0ES	2334	66	48	2
L-PEFCG-6654-0ES	2474	66	54	2
L-PEFCG-6660-0ES	2545	66	60	2
Two 16" clear glass segments on top				
L-PEFCG-8224-0SS	1899	82	24	2
L-PEFCG-8230-0SS	2172	82	30	2
L-PEFCG-8236-0SS	2311	82	36	2
L-PEFCG-8242-0SS	2415	82	42	2
L-PEFCG-8248-0SS	2551	82	48	2
One 24" & One 16" clear glass segment on top				
L-PEFCG-8224-0TS	1884	82	24	2
L-PEFCG-8230-0TS	2140	82	30	2
L-PEFCG-8236-0TS	2270	82	36	2
L-PEFCG-8242-0TS	2388	82	42	2
L-PEFCG-8248-0TS	2542	82	48	2
Two 24" clear glass segments on top				
L-PEFCG-8224-0TT	1918	82	24	2
L-PEFCG-8230-0TT	2163	82	30	2
L-PEFCG-8236-0TT	2285	82	36	2
L-PEFCG-8242-0TT	2411	82	42	2
L-PEFCG-8248-0TT	2559	82	48	2
One 8" & Two 16" clear glass segments on top				
L-PEFCG-8224-ESS	2060	82	24	2
L-PEFCG-8230-ESS	2387	82	30	2
L-PEFCG-8236-ESS	2532	82	36	2
L-PEFCG-8242-ESS	2546	82	42	2
L-PEFCG-8248-ESS	2738	82	48	2
Three 16" clear glass segments on top				
L-PEFCG-8224-SSS	2104	82	24	2
L-PEFCG-8230-SSS	2339	82	30	2
L-PEFCG-8236-SSS	2490	82	36	2
L-PEFCG-8242-SSS	2635	82	42	2
L-PEFCG-8248-SSS	2806	82	48	2



OOE
One 8" frosted glass segment on top

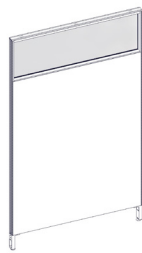

OOS
One 16" frosted glass segment on top



OOT
One 24" frosted glass segment on top



OEE
Two 8" frosted glass segments on top



OES
One 8" & One 16" frosted glass segment on top



OSS
Two 16" frosted glass segments on top



OTS
One 24" & One 16" frosted glass segment on top



OTT
Two 24" frosted glass segments on top



ESS
One 8" & Two 16" frosted glass segments on top



SSS
Three 16" frosted glass segments on top

How to order and read your code

L - P E F F G - 42 24 - 0 0 E

product line	standard	P= glazed E = Elevated	F=Fabric L=Laminate	C= Clear F=Frosted	A=Acrylic G=Glass	height	width	0 = No segment E = 8 inch segment S = 16 inch segment T = 24 inch segment
--------------	----------	---------------------------	------------------------	-----------------------	----------------------	--------	-------	--

What's Included:

One (1) 2" thick fabric panel with glazed glass top and laminate bottom, also with 1" incremented slotted channels, One (1) top trim

How to Specify:

Refer to panel fabric cards for fabric selections
Choose White, Black, Silver, Charcoal for Panel Frame colour

Options:

Height*: 34", 42", 50", 66", 82"
Width: 24", 30", 36", 42", 48", 54", 60", 66", 72"

Fabric

Glass/Acrylic

Metal Powder Coat Paint: White, Black, Silver, Charcoal

*34" high - 50" high available up to 72" wide, 66" high available up to 60" wide, 82" high available up to 48" wide

Notes:

Non-power capable panel.
Can be used in run with power-capable panels and allows wires to pass through.
Panels are non tackable. For tackable option see Panel Add-On section.
Fabric Upcharge
Grade 2 - \$216 per panel,
Grade 3 - \$266 per panel

Code	Price	H	W	D
One 8" frosted glass segment on top				
L-PEFFG-4224-00E	1550	42	24	2
L-PEFFG-4230-00E	1640	42	30	2
L-PEFFG-4236-00E	1730	42	36	2
L-PEFFG-4242-00E	1819	42	42	2
L-PEFFG-4248-00E	1910	42	48	2
L-PEFFG-4254-00E	1999	42	54	2
L-PEFFG-4260-00E	2087	42	60	2
L-PEFFG-5024-00E	1550	50	24	2
L-PEFFG-5030-00E	1640	50	30	2
L-PEFFG-5036-00E	1730	50	36	2
L-PEFFG-5042-00E	1819	50	42	2
L-PEFFG-5048-00E	1910	50	48	2
L-PEFFG-5054-00E	1999	50	54	2
L-PEFFG-5060-00E	2087	50	60	2
One 16" frosted glass segment on top				
L-PEFFG-5024-00S	1550	50	24	2
L-PEFFG-5030-00S	1640	50	30	2
L-PEFFG-5036-00S	1730	50	36	2
L-PEFFG-5042-00S	1819	50	42	2
L-PEFFG-5048-00S	1910	50	48	2
L-PEFFG-5054-00S	1999	50	54	2
L-PEFFG-5060-00S	2087	50	60	2
L-PEFFG-6624-00S	1609	66	24	2
L-PEFFG-6630-00S	1720	66	30	2
L-PEFFG-6636-00S	1834	66	36	2
L-PEFFG-6642-00S	1946	66	42	2
L-PEFFG-6648-00S	2059	66	48	2
L-PEFFG-6654-00S	2171	66	54	2
L-PEFFG-6660-00S	2282	66	60	2
L-PEFFG-8224-00S	1910	82	24	2
L-PEFFG-8230-00S	2218	82	30	2
L-PEFFG-8236-00S	2359	82	36	2
L-PEFFG-8242-00S	2438	82	42	2
L-PEFFG-8248-00S	2573	82	48	2
One 24" frosted glass segment on top				
L-PEFFG-6624-00T	1609	66	24	2
L-PEFFG-6630-00T	1720	66	30	2
L-PEFFG-6636-00T	1834	66	36	2
L-PEFFG-6642-00T	1946	66	42	2
L-PEFFG-6648-00T	2059	66	48	2
L-PEFFG-6654-00T	2171	66	54	2
L-PEFFG-6660-00T	2282	66	60	2

Code	Price	H	W	D
Two 8" frosted glass segments on top				
L-PEFFG-6624-0EE	2031	66	24	2
L-PEFFG-6630-0EE	2288	66	30	2
L-PEFFG-6636-0EE	2388	66	36	2
L-PEFFG-6642-0EE	2460	66	42	2
L-PEFFG-6648-0EE	2556	66	48	2
L-PEFFG-6654-0EE	2687	66	54	2
L-PEFFG-6660-0EE	2771	66	60	2
One 8" & One 16" frosted glass segment on top				
L-PEFFG-6624-0ES	1984	66	24	2
L-PEFFG-6630-0ES	2220	66	30	2
L-PEFFG-6636-0ES	2347	66	36	2
L-PEFFG-6642-0ES	2463	66	42	2
L-PEFFG-6648-0ES	2609	66	48	2
L-PEFFG-6654-0ES	2771	66	54	2
L-PEFFG-6660-0ES	2877	66	60	2
Two 16" frosted glass segments on top				
L-PEFFG-8224-0SS	2096	82	24	2
L-PEFFG-8230-0SS	2393	82	30	2
L-PEFFG-8236-0SS	2573	82	36	2
L-PEFFG-8242-0SS	2726	82	42	2
L-PEFFG-8248-0SS	2904	82	48	2
One 24" & One 16" frosted glass segment on top				
L-PEFFG-8224-0TS	2116	82	24	2
L-PEFFG-8230-0TS	2412	82	30	2
L-PEFFG-8236-0TS	2602	82	36	2
L-PEFFG-8242-0TS	2776	82	42	2
L-PEFFG-8248-0TS	2981	82	48	2
Two 24" frosted glass segments on top				
L-PEFFG-8224-0TT	2183	82	24	2
L-PEFFG-8230-0TT	2495	82	30	2
L-PEFFG-8236-0TT	2684	82	36	2
L-PEFFG-8242-0TT	2872	82	42	2
L-PEFFG-8248-0TT	3091	82	48	2
One 8" & Two 16" frosted glass segments on top				
L-PEFFG-8224-ESS	2359	82	24	2
L-PEFFG-8230-ESS	2709	82	30	2
L-PEFFG-8236-ESS	2895	82	36	2
L-PEFFG-8242-ESS	2955	82	42	2
L-PEFFG-8248-ESS	3192	82	48	2
Three 16" frosted glass segments on top				
L-PEFFG-8224-SSS	2401	82	24	2
L-PEFFG-8230-SSS	2672	82	30	2
L-PEFFG-8236-SSS	2887	82	36	2
L-PEFFG-8242-SSS	3097	82	42	2
L-PEFFG-8248-SSS	3333	82	48	2



OOE
One 8" clear acrylic segment on top

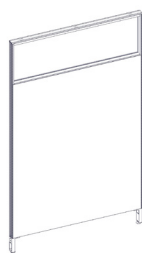

OOS
One 16" clear acrylic segment on top

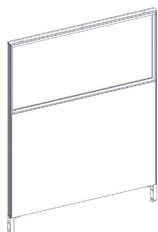

OOT
One 24" clear acrylic segment on top



OEE
Two 8" clear acrylic segments on top

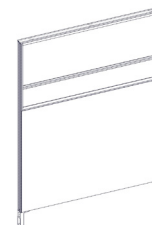

OES
One 8" & One 16" clear acrylic segment on top



OSS
Two 16" clear acrylic segments on top



OTS
One 24" & One 16" clear acrylic segment on top



OTT
Two 24" clear acrylic segments on top



ESS
One 8" & Two 16" clear acrylic segments on top



SSS
Three 16" clear acrylic segments on top

How to order and read your code

L - P E L C A - 42 24 - 0 0 E

product line	standard	P= glazed E = Elevated	F=Fabric L=Laminate	C= Clear F=Frosted	A=Acrylic G=Glass	height	width	0 = No segment E = 8 inch segment S = 16 inch segment T = 24 inch segment
--------------	----------	---------------------------	------------------------	-----------------------	----------------------	--------	-------	--

What's Included:

One (1) 2" thick panel with glazed glass top and laminate bottom,
also 1" incremented slotted channels,
One (1) top trim

How to Specify:

Refer to laminate cards for laminate selections

Choose glass or acrylic

Choose White, Black, Silver, Charcoal for Panel Frame colour

Options:

Height*: 34", 42", 50", 66", 82"

Width: 24", 30", 36", 42", 48",

Laminate

Glass/Acrylic

Metal Powder Coat Paint: White, Black, Silver, Charcoal

*82"H available up to 36"W

Notes:

Non-power capable panel.

Can be used in run with power-capable panels and allows wires to pass through.

Panels are non tackable. For tackable option see Panel Add-On section.

Code	Price	H	W	D
One 8" clear acrylic segment on top				
L-PELCA-4224-00E	1311	42	24	2
L-PELCA-4230-00E	1370	42	30	2
L-PELCA-4236-00E	1433	42	36	2
L-PELCA-4242-00E	1526	42	42	2
L-PELCA-4248-00E	1573	42	48	2
L-PELCA-5024-00E	1352	50	24	2
L-PELCA-5030-00E	1414	50	30	2
L-PELCA-5036-00E	1474	50	36	2
L-PELCA-5042-00E	1599	50	42	2
L-PELCA-5048-00E	1636	50	48	2
One 16" clear acrylic segment on top				
L-PELCA-5024-00S	1364	50	24	2
L-PELCA-5030-00S	1428	50	30	2
L-PELCA-5036-00S	1488	50	36	2
L-PELCA-5042-00S	1630	50	42	2
L-PELCA-5048-00S	1666	50	48	2
L-PELCA-6624-00S	1479	66	24	2
L-PELCA-6630-00S	1566	66	30	2
L-PELCA-6636-00S	1654	66	36	2
L-PELCA-6642-00S	1846	66	42	2
L-PELCA-6648-00S	1893	66	48	2
L-PELCA-8224-00S	1820	82	24	2
L-PELCA-8230-00S	1830	82	30	2
L-PELCA-8236-00S	2431	82	36	2
One 24" clear acrylic segment on top				
L-PELCA-6624-00T	1479	66	24	2
L-PELCA-6630-00T	1586	66	30	2
L-PELCA-6636-00T	1691	66	36	2
L-PELCA-6642-00T	1846	66	42	2
L-PELCA-6648-00T	1937	66	48	2

Code	Price	H	W	D
Two 8" clear acrylic segments on top				
L-PELCA-6624-0EE	1589	66	24	2
L-PELCA-6630-0EE	1596	66	30	2
L-PELCA-6636-0EE	1918	66	36	2
L-PELCA-6642-0EE	1952	66	42	2
L-PELCA-6648-0EE	2005	66	48	2
One 8" & One 16" clear acrylic segment on top				
L-PELCA-6624-0ES	1595	66	24	2
L-PELCA-6630-0ES	1649	66	30	2
L-PELCA-6636-0ES	2000	66	36	2
L-PELCA-6642-0ES	2056	66	42	2
L-PELCA-6648-0ES	2115	66	48	2
Two 16" clear acrylic segments on top				
L-PELCA-8224-0SS	1660	82	24	2
L-PELCA-8230-0SS	1731	82	30	2
L-PELCA-8236-0SS	2119	82	36	2
One 24" & One 16" clear acrylic segment on top				
L-PELCA-8224-0TS	1694	82	24	2
L-PELCA-8230-0TS	1793	82	30	2
L-PELCA-8236-0TS	2129	82	36	2
Two 24" clear acrylic segments on top				
L-PELCA-8224-0TT	1621	82	24	2
L-PELCA-8230-0TT	1706	82	30	2
L-PELCA-8236-0TT	1993	82	36	2
One 8" & Two 16" clear acrylic segments on top				
L-PELCA-8224-ESS	1769	82	24	2
L-PELCA-8230-ESS	1953	82	30	2
L-PELCA-8236-ESS	2300	82	36	2
Three 16" clear acrylic segments on top				
L-PELCA-8224-SSS	1732	82	24	2
L-PELCA-8230-SSS	1828	82	30	2
L-PELCA-8236-SSS	2204	82	36	2



OOE
One 8" frosted acrylic segment on top

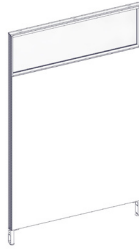

OOS
One 16" frosted acrylic segment on top



OOT
One 24" frosted acrylic segment on top

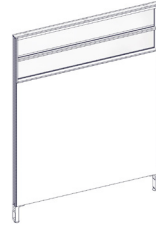

OEE
Two 8" frosted acrylic segments on top



OES
One 8" & One 16" frosted acrylic segment on top



OSS
Two 16" frosted acrylic segments on top



OTS
One 24" & One 16" frosted acrylic segment on top



OTT
Two 24" frosted acrylic segments on top



ESS
One 8" & Two 16" frosted acrylic segments on top



SSS
Three 16" frosted acrylic segments on top

How to order and read your code

L - P E L F A - 42 24 - 0 0 E

product line	standard	P= glazed E = Elevated	F=Fabric L=Laminate	C= Clear F=Frosted	A=Acrylic G=Glass	height	width	0 = No segment E = 8 inch segment S = 16 inch segment T = 24 inch segment
--------------	----------	---------------------------	------------------------	-----------------------	----------------------	--------	-------	--

What's Included:

One (1) 2" thick panel with glazed glass top and laminate bottom,
also 1" incremented slotted channels,
One (1) top trim

How to Specify:

Refer to laminate cards for laminate selections
Choose glass or acrylic
Choose White, Black, Silver, Charcoal for Panel Frame colour

Options:

Height*: 34", 42", 50", 66", 82"

Width: 24", 30", 36", 42", 48",

Laminate

Glass/Acrylic

Metal Powder Coat Paint: White, Black, Silver, Charcoal

*82"H available up to 36"W

Notes:

Non-power capable panel.
Can be used in run with power-capable panels and allows wires to pass through.
Panels are non tackable. For tackable option see Panel Add-On section.

Code	Price	H	W	D
One 8" frosted acrylic segment on top				
L-PELFA-4224-00E	1428	24	42	2
L-PELFA-4230-00E	1487	30	42	2
L-PELFA-4236-00E	1549	36	42	2
L-PELFA-4242-00E	1643	42	42	2
L-PELFA-4248-00E	1690	48	42	2
L-PELFA-5024-00E	1468	24	50	2
L-PELFA-5030-00E	1529	30	50	2
L-PELFA-5036-00E	1590	36	50	2
L-PELFA-5042-00E	1716	42	50	2
L-PELFA-5048-00E	1751	48	50	2
One 16" frosted acrylic segment on top				
L-PELFA-5024-00S	1479	24	50	2
L-PELFA-5030-00S	1543	30	50	2
L-PELFA-5036-00S	1603	36	50	2
L-PELFA-5042-00S	1746	42	50	2
L-PELFA-5048-00S	1782	48	50	2
L-PELFA-6624-00S	1596	24	66	2
L-PELFA-6630-00S	1685	30	66	2
L-PELFA-6636-00S	1770	36	66	2
L-PELFA-6642-00S	1963	42	66	2
L-PELFA-6648-00S	2010	48	66	2
L-PELFA-8224-00S	1862	24	82	2
L-PELFA-8230-00S	1884	30	82	2
L-PELFA-8236-00S	2503	36	82	2
One 24" frosted acrylic segment on top				
L-PELFA-6624-00T	1596	24	66	2
L-PELFA-6630-00T	1701	30	66	2
L-PELFA-6636-00T	1806	36	66	2
L-PELFA-6642-00T	1963	42	66	2
L-PELFA-6648-00T	2054	48	66	2

Code	Price	H	W	D
Two 8" frosted acrylic segments on top				
L-PELFA-6624-0EE	1663	24	66	2
L-PELFA-6630-0EE	1693	30	66	2
L-PELFA-6636-0EE	2047	36	66	2
L-PELFA-6642-0EE	2076	42	66	2
L-PELFA-6648-0EE	2153	48	66	2
One 8" & One 16" frosted acrylic segment on top				
L-PELFA-6624-0ES	1655	24	66	2
L-PELFA-6630-0ES	1732	30	66	2
L-PELFA-6636-0ES	2099	36	66	2
L-PELFA-6642-0ES	2178	42	66	2
L-PELFA-6648-0ES	2236	48	66	2
Two 16" frosted acrylic segments on top				
L-PELFA-8224-0SS	1546	24	82	2
L-PELFA-8230-0SS	1565	30	82	2
L-PELFA-8236-0SS	1901	36	82	2
One 24" & One 16" frosted acrylic segment on top				
L-PELFA-8224-0TS	1817	24	82	2
L-PELFA-8230-0TS	1958	30	82	2
L-PELFA-8236-0TS	2294	36	82	2
Two 24" frosted acrylic segments on top				
L-PELFA-8224-0TT	1745	24	82	2
L-PELFA-8230-0TT	1870	30	82	2
L-PELFA-8236-0TT	2191	36	82	2
One 8" & Two 16" frosted acrylic segments on top				
L-PELFA-8224-ESS	1892	24	82	2
L-PELFA-8230-ESS	2116	30	82	2
L-PELFA-8236-ESS	2463	36	82	2
Three 16" frosted acrylic segments on top				
L-PELFA-8224-SSS	1855	24	82	2
L-PELFA-8230-SSS	1991	30	82	2
L-PELFA-8236-SSS	2451	36	82	2



OOE
One 8" clear glass segment on top



OOS
One 16" clear glass segment on top

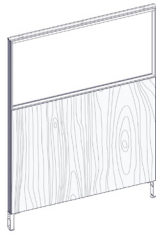

OOT
One 24" clear glass segment on top

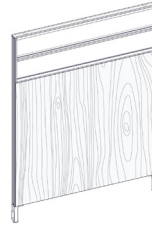

OEE
Two 8" clear glass segments on top



OES
One 8" & One 16" clear glass segment on top



OSS
Two 16" clear glass segments on top



OTS
One 24" & One 16" clear glass segment on top



OTT
Two 24" clear glass segments on top



ESS
One 8" & Two 16" clear glass segments on top



SSS
Three 16" clear glass segments on top

How to order and read your code

L - P E L C G - 42 24 - 0 0 E

product line	standard	P= glazed E = Elevated	F=Fabric L=Laminate	C= Clear F=Frosted	A=Acrylic G=Glass	height	width	O = No segment E = 8 inch segment S = 16 inch segment T = 24 inch segment
--------------	----------	---------------------------	------------------------	-----------------------	----------------------	--------	-------	--

What's Included:

One (1) 2" thick panel with glazed glass top and laminate bottom, also 1" incremented slotted channels, One (1) top trim

How to Specify:

Refer to laminate cards for laminate selections
Choose glass or acrylic
Choose White, Black, Silver, Charcoal for Panel Frame color

Options:

Height*: 34", 42", 50", 66", 82"

Width: 24", 30", 36", 42", 48"

Laminate

Glass/Acrylic

Metal Powder Coat Paint: White, Black, Silver, Charcoal

*82"H available up to 36"W

Notes:

Non-power capable panel.

Can be used in run with power-capable panels and allows wires to pass through.

Panels are non tackable. For tackable option see Panel Add-On section.

Code	Price	H	W	D
One 8" clear glass segment on top				
L-PELCG-4224-00E	1422	42	24	2
L-PELCG-4230-00E	1494	42	30	2
L-PELCG-4236-00E	1564	42	36	2
L-PELCG-4242-00E	1644	42	42	2
L-PELCG-4248-00E	1723	42	48	2
L-PELCG-5024-00E	1465	50	24	2
L-PELCG-5030-00E	1534	50	30	2
L-PELCG-5036-00E	1604	50	36	2
L-PELCG-5042-00E	1686	50	42	2
L-PELCG-5048-00E	1764	50	48	2
One 16" clear glass segment on top				
L-PELCG-5024-00S	1555	50	24	2
L-PELCG-5030-00S	1624	50	30	2
L-PELCG-5036-00S	1693	50	36	2
L-PELCG-5042-00S	1770	50	42	2
L-PELCG-5048-00S	1853	50	48	2
L-PELCG-6624-00S	1688	66	24	2
L-PELCG-6630-00S	1776	66	30	2
L-PELCG-6636-00S	1864	66	36	2
L-PELCG-6642-00S	1972	66	42	2
L-PELCG-6648-00S	2056	66	48	2
L-PELCG-8224-00S	1771	82	24	2
L-PELCG-8230-00S	1812	82	30	2
L-PELCG-8236-00S	2438	82	36	2
One 24" clear glass segment on top				
L-PELCG-6624-00T	1736	66	24	2
L-PELCG-6630-00T	1825	66	30	2
L-PELCG-6636-00T	1913	66	36	2
L-PELCG-6642-00T	2030	66	42	2
L-PELCG-6648-00T	2134	66	48	2

Code	Price	H	W	D
Two 8" clear glass segments on top				
L-PELCG-6624-0EE	1701	66	24	2
L-PELCG-6630-0EE	1749	66	30	2
L-PELCG-6636-0EE	2103	66	36	2
L-PELCG-6642-0EE	2147	66	42	2
L-PELCG-6648-0EE	2220	66	48	2
One 8" & One 16" clear glass segment on top				
L-PELCG-6624-0ES	1701	66	24	2
L-PELCG-6630-0ES	1771	66	30	2
L-PELCG-6636-0ES	2144	66	36	2
L-PELCG-6642-0ES	2207	66	42	2
L-PELCG-6648-0ES	2298	66	48	2
Two 16" clear glass segments on top				
L-PELCG-8224-0SS	1765	82	24	2
L-PELCG-8230-0SS	1831	82	30	2
L-PELCG-8236-0SS	2220	82	36	2
One 24" & One 16" clear glass segment on top				
L-PELCG-8224-0TS	1802	82	24	2
L-PELCG-8230-0TS	1900	82	30	2
L-PELCG-8236-0TS	2297	82	36	2
Two 24" clear glass segments on top				
L-PELCG-8224-0TT	1765	82	24	2
L-PELCG-8230-0TT	1868	82	30	2
L-PELCG-8236-0TT	2180	82	36	2
One 8" & Two 16" clear glass segments on top				
L-PELCG-8224-ESS	1977	82	24	2
L-PELCG-8230-ESS	2149	82	30	2
L-PELCG-8236-ESS	2557	82	36	2
Three 16" clear glass segments on top				
L-PELCG-8224-SSS	1952	82	24	2
L-PELCG-8230-SSS	2044	82	30	2
L-PELCG-8236-SSS	2385	82	36	2



OOE
One 8" frosted glass segment on top



OOS
One 16" frosted glass segment on top



OOT
One 24" frosted glass segment on top



OEE
Two 8" frosted glass segments on top



OES
One 8" & One 16" frosted glass segment on top



OSS
Two 16" frosted glass segments on top



OTS
One 24" & One 16" frosted glass segment on top



OTT
Two 24" frosted glass segments on top



ESS
One 8" & Two 16" frosted glass segments on top



SSS
Three 16" frosted glass segments on top

How to order and read your code

L - P E L F G - 42 24 - 0 0 E

product standard P= glazed F=Fabric C= Clear A=Acrylic height width 0 = No segment
line E = Elevated L=Laminate F=Frosted G=Glass 0 = 8 inch segment
E = 16 inch segment
S = 24 inch segment
T = 24 inch segment

What's Included:

One (1) 2" thick panel with glazed glass top and laminate bottom, also 1" incremented slotted channels, One (1) top trim

How to Specify:

Refer to laminate cards for laminate selections

Choose glass or acrylic

Choose White, Black, Silver, Charcoal for Panel Frame colour

Options:

Height*: 34", 42", 50", 66", 82"

Width: 24", 30", 36", 42", 48",

Laminate

Glass/Acrylic

Metal Powder Coat Paint: White, Black, Silver, Charcoal

*82"H available up to 36"W

Notes:

Non-power capable panel.

Can be used in run with power-capable panels and allows wires to pass through.

Panels are non tackable. For tackable option see Panel Add-On section.

Code	Price	H	W	D
One 8" frosted glass segment on top				
L-PELFG-4224-00E	1540	24	42	2
L-PELFG-4230-00E	1612	30	42	2
L-PELFG-4236-00E	1679	36	42	2
L-PELFG-4242-00E	1760	42	42	2
L-PELFG-4248-00E	1841	48	42	2
L-PELFG-5024-00E	1581	24	50	2
L-PELFG-5030-00E	1649	30	50	2
L-PELFG-5036-00E	1721	36	50	2
L-PELFG-5042-00E	1802	42	50	2
L-PELFG-5048-00E	1879	48	50	2
One 16" frosted glass segment on top				
L-PELFG-5024-00S	1672	24	50	2
L-PELFG-5030-00S	1742	30	50	2
L-PELFG-5036-00S	1810	36	50	2
L-PELFG-5042-00S	1887	42	50	2
L-PELFG-5048-00S	1970	48	50	2
L-PELFG-6624-00S	1804	24	66	2
L-PELFG-6630-00S	1892	30	66	2
L-PELFG-6636-00S	1982	36	66	2
L-PELFG-6642-00S	2087	42	66	2
L-PELFG-6648-00S	2172	48	66	2
L-PELFG-8224-00S	1988	24	82	2
L-PELFG-8230-00S	2038	30	82	2
L-PELFG-8236-00S	2687	36	82	2
One 24" frosted glass segment on top				
L-PELFG-6624-00T	1853	24	66	2
L-PELFG-6630-00T	1940	30	66	2
L-PELFG-6636-00T	2028	36	66	2
L-PELFG-6642-00T	2146	42	66	2
L-PELFG-6648-00T	2251	48	66	2

Code	Price	H	W	D
Two 8" frosted glass segments on top				
L-PELFG-6624-0EE	1901	24	66	2
L-PELFG-6630-0EE	1948	30	66	2
L-PELFG-6636-0EE	2302	36	66	2
L-PELFG-6642-0EE	2346	42	66	2
L-PELFG-6648-0EE	2419	48	66	2
One 8" & One 16" frosted glass segment on top				
L-PELFG-6624-0ES	1901	24	66	2
L-PELFG-6630-0ES	1983	30	66	2
L-PELFG-6636-0ES	2375	36	66	2
L-PELFG-6642-0ES	2460	42	66	2
L-PELFG-6648-0ES	2573	48	66	2
Two 16" frosted glass segments on top				
L-PELFG-8224-0SS	1963	24	82	2
L-PELFG-8230-0SS	2051	30	82	2
L-PELFG-8236-0SS	2486	36	82	2
One 24" & One 16" frosted glass segment on top				
L-PELFG-8224-0TS	2031	24	82	2
L-PELFG-8230-0TS	2172	30	82	2
L-PELFG-8236-0TS	2627	36	82	2
Two 24" frosted glass segments on top				
L-PELFG-8224-0TT	2028	24	82	2
L-PELFG-8230-0TT	2197	30	82	2
L-PELFG-8236-0TT	2578	36	82	2
One 8" & Two 16" frosted glass segments on top				
L-PELFG-8224-ESS	2274	24	82	2
L-PELFG-8230-ESS	2469	30	82	2
L-PELFG-8236-ESS	2924	36	82	2
Three 16" frosted glass segments on top				
L-PELFG-8224-SSS	2248	24	82	2
L-PELFG-8230-SSS	2376	30	82	2
L-PELFG-8236-SSS	2783	36	82	2

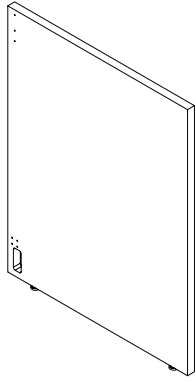

Single Span Middle
Horizontal Woodgrain
Gallery Panel

What's Included:

One (1) 1" thick laminate gallery panel, two (2) gallery panel top brackets

How to Specify:

Refer to laminate cards for laminate selections

Notes:

Gallery panels come with pre-drilled holes on each side and bottom notch for wire routing

Gallery panels must be used between two standard fabric or laminate panels

Gallery panels must be the same height or lower than the connecting standard fabric or laminate panel

Options:

Height: 34", 42", 50"

Width: 26", 32", 38", 44", 50", 56", 62", 68", 74"

Laminate color

Code	Price	H	W	D	Weight (lb.)	Volume (ft ³)
L-PYHM-3426-S1	329	34	26	2		
L-PYHM-3432-S1	363	34	32	2		
L-PYHM-3438-S1	399	34	38	2		
L-PYHM-3444-S1	428	34	44	2		
L-PYHM-3450-S1	465	34	50	2		
L-PYHM-3456-S1	499	34	50	2		
L-PYHM-3462-S1	531	34	62	2		
L-PYHM-3468-S1	565	34	68	2		
L-PYHM-3474-S1	597	34	74	2		
L-PYHM-4226-S1	363	42	26	2		
L-PYHM-4232-S1	407	42	32	2		
L-PYHM-4238-S1	448	42	38	2		
L-PYHM-4244-S1	491	42	44	2		
L-PYHM-4250-S1	530	42	50	2		
L-PYHM-4256-S1	568	42	50	2		
L-PYHM-4262-S1	611	42	62	2		
L-PYHM-4268-S1	651	42	68	2		
L-PYHM-4274-S1	694	42	74	2		
L-PYHM-5026-S1	401	50	26	2		
L-PYHM-5032-S1	451	50	32	2		
L-PYHM-5038-S1	498	50	38	2		
L-PYHM-5044-S1	545	50	44	2		
L-PYHM-5050-S1	593	50	50	2		
L-PYHM-5056-S1	641	50	50	2		
L-PYHM-5062-S1	692	50	62	2		
L-PYHM-5068-S1	737	50	68	2		
L-PYHM-5074-S1	788	50	74	2		

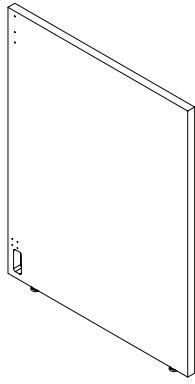

Double Span Middle
Horizontal Woodgrain
Gallery Panel

What's Included:

X"-X": One (1) 1"thick laminate gallery panel, two (2) gallery panel top brackets

X"-X": Two (2) 1"thick laminate gallery panel, four (4) gallery panel top brackets

How to Specify:

Refer to laminate cards for laminate selections

Notes:

Gallery panels come with pre-drilled holes on each side and bottom notch for wire routing

Gallery panels must be used between two standard fabric or laminate panels

Gallery panels must be the same height or lower than the connecting standard fabric or laminate panel

Options:

Height: 34", 42", 50"

Width: 26", 32", 38", 44", 50", 56", 62", 68", 74"

Laminate color

Code	Price	H	W	D	Weight (lb.)	Volume (ft ³)
1 Piece						
L-PYHM-3442-D1	421	34	42	2		
L-PYHM-3450-D1	465	34	50	2		
L-PYHM-3462-D1	531	34	62	2		
L-PYHM-3474-D1	597	34	74	2		
L-PYHM-3486-D1	666	34	86	2		
L-PYHM-4242-D1	473	42	42	2		
L-PYHM-4250-D1	530	42	50	2		
L-PYHM-4262-D1	611	42	62	2		
L-PYHM-4274-D1	694	42	74	2		
L-PYHM-4286-D1	776	42	86	2		
L-PYHM-5042-D1	530	50	42	2		
L-PYHM-5050-D1	593	50	50	2		
L-PYHM-5062-D1	692	50	62	2		
L-PYHM-5074-D1	788	50	74	2		
L-PYHM-5086-D1	883	50	86	2		
2 Pieces						
L-PYHM-3498-D2	857	34	98	2		
L-PYHM-4298-D2	981	42	98	2		
L-PYHM-5098-D2	1107	50	98	2		
L-PYHM-34110-D2	927	34	110	2		
L-PYHM-34122-D2	992	34	122	2		
L-PYHM-34134-D2	1056	34	134	2		
L-PYHM-34146-D2	1124	34	146	2		
L-PYHM-42110-D2	1063	42	110	2		
L-PYHM-42122-D2	1147	42	122	2		
L-PYHM-42134-D2	1230	42	134	2		
L-PYHM-42146-D2	1315	42	146	2		
L-PYHM-50110-D2	1206	50	110	2		
L-PYHM-50122-D2	1300	50	122	2		
L-PYHM-50134-D2	1402	50	134	2		
L-PYHM-50146-D2	1495	50	146	2		



Single Span End Horizontal
Woodgrain Gallery Panel
No Power Cutout

What's Included:

One (1) 1" thick laminate gallery panel, two (2) gallery panel top brackets

How to Specify:

Refer to laminate cards for laminate selections

Choose option for power cut out or no power cut out

Notes:

Gallery panels come with pre-drilled holes on each side and bottom notch for wire routing

Gallery panels must be used between two standard fabric or laminate panels

Gallery panels must be the same height or lower than the connecting standard fabric or laminate panel

Options:

Height: 34", 42", 50"

Width: 26", 32", 38", 44", 50", 56", 62", 68", 74"

Laminate color

Power cut out

Code	Price	H	W	D	Weight (lb.)	Volume (ft ³)
left hand						
L-PYHE-3426-S1L	283	34	26	2		
L-PYHE-3432-S1L	317	34	32	2		
L-PYHE-3438-S1L	351	34	38	2		
L-PYHE-3444-S1L	384	34	44	2		
L-PYHE-3450-S1L	415	34	50	2		
L-PYHE-3456-S1L	452	34	56	2		
L-PYHE-3462-S1L	484	34	62	2		
L-PYHE-3468-S1L	520	34	68	2		
L-PYHE-3474-S1L	552	34	74	2		
L-PYHE-4226-S1L	317	42	26	2		
L-PYHE-4232-S1L	359	42	32	2		
L-PYHE-4238-S1L	400	42	38	2		
L-PYHE-4244-S1L	441	42	44	2		
L-PYHE-4250-S1L	481	42	50	2		
L-PYHE-4256-S1L	523	42	56	2		

Code	Price	H	W	D	Weight (lb.)	Volume (ft ³)
L-PYHE-4262-S1L	564	42	62	2		
L-PYHE-4268-S1L	604	42	68	2		
L-PYHE-4274-S1L	643	42	74	2		
L-PYHE-5026-S1L	353	50	26	2		
L-PYHE-5032-S1L	401	50	32	2		
L-PYHE-5038-S1L	451	50	38	2		
L-PYHE-5044-S1L	499	50	44	2		
L-PYHE-5050-S1L	545	50	50	2		
L-PYHE-5056-S1L	594	50	56	2		
L-PYHE-5062-S1L	641	50	62	2		
L-PYHE-5068-S1L	692	50	68	2		
L-PYHE-5074-S1L	738	50	74	2		
right hand						
L-PYHE-3426-S1R	283	34	26	2		
L-PYHE-3432-S1R	317	34	32	2		
L-PYHE-3438-S1R	351	34	38	2		
L-PYHE-3444-S1R	384	34	44	2		
L-PYHE-3450-S1R	415	34	50	2		
L-PYHE-3456-S1R	452	34	56	2		
L-PYHE-3462-S1R	484	34	62	2		
L-PYHE-3468-S1R	520	34	68	2		
L-PYHE-3474-S1R	552	34	74	2		
L-PYHE-4226-S1R	317	42	26	2		
L-PYHE-4232-S1R	359	42	32	2		
L-PYHE-4238-S1R	400	42	38	2		
L-PYHE-4244-S1R	441	42	44	2		
L-PYHE-4250-S1R	481	42	50	2		
L-PYHE-4256-S1R	523	42	56	2		
L-PYHE-4262-S1R	564	42	62	2		
L-PYHE-4268-S1R	604	42	68	2		
L-PYHE-4274-S1R	643	42	74	2		
L-PYHE-5026-S1R	353	50	26	2		
L-PYHE-5032-S1R	401	50	32	2		
L-PYHE-5038-S1R	451	50	38	2		
L-PYHE-5044-S1R	499	50	44	2		
L-PYHE-5050-S1R	545	50	50	2		
L-PYHE-5056-S1R	594	50	56	2		
L-PYHE-5062-S1R	641	50	62	2		
L-PYHE-5068-S1R	692	50	68	2		
L-PYHE-5074-S1R	738	50	74	2		



Single Span End Horizontal Woodgrain Gallery Panel with Power Cutout

What's Included:

One (1) 1" thick laminate gallery panel, two (2) gallery panel top brackets

How to Specify:

Refer to laminate cards for laminate selections

Choose option for power cut out or no power cut out

Notes:

Gallery panels come with pre-drilled holes on each side and bottom notch for wire routing

Gallery panels must be used between two standard fabric or laminate panels

Gallery panels must be the same height or lower than the connecting standard fabric or laminate panel

Options:

Height: 34", 42", 50"

Width: 26", 32", 38", 44", 50", 56", 62", 68", 74"

Laminate color

No power cut out

Code	Price	H	W	D	Weight (lb.)	Volume (ft ³)
left hand						
L-PCHE-3426-S1L	283	34	26	1		
L-PCHE-3432-S1L	317	34	32	1		
L-PCHE-3438-S1L	351	34	38	1		
L-PCHE-3444-S1L	384	34	44	1		
L-PCHE-3450-S1L	415	34	50	1		
L-PCHE-3456-S1L	452	34	56	1		
L-PCHE-3462-S1L	484	34	62	1		
L-PCHE-3468-S1L	520	34	68	1		
L-PCHE-3474-S1L	552	34	74	1		
L-PCHE-4226-S1L	317	42	26	1		
L-PCHE-4232-S1L	359	42	32	1		
L-PCHE-4238-S1L	400	42	38	1		
L-PCHE-4244-S1L	441	42	44	1		
L-PCHE-4250-S1L	481	42	50	1		
L-PCHE-4256-S1L	523	42	56	1		

Code	Price	H	W	D	Weight (lb.)	Volume (ft ³)
L-PCHE-4262-S1L	564	42	62	1		
L-PCHE-4268-S1L	604	42	68	1		
L-PCHE-4274-S1L	643	42	74	1		
L-PCHE-5026-S1L	353	50	26	1		
L-PCHE-5032-S1L	401	50	32	1		
L-PCHE-5038-S1L	451	50	38	1		
L-PCHE-5044-S1L	499	50	44	1		
L-PCHE-5050-S1L	545	50	50	1		
L-PCHE-5056-S1L	594	50	56	1		
L-PCHE-5062-S1L	641	50	62	1		
L-PCHE-5068-S1L	692	50	68	1		
L-PCHE-5074-S1L	738	50	74	1		
right hand						
L-PCHE-3426-S1R	283	34	26	1		
L-PCHE-3432-S1R	317	34	32	1		
L-PCHE-3438-S1R	351	34	38	1		
L-PCHE-3444-S1R	384	34	44	1		
L-PCHE-3450-S1R	415	34	50	1		
L-PCHE-3456-S1R	452	34	56	1		
L-PCHE-3462-S1R	484	34	62	1		
L-PCHE-3468-S1R	520	34	68	1		
L-PCHE-3474-S1R	552	34	74	1		
L-PCHE-4226-S1R	317	42	26	1		
L-PCHE-4232-S1R	359	42	32	1		
L-PCHE-4238-S1R	400	42	38	1		
L-PCHE-4244-S1R	441	42	44	1		
L-PCHE-4250-S1R	481	42	50	1		
L-PCHE-4256-S1R	523	42	56	1		
L-PCHE-4262-S1R	564	42	62	1		
L-PCHE-4268-S1R	604	42	68	1		
L-PCHE-4274-S1R	643	42	74	1		
L-PCHE-5026-S1R	353	50	26	1		
L-PCHE-5032-S1R	401	50	32	1		
L-PCHE-5038-S1R	451	50	38	1		
L-PCHE-5044-S1R	499	50	44	1		
L-PCHE-5050-S1R	545	50	50	1		
L-PCHE-5056-S1R	594	50	56	1		
L-PCHE-5062-S1R	641	50	62	1		
L-PCHE-5068-S1R	692	50	68	1		
L-PCHE-5074-S1R	738	50	74	1		



Single piece
Double Span End
Horizontal Woodgrain
Gallery Panel
No Power Cutout



Two pieces
Double Span End
Horizontal Woodgrain
Gallery Panel
No Power Cutout

What's Included:

X"-X": One (1) 1"thick laminate gallery panel, two (2) gallery panel top brackets

X"-X": Two (2) 1"thick laminate gallery panel, four (4) gallery panel top brackets

How to Specify:

Refer to laminate cards for laminate selections
Choose option for power cut out or no power cut out

Notes:

Gallery panels come with pre-drilled holes on each side and bottom notch for wire routing

Gallery panels must be used between two standard fabric or laminate panels

Gallery panels must be the same height or lower than the connecting standard fabric or laminate panel

Options:

Height: 34", 42", 50"

Width: 26", 32", 38", 44", 50", 56", 62", 68", 74"

Laminate color

Power cut out

Code	Price	H	W	D	Weight (lb.)	Volume (ft ³)
single piece						
L-PYHE-3442-D1	373	34	42	2		
L-PYHE-3450-D1	415	34	50	2		
L-PYHE-3462-D1	484	34	62	2		
L-PYHE-3474-D1	552	34	74	2		
L-PYHE-3486-D1	621	34	86	2		
L-PYHE-4242-D1	426	42	42	2		
L-PYHE-4250-D1	481	42	50	2		
L-PYHE-4262-D1	564	42	62	2		
L-PYHE-4274-D1	643	42	74	2		
L-PYHE-4286-D1	730	42	86	2		
L-PYHE-5042-D1	481	50	42	2		
L-PYHE-5050-D1	545	50	50	2		
L-PYHE-5062-D1	641	50	62	2		
L-PYHE-5074-D1	738	50	74	2		
L-PYHE-5086-D1	836	50	86	2		
2 pieces						
L-PYHE-3498-D2	857	34	98	2		
L-PYHE-4298-D2	981	42	98	2		
L-PYHE-5098-D2	1107	50	98	2		
L-PYHE-34110-D2	927	34	110	2		
L-PYHE-34122-D2	992	34	122	2		
L-PYHE-34134-D2	1056	34	134	2		
L-PYHE-34146-D2	1124	34	146	2		
L-PYHE-42110-D2	1063	42	110	2		
L-PYHE-42122-D2	1147	42	122	2		
L-PYHE-42134-D2	1230	42	134	2		
L-PYHE-42146-D2	1315	42	146	2		
L-PYHE-50110-D2	1206	50	110	2		
L-PYHE-50122-D2	1300	50	122	2		
L-PYHE-50134-D2	1402	50	134	2		
L-PYHE-50146-D2	1495	50	146	2		



Single piece

Double Span End
Horizontal Woodgrain Gallery
Panel with Power Cutout



2 pieces

What's Included:

X"-X": One (1) 1"thick laminate gallery panel, two (2) gallery panel top brackets

X"-X": Two (2) 1"thick laminate gallery panel, four (4) gallery panel top brackets

How to Specify:

Refer to laminate cards for laminate selections
Choose option for power cut out or no power cut out

Notes:

Gallery panels come with pre-drilled holes on each side and bottom notch for wire routing

Gallery panels must be used between two standard fabric or laminate panels

Gallery panels must be the same height or lower than the connecting standard fabric or laminate panel

Options:

Height: 34", 42", 50"

Width: 26", 32", 38", 44", 50", 56", 62", 68", 74"

Laminate color

No power cut out

Code	Price	H	W	D	Weight (lb.)	Volume (ft ³)
single piece						
L-PCHE-3442-D1	373	34	42	1		
L-PCHE-3450-D1	415	34	50	1		
L-PCHE-3462-D1	484	34	62	1		
L-PCHE-3474-D1	552	34	74	1		
L-PCHE-3486-D1	621	34	86	1		
L-PCHE-4242-D1	426	42	42	1		
L-PCHE-4250-D1	481	42	50	1		
L-PCHE-4262-D1	564	42	62	1		
L-PCHE-4274-D1	643	42	74	1		
L-PCHE-4286-D1	730	42	86	1		
L-PCHE-5042-D1	481	50	42	1		
L-PCHE-5050-D1	545	50	50	1		
L-PCHE-5062-D1	641	50	62	1		
L-PCHE-5074-D1	738	50	74	1		
L-PCHE-5086-D1	836	50	86	1		
2 pieces						
L-PCHE-3498-D2	857	34	98	1		
L-PCHE-34110-D2	927	34	110	1		
L-PCHE-34122-D2	992	34	122	1		
L-PCHE-34134-D2	1056	34	134	1		
L-PCHE-34146-D2	1124	34	146	1		
L-PCHE-4298-D2	981	42	98	1		
L-PCHE-42110-D2	1063	42	110	1		
L-PCHE-42122-D2	1147	42	122	1		
L-PCHE-42134-D2	1230	42	134	1		
L-PCHE-42146-D2	1315	42	146	1		
L-PCHE-5098-D2	1107	50	98	1		
L-PCHE-50110-D2	1206	50	110	1		
L-PCHE-50122-D2	1300	50	122	1		
L-PCHE-50134-D2	1402	50	134	1		
L-PCHE-50146-D2	1495	50	146	1		

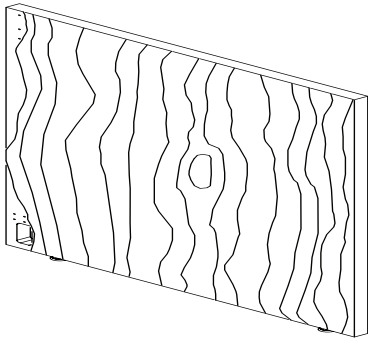

Single Span Middle
Vertical Woodgrain
Gallery Panel

What's Included:

One (1) 1" thick laminate gallery panel,
two (2) gallery panel top brackets

How to Specify:

Refer to laminate cards for laminate selections

Notes:

Gallery panels come with pre-drilled holes on each side and bottom notch for wire routing

Gallery panels must be used between two standard fabric or laminate panels

Gallery panels must be the same height or lower than the connecting standard fabric or laminate panel

Options:

Height: 34", 42", 50"

Width: 26", 32", 38", 44", 50", 56", 62", 68", 74"

Laminate color

Code	Price	H	W	D	Weight (lb.)	Volume (ft ³)
L-PYGM-3426-S1	329	34	26	1	17.68	0.51
L-PYGM-3432-S1	363	34	32	1	21.76	0.63
L-PYGM-3438-S1	399	34	38	1	25.84	0.75
L-PYGM-3444-S1	428	34	44	1	29.92	0.87
L-PYGM-3450-S1	465	34	50	1	34.00	0.98
L-PYGM-3456-S1	499	34	56	1	38.08	1.10
L-PYGM-4226-S1	363	42	26	1	21.84	0.63
L-PYGM-4232-S1	407	42	32	1	26.88	0.78
L-PYGM-4238-S1	448	42	38	1	31.92	0.92
L-PYGM-4244-S1	491	42	44	1	36.96	1.07
L-PYGM-4250-S1	530	42	50	1	42.00	1.22
L-PYGM-4256-S1	568	42	56	1	47.04	1.36
L-PYGM-5026-S1	401	50	26	1	26.00	0.75
L-PYGM-5032-S1	451	50	32	1	32.00	0.93
L-PYGM-5038-S1	498	50	38	1	38.00	1.10
L-PYGM-5044-S1	545	50	44	1	44.00	1.27
L-PYGM-5050-S1	593	50	50	1	50.00	1.45
L-PYGM-5056-S1	641	50	56	1	56.00	1.62

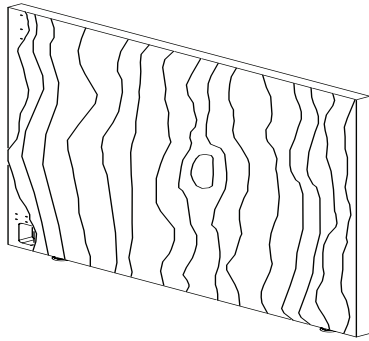

Double Span Middle
Vertical Woodgrain
Gallery Panel

What's Included:

X"-X": One (1) 1"thick laminate gallery panel, two (2) gallery panel top brackets

X"-X": Two (2) 1"thick laminate gallery panel, four (4) gallery panel top brackets

How to Specify:

Refer to laminate cards for laminate selections

Notes:

Gallery panels come with pre-drilled holes on each side and bottom notch for wire routing

Gallery panels must be used between two standard fabric or laminate panels

Gallery panels must be the same height or lower than the connecting standard fabric or laminate panel

Options:

Height: 34", 42", 50"

Width: 26", 32", 38", 44", 50", 56", 62", 68", 74"

Laminate color

Code	Price	H	W	D	Weight (lb.)	Volume (ft ³)
single piece						
L-PYGM-3442-D1	421	34	42	1	28.56	0.83
L-PYGM-3450-D1	465	34	50	1	34.00	0.98
L-PYGM-4242-D1	473	42	42	1	28.56	1.02
L-PYGM-4250-D1	530	42	50	1	42.00	1.22
L-PYGM-5042-D1	530	50	42	1	28.56	1.22
L-PYGM-5050-D1	593	50	50	1	50.00	1.45
2 pieces						
L-PYGM-3462-D2	654	34	62	1	42.16	1.22
L-PYGM-3474-D2	720	34	74	1	50.32	1.46
L-PYGM-3486-D2	789	34	86	1	58.48	1.69
L-PYGM-3498-D2	857	34	98	1	66.64	1.93
L-PYGM-4262-D2	737	42	62	1	52.08	1.51
L-PYGM-4274-D2	818	42	74	1	62.16	1.80
L-PYGM-4286-D2	900	42	86	1	72.24	2.09
L-PYGM-4298-D2	981	42	98	1	82.32	2.38
L-PYGM-5062-D2	820	50	62	1	62.00	1.79
L-PYGM-5074-D2	916	50	74	1	74.00	2.14
L-PYGM-5086-D2	1014	50	86	1	86.00	2.49
L-PYGM-5098-D2	1107	50	98	1	98.00	2.84
L-PYGM-34110-D2	927	34	110	1	74.80	2.16
L-PYGM-42110-D2	1063	42	110	1	92.40	2.67
L-PYGM-50110-D2	1206	50	110	1	110.00	3.18

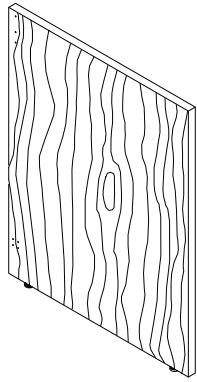

Single Span End
Vertical Woodgrain
Gallery Panel
No Power Cutout

What's Included:

One (1) 1"thick laminate gallery panel,
two (2) gallery panel top brackets

How to Specify:

Refer to laminate cards for laminate selections

Choose option for power cut out or no power cut out

Notes:

Gallery panels come with pre-drilled holes on each side and bottom notch for wire routing

Gallery panels must be used between two standard fabric or laminate panels

Gallery panels must be the same height or lower than the connecting standard fabric or laminate panel

Options:

Height: 34", 42", 50"

Width: 26", 32", 38", 44", 50", 56", 62", 68", 74"

Laminate color

Power cut out, No power cut out

Code	Price	H	W	D	Weight (lb.)	Volume (ft ³)
left hand						
L-PYGE-3426-S1L	283	34	26	1	17.68	0.51
L-PYGE-3432-S1L	317	34	32	1	21.76	0.63
L-PYGE-3438-S1L	351	34	38	1	25.84	0.75
L-PYGE-3444-S1L	384	34	44	1	29.92	0.87
L-PYGE-3450-S1L	415	34	50	1	34.00	0.98
L-PYGE-3456-S1L	452	34	56	1	38.08	1.10
L-PYGE-4226-S1L	317	42	26	1	21.84	0.63
L-PYGE-4232-S1L	359	42	32	1	26.88	0.78
L-PYGE-4238-S1L	400	42	38	1	31.92	0.92
L-PYGE-4244-S1L	441	42	44	1	36.96	1.07
L-PYGE-4250-S1L	481	42	50	1	42.00	1.22
L-PYGE-4256-S1L	523	42	56	1	47.04	1.36
L-PYGE-5026-S1L	353	50	26	1	26.00	0.75
L-PYGE-5032-S1L	401	50	32	1	32.00	0.93
L-PYGE-5038-S1L	451	50	38	1	38.00	1.10
L-PYGE-5044-S1L	499	50	44	1	44.00	1.27
L-PYGE-5050-S1L	545	50	50	1	50.00	1.45
L-PYGE-5056-S1L	594	50	56	1	56.00	1.62
right hand						
L-PYGE-3426-S1R	283	34	26	1	17.68	0.51
L-PYGE-3432-S1R	317	34	32	1	21.76	0.63
L-PYGE-3438-S1R	351	34	38	1	25.84	0.75
L-PYGE-3444-S1R	384	34	44	1	29.92	0.87
L-PYGE-3450-S1R	415	34	50	1	34.00	0.98
L-PYGE-3456-S1R	452	34	56	1	38.08	1.10
L-PYGE-4226-S1R	317	42	26	1	21.84	0.63
L-PYGE-4232-S1R	359	42	32	1	26.88	0.78
L-PYGE-4238-S1R	400	42	38	1	31.92	0.92
L-PYGE-4244-S1R	441	42	44	1	36.96	1.07
L-PYGE-4250-S1R	481	42	50	1	42.00	1.22
L-PYGE-4256-S1R	523	42	56	1	47.04	1.36
L-PYGE-5026-S1R	353	50	26	1	26.00	0.75
L-PYGE-5032-S1R	401	50	32	1	32.00	0.93
L-PYGE-5038-S1R	451	50	38	1	38.00	1.10
L-PYGE-5044-S1R	499	50	44	1	44.00	1.27
L-PYGE-5050-S1R	545	50	50	1	50.00	1.45
L-PYGE-5056-S1R	594	50	56	1	56.00	1.62

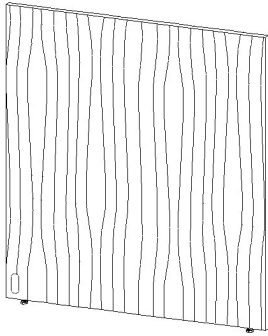

Single Span End
Vertical Woodgrain
Gallery Panel
with Power Cutout

What's Included:

One (1) 1"thick laminate gallery panel,
two (2) gallery panel top brackets

How to Specify:

Refer to laminate cards for laminate selections

Choose option for power cut out or no power cut
out

Notes:

Gallery panels come with pre-drilled holes
on each side and bottom notch for wire
routing

Gallery panels must be used between two
standard fabric or laminate panels

Gallery panels must be the same height or
lower than the connecting standard fabric
or laminate panel

Options:

Height: 34", 42", 50"

Width: 26", 32", 38", 44", 50", 56", 62", 68", 74"

Laminate color

Power cut out, No power cut out

Code	Price	H	W	D	Weight (lb.)	Volume (ft ³)
left hand						
L-PCGE-3426-S1L	283	34	26	1	17.68	0.51
L-PCGE-3432-S1L	317	34	32	1	21.76	0.63
L-PCGE-3438-S1L	351	34	38	1	25.84	0.75
L-PCGE-3444-S1L	384	34	44	1	29.92	0.87
L-PCGE-3450-S1L	415	34	50	1	34.00	0.98
L-PCGE-3456-S1L	452	34	56	1	38.08	1.10
L-PCGE-4226-S1L	317	42	26	1	21.84	0.63
L-PCGE-4232-S1L	359	42	32	1	26.88	0.78
L-PCGE-4238-S1L	400	42	38	1	31.92	0.92
L-PCGE-4244-S1L	441	42	44	1	36.96	1.07
L-PCGE-4250-S1L	481	42	50	1	42.00	1.22
L-PCGE-4256-S1L	523	42	56	1	47.04	1.36
L-PCGE-5026-S1L	353	50	26	1	26.00	0.75
L-PCGE-5032-S1L	401	50	32	1	32.00	0.93
L-PCGE-5038-S1L	451	50	38	1	38.00	1.10
L-PCGE-5044-S1L	499	50	44	1	44.00	1.27
L-PCGE-5050-S1L	545	50	50	1	50.00	1.45
L-PCGE-5056-S1L	594	50	56	1	56.00	1.62
right hand						
L-PCGE-3426-S1R	283	34	26	1	17.68	0.51
L-PCGE-3432-S1R	317	34	32	1	21.76	0.63
L-PCGE-3438-S1R	351	34	38	1	25.84	0.75
L-PCGE-3444-S1R	384	34	44	1	29.92	0.87
L-PCGE-3450-S1R	415	34	50	1	34.00	0.98
L-PCGE-3456-S1R	452	34	56	1	38.08	1.10
L-PCGE-4226-S1R	317	42	26	1	21.84	0.63
L-PCGE-4232-S1R	359	42	32	1	26.88	0.78
L-PCGE-4238-S1R	400	42	38	1	31.92	0.92
L-PCGE-4244-S1R	441	42	44	1	36.96	1.07
L-PCGE-4250-S1R	481	42	50	1	42.00	1.22
L-PCGE-4256-S1R	523	42	56	1	47.04	1.36
L-PCGE-5026-S1R	353	50	26	1	26.00	0.75
L-PCGE-5032-S1R	401	50	32	1	32.00	0.93
L-PCGE-5038-S1R	451	50	38	1	38.00	1.10
L-PCGE-5044-S1R	499	50	44	1	44.00	1.27
L-PCGE-5050-S1R	545	50	50	1	50.00	1.45
L-PCGE-5056-S1R	594	50	56	1	56.00	1.62

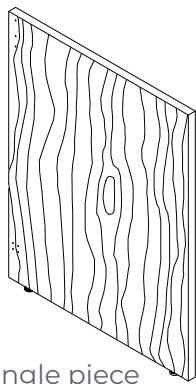

Single piece

Double Span End
Vertical Woodgrain
Gallery Panel
No Power Cutout

What's Included:

X"-X": One (1) 1"thick laminate gallery panel, two (2) gallery panel top brackets

X"-X": Two (2) 1"thick laminate gallery panel, four (4) gallery panel top brackets

How to Specify:

Refer to laminate cards for laminate selections
Choose option for power cut out or no power cut out

Notes:

Gallery panels come with pre-drilled holes on each side and bottom notch for wire routing

Gallery panels must be used between two standard fabric or laminate panels

Gallery panels must be the same height or lower than the connecting standard fabric or laminate panel

Options:

Height: 34", 42", 50"

Width: 26", 32", 38", 44", 50", 56", 62", 68", 74"

Laminate color

Power cut out, no power cut out

Code	Price	H	W	D	Weight (lb.)	Volume (ft ³)
single piece						
L-PYGE-3442-D1	373	34	42	1	28.56	0.83
L-PYGE-3450-D1	415	34	50	1	34.00	0.98
L-PYGE-4242-D1	426	42	42	1	28.56	1.02
L-PYGE-4250-D1	481	42	50	1	42.00	1.22
L-PYGE-5042-D1	481	50	42	1	28.56	1.22
L-PYGE-5050-D1	545	50	50	1	50.00	1.45
2 pieces						
L-PYGE-3462-D2	654	34	62	1	42.16	1.22
L-PYGE-3474-D2	720	34	74	1	50.32	1.46
L-PYGE-3486-D2	789	34	86	1	58.48	1.69
L-PYGE-3498-D2	857	34	98	1	66.64	1.93
L-PYGE-4262-D2	737	42	62	1	52.08	1.51
L-PYGE-4274-D2	818	42	74	1	62.16	1.80
L-PYGE-4286-D2	900	42	86	1	72.24	2.09
L-PYGE-4298-D2	981	42	98	1	82.32	2.38
L-PYGE-5062-D2	820	50	62	1	62.00	1.79
L-PYGE-5074-D2	916	50	74	1	74.00	2.14
L-PYGE-5086-D2	1014	50	86	1	86.00	2.49
L-PYGE-5098-D2	1107	50	98	1	98.00	2.84
L-PYGE-34110-D2	927	34	110	1	74.80	2.16
L-PYGE-42110-D2	1063	42	110	1	92.40	2.67
L-PYGE-50110-D2	1206	50	110	1	110.00	3.18

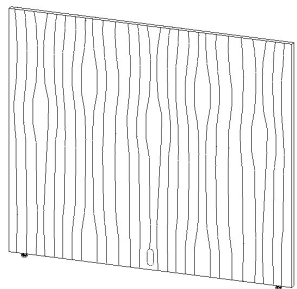

Single piece

Double Span End
Vertical Woodgrain
Gallery Panel
with Power Cutout

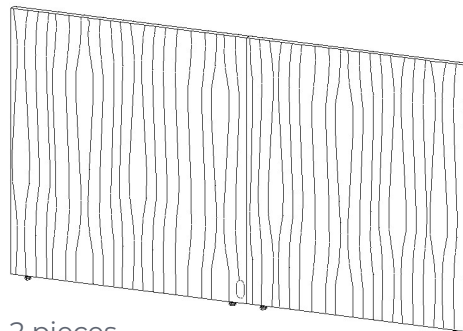

2 pieces

What's Included:

X"-X": One (1) 1"thick laminate gallery panel, two (2) gallery panel top brackets

X"-X": Two (2) 1"thick laminate gallery panel, four (4) gallery panel top brackets

How to Specify:

Refer to laminate cards for laminate selections

Choose option for power cut out or no power cut out

Notes:

Gallery panels come with pre-drilled holes on each side and bottom notch for wire routing

Gallery panels must be used between two standard fabric or laminate panels

Gallery panels must be the same height or lower than the connecting standard fabric or laminate panel

Options:

Height: 34", 42", 50"

Width: 26", 32", 38", 44", 50", 56", 62", 68", 74"

Laminate color

Power cut out, no power cut out

Code	Price	H	W	D	Weight (lb.)	Volume (ft ³)
single piece						
L-PCGE-3442-D1	373	34	42	1	28.56	0.83
L-PCGE-3450-D1	415	34	50	1	34.00	0.98
L-PCGE-4242-D1	426	42	42	1	28.56	1.02
L-PCGE-4250-D1	481	42	50	1	42.00	1.22
L-PCGE-5042-D1	481	50	42	1	28.56	1.22
L-PCGE-5050-D1	545	50	50	1	50.00	1.45
2 pieces						
L-PCGE-3462-D2	654	34	62	1	42.16	1.22
L-PCGE-3474-D2	720	34	74	1	50.32	1.46
L-PCGE-3486-D2	789	34	86	1	58.48	1.69
L-PCGE-3498-D2	857	34	98	1	66.64	1.93
L-PCGE-34110-D2	927	34	110	1	52.08	1.51
L-PCGE-4262-D2	737	42	62	1	62.16	1.80
L-PCGE-4274-D2	818	42	74	1	72.24	2.09
L-PCGE-4286-D2	900	42	86	1	82.32	2.38
L-PCGE-4298-D2	981	42	98	1	62.00	1.79
L-PCGE-42110-D2	1063	42	110	1	74.00	2.14
L-PCGE-5062-D2	820	50	62	1	86.00	2.49
L-PCGE-5074-D2	916	50	74	1	98.00	2.84
L-PCGE-5086-D2	1014	50	86	1	74.80	2.16
L-PCGE-5098-D2	1107	50	98	1	92.40	2.67
L-PCGE-50110-D2	1206	50	110	1	110.00	3.18

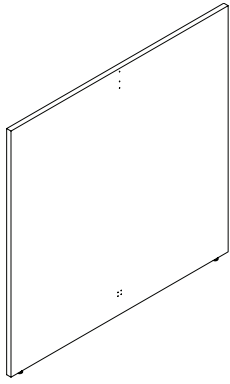

Single Span Middle
Solid Gallery Panel

What's Included:

One (1) 1" thick laminate gallery panel,
two (2) gallery panel top brackets

How to Specify:

Refer to laminate cards for laminate selections

Notes:

Gallery panels come with pre-drilled holes on each side and bottom notch for wire routing

Gallery panels must be used between two standard fabric or laminate panels

Gallery panels must be the same height or lower than the connecting standard fabric or laminate panel

Options:

Height: 34", 42", 50"

Width: 26", 32", 38", 44", 50", 56", 62", 68", 74"

Laminate color

Code	Price	H	W	D	Weight (lb.)	Volume (ft ³)
L-PYSM-3426-S1	329	34	26	1	17.68	0.51
L-PYSM-3432-S1	363	34	32	1	21.76	0.63
L-PYSM-3438-S1	399	34	38	1	25.84	0.75
L-PYSM-3444-S1	428	34	44	1	29.92	0.87
L-PYSM-3450-S1	465	34	50	1	34.00	0.98
L-PYSM-3456-S1	499	34	56	1	38.08	1.10
L-PYSM-3462-S1	531	34	62	1	42.16	1.22
L-PYSM-3468-S1	565	34	68	1	46.24	1.34
L-PYSM-3474-S1	597	34	74	1	50.32	1.46
L-PYSM-4226-S1	363	42	26	1	21.84	0.63
L-PYSM-4232-S1	407	42	32	1	26.88	0.78
L-PYSM-4238-S1	448	42	38	1	31.92	0.92
L-PYSM-4244-S1	491	42	44	1	36.96	1.07
L-PYSM-4250-S1	530	42	50	1	42.00	1.22
L-PYSM-4256-S1	568	42	56	1	47.04	1.36
L-PYSM-4262-S1	611	42	62	1	52.08	1.51
L-PYSM-4268-S1	651	42	68	1	57.12	1.65
L-PYSM-4274-S1	694	42	74	1	62.16	1.80
L-PYSM-5026-S1	401	50	26	1	26.00	0.75
L-PYSM-5032-S1	451	50	32	1	32.00	0.93
L-PYSM-5038-S1	498	50	38	1	38.00	1.10
L-PYSM-5044-S1	545	50	44	1	44.00	1.27
L-PYSM-5050-S1	593	50	50	1	50.00	1.45
L-PYSM-5056-S1	641	50	56	1	56.00	1.62
L-PYSM-5062-S1	692	50	62	1	62.00	1.79
L-PYSM-5068-S1	737	50	68	1	68.00	1.97
L-PYSM-5074-S1	788	50	74	1	74.00	2.14

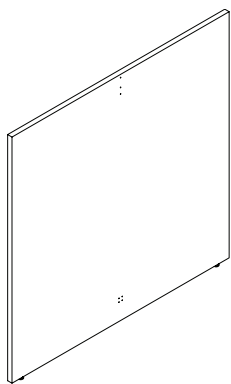

Single piece

Double Span Middle
Solid Gallery Panel

What's Included:

X"-X": One (1) 1"thick laminate gallery panel,
two (2) gallery panel top brackets

X"-X": Two (2) 1"thick laminate gallery panel,
four (4) gallery panel top brackets

How to Specify:

Refer to laminate cards for laminate selections

Notes:

Gallery panels come with pre-drilled holes
on each side and bottom notch for wire
routing

Gallery panels must be used between two
standard fabric or laminate panels

Gallery panels must be the same height or
lower than the connecting standard fabric
or laminate panel

Options:

Height: 34", 42", 50"

Width: 26", 32", 38", 44", 50", 56", 62", 68", 74"

Laminate color

Power cut out, no power cut out

Code	Price	H	W	D	Weight (lb.)	Volume (ft ³)
single piece						
L-PYSM-3442-D1	421	34	42	1	28.56	0.83
L-PYSM-3450-D1	465	34	50	1	34.00	0.98
L-PYSM-3462-D1	531	34	62	1	42.16	1.22
L-PYSM-3474-D1	597	34	74	1	50.32	1.46
L-PYSM-3486-D1	666	34	86	1	58.48	1.69
L-PYSM-4242-D1	473	42	42	1	35.28	1.02
L-PYSM-4250-D1	530	42	50	1	42.00	1.22
L-PYSM-4262-D1	611	42	62	1	52.08	1.51
L-PYSM-4274-D1	694	42	74	1	62.16	1.80
L-PYSM-4286-D1	776	42	86	1	72.24	2.09
L-PYSM-5042-D1	530	50	42	1	42.00	1.22
L-PYSM-5050-D1	593	50	50	1	50.00	1.45
L-PYSM-5062-D1	692	50	62	1	62.00	1.79
L-PYSM-5074-D1	788	50	74	1	74.00	2.14
L-PYSM-5086-D1	883	50	86	1	86.00	2.49
2 pieces						
L-PYSM-3498-D2	857	34	98	1	66.64	1.93
L-PYSM-4298-D2	981	42	98	1	82.32	2.38
L-PYSM-5098-D2	1107	50	98	1	98.00	2.84
L-PYSM-34110-D2	927	34	110	1	74.80	2.16
L-PYSM-34122-D2	992	34	122	1	82.96	2.40
L-PYSM-34134-D2	1056	34	134	1	91.12	2.64
L-PYSM-34146-D2	1124	34	146	1	99.28	2.87
L-PYSM-42110-D2	1063	42	110	1	92.40	2.67
L-PYSM-42122-D2	1147	42	122	1	102.48	2.97
L-PYSM-42134-D2	1230	42	134	1	112.56	3.26
L-PYSM-42146-D2	1315	42	146	1	122.64	3.55
L-PYSM-50110-D2	1206	50	110	1	110.00	3.18
L-PYSM-50122-D2	1300	50	122	1	122.00	3.53
L-PYSM-50134-D2	1402	50	134	1	134.00	3.88
L-PYSM-50146-D2	1495	50	146	1	146.00	4.22

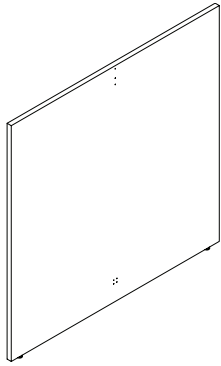

Single Span End
Solid Gallery Panel

What's Included:

One (1) 1"thick laminate gallery panel,
two (2) gallery panel top brackets

How to Specify:

Refer to laminate cards for laminate selections

Choose option for power cut out or no power cut out

Options:

Height: 34", 42", 50"

Width: 26", 32", 38", 44", 50", 56", 62", 68", 74"

Laminate color

Power cut out, No power cut out

Notes:

Gallery panels come with pre-drilled holes on each side and bottom notch for wire routing

Gallery panels must be used between two standard fabric or laminate panels

Gallery panels must be the same height or lower than the connecting standard fabric or laminate panel

Code	Price	H	W	D	Weight (lb.)	Volume (ft ³)
left hand						
L-PYSE-3426-S1L	283	34	26	1	17.68	0.51
L-PYSE-3432-S1L	317	34	32	1	21.76	0.63
L-PYSE-3438-S1L	351	34	38	1	25.84	0.75
L-PYSE-3444-S1L	384	34	44	1	29.92	0.87
L-PYSE-3450-S1L	415	34	50	1	34.00	0.98
L-PYSE-3456-S1L	452	34	56	1	38.08	1.10
L-PYSE-3462-S1L	484	34	62	1	42.16	1.22
L-PYSE-3468-S1L	520	34	68	1	46.24	1.34
L-PYSE-3474-S1L	552	34	74	1	50.32	1.46
L-PYSE-4226-S1L	317	42	26	1	21.84	0.63
L-PYSE-4232-S1L	359	42	32	1	26.88	0.78
L-PYSE-4238-S1L	400	42	38	1	31.92	0.92
L-PYSE-4244-S1L	441	42	44	1	36.96	1.07
L-PYSE-4250-S1L	481	42	50	1	42.00	1.22
L-PYSE-4256-S1L	523	42	56	1	47.04	1.36

Code	Price	H	W	D	Weight (lb.)	Volume (ft ³)
L-PYSE-4262-S1L	564	42	62	1	52.08	1.51
L-PYSE-4268-S1L	604	42	68	1	57.12	1.65
L-PYSE-4274-S1L	643	42	74	1	62.16	1.80
L-PYSE-5026-S1L	353	50	26	1	26.00	0.75
L-PYSE-5032-S1L	401	50	32	1	32.00	0.93
L-PYSE-5038-S1L	451	50	38	1	38.00	1.10
L-PYSE-5044-S1L	499	50	44	1	44.00	1.27
L-PYSE-5050-S1L	545	50	50	1	50.00	1.45
L-PYSE-5056-S1L	594	50	56	1	56.00	1.62
L-PYSE-5062-S1L	641	50	62	1	62.00	1.79
L-PYSE-5068-S1L	692	50	68	1	68.00	1.97
L-PYSE-5074-S1L	738	50	74	1	74.00	2.14
right hand						
L-PYSE-3426-S1R	283	34	26	1	17.68	0.51
L-PYSE-3432-S1R	317	34	32	1	21.76	0.63
L-PYSE-3438-S1R	351	34	38	1	25.84	0.75
L-PYSE-3444-S1R	384	34	44	1	29.92	0.87
L-PYSE-3450-S1R	415	34	50	1	34.00	0.98
L-PYSE-3456-S1R	452	34	56	1	38.08	1.10
L-PYSE-3462-S1R	484	34	62	1	42.16	1.22
L-PYSE-3468-S1R	520	34	68	1	46.24	1.34
L-PYSE-3474-S1R	552	34	74	1	50.32	1.46
L-PYSE-4226-S1R	317	42	26	1	21.84	0.63
L-PYSE-4232-S1R	359	42	32	1	26.88	0.78
L-PYSE-4238-S1R	400	42	38	1	31.92	0.92
L-PYSE-4244-S1R	441	42	44	1	36.96	1.07
L-PYSE-4250-S1R	481	42	50	1	42.00	1.22
L-PYSE-4256-S1R	523	42	56	1	47.04	1.36
L-PYSE-4262-S1R	564	42	62	1	52.08	1.51
L-PYSE-4268-S1R	604	42	68	1	57.12	1.65
L-PYSE-4274-S1R	643	42	74	1	62.16	1.80
L-PYSE-5026-S1R	353	50	26	1	26.00	0.75
L-PYSE-5032-S1R	401	50	32	1	32.00	0.93
L-PYSE-5038-S1R	451	50	38	1	38.00	1.10
L-PYSE-5044-S1R	499	50	44	1	44.00	1.27
L-PYSE-5050-S1R	545	50	50	1	50.00	1.45
L-PYSE-5056-S1R	594	50	56	1	56.00	1.62
L-PYSE-5062-S1R	641	50	62	1	62.00	1.79
L-PYSE-5068-S1R	692	50	68	1	68.00	1.97
L-PYSE-5074-S1R	738	50	74	1	74.00	2.14

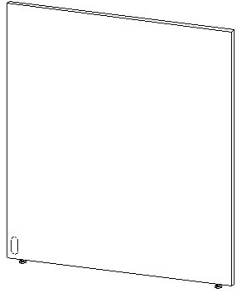

Single Span End
Solid Gallery Panel
with Power Cutout

What's Included:

One (1) 1"thick laminate gallery panel,
two (2) gallery panel top brackets

How to Specify:

Refer to laminate cards for laminate selections
Choose option for power cut out or no power cut out

Options:

- Height: 34", 42", 50"
- Width: 26", 32", 38", 44", 50", 56", 62", 68", 74"
- Laminate color
- Power cut out, No power cut out

Notes:

Gallery panels come with pre-drilled holes on each side and bottom notch for wire routing
Gallery panels must be used between two standard fabric or laminate panels
Gallery panels must be the same height or lower than the connecting standard fabric or laminate panel

Code	Price	H	W	D	Weight (lb.)	Volume (ft ³)
left hand						
L-PCSE-3426-S1L	283	34	26	1	17.68	0.51
L-PCSE-3432-S1L	317	34	32	1	21.76	0.63
L-PCSE-3438-S1L	351	34	38	1	25.84	0.75
L-PCSE-3444-S1L	384	34	44	1	29.92	0.87
L-PCSE-3450-S1L	415	34	50	1	34.00	0.98
L-PCSE-3456-S1L	452	34	56	1	38.08	1.10
L-PCSE-3462-S1L	484	34	62	1	42.16	1.22
L-PCSE-3468-S1L	520	34	68	1	46.24	1.34
L-PCSE-3474-S1L	552	34	74	1	50.32	1.46
L-PCSE-4226-S1L	317	42	26	1	21.84	0.63
L-PCSE-4232-S1L	359	42	32	1	26.88	0.78
L-PCSE-4238-S1L	400	42	38	1	31.92	0.92
L-PCSE-4244-S1L	441	42	44	1	36.96	1.07
L-PCSE-4250-S1L	481	42	50	1	42.00	1.22
L-PCSE-4256-S1L	523	42	56	1	47.04	1.36

Code	Price	H	W	D	Weight (lb.)	Volume (ft ³)
L-PCSE-4262-S1L	564	42	62	1	52.08	1.51
L-PCSE-4268-S1L	604	42	68	1	57.12	1.65
L-PCSE-4274-S1L	643	42	74	1	62.16	1.80
L-PCSE-5026-S1L	353	50	26	1	26.00	0.75
L-PCSE-5032-S1L	401	50	32	1	32.00	0.93
L-PCSE-5038-S1L	451	50	38	1	38.00	1.10
L-PCSE-5044-S1L	499	50	44	1	44.00	1.27
L-PCSE-5050-S1L	545	50	50	1	50.00	1.45
L-PCSE-5056-S1L	594	50	56	1	56.00	1.62
L-PCSE-5062-S1L	641	50	62	1	62.00	1.79
L-PCSE-5068-S1L	692	50	68	1	68.00	1.97
L-PCSE-5074-S1L	738	50	74	1	74.00	2.14
right hand						
L-PCSE-3426-S1R	283	34	26	1	17.68	0.51
L-PCSE-3432-S1R	317	34	32	1	21.76	0.63
L-PCSE-3438-S1R	351	34	38	1	25.84	0.75
L-PCSE-3444-S1R	384	34	44	1	29.92	0.87
L-PCSE-3450-S1R	415	34	50	1	34.00	0.98
L-PCSE-3456-S1R	452	34	56	1	38.08	1.10
L-PCSE-3462-S1R	484	34	62	1	42.16	1.22
L-PCSE-3468-S1R	520	34	68	1	46.24	1.34
L-PCSE-3474-S1R	552	34	74	1	50.32	1.46
L-PCSE-4226-S1R	317	42	26	1	21.84	0.63
L-PCSE-4232-S1R	359	42	32	1	26.88	0.78
L-PCSE-4238-S1R	400	42	38	1	31.92	0.92
L-PCSE-4244-S1R	441	42	44	1	36.96	1.07
L-PCSE-4250-S1R	481	42	50	1	42.00	1.22
L-PCSE-4256-S1R	523	42	56	1	47.04	1.36
L-PCSE-4262-S1R	564	42	62	1	52.08	1.51
L-PCSE-4268-S1R	604	42	68	1	57.12	1.65
L-PCSE-4274-S1R	643	42	74	1	62.16	1.80
L-PCSE-5026-S1R	353	50	26	1	26.00	0.75
L-PCSE-5032-S1R	401	50	32	1	32.00	0.93
L-PCSE-5038-S1R	451	50	38	1	38.00	1.10
L-PCSE-5044-S1R	499	50	44	1	44.00	1.27
L-PCSE-5050-S1R	545	50	50	1	50.00	1.45
L-PCSE-5056-S1R	594	50	56	1	56.00	1.62
L-PCSE-5062-S1R	641	50	62	1	62.00	1.79
L-PCSE-5068-S1R	692	50	68	1	68.00	1.97
L-PCSE-5074-S1R	738	50	74	1	74.00	2.14

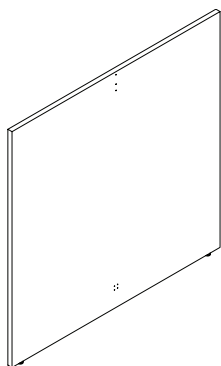

Single piece

Double Span End
Solid Gallery Panel
No Power Cutout

What's Included:

X"-X": One (1) 1"thick laminate gallery panel, two (2) gallery panel top brackets

X"-X": Two (2) 1"thick laminate gallery panel, four (4) gallery panel top brackets

How to Specify:

Refer to laminate cards for laminate selections

Choose option for power cut out or no power cut out

Notes:

Gallery panels come with pre-drilled holes on each side and bottom notch for wire routing

Gallery panels must be used between two standard fabric or laminate panels

Gallery panels must be the same height or lower than the connecting standard fabric or laminate panel

Options:

Height: 34", 42", 50"

Width: 26", 32", 38", 44", 50", 56", 62", 68", 74"

Laminate color

Power cut out, no power cut out

Code	Price	H	W	D	Weight (lb.)	Volume (ft ³)
single piece						
L-PYSE-3442-D1	373	34	42	1	28.56	0.83
L-PYSE-3450-D1	415	34	50	1	34.00	0.98
L-PYSE-3462-D1	484	34	62	1	42.16	1.22
L-PYSE-3474-D1	552	34	74	1	50.32	1.46
L-PYSE-3486-D1	621	34	86	1	58.48	1.69
L-PYSE-4242-D1	426	42	42	1	35.28	1.02
L-PYSE-4250-D1	481	42	50	1	42.00	1.22
L-PYSE-4262-D1	564	42	62	1	52.08	1.51
L-PYSE-4274-D1	643	42	74	1	62.16	1.80
L-PYSE-4286-D1	730	42	86	1	72.24	2.09
L-PYSE-5042-D1	481	50	42	1	42.00	1.22
L-PYSE-5050-D1	545	50	50	1	50.00	1.45
L-PYSE-5062-D1	641	50	62	1	62.00	1.79
L-PYSE-5074-D1	738	50	74	1	74.00	2.14
L-PYSE-5086-D1	836	50	86	1	86.00	2.49
2 pieces						
L-PYSE-3498-D2	857	34	98	1	66.64	1.93
L-PYSE-4298-D2	981	42	98	1	82.32	2.38
L-PYSE-5098-D2	1107	50	98	1	98.00	2.84
L-PYSE-34110-D2	927	34	110	1	74.80	2.16
L-PYSE-34122-D2	992	34	122	1	82.96	2.40
L-PYSE-34134-D2	1056	34	134	1	91.12	2.64
L-PYSE-34146-D2	1124	34	146	1	99.28	2.87
L-PYSE-42110-D2	1063	42	110	1	92.40	2.67
L-PYSE-42122-D2	1147	42	122	1	102.48	2.97
L-PYSE-42134-D2	1230	42	134	1	112.56	3.26
L-PYSE-42146-D2	1315	42	146	1	122.64	3.55
L-PYSE-50110-D2	1206	50	110	1	110.00	3.18
L-PYSE-50122-D2	1300	50	122	1	122.00	3.53
L-PYSE-50134-D2	1402	50	134	1	134.00	3.88
L-PYSE-50146-D2	1495	50	146	1	146.00	4.22

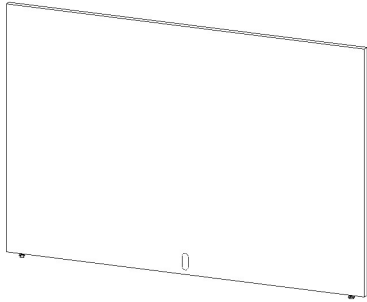

Single piece

Double Span End
Solid Gallery Panel
with Power Cutout

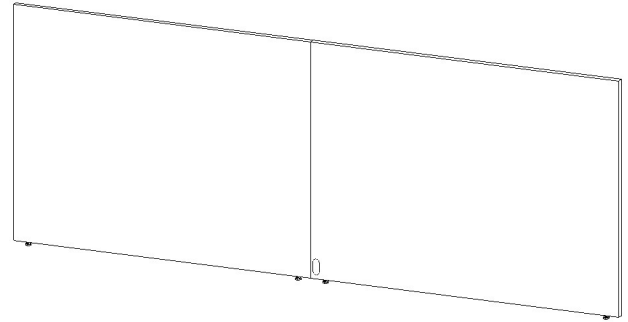

2 pieces

What's Included:

X"-X": One (1) 1"thick laminate gallery panel, two (2) gallery panel top brackets

X"-X": Two (2) 1"thick laminate gallery panel, four (4) gallery panel top brackets

How to Specify:

Refer to laminate cards for laminate selections

Choose option for power cut out or no power cut out

Notes:

Gallery panels come with pre-drilled holes on each side and bottom notch for wire routing

Gallery panels must be used between two standard fabric or laminate panels

Gallery panels must be the same height or lower than the connecting standard fabric or laminate panel

Options:

Height: 34", 42", 50"

Width: 26", 32", 38", 44", 50", 56", 62", 68", 74"

Laminate color

Power cut out, no power cut out

Code	Price	H	W	D	Weight (lb.)	Volume (ft ³)
single piece						
L-PCSE-3442-D1	373	34	42	1	28.60	0.80
L-PCSE-3450-D1	415	34	50	1	34.00	1.00
L-PCSE-3462-D1	484	34	62	1	42.20	1.20
L-PCSE-3474-D1	552	34	74	1	50.30	1.50
L-PCSE-3486-D1	621	34	86	1	58.50	1.70
L-PCSE-4242-D1	426	42	42	1	35.30	1.00
L-PCSE-4250-D1	481	42	50	1	42.00	1.20
L-PCSE-4262-D1	564	42	62	1	52.10	1.50
L-PCSE-4274-D1	643	42	74	1	62.20	1.80
L-PCSE-4286-D1	730	42	86	1	72.20	2.10
L-PCSE-5042-D1	481	50	42	1	42.00	1.20
L-PCSE-5050-D1	545	50	50	1	50.00	1.40
L-PCSE-5062-D1	641	50	62	1	62.00	1.80
L-PCSE-5074-D1	738	50	74	1	74.00	2.10
L-PCSE-5086-D1	836	50	86	1	86.00	2.50
2 pieces						
L-PCSE-3498-D2	857	34	98	1	66.60	1.90
L-PCSE-34110-D2	927	34	110	1	82.30	2.40
L-PCSE-34122-D2	992	34	122	1	98.00	2.80
L-PCSE-34134-D2	1056	34	134	1	74.80	2.20
L-PCSE-34146-D2	1124	34	146	1	83.00	2.40
L-PCSE-4298-D2	981	42	98	1	91.10	2.60
L-PCSE-42110-D2	1063	42	110	1	99.30	2.90
L-PCSE-42122-D2	1147	42	122	1	92.40	2.70
L-PCSE-42134-D2	1230	42	134	1	102.50	3.00
L-PCSE-42146-D2	1315	42	146	1	112.60	3.30
L-PCSE-5098-D2	1107	50	98	1	122.60	3.50
L-PCSE-50110-D2	1206	50	110	1	110.00	3.20
L-PCSE-50122-D2	1300	50	122	1	122.00	3.50
L-PCSE-50134-D2	1402	50	134	1	134.00	3.90
L-PCSE-50146-D2	1495	50	146	1	146.00	4.20

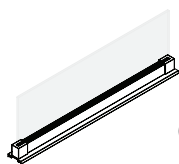

Glass Frameless Blade for Standard and Elevated Panels

Double span panel top mounted privacy screen can be placed across the width of two equal sized panels

What's Included:

One (1) tempered glass piece, One (1) channel extrusion, Two (2) end caps, One (1) top trim

How to Specify:

Refer to metal finish card for metal finish options

Notes:

One (1) glass piece can span the width of one or two panels up to 72"W

Glass is tempered

Options:

Height: 8", 16", 20"

Width: 24", 30", 36", 42", 48", 54", 60", 66", 72"

Clear, Frosted

Code	Price	H	W	D	Weight (lb.)	Volume (ft ³)
Glass screen - Clear						
L-VG-P-0824-C	538	8	24	0.75		
L-VG-P-0830-C	570	8	30	0.75		
L-VG-P-0836-C	623	8	36	0.75		
L-VG-P-0842-C	666	8	42	0.75		
L-VG-P-0848-C	673	8	48	0.75		
L-VG-P-0854-C	726	8	54	0.75		
L-VG-P-0860-C	737	8	60	0.75		
L-VG-P-0866-C	790	8	66	0.75		
L-VG-P-0872-C	798	8	72	0.75		
L-VG-P-1624-C	584	16	24	0.75		
L-VG-P-1630-C	621	16	30	0.75		
L-VG-P-1636-C	678	16	36	0.75		
L-VG-P-1642-C	725	16	42	0.75		
L-VG-P-1648-C	734	16	48	0.75		
L-VG-P-1654-C	790	16	54	0.75		
L-VG-P-1660-C	795	16	60	0.75		

Code	Price	H	W	D	Weight (lb.)	Volume (ft ³)
L-VG-P-1666-C	834	16	66	0.75		
L-VG-P-1672-C	867	16	72	0.75		
L-VG-P-2024-C	625	20	24	0.75		
L-VG-P-2030-C	669	20	30	0.75		
L-VG-P-2036-C	755	20	36	0.75		
L-VG-P-2042-C	804	20	42	0.75		
L-VG-P-2048-C	809	20	48	0.75		
L-VG-P-2054-C	867	20	54	0.75		
L-VG-P-2060-C	877	20	60	0.75		
L-VG-P-2066-C	923	20	66	0.75		
L-VG-P-2072-C	940	20	72	0.75		

Code	Price	H	W	D	Weight (lb.)	Volume (ft ³)
Glass screen - Frosted						
L-VG-P-0824-F	699	8	24	0.75		
L-VG-P-0830-F	739	8	30	0.75		
L-VG-P-0836-F	809	8	36	0.75		
L-VG-P-0842-F	867	8	42	0.75		
L-VG-P-0848-F	875	8	48	0.75		
L-VG-P-0854-F	944	8	54	0.75		
L-VG-P-0860-F	952	8	60	0.75		
L-VG-P-0866-F	1017	8	66	0.75		
L-VG-P-0872-F	1036	8	72	0.75		
L-VG-P-1624-F	761	16	24	0.75		
L-VG-P-1630-F	806	16	30	0.75		
L-VG-P-1636-F	881	16	36	0.75		
L-VG-P-1642-F	942	16	42	0.75		
L-VG-P-1648-F	952	16	48	0.75		
L-VG-P-1654-F	1028	16	54	0.75		
L-VG-P-1660-F	1033	16	60	0.75		
L-VG-P-1666-F	1105	16	66	0.75		
L-VG-P-1672-F	1127	16	72	0.75		
L-VG-P-2024-F	810	20	24	0.75		
L-VG-P-2030-F	871	20	30	0.75		
L-VG-P-2036-F	981	20	36	0.75		
L-VG-P-2042-F	1044	20	42	0.75		
L-VG-P-2048-F	1050	20	48	0.75		
L-VG-P-2054-F	1127	20	54	0.75		
L-VG-P-2060-F	1140	20	60	0.75		
L-VG-P-2066-F	1201	20	66	0.75		
L-VG-P-2072-F	1222	20	72	0.75		

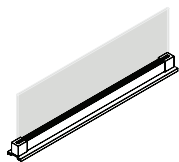

Acrylic Frameless Blade for Standard and Elevated Panels

What's Included:

One (1) acrylic piece, One (1) channel extrusion, Two (2) end caps, One (1) top trim

How to Specify:

Refer to metal finish card for metal finish options

Notes:

One (1) acrylic piece can span the width of one or two panels up to 72"W

Options:

Height: 8", 16"

Width: 24", 30", 36", 42", 48", 54", 60", 66", 72"

Clear, Frosted

Code	Price	H	W	D	Weight (lb.)	Volume (ft ³)
Acrylic screen - Frosted						
L-VA-P-0824-F	699	8	24	0.75		
L-VA-P-0830-F	739	8	30	0.75		
L-VA-P-0836-F	809	8	36	0.75		
L-VA-P-0842-F	867	8	42	0.75		
L-VA-P-0848-F	875	8	48	0.75		
L-VA-P-0854-F	944	8	54	0.75		
L-VA-P-0860-F	952	8	60	0.75		
L-VA-P-0866-F	1017	8	66	0.75		
L-VA-P-0872-F	1036	8	72	0.75		
L-VA-P-1624-F	761	16	24	0.75		
L-VA-P-1630-F	806	16	30	0.75		
L-VA-P-1636-F	881	16	36	0.75		
L-VA-P-1642-F	942	16	42	0.75		
L-VA-P-1648-F	952	16	48	0.75		
L-VA-P-1654-F	1028	16	54	0.75		
L-VA-P-1660-F	1033	16	60	0.75		
L-VA-P-1666-F	1105	16	66	0.75		
L-VA-P-1672-F	1127	16	72	0.75		

Code	Price	H	W	D	Weight (lb.)	Volume (ft ³)
Acrylic screen - Clear						
L-VA-P-0824-C	538	8	24	0.75		
L-VA-P-0830-C	570	8	30	0.75		
L-VA-P-0836-C	623	8	36	0.75		
L-VA-P-0842-C	666	8	42	0.75		
L-VA-P-0848-C	673	8	48	0.75		
L-VA-P-0854-C	726	8	54	0.75		
L-VA-P-0860-C	734	8	60	0.75		
L-VA-P-0866-C	790	16	66	0.75		
L-VA-P-0872-C	798	16	72	0.75		
L-VA-P-1624-C	584	16	24	0.75		
L-VA-P-1630-C	621	16	30	0.75		
L-VA-P-1636-C	678	16	36	0.75		
L-VA-P-1642-C	725	16	42	0.75		
L-VA-P-1648-C	734	16	48	0.75		
L-VA-P-1654-C	790	16	54	0.75		
L-VA-P-1660-C	795	16	60	0.75		
L-VA-P-1666-C	834	16	66	0.75		
L-VA-P-1672-C	867	16	72	0.75		

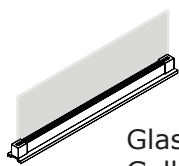

Glass Frameless Blade for Gallery Panels

What's Included:

One (1) tempered glass piece, One (1) accessory rail channel extrusion, Two (2) end caps

How to Specify:

Refer to metal finish card for metal finish options

Notes:

One (1) glass piece can span the width of one or two panels up to 72"W

Glass is tempered

Accessory rail channel extrusion can accommodate all Tayco accessories except for the paper sorter

Options:

Height: 8", 16"

Width: 24", 30", 36", 42", 48", 54", 60"

Clear, Frosted

Code	Price	H	W	D	Weight (lb.)	Volume (ft ³)
Glass screen - Frosted						
L-VG-Y-0824-F	806	8	24	0.75	5.00	0.08
L-VG-Y-0830-F	847	8	30	0.75	6.00	0.10
L-VG-Y-0836-F	913	8	36	0.75	7.00	0.13
L-VG-Y-0842-F	976	8	42	0.75	8.00	0.15
L-VG-Y-0848-F	981	8	48	0.75	10.00	0.17
L-VG-Y-0854-F	1050	8	54	0.75	11.00	0.19
L-VG-Y-0860-F	1058	8	60	0.75	12.00	0.21
L-VG-Y-1624-F	867	16	24	0.75	10.00	0.17
L-VG-Y-1630-F	911	16	30	0.75	12.00	0.21
L-VG-Y-1636-F	988	16	36	0.75	14.00	0.25
L-VG-Y-1642-F	1049	16	42	0.75	17.00	0.29
L-VG-Y-1648-F	1058	16	48	0.75	19.00	0.33
L-VG-Y-1654-F	1135	16	54	0.75	22.00	0.38
L-VG-Y-1660-F	1139	16	60	0.75	24.00	0.42

Code	Price	H	W	D	Weight (lb.)	Volume (ft ³)
Glass screen - Clear						
L-VG-Y-0824-C	699	8	30	0.75	6.00	0.10
L-VG-Y-0830-C	739	8	36	0.75	7.00	0.13
L-VG-Y-0836-C	809	8	42	0.75	8.00	0.15
L-VG-Y-0842-C	867	8	48	0.75	10.00	0.17
L-VG-Y-0848-C	875	8	54	0.75	11.00	0.19
L-VG-Y-0854-C	944	8	60	0.75	12.00	0.21
L-VG-Y-0860-C	952	16	24	0.75	10.00	0.17
L-VG-Y-1624-C	761	16	30	0.75	12.00	0.21
L-VG-Y-1630-C	806	16	36	0.75	14.00	0.25
L-VG-Y-1636-C	881	16	42	0.75	17.00	0.29
L-VG-Y-1642-C	942	16	48	0.75	19.00	0.33
L-VG-Y-1648-C	952	16	54	0.75	22.00	0.38
L-VG-Y-1654-C	1028	16	60	0.75	24.00	0.42
L-VG-Y-1660-C	1033	16	60	0.75	24.00	0.42

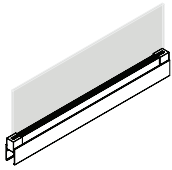

Acrylic Frameless Blade for Gallery Panels

What's Included:

One (1) acrylic piece, One (1) accessory rail channel extrusion, Two (2) end caps

How to Specify:

Refer to metal finish card for metal finish options

Notes:

One (1) acrylic piece can span the width of one or two panels up to 72"W

Accessory rail channel extrusion can accommodate all Tayco accessories except for the paper sorter

Options:

Height: 8", 16"

Width: 24", 30", 36", 42", 48", 54", 60"

Clear, Frosted

Code	Price	H	W	D	Weight (lb.)	Volume (ft ³)
Acrylic screen - Frosted						
L-VA-Y-0824-F	806	8	24	0.75	4.00	0.08
L-VA-Y-0830-F	847	8	30	0.75	5.00	0.10
L-VA-Y-0836-F	913	8	36	0.75	5.00	0.13
L-VA-Y-0842-F	976	8	42	0.75	6.00	0.15
L-VA-Y-0848-F	981	8	48	0.75	7.00	0.17
L-VA-Y-0854-F	1050	8	54	0.75	8.00	0.19
L-VA-Y-0860-F	1058	8	60	0.75	9.00	0.21
L-VA-Y-1624-F	867	16	24	0.75	7.00	0.17
L-VA-Y-1630-F	911	16	30	0.75	9.00	0.21
L-VA-Y-1636-F	988	16	36	0.75	11.00	0.25
L-VA-Y-1642-F	1049	16	42	0.75	13.00	0.29
L-VA-Y-1648-F	1058	16	48	0.75	14.00	0.33
L-VA-Y-1654-F	1135	16	54	0.75	16.00	0.38
L-VA-Y-1660-F	1139	16	60	0.75	18.00	0.42

Code	Price	H	W	D	Weight (lb.)	Volume (ft ³)
Acrylic screen - Clear						
L-VA-Y-0824-C	699	8	24	0.75	4.00	0.08
L-VA-Y-0830-C	739	8	30	0.75	5.00	0.10
L-VA-Y-0836-C	809	8	36	0.75	5.00	0.13
L-VA-Y-0842-C	867	8	42	0.75	6.00	0.15
L-VA-Y-0848-C	875	8	48	0.75	7.00	0.17
L-VA-Y-0854-C	944	8	54	0.75	8.00	0.19
L-VA-Y-0860-C	952	8	60	0.75	9.00	0.21
L-VA-Y-1624-C	761	16	24	0.75	7.00	0.17
L-VA-Y-1630-C	806	16	30	0.75	9.00	0.21
L-VA-Y-1636-C	881	16	36	0.75	11.00	0.25
L-VA-Y-1642-C	942	16	42	0.75	13.00	0.29
L-VA-Y-1648-C	952	16	48	0.75	14.00	0.33
L-VA-Y-1654-C	1028	16	54	0.75	16.00	0.38
L-VA-Y-1660-C	1033	16	60	0.75	18.00	0.42

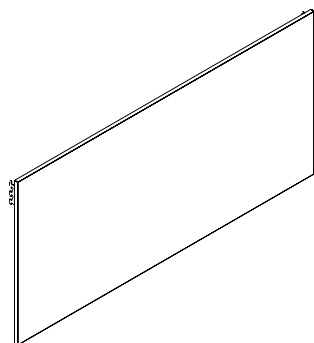

Panel Mounted Whiteboard

What's Included:

One (1) whiteboard, Two (2) slotted channel brackets

How to Specify:

Specify width of whiteboard to match the width of the panel

Choose White, Black, Silver, Charcoal for bracket color

Notes:

Panel Mounted Whiteboard is compatible with fabric and laminate panels only

Options:

Height: 15"

Width: 24", 30", 36", 42", 48", 54", 60"

Code	Price	H	W	D	Weight (lb.)	Volume (ft ³)
L-AWP0-1524	296	15	24	0.75	3.74	
L-AWP0-1530	331	15	30	0.75	4.86	
L-AWP0-1536	368	15	36	0.75	6.22	
L-AWP0-1542	402	15	42	0.75	7.48	
L-AWP0-1548	439	15	48	0.75	8.72	
L-AWP0-1554	477	15	54	0.75	9.96	
L-AWP0-1560	510	15	60	0.75	11.22	

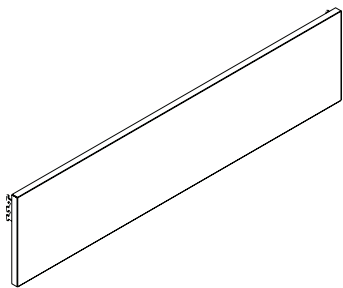

Panel Mounted Tackboard

What's Included:

One (1) tackboard, Two (2) slotted channel brackets

How to Specify:

Specify width of tackboard to match the width of the panel

Refer to panel fabric cards for fabric selections

Choose White, Black, Silver, Charcoal for bracket color

Notes:

Panel Mounted Tackboard is compatible with fabric and laminate panels only

Options:

Height: 7", 15"

Width: 24", 30", 36", 42", 48", 54", 60"

Code	Price	H	W	D	Weight (lb.)	Volume (ft ³)
L-ATP0-0724	187	7	24	0.75	1.87	
L-ATP0-0730	197	7	30	0.75	2.43	
L-ATP0-0736	208	7	36	0.75	3.11	
L-ATP0-0742	218	7	42	0.75	3.74	
L-ATP0-0748	225	7	48	0.75	4.36	
L-ATP0-0754	232	7	54	0.75	4.98	
L-ATP0-0760	240	7	60	0.75	5.61	
L-ATP0-1524	232	15	24	0.75	4.00	
L-ATP0-1530	253	15	30	0.75	4.86	
L-ATP0-1536	269	15	36	0.75	6.22	
L-ATP0-1542	286	15	42	0.75	7.48	
L-ATP0-1548	307	15	48	0.75	8.72	
L-ATP0-1554	324	15	54	0.75	9.96	
L-ATP0-1560	340	15	60	0.75	11.22	

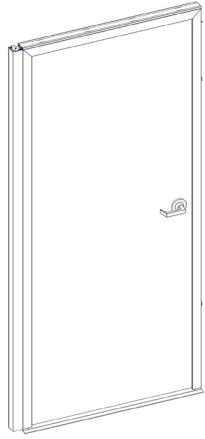

Hinged Door

What's Included:

Hinged Door laminate available in white, black and silver

How to Specify:

Notes:

Options:

Height: 82"

Width: 36", 42",

Left handed, Right handed

Straight connection, 90 degree connection, 3-way connection and 4-way connection

Code	Price	H	W	D	Weight (lb.)	Volume (ft ³)
Straight connection						
L-PD00-8236-L	3670	82	36			
L-PD00-8236-R	3670	82	36			
L-PD00-8242-L	3740	82	42			
L-PD00-8242-R	3740	82	42			
3-way connection						
L-PD00-8236-L-3W	4382	82	36			
L-PD00-8236-R-3W	4382	82	36			
L-PD00-8242-L-3W	4452	82	42			
L-PD00-8242-R-3W	4452	82	42			
4-way connection						
L-PD00-8236-L-4W	4092	82	36			
L-PD00-8236-R-4W	4092	82	36			
L-PD00-8242-L-4W	4162	82	42			
L-PD00-8242-R-4W	4162	82	42			
90 degree connection						
L-PD00-8236-L-90	4171	82	36			
L-PD00-8236-R-90	4171	82	36			
L-PD00-8242-L-90	4241	82	42			
L-PD00-8242-R-90	4241	82	42			

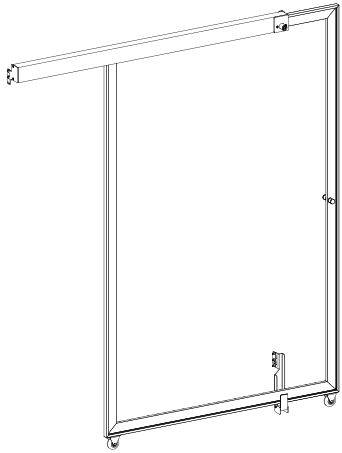

Sliding Door - Acrylic



T filler

What's Included:

Sliding door acrylic available in white and black

How to Specify:

Notes:

T filler for sliding door required for applications where the ends on a panel end.

Options:

Height: 66"

Bracket Width: 30", 36", 42", 48", 54", 60"

Door Width: 30", 36", 42"

Left handed, Right handed

Clear, Frosted, Fluted

Code	Price	H	W	D	Weight (lb.)	Volume (ft ³)
Clear Acrylic - left hand						
L-PDSC-663030-L	2463	66	30			
L-PDSC-663036-L	2479	66	36			
L-PDSC-663042-L	2486	66	42			
L-PDSC-663048-L	2494	66	48			
L-PDSC-663054-L	2500	66	54			
L-PDSC-663060-L	2506	66	60			
L-PDSC-663636-L	2474	66	36			
L-PDSC-663642-L	2487	66	42			
L-PDSC-663648-L	2495	66	48			
L-PDSC-663654-L	2502	66	54			
L-PDSC-663660-L	2507	66	60			
L-PDSC-664242-L	2481	66	42			
L-PDSC-664248-L	2496	66	48			
L-PDSC-664254-L	2502	66	54			
L-PDSC-664260-L	2508	66	60			
Clear Acrylic - right hand						
L-PDSC-663030-R	2463	66	30			
L-PDSC-663036-R	2479	66	36			
L-PDSC-663042-R	2486	66	42			
L-PDSC-663048-R	2494	66	48			
L-PDSC-663054-R	2500	66	54			
L-PDSC-663060-R	2506	66	60			
L-PDSC-663636-R	2474	66	36			
L-PDSC-663642-R	2487	66	42			
L-PDSC-663648-R	2495	66	48			
L-PDSC-663654-R	2502	66	54			
L-PDSC-663660-R	2507	66	60			
L-PDSC-664242-R	2481	66	42			
L-PDSC-664248-R	2496	66	48			
L-PDSC-664254-R	2502	66	54			
L-PDSC-664260-R	2508	66	60			
T-filler						
L-SDP-66	482	66				

Code	Price	H	W	D	Weight (lb.)	Volume (ft ³)
L-PDSF-663042-L	2735	66	42			
L-PDSF-663048-L	2740	66	48			
L-PDSF-663054-L	2748	66	54			
L-PDSF-663060-L	2756	66	60			
L-PDSF-663636-L	2723	66	36			
L-PDSF-663642-L	2736	66	42			
L-PDSF-663648-L	2742	66	48			
L-PDSF-663654-L	2749	66	54			
L-PDSF-663660-L	2758	66	60			
L-PDSF-664242-L	2732	66	42			
L-PDSF-664248-L	2744	66	48			
L-PDSF-664254-L	2750	66	54			
L-PDSF-664260-L	2759	66	60			
Frosted Acrylic - right hand						
L-PDSF-663030-R	2713	66	30			
L-PDSF-663036-R	2727	66	36			
L-PDSF-663042-R	2735	66	42			
L-PDSF-663048-R	2740	66	48			
L-PDSF-663054-R	2748	66	54			
L-PDSF-663060-R	2756	66	60			
L-PDSF-663636-R	2723	66	36			
L-PDSF-663642-R	2736	66	42			
L-PDSF-663648-R	2742	66	48			
L-PDSF-663654-R	2749	66	54			
L-PDSF-663660-R	2758	66	60			
L-PDSF-664242-R	2732	66	42			
L-PDSF-664248-R	2744	66	48			
L-PDSF-664254-R	2750	66	54			
L-PDSF-664260-R	2759	66	60			

Code	Price	H	W	D	Weight (lb.)	Volume (ft ³)
Fluted acrylic - left hand						
L-PDSL-663030-L	2463	66	30			
L-PDSL-663036-L	2479	66	36			
L-PDSL-663042-L	2486	66	42			
L-PDSL-663048-L	2494	66	48			
L-PDSL-663054-L	2500	66	54			
L-PDSL-663060-L	2506	66	60			
L-PDSL-663636-L	2474	66	36			
L-PDSL-663642-L	2487	66	42			
L-PDSL-663648-L	2495	66	48			
L-PDSL-663654-L	2502	66	54			
L-PDSL-663660-L	2507	66	60			
L-PDSL-664242-L	2481	66	42			
L-PDSL-664248-L	2496	66	48			
L-PDSL-664254-L	2502	66	54			
L-PDSL-664260-L	2508	66	60			
Fluted acrylic - right hand						
L-PDSL-663030-R	2463	66	30			
L-PDSL-663036-R	2479	66	36			
L-PDSL-663042-R	2486	66	42			
L-PDSL-663048-R	2494	66	48			
L-PDSL-663054-R	2500	66	54			
L-PDSL-663060-R	2506	66	60			
L-PDSL-663636-R	2474	66	36			
L-PDSL-663642-R	2487	66	42			
L-PDSL-663648-R	2495	66	48			
L-PDSL-663654-R	2502	66	54			
L-PDSL-663660-R	2507	66	60			
L-PDSL-664242-R	2481	66	42			
L-PDSL-664248-R	2496	66	48			
L-PDSL-664254-R	2502	66	54			
L-PDSL-664260-R	2508	66	60			

tayco®

Switch Canada Pricebook
June 2026

**Connections
& Trims**

Connections & Trims

2-Way Connection	118
3-Way T Connection	119
4-Way X Connection	120
Top Cap	121
Full Height End Trim	122
Partial Height End Trim	123
Full Height T Filler	124
Partial Height T Filler	125
90 Degree Filler-Full Height	126
90 Degree Filler- Partial Height	127
Straight Filler	128
Gallery Panel FillerConnections and Trims	129
Adjustable Wall Connector	130

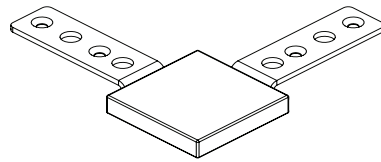

2-Way 90 degree Connection



What's Included:

One (1) type A or type B straight or 90 degree connection bracket, accompanying screws

How to Specify:

Refer to page X for connection type application guide

Code	Price	H	W	D	Weight (lb.)	Volume (ft ³)
2-Way Straight Connection						
L-HC2W-180-A	25	1	2	3	0.02	0.00
L-HC2W-180-B	23	1	2	3	0.02	0.00
2-Way 90 degree Connection						
L-HC2W-90-A	59	1	2	3	0.02	0.00
L-HC2W-90-B	59	1	2	3	0.02	0.00

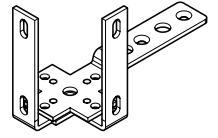
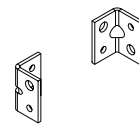
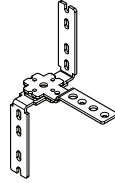
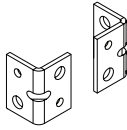
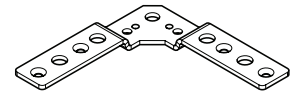
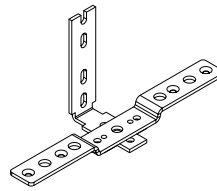
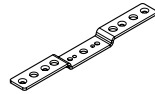
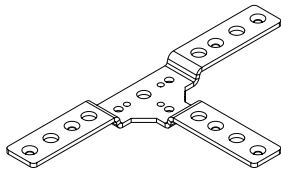

L-HC3W-A

L-HC3W-C

L-HC3W-D



L-HC3W-B

What's Included:

One (1) type A or type B straight or 90 degree connection bracket, accompanying screws

How to Specify:

Refer to page X for connection type application guide

Notes:

Code	Price	H	W	D	Weight (lb.)	Volume (ft ³)
3 Way T Connectors						
L-HC3W-A	99	1	2	3	0.02	0.00
L-HC3W-B	129	1	2	3	0.02	0.00
L-HC3W-C	94	1	2	3	0.02	0.00
L-HC3W-D	123	1	2	3	0.02	0.00

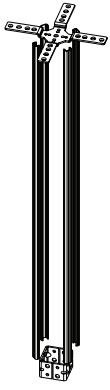

L-HC4W-A

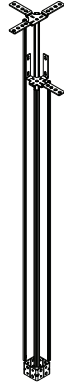

L-HC4W-B

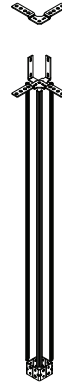

L-HC4W-C



L-HC4W-D

What's Included:

One (1) type A, B, C or D 4-Way X connection bracket, accompanying screws

How to Specify:

Refer to page X for connection type application guide

Notes:

Code	Price	H	W	D	Weight (lb.)	Volume (ft ³)
4 way connectors						
L-HC4W-A	158	1	2	3	0.02	0.00
L-HC4W-B	201	1	2	3	0.02	0.00
L-HC4W-C	181	1	2	3	0.02	0.00
L-HC4W-D	187	1	2	3	0.02	0.00

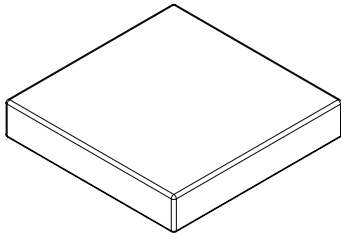

What's Included:

One (1) Top Cap

How to Specify:

Choose White, Black, Silver, Charcoal for Top Cap

Notes:

Options:

Width: 2"

Depth: 2"

Code	Price	H	W	D	Weight (lb.)	Volume (ft ³)
L-HUFC-02	12	1	2	2	0.02	0.00



Standard



with coat hook

What's Included:

One (1) Full Height End Trim

How to Specify:

Choose White, Black, Silver, Charcoal for Full Height End Trim Colour

Notes:

Options:

Height: 34", 42", 50", 66", 82"

Width: 2"

Standard, Coat Hook

Code	Price	H	W	D	Weight (lb.)	Volume (ft ³)
standard						
L-HETF-34	93	34	2	1	0.68	0.04
L-HETF-42	94	42	2	1	0.84	0.05
L-HETF-50	99	50	2	1	1.00	0.06
L-HETF-66	119	66	2	1	1.32	0.08
L-HETF-82	225	82	2	2	1.32	0.19
with coat hook						
L-HETF-34-CH	110	34	2	1	0.68	0.04
L-HETF-42-CH	117	42	2	1	0.84	0.05
L-HETF-50-CH	126	50	2	1	1.00	0.06
L-HETF-66-CH	152	66	2	1	1.32	0.08

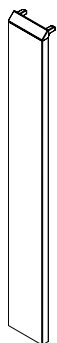

What's Included:

One (1) Partial Height End Trim

How to Specify:

Choose White, Black, Silver, Charcoal for Partial Height End Trim Colour

Notes:

Options:

Height: 8", 16", 24", 32", 40", 48"

Width: 2"

Code	Price	H	W	D	Weight (lb.)	Volume (ft ³)
L-HETP-08	84	8	2	1	0.16	0.01
L-HETP-16	89	16	2	1	0.32	0.02
L-HETP-24	90	24	2	1	0.48	0.03
L-HETP-32	93	32	2	1	0.64	0.04
L-HETP-40	170	40	2	1	0.72	0.05
L-HETP-48	185	48	2	1	0.84	0.06



Full Height T Filler

What's Included:

One (1) Full Height T Filler

How to Specify:

Choose White, Black, Silver, Charcoal for Full Height T Filler

Notes:

Options:

Height: 34", 42", 50", 66", 82"

Width: 2"

Code	Price	H	W	D	Weight (lb.)	Volume (ft ³)
L-HFTR-34	209	34	2	1	0.68	0.04
L-HFTR-42	209	42	2	1	0.84	0.05
L-HFTR-50	219	50	2	1	1.00	0.06
L-HFTR-66	219	66	2	1	1.32	0.08
L-HFTR-82	426	82	2	1	1.64	0.09



Partial Height T Filler

What's Included:

One (1) Partial Height T Filler

How to Specify:

Choose White, Black, Silver, Charcoal for Partial Height T Filler

Notes:

Options:

Height: 8", 16", 24", 32", 40", 48"

Width: 2"

Code	Price	H	W	D	Weight (lb.)	Volume (ft ³)
L-HFTP-08	164	8	2	1	0.16	0.01
L-HFTP-16	164	16	2	1	0.32	0.02
L-HFTP-24	170	24	2	1	0.48	0.03
L-HFTP-32	170	32	2	1	0.64	0.04
L-HFTP-40	278	40	2	1	0.72	0.05



Full Height 90 Degree Filler

What's Included:

One (1) Full Height 90 Degree Filler

How to Specify:

Choose White, Black, Silver, Charcoal for Full Height 90 Degree Filler

Notes:

Options:

Height: 34", 42", 50", 66", 82"

Width: 2"

Code	Price	H	W	D	Weight (lb.)	Volume (ft ³)
L-HFNR-34	171	34	2	1	0.7	0.04
L-HFNR-42	181	42	2	1	0.7	0.05
L-HFNR-50	193	50	2	1	1.0	0.06
L-HFNR-66	209	66	2	1	1.3	0.08
L-HFNR-82	426	82	2	1	1.6	0.09



Partial Height 90 Degree Filler

What's Included:

One (1) Partial Height 90 Degree Filler

How to Specify:

Choose White, Black, Silver, Charcoal for Partial Height 90 Degree Filler

Notes:

Options:

Height: 8", 16", 24", 32", 40", 48"

Width: 2"

Code	Price	H	W	D	Weight (lb.)	Volume (ft ³)
L-HFNP-08	72	8	2	1	0.2	0.01
L-HFNP-16	124	16	2	1	0.3	0.02
L-HFNP-24	135	24	2	1	0.5	0.03
L-HFNP-32	183	32	2	1	0.6	0.04
L-HFNP-40	278	40	2	1	0.7	0.05
L-HFNP-48	295	48	2	1	0.8	0.05

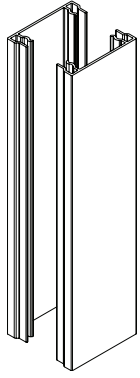

What's Included:

Partial Height Straight Filler

How to Specify:

Choose White, Black, Silver, Charcoal for Partial Height Straight Filler

Notes:

Options:

Height: 8", 16", 24", 32", 40", 48"

Width: 2"

Code	Price	H	W	D	Weight (lb.)	Volume (ft ³)
L-HFSP-08	55	8	2	1	0.2	0.01
L-HFSP-16	94	16	2	1	0.3	0.02
L-HFSP-24	101	24	2	1	0.5	0.03
L-HFSP-32	105	32	2	1	0.6	0.04
L-HFSP-40	278	40	2	1	0.8	0.05
L-HFSP-48	295	48	2	1	1.0	0.06

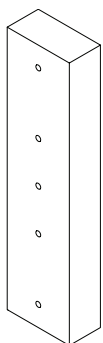

Partial Height Gallery Panel Filler

What's Included:

One (1)Partial Height Gallery Panel Filler

How to Specify:

Gallery Panel Filler matches laminate finish chosen on Gallery Panel

Notes:

Options:

Height: 8", 16", 24", 32", 40", 48"

Width: 2"

Thickness: 1"

Code	Price	H	W	D	Weight (lb.)	Volume (ft ³)
L-HYP-08	84	8	1	1	0.1	0.00
L-HYP-16	89	16	1	1	0.2	0.01
L-HYP-24	112	24	1	1	0.2	0.01
L-HYP-32	132	32	1	1	0.3	0.02
L-HYP-40	278	40	1	1	0.4	0.03
L-HYP-48	295	48	1	1	0.6	0.04



mount 2



mount 4



mount 6

Code	Price	H	W	D	Weight (lb.)	Volume (ft ³)
mount 2						
L-HW2-34	147	34	2	2	1.4	0.08
L-HW2-42	177	42	2	2	1.7	0.10
L-HW2-50	208	50	2	2	2.0	0.12
L-HW2-66	263	66	2	2	2.6	0.15
L-HW2-82	363	82	2	2	3.2	0.18
mount 4						
L-HW4-34	170	34	2	4	2.7	0.16
L-HW4-42	198	42	2	4	3.4	0.19
L-HW4-50	230	50	2	4	4.0	0.23
L-HW4-66	284	66	2	4	5.3	0.31
L-HW4-82	400	82	2	4	6.6	0.40
mount 6						
L-HW6-34	193	34	2	6	4.1	0.24
L-HW6-42	209	42	2	6	5.0	0.29
L-HW6-50	240	50	2	6	6.0	0.35
L-HW6-66	304	66	2	6	7.9	0.46
L-HW6-82	426	82	2	6	9.8	0.57

tayco®

Switch Canada Pricebook
June 2026

Worksurfaces

Straight w/ grommet	134
Straight Worksurface w/o Grommet	136
Straight Worksurface w/ Wire Play	140
5-sided w/ Grommet	144
5-sided Worksurface w/ Wire Play	146
Unitized w/ Grommet	148
Unitized w/ Wire Play	150
Transaction Top	152

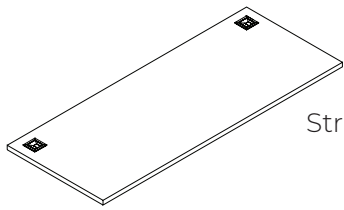

Straight Worksurface with Grommet

What's Included:

- One (1) worksurface
- 24"-48" - One (1) grommet cover for centre grommet
- 54"-96" - Two (2) grommet covers for grommet on each end

How to Specify:

Refer to laminate card for laminate options

Notes:

- 24"-48" - One (1) grommet hole in the centre of the worksurface
- 54"-96" - Two (2) grommet holes on each end of the worksurface

Options:

Width:	24", 30", 36", 42", 48", 54", 60", 66", 72", 78", 84", 90", 96"
Depth:	20", 24", 30"
Thickness:	1"

Code	Price	H	W	D	Weight (lb.)	Volume (ft ³)
L-WS0G-2420	222	24	20	1	9.6	0.28
L-WS0G-3020	255	30	20	1	12.0	0.35
L-WS0G-3620	312	36	20	1	14.4	0.42
L-WS0G-4220	325	42	20	1	16.8	0.49
L-WS0G-4820	351	48	20	1	19.2	0.56
L-WS0G-5420	407	54	20	1	21.6	0.62
L-WS0G-6020	429	60	20	1	24.0	0.69
L-WS0G-6620	467	66	20	1	26.4	0.76
L-WS0G-7220	498	72	20	1	28.8	0.83
L-WS0G-7820	525	78	20	1	31.2	0.90
L-WS0G-8420	590	84	20	1	33.6	0.97
L-WS0G-9020	598	90	20	1	36.0	1.04
L-WS0G-9620	641	96	20	1	38.4	1.11
L-WS0G-2424	222	24	24	1	11.5	0.33

Code	Price	H	W	D	Weight (lb.)	Volume (ft ³)
L-WS0G-3024	255	30	24	1	14.4	0.42
L-WS0G-3624	312	36	24	1	17.3	0.50
L-WS0G-4224	325	42	24	1	20.2	0.58
L-WS0G-4824	351	48	24	1	23.0	0.67
L-WS0G-5424	407	54	24	1	25.9	0.75
L-WS0G-6024	429	60	24	1	28.8	0.83
L-WS0G-6624	467	66	24	1	31.7	0.92
L-WS0G-7224	498	72	24	1	34.6	1.00
L-WS0G-7824	525	78	24	1	37.4	1.08
L-WS0G-8424	590	84	24	1	40.3	1.17
L-WS0G-9024	598	90	24	1	43.2	1.25
L-WS0G-9624	641	96	24	1	46.1	1.33
L-WS0G-2430	255	24	30	1	14.4	0.42
L-WS0G-3030	288	30	30	1	18.0	0.52
L-WS0G-3630	327	36	30	1	21.6	0.62
L-WS0G-4230	358	42	30	1	25.2	0.73
L-WS0G-4830	401	48	30	1	28.8	0.83
L-WS0G-5430	439	54	30	1	32.4	0.94
L-WS0G-6030	476	60	30	1	36.0	1.04
L-WS0G-6630	518	66	30	1	39.6	1.15
L-WS0G-7230	555	72	30	1	43.2	1.25
L-WS0G-7830	594	78	30	1	46.8	1.35
L-WS0G-8430	625	84	30	1	50.4	1.46
L-WS0G-9030	662	90	30	1	54.0	1.56
L-WS0G-9630	700	96	30	1	57.6	1.67

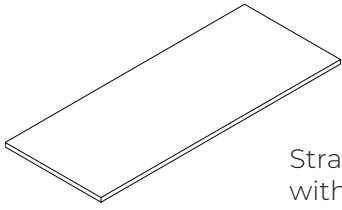

Straight Worksurface without Full Depth without Grommet

What's Included:

One (1) worksurface

How to Specify:

Refer to laminate card for laminate options

Notes:

Worksurface is full depth to sit flush against panel with no grommet

Options:

Width: 24", 30", 36", 42", 48", 54", 60", 66", 72", 78", 84", 90", 96"

Depth: 20", 24", 30"

Thickness: 1"

Code	Price	Height	Depth	Thickness	Weight (lb.)	Volume (ft ³)
Straight Worksurface without Full Depth without Grommet						
L-WS00-2320	171	23	20	1	9.2	0.27
L-WS00-2420	171	24	20	1	9.6	0.28
L-WS00-2920	206	29	20	1	11.6	0.34
L-WS00-3020	206	30	20	1	12.0	0.35
L-WS00-3520	256	35	20	1	14.0	0.41
L-WS00-3620	256	36	20	1	14.4	0.42
L-WS00-4120	265	41	20	1	16.4	0.47
L-WS00-4220	265	42	20	1	16.8	0.49
L-WS00-4720	292	47	20	1	18.8	0.54
L-WS00-4820	292	48	20	1	19.2	0.56
L-WS00-5320	350	53	20	1	21.2	0.61

Code	Price	Height	Depth	Thickness	Weight (lb.)	Volume (ft ³)
L-WS00-5420	350	54	20	1	21.6	0.62
L-WS00-5920	350	59	20	1	23.6	0.68
L-WS00-6020	350	60	20	1	24.0	0.69
L-WS00-6520	407	65	20	1	26.0	0.75
L-WS00-6620	407	66	20	1	26.4	0.76
L-WS00-7120	438	71	20	1	28.4	0.82
L-WS00-7220	438	72	20	1	28.8	0.83
L-WS00-7620	467	76	20	1	30.4	0.88
L-WS00-7720	467	77	20	1	30.8	0.89
L-WS00-7820	467	78	20	1	31.2	0.90
L-WS00-8220	499	82	20	1	32.8	0.95
L-WS00-8320	499	83	20	1	33.2	0.96
L-WS00-8420	499	84	20	1	33.6	0.97
L-WS00-8820	518	88	20	1	35.2	1.02
L-WS00-8920	518	89	20	1	35.6	1.03
L-WS00-9020	518	90	20	1	36.0	1.04
L-WS00-9420	550	94	20	1	37.6	1.09
L-WS00-9520	550	95	20	1	38.0	1.10
L-WS00-9620	550	96	20	1	38.4	1.11
L-WS00-2324	171	23	24	1	11.0	0.32
L-WS00-2424	171	24	24	1	11.5	0.33
L-WS00-2924	206	29	24	1	13.9	0.40
L-WS00-3024	206	30	24	1	14.4	0.42
L-WS00-3524	256	35	24	1	16.8	0.49
L-WS00-3624	256	36	24	1	17.3	0.50
L-WS00-4124	265	41	24	1	19.7	0.57

[2 of 4] continued on next page

Worksurface continued [3 of 4]

Code	Price	Height	Depth	Thickness	Weight (lb.)	Volume (ft ³)
L-WS00-4224	265	42	24	1	20.2	0.58
L-WS00-4724	292	47	24	1	22.6	0.65
L-WS00-4824	292	48	24	1	23.0	0.67
L-WS00-5324	350	53	24	1	25.4	0.74
L-WS00-5424	350	54	24	1	25.9	0.75
L-WS00-5924	374	59	24	1	28.3	0.82
L-WS00-6024	374	60	24	1	28.8	0.83
L-WS00-6524	407	65	24	1	31.2	0.90
L-WS00-6624	407	66	24	1	31.7	0.92
L-WS00-7124	438	71	24	1	34.1	0.99
L-WS00-7224	438	72	24	1	34.6	1.00
L-WS00-7624	467	76	24	1	36.5	1.06
L-WS00-7724	467	77	24	1	37.0	1.07
L-WS00-7824	467	78	24	1	37.4	1.08
L-WS00-8224	499	82	24	1	39.4	1.14
L-WS00-8324	499	83	24	1	39.8	1.15
L-WS00-8424	499	84	24	1	40.3	1.17
L-WS00-8824	518	88	24	1	42.2	1.22
L-WS00-8924	518	89	24	1	42.7	1.24
L-WS00-9024	518	90	24	1	43.2	1.25
L-WS00-9424	550	94	24	1	45.1	1.31
L-WS00-9524	550	95	24	1	45.6	1.32
L-WS00-9624	550	96	24	1	46.1	1.33
L-WS00-2330	206	23	30	1	13.8	0.40
L-WS00-2430	206	24	30	1	14.4	0.42
L-WS00-2930	239	29	30	1	17.4	0.50

Worksurface continued [4 of 4]

Code	Price	Height	Depth	Thickness	Weight (lb.)	Volume (ft ³)
L-WS00-3030	239	30	30	1	18.0	0.52
L-WS00-3530	279	35	30	1	21.0	0.61
L-WS00-3630	279	36	30	1	21.6	0.62
L-WS00-4130	310	41	30	1	24.6	0.71
L-WS00-4230	310	42	30	1	25.2	0.73
L-WS00-4730	353	47	30	1	28.2	0.82
L-WS00-4830	353	48	30	1	28.8	0.83
L-WS00-5330	390	53	30	1	31.8	0.92
L-WS00-5430	390	54	30	1	32.4	0.94
L-WS00-5930	427	59	30	1	35.4	1.02
L-WS00-6030	427	60	30	1	36.0	1.04
L-WS00-6530	468	65	30	1	39.0	1.13
L-WS00-6630	468	66	30	1	39.6	1.15
L-WS00-7130	505	71	30	1	42.6	1.23
L-WS00-7230	505	72	30	1	43.2	1.25
L-WS00-7630	549	76	30	1	45.6	1.32
L-WS00-7730	549	77	30	1	46.2	1.34
L-WS00-7830	549	78	30	1	46.8	1.35
L-WS00-8230	578	82	30	1	49.2	1.42
L-WS00-8330	578	83	30	1	49.8	1.44
L-WS00-8430	578	84	30	1	50.4	1.46
L-WS00-8830	616	88	30	1	52.8	1.53
L-WS00-8930	616	89	30	1	53.4	1.55
L-WS00-9030	616	90	30	1	54.0	1.56
L-WS00-9430	651	94	30	1	56.4	1.63
L-WS00-9530	651	95	30	1	57.0	1.65
L-WS00-9630	651	96	30	1	57.6	1.67

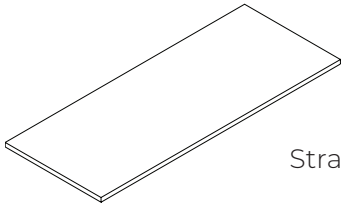

Straight Worksurface with 1" Wire Play

What's Included:

One (1) worksurface

How to Specify:

Refer to laminate card for laminate options

Notes:

Worksurface sits 1" from the panel to allow for wire routing. No grommet is included with this worksurface

Options:

Width:	23", 24", 29", 30", 35", 36", 41", 42", 47", 48", 53", 54", 59", 60", 65", 66", 71", 72", 77", 78", 83", 84", 89", 90", 95", 96"
Depth:	19", 20", 23", 24", 29", 30"
Thickness:	1"

Code	Price	Height	Depth	Thickness	Weight (lb.)	Volume (ft ³)
Straight Worksurface with 1" Wire Play						
L-WS00-2319	171	23	19	1	8.7	0.25
L-WS00-2419	171	24	19	1	9.1	0.26
L-WS00-2919	206	29	19	1	11.0	0.32
L-WS00-3019	206	30	19	1	11.4	0.33
L-WS00-3519	256	35	19	1	13.3	0.38
L-WS00-3619	256	36	19	1	13.7	0.40
L-WS00-4119	265	41	19	1	15.6	0.45
L-WS00-4219	265	42	19	1	16.0	0.46
L-WS00-4719	292	47	19	1	17.9	0.52
L-WS00-4819	292	48	19	1	18.2	0.53
L-WS00-5319	350	53	19	1	20.1	0.58
L-WS00-5419	350	54	19	1	20.5	0.59

Code	Price	Height	Depth	Thickness	Weight (lb.)	Volume (ft ³)
L-WS00-5919	350	59	19	1	22.4	0.65
L-WS00-6019	350	60	19	1	22.8	0.66
L-WS00-6519	407	65	19	1	24.7	0.71
L-WS00-6619	407	66	19	1	25.1	0.73
L-WS00-7119	438	71	19	1	27.0	0.78
L-WS00-7219	438	72	19	1	27.4	0.79
L-WS00-7619	467	76	19	1	28.9	0.84
L-WS00-7719	467	77	19	1	29.3	0.85
L-WS00-7819	467	78	19	1	29.6	0.86
L-WS00-8219	499	82	19	1	31.2	0.90
L-WS00-8319	499	83	19	1	31.5	0.91
L-WS00-8419	499	84	19	1	31.9	0.92
L-WS00-8819	518	88	19	1	33.4	0.97
L-WS00-8919	518	89	19	1	33.8	0.98
L-WS00-9019	518	90	19	1	34.2	0.99
L-WS00-9419	550	94	19	1	35.7	1.03
L-WS00-9519	550	95	19	1	36.1	1.04
L-WS00-9619	550	96	19	1	36.5	1.06
L-WS00-2323	171	23	23	1	10.6	0.31
L-WS00-2423	171	24	23	1	11.0	0.32
L-WS00-2923	206	29	23	1	13.3	0.39
L-WS00-3023	206	30	23	1	13.8	0.40
L-WS00-3523	256	35	23	1	16.1	0.47
L-WS00-3623	256	36	23	1	16.6	0.48
L-WS00-4123	265	41	23	1	18.9	0.55
L-WS00-4223	265	42	23	1	19.3	0.56
L-WS00-4723	292	47	23	1	21.6	0.63

[2 of 4] continued on next page

Worksurface continued [3 of 4]

Code	Price	Height	Depth	Thickness	Weight (lb.)	Volume (ft ³)
L-WS00-4823	292	48	23	1	22.1	0.64
L-WS00-5323	350	53	23	1	24.4	0.71
L-WS00-5423	350	54	23	1	24.8	0.72
L-WS00-5923	350	59	23	1	27.1	0.79
L-WS00-6023	350	60	23	1	27.6	0.80
L-WS00-6523	407	65	23	1	29.9	0.87
L-WS00-6623	407	66	23	1	30.4	0.88
L-WS00-7123	438	71	23	1	32.7	0.95
L-WS00-7223	438	72	23	1	33.1	0.96
L-WS00-7623	467	76	23	1	35.0	1.01
L-WS00-7723	467	77	23	1	35.4	1.02
L-WS00-7823	467	78	23	1	35.9	1.04
L-WS00-8223	499	82	23	1	37.7	1.09
L-WS00-8323	499	83	23	1	38.2	1.10
L-WS00-8423	499	84	23	1	38.6	1.12
L-WS00-8823	518	88	23	1	40.5	1.17
L-WS00-8923	518	89	23	1	40.9	1.18
L-WS00-9023	518	90	23	1	41.4	1.20
L-WS00-9423	550	94	23	1	43.2	1.25
L-WS00-9523	550	95	23	1	43.7	1.26
L-WS00-9623	550	96	23	1	44.2	1.28
L-WS00-2329	206	23	29	1	13.3	0.39
L-WS00-2429	206	24	29	1	13.9	0.40
L-WS00-2929	239	29	29	1	16.8	0.49
L-WS00-3029	239	30	29	1	17.4	0.50
L-WS00-3529	279	35	29	1	20.3	0.59
L-WS00-3629	279	36	29	1	20.9	0.60
L-WS00-4129	310	41	29	1	23.8	0.69

Worksurface continued [4 of 4]

Code	Price	Height	Depth	Thickness	Weight (lb.)	Volume (ft ³)
L-WS00-4229	310	42	29	1	24.4	0.70
L-WS00-4729	353	47	29	1	27.3	0.79
L-WS00-4829	353	48	29	1	27.8	0.81
L-WS00-5329	390	53	29	1	30.7	0.89
L-WS00-5429	390	54	29	1	31.3	0.91
L-WS00-5929	427	59	29	1	34.2	0.99
L-WS00-6029	427	60	29	1	34.8	1.01
L-WS00-6529	468	65	29	1	37.7	1.09
L-WS00-6629	468	66	29	1	38.3	1.11
L-WS00-7129	505	71	29	1	41.2	1.19
L-WS00-7229	505	72	29	1	41.8	1.21
L-WS00-7629	549	76	29	1	44.1	1.28
L-WS00-7729	549	77	29	1	44.7	1.29
L-WS00-7829	549	78	29	1	45.2	1.31
L-WS00-8229	578	82	29	1	47.6	1.38
L-WS00-8329	578	83	29	1	48.1	1.39
L-WS00-8429	578	84	29	1	48.7	1.41
L-WS00-8829	616	88	29	1	51.0	1.48
L-WS00-8929	616	89	29	1	51.6	1.49
L-WS00-9029	616	90	29	1	52.2	1.51
L-WS00-9429	651	94	29	1	54.5	1.58
L-WS00-9529	651	95	29	1	55.1	1.59
L-WS00-9629	651	96	29	1	55.7	1.61

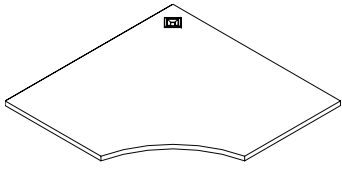

Curved 5-Sided Workspace with Grommet

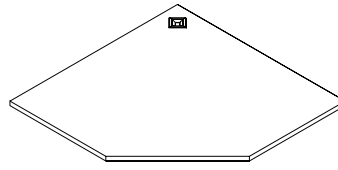

Straight 5-Sided Workspace with Grommet

What's Included:

One (1) workspace, One (1) grommet

How to Specify:

Refer to laminate card for laminate options

Notes:

Workspace sits 1" from the panel to allow for wire routing. No grommet is included with this workspace

Surface has a curved front

Options:

Side A*: 36", 42", 48"

Side B: 24", 30"

Thickness: 1"

Straight, Curved Front

Grommet Type & Color: Square (Silver, Black, White), Oval (Silver, Black)

*36" on side A only available in 24" on side B

Code	Price	Height	Depth	Thickness	Weight (lb.)	Volume (ft ³)
curved front with grommet						
L-W5CG-3624	467	36	24	1	30.0	0.50
L-W5CG-4224	556	42	24	1	33.0	0.58
L-W5CG-4824	667	48	24	1	36.0	0.67
L-W5CG-4230	556	42	30	1	35.0	0.73
L-W5CG-4830	667	48	30	1	38.0	0.83
straight front with grommet						
L-W5SG-3624	467	36	24	1	30.0	0.50
L-W5SG-4224	556	42	24	1	33.0	0.58
L-W5SG-4824	667	48	24	1	36.0	0.67
L-W5SG-4230	556	42	30	1	35.0	0.73
L-W5SG-4830	667	48	30	1	38.0	0.83

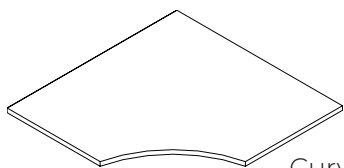

Curved 5-Sided Worksurface with 1" Wire Play

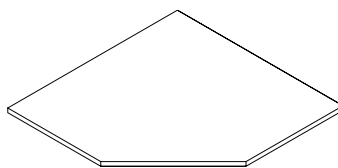

Straight 5-Sided Worksurface with 1" Wire Play

What's Included:

One (1) worksurface

How to Specify:

Refer to laminate card for laminate options

Options:

Side A & C*: 35", 36", 41", 42", 47", 48"

Side B & D: 23", 24", 29", 30"

Thickness: 1"

Straight, Curved Front

*35" & 36" on side A & C only available in 23" & 24" on side B & D

Notes:

Worksurface sits 1" from the panel to allow for wire routing. No grommet is included with this worksurface

Code	Price	Height	Depth	Thickness	Weight (lb.)	Volume (ft ³)
Left hand curved front						
L-W5C0-3624-L	467	36	24	1	30.0	0.50
L-W5C0-4224-L	556	42	24	1	33.0	0.58
L-W5C0-4824-L	667	48	24	1	36.0	0.67
L-W5C0-4230-L	556	42	30	1	35.0	0.73
L-W5C0-4830-L	667	48	30	1	38.0	0.83
Right hand curved front						
L-W5C0-3624-R	467	36	24	1	30.0	0.50
L-W5C0-4224-R	556	42	24	1	33.0	0.58
L-W5C0-4824-R	667	48	24	1	36.0	0.67
L-W5C0-4230-R	556	42	30	1	35.0	0.73
L-W5C0-4830-R	667	48	30	1	38.0	0.83
Double curved front						
L-W5C0-3523-D	467	35	23	1	30.0	0.47
L-W5C0-4123-D	556	41	23	1	33.0	0.55
L-W5C0-4723-D	667	47	23	1	36.0	0.63
L-W5C0-4129-D	556	41	29	1	35.0	0.69
L-W5C0-4729-D	667	47	29	1	38.0	0.79

Code	Price	Height	Depth	Thickness	Weight (lb.)	Volume (ft ³)
Left hand straight front						
L-W5S0-3624-L	467	36	24	1	30.0	0.50
L-W5S0-4224-L	556	42	24	1	33.0	0.58
L-W5S0-4824-L	667	48	24	1	36.0	0.67
L-W5S0-4230-L	556	42	30	1	35.0	0.73
L-W5S0-4830-L	667	48	30	1	38.0	0.83
Right hand straight front						
L-W5S0-3624-R	467	36	24	1	30.0	0.50
L-W5S0-4224-R	556	42	24	1	33.0	0.58
L-W5S0-4824-R	667	48	24	1	36.0	0.67
L-W5S0-4230-R	556	42	30	1	35.0	0.73
L-W5S0-4830-R	667	48	30	1	38.0	0.83
Double straight front						
L-W5S0-3523-D	467	35	23	1	30.0	0.47
L-W5S0-4123-D	556	41	23	1	33.0	0.55
L-W5S0-4723-D	667	47	23	1	36.0	0.63
L-W5S0-4129-D	556	41	29	1	35.0	0.69
L-W5S0-4729-D	667	47	29	1	38.0	0.79

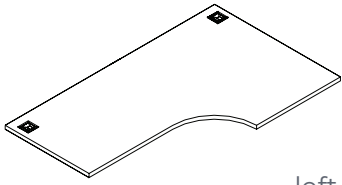

left hand shown
with grommet

What's Included:

One (1) worksurface, Two(2) grommets

How to Specify:

Refer to laminate card for laminate options

Notes:

Surface has a curved front

Options:

Side A: 36"

Side B: 24"

Side C: 54", 60", 66", 72", 78", 84", 90", 96"

Thickness: 1"

Left Hand, Right Hand

Grommet Type & Color: Square (Silver, Black, White), Oval (Silver, Black)

Code	Price	Height	Depth	Thickness	Weight (lb.)	Volume (ft ³)
Left hand with grommet						
L-WUCG-543624-L	627	54	36	1	24.9	1.12
L-WUCG-603624-L	661	60	36	1	26.9	1.25
L-WUCG-663624-L	734	66	36	1	28.9	1.38
L-WUCG-723624-L	778	72	36	1	30.9	1.50
L-WUCG-783624-L	838	78	36	1	32.9	1.62
L-WUCG-843624-L	899	84	36	1	34.9	1.75
L-WUCG-903624-L	1032	90	36	1	36.9	1.88
L-WUCG-963624-L	1088	96	36	1	38.9	2.00
Right hand with grommet						
L-WUCG-543624-R	627	54	36	1	24.9	1.12
L-WUCG-603624-R	661	60	36	1	26.9	1.25
L-WUCG-663624-R	734	66	36	1	28.9	1.38
L-WUCG-723624-R	778	72	36	1	30.9	1.50
L-WUCG-783624-R	838	78	36	1	32.9	1.62
L-WUCG-843624-R	899	84	36	1	34.9	1.75
L-WUCG-903624-R	1032	90	36	1	36.9	1.88
L-WUCG-963624-R	1088	96	36	1	38.9	2.00

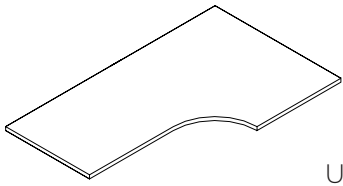

Unitized Worksurface with 1" Wire Play

What's Included:

One (1) worksurface

How to Specify:

Refer to laminate card for laminate options

Notes:

Worksurface sits 1" from the panel to allow for wire routing. No grommet is included with this worksurface

Surface has a curved front

Options:

Side A: 53", 54", 59", 60", 65", 66", 71", 72", 77", 78", 83", 84", 89", 90", 95", 96"

Side B: 23", 24"

Side C: 35", 36"

Side D: 23", 24"

Code	Price	Height	Depth	Thickness	Weight (lb)	Volume (ft ³)
Left hand						
L-WUC0-543524-L	627	54	35	1	24.9	1.09
L-WUC0-603524-L	661	60	35	1	26.9	1.22
L-WUC0-663524-L	734	66	35	1	28.9	1.34
L-WUC0-723524-L	778	72	35	1	30.9	1.46
L-WUC0-783524-L	838	78	35	1	32.9	1.58
L-WUC0-843524-L	899	84	35	1	34.9	1.70
L-WUC0-903524-L	1032	90	35	1	36.9	1.82
L-WUC0-963524-L	1088	96	35	1	38.9	1.94
L-WUC0-533624-L	627	53	36	1	24.9	1.10
L-WUC0-593624-L	661	59	36	1	26.9	1.23
L-WUC0-653624-L	734	65	36	1	28.9	1.35
L-WUC0-713624-L	778	71	36	1	30.9	1.48
L-WUC0-773624-L	838	77	36	1	32.9	1.60
L-WUC0-833624-L	899	83	36	1	34.9	1.73
L-WUC0-893624-L	1032	89	36	1	36.9	1.85

Code	Price	Height	Depth	Thickness	Weight (lb)	Volume (ft ³)
L-WUC0-953624-L	1088	95	36	1	38.9	1.98
L-WUC0-533523-L	627	53	35	1	24.9	1.07
L-WUC0-593523-L	661	59	35	1	26.9	1.20
L-WUC0-653523-L	734	65	35	1	28.9	1.32
L-WUC0-713523-L	778	71	35	1	30.9	1.44
L-WUC0-773523-L	838	77	35	1	32.9	1.56
L-WUC0-833523-L	899	83	35	1	34.9	1.68
L-WUC0-893523-L	1032	89	35	1	36.9	1.80
L-WUC0-953523-L	1088	95	35	1	38.9	1.92
Right hand						
L-WUC0-543524-R	627	54	35	1	24.9	1.09
L-WUC0-603524-R	661	60	35	1	26.9	1.22
L-WUC0-663524-R	734	66	35	1	28.9	1.34
L-WUC0-723524-R	778	72	35	1	30.9	1.46
L-WUC0-783524-R	838	78	35	1	32.9	1.58
L-WUC0-843524-R	899	84	35	1	34.9	1.70
L-WUC0-903524-R	1032	90	35	1	36.9	1.82
L-WUC0-963524-R	1088	96	35	1	38.9	1.94
L-WUC0-533624-R	627	53	36	1	24.9	1.10
L-WUC0-593624-R	661	59	36	1	26.9	1.23
L-WUC0-653624-R	734	65	36	1	28.9	1.35
L-WUC0-713624-R	778	71	36	1	30.9	1.48
L-WUC0-773624-R	838	77	36	1	32.9	1.60
L-WUC0-833624-R	899	83	36	1	34.9	1.73
L-WUC0-893624-R	1032	89	36	1	36.9	1.85
L-WUC0-953624-R	1088	95	36	1	38.9	1.98
L-WUC0-533523-R	627	53	35	1	24.9	1.07
L-WUC0-593523-R	661	59	35	1	26.9	1.20
L-WUC0-653523-R	734	65	35	1	28.9	1.32
L-WUC0-713523-R	778	71	35	1	30.9	1.44
L-WUC0-773523-R	838	77	35	1	32.9	1.56
L-WUC0-833523-R	899	83	35	1	34.9	1.68
L-WUC0-893523-R	1032	89	35	1	36.9	1.80
L-WUC0-953523-R	1088	95	35	1	38.9	1.92

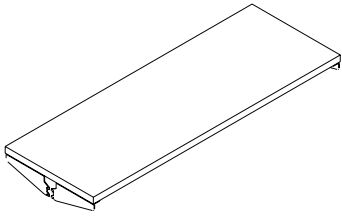

What's Included:

One (1) transaction top, Four (4) cantilever brackets

How to Specify:

Match the transaction top to the corresponding panel width

Refer to laminate card for laminate options

Choose White, Black, Silver, Charcoal for cantilever color

Notes:

Options:

Width: 24", 30", 36", 42", 48", 54", 60"

Depth: 15"

Thickness: 1"

Cantilever Paint Color: Silver, White, Black, Charcoal

Code	Price	H	W	D	Weight (lb.)	Volume (ft ³)
L-WTT-2415	286	24	15	1	5.8	0.21
L-WTT-3015	310	30	15	1	7.2	0.26
L-WTT-3615	324	36	15	1	8.6	0.31
L-WTT-4215	340	42	15	1	10.1	0.36
L-WTT-4815	356	48	15	1	11.5	0.42
L-WTT-5415	375	54	15	1	13.0	0.47
L-WTT-6015	387	60	15	1	14.4	0.52



Switch Canada Pricebook
June 2026

Supports

Ladder Gable	156
Standard Panel	156
Gallery Panel	158
Freestanding Panel	160
Laminate Gable	161
Standard Panel	161
Gallery Panel	162
Freestanding	163
Wrap Gable	164
Standard Panel	164
Gallery Panel	165
Tech Drop	166
Cantilever	167
Standard Panel	167
Gallery Panel	168
Standard Panel Mount Corner Bracket	170
Flush Plates	171
Storage Support Bracket	172
Fixed Credenza Support Bracket	173
90 Degree Storage Bracket	174
Horizontal Surface Support	175

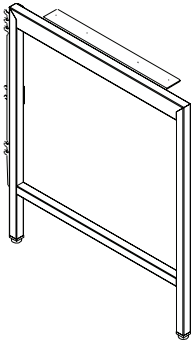

Standard Panel Ladder Gable

What's Included:

One (1) ladder gable, one (1) standard panel mount bracket, (1) surface to gable connector

How to Specify:

Choose White, Black, Silver, Charcoal for ladder gable colour

Notes:

Ladder Gable can be used with worksurface with grommet, worksurface without grommet, worksurface for 1" wire play

Mid gable is used at the surface joint

Options:

Heights*: 25", 28"

Depth: 20", 24", 30"

Ladder Gable Paint Colour:: Silver, White, Black, Charcoal

End gable: (Left hand, right hand) or mid gable

*25" high to be used to Tech Drop surface

Code	Price	H	W	D	Weight (lb.)	Volume (ft ³)
Left hand						
L-HOEG-P-2520-L	521	25	20	2	10.0	0.58
L-HOEG-P-2524-L	526	25	24	2	12.0	0.69
L-HOEG-P-2530-L	565	25	30	2	15.0	0.87
L-HOEG-P-2820-L	529	28	20	2	11.2	0.65
L-HOEG-P-2824-L	533	28	24	2	13.4	0.78
L-HOEG-P-2830-L	577	28	30	2	16.8	0.97
Right hand						
L-HOEG-P-2520-R	521	25	20	2	10.0	0.58
L-HOEG-P-2524-R	526	25	24	2	12.0	0.69
L-HOEG-P-2530-R	565	25	30	2	15.0	0.87
L-HOEG-P-2820-R	529	28	20	2	11.2	0.65
L-HOEG-P-2824-R	533	28	24	2	13.4	0.78
Mid						
L-HOMG-P-2520	521	25	20	2	10.0	0.58
L-HOMG-P-2524	526	25	24	2	12.0	0.69
L-HOMG-P-2530	565	25	30	2	15.0	0.87
L-HOMG-P-2820	529	28	20	2	11.2	0.65
L-HOMG-P-2824	533	28	24	2	13.4	0.78
L-HOMG-P-2830	577	28	30	2	16.8	0.97

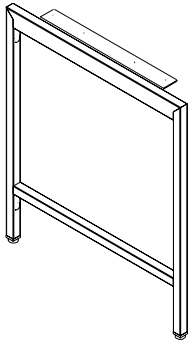

Gallery Panel Ladder Gable

What's Included:

One (1) ladder gable, one (1) gallery panel mount bracket, (1) surface to gable connector

How to Specify:

Choose White, Black, Silver, Charcoal for ladder gable colour

Notes:

Ladder Gable can be used with worksurface with grommet, worksurface without grommet, worksurface for 1" wire play

Mid gable is used at the surface joint

Options:

Heights*: 25", 28"

Depth: 20", 24", 30"

Ladder Gable Paint Colour:: Silver, White, Black, Charcoal

End gable: (Left hand, right hand) or mid gable

*25" high to be used to Tech Drop surface

Code	Price	H	W	D	Weight (lb.)	Volume (ft ³)
Left hand						
L-HOEG-Y-2520-L	521	25	20	2	10.0	0.58
L-HOEG-Y-2524-L	526	25	24	2	12.0	0.69
L-HOEG-Y-2530-L	565	25	30	2	15.0	0.87
L-HOEG-Y-2820-L	529	28	20	2	11.2	0.65
L-HOEG-Y-2824-L	533	28	24	2	13.4	0.78
L-HOEG-Y-2830-L	577	28	30	2	16.8	0.97
Right hand						
L-HOEG-Y-2520-R	521	25	20	2	10.0	0.58
L-HOEG-Y-2524-R	526	25	24	2	12.0	0.69
L-HOEG-Y-2530-R	565	25	30	2	15.0	0.87
L-HOEG-Y-2820-R	529	28	20	2	11.2	0.65
L-HOEG-Y-2824-R	533	28	24	2	13.4	0.78
L-HOEG-Y-2830-R	577	28	30	2	16.8	0.97
Mid						
L-HOMG-Y-2520	521	25	20	2	10.0	0.58
L-HOMG-Y-2524	526	25	24	2	12.0	0.69
L-HOMG-Y-2530	565	25	30	2	15.0	0.87
L-HOMG-Y-2820	529	28	20	2	11.2	0.65
L-HOMG-Y-2824	533	28	24	2	13.4	0.78
L-HOMG-Y-2830	577	28	30	2	16.8	0.97

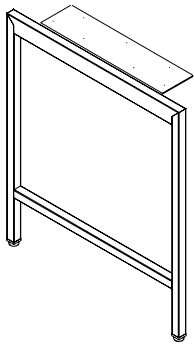

Freestanding

What's Included:

One (1) 90 degree bracket

How to Specify:

Available in black only

Notes:

90 degree bracket is used to connect a worksurface to a gallery panel

Options:

Heights*: 25", 28"

Depth: 20", 24", 30"

Ladder Gable Paint Colour:: Silver, White, Black, Charcoal

End gable: (Left hand, right hand)

*25" high to be used to Tech Drop surface

Code	Price	H	W	D	Weight (lb.)	Volume (ft ³)
Freestanding						
L-HOEG-S-2520	521	25	20	2	10.0	0.58
L-HOEG-S-2524	526	25	24	2	12.0	0.69
L-HOEG-S-2530	565	25	30	2	15.0	0.87
L-HOEG-S-2820	529	28	20	2	11.2	0.65
L-HOEG-S-2824	533	28	24	2	13.4	0.78
L-HOEG-S-2830	577	28	30	2	16.8	0.97

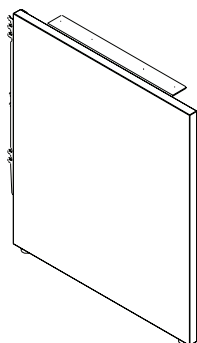

Standard Panel
Laminate Gable

What's Included:

One (1) ladder gable, one (1) standard panel mount bracket, (1) surface to gable connector

How to Specify:

Laminate Gable Paint Colour: Silver, White, Black, Charcoal

Laminate Gable Laminate Colour: Refer to laminate card for laminate options

End gable (Left hand, right hand)

Notes:

Ladder Gable can be used with worksurface with grommet, worksurface without grommet, worksurface for 1" wire play

Options:

Heights*: 25", 28"

Depth: 20", 24", 30"

*25" high to be used to Tech Drop surface

Code	Price	H	W	D	Weight (lb.)	Volume (ft ³)
Left hand						
L-HCEG-P-2520-L	244	25	20	2	10.0	0.58
L-HCEG-P-2524-L	268	25	24	2	12.0	0.69
L-HCEG-P-2530-L	287	25	30	2	15.0	0.87
L-HCEG-P-2812-L	230	28	12	2	10.0	0.39
L-HCEG-P-2820-L	257	28	20	2	11.2	0.65
L-HCEG-P-2824-L	275	28	24	2	13.4	0.78
L-HCEG-P-2830-L	302	28	30	2	16.8	0.97
Right hand						
L-HCEG-P-2520-R	244	25	20	2	10.0	0.58
L-HCEG-P-2524-R	268	25	24	2	12.0	0.69
L-HCEG-P-2530-R	287	25	30	2	15.0	0.87
L-HCEG-P-2812-R	230	28	12	2	10.0	0.39
L-HCEG-P-2820-R	257	28	20	2	11.2	0.65
L-HCEG-P-2824-R	275	28	24	2	13.4	0.78
L-HCEG-P-2830-R	302	28	30	2	16.8	0.97

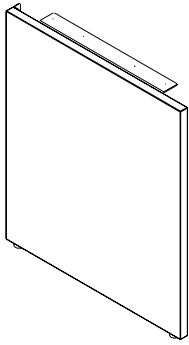

Gallery Panel
Laminate Gable

What's Included:

One (1) ladder gable, one (1) gallery panel mount bracket,
(1) surface to gable connector

How to Specify:

Laminate Gable Paint Colour: Silver, White, Black, Charcoal

Laminate Gable Laminate Colour: Refer to laminate card
for laminate options

End gable (Left hand, right hand)

Notes:

Ladder Gable can be used with
worksurface with grommet,
worksurface without grommet,
worksurface for 1" wire play

Options:

Heights*: 25", 28"

Depth: 20", 24", 30"

*25" high to be used to Tech Drop surface

Code	Price	H	W	D	Weight (lb.)	Volume (ft ³)
Left hand						
L-HCEG-Y-2520-L	237	25	20	2	10.0	0.58
L-HCEG-Y-2524-L	256	25	24	2	12.0	0.69
L-HCEG-Y-2530-L	281	25	30	2	15.0	0.87
L-HCEG-Y-2812-L	222	28	12	2	11.2	0.39
L-HCEG-Y-2820-L	244	28	20	2	11.2	0.65
L-HCEG-Y-2824-L	268	28	24	2	13.4	0.78
L-HCEG-Y-2830-L	295	28	30	2	16.8	0.97
Right hand						
L-HCEG-Y-2520-R	237	25	20	2	10.0	0.58
L-HCEG-Y-2524-R	256	25	24	2	12.0	0.69
L-HCEG-Y-2530-R	281	25	30	2	15.0	0.87
L-HCEG-Y-2812-R	222	28	12	2	11.2	0.39
L-HCEG-Y-2820-R	244	28	20	2	11.2	0.65
L-HCEG-Y-2824-R	268	28	24	2	13.4	0.78
L-HCEG-Y-2830-R	295	28	30	2	16.8	0.97

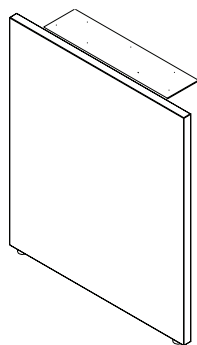

Freestanding Laminate Gable

What's Included:

One (1) ladder gable, (1) surface to gable connector

How to Specify:

Laminate Gable Paint Colour: Silver, White, Black, Charcoal

Laminate Gable Laminate Colour: Refer to laminate card for laminate options

Notes:

Laminate Gable can be used with worksurface with grommet, worksurface without grommet, worksurface for 1" wire play

Freestanding gable is used when one side of the surface is connected to a panel and the other is open

Options:

Heights*: 25", 28"

Depth: 20", 24", 30"

*25" is used with the 20" deep surface

Code	Price	H	W	D	Weight (lb.)	Volume (ft ³)
L-HCEG-S-2520	257	25	20	2	10.0	0.58
L-HCEG-S-2524	273	25	24	2	12.0	0.69
L-HCEG-S-2530	300	25	30	2	15.0	0.87
L-HCEG-S-2820	268	28	20	2	11.2	0.65
L-HCEG-S-2824	286	28	24	2	13.4	0.78
L-HCEG-S-2830	312	28	30	2	16.8	0.97

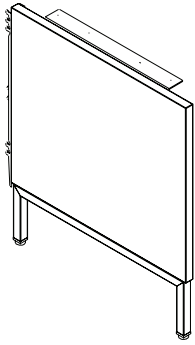

Standard Panel
Wrap Laminate Gable

What's Included:

One (1) wrap gable, one (1) standard panel mount bracket,
(1) surface to gable connector

How to Specify:

Laminate Gable Paint Colour: Silver, White, Black, Charcoal

Laminate Gable Laminate Colour: Refer to laminate card for laminate options

End gable (Left hand, right hand)

Notes:

Laminate Gable can be used with worksurface with grommet, worksurface without grommet, worksurface for 1" wire play

Freestanding gable is used when one side of the surface is connected to a panel and the other is open

Options:

Heights*: 25", 28"

Depth: 20", 24", 30"

*25" high to be used to Tech Drop surface

Code	Price	H	W	D	Weight (lb.)	Volume (ft ³)
Left hand						
L-HWEG-P-2520-L	474	25	20	2	10.0	0.58
L-HWEG-P-2524-L	492	25	24	2	12.0	0.69
L-HWEG-P-2530-L	540	25	30	2	15.0	0.87
L-HWEG-P-2820-L	491	28	20	2	11.2	0.65
L-HWEG-P-2824-L	502	28	24	2	13.4	0.78
L-HWEG-P-2830-L	555	28	30	2	16.8	0.97
Right hand						
L-HWEG-P-2520-R	474	25	20	2	10.0	0.58
L-HWEG-P-2524-R	492	25	24	2	12.0	0.69
L-HWEG-P-2530-R	540	25	30	2	15.0	0.87
L-HWEG-P-2820-R	491	28	20	2	11.2	0.65
L-HWEG-P-2824-R	502	28	24	2	13.4	0.78
L-HWEG-P-2830-R	555	28	30	2	16.8	0.97

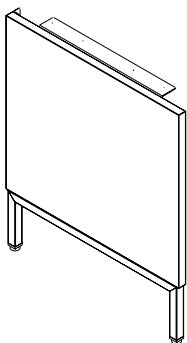

Gallery Panel
Wrap Laminate Gable

What's Included:

One (1) wrap gable, one (1) gallery panel mount bracket, (1) surface to gable connector

How to Specify:

Laminate Gable Paint Colour: Silver, White, Black, Charcoal
 Laminate Gable Laminate Colour: Refer to laminate card for laminate options
 End gable (Left hand, right hand)

Notes:

Laminate Gable can be used with worksurface with grommet, worksurface without grommet, worksurface for 1" wire play

Freestanding gable is used when one side of the surface is connected to a panel and the other is open

Options:

Heights*: 25", 28"

Depth: 20", 24", 30"

*25" high to be used to Tech Drop surface

Code	Price	H	W	D	Weight (lb.)	Volume (ft ³)
Left hand						
L-HWEG-Y-2520-L	474	25	20	2	10.0	0.58
L-HWEG-Y-2524-L	492	25	24	2	12.0	0.69
L-HWEG-Y-2530-L	540	25	30	2	15.0	0.87
L-HWEG-Y-2820-L	491	28	20	2	11.2	0.65
L-HWEG-Y-2824-L	502	28	24	2	13.4	0.78
L-HWEG-Y-2830-L	557	28	30	2	16.8	0.97
Right hand						
L-HWEG-Y-2520-R	474	25	20	2	10.0	0.58
L-HWEG-Y-2524-R	492	25	24	2	12.0	0.69
L-HWEG-Y-2530-R	540	25	30	2	15.0	0.87
L-HWEG-Y-2820-R	491	28	20	2	11.2	0.65
L-HWEG-Y-2824-R	502	28	24	2	13.4	0.78
L-HWEG-Y-2830-R	557	28	30	2	16.8	0.97

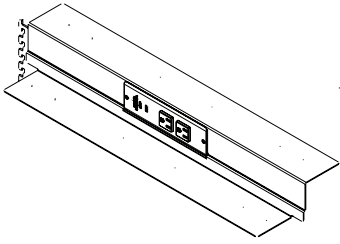

Standard Panel Tech Drop

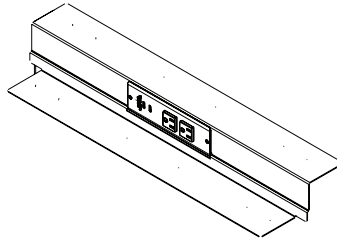

Gallery Panel Tech Drop

What's Included:

One (1) tech drop, one (1) power module with two (2) AC outlets and two (2) USB-A outlets, one (1) panel connector hardware

How to Specify:

Choose White, Black, Silver, Charcoal for Tech Drop

Left, right

Notes:

Tech drop offers a 3" drop between main surface and return surface

Tech drop must be mounted to the panel

Options:

Heights: 3"

Depth*: 19", 23"

*19" is used with the 20" deep surface

Code	Price	H	W	D	Weight (lb.)	Volume (ft ³)
Standard Panel Tech Drop - left hand						
L-HSSE-P-19-L	455	3	19.875	4	6.3	0.14
L-HSSE-P-23-L	465	3	23.875	4	7.7	0.17
Standard Panel Tech Drop - right hand						
L-HSSE-P-19-R	455	3	19.875	4	6.3	0.14
L-HSSE-P-23-R	465	3	23.875	4	7.7	0.17
Gallery Panel Tech Drop - left hand						
L-HSSE-Y-19-L	459	3	19.875	4	6.3	0.14
L-HSSE-Y-23-L	468	3	23.875	4	7.7	0.17
Gallery Panel Tech Drop - right hand						
L-HSSE-Y-19-R	459	3	19.875	4	6.3	0.14
L-HSSE-Y-23-R	468	3	23.875	4	7.7	0.17

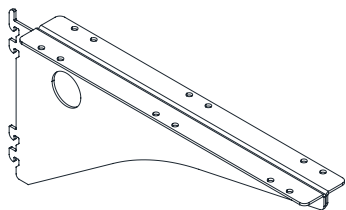

Standard Panel Mounted Cantilever Arm

What's Included:

One (1) standard panel mounted cantilever arm

How to Specify:

Left, right, mid

Notes:

Cantilever available in black only

Options:

Depth: 16", 22"

Code	Price	H	W	D	Weight (lb.)	Volume (ft ³)
intermediate						
L-CCAB-P-16	48	8	16	2	2.6	0.15
L-CCAB-P-22	85	8	22	2	3.5	0.21
left hand						
L-CCAB-P-16-L	48	8	16	1.5	1.9	0.11
L-CCAB-P-22-L	85	8	22	1.5	2.6	0.15
right hand						
L-CCAB-P-16-R	48	8	16	1.5	1.9	0.11
L-CCAB-P-22-R	85	8	22	1.5	2.6	0.15

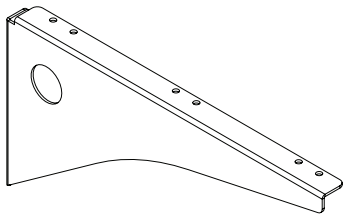

Gallery Panel Mounted
Cantilever Arm

What's Included:

One (1) gallery panel mounted cantilever arm

How to Specify:

Left, right, mid

Notes:

Cantilever available in black only

Options:

Depth: 16", 22"

Code	Price	H	W	D	Weight (lb.)	Volume (ft ³)
intermediate						
L-CCAB-Y-16	48	8	16	2	2.6	0.15
L-CCAB-Y-22	85	8	22	2	3.5	0.21
left hand						
L-CCAB-Y-16-L	48	8	16	1.5	1.9	0.11
L-CCAB-Y-22-L	85	8	22	1.5	2.6	0.15
right hand						
L-CCAB-Y-16-R	48	8	16	1.5	1.9	0.11
L-CCAB-Y-22-R	85	8	22	1.5	2.6	0.15

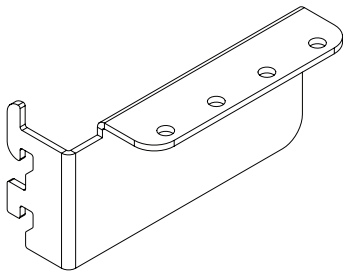

L-HCB
left hand shown

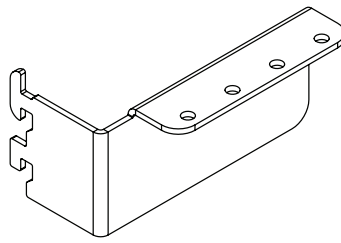

L-HCB1
left hand shown

What's Included:

One (1) standard panel mounted corner bracket

How to Specify:

Left, right

Full depth surface, surface with 1" wire play

Notes:

Worksurface with 1" wire play requires 1" offset bracket

Corner bracket available in black only

Options:

Code	Price	H	W	D	Weight (lb.)	Volume (ft ³)
L-HCB-P-L	9	3	4	2	0.1	0.01
L-HCB1-P-L	21	3	4	2	0.1	0.01
L-HCB-P-R	9	3	4	2	0.1	0.01
L-HCB1-P-R	21	3	4	2	0.1	0.01

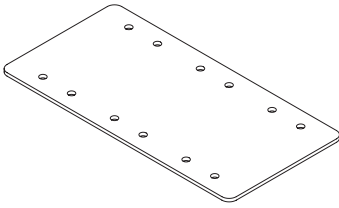

What's Included:

One (1) flush plate

How to Specify:

Flush Plate Paint Colour: Silver only

Notes:

Flush plate is used at surface joint to connect two surfaces together

Options:

Width: 5.5"

Depth: 3"

Code	Price	H	W	D	Weight (lb.)	Volume (ft ³)
L-PWW	48	3	5.5	0.125	1.0	0.00

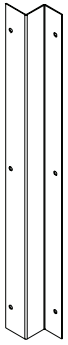

for standard panel

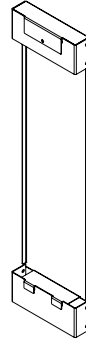

for gallery panel

What's Included:

panel to storage support bracket

How to Specify:

Available in white, black, charcoal, and silver

Notes:

Storage support bracket is used to connect off-modular storage to a surface

24" bracket is used to close 1" gap between storage and panel

30" bracket is used to close 7" gap between storage and panel

Options:

Width: 1", 7"

Code	Price	H	W	Weight (lb.)	Volume (ft ³)
for standard panel - left hand					
L-HPSP-24-L	68	28	1	8.6	0.39
L-HPSP-30-L	121	28	1	10.7	0.49
for standard panel -right hand					
L-HPSP-24-R	68	28	1	8.6	0.39
L-HPSP-30-R	121	28	1	10.7	0.49
for gallery panel					
L-HPGP-24	89	28	1	8.6	0.39
L-HPGP-30	168	2828	1	10.7	0.49

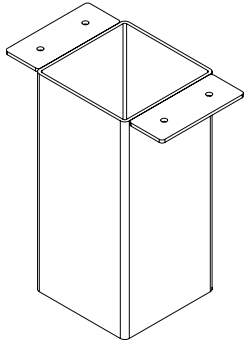

What's Included:

One (1) 90 degree bracket

How to Specify:

Flush Plate Paint Colour: Silver, White, Black, Charcoal

Notes:

Options:

Height: 6"

Width: 4"

Depth: 4"

Code	Price	H	W	D	Weight (lb.)	Volume (ft ³)
L-HCFM6	201	6.375	7	4	6.0	0.14

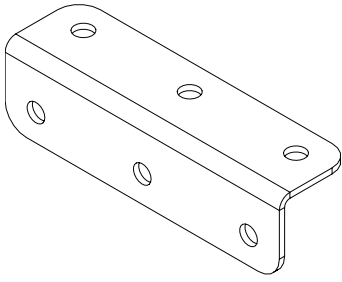

What's Included:

One (1) 90 degree bracket

How to Specify:

Available in black only

Notes:

90 degree bracket is used to connect a worksurface to a gallery panel

24" deep surface: two (2) brackets
 30" deep surface: three (3) brackets

Options:

Depth: 3"

Code	Price	Specifications	Weight (lb.)	Volume (ft ³)
L-HSSB	3	3", 6 Holes	0.5	0.09
L-HSSB-24	9	For 24"Deep	2.2	0.09
L-HSSB-30	16	For 30"Deep	3.0	0.09

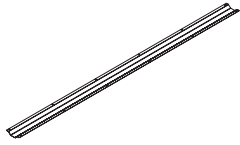

What's Included:

Horizontal Surface Support, installation hardware.

How to Specify:

The horizontal surface support is available only in silver.

Notes:

The horizontal surface support is used to support worksurfaces 54-inches and longer.

This item is mounted to the underside of a worksurface.

Options:

width 51, 57, 63, 69, 75

Code	Price	W (in)	Weight (lb)	Volume (ft ³)
L-CH00-54	81	51	4.0	0.05
L-CH00-60	87	57	4.5	0.05
L-CH00-66	94	63	5.0	0.06
L-CH00-72	98	69	5.5	0.06
L-CH00-78	104	75	6.0	0.07



Switch Canada Pricebook
June 2026

Electrics

Power Module	178
Starter Harness	179
Connector Harness	180
Male to Female Extension Harness	182
New York Junction Box	183
Chicago Electrical Box	184
Power Pole	185
Communication Kit	186
Conversion Kit	187

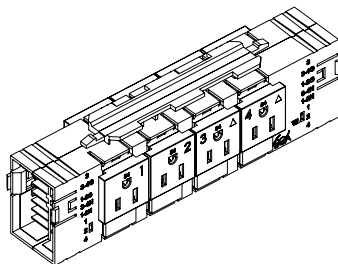
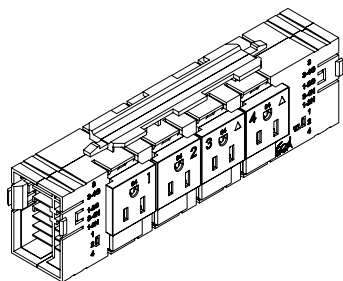

What's Included:

One (1) single power module with four (4) ac outlets or one (1) double sided power module with eight (8) ac outlets (four on each side)

How to Specify:

Available in grey only
Single sided, double sided

Notes:

Power modules are installed in the center cut out power capable panels only

Double sided power module has four (4) ac outlets on each side

Refer to Switch electrical specification guide for more information

Options:

Width: 8"

Code	Price	H	W	D	Weight (lb.)	Volume (ft ³)
single sided						
L-EM84-S	240	3	6	3	1.7	0.03
double sided						
L-EM84-D	350	3	6	3	2.0	0.03

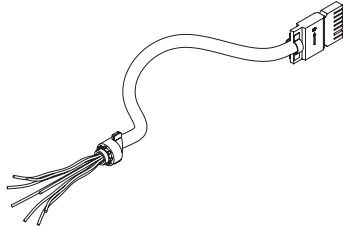

What's Included:

One (1) open wire starter harness

How to Specify:

Available in grey only

Single sided, double sided

Notes:

Switch electrical system is rated for 20 amps

Tayco recommends up to 8 workstations hardwired to one power source

Options:

Length: 72", 168"

Code	Price	L	D	Weight (lb.)	Volume (ft ³)
L-ES84-072-0	364	72	0.75	2.6	0.40
L-ES84-168-0	531	168	0.75	5.1	0.50

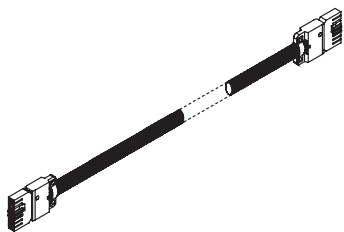

What's Included:

One (1) connector harness

How to Specify:

Available in grey only

Single sided, double sided

Notes:

Connector harness is used to connect two power modules together

Refer to installation guide for connector harness length calculation

Options:

Length: 22"-181" in 3" increments

Code	Price	Length	D	Weight (lb.)	Volume (ft ³)
L-EH84-22	198	22	0.75	0.6	0.20
L-EH84-25	208	25	0.75	0.7	0.20
L-EH84-28	214	28	0.75	0.8	0.20
L-EH84-31	222	31	0.75	0.8	0.20
L-EH84-34	230	34	0.75	0.9	0.20
L-EH84-37	234	37	0.75	1.0	0.20
L-EH84-40	240	40	0.75	1.1	0.20
L-EH84-43	244	43	0.75	1.2	0.20
L-EH84-46	257	46	0.75	1.3	0.20
L-EH84-49	263	49	0.75	1.5	0.20
L-EH84-52	269	52	0.75	1.5	0.20
L-EH84-55	275	55	0.75	1.6	0.20
L-EH84-58	283	58	0.75	1.7	0.20
L-EH84-61	288	61	0.75	1.8	0.20
L-EH84-64	296	64	0.75	1.9	0.20
L-EH84-67	304	67	0.75	1.9	0.20
L-EH84-70	317	70	0.75	2.0	0.20
L-EH84-73	325	73	0.75	2.0	0.20
L-EH84-76	330	76	0.75	2.0	0.20
L-EH84-79	339	79	0.75	2.1	0.20
L-EH84-82	346	82	0.75	2.1	0.20
L-EH84-85	352	85	0.75	2.4	0.20
L-EH84-88	358	88	0.75	2.4	0.20
L-EH84-91	363	91	0.75	2.4	0.20

Power & Data continued

Code	Price	Length	D	Weight (lb.)	Volume (ft ³)
L-EH84-94	373	94	0.75	2.5	0.20
L-EH84-97	379	97	0.75	2.5	0.20
L-EH84-100	385	100	0.75	2.7	0.20
L-EH84-103	390	103	0.75	2.7	0.20
L-EH84-106	400	106	0.75	2.9	0.20
L-EH84-109	402	109	0.75	2.9	0.20
L-EH84-112	409	112	0.75	3.0	0.20
L-EH84-115	421	115	0.75	3.0	0.20
L-EH84-118	426	118	0.75	3.2	0.20
L-EH84-121	429	121	0.75	3.4	0.20
L-EH84-124	439	124	0.75	3.4	0.20
L-EH84-127	446	127	0.75	3.5	0.20
L-EH84-130	453	130	0.75	3.5	0.20
L-EH84-133	460	133	0.75	3.4	0.20
L-EH84-136	467	136	0.75	3.7	0.20
L-EH84-139	472	139	0.75	3.9	0.20
L-EH84-142	649	142	0.75	3.9	0.20
L-EH84-145	655	145	0.75	3.9	0.20
L-EH84-148	665	148	0.75	3.9	0.20
L-EH84-151	669	151	0.75	4.2	0.20
L-EH84-154	679	154	0.75	4.3	0.20
L-EH84-157	686	157	0.75	4.4	0.20
L-EH84-160	692	160	0.75	4.4	0.20
L-EH84-163	698	163	0.75	4.5	0.20
L-EH84-166	706	166	0.75	4.6	0.20
L-EH84-169	711	169	0.75	4.7	0.20
L-EH84-172	717	172	0.75	4.8	0.20
L-EH84-175	725	175	0.75	4.8	0.20
L-EH84-178	734	178	0.75	4.9	0.20
L-EH84-181	738	181	0.75	5.0	0.20

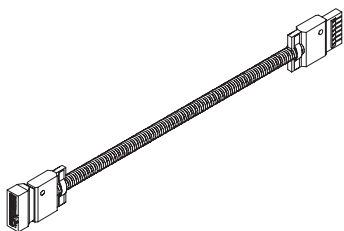

What's Included:

One (1) male to female extension harness

How to Specify:

Available in grey only
 Single sided, double sided

Options:

Length: 44", 122"

Notes:

Male to female extension harness is used to extend length of the starter harness

Code	Price	Length	D	Weight (lb.)
L-E8FM-044	275	44	0.75	0.3
L-E8FM-122	481	122	0.75	0.6

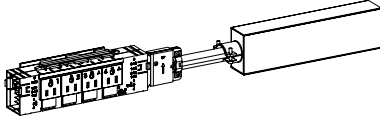

What's Included:

Panels 24", 30", 36" wide: One (1) New York junction box

Panels 42" or wider: One (1) New York junction box with single or double power module

How to Specify:

Panels 24", 30", 36" wide: Specify junction box without power module. Power module and starter harness must be specified speratley

Panels 42" or wider: Specify single or double power module with junction box

Notes:

Male to female extension harness is used to extend length of the starter harness

Options:

Junction Box width: 9"

Junction Box with power module width: 18"

Code	Price	Length	D	Weight (lb.)
L-NY84-004-D	826			
L-NY84-004-S	676			
L-NYEJ-84	234			

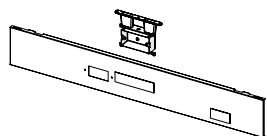

Single sided

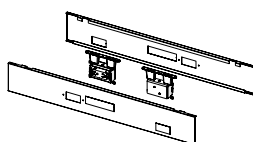

Double sided

What's Included:

Single Sided: One (1) electrical box with two (2) ac outlets and one (1) panel raceway

Double Sided: Two (2) single sided electrical boxes each with two (2) ac outlets and two (2) panel raceways

How to Specify:

Select corresponding size to match the panel width

Options:

Width: 30", 36", 42", 48", 54", 60", 72"

Notes:

Junction box is located on the left hand side of the panel

Code	Price	Length	W	Weight (lb.)
Single Sided				
L-JB0X-30-S	387	30		
L-JB0X-36-S	387	36		
L-JB0X-42-S	387	42		
L-JB0X-48-S	387	48		
L-JB0X-54-S	387	54		
L-JB0X-60-S	387	60		
Double Sided				
L-JB0X-30-D	773	30		
L-JB0X-36-D	773	36		
L-JB0X-42-D	773	42		
L-JB0X-48-D	773	48		
L-JB0X-54-D	773	54		
L-JB0X-60-D	773	60		

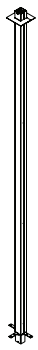

for 3 way connection(3W)

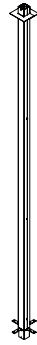

for 4 way connection(4W)



For 90 Degree Connection (N)

What's Included:

One (1) power pole, chosen mounting hardware

How to Specify:

Specify type based on panel connection: 90 degree, 3-way T, 4 way X and gallery panel mount

90 degree, 3-way T and 4-way X must be used with same height connecting panels

Use gallery panel mount type at the end of a run

Notes:

Options:

Connector type height: 96", 120"

Gallery panel height: 144"

Code	Price	H	W	D	Weight (lb.)	Volume (ft ³)
standard panel						
L-EP-P-120-3W	667	120	2	2	2.0	0.28
L-EP-P-120-4W	667	120	2	2	2.0	0.28
L-EP-P-120-N	667	120	2	2	2.0	0.28
L-EP-P-96-3W	581	96	2	2	1.5	0.22
L-EP-P-96-4W	581	96	2	2	1.5	0.22
L-EP-P-96-N	581	96	2	2	2.0	0.22
gallery panel						
L-EP-Y-144	800	144	2	2	2.0	0.33

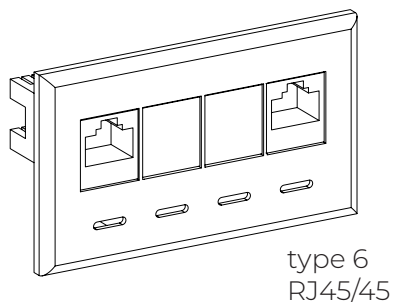
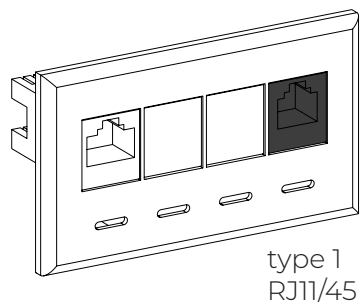

What's Included:

One (1) data plate with four (4) openings and chosen combination of RJ11/RJ45

How to Specify:

Specify RJ11 for phone connection

Specify RJ45 for data connection

Notes:

Data is placed on the right hand side of the cutout in the panel raceway

Options:

Panel cutout width: 2 3/4"

Panel cutout height: 1 3/8"

Code	Price	H	W	D	Weight (lb.)	Volume (ft ³)
type 1						
L-ECK1	306	2	4	1	0.2	0.00
type 6						
L-ECK6	263	2	4	1	0.2	0.00

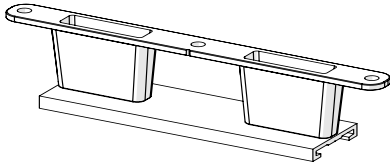

Non-Power Capable to Power Capable Panel Conversion Kit

What's Included:

One (1) power module mounting bracket

How to Specify:

Specify RJ11 for phone connection

Specify RJ45 for data connection

Notes:

Used to convert a non-power capable panel to a power capable panel

To be placed in the of the non-power capable panel raceway to convert to a power capable

Power module to be specified seperately

Options:

Code	Price	Weight (lb.)	Volume (ft ³)
RI-0300	27		



Switch Canada Pricebook
June 2026

Storage

Pedestals	190
Underdesk Pedestal	190
Mobile	191
Upholstered Seat Pad	192
Lateral File	193
Underdesk	193
Freestanding	194
Credenza	195
Open Lateral	195
Storage Tower	196
Wardrobe Tower	197
Combo Tower	198
w/ Front Access	198
w/ Side Access	200
Panel Mounted Overheads - Cabinet	202
Flipper	202
Hinged Door	203
Shared	204
Cubby	206
Metal Shelf	207

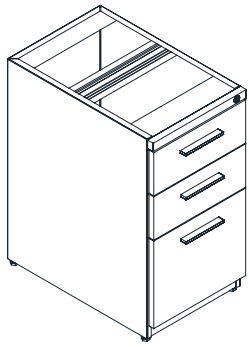

box/box/file

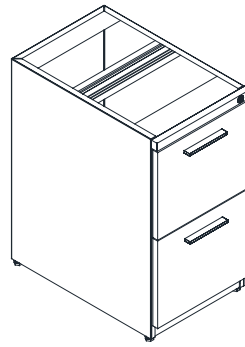

file/file

What's Included:

One (1) box/box/file or one (1) file/file underdesk pedestal

How to Specify:

Pedestal type: box/box/file, file/file

Notes:

Pedestal brackets must be ordered separately

Locks can be keyed alike or random

Options:

Height: 28"

Width: 16"

Depth: 23", 29"

Code	Price	H	W	D	Weight (lb.)	Volume (ft ³)
box/box/file						
L-FPBU-281623	1005	28	16	23	64.4	5.96
L-FPBU-281629	1173	28	16	29	81.2	7.52
file/file						
L-FPFU-281623	1005	28	16	23	64.4	5.96
L-FPFU-281629	1055	28	16	29	81.2	7.52

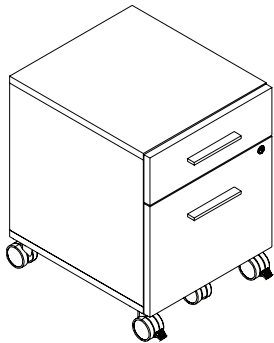

box/ file/no cushion

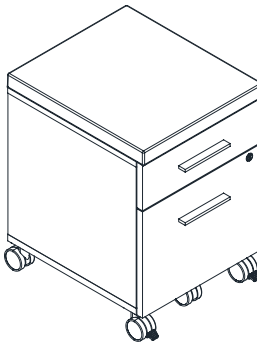

box/file w/ cushion

What's Included:

One (1) box/file mobile pedestal or one (1) box/file mobile pedestal with cushion, five (5) lockable casters

How to Specify:

- With or without cushion
- Refer to seating fabric card for cushion fabric selection
- Choose handle type and finish
- Choose depth
- Choose silver or white for caster finish

Notes:

Locks can be keyed alike or random

Options:

Height: 21" without cushion, 22" with cushion

Width: 16"

Depth: 18"

Code	Price	H	W	D	Weight (lb.)	Volume (ft ³)
box/file/no cushion						
L-FPL0-211618	1330	21	16	18	43.2	3.50
box/file w/ cushion						
L-FPLS-221618	1384	22	16	18	45.3	3.67

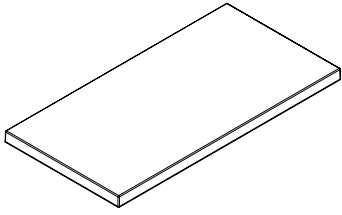

What's Included:

One (1) upholstered seat pad

How to Specify:

Refer to seating fabric card for fabric selection

Notes:

Options:

Height: 1"

Width: 24", 30", 36", 48", 60", 72"

Depth: 18"

Code	Price	H	W	D	Weight (lb.)	Volume (ft ³)
L-PAD-1824	422	1	24	18	2.4	0.67
L-PAD-1830	485	1	30	18	3.0	0.83
L-PAD-1836	557	1	36	18	3.6	1.00
L-PAD-1848	657	1	48	18	4.8	1.33
L-PAD-1860	761	1	60	18	6.0	1.67
L-PAD-1872	861	1	72	18	7.2	2.00

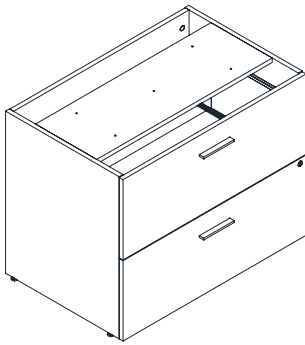

Lateral File lateral

What's Included:

One (1) two drawer underdesk lateral filing cabinet, each drawer is equipped with (2) bars for front to back filing

How to Specify:

Refer to laminate card for laminate selection

Choose handle type and finish

Choose depth

Notes:

Lateral brackets must be ordered separately

Locks can be keyed alike or random

Options:

Height: 28"

Width: 30", 36"

Depth: 23", 29"

Code	Price	H	W	D	Weight (lb.)	Volume (ft ³)
underdesk 2 Drawer						
L-FL2U-283023	2195	28	30	23	107.3	11.18
L-FL2U-283029	2231	28	30	29	135.3	14.10
L-FL2U-283623	2399	28	36	23	128.8	13.42
L-FL2U-283629	2437	28	36	29	162.4	16.92

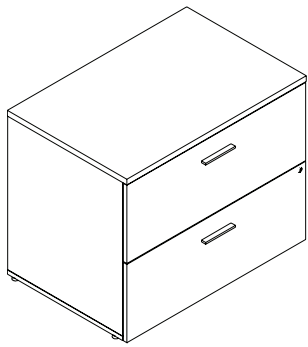

Lateral File
2 Drawer

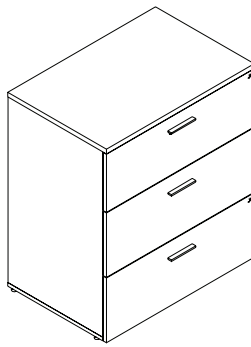

3 drawer

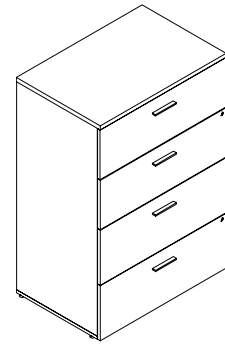

4 drawer

What's Included:

One (1) two drawer, three drawer or four drawer freestanding lateral filing cabinet with finished top, each drawer is equipped with (2) bars for front to back filing

How to Specify:

- Refer to laminate card for laminate selection
- Choose two drawer, three drawer or four drawers
- Choose handle type and finish
- Choose silver or white for caster finish

Notes:

Locks can be keyed alike or random

Options:

Height: 29" for 2 drawer, 42" for 3 drawer, 54" for 4 drawer

Width: 30", 36"

Depth: 24"

Code	Price	H	W	D	Weight (lb.)	Volume (ft ³)
2 Drawer						
L-FL2F-293024	2090	29	30	24	116.0	12.08
L-FL2F-293624	2090	29	36	24	139.2	14.50
3 drawer						
L-FL3F-423024	2237	42	30	24	168.0	17.50
L-FL3F-423624	2372	42	36	24	201.6	21.00
4 drawer						
L-FL4F-543024	2809	54	30	24	216.0	22.50
L-FL4F-543624	2976	54	36	24	259.2	27.00

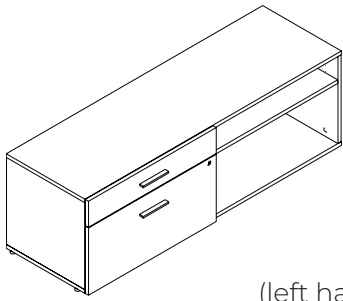

(left hand shown)

What's Included:

One (1) open lateral credenza, one (1) adjustable shelf for open cabinet

How to Specify:

- Choose right hand or left hand
- Refer to laminate card for laminate selection
- Choose handle type and finish

Notes:

- Locks can be keyed alike or random
- Right handed has lateral on right side
- Left handed has lateral on left side
- Can be used as a surface support credenza, with credenza fixed support specified separately

Options:

Height:	22"
Width:	48", 60", 72"
Depth:	18"

Code	Price	H	W	D	Weight (lb.)	Volume (ft ³)
Left hand						
L-CRCL-224818-L	1282	22	48	18	115.2	11.00
L-CRCL-226018-L	1404	22	60	18	144.0	13.75
L-CRCL-227218-L	1555	22	72	18	172.8	16.50
Right hand						
L-CRCL-224818-R	1282	22	48	18	115.2	11.00
L-CRCL-226018-R	1404	22	60	18	144.0	13.75
L-CRCL-227218-R	1555	22	72	18	172.8	16.50

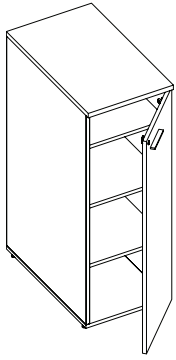

left hand shown

What's Included:

One (1) storage tower with one (1) adjustable shelf and (1) fixed shelf for 42" high or two (2) adjustable shelves and (1) fixed shelf for 50" high

How to Specify:

- Choose right hand or left hand
- Refer to laminate card for laminate selection
- Choose handle type and finish

Notes:

- Locks can be keyed alike or random
- Right handed has hinge on right side
- Left handed has hinge on left side

Options:

Height:	42", 50"
Width:	18"
Depth:	24", 30"

Code	Price	H	W	D	Weight (lb.)	Volume (ft ³)
Left hand						
L-FTSS-421824-L	1644	42	18	24	86.4	10.50
L-FTSS-421830-L	1673	42	18	30	108.0	13.13
L-FTSS-501824-L	1673	50	18	24	102.9	12.50
L-FTSS-501830-L	1691	50	18	30	128.6	15.63
Right hand						
L-FTSS-421824-R	1644	42	18	24	86.4	10.50
L-FTSS-421830-R	1673	42	18	30	108.0	13.13
L-FTSS-501824-R	1673	50	18	24	102.9	12.50
L-FTSS-501830-R	1691	50	18	30	128.6	15.63

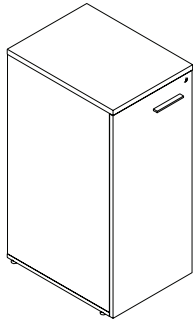

left hand shown

What's Included:

One (1) wardrobe tower, one (1) coat bar

How to Specify:

- Choose right hand or left hand
- Refer to laminate card for laminate selection
- Choose handle type and finish

Notes:

- Locks can be keyed alike or random
- Right handed has hinge on right side
- Left handed has hinge on left side

Options:

Height:	42", 50"
Width:	18"
Depth:	24", 30"

Code	Price	H	W	D	Weight (lb.)	Volume (ft ³)
Left hand						
L-FTCS-421824-L	1273	42	18	24	86.4	10.50
L-FTCS-421830-L	1358	42	18	30	108.0	13.13
L-FTCS-501824-L	1407	50	18	24	102.9	12.50
L-FTCS-501830-L	1524	50	18	30	128.6	15.63
Right hand						
L-FTCS-421824-R	1273	42	18	24	86.4	10.50
L-FTCS-421830-R	1358	42	18	30	108.0	13.13
L-FTCS-501824-R	1407	50	18	24	102.9	12.50
L-FTCS-501830-R	1524	50	18	30	128.6	15.63

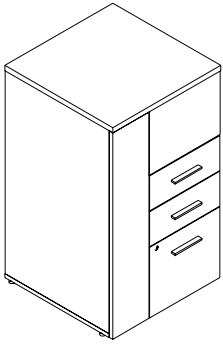

Combo Tower(left hand shown)

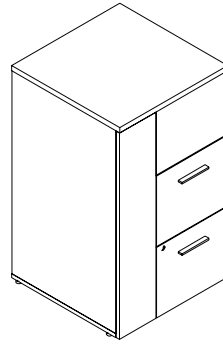

Combo Tower
(left hand shown)

What's Included:

- One (1) combo tower with front access,
- one (1) coat bar,
- one (1) box/box/file or one(1) file/file drawers,
- one(1) cubby for 42" high or two (2) cubbies for 50" high

How to Specify:

- Choose right hand or left hand
- Refer to laminate card for laminate selection
- Choose handle type and finish
- Choose box/box/file, file/file drawers

Notes:

- Locks can be keyed alike or random
- Right handed has door on right side
- Left handed has door on left side

Options:

Height: 42", 50"

Width: 24"

Depth: 24", 30"

Code	Price	H	W	D	Weight (lb.)	Volume (ft ³)
box/box/file pedestal -left hand						
L-CWTB-422424-L	2802	42	24	24	127.0	14.00
L-CWTB-422430-L	2814	42	24	30	159.0	18.00
L-CWTB-502424-L	2814	50	24	24	152.0	17.00
L-CWTB-502430-L	2825	50	24	30	189.0	21.00
box/box/file pedestal - right hand						
L-CWTB-422424-R	2802	42	24	24	127.0	14.00
L-CWTB-422430-R	2814	42	24	30	159.0	18.00
L-CWTB-502424-R	2814	50	24	24	152.0	17.00
L-CWTB-502430-R	2825	50	24	30	189.0	21.00
file/file pedestal - left hand						
L-CWTF-422424-L	2697	42	24	24	127.0	14.00
L-CWTF-422430-L	2697	42	24	30	159.0	18.00
L-CWTF-502424-L	2697	50	24	24	152.0	17.00
L-CWTF-422430-L	2697	42	24	30	159.0	18.00
file/file pedestal - right hand						
L-CWTF-422424-R	2697	42	24	24	127.0	14.00
L-CWTF-422430-R	2697	42	24	30	159.0	18.00
L-CWTF-502424-R	2697	50	24	24	152.0	17.00
L-CWTF-502430-R	2697	50	24	30	189.0	21.00

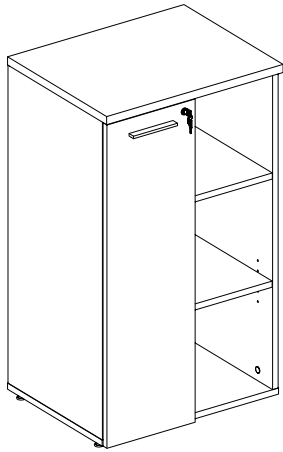

left hand shown

What's Included:

- One (1) combo tower with side access,
- one (1) coat bar,
- one (1) adjustable shelf and
- one (1) fixed shelf for 42" high or two (2) adjustable shelves and (1) fixed shelf for 50" high

How to Specify:

Choose right hand or left hand
Refer to laminate card for laminate selection
Choose handle type and finish
Choose box/box/file, file/file drawers

Notes:

Locks can be keyed alike or random
Right handed has door on right side
Left handed has door on left side

Options:

Height: 42", 50"

Width: 24"

Depth: 18.75", 24", 30"

Code	Price	H	W	D	Weight (lb.)	Volume (ft ³)
Left Hand						
L-FTCO-422418-L	1655	41	24	18.75	85.0	11.00
L-FTCO-422424-L	1834	41	24	24	101.0	14.00
L-FTCO-422430-L	2060	41	24	30	121.0	17.00
L-FTCO-502418-L	1904	49	24	18.75	97.0	13.00
L-FTCO-502424-L	2116	49	24	24	115.0	16.00
L-FTCO-502430-L	2376	49	24	30	138.0	21.00
Right hand						
L-FTCO-422418-R	1655	41	24	18.75	85.0	11.00
L-FTCO-422424-R	1834	41	24	24	101.0	14.00
L-FTCO-422430-R	2060	41	24	30	121.0	17.00
L-FTCO-502418-R	1904	49	24	18.75	97.0	13.00
L-FTCO-502424-R	2116	49	24	24	115.0	16.00

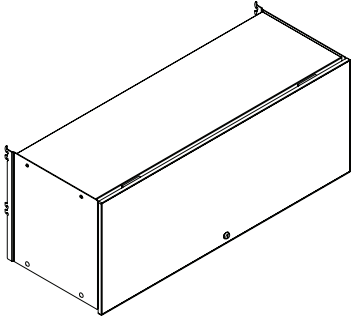

What's Included:

One (1) flipper cabinet

How to Specify:

Choose metal or laminate face

Choose white, black, silver, charcoal for metal face and body

Refer to laminate card for laminate face options

Notes:

Locks can be keyed alike or random

Flipper cabinet slides are easy-down pneumatic

Options:

Height*: 16"

Width: 30", 36", 42", 48", 54", 60"

Depth**: 15"

* Internal cabinet height is 13"

** Internal cabinet depth is 13"

Code	Price	H	W	D	Weight (lb.)	Volume (ft ³)
laminate face w/pneumatic slides						
L-SPFL-1530-P	1475	16	30	15	32.7	4.17
L-SPFL-1536-P	1559	16	36	15	39.3	5.00
L-SPFL-1542-P	1638	16	42	15	45.8	5.83
L-SPFL-1548-P	1720	16	48	15	52.4	6.67
L-SPFL-1554-P	1797	16	54	15	58.9	7.50
L-SPFL-1560-P	1879	16	60	15	65.5	8.33
metal face w/pneumatic slides						
L-SPFM-1530-P	1592	16	30	15	32.7	4.17
L-SPFM-1536-P	1674	16	36	15	39.3	5.00
L-SPFM-1542-P	1755	16	42	15	45.8	5.83
L-SPFM-1548-P	1837	16	48	15	52.4	6.67
L-SPFM-1554-P	1917	16	54	15	58.9	7.50
L-SPFM-1560-P	1998	16	60	15	65.5	8.33

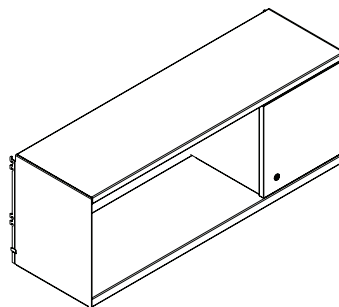
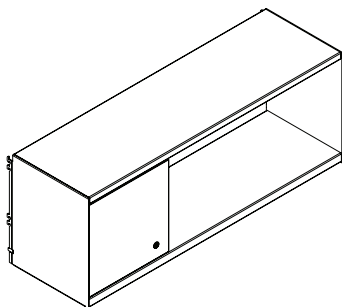

What's Included:

One (1) hinged cabinet, one (1) 12" wide hinged door

How to Specify:

Choose white, black, silver, charcoal for metal body

Refer to laminate card for laminate face options

Door on right or left side

Notes:

Locks can be keyed alike or random

OL refers to open on left side

LO refers to open on right side

Options:

Height*: 16"

Width: 36", 42", 48", 54", 60"

Depth**: 12"

* Internal cabinet height is 13"

** Internal cabinet depth is 12"

Code	Price	H	W	D	Weight (lb.)	Volume (ft ³)
closed/open						
L-SPLO-1536	1117	16	36	15	43.2	5.00
L-SPLO-1542	1189	16	42	15	50.4	5.83
L-SPLO-1548	1218	16	48	15	57.6	6.67
L-SPLO-1554	1295	16	54	15	64.8	7.50
L-SPLO-1560	1319	16	60	15	72.0	8.33
open/closed						
L-SPOL-1536	1117	16	36	15	43.2	5.00
L-SPOL-1542	1189	16	42	15	50.4	5.83
L-SPOL-1548	1218	16	48	15	57.6	6.67
L-SPOL-1554	1295	16	54	15	64.8	7.50
L-SPOL-1560	1319	16	60	15	72.0	8.33

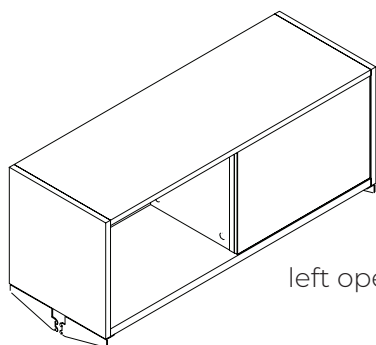

left open/right tackboard

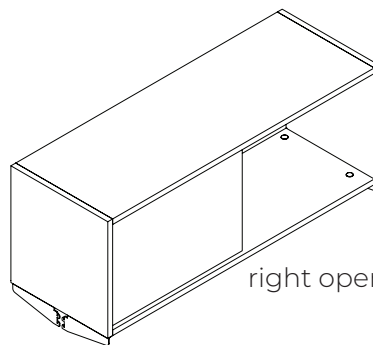

right open/ left melamine

What's Included:

One (1) shared cabinet, (1) tackboard if tackboard option is selected, four (4) panel mount cantilevers for up to 60"W or six (6) panel mount cantilevers for 66", 72"W

How to Specify:

Choose white, black, silver, charcoal for cantilever
 Refer to laminate card for laminate face options
 Refer to panel fabric card for tackboard fabric options

Notes:

OM refers to open on left side
 MO refers to open on right side
 OT refers to open on left side with tackboard on right side
 TO refers to open on right side with tackboard on left side

Options:

Height*: 16"

Width: 36", 42", 48", 54", 60", 66", 72"

Depth**: 15"

* Internal cabinet height is 13" ** Internal cabinet depth is 13.5"

Code	Price	H	W	D	Weight (lb.)	Volume (ft ³)
left open/right tackboard						
L-STOT-161536	962	16	36	15	43.2	5.00
L-STOT-161542	1024	16	42	15	50.4	5.83
L-STOT-161548	1091	16	48	15	57.6	6.67
L-STOT-161554	1151	16	54	15	64.8	7.50
L-STOT-161560	1218	16	60	15	72.0	8.33
L-STOT-161566	1282	16	66	15	79.2	9.17
L-STOT-161572	1344	16	72	15	86.4	10.00
right open/ left tackboard						
L-STTO-161536	962	16	36	15	43.2	5.00
L-STTO-161542	1024	16	42	15	50.4	5.83
L-STTO-161548	1091	16	48	15	57.6	6.67
L-STTO-161554	1151	16	54	15	64.8	7.50
L-STTO-161560	1218	16	60	15	72.0	8.33
L-STTO-161566	1282	16	66	15	79.2	9.17
L-STTO-161572	1344	16	72	15	86.4	10.00

Code	Price	H	W	D	Weight (lb.)	Volume (ft ³)
right open/left melamine						
L-STMO-161536	723	16	36	15	43.2	5.00
L-STMO-161542	778	16	42	15	50.4	5.83
L-STMO-161548	833	16	48	15	57.6	6.67
L-STMO-161554	886	16	54	15	64.8	7.50
L-STMO-161560	942	16	60	15	72.0	8.33
L-STMO-161566	997	16	66	15	79.2	9.17
L-STMO-161572	1053	16	72	15	86.4	10.00
left open/right melamine						
L-STOM-161536	723	16	36	15	43.2	5.00
L-STOM-161542	778	16	42	15	50.4	5.83
L-STOM-161548	833	16	48	15	57.6	6.67
L-STOM-161554	886	16	54	15	64.8	7.50
L-STOM-161560	942	16	60	15	72.0	8.33
L-STOM-161566	997	16	66	15	79.2	9.17
L-STOM-161572	1053	16	72	15	86.4	10.00

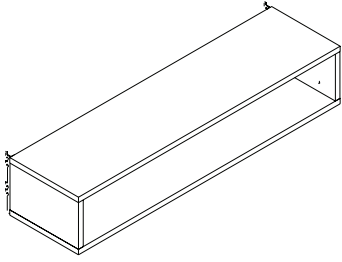

What's Included:

One (1) open cubby, two (2) mounting brackets

How to Specify:

Refer to laminate card for laminate face options

Notes:

Options:

Height*: 8"

Width: 24", 30", 36", 42", 48"

Depth**: 11"

* Internal cabinet height is 6.5"

** Internal cabinet depth is 11"

Code	Price	H	W	D	Weight (lb.)	Volume (ft ³)
L-SCS-081124	423	8	24	15	24.0	1.67
L-SCS-081130	439	8	30	15	27.0	2.08
L-SCS-081136	459	8	36	15	30.0	2.50
L-SCS-081142	474	8	42	15	33.0	2.92
L-SCS-081148	496	8	48	15	36.0	3.33

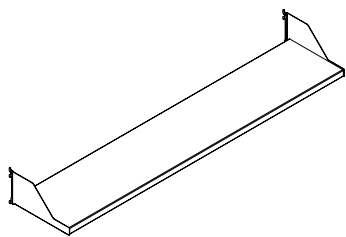

What's Included:

One (1) metal shelf

How to Specify:

Choose white, black, silver, charcoal for metal shelf

Notes:

Options:

Height: 6"

Width: 30", 36", 42", 48", 54", 60"

Depth: 12"

Code	Price	H	W	D	Weight (lb.)	Volume (ft ³)
L-SOOM-1230	346	2	30	12	14.4	0.42
L-SOOM-1236	362	2	36	12	17.3	0.50
L-SOOM-1242	382	2	42	12	20.2	0.58
L-SOOM-1248	401	2	48	12	23.0	0.67
L-SOOM-1254	409	2	54	12	25.9	0.75
L-SOOM-1260	438	2	60	12	28.8	0.83

tayco®

Switch Canada Pricebook
June 2026

Accessories

Desktop Power Module	210
Tasklight	211
Monitor Arm	212
Keyboard Tray	213
Work Organizers	214
Accessory Rail	215
Pencil Tray	216

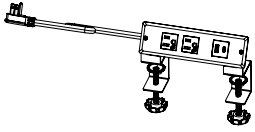

What's Included:

Clamp mount desktop power module equipped with two ac outlets, one USB A and one USB C charging ports, and one (1) three prong cord

How to Specify:

Can be used on freestanding surface or surface with 1" wireplay if connected to a panel

Available in black only

Notes:

Clamp requires 1 3/4" x 8 1/8" undersurface clearance

Dimensions:

Cord length: 120"

Power Module Width: 8"

Code	Price	H	W	D	Weight (lb.)	Volume (ft ³)
V-EMW-2AC	208	6	4	3	1.0	0.04

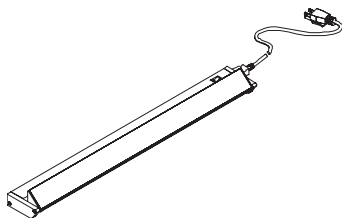
**What's Included:**

Task Light (1) and installation hardware.

How to Specify:

This product is available only in silver.

Notes:

The task light can be mounted beneath an overhead cabinet or shelf to provide focused lighting within the workstation.

The task light cord is 9-feet long from the end of the task light.

Task lights come with built-in occupancy sensor with 30 minute delay

Options:

Width 24", 36", 48"

Code	Price	H	W	D	Weight (lb.)	Volume (ft ³)
V-ELU-24	344	3	24	1	9.5	0.04
V-ELU-36	387	3	36	1	13.7	0.06
V-ELU-48	486	3	48	1	17.9	0.08

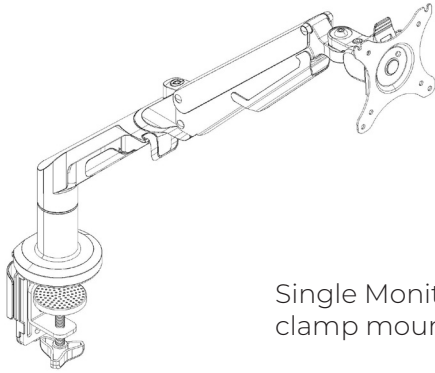

Single Monitor Arm - clamp mount

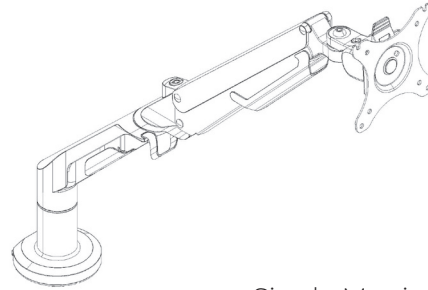

Single Monitor Arm - grommet mount

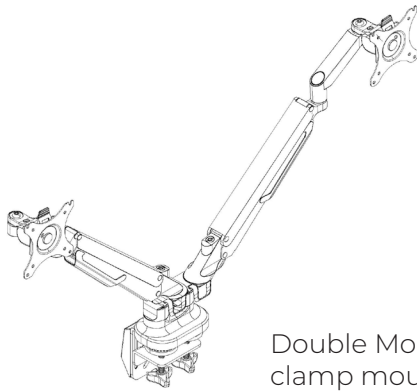

Double Monitor Arm - clamp mount

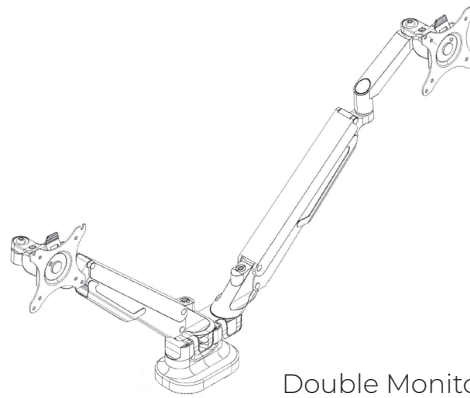

Double Monitor Arm - grommet mount

What's Included:

One monitor arm and installation hardware for both clamp and grommet mount

How to Specify:

- Specify type

Notes:

Available in silver only

Single Monitor Arm

- Screen Size - 17"-36"
- Load Capacity - 6.6-26.4lbs/3-12kg
- Tilt Range - -90 degrees - -15 degrees

Dual Monitor Arm

- Screen Size - 17"-32"
- Load Capacity - 4.4-19.8lbs/2-9kg
- Tilt Range - -90 degrees - -15 degrees

Dimensions:

Vesa: 75x75 and 100x100

Code	Price
Monitor Arm - Single Mount	
V-AFMA-01	426
Monitor Arm - Double Mount	
V-AFMA-02	711

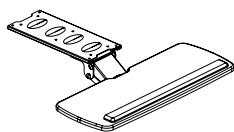

Articulating Keyboard Tray

What's Included:

Keyboard Tray, installation hardware.

How to Specify:

The articulating keyboards are available only in black.

Notes:

Keyboard trays provide adjustable ergonomic support for individuals in multi-task environments

Code	Price	H	W	D	Volume (ft ³)	Weight (lb)
Articulating Keyboard Tray						
V-KASX-2510	459	0	25	10	0	15

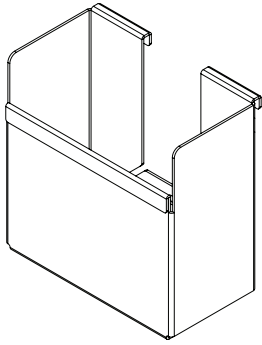

pencil holder

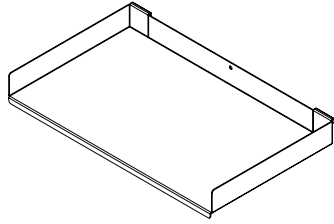

paper tray - legal

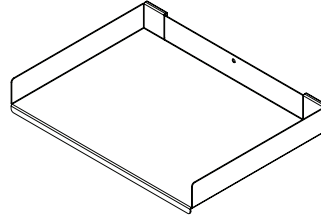

paper tray - letter

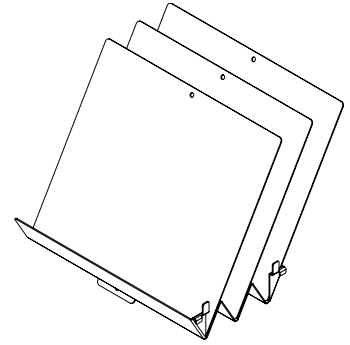

document sorter

What's Included:

One (1) paper tray or one (1) paper holder or one (1) paper sorter

How to Specify:

Refer to metal paint card for metal paint colors

Notes:

Dimensions:

Code	Price	H	W	D	Weight (lb.)	Volume (ft ³)
pen holder						
L-AAP0	152	6	4	2	0.3	
paper tray - legal						
L-AAP-13	179	11	13	1	3.2	
paper tray - letter						
L-AAP-9	157	11	9	1	2.1	
paper sorter						
L-AAS	269	10	10	10	3.2	

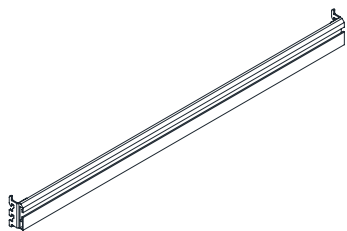

What's Included:

One (1) panel mount or wall mount accessory rail

How to Specify:

Panel mount, wall mount

Refer to metal paint card for metal paint colours

Notes:

Dimensions:

Width: 24", 30", 36", 42", 48", 54", 60"

Code	Price	H	W	D	Weight (lb.)	Volume (ft ³)
Panel Mounted						
L-AR-24	257	3	24	0.75	0.8	
L-AR-30	267	3	30	0.75	0.9	
L-AR-36	273	3	36	0.75	1.0	
L-AR-42	284	3	42	0.75	1.0	
L-AR-48	294	3	48	0.75	1.1	
L-AR-54	302	3	54	0.75	1.2	
L-AR-60	311	3	60	0.75	1.3	
Wall Mounted						
L-AR-24-W	257	3	24	0.75	0.8	
L-AR-30-W	267	3	30	0.75	0.9	
L-AR-36-W	273	3	36	0.75	1.0	
L-AR-42-W	284	3	42	0.75	1.0	
L-AR-48-W	294	3	48	0.75	1.1	
L-AR-54-W	302	3	54	0.75	1.2	
L-AR-60-W	311	3	60	0.75	1.3	

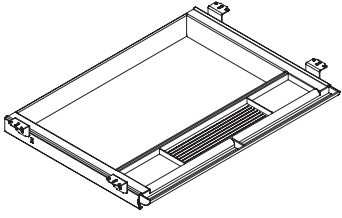

What's Included:

One (1) pencil tray

How to Specify:

Available in black only

Notes:

Available in black only

Dimensions:

Width: 24"

Depth: 16"

Code	Price	H	W	D	Weight (lb.)	Volume (ft ³)
V-ADPP	100	14	21	2	1.8	0.34

