

tayco[®]



**Union Quick Ship
Pricebook**
August 2025

Contents

Caution	5
Overview	6
Statement of Line	9
Step-by-step order placement	17
Finishes	18
Trims - Metal	18
Laminates - Solid	18
Laminates - Woodgrain	19
Desks	20
straight	22
full modesty	22
partial modesty	24
full recessed modesty	26
arc	27
full recessed modesty	27
Tables	28
D-table	30
J-table	31
P-table	32
F-table	33
U-table	34
C-table	35
Corners	36
straight front corner	38
full modesty /w gable	38
partial modesty no gable	39
partial modesty /w gable	40
curved front corner	41
full modesty /w gable	41
full modesty no gable	42
partial modesty /w gable	43

Unitized Desks	44
curved front	46
w/full modesties /w gables	46
w/full modesties / no gables	47
w/partial modesties /w gables	48
Bridges	50
straight bridge	52
/w full modesty	52
/w partial modesty	53
Returns	54
straight return	56
full modesty	56
partial modesty	58
Credenzas	60
top	62
double lateral file	63
double storage cabinet	64
Supports	66
intermediate support	68
cantilever	69
Filing & Storage	70
pedestals	72
underdesk combo pedestal BBF & FF	73
underdesk storage cabinet	74
underdesk 2-drawer lateral file	75
freestanding 2-drawer lateral file	76
freestanding 3-drawer lateral file	77
freestanding storage cabinet	78
freestanding storage tower- single door	79
storage cabinet w/coat bar and shelves	80
freestanding combo lateral storage double door	81
bookcase	82

Conference Tabletops	84
<u>straight tabletop</u>	86
<u>straight tabletop w/power and data</u>	88
<u>boat-shaped tabletop</u>	90
<u>boat-shaped tabletop w/power and data</u>	92
<u>racetrack tabletop</u>	94
<u>racetrack tabletop w/power and data</u>	96
Overhead Storage	98
<u>hinged door hutch</u>	100
<u>wall mounted hinged door hutch</u>	101
Bases	102
<u>gable & modesty base</u>	104
<u>for straight tabletop</u>	104
<u>for racetrack top</u>	106
<u>elliptical base</u>	108
<u>for straight tabletop</u>	108
<u>for racetrack top</u>	110
Accessories	112
<u>keyboard tray</u>	114
<u>PET tackboard for hutch</u>	115
<u>pencil drawer</u>	116
<u>task light</u>	117
<u>monitor arm</u>	118
<u>ellora grommet add-ons</u>	119

Load Bottom Drawer First

- Operate one drawer at a time
- Units may tip if loaded incorrectly
- Units should be attached to a wall or other furniture to reduce tipping hazard
- Always load the heaviest files in the bottom drawer

Heavy Load

- Some products must be anchored to wall to ensure stability & safety.
- It is the owner and installers responsibility to ensure that the wall type and construction is of sufficient strength to carry the loads of any wall mounted products and their contents.
- Failure of the wall and anchors to support all imposed loads may result in property damage and/or personal injury.
- Tayco can provide size and empty weight of its products only. As wall blocking is considered a building construction process, Tayco cannot provide recommendations in this respect and cannot be responsible for damage or injury that may occur as a result of improper installation and/or blocking.

Instability Hazard

Mobile items on casters such as flip top, personal and movable tables of any type and storage items of any type may present an instability hazard if not secured correctly while in use or in storage. Flip top tables or training tables of any type, are inherently more unstable when folded. Tayco provides the following guidelines & warnings when using mobile products:

- Lock casters immediately after moving. Do not leave the casters unlocked when in use or in storage.
- Motion may increase the instability of any item with casters. If the wheels hit an obstruction the table's forward momentum often causes overturn, especially if the item is not equipped with wheel extensions. Exercise strong caution while moving these items.
- Use caution when abrupt level changes in the floor are present (such as a doorway or room threshold) as caster failure or tipping may result.
- Do not stand, sit or lean on mobile items for support. They are not intended for this use and personal injury or property damage may result.
- Mobile units that feature height adjustable elements must be lowered to the minimum compressed height when moving to prevent instability. It is also recommended the user remove all computer equipment or other accessories to prevent possible weight imbalance or damage to equipment.
- Failure to follow the guidelines above may result in property damage or personal injury.

Overview

Tayco introduces Union Quick Ship, a full line of case goods and conference furniture.

Union is divided into three distinct product groups for ease of specifying: Executive, Professional and Conference. The prefix of the product code indicates the product group.

QML 1" – Union Quick Ship Professional
QMB 1.5" – Union Quick Ship Conference

Tayco's Quick Ship Program offers a selection of furniture systems and ergonomic accessories with a 10-day lead time. This program includes flexible panel systems designed for various work environments, casegoods suitable for private offices and meeting spaces, and ergonomic accessories such as monitor arms and power solutions.

The Union Quick Ship line provides casegoods for workspaces, featuring desks and storage. This program offers a modern design with durable construction. Each piece is made with 1" thick thermally fused melamine worksurfaces, desk-height storage cabinet tops and 3/4" thick tops.

desks, returns, bridges and credenzas

Desks are available with a choice of recessed or flush modesties. Union desks, end gables and modesties are made with 45 lb./cubic foot density industrial-grade composite wood core, finished on both sides. Many pieces are available with partial or full modesties. Partial modesties (10"H) should be ordered only for pieces located next to a wall. Otherwise, full modesties should be used.

pedestals

All pedestal drawers are outfitted with full extension slides. Drawers can be easily removed by releasing the small catches on either side of the slide. Pedestals come standard with locks. One lock will lock all drawers. File drawers will accommodate legal or letter-size documents.

freestanding storage and combo cabinets

Various combination filing and storage units provide a place to hang a coat, store personal items and documents to suit any individual's needs.

bookcases

Bookcases have height-adjustable shelves with the exception of any desk-height shelves. They are fixed to add structural stability to the bookcase.

intermediate gable supports

Some configurations require the use of an intermediate gable support. This support must be ordered separately. The situations requiring an intermediate gable support are:

- For use under surfaces 60" wide or greater where there is no filing or storage to support the worksurface (see picture 1). The intermediate support is necessary if a hutch is placed over a bridge or return surface (see picture 2).

surfaces 60" wide or greater

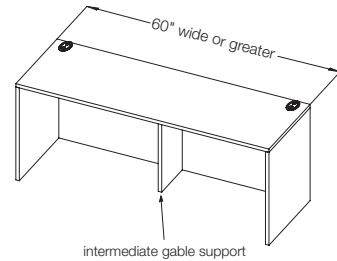

picture 1

under surfaces with a hutch

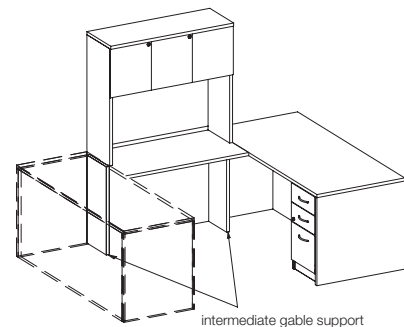

picture 2

- Under return surfaces where the return meets the primary desk or Peninsula table.
- The 12" wide intermediary gable is for 21" and 24"-deep surfaces and the 18"-wide intermediate gable is used with 30"- and 36"-deep worksurfaces. (see Picture 3)

universal gable support

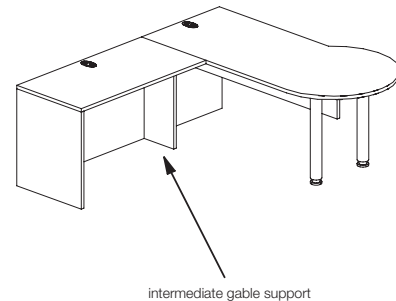

picture 3

hutches and cabinets

Hutches and cabinet doors come in classic laminate. Hutches with laminate doors always come standard with locking doors.

accessories

Computer accessories include flat-screen monitor arms, and articulating keyboard trays.

Heavy-duty flat-screen monitor arms adjust to the user while storing wires within the arm. The monitor mounting plate meets VESA standards to accommodate most monitors. Monitor arms can be grommet- or clamp-mounted to the worksurface. Articulating keyboard trays complete the workstation.

Hutch-mounted tackboards can be finished in any Tayco standard PET to match the office decor.

Standard LED task lights are available in two sizes.

handle details

Six handle options are available in choice of colors.

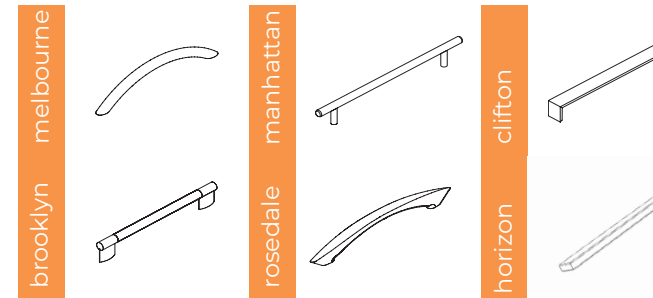

default vinyl color selections

Each laminate comes with matching vinyl trim color unless otherwise specified on your purchase order. Refer to the laminate finishes [on page 19](#) for details.

filing options

Pedestal file drawers can accommodate letter- or legal-size documents. Letter-size papers can be filed either front to back or side to side. Lateral drawers can accommodate front to back or side to side filing of legal- or letter-size documents.

Disclaimer: Please note that lateral file drawers are intended for filing letter and legal size paper front to back or side to side only. For details and weight restrictions please contact customer service.

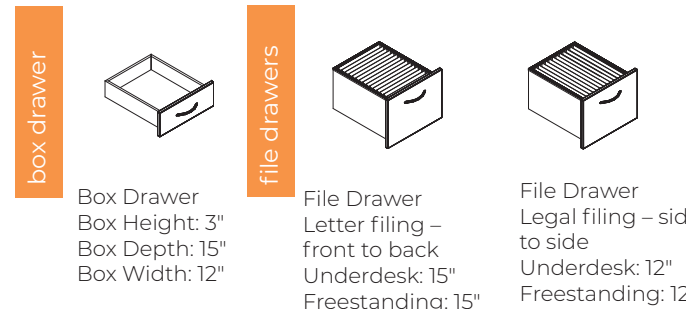

Box Drawer
Box Height: 3"
Box Depth: 15"
Box Width: 12"

File Drawer
Letter filing – front to back
Underdesk: 15"
Freestanding: 15"

File Drawer
Legal filing – side to side
Underdesk: 12"
Freestanding: 12"

lateral file drawer

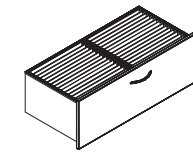

Lateral File Drawer (36W & 42W)
Legal filing – front to back
Underdesk: 15"
Freestanding: 15"

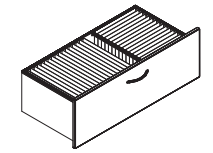

Lateral File Drawer (36W & 42W)
Legal filing – side to side
Letter filing – front to back
Underdesk: 15"
Freestanding: 15"

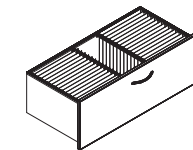

Lateral File Drawer (30W, 36W & 42W)
Letter filing – front to back
Underdesk: 15"
Freestanding: 15"

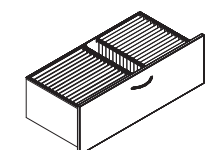

Lateral File Drawer (36W & 42W)
Letter & legal filing – front to back
Underdesk: 15"
Freestanding: 15"

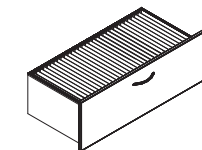

Lateral File Drawer (30W, 36W & 42W)
Legal filing – side to side
Underdesk: 30W-25½", 36W-31½", 42W-37½"
Freestanding: 30W-25½", 36W-31½", 42W-37½"

How to Order and Read your Code:

QM or QML **TSOG** **60** **21**
product line item width depth

grain direction

Horizontal Surfaces

When ordering a directional laminate, the grain will run the direction of the width of the worksurface (excluding bridge surfaces), hutch or storage top. Grain on bridge modesty runs vertically so the grain will run the same direction on the entire suite.

Vertical Surfaces

Directional laminates run vertically on vertical surfaces such as cabinet doors, pedestal drawer fronts and gables, as well as all cabinet, lateral file and pedestal kick-plates. The grain runs horizontally across the width of modesty panels.

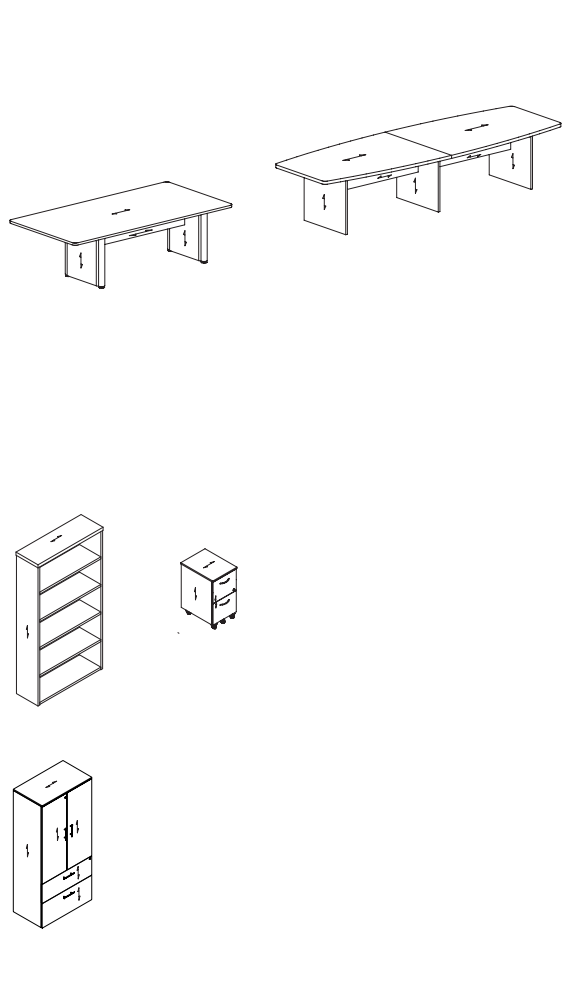
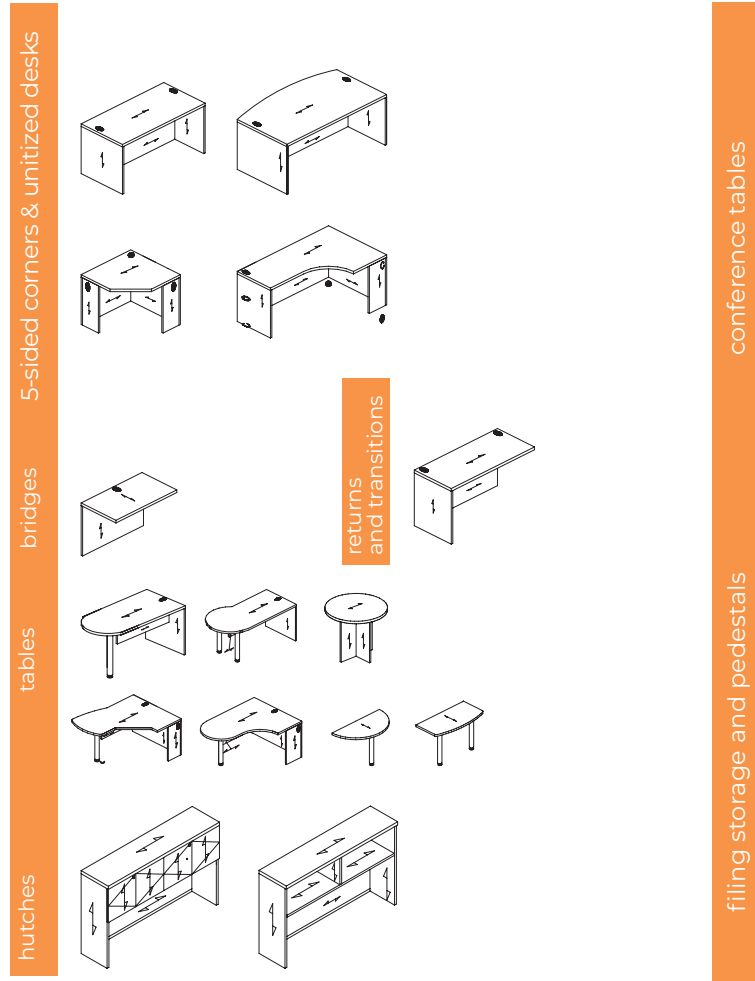

Note: Boardroom tables with tops comprised of 2 or more pieces will not have a consistent grain pattern.

grommets

Oval shaped grommets are available in black or silver and square shaped grommets are available in black, silver or white to coordinate with furniture.

Components Available With or Without Grommets

- ◆ Arc desks without pedestals
- ◆ Straight desks with recessed modesties

Components Without Grommets

- ◆ "U" and "C" Tables

Grommet Placement

Surfaces up to and including 48" wide have one grommet located at back center of the surface. Surfaces 54" wide and wider have two grommets at either side of the back of the surface.

Components Including Grommets

- ◆ Peninsula tables
- ◆ Arc desks with pedestals
- ◆ Straight desks with recessed modesties and pedestals
- ◆ Straight desks with flush modesties
- ◆ Returns
- ◆ Bridges
- ◆ 5-sided corner worksurfaces
- ◆ Unitized desks
- ◆ Reception units

Statement of Line

Desks

1" Thick Desks

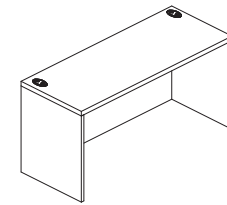

QML-TS0G
Straight w/ Full Modesty
W: 30" - 96"
D: 21" - 30"
H: 29.5"

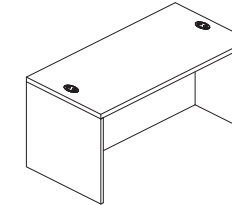

QML-TSRG
Straight w/ Full Recessed Modesty
W: 60" - 96"
D: 30" - 36"
H: 29"

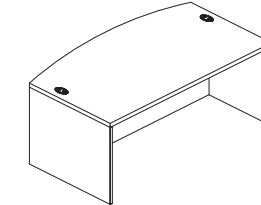

QML-TARG
Arc w/ Full Recessed Modesty
W: 72" - 96"
D: 36"
H: 29"

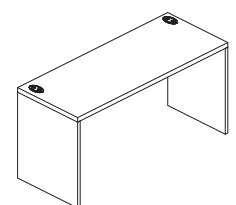

QML-TS0Z
Straight w/ Partial Modesty
W: 30" - 96"
D: 21" - 30"
H: 29.5"

Tables

1" Thick

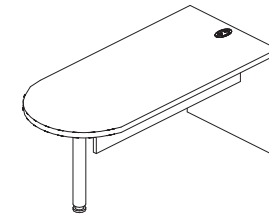

QML-TD0G
D-Table
W: 60" - 84"
D: 30"-36"
H: 29"

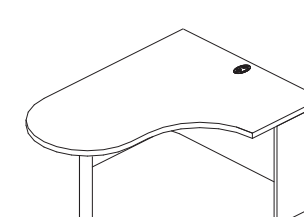

QML-TJ0G-L / QML-TJ0G-R
J-Table (Left Hand shown)
W: 60" - 84"
D: 24"
H: 29"

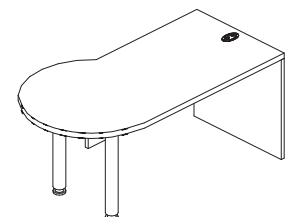

QML-TP0G-L / QML-TP0G-R
P-Table (Left Hand shown)
W: 60" - 84"
D: 30"
H: 29"

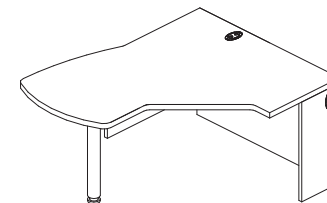

QML-TFSG-L / QML-TFSG-R
F-Table (Left Hand shown)
W: 60" - 84"
D: 24"
H: 29"

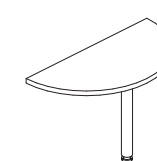

QML-TC00
C-Table
W: 42" - 60"
D: 21"-30"
H: 29"

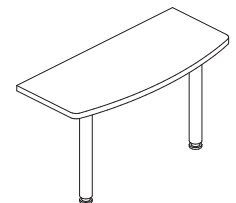

QML-WEU0
U-Table
W: 42" - 60"
D: 24"
H: 29"

Corners

1" Thick

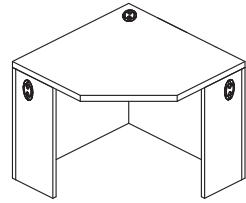

QML-W5S0
Straight Front
Full Modesty w/
Intermediate Gable
W: 36" - 42"
D: 21" - 24"
H: 29"

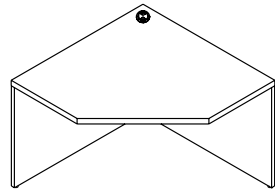

QML-W5S0-N
Straight Front
Full Modesty/ No Intermediate
Gable
W: 36" - 42"
D: 21" - 24"
H: 29"

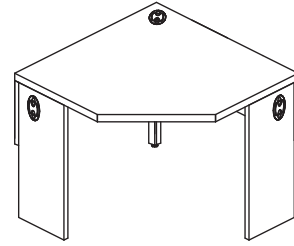

QML-W5S0-P
Straight Front
Partial Modesty w/ Intermediate
Gable
W: 36" - 42"
D: 21" - 24"
H: 29"

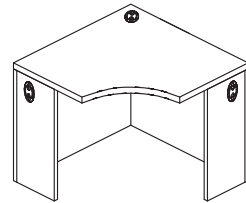

QML-W5C0
Curve Front
Full Modesty w/
Intermediate Gable
W: 36" - 42"
D: 21" - 24"
H: 29"

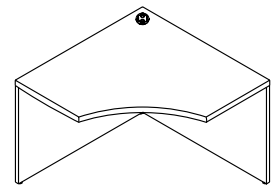

QML-W5C0-N
Curve Front
Full Modesty/ No Intermediate
Gable
W: 36" - 42"
D: 21" - 24"
H: 29"

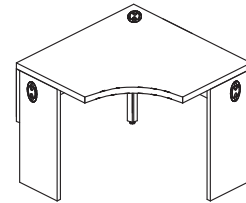

QML-W5C0-P
Curve Front
Partial Modesty w/ Intermediate
Gable
W: 36" - 42"
D: 21" - 24"
H: 29"

Unitized Desks

1" Thick

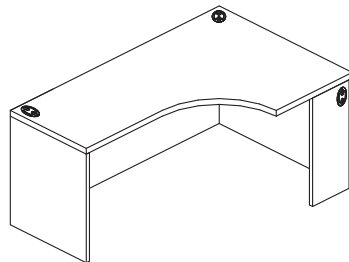

QML-UC4G-L / QML-UC4G-R
Unitized Desk (Left Hand
shown)
Full Modesty w/
Intermediate Gable
W: 66" - 72"
D: 39" - 42"
H: 29"

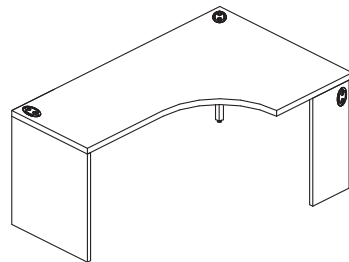

QML-UC4Z-L / QML-UC4G-R
Unitized Desk (Left Hand shown)
Partial Modesty w/ Intermediate
Gable
W: 66" - 72"
D: 39" - 42"
H: 29"

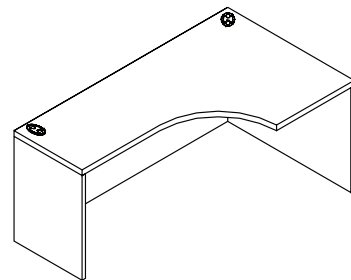

QML-UC4G-L-N / QML-UC4G-R-N
Unitized Desk - (Left Hand
shown)
Full Modesty/ No Intermediate
Gable
W: 66" - 72"
D: 39" - 42"
H: 29"

Bridges

1" Thick

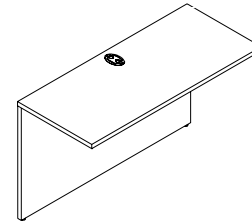

QML-BS0G
Straight w/ Full Modesty
W: 30" - 48"
D: 21" - 24"
H: 29"

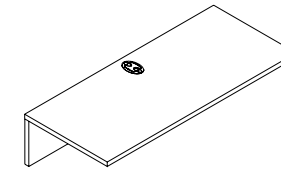

QML-BS0Z
Straight w/ Partial Modesty
W: 30" - 48"
D: 21" - 24"
H: 29"

Returns

1" Thick

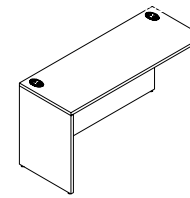

QML-WS1G-L / QML-
WS1G-R
Straight w/ Full Modesty
(Left Hand shown)
W: 24" - 60"
D: 21" - 30"
H: 29"

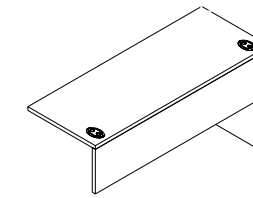

QML-WS1Z-L / QML-WS1Z-R
Straight w/ Partial Modesty
Left Hand shown)
W: 24" - 60"
D: 21" - 30"
H: 29"

Credenza Top

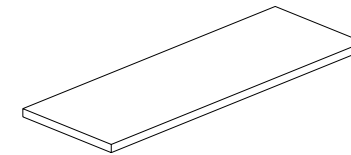

QML-WSS0
1" Thick Credenza Top
W: 60" - 84"
D: 21"

Credenzas
1" Thick

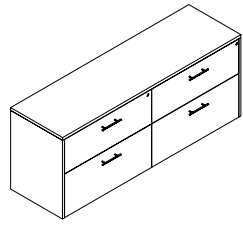

QML-CRLL
Credenza w/ Double Lateral
Files
W: 72"
D: 21" - 24"
H: 29"

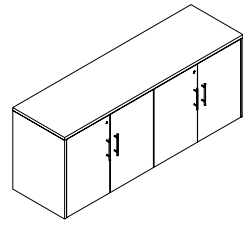

QML-CRSS
Credenza w/ Double Storage Files
W: 72"
D: 21" - 24"
H: 29"

Supports



QM-CGU0
Intermediate Gable Support
W: 12" - 18"
D: 1"
H: 28"

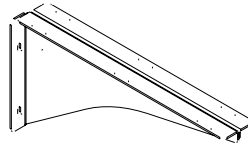

QM-CCAB
Center Cantilever Support
W: 16" - 22"

Pedestals

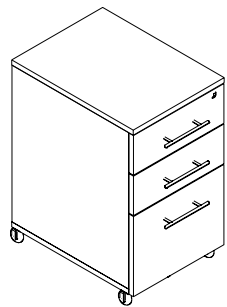

QM-FPBM
Mobile Box/Box/File
W: 16"
D: 21"
H: 28"

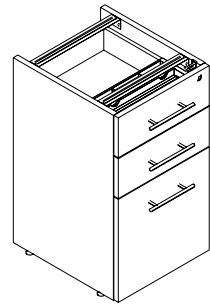

QM-FPBU
Underdesk Box/Box/File
W: 16"
D: 18" - 24"
H: 28"

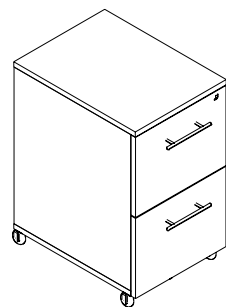

QM-FPFM
Mobile File/File
W: 16"
D: 21"
H: 28"

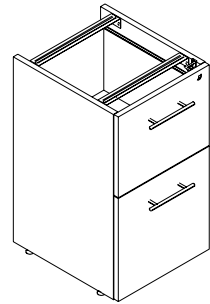

QM-FPFU
Underdesk File/File
W: 16"
D: 18" - 24"
H: 28"

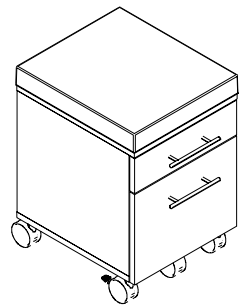

QM-1030
Pedestal w/ Seat Cushion |
Executive & Professional
W: 16"
D: 18"
H: 23"

Filing & Storage

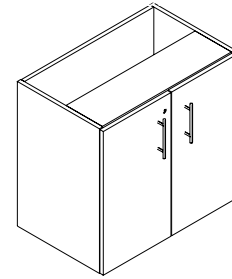

QM-FSU0
Underdesk Storage Cabinet
W: 30" - 42"
D: 20" - 21"
H: 28"

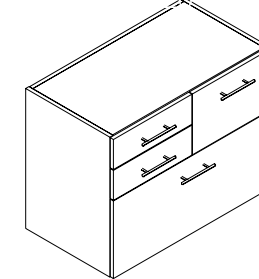

QM-FPJU-L / M-FPJU-R
Underdesk Combo Pedestal
w/Box/Box/File and File/File
LH/ RH (LH shown)
W: 36"
D: 20" - 21"
H: 28"

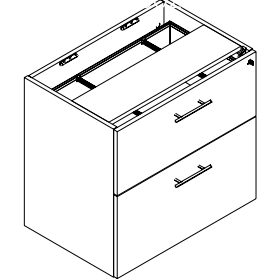

QM-FL2U
Underdesk 2-Drawer Lateral
File
W: 30" - 42"
D: 20" - 21"
H: 28"

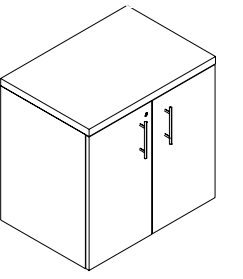

QM-FSF0
1" Freestanding Storage
Cabinet
W: 30" - 42"
D: 21"
H: 29"

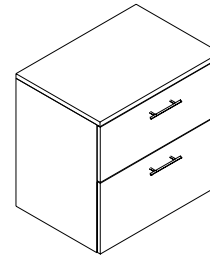

QML-FL2F
Freestanding 2-Drawer Lateral File
W: 30" - 42"
D: 21"
H: 29"

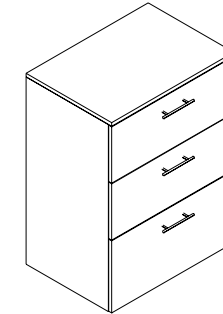

QML-FL3F
Freestanding 3-Drawer Lateral File
W: 30" - 36"
D: 21"
H: 40"

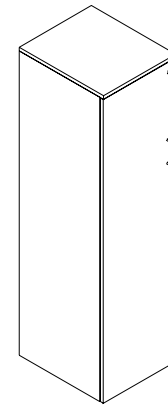

QML-FSDS
Freestanding Storage
Tower (Left Hand shown)
W: 36"
D: 21"
H: 67"

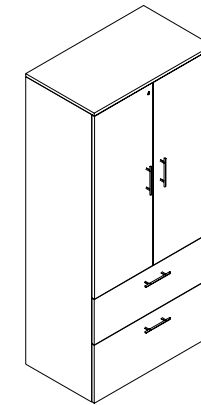

QML-FCSL
Combo Cabinet w/Storage
and Lateral File
W: 36"
D: 21"
H: 67"

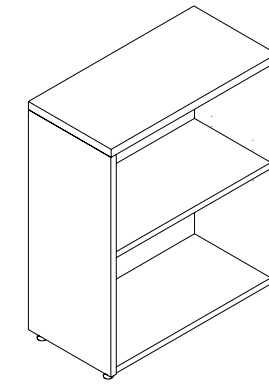

QML-SB0X
Bookcase
W: 24" - 42"
D: 12"/15"/21"
H: 29"/67"/77"

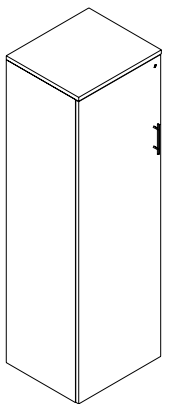

QML-FSDC-L / QML-FSDC-R
Storage Cabinet with Coat Bar
and Shelves
(Left Hand shown)
W: 24"
D: 21"
H: 67"

Overhead Storage

1" Thick

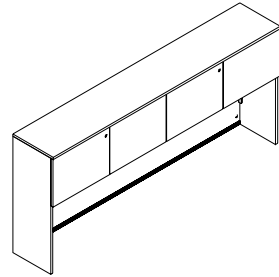

QML-SHHO
Hinged Door Hutch
W: 30" - 84"
D: 15"
H: 38"

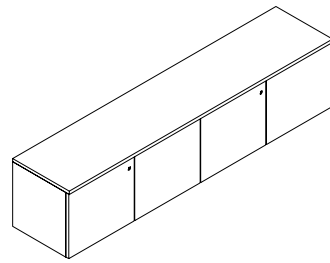

QML-SHHW-L
Wall Mounted Hinged Door
Hutch
W: 30" - 72"
D: 15"
H: 16.5"

Tabletops

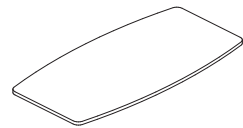

QMB-MBBX
Boat Shaped Tabletop
W: 72" - 240"
D: 36" - 60"



QMB-MBBP
Boat Shaped Tabletop w/
Power & Data
W: 72" - 240"
D: 36" - 60"

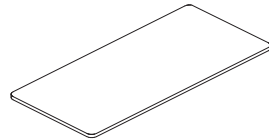

QMB-MSSX
Straight Tabletop
W: 72" - 240"
D: 36" - 60"

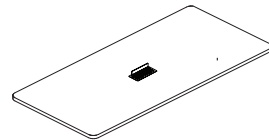

QMB-MSSP
Straight Tabletop w/
Power & Data
W: 72" - 240"
D: 36" - 60"

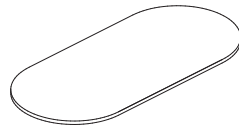

QMB-MRRX
Racetrack Tabletop
W: 72" - 240"
D: 36" - 60"

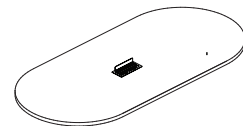

QMB-MRRP
Racetrack Tabletop w/
Power & Data
W: 72" - 240"
D: 36" - 60"

Bases

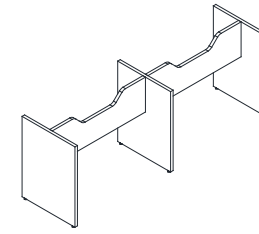

QMB-B4
Gable Base for Straight/Boat
Tabletop
W: 36" - 60"
D: 72" - 240"
H: 28"

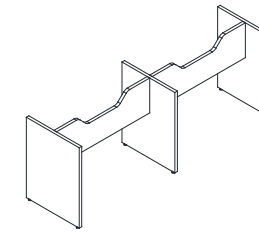

QMB-B4-R
Gable Base for Racetrack
Tabletop
W: 48" - 60"
D: 84" - 240"
H: 28"

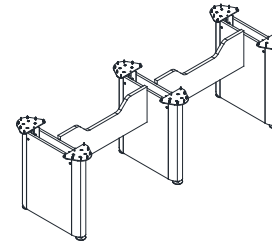

QMB-B5
Elliptical Base for Straight/
Boat Tabletop
W: 36" - 60"
D: 72" - 204"
H: 28"

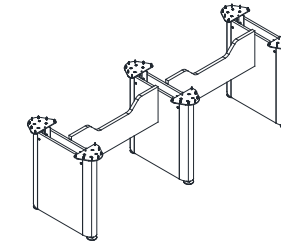

QMB-B5-R
Elliptical Base for Racetrack
Tabletop
W: 48" - 60"
D: 84" - 240"
H: 28"

Accessories

Keyboard

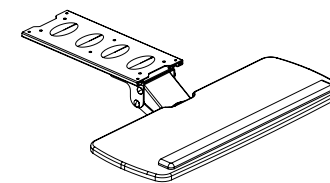

V-KASX
Articulating Keyboard
Tray
W: 25"
D: 10"

Tackboard for Hutch

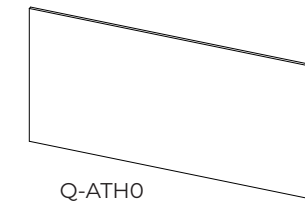

Q-ATHO
PET Tackboard
W: 27" - 81"
D: 0.5"
H: 21"

Pencil Drawer

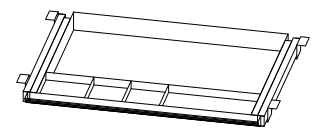

V-ADPP
Plastic Pencil Drawer
W: 21"
D: 16"
H: 2.8"

Tasklight

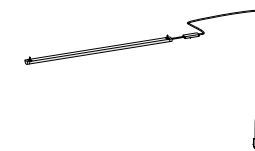

V-ELU
Task Light
W: 36" - 66"
72" - 84"

Accessories (Cont.)

Monitor Arm

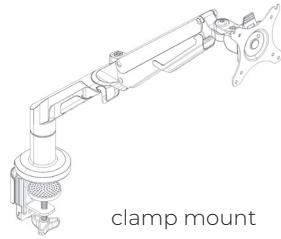

clamp mount

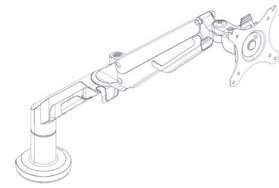

grommet mount

V-AFMA-01
Single Mount

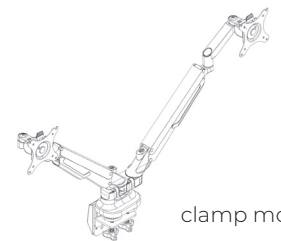

clamp mount



grommet mount

V-AFMA-02
Double Mount

Electrics



QM-RJ45



QM-HDMI

Step-by-step order placement

1. purchase order number
2. quantity
3. product codes and descriptions
4. finishes
5. options
6. provide a drawing or Tayco quotation number
7. shipping address, on-site contact name and phone number
8. shipping instructions
9. confirm access to elevators, loading dock, etc.
10. requested ship date/installation date
11. submit a completed Tayco installation checklist if Tayco is installing the furniture
12. discount, net price and freight charges
13. keep Tayco order numbers on file for reference when placing additional orders

Finishes

Trims - Metal

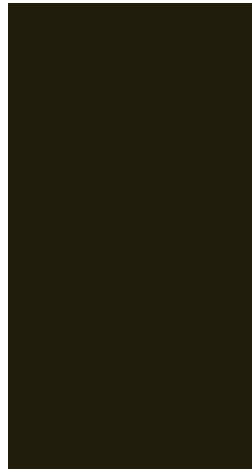

Black
P114

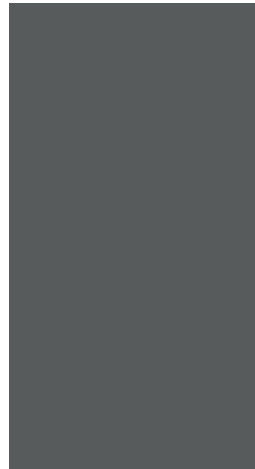

Charcoal
P139

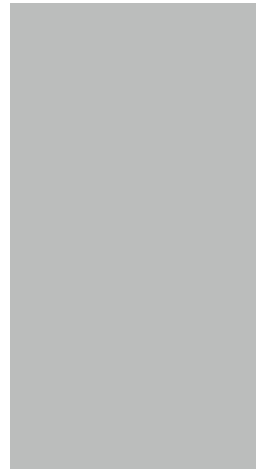

Silver
P112

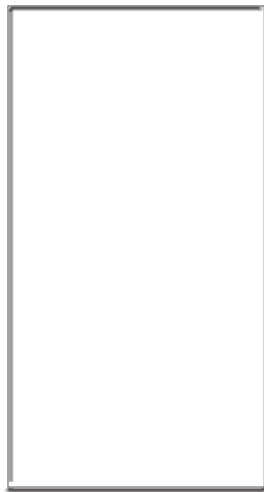

White
P121

Laminates - Solids

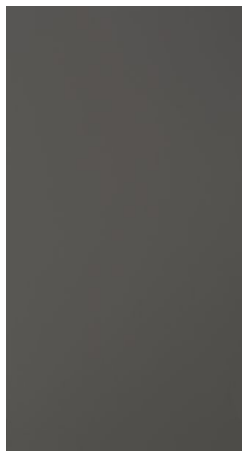

Moonlight*
L164/V164

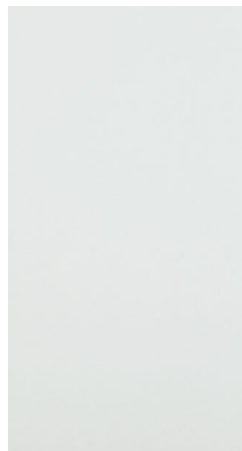

White
L121/V121

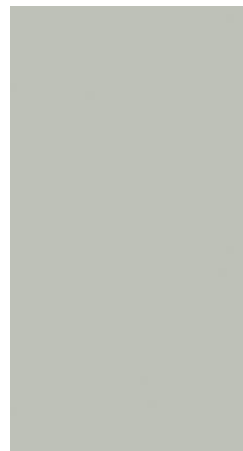

Summer Drops*
L154/V154

* not available in Conference

Laminates - Woodgrain



Copa_Cabana
L133/V133



Fogo Harbour
L165/V143



Megantic
L163/V163



Sable_Island
L161/V161



Tofino
L162/V162



Tuxedo
L132/V132



Union Quickship Pricebook
August 2025
Desks

straight

<u>straight</u>	22
<u>full modesty</u>	22
<u>partial modesty</u>	24
<u>full recessed modesty</u>	26
<u>arc</u>	27
<u>full recessed modesty</u>	27

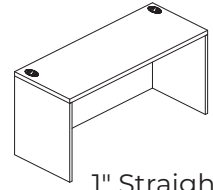

1" Straight Desk/Full Modesty

How to Specify:

Each laminate comes with matching vinyl trim color unless otherwise specified on your purchase order. Refer to the laminate finishes [on page 19](#) for details.

Notes:

Options:

laminate color

grommet color

Code	Price	H	W	D	Volume (ft ³)	Weight (lb)
QML-TS0G-3024	728	29	30	24	12.08	77.17
QML-TS0G-3030	769	29	30	30	15.1	84.2
QML-TS0G-3624	779	29	36	24	14.5	96.29
QML-TS0G-3630	828	29	36	30	18.13	95.73
QML-TS0G-4224	808	29	42	24	16.92	115.41
QML-TS0G-4230	876	29	42	30	21.15	107.26
QML-TS0G-4824	854	29	48	24	19.33	134.53
QML-TS0G-4830	936	29	48	30	24.17	118.79
QML-TS0G-5424	902	29	54	24	21.75	153.65
QML-TS0G-5430	999	29	54	30	27.19	130.32
QML-TS0G-6021	911	29	60	21	21.15	107.7
QML-TS0G-6024	952	29	60	24	24.17	172.77
QML-TS0G-6030	1050	29	60	30	30.21	141.85
QML-TS0G-6621	963	29	66	21	23.26	117.12
QML-TS0G-6624	1000	29	66	24	26.58	191.89
QML-TS0G-6630	1088	29	66	30	33.23	153.38
QML-TS0G-7221	1000	29	72	21	25.38	126.54
QML-TS0G-7224	1042	29	72	24	29	211.01
QML-TS0G-7230	1134	29	72	30	36.25	164.91
QML-TS0G-7821	1050	29	78	21	27.49	135.96
QML-TS0G-7824	1088	29	78	24	31.42	230.13
QML-TS0G-7830	1202	29	78	30	39.27	176.44
QML-TS0G-8421	1109	29	84	21	29.6	145.38
QML-TS0G-8424	1147	29	84	24	33.83	249.25
QML-TS0G-8430	1265	29	84	30	42.29	187.97
QML-TS0G-9021	1204	29	90	21	31.72	154.8
QML-TS0G-9024	1444	29	90	24	36.25	268.37
QML-TS0G-9030	1489	29	90	30	45.31	199.5
QML-TS0G-9621	1204	29	96	21	33.83	164.22
QML-TS0G-9624	1510	29	96	24	38.67	287.49
QML-TS0G-9630	1569	29	96	30	48.33	211.03

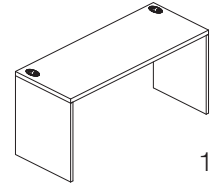

1" Straight Desk w/Partial Modesty

How to Specify:

Each laminate comes with matching vinyl trim color unless otherwise specified on your purchase order. Refer to the laminate finishes [on page 19](#) for details.

Notes:

Partial modesties are 10"H.

Options:

laminate color

grommet color

Code	Price	H	W	D	Volume (ft ³)	Weight (lb)
QML-TS0Z-3024	728	29	30	24	12.08	61.95
QML-TS0Z-3030	769	29	30	30	15.1	63.48
QML-TS0Z-3624	779	29	36	24	14.5	67.5
QML-TS0Z-3630	828	29	36	30	18.13	69.97
QML-TS0Z-4224	808	29	42	24	16.92	73.05
QML-TS0Z-4230	876	29	42	30	21.15	76.46
QML-TS0Z-4824	854	29	48	24	19.33	78.6
QML-TS0Z-4830	936	29	48	30	24.17	82.95
QML-TS0Z-5424	902	29	54	24	21.75	84.15
QML-TS0Z-5430	999	29	54	30	27.19	89.44
QML-TS0Z-6021	911	29	60	21	21.15	81.41
QML-TS0Z-6024	952	29	60	24	24.17	89.7
QML-TS0Z-6030	1050	29	60	30	30.21	95.93
QML-TS0Z-6621	963	29	66	21	23.26	86.6
QML-TS0Z-6624	1000	29	66	24	26.58	95.25
QML-TS0Z-6630	1088	29	66	30	33.23	102.42
QML-TS0Z-7221	1000	29	72	21	25.38	91.79
QML-TS0Z-7224	1042	29	72	24	29	100.8
QML-TS0Z-7230	1134	29	72	30	36.25	108.91
QML-TS0Z-7821	1050	29	78	21	27.49	96.98
QML-TS0Z-7824	1088	29	78	24	31.42	106.35
QML-TS0Z-7830	1202	29	78	30	39.27	115.4
QML-TS0Z-8421	1109	29	84	21	29.6	102.17
QML-TS0Z-8424	1147	29	84	24	33.83	111.9
QML-TS0Z-8430	1265	29	84	30	42.29	121.89
QML-TS0Z-9021	1204	29	90	21	31.72	107.36
QML-TS0Z-9024	1444	29	90	24	36.25	117.45
QML-TS0Z-9030	1465	29	90	30	45.31	128.38
QML-TS0Z-9621	1292	29	96	21	33.83	112.55
QML-TS0Z-9624	1510	29	96	24	38.67	123
QML-TS0Z-9630	1569	29	96	30	48.33	134.87

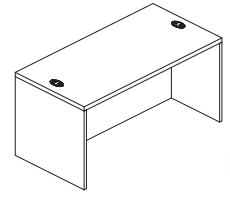

1" Straight Desk w/Recessed Full Modesty and Grommets

How to Specify:

Each laminate comes with matching vinyl trim color unless otherwise specified on your purchase order. Refer to the laminate finishes [on page 19](#) for details.

Options:

laminate color

grommet color

Notes:

Recessed modesty:

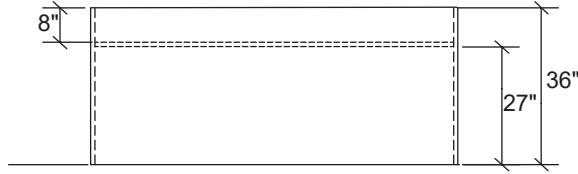

Code	Price	H	W	D	Volume (ft ³)	Weight (lb)
QML-TSRG-6030	1068	29	60	30	30.21	137.93
QML-TSRG-6036	1237	29	60	36	36.25	150.3
QML-TSRG-6630	1109	29	66	30	33.23	149.46
QML-TSRG-6636	1282	29	66	36	39.88	160.2
QML-TSRG-7230	1158	29	72	30	36.25	160.99
QML-TSRG-7236	1331	29	72	36	43.5	170.1
QML-TSRG-7830	1222	29	78	30	39.27	172.52
QML-TSRG-7836	1390	29	78	36	47.13	180
QML-TSRG-8430	1282	29	84	30	42.29	184.05
QML-TSRG-8436	1441	29	84	36	50.75	189.9
QML-TSRG-9030	1512	29	90	30	45.31	195.58
QML-TSRG-9036	1590	29	90	36	54.38	199.8
QML-TSRG-9630	1635	29	96	30	48.33	207.11
QML-TSRG-9636	1725	29	96	36	58	209.7

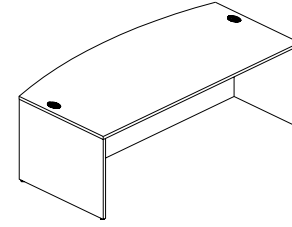

1" Arc Desk w/Recessed Full Modesty and Grommets

How to Specify:

Each laminate comes with matching vinyl trim color unless otherwise specified on your purchase order. Refer to the laminate finishes [on page 19](#) for details.

Options:

laminate color

grommet color

Notes:

Recessed modesty:

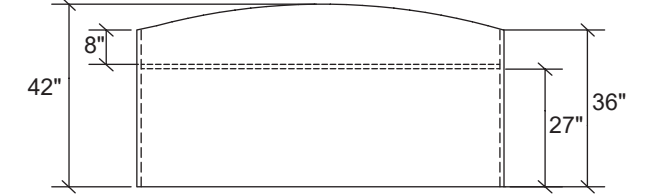

Code	Price	H	W	D	Volume (ft ³)	Weight (lb)
QML-TARG-7236	1552	29	72	36	43.5	178.09
QML-TARG-7836	1629	29	78	36	47.13	188.84
QML-TARG-8436	1710	29	84	36	50.75	199.59
QML-TARG-9036	1781	29	90	36	54.38	210.34
QML-TARG-9636	1857	29	96	36	58	221.09



Union Quick Ship Pricebook
August 2025
Tables

D-table	30
J-table	31
P-table	32
F-table	33
U-table	34
C-table	35

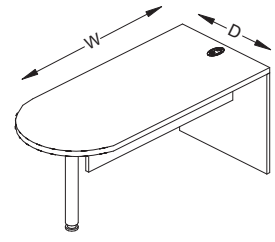

1" D-Table w/Full Gable

How to Specify:

Each laminate comes with matching vinyl trim color unless otherwise specified on your purchase order. Refer to the laminate finishes [on page 19](#) for details.

Notes:

36"D D-tables include two post supports.

Options:

- laminate color

- grommet color

- metal color (for post support)

Code	Price	H	W	D	Volume (ft ³)	Weight (lb)
QML-TD0G-6030	1130	29	60	30	30.21	86.48
QML-TD0G-6036	1233	29	60	36	36.25	107.18
QML-TD0G-6630	1179	29	66	30	33.23	92.95
QML-TD0G-6636	1287	29	66	36	39.88	115.76
QML-TD0G-7230	1221	29	72	30	36.25	99.42
QML-TD0G-7236	1323	29	72	36	43.5	124.34
QML-TD0G-7830	1265	29	78	30	39.27	105.9
QML-TD0G-7836	1367	29	78	36	47.13	132.92
QML-TD0G-8430	1314	29	84	30	42.29	112.38
QML-TD0G-8436	1415	29	84	36	50.75	141.5

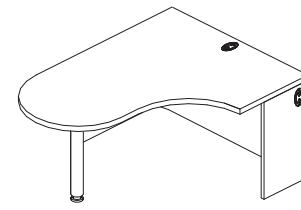

1" J-Table, LH Shown

How to Specify:

Each laminate comes with matching vinyl trim color unless otherwise specified on your purchase order. Refer to the laminate finishes [on page 19](#) for details.

Notes:

Options:

- laminate color

- grommet color

- metal color (for post support)

Code	Price	H	W	D	Volume (ft ³)	Weight (lb)
Left Hand						
QML-TJ0G-604824L	1694	29	60	24	24.17	120.67
QML-TJ0G-664824L	1817	29	66	24	26.58	127.15
QML-TJ0G-724824L	1915	29	72	24	29	133.63
QML-TJ0G-784824L	2024	29	78	24	31.42	140.11
QML-TJ0G-844824L	2122	29	84	24	33.83	146.59
Right Hand						
QML-TJ0G-604824R	1694	29	60	24	24.17	120.67
QML-TJ0G-664824R	1817	29	66	24	26.58	127.15
QML-TJ0G-724824R	1915	29	72	24	29	133.63
QML-TJ0G-784824R	2024	29	78	24	31.42	140.11
QML-TJ0G-844824R	2122	29	84	24	33.83	146.59

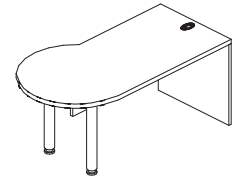

1" P-Table, LH Shown

How to Specify:

Each laminate comes with matching vinyl trim color unless otherwise specified on your purchase order. Refer to the laminate finishes [on page 19](#) for details.

Notes:

Options:

- laminate color

- grommet color

- metal color (for post support)

Code	Price	H	W	D	Volume (ft ³)	Weight (lb)
Left Hand						
QML-TP0G-6030-L	1552	29	60	30	30.21	96.51
QML-TP0G-6630-L	1629	29	66	30	33.23	103.34
QML-TP0G-7230-L	1686	29	72	30	36.25	110.17
QML-TP0G-7830-L	1759	29	78	30	39.27	117
QML-TP0G-8430-L	1825	29	84	30	42.29	123.83
Right Hand						
QML-TP0G-6030-R	1552	29	60	30	30.21	96.51
QML-TP0G-6630-R	1629	29	66	30	33.23	103.34
QML-TP0G-7230-R	1686	29	72	30	36.25	110.17
QML-TP0G-7830-R	1759	29	78	30	39.27	117
QML-TP0G-8430-R	1825	29	84	30	42.29	123.83

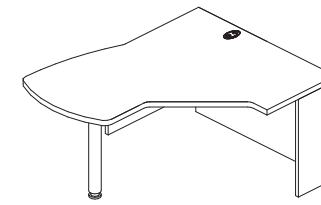

1" F-Table, LH Shown

How to Specify:

Each laminate comes with matching vinyl trim color unless otherwise specified on your purchase order. Refer to the laminate finishes [on page 19](#) for details.

Notes:

Options:

- laminate color

- grommet color

- metal color (for post support)

Code	Price	H	W	D	Volume (ft ³)	Weight (lb)
Left Hand						
QML-TFSG-604824L	2068	29	60	24	24.17	123.35
QML-TFSG-664824L	2103	29	66	24	26.58	129.35
QML-TFSG-724824L	2140	29	72	24	29	135.35
QML-TFSG-784824L	2177	29	78	24	31.42	141.35
QML-TFSG-844824L	2213	29	84	24	33.83	147.35
Right Hand						
QML-TFSG-604824R	2068	29	60	24	24.17	123.35
QML-TFSG-664824R	2103	29	66	24	26.58	129.35
QML-TFSG-724824R	2140	29	72	24	29	135.35
QML-TFSG-784824R	2177	29	78	24	31.42	141.35
QML-TFSG-844824R	2213	29	84	24	33.83	147.35

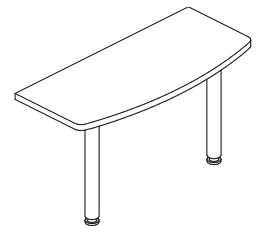

1" U-Table

How to Specify:

Each laminate comes with matching vinyl trim color unless otherwise specified on your purchase order. Refer to the laminate finishes [on page 19](#) for details.

Notes:

Options:

- laminate color
- metal color (for post support)

Code	Price	H	W	D	Volume (ft ³)	Weight (lb)
QML-WEU0-4224	881	29	42	24	16.92	38.79
QML-WEU0-4824	915	29	48	24	19.33	42.36
QML-WEU0-6024	1105	29	60	24	24.17	45.92

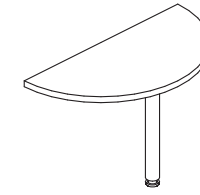

1" C-Table

How to Specify:

Each laminate comes with matching vinyl trim color unless otherwise specified on your purchase order. Refer to the laminate finishes [on page 19](#) for details.

Notes:

Options:

- laminate color
- metal color (for post support)

Code	Price	H	W	D	Volume (ft ³)	Weight (lb)
QML-TC00-4221	683	29	42	21	14.8	25
QML-TC00-4824	791	29	48	24	19.33	30.56
QML-TC00-6030	901	29	60	30	30.21	36.12



Union Quick Ship Pricebook
August 2025
Corners

corners

<u>straight front corner</u>	38
<u>full modesty /w gable</u>	38
<u>partial modesty no gable</u>	39
<u>partial modesty /w gable</u>	40
<u>curved front corner</u>	41
<u>full modesty /w gable</u>	41
<u>full modesty no gable</u>	42
<u>partial modesty /w gable</u>	43

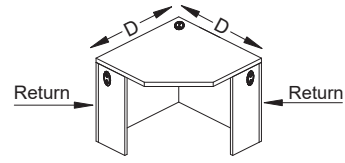

1" Straight Front Corner Worksurface
w/Full Modesties

How to Specify:

Each laminate comes with matching vinyl trim color unless otherwise specified on your purchase order. Refer to the laminate finishes [on page 19](#) for details..

Notes:

Options:

- laminate color

- grommet color

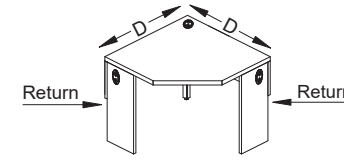

1" Straight Front Corner Worksurface
w/Partial Modesties , no Gables

How to Specify:

Each laminate comes with matching vinyl trim color unless otherwise specified on your purchase order. Refer to the laminate finishes [on page 19](#) for details.

Notes:

Partial modesties are 10"H.

Options:

- laminate color

- grommet color

- metal color (for post support)

Code	Price	H	D	Return	Volume (ft ³)	Weight (lb)
QML-W5S0-3621	1050	29	36	21	12.69	99.2
QML-W5S0-3624	1050	29	36	24	14.5	100.27
QML-W5S0-4221	1234	29	42	21	14.8	117.14
QML-W5S0-4224	1234	29	42	24	16.92	118.66

Code	Price	H	D	Return	Volume (ft ³)	Weight (lb)
QML-W5S0-3621-N	748	29	36	21	12.69	99.2
QML-W5S0-3624-N	748	29	36	24	14.5	100.27
QML-W5S0-4221-N	934	29	42	21	14.8	117.14
QML-W5S0-4224-N	934	29	42	24	16.92	118.66

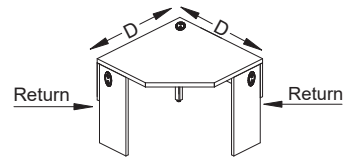

1" Straight Front Corner Worksurface
w/Partial Modesties and Gables

How to Specify:

Each laminate comes with matching vinyl trim color unless otherwise specified on your purchase order. Refer to the laminate finishes [on page 19](#) for details.

Notes:

Partial modesties are 10"H.

Options:

- laminate color

- grommet color

- metal color (for post support)

Code	Price	H	D	Return	Volume (ft ³)	Weight (lb)
QML-W5S0-3621-P	1050	29	36	21	12.69	69.94
QML-W5S0-3624-P	1050	29	36	24	14.5	70.71
QML-W5S0-4221-P	1234	29	42	21	14.8	82.78
QML-W5S0-4224-P	1234	29	42	24	16.92	84.3

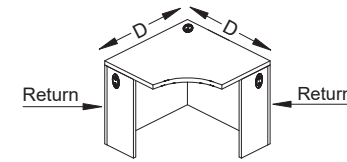

1" Curved Front Corner Worksurface
w/Full Modesties

How to Specify:

Each laminate comes with matching vinyl trim color unless otherwise specified on your purchase order. Refer to the laminate finishes [on page 19](#) for details.

Notes:

Options:

- laminate color

- grommet color

Code	Price	H	D	Return	Volume (ft ³)	Weight (lb)
QML-W5C0-3621	1050	29	36	21	12.69	97.54
QML-W5C0-3624	1050	29	36	24	14.5	98.3
QML-W5C0-4221	1234	29	42	21	14.8	113.86
QML-W5C0-4224	1234	29	42	24	16.92	116.26

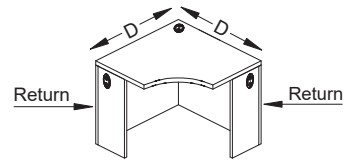

1" Curved Front Corner Worksurface w/Full Modesties, no gables

How to Specify:

Each laminate comes with matching vinyl trim color unless otherwise specified on your purchase order. Refer to the laminate finishes [on page 19](#) for details.

Notes:

Options:

- laminate color

- grommet color

Code	Price	H	D	Return	Volume (ft ³)	Weight (lb)
QML-W5C0-3621-N	748	29	36	21	12.69	97.54
QML-W5C0-3624-N	748	29	36	24	14.5	98.3
QML-W5C0-4221-N	934	29	42	21	14.8	113.66
QML-W5C0-4224-N	934	29	42	24	16.92	116.26

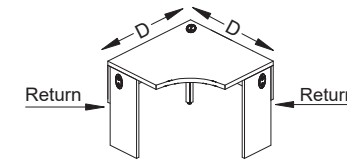

1" Curved Front Corner Worksurface w/ Partial Modesties and gables

How to Specify:

Each laminate comes with matching vinyl trim color unless otherwise specified on your purchase order. Refer to the laminate finishes [on page 19](#) for details.

Notes:

Partial modesties are 10"H.

Options:

- laminate color

- grommet color

- metal color (for post support)

Code	Price	H	D	Return	Volume (ft ³)	Weight (lb)
QML-W5C0-3621-P	1050	29	36	21	12.69	67.98
QML-W5C0-3624-P	1050	29	36	24	14.5	68.74
QML-W5C0-4221-P	1234	29	42	21	14.8	75.61
QML-W5C0-4224-P	1234	29	42	24	16.92	78.01



Union Quick Ship Pricebook
August 2025
Unitized Desks

unitized desks

<u>curved front</u>	46
<u>w/full modesties /w gables</u>	46
<u>w/full modesties / no gables</u>	47
<u>w/partial modesties /w gables</u>	48

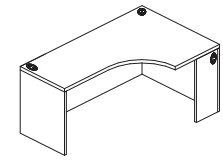

1" Curved Front Unitized Desk
w/Full Modesties, Full Gables,
LH Shown

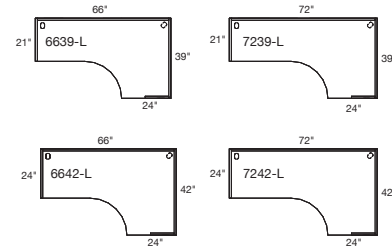

How to Specify:

Each laminate comes with matching vinyl trim color unless otherwise specified on your purchase order. Refer to the laminate finishes [on page 19](#) for details.

Notes:

Options:

laminate color

grommet color

Code	Price	H	W	D	Volume (ft ³)	Weight (lb)
Left Hand						
QML-UC4G-6639-L	1617	29	66	39	43.2	120.6
QML-UC4G-6642-L	1682	29	66	42	46.52	161.1
QML-UC4G-7239-L	1719	29	72	39	47.13	153.9
QML-UC4G-7242-L	2018	29	72	42	50.75	170.55
Right Hand						
QML-UC4G-6639-R	1617	29	66	39	43.2	120.6
QML-UC4G-6642-R	1682	29	66	42	46.52	161.1
QML-UC4G-7239-R	1719	29	72	39	47.13	153.9
QML-UC4G-7242-R	2018	29	72	42	50.75	170.55

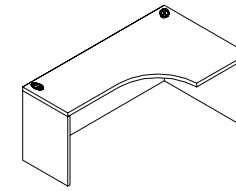

1" Curved Front Unitized Desk
w/Full Modesties, No Gables
LH Shown

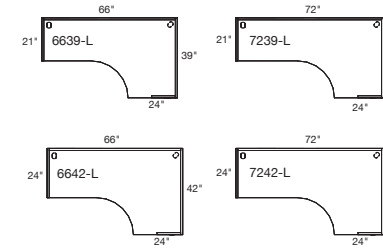

How to Specify:

Each laminate comes with matching vinyl trim color unless otherwise specified on your purchase order. Refer to the laminate finishes [on page 19](#) for details.

Notes:

Options:

laminate color

grommet color

Code	Price	H	W	D	Volume (ft ³)	Weight (lb)
Left Hand						
QML-UC4G-6639-L-N	1465	29	66	39	43.2	120.6
QML-UC4G-6642-L-N	1528	29	66	42	46.52	161.1
QML-UC4G-7239-L-N	1570	29	72	39	47.13	153.9
QML-UC4G-7242-L-N	1863	29	72	42	50.75	170.55
Right Hand						
QML-UC4G-6639-R-N	1465	29	66	39	43.2	120.6
QML-UC4G-6642-R-N	1528	29	66	42	46.52	161.1
QML-UC4G-7239-R-N	1570	29	72	39	47.13	153.9
QML-UC4G-7242-R-N	1863	29	72	42	50.75	170.55

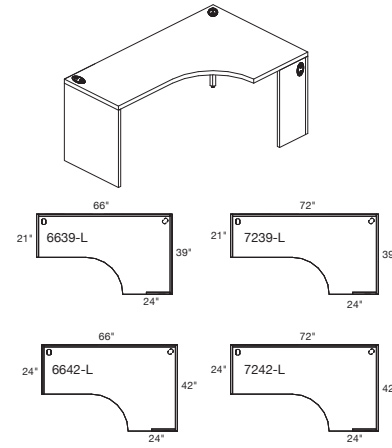

1" Curved Front Unitized Desk
w/Partial Modesties,
/ no Gables
LH Shown

How to Specify:

Each laminate comes with matching vinyl trim color unless otherwise specified on your purchase order. Refer to the laminate finishes [on page 19](#) for details.

Notes:

Options:

laminate color

grommet color

Code	Price	H	W	D	Volume (ft ³)	Weight (lb)
Left Hand						
QML-UC4Z-6639-L	1617	29	66	39	43.2	99.79
QML-UC4Z-6642-L	1682	29	66	42	46.52	114.66
QML-UC4Z-7239-L	1719	29	72	39	47.13	108.77
QML-UC4Z-7242-L	2018	29	72	42	50.75	126.11
Right Hand						
QML-UC4Z-6639-R	1617	29	66	39	43.2	99.79
QML-UC4Z-6642-R	1682	29	66	42	46.52	114.66
QML-UC4Z-7239-R	1719	29	72	39	47.13	108.77
QML-UC4Z-7242-R	2018	29	72	42	50.75	126.11



Union Quick Ship Pricebook
August 2025
Bridges

bridges

<u>straight bridge</u>	52
<u>/w full modesty</u>	52
<u>/w partial modesty</u>	53

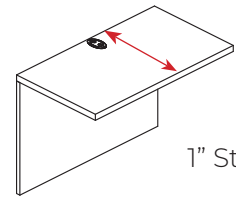

1" Straight Bridge w/Full Modesty

How to Specify:

Each laminate comes with matching vinyl trim color unless otherwise specified on your purchase order. Refer to the laminate finishes [on page 19](#) for details.

Notes:

Options:

- laminate color

- grommet color

Code	Price	H	W	D	Volume (ft ³)	Weight (lb)
QML-BS0G-3021	495	29	30	21	10.57	38
QML-BS0G-3024	518	29	30	24	12.08	40.35
QML-BS0G-3621	534	29	36	21	12.69	45.78
QML-BS0G-3624	555	29	36	24	14.5	48.6
QML-BS0G-4221	594	29	42	21	14.8	53.56
QML-BS0G-4224	612	29	42	24	16.92	56.85
QML-BS0G-4821	634	29	48	21	16.92	61.34
QML-BS0G-4824	695	29	48	24	19.33	65.1

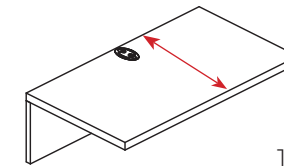

1" Straight Bridge w/Partial Modesty

How to Specify:

Each laminate comes with matching vinyl trim color unless otherwise specified on your purchase order. Refer to the laminate finishes [on page 19](#) for details.

Notes:

Partial modesties are 10"H.

Options:

- laminate color

- grommet color

Code	Price	H	W	D	Volume (ft ³)	Weight (lb)
QML-BS0Z-3021	495	29	30	21	10.6	25.4
QML-BS0Z-3024	518	29	30	24	12.1	27.75
QML-BS0Z-3621	534	29	36	21	12.7	33.18
QML-BS0Z-3624	555	29	36	24	14.5	36
QML-BS0Z-4221	594	29	42	21	14.8	40.96
QML-BS0Z-4224	612	29	42	24	16.9	44.25
QML-BS0Z-4821	634	29	48	21	16.9	48.74
QML-BS0Z-4824	695	29	48	24	19.3	52.5



Union Quick Ship Pricebook
August 2025
Returns

returns

<u>straight return</u>	56
<u>full modesty</u>	56
<u>partial modesty</u>	58

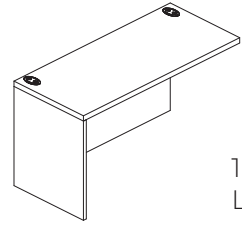

1" Straight Return w/Full Modesty, LH Shown

How to Specify:

Each laminate comes with matching vinyl trim color unless otherwise specified on your purchase order. Refer to the laminate finishes [on page 19](#) for details.

Notes:

1 grommet for width 48" or less
2 grommets for width 54" and wider

Options:

laminate color

grommet color

Code	Price	H	W	D	Volume (ft ³)	Weight (lb)
QML-WS1G-2421-L	630	29	24	21	8.46	45
QML-WS1G-2424-L	641	29	24	24	9.67	48.75
QML-WS1G-2430-L	706	29	24	30	12.08	56.7
QML-WS1G-3021-L	641	29	30	21	10.57	52.4
QML-WS1G-3024-L	653	29	30	24	12.08	56.55
QML-WS1G-3030-L	727	29	30	30	15.1	65.73
QML-WS1G-3621-L	653	29	36	21	12.69	59.8
QML-WS1G-3624-L	661	29	36	24	14.5	64.35
QML-WS1G-3630-L	763	29	36	30	18.13	74.76
QML-WS1G-4221-L	661	29	42	21	14.8	67.2
QML-WS1G-4224-L	684	29	42	24	16.92	72.15
QML-WS1G-4230-L	793	29	42	30	21.15	83.79
QML-WS1G-4821-L	706	29	48	21	16.92	74.6
QML-WS1G-4824-L	727	29	48	24	19.33	79.95
QML-WS1G-4830-L	829	29	48	30	24.17	92.82
QML-WS1G-5421-L	751	29	54	21	19.03	82
QML-WS1G-5424-L	774	29	54	24	21.75	87.75
QML-WS1G-5430-L	865	29	54	30	27.19	101.85
QML-WS1G-6021-L	793	29	60	21	21.15	89.4
QML-WS1G-6024-L	818	29	60	24	24.17	95.55
QML-WS1G-6030-L	921	29	60	30	30.21	110.88
QML-WS1G-2421-R	630	29	24	21	8.46	45
QML-WS1G-2424-R	641	29	24	24	9.67	48.75
QML-WS1G-2430-R	706	29	24	30	12.08	56.7
QML-WS1G-3021-R	641	29	30	21	10.57	52.4
QML-WS1G-3024-R	653	29	30	24	12.08	56.55
QML-WS1G-3030-R	727	29	30	30	15.1	65.73
QML-WS1G-3621-R	653	29	36	21	12.69	59.8
QML-WS1G-3624-R	661	29	36	24	14.5	64.35
QML-WS1G-3630-R	763	29	36	30	18.13	74.76
QML-WS1G-4221-R	661	29	42	21	14.8	67.2
QML-WS1G-4224-R	684	29	42	24	16.92	72.15
QML-WS1G-4230-R	793	29	42	30	21.15	83.79
QML-WS1G-4821-R	706	29	48	21	16.92	74.6
QML-WS1G-4824-R	727	29	48	24	19.33	79.95
QML-WS1G-4830-R	829	29	48	30	24.17	92.82
QML-WS1G-5421-R	751	29	54	21	19.03	82
QML-WS1G-5424-R	774	29	54	24	21.75	87.75
QML-WS1G-5430-R	865	29	54	30	27.19	101.85
QML-WS1G-6021-R	793	29	60	21	21.15	89.4
QML-WS1G-6024-R	818	29	60	24	24.17	95.55
QML-WS1G-6030-R	921	29	60	30	30.21	110.88

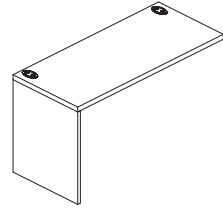

1" Straight Return w/Partial Modesty, LH Shown

How to Specify:

Each laminate comes with matching vinyl trim color unless otherwise specified on your purchase order. Refer to the laminate finishes [on page 19](#) for details.

Notes:

Partial modesties are 10"H
 1 grommet for width 48" or less
 2 grommets for width 54" and wider

Options:

laminate color

grommet color

Code	Price	H	W	D	Volume (ft ³)	Weight (lb)
QML-WS1Z-2421-L	630	29	24	21	8.46	35.1
QML-WS1Z-2424-L	641	29	24	24	9.67	36.9
QML-WS1Z-2430-L	706	29	24	30	12.08	49.35
QML-WS1Z-3021-L	641	29	30	21	10.57	42.5
QML-WS1Z-3024-L	653	29	30	24	12.08	44.7
QML-WS1Z-3030-L	727	29	30	30	15.1	58.38
QML-WS1Z-3621-L	653	29	36	21	12.69	49.9
QML-WS1Z-3630-L	763	29	36	30	18.13	67.41
QML-WS1Z-4221-L	661	29	42	21	14.8	57.3
QML-WS1Z-4224-L	684	29	42	24	16.92	60.3
QML-WS1Z-4230-L	793	29	42	30	21.15	76.44
QML-WS1Z-4230-R	793	29	42	30	21.15	76.44
QML-WS1Z-4821-L	706	29	48	21	16.92	64.7
QML-WS1Z-4824-L	727	29	48	24	19.33	68.1
QML-WS1Z-4830-L	829	29	48	30	24.17	85.47
QML-WS1Z-5421-L	751	29	54	21	19.03	72.1
QML-WS1Z-5424-L	774	29	54	24	21.75	75.9
QML-WS1Z-5430-L	865	29	54	30	27.19	94.5
QML-WS1Z-6021-L	793	29	60	21	21.15	79.5
QML-WS1Z-6024-L	818	29	60	24	24.17	83.7
QML-WS1Z-6030-L	921	29	60	30	30.21	103.53
QML-WS1Z-2421-R	630	29	24	21	8.46	35.1
QML-WS1Z-2424-R	641	29	24	24	9.67	36.9
QML-WS1Z-2430-R	706	29	24	30	12.08	49.35
QML-WS1Z-3021-R	641	29	30	21	10.57	42.5
QML-WS1Z-3024-R	653	29	30	24	12.08	44.7
QML-WS1Z-3030-R	727	29	30	30	15.1	58.38
QML-WS1Z-3621-R	653	29	36	21	12.69	49.9
QML-WS1Z-3624-R	661	29	36	24	14.5	52.5
QML-WS1Z-3630-R	763	29	36	30	18.13	67.41
QML-WS1Z-4221-R	661	29	42	21	14.8	57.3
QML-WS1Z-4224-R	684	29	42	24	16.92	60.3
QML-WS1Z-4230-R	793	29	42	30	21.15	76.44
QML-WS1Z-4821-R	706	29	48	21	16.92	64.7
QML-WS1Z-4824-R	727	29	48	24	19.33	68.1
QML-WS1Z-4830-R	829	29	48	30	24.17	85.47
QML-WS1Z-5421-R	751	29	54	21	19.03	72.1
QML-WS1Z-5424-R	774	29	54	24	21.75	75.9
QML-WS1Z-5430-R	865	29	54	30	27.19	94.5
QML-WS1Z-6021-R	793	29	60	21	21.15	79.5
QML-WS1Z-6024-R	818	29	60	24	24.17	83.7
QML-WS1Z-6030-R	921	29	60	30	30.21	103.53



Union Quick Ship Pricebook
August 2025
Credenzas

credenzas

<u>top</u>	62
<u>double lateral file</u>	63
<u>double storage cabinet</u>	64

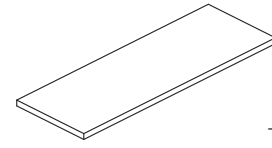

1" Credenza Top

How to Specify:

Each laminate comes with matching vinyl trim color unless otherwise specified on your purchase order. Refer to the laminate finishes [on page 19](#) for details.

Notes:

Options:

laminate color

handle color

handle style

Code	Price	H	W	D	Volume (ft ³)	Weight (lb)
QML-WSS0-6021	399	1	60	21	0.73	32.81
QML-WSS0-6621	438	1	66	21	0.8	36.09
QML-WSS0-7221	459	1	72	21	0.88	39.37
QML-WSS0-7821	496	1	78	21	0.95	42.65
QML-WSS0-8421	535	1	84	21	1.02	45.93

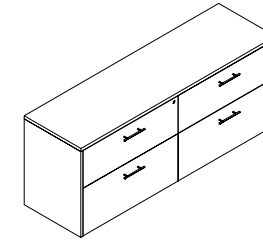

1" Credenza w/Double Lateral Files

How to Specify:

Each laminate comes with matching vinyl trim color unless otherwise specified on your purchase order. Refer to the laminate finishes [on page 19](#) for details.

Notes:

Options:

laminate color

edge profile

handle color

handle style

Code	Price	H	W	D	Volume (ft ³)	Weight (lb)
QML-CRLL-7221	2615	29	72	21	25.38	205.87
QML-CRLL-7224	2770	29	72	24	29	220

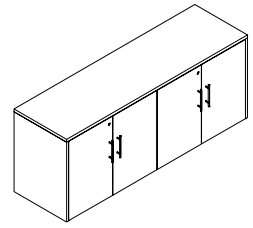

1" Credenza w/Double Storage Cabinets

How to Specify:

Each laminate comes with matching vinyl trim color unless otherwise specified on your purchase order. Refer to the laminate finishes [on page 19](#) for details.

Notes:

Cabinets and laterals include locks and keys.

Options:

laminate color

handle color

handle style

Code	Price	H	W	D	Volume (ft ³)	Weight (lb)
QML-CRSS-7221	2039	29	72	21	25.38	225.45
QML-CRSS-7224	2180	29	72	24	29	236.26



Union Quick Ship Pricebook
August 2025
Supports

supports

<u>intermediate support</u>	<u>68</u>
<u>cantilever</u>	<u>69</u>

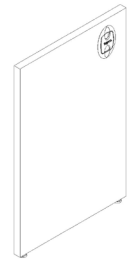

Intermediate Gable Support

How to Specify:

Each laminate comes with matching vinyl trim color unless otherwise specified on your purchase order. Refer to the laminate finishes [on page 19](#) for details.

Notes:

Options:

- laminate color

- grommet color

Code	Price	H	W	D	Volume (ft ³)	Weight (lb)
QM-CGU0-12	210	28	12	1	0.19	8.75
QM-CGU0-18	224	28	18	1	0.29	13.12

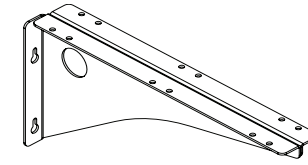

Center Cantilever Support

How to Specify:

Cantilevers are used to join 2 desks w/full modesty. Intermediate gable is required instead of cantilever when hutch sits on top of a desk.

Notes:

Options:

- cantilever available in black only

Code	Price	H	W	D	Volume (ft ³)	Weight (lb)
QM-CCAB-16	110	0	#N/A	#N/A	#N/A	#N/A
QM-CCAB-22	118	0	#N/A	#N/A	#N/A	#N/A



Union Quick Ship Pricebook
August 2025
Filing & Storage

filing and storage

<u>pedestals</u>	<u>72</u>
<u>underdesk combo pedestal BBF & FF</u>	<u>73</u>
<u>underdesk storage cabinet</u>	<u>74</u>
<u>underdesk 2-drawer lateral file</u>	<u>75</u>
<u>freestanding 2-drawer lateral file</u>	<u>76</u>
<u>freestanding 3-drawer lateral file</u>	<u>77</u>
<u>freestanding storage cabinet</u>	<u>78</u>
<u>freestanding storage tower- single door</u>	<u>79</u>
<u>storage cabinet w/coat bar and shelves</u>	<u>80</u>
<u>freestanding combo lateral storage double door</u>	<u>81</u>
<u>bookcase</u>	<u>82</u>

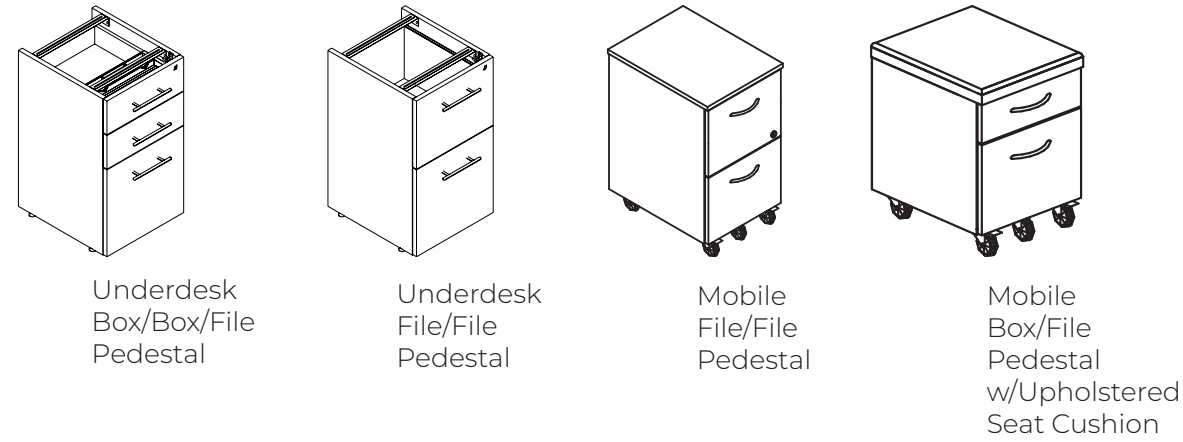

Underdesk Box/Box/File Pedestal

Underdesk File/File Pedestal

Mobile File/File Pedestal

Mobile Box/File Pedestal w/Upholstered Seat Cushion

How to Specify:

Each laminate comes with matching vinyl trim color unless otherwise specified on your purchase order. Refer to the laminate finishes [on page 19](#) for details.

Notes:

Pedestals include lock and keys.

Options:

- laminate color _____
- handle color _____
- handle style _____
- back back full back _____

Code	Price	H	W	D	Volume (ft ³)	Weight (lb)
Underdesk Box/Box/File Pedestal						
QM-FPBU-1618	965	28	16	18	4.67	55
QM-FPBU-1624	1031	28	16	24	6.22	55
Underdesk File/File Pedestal						
QM-FPFU-1624	1031	28	16	24	6.22	55
Mobile File/File Pedestal						
QM-FPFM-1621	1268	28	16	21	5.44	68
Mobile Box/File Pedestal w/Upholstered Seat Cushion						
QM-1030-1618	1547	21	16	18	3.5	55

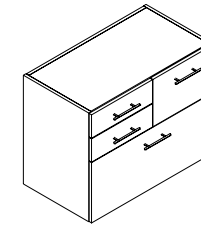

Underdesk Combo Pedestal w/Box/Box/File and File/File, LH Shown

How to Specify:

Each laminate comes with matching vinyl trim color unless otherwise specified on your purchase order. Refer to the laminate finishes [on page 19](#) for details.

Notes:

Cabinets and lateral files include lock and keys.

Options:

- laminate color _____
- handle color _____
- handle style _____

Code	Price	H	W	D	Volume (ft ³)	Weight (lb)
QM-FPJU-3620-L	1865	28	36	20	11.67	121
QM-FPJU-3621-L	1865	28	36	21	12.25	122
QM-FPJU-3620-R	1865	28	36	20	11.67	121
QM-FPJU-3621-R	1865	28	36	21	12.25	122

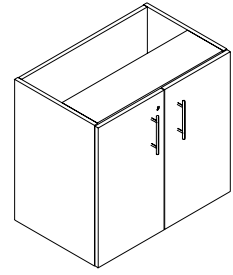

Underdesk Storage Cabinet

How to Specify:

Each laminate comes with matching vinyl trim color unless otherwise specified on your purchase order. Refer to the laminate finishes [on page 19](#) for details.

Notes:

Cabinets and lateral files include lock and keys.

Options:

laminate color

handle color

handle style

Code	Price	H	W	D	Volume (ft ³)	Weight (lb)
QM-FSU0-3020	1183	28	30	20	9.72	88
QM-FSU0-3021	1183	28	30	21	10.21	92
QM-FSU0-3620	1281	28	36	20	11.67	102
QM-FSU0-3621	1281	28	36	21	12.25	107
QM-FSU0-4220	1378	28	42	20	13.61	117
QM-FSU0-4221	1378	28	42	21	14.29	122

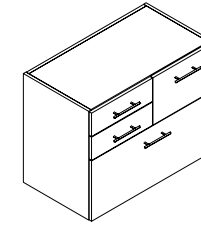

Underdesk 2-Drawer Lateral File

How to Specify:

Each laminate comes with matching vinyl trim color unless otherwise specified on your purchase order. Refer to the laminate finishes [on page 19](#) for details.

Notes:

Cabinets and lateral files include lock and keys.

Options:

laminate color

handle color

handle style

Code	Price	H	W	D	Volume (ft ³)	Weight (lb)
QM-FL2U-3020	1526	28	30	20	9.72	82.06
QM-FL2U-3021	1526	28	30	21	10.21	84.6
QM-FL2U-3620	1581	28	36	20	11.67	86.64
QM-FL2U-3621	1581	28	36	21	12.25	88.02
QM-FL2U-4220	1669	28	42	20	13.61	89.35
QM-FL2U-4221	1669	28	42	21	14.29	91.44

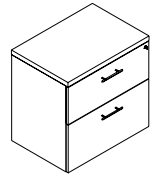

1" Freestanding 2-Drawer Lateral File

How to Specify:

Each laminate comes with matching vinyl trim color unless otherwise specified on your purchase order. Refer to the laminate finishes [on page 19](#) for details.

Notes:

Cabinets and lateral files include lock and keys.

Options:

- laminate color

- handle color

- handle style

Code	Price	H	W	D	Volume (ft ³)	Weight (lb)
QML-FL2F-3021	1579	29	30	21	10.57	92.7
QML-FL2F-3621	1630	29	36	21	12.69	107.1
QML-FL2F-4221	1717	29	42	21	14.8	121.5

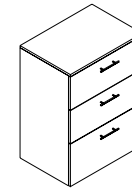

3/4" Freestanding 3-Drawer Lateral File

How to Specify:

Each laminate comes with matching vinyl trim color unless otherwise specified on your purchase order. Refer to the laminate finishes [on page 19](#) for details.

Notes:

Cabinets and lateral files include lock and keys.

Options:

- laminate color

- handle color

- handle style

Code	Price	H	W	D	Volume (ft ³)	Weight (lb)
QML-FL3F-3021	2025	28	16	24	6.22	55
QML-FL3F-3621	2112	40.5	36	21	17.7	155.0

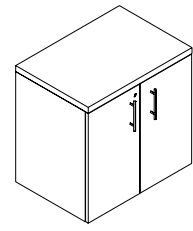

1" Freestanding Storage Cabinet

How to Specify:

Each laminate comes with matching vinyl trim color unless otherwise specified on your purchase order. Refer to the laminate finishes [on page 19](#) for details.

Notes:

Cabinets and lateral files include lock and keys.

Options:

laminate color

handle color

handle style

Code	Price	H	W	D	Volume (ft ³)	Weight (lb)
QML-FSF0-3021	1244	29	30	21	10.57	88
QML-FSF0-3621	1341	29	36	21	12.69	97
QML-FSF0-4221	1436	29	42	21	14.8	106

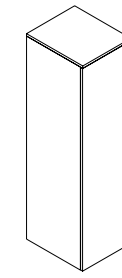

3/4" Storage Cabinet w/ Shelves

How to Specify:

Each laminate comes with matching vinyl trim color unless otherwise specified on your purchase order. Refer to the laminate finishes [on page 19](#) for details.

Notes:

Cabinets and lateral files include lock and keys.

Options:

laminate color

handle color

handle style

Code	Price	H	W	D	Volume (ft ³)	Weight (lb)
QML-FSDS-1821-L	1386	67	18	21	14.66	128.7
QML-FSDS-1821-R	1386	67	18	21	14.66	128.7

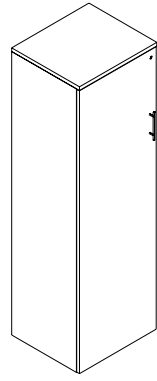

3/4" Storage Cabinet w/Coat Bar and Shelves, Left Hand shown

How to Specify:

Each laminate comes with matching vinyl trim color unless otherwise specified on your purchase order. Refer to the laminate finishes [on page 19](#) for details.

Notes:

Cabinets and lateral files include lock and keys.

Options:

laminate color

handle color

handle style

Code	Price	H	W	D	Volume (ft ³)	Weight (lb)
QML-FSDC-2421-L	1499	67	24	21	19.54	169.95
QML-FSDC-2421-R	1499	67	24	21	19.54	169.95

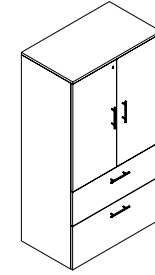

3/4" Combo Cabinet w/Storage and Lateral File

How to Specify:

Each laminate comes with matching vinyl trim color unless otherwise specified on your purchase order. Refer to the laminate finishes [on page 19](#) for details.

Notes:

Cabinets and lateral files include lock and keys.

Options:

laminate color

handle color

handle style

Code	Price	H	W	D	Volume (ft ³)	Weight (lb)
QML-FCSL-3621	2447	67	36	21	29.31	251.25

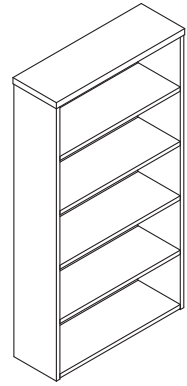

12" or 15" Deep bookcase
3/4" or 1" top

How to Specify:

Each laminate comes with matching vinyl trim color unless otherwise specified on your purchase order. Refer to the laminate finishes [on page 19](#) for details.

Notes:

- Book cases have adjustable shelves and one fixed shelf at desk height.
- All bookcases come with a solid laminate back in matching color.
- Number of shelves includes shelf on bottom of bookcase.
- Bookcases at desk height (29"H) come with 1" top.
- Bookcases taller than desk height come with 3/4" top.

Options:

laminate color

Code	Price	H	W	D	Volume (ft ³)	Weight (lb)	# of Shelves
12" Deep, 1" Top							
QML-SB0X-292412	646	29	24	12	4.83	48.03	2
QML-SB0X-293012	715	29	30	12	6.04	56.24	2
QML-SB0X-293612	780	29	36	12	7.25	64.45	2
QML-SB0X-294212	849	29	42	12	8.46	72.66	2
15" Deep, 1" Top							
QML-SB0X-292415	725	29	24	15	6.04	57.43	2
QML-SB0X-293015	805	29	30	15	7.55	66.99	2
QML-SB0X-293615	880	29	36	15	9.06	76.54	2
QML-SB0X-294215	957	29	42	15	10.57	86.1	2
12" Deep, 3/4" Top							
QML-SB0X-672412	1134	67	24	12	11.17	104.8	5
QML-SB0X-673012	1257	67	30	12	13.96	122.31	5
QML-SB0X-673612	1380	67	36	12	16.75	139.81	5
QML-SB0X-674212	1502	67	42	12	19.54	157.32	5
QML-SB0X-772412	1287	77	24	12	12.83	120.9	6
QML-SB0X-773012	1422	77	30	12	16.04	141.17	6
QML-SB0X-773612	1558	77	36	12	19.25	161.44	6
QML-SB0X-774212	1696	77	42	12	22.46	181.7	6
15" Deep, 3/4" Top							
QML-SB0X-672415	1276	67	24	15	13.96	124.81	5
QML-SB0X-673015	1416	67	30	15	17.45	145	5
QML-SB0X-673615	1554	67	36	15	20.94	165.19	5
QML-SB0X-674215	1692	67	42	15	24.43	185.39	5
QML-SB0X-772415	1446	77	24	15	16.04	144.04	6
QML-SB0X-773015	1600	77	30	15	20.05	167.45	6
QML-SB0X-774215	1911	77	42	15	28.07	214.25	6



Union Quick Ship Pricebook
August 2025

Overhead Storage

overhead storage

<u>hinged door hutch</u>	<u>100</u>
<u>wall mounted hinged door hutch</u>	<u>101</u>

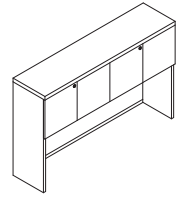

3/4" Hinged-Door Hutch

How to Specify:

Each laminate comes with matching vinyl trim color unless otherwise specified on your purchase order. Refer to the laminate finishes [on page 19](#) for details.

Notes:

Number of Openings and Doors per Hutch										
width(in)	30	36	42	48	54	60	66	72	78	84
openings	1	1	2	2	2	2	2	2	2	2
doors	2	2	3	3	3	4	4	4	4	4

Laminate doors include locks and keys.

Options:

laminate color

Code	Price	H	W	D	Volume (ft ³)	Weight (lb)
QM-SHH0-1530-L	1198	38	30	15	10.16	85.07
QM-SHH0-1536-L	1265	38	36	15	12.19	94.31
QM-SHH0-1542-L	1444	38	42	15	14.22	103.55
QM-SHH0-1548-L	1570	38	48	15	16.25	117.51
QM-SHH0-1554-L	1704	38	54	15	18.28	126.75
QM-SHH0-1560-L	1816	38	60	15	20.31	140.72
QM-SHH0-1566-L	1926	38	66	15	22.34	149.96
QM-SHH0-1572-L	2025	38	72	15	24.38	159.2
QM-SHH0-1578-L	2124	38	78	15	26.41	168.44
QM-SHH0-1584-L	2203	38	84	15	28.44	177.68

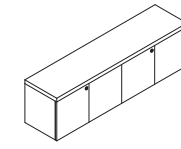

3/4" Wall-Mounted Hinged-Door Hutch

How to Specify:

Each laminate comes with matching vinyl trim color unless otherwise specified on your purchase order. Refer to the laminate finishes [on page 19](#) for details.

Notes:

Number of Openings and Doors per Hutch								
width(in)	30	36	42	48	54	60	66	72
openings	1	1	2	2	2	2	2	2
doors	2	2	3	3	3	4	4	4

Laminate doors include locks and keys.

Install wall-mounted overheads directly onto permanent studs. Please refer to installation instructions.

Options:

laminate color

Code	Price	H	W	D	Volume (ft ³)	Weight (lb)
QM-SHHW-1530-L	856	17	30	15	4.43	46.9
QM-SHHW-1536-L	908	17	36	15	5.31	52.99
QM-SHHW-1542-L	1014	17	42	15	6.2	59.08
QM-SHHW-1548-L	1068	17	48	15	7.08	65.17
QM-SHHW-1554-L	1118	17	54	15	7.97	71.26
QM-SHHW-1560-L	1222	17	60	15	8.85	77.35
QM-SHHW-1566-L	1274	17	66	15	9.74	83.44
QM-SHHW-1572-L	1327	17	72	15	10.63	89.53



conference tabletops

<u>straight tabletop</u>	86
<u>straight tabletop w/power and data</u>	88
<u>boat-shaped tabletop</u>	90
<u>boat-shaped tabletop w/power and data</u>	92
<u>racetrack tabletop</u>	94
<u>racetrack tabletop w/power and data</u>	96

Union Quick Ship Pricebook August 2025 Conference Tabletops

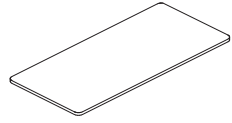

1.5" Straight Tabletop

How to Specify:

Each laminate comes with matching vinyl trim color unless otherwise specified on your purchase order. Refer to the laminate finishes [on page 19](#) for details.

Options:

laminate color

Notes:

Tabletops 72"-96"W are configured in one-piece top.

Tabletops 108"-192"W are configured in two-piece tops.

Tabletops 204"-240"W are configured in three-piece tops.

Boardroom tables with tops comprised of 2 or more pieces will not have a consistent grain pattern.

Code	Price	H	W	D	Volume (ft ³)	Weight (lb)
QMB-MSSX-7236	827	1.5	72	36	2.25	89.91
QMB-MSSX-7242	1035	1.5	72	42	2.63	104.92
QMB-MSSX-8436	950	1.5	84	36	2.63	104.92
QMB-MSSX-8442	1124	1.5	84	42	3.06	122.43
QMB-MSSX-8448	1198	1.5	84	48	3.5	139.93
QMB-MSSX-9636	1037	1.5	96	36	3	119.93
QMB-MSSX-9642	1216	1.5	96	42	3.5	139.93
QMB-MSSX-9648	1257	1.5	96	48	4	159.94
QMB-MSSX-10848	1506	1.5	108	48	4.5	179.76
QMB-MSSX-10854	1781	1.5	108	54	5.06	202.27
QMB-MSSX-10860	1811	1.5	108	60	5.63	224.78
QMB-MSSX-12048	1646	1.5	120	48	5	199.77
QMB-MSSX-12054	1945	1.5	120	54	5.63	224.78
QMB-MSSX-12060	1975	1.5	120	60	6.25	249.79
QMB-MSSX-13248	1783	1.5	132	48	5.5	219.78
QMB-MSSX-13254	2111	1.5	132	54	6.19	247.29

Code	Price	H	W	D	Volume (ft ³)	Weight (lb)
QMB-MSSX-13260	2142	1.5	132	60	6.88	274.8
QMB-MSSX-14448	1922	1.5	144	48	6	239.78
QMB-MSSX-14454	2278	1.5	144	54	6.75	269.8
QMB-MSSX-14460	2309	1.5	144	60	7.5	299.81
QMB-MSSX-15648	2064	1.5	156	48	6.5	259.69
QMB-MSSX-15654	2447	1.5	156	54	7.31	292.3
QMB-MSSX-15660	2476	1.5	156	60	8.13	324.82
QMB-MSSX-16848	2416	1.5	168	48	7	279.8
QMB-MSSX-16854	2610	1.5	168	54	7.88	314.81
QMB-MSSX-16860	2641	1.5	168	60	8.75	349.83
QMB-MSSX-18048	2451	1.5	180	48	7.5	299.81
QMB-MSSX-18054	2777	1.5	180	54	8.44	337.32
QMB-MSSX-18060	2810	1.5	180	60	9.38	374.84
QMB-MSSX-19248	2478	1.5	192	48	8	319.82
QMB-MSSX-19254	2946	1.5	192	54	9	359.83
QMB-MSSX-19260	2974	1.5	192	60	10	399.85
QMB-MSSX-20448	2749	1.5	204	48	8.5	339.63
QMB-MSSX-20454	3256	1.5	204	54	9.56	382.15
QMB-MSSX-20460	3301	1.5	204	60	10.63	424.67
QMB-MSSX-21648	2886	1.5	216	48	9	359.64
QMB-MSSX-21654	3421	1.5	216	54	10.13	404.66
QMB-MSSX-21660	3468	1.5	216	60	11.25	449.68
QMB-MSSX-22848	3026	1.5	228	48	9.5	379.65
QMB-MSSX-22854	3589	1.5	228	54	10.69	427.17
QMB-MSSX-22860	3633	1.5	228	60	11.88	474.69
QMB-MSSX-24048	3383	1.5	240	48	10	399.66
QMB-MSSX-24054	3754	1.5	240	54	11.25	449.68
QMB-MSSX-24060	3801	1.5	240	60	12.5	499.7

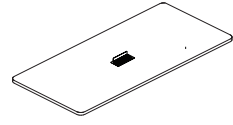

1.5" Straight Tabletop w/Power and Data

How to Specify:

Each laminate comes with matching vinyl trim color unless otherwise specified on your purchase order. Refer to the laminate finishes [on page 19](#) for details.

Notes:

Tabletops 72"-96"W are configured in one-piece top.
 Tabletops 108"-192"W are configured in two-piece tops.
 Tabletops 204"-240"W are configured in three-piece tops.
 Single-piece tabletops are equipped with one power and data grommet, two-piece tabletops are equipped with two power and data grommets, and three-piece tabletops are equipped with three power and data grommets.
 Two power and dual USB-A receptacles with 3 open slots to accommodate RJ11, RJ45, HDMI, VGA or Stereo. Items for 3 open slots must be specified and purchased separately.
 Boardroom tables with tops comprised of 2 or more pieces will not have a consistent grain pattern.

Options:

- laminate color
- grommet color (for tabletops with power and data)

Code	Price	H	W	D	Volume (ft ³)	Weight (lb)
QMB-MSSP-7236	1967	1.5	72	36	2.25	87.99
QMB-MSSP-7242	2176	1.5	72	42	2.63	102.99
QMB-MSSP-8436	2092	1.5	84	36	2.63	102.99
QMB-MSSP-8442	2266	1.5	84	42	3.06	120.5
QMB-MSSP-8448	2341	1.5	84	48	3.5	138.01
QMB-MSSP-9636	2180	1.5	96	36	3	118
QMB-MSSP-9642	2359	1.5	96	42	3.5	138.01
QMB-MSSP-9648	2399	1.5	96	48	4	158.01
QMB-MSSP-10848	3788	1.5	108	48	4.5	178.17
QMB-MSSP-10854	4064	1.5	108	54	5.06	200.68
QMB-MSSP-10860	4095	1.5	108	60	5.63	223.19
QMB-MSSP-12048	3926	1.5	120	48	5	198.18
QMB-MSSP-12054	4229	1.5	120	54	5.63	223.19
QMB-MSSP-12060	4257	1.5	120	60	6.25	248.2

Code	Price	H	W	D	Volume (ft ³)	Weight (lb)
QMB-MSSP-13248	4065	1.5	132	48	5.5	218.19
QMB-MSSP-13254	4394	1.5	132	54	6.19	245.7
QMB-MSSP-13260	4422	1.5	132	60	6.88	273.21
QMB-MSSP-14448	4205	1.5	144	48	6	238.19
QMB-MSSP-14454	4560	1.5	144	54	6.75	268.21
QMB-MSSP-14460	4592	1.5	144	60	7.5	298.22
QMB-MSSP-15648	4344	1.5	156	48	6.5	258.2
QMB-MSSP-15654	4727	1.5	156	54	7.31	290.72
QMB-MSSP-15660	4759	1.5	156	60	8.13	323.23
QMB-MSSP-16848	4701	1.5	168	48	7	278.21
QMB-MSSP-16854	4893	1.5	168	54	7.88	313.22
QMB-MSSP-16860	4924	1.5	168	60	8.75	348.24
QMB-MSSP-18048	4730	1.5	180	48	7.5	298.22
QMB-MSSP-18054	5058	1.5	180	54	8.44	335.73
QMB-MSSP-18060	5090	1.5	180	60	9.38	373.25
QMB-MSSP-19248	4762	1.5	192	48	8	318.23
QMB-MSSP-19254	5226	1.5	192	54	9	358.24
QMB-MSSP-19260	5255	1.5	192	60	10	398.26
QMB-MSSP-20448	6170	1.5	204	48	8.5	337.25
QMB-MSSP-20454	6680	1.5	204	54	9.56	379.77
QMB-MSSP-20460	6725	1.5	204	60	10.63	422.28
QMB-MSSP-21648	6310	1.5	216	48	9	357.26
QMB-MSSP-21654	6846	1.5	216	54	10.13	402.28
QMB-MSSP-21660	6889	1.5	216	60	11.25	447.29
QMB-MSSP-22848	6447	1.5	228	48	9.5	377.27
QMB-MSSP-22854	7011	1.5	228	54	10.69	424.79
QMB-MSSP-22860	7055	1.5	228	60	11.88	472.3
QMB-MSSP-24048	6806	1.5	240	48	10	397.27
QMB-MSSP-24054	7178	1.5	240	54	11.25	447.29
QMB-MSSP-24060	7222	1.5	240	60	12.5	497.31

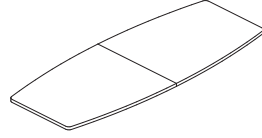
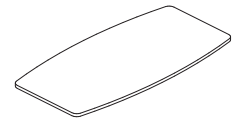

1.5" Boat-Shaped Tabletop

How to Specify:

Each laminate comes with matching vinyl trim color unless otherwise specified on your purchase order. Refer to the laminate finishes [on page 19](#) for details.

Notes:

Tabletops 72"-96"W are configured in one-piece top.

Tabletops 108"-192"W are configured in two-piece tops.

Tabletops 204"-240"W are configured in three-piece tops.

Boardroom tables with tops comprised of 2 or more pieces will not have a consistent grain pattern.

Options:

laminate color

Code	Price	H	W	D	Volume (ft ³)	Weight (lb)
QMB-MBBX-7236	827	1.5	72	36	2.25	80.81
QMB-MBBX-7242	1035	1.5	72	42	2.63	95.09
QMB-MBBX-8436	950	1.5	84	36	2.63	93.4
QMB-MBBX-8442	1124	1.5	84	42	3.06	110.91
QMB-MBBX-8448	1198	1.5	84	48	3.5	128.42
QMB-MBBX-9636	1037	1.5	96	36	3	106.72
QMB-MBBX-9642	1216	1.5	96	42	3.5	126.73
QMB-MBBX-9648	1257	1.5	96	48	4	146.74
QMB-MBBX-10848	1506	1.5	108	48	4.5	164.78
QMB-MBBX-19260	2974	1.5	192	60	10	373.16

Code	Price	H	W	D	Volume (ft ³)	Weight (lb)
QMB-MBBX-20448	2749	1.5	204	48	8.5	344.36
QMB-MBBX-20454	3256	1.5	204	54	9.56	353.87
QMB-MBBX-20460	3301	1.5	204	60	10.63	396.39
QMB-MBBX-21648	2886	1.5	216	48	9	329.69
QMB-MBBX-21654	3421	1.5	216	54	10.13	374.71
QMB-MBBX-21660	3468	1.5	216	60	11.25	419.73
QMB-MBBX-22848	3026	1.5	228	48	9.5	348.03
QMB-MBBX-22854	3589	1.5	228	54	10.69	395.55
QMB-MBBX-22860	3633	1.5	228	60	11.88	443.07
QMB-MBBX-24048	3383	1.5	240	48	10	366.37
QMB-MBBX-24054	3754	1.5	240	54	11.25	416.39
QMB-MBBX-24060	3801	1.5	240	60	12.5	466.41

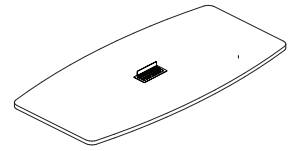

1.5" Boat-Shaped Tabletop w/Power and Data

How to Specify:

Each laminate comes with matching vinyl trim color unless otherwise specified on your purchase order. Refer to the laminate finishes [on page 19](#) for details.

Notes:

Tabletops 72"-96"W are configured in one-piece top.
 Tabletops 108"-192"W are configured in two-piece tops.
 Tabletops 204"-240"W are configured in three-piece tops.
 Single-piece tabletops are equipped with one power and data grommet, two-piece tabletops are equipped with two power and data grommets, and three-piece tabletops are equipped with three power and data grommets.
 Two power and dual USB-A receptacles with 3 open slots to accommodate RJ11, RJ45, HDMI, VGA or Stereo. Items for 3 open slots must be specified and purchased separately.
 Boardroom tables with tops comprised of 2 or more pieces will not have a consistent grain pattern.

Options:

- laminate color
- grommet color (for tabletops with power and data)

Code	Price	H	W	D	Volume (ft ³)	Weight (lb)
QMB-MBBP-7236	1967	1.5	72	36	2.25	78.15
QMB-MBBP-7242	2176	1.5	72	42	2.63	93.16
QMB-MBBP-8436	2092	1.5	84	36	2.63	91.47
QMB-MBBP-8442	2266	1.5	84	42	3.06	108.98
QMB-MBBP-8448	2341	1.5	84	48	3.5	126.49
QMB-MBBP-9636	2180	1.5	96	36	3	104.8
QMB-MBBP-9642	2359	1.5	96	42	3.5	124.8
QMB-MBBP-9648	2399	1.5	96	48	4	144.81
QMB-MBBP-10848	3788	1.5	108	48	4.5	160.92
QMB-MBBP-10854	4064	1.5	108	54	5.06	183.44
QMB-MBBP-10860	4095	1.5	108	60	5.63	205.94
QMB-MBBP-12048	3926	1.5	120	48	5	179.26
QMB-MBBP-12054	4229	1.5	120	54	5.63	204.26
QMB-MBBP-12060	4257	1.5	120	60	6.25	229.28

Code	Price	H	W	D	Volume (ft ³)	Weight (lb)
QMB-MBBP-13248	4065	1.5	132	48	5.5	197.6
QMB-MBBP-13254	4394	1.5	132	54	6.19	225.1
QMB-MBBP-13260	4422	1.5	132	60	6.88	252.62
QMB-MBBP-14448	4205	1.5	144	48	6	215.92
QMB-MBBP-14454	4560	1.5	144	54	6.75	245.94
QMB-MBBP-14460	4592	1.5	144	60	7.5	275.94
QMB-MBBP-15648	4344	1.5	156	48	6.5	234.26
QMB-MBBP-15654	4727	1.5	156	54	7.31	266.78
QMB-MBBP-15660	4759	1.5	156	60	8.13	299.28
QMB-MBBP-16848	4701	1.5	168	48	7	252.6
QMB-MBBP-16854	4893	1.5	168	54	7.88	287.6
QMB-MBBP-16860	4924	1.5	168	60	8.75	322.62
QMB-MBBP-18048	4730	1.5	180	48	7.5	270.92
QMB-MBBP-18054	5058	1.5	180	54	8.44	308.44
QMB-MBBP-18060	5090	1.5	180	60	9.38	345.96
QMB-MBBP-19248	4762	1.5	192	48	8	289.26
QMB-MBBP-19254	5226	1.5	192	54	9	329.28
QMB-MBBP-19260	5255	1.5	192	60	10	369.3
QMB-MBBP-20448	6170	1.5	204	48	8.5	308.97
QMB-MBBP-20454	6680	1.5	204	54	9.56	351.49
QMB-MBBP-20460	6725	1.5	204	60	10.63	394.01
QMB-MBBP-21648	6310	1.5	216	48	9	327.31
QMB-MBBP-21654	6846	1.5	216	54	10.13	373.33
QMB-MBBP-21660	6889	1.5	216	60	11.25	417.35
QMB-MBBP-22848	6447	1.5	228	48	9.5	345.65
QMB-MBBP-22854	7011	1.5	228	54	10.69	393.17
QMB-MBBP-22860	7055	1.5	228	60	11.88	440.69
QMB-MBBP-24048	6806	1.5	240	48	10	363.99
QMB-MBBP-24054	7178	1.5	240	54	11.25	414.01
QMB-MBBP-24060	7222	1.5	240	60	12.5	464.03



1.5" Racetrack Tabletop

How to Specify:

Each laminate comes with matching vinyl trim color unless otherwise specified on your purchase order. Refer to the laminate finishes [on page 19](#) for details.

Notes:

Tabletops 72"-96"W are configured in one-piece top.

Tabletops 108"-192"W are configured in two-piece tops.

Tabletops 204"-240"W are configured in three-piece tops.

Boardroom tables with tops comprised of 2 or more pieces will not have a consistent grain pattern.

Options:

laminate color

Code	Price	H	W	D	Volume (ft ³)	Weight (lb)
QMB-MRRX-7236	827	1.5	72	36	2.25	80.37
QMB-MRRX-7242	1035	1.5	72	42	2.63	91.89
QMB-MRRX-8436	950	1.5	84	36	2.63	95.38
QMB-MRRX-8442	1124	1.5	84	42	3.06	109.4
QMB-MRRX-8448	1198	1.5	84	48	3.5	122.88
QMB-MRRX-9636	1037	1.5	96	36	3	110.38
QMB-MRRX-9642	1216	1.5	96	42	3.5	126.9
QMB-MRRX-9648	1257	1.5	96	48	4	142.89
QMB-MRRX-10848	1506	1.5	108	48	4.5	162.62
QMB-MRRX-10854	1781	1.5	108	54	5.06	180.56
QMB-MRRX-10860	1811	1.5	108	60	5.63	197.96
QMB-MRRX-12048	1646	1.5	120	48	5	182.6
QMB-MRRX-12054	1945	1.5	120	54	5.63	203.06
QMB-MRRX-12060	1975	1.5	120	60	6.25	222.98

Code	Price	H	W	D	Volume (ft ³)	Weight (lb)
QMB-MRRX-13248	1783	1.5	132	48	5.5	202.62
QMB-MRRX-13254	2111	1.5	132	54	6.19	225.58
QMB-MRRX-13260	2142	1.5	132	60	6.88	247.98
QMB-MRRX-14448	1922	1.5	144	48	6	222.64
QMB-MRRX-14454	2278	1.5	144	54	6.75	248.08
QMB-MRRX-14460	2309	1.5	144	60	7.5	273
QMB-MRRX-15648	2064	1.5	156	48	6.5	242.64
QMB-MRRX-15654	2447	1.5	156	54	7.31	270.6
QMB-MRRX-15660	2476	1.5	156	60	8.13	298.02
QMB-MRRX-16848	2416	1.5	168	48	7	262.66
QMB-MRRX-16854	2610	1.5	168	54	7.88	293.1
QMB-MRRX-16860	2641	1.5	168	60	8.75	323.02
QMB-MRRX-18048	2451	1.5	180	48	7.5	282.66
QMB-MRRX-18054	2777	1.5	180	54	8.44	315.62
QMB-MRRX-18060	2810	1.5	180	60	9.38	348.04
QMB-MRRX-19248	2478	1.5	192	48	8	302.66
QMB-MRRX-19254	2946	1.5	192	54	9	338.12
QMB-MRRX-19260	2974	1.5	192	60	10	373.04
QMB-MRRX-20448	2749	1.5	204	48	8.5	322.58
QMB-MRRX-20454	3256	1.5	204	54	9.56	360.53
QMB-MRRX-20460	3301	1.5	204	60	10.63	397.95
QMB-MRRX-21648	2886	1.5	216	48	9	342.59
QMB-MRRX-21654	3421	1.5	216	54	10.13	383.04
QMB-MRRX-21660	3468	1.5	216	60	11.25	422.97
QMB-MRRX-22848	3026	1.5	228	48	9.5	362.59
QMB-MRRX-22854	3589	1.5	228	54	10.69	405.55
QMB-MRRX-22860	3633	1.5	228	60	11.88	447.97
QMB-MRRX-24048	3383	1.5	240	48	10	382.6
QMB-MRRX-24054	3754	1.5	240	54	11.25	428.06
QMB-MRRX-24060	3801	1.5	240	60	12.5	472.98

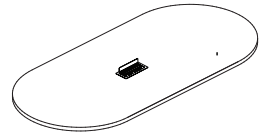

1.5" Racetrack Tabletop w/Power and Data

How to Specify:

Each laminate comes with matching vinyl trim color unless otherwise specified on your purchase order. Refer to the laminate finishes [on page 19](#) for details.

Notes:

Tabletops 72"-96"W are configured in one-piece top.
 Tabletops 108"-192"W are configured in two-piece tops.
 Tabletops 204"-240"W are configured in three-piece tops.
 Single-piece tabletops are equipped with one power and data grommet, two-piece tabletops are equipped with two power and data grommets, and three-piece tabletops are equipped with three power and data grommets.
 Two power and dual USB-A receptacles with 3 open slots to accommodate RJ11, RJ45, HDMI, VGA or Stereo. Items for 3 open slots must be specified and purchased separately.
 Boardroom tables with tops comprised of 2 or more pieces will not have a consistent grain pattern.

Options:

- laminate color
- grommet color (for tabletops with power and data)

Code	Price	H	W	D	Volume (ft ³)	Weight (lb)
QMB-MRRP-7236	1967	1.5	72	36	2.25	78.44
QMB-MRRP-7242	2176	1.5	72	42	2.63	89.96
QMB-MRRP-8436	2092	1.5	84	36	2.63	93.45
QMB-MRRP-8442	2266	1.5	84	42	3.06	107.47
QMB-MRRP-8448	2341	1.5	84	48	3.5	120.95
QMB-MRRP-9636	2180	1.5	96	36	3	108.46
QMB-MRRP-9642	2359	1.5	96	42	3.5	124.98
QMB-MRRP-9648	2399	1.5	96	48	4	140.96
QMB-MRRP-10848	3788	1.5	108	48	4.5	158.76
QMB-MRRP-10854	4064	1.5	108	54	5.06	176.7
QMB-MRRP-10860	4095	1.5	108	60	5.63	194.12
QMB-MRRP-12048	3926	1.5	120	48	5	178.76
QMB-MRRP-12054	4229	1.5	120	54	5.63	199.22
QMB-MRRP-12060	4257	1.5	120	60	6.25	219.12

Code	Price	H	W	D	Volume (ft ³)	Weight (lb)
QMB-MRRP-13248	4065	1.5	132	48	5.5	198.78
QMB-MRRP-13254	4394	1.5	132	54	6.19	221.72
QMB-MRRP-13260	4422	1.5	132	60	6.88	244.14
QMB-MRRP-14448	4205	1.5	144	48	6	218.78
QMB-MRRP-14454	4560	1.5	144	54	6.75	244.24
QMB-MRRP-14460	4592	1.5	144	60	7.5	269.14
QMB-MRRP-15648	4344	1.5	156	48	6.5	238.78
QMB-MRRP-15654	4727	1.5	156	54	7.31	266.74
QMB-MRRP-15660	4759	1.5	156	60	8.13	294.16
QMB-MRRP-16848	4701	1.5	168	48	7	258.8
QMB-MRRP-16854	4893	1.5	168	54	7.88	289.24
QMB-MRRP-16860	4924	1.5	168	60	8.75	319.16
QMB-MRRP-18048	4730	1.5	180	48	7.5	278.8
QMB-MRRP-18054	5058	1.5	180	54	8.44	311.76
QMB-MRRP-18060	5090	1.5	180	60	9.38	344.18
QMB-MRRP-19248	4762	1.5	192	48	8	298.82
QMB-MRRP-19254	5226	1.5	192	54	9	334.24
QMB-MRRP-19260	5255	1.5	192	60	10	369.18
QMB-MRRP-20448	6170	1.5	204	48	8.5	320.19
QMB-MRRP-20454	6680	1.5	204	54	9.56	358.15
QMB-MRRP-20460	6725	1.5	204	60	10.63	395.57
QMB-MRRP-21648	6310	1.5	216	48	9	340.2
QMB-MRRP-21654	6846	1.5	216	54	10.13	380.66
QMB-MRRP-21660	6889	1.5	216	60	11.25	420.58
QMB-MRRP-22848	6447	1.5	228	48	9.5	360.21
QMB-MRRP-22854	7011	1.5	228	54	10.69	403.17
QMB-MRRP-22860	7055	1.5	228	60	11.88	445.59
QMB-MRRP-24048	6806	1.5	240	48	10	380.22
QMB-MRRP-24054	7178	1.5	240	54	11.25	425.68
QMB-MRRP-24060	7222	1.5	240	60	12.5	470.6



Union Quick Ship Pricebook
August 2025
Bases

bases

<u>gable & modesty base</u>	104
<u>for straight tabletop</u>	104
<u>for racetrack top</u>	106
<u>elliptical base</u>	108
<u>for straight tabletop</u>	108
<u>for racetrack top</u>	110

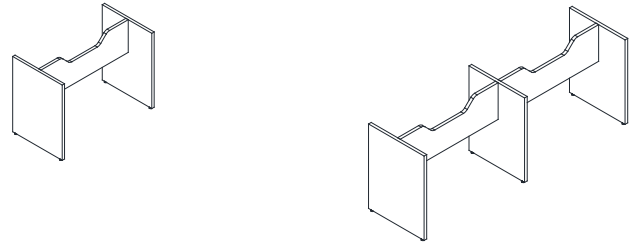

Notes:

Match table base size to table top size.

Options:

laminate color

for Straight/Boat Tabletops

Code	Price	H	W	D	Volume (ft ³)	Weight (lb)
QMB-B4-7236	561	28	36	21	12.25	41.45
QMB-B4-7242	561	28	42	24	16.33	52.15
QMB-B4-8436	561	28	36	21	12.25	44.55
QMB-B4-8442	575	28	42	24	16.33	55.89
QMB-B4-8448	628	28	48	84	65.33	51.53
QMB-B4-9636	575	28	36	96	56	43.54
QMB-B4-9642	607	28	42	96	65.33	47.38
QMB-B4-9648	680	28	48	30	23.33	63.75
QMB-B4-10848	960	28	48	30	23.33	67.75
QMB-B4-10854	1055	28	54	108	94.5	88.49
QMB-B4-10860	1147	28	60	108	105	100
QMB-B4-12048	999	28	48	120	93.33	71.99
QMB-B4-12054	1096	28	54	120	105	91.82
QMB-B4-12060	1189	28	60	120	116.67	103.34
QMB-B4-13248	1040	28	48	30	23.33	76.23
QMB-B4-13254	1136	28	54	132	115.5	95.16
QMB-B4-13260	1225	28	60	132	128.33	106.67
QMB-B4-14448	1087	28	48	30	23.33	80.47

Code	Price	H	W	D	Volume (ft ³)	Weight (lb)
QMB-B4-14454	1183	28	54	144	126	98.88
QMB-B4-14460	1274	28	60	144	140	110.4
QMB-B4-15648	1128	28	48	156	121.33	90.7
QMB-B4-15654	1221	28	54	156	136.5	102.22
QMB-B4-15660	1314	28	60	156	151.67	113.73
QMB-B4-16848	1167	28	48	168	130.67	94.04
QMB-B4-16854	1262	28	54	168	147	105.55
QMB-B4-16860	1353	28	60	168	163.33	117.07
QMB-B4-18048	1207	28	48	180	140	97.37
QMB-B4-18054	1304	28	60	180	175	108.98
QMB-B4-18060	1396	28	60	180	175	120.4
QMB-B4-19248	1248	28	48	192	149.33	100.71
QMB-B4-19254	1344	28	54	192	168	112.22
QMB-B4-19260	1436	28	60	192	186.67	123.74
QMB-B4-20448	1528	28	48	204	158.67	122.06
QMB-B4-20454	1657	28	54	204	178.5	137.42
QMB-B4-20460	1777	28	60	204	198.33	152.77
QMB-B4-21648	1573	28	48	216	168	125.79
QMB-B4-21654	1702	28	54	216	189	141.14
QMB-B4-21660	1820	28	60	216	210	156.5
QMB-B4-22848	1617	28	48	228	177.33	129.13
QMB-B4-22854	1742	28	54	228	199.5	144.48
QMB-B4-22860	1862	28	60	228	221.67	159.84
QMB-B4-24048	1656	28	48	228	177.33	132.46
QMB-B4-24054	1783	28	54	240	210	147.81
QMB-B4-24060	1904	28	60	240	233.33	163.17

for Racetrack Top						
Code	Price	H	W	D	Volume (ft ³)	Weight (lb)
QMB-B4-8448R	613	28	48	84	1.24	50.41
QMB-B4-9648R	658	28	48	96	74.67	53.95
QMB-B4-10848R	946	28	48	108	84	75.86
QMB-B4-10854R	1028	28	54	108	94.5	86.26
QMB-B4-10860R	1107	28	60	108	105	96.67
QMB-B4-12048R	985	28	48	120	93.33	79.19
QMB-B4-12054R	1067	28	54	120	105	89.6
QMB-B4-12060R	1147	28	60	120	116.67	100
QMB-B4-13248R	1028	28	48	132	102.67	82.53
QMB-B4-13254R	1108	28	54	132	115.5	92.93
QMB-B4-13260R	1189	28	60	132	128.33	103.34
QMB-B4-14448R	1072	28	48	144	112	86.26
QMB-B4-14454R	1153	28	54	144	126	96.66
QMB-B4-14460R	1230	28	60	144	140	106.67
QMB-B4-15648R	1110	28	48	156	121.33	89.59
QMB-B4-15654R	1194	28	54	156	136.5	99.99
QMB-B4-15660R	1274	28	60	156	151.67	110.4
QMB-B4-16848R	1153	28	48	168	130.67	92.92
QMB-B4-16854R	1234	28	54	168	147	103.33
QMB-B4-16860R	1314	28	60	168	163.33	113.73
QMB-B4-18048R	1194	28	48	180	140	96.26
QMB-B4-18054R	1276	28	54	180	157.5	106.66

Code	Price	H	W	D	Volume (ft ³)	Weight (lb)
QMB-B4-18060R	1353	28	60	180	175	117.07
QMB-B4-19248R	1233	28	48	192	149.33	99.59
QMB-B4-19254R	1315	28	54	192	168	110
QMB-B4-19260R	1396	28	60	192	186.67	120.4
QMB-B4-20448R	1513	28	48	204	158.67	120.97
QMB-B4-20454R	1629	28	54	204	178.5	135.19
QMB-B4-20460R	1734	28	60	204	198.33	149.44
QMB-B4-21648R	1558	28	48	216	168	124.68
QMB-B4-21654R	1672	28	54	216	189	138.92
QMB-B4-21660R	1780	28	60	216	210	152.77
QMB-B4-22848R	1598	28	48	228	177.33	128.01
QMB-B4-22854R	1715	28	54	228	199.5	142.26
QMB-B4-22860R	1820	28	60	228	221.67	156.5
QMB-B4-24048R	1641	28	48	240	186.67	131.35
QMB-B4-24054R	1756	28	54	240	210	145.59
QMB-B4-24060R	1862	28	60	240	233.33	159.83

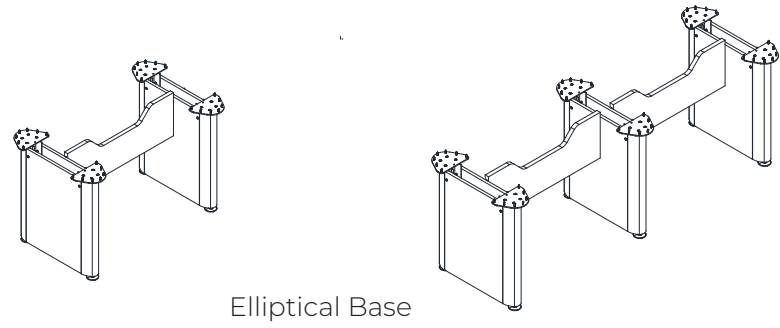

Elliptical Base

Notes:

Match table base size to table top size.

Options:

laminate color

metal color

for Straight/Boat Tabletops

Code	Price	H	W	D	Volume (ft ³)	Weight (lb)
QMB-B5-7236	1479	28	36	72	42	57.58
QMB-B5-7242	1531	28	42	72	49	63
QMB-B5-8436	1515	28	36	84	49	60.91
QMB-B5-8442	1569	28	42	84	57.17	66.33
QMB-B5-8448	1658	28	48	84	65.33	71.75
QMB-B5-9636	1556	28	36	96	56	64.45
QMB-B5-9642	1607	28	42	96	65.33	69.86
QMB-B5-9648	1697	28	48	96	74.67	75.3
QMB-B5-10848	2495	28	48	30	23.33	106.9
QMB-B5-10854	2590	28	54	108	94.5	123.15
QMB-B5-10860	2739	28	60	108	105	139.41
QMB-B5-12048	2534	28	48	120	93.33	110.23
QMB-B5-12054	2627	28	54	120	105	126.49

Code	Price	H	W	D	Volume (ft ³)	Weight (lb)
QMB-B5-12060	2777	28	60	120	116.67	142.75
QMB-B5-13248	2571	28	48	132	102.67	113.57
QMB-B5-13254	2664	28	54	132	115.5	129.82
QMB-B5-13260	2814	28	60	132	128.33	146.08
QMB-B5-14448	2615	28	48	144	112	117.29
QMB-B5-14454	2706	28	54	144	126	133.55
QMB-B5-14460	2856	28	60	144	140	149.81
QMB-B5-15648	2653	28	48	156	121.33	120.63
QMB-B5-15654	2745	28	54	156	136.5	136.88
QMB-B5-15660	2896	28	60	156	151.67	153.14
QMB-B5-16848	2685	28	48	168	130.67	123.96
QMB-B5-16854	2778	28	54	168	147	140.22
QMB-B5-16860	2927	28	60	168	163.33	156.48
QMB-B5-18048	2728	28	48	180	140	127.3
QMB-B5-18054	2818	28	54	180	157.5	143.55
QMB-B5-18060	2972	28	60	180	175	159.81
QMB-B5-19248	2764	28	48	192	149.33	130.63
QMB-B5-19254	2856	28	54	192	168	146.89
QMB-B5-19260	3010	28	60	192	186.67	163.15
QMB-B5-20448	4194	28	48	204	158.67	161.69
QMB-B5-20454	4320	28	54	204	178.5	183.37
QMB-B5-20460	4521	28	60	204	198.33	205.04

for Racetrack Tabletop						
Code	Price	H	W	D	Volume (ft ³)	Weight (lb)
QMB-B5-8448R	1646	28	48	84	65.33	70.64
QMB-B5-9648R	1686	28	48	96	74.67	74.17
QMB-B5-10848R	2484	28	48	108	84	105.79
QMB-B5-10854R	2563	28	54	108	94.5	120.93
QMB-B5-10860R	2699	28	60	108	105	136.08
QMB-B5-12048R	2524	28	48	120	93.33	109.12
QMB-B5-12054R	2602	28	54	120	105	124.27
QMB-B5-12060R	2739	28	60	120	116.67	139.41
QMB-B5-13248R	2561	28	48	132	102.67	112.45
QMB-B5-13254R	2639	28	54	132	115.5	127.6
QMB-B5-13260R	2777	28	60	132	128.33	142.75
QMB-B5-14448R	2505	28	48	144	112	116.18
QMB-B5-14454R	2596	28	54	144	126	130.93
QMB-B5-14460R	2814	28	60	144	140	146.08
QMB-B5-15648R	2640	28	48	156	121.33	119.52
QMB-B5-15654R	2718	28	54	156	136.5	134.66
QMB-B5-15660R	2856	28	60	156	151.67	149.81
QMB-B5-16848R	2678	28	48	168	130.67	122.85
QMB-B5-16854R	2756	28	54	168	147	138
QMB-B5-16860R	2896	28	60	168	163.33	153.14
QMB-B5-18048R	2716	28	48	180	140	126.19
QMB-B5-18054R	2792	28	54	180	157.5	141.33
QMB-B5-18060R	2927	28	60	180	175	156.48
QMB-B5-19248R	2753	28	48	192	149.33	129.52
QMB-B5-19254R	2831	28	54	192	168	144.67

Code	Price	H	W	D	Volume (ft ³)	Weight (lb)
QMB-B5-19260R	2972	28	60	192	186.67	159.81
QMB-B5-20448R	4178	28	48	204	158.67	160.58
QMB-B5-20454R	4280	28	54	204	178.5	181.14
QMB-B5-20460R	4463	28	60	204	198.33	201.71
QMB-B5-21648R	4097	28	48	216	168	164.31
QMB-B5-21654R	4223	28	54	216	189	184.48
QMB-B5-21660R	4524	28	60	216	210	205.04
QMB-B5-22848R	4297	28	48	228	177.33	167.64
QMB-B5-22854R	4397	28	54	228	199.5	188.2
QMB-B5-22860R	4579	28	60	228	221.67	208.77
QMB-B5-24048R	4351	28	48	240	186.67	170.97
QMB-B5-24054R	4457	28	54	240	210	191.54
QMB-B5-24060R	4637	28	60	240	233.33	212.1



Union Quick Ship Pricebook
August 2025

Accessories

accessories

<u>keyboard tray</u>	114
<u>PET tackboard for hutch</u>	115
<u>pencil drawer</u>	116
<u>task light</u>	117
<u>monitor arm</u>	118
<u>ellora grommet add-ons</u>	119

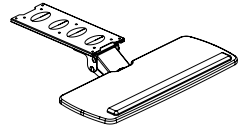

Articulating Keyboard Tray

What's Included:

Keyboard Tray, installation hardware.

How to Specify:

The articulating keyboards are available only in black.

Notes:

Keyboard trays provide adjustable ergonomic support for individuals in multi-task environments

Code	Price	H	W	D	Volume (ft ³)	Weight (lb)
Articulating Keyboard Tray						
V-KASX-2510	421	0	25	10	0	15

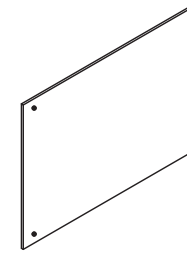

21"H Tackboard for Hutch

Options:

P.E.T. color (for tackboard)

Code	Price	H	W	D	Volume (ft ³)	Weight (lb)
21"H PET Tackboard for Hutch						
Q-ATH0-2127	314	21	27	0.5	0.16	2.7
Q-ATH0-2133	324	21	33	0.5	0.2	3.1
Q-ATH0-2139	419	21	39	0.5	0.24	3.5
Q-ATH0-2145	438	21	45	0.5	0.27	3.9
Q-ATH0-2151	621	21	51	0.5	0.31	4.3
Q-ATH0-2157	626	21	57	0.5	0.35	4.7
Q-ATH0-2163	632	21	63	0.5	0.38	5.1
Q-ATH0-2169	637	21	69	0.5	0.42	5.5
Q-ATH0-2175	745	21	75	0.5	0.46	5.9
Q-ATH0-2181	750	21	81	0.5	0.49	6.3

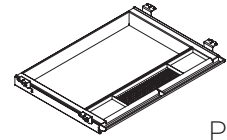

Plastic Pencil Drawer

Notes:

Plastic Pencil Drawers are available in black only.

Code	Price	H	W	D	Volume (ft ³)	Weight (lb)
V-ADPP	92	2.8	21	16	0.62	2

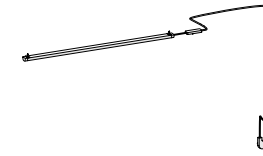

Task Light

Notes:

Task light comes in silver finish.

V-ELU-3666 fits under hutches between 36" and 66"W

V-ELU-7284 fits under hutches between 72"-84"W

Code	Price	H	W	D	Volume (ft ³)	Weight (lb)
V-ELU-3666	441	17	36.39	15	4.43	13.7
V-ELU-7284	817	17	48.15	15	-	17.9

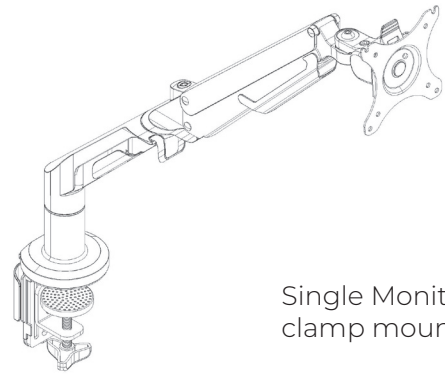

Single Monitor Arm - clamp mount

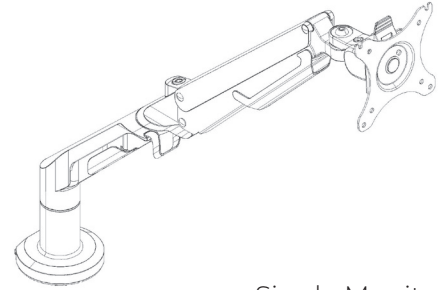

Single Monitor Arm - grommet mount

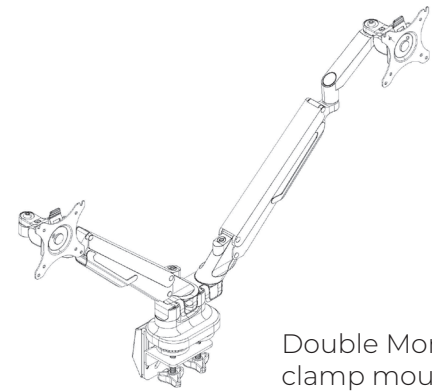

Double Monitor Arm - clamp mount

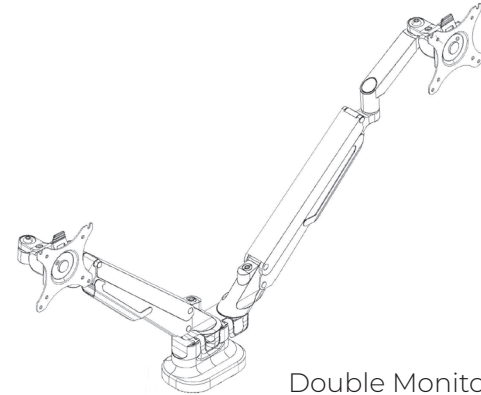

Double Monitor Arm - grommet mount

What's Included:

One monitor arm and installation hardware for both clamp and grommet mount

How to Specify:

- Specify type

Dimensions:

Vesa: 75x75 and 100x100

Notes:

Available in silver only

Single Monitor Arm

- Screen Size - 17"-36"
- Load Capacity - 6.6-26.4lbs/3-12kg
- Tilt Range - -90 degrees - -15 degrees

Dual Monitor Arm

- Screen Size - 17"-32"
- Load Capacity - 4.4-19.8lbs/2-9kg
- Tilt Range - -90 degrees - -15 degrees

Code	Price
Monitor Arm - Single Mount	
V-AFMA-01	391
Monitor Arm - Double Mount	
V-AFMA-02	652



QM-RJ45

RJ45 Cat6 Plug With Cord 72", Black



QM-HDMI

HDMI Coupler, 18" Cord, Female/Female Connection, Black

Code	Price
QM-RJ45	211
QM-HDMI	205