

tayco[®]

Switch Canada
Pricebook
April 2025

Contents

Statement of Line	vi
Space Division	vi
Worksurface & Supports	viii
Connections & Trims	x
Storage	xi
Electrics	xii
Accessories	xii
Segment Types	xiii
Caution	xiv
Application Guidelines	xv
Types of Surfaces	xv
Gallery Panel Planning	xvi
Connection Types - Panel Doors	xvii
Connection Types - Sliding Doors	xviii
Connection Types - Fillers	xix
Wire Play Planning	xxi
Panels	2
Standard Panel - Monolithic	4
Non Powered Capable	4
Powered Capable	8
Standard - Glazed	12
Non Powered	12
Powered	28
Elevated - Monolithic	44
Elevated - Glazed	48
Gallery - Woodgrain	64
Horizontal Grain	64
Vertical Grain	76
Gallery - Solid	88
Frameless Blade	100
Standard & Elevated Panel Mounted Glass	100
Standard & Elevated Panel Mounted Acrylic	102
Gallery Panel Mounted Glass	104
Gallery Panel Mounted Acrylic	106

Panel Mounted Add Ons	108
Whiteboard	108
Tackboard	109
Doors	110
Hinged	110
Sliding	112
Connections & Trims	116
2-Way Connection	118
3-Way T Connection	119
4-Way X Connection	120
Top Cap	121
Full Height End Trim	122
Partial Height End Trim	123
Full Height T Filler	124
Partial Height T Filler	125
90 Degree Filler-Full Height	126
90 Degree Filler- Partial Height	127
Straight Filler	128
Gallery Panel Filler	129
Adjustable Wall Connector	130
Spline	131
Worksurfaces	132
Straight w grommet	134
Straight Worksurface w/o Grommet	136
Straight Worksurface w/ Wire Play	140
5-sided w Grommet	144
Straight Worksurface with Wire Play	146
Unitized w/ Grommet	148
Unitized w/ Wire Play	150
Transaction Top	152

Supports	154
Ladder Gable	156
Standard Panel	156
Gallery Panel	158
Freestanding Panel	160
Laminate Gable	161
Standard Panel	161
Gallery Panel	162
Freestanding	163
Wrap Gable	164
Standard Panel	164
Gallery Panel	165
Tech Drop	166
Cantilever	167
Standard Panel	167
Gallery Panel	168
Standard Panel Mount Corner Bracket	170
Flush Plates	171
Storage Support Bracket	172
Fixed Credenza Support Bracket	173
90 Degree Storage Bracket	174
Horizontal Surface Support	175
Electrics	176
Power Module	178
Starter Harness	179
Connector Harness	180
Male to Female Extension Harness	182
New York Junction Box	183
Chicago Electrical Box	184
Power Pole	185
Communication Kit	186
Conversion Kit	187

Storage	188
Pedestals	190
Underdesk Pedestal	190
Mobile	191
Upholstered Seat Pad	192
Lateral File	193
Underdesk	193
Freestanding	194
Credenza	195
Open Lateral	195
Storage Tower	196
Wardrobe Tower	197
Combo Tower	198
w/ Front Access	198
w/ Side Access	200
Panel Mounted Overheads - Cabinet	202
Flipper	202
Hinged Door	203
Shared	204
Cubby	206
Metal Shelf	207
Accessories	208
Cable manager	210
Desktop Power Module	211
Tasklight	212
Monitor Arm	213
Keyboard Tray	214
Work Organizers	215
Accessory Rail	216
Pencil Tray	217

Statement of Line

Space Division

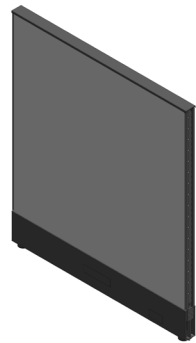

L-PPFO
Standard Fabric Panel
H: 34", 42", 50", 66", 82"
W: 24" - 72"
*66"H available up to 60"W
*82"H available up to 48"W



L-PPLO
Standard Laminate Panel
H: 34", 42", 50", 66", 82"
W: 24" - 48"
*82"H available up to 36"W



L-PPFCA/LPPFCG
L-PPFFA/L-PPFFG
Standard Segmented Laminate Panel
H: 34", 42", 50", 66", 82"
W: 24" - 60"
*82"H available up to 48"W



L-PPLCA/LPPLCG
L-PPLFA/L-PPLFG
Standard Segmented Laminate Panel
H: 34", 42", 50", 66", 82"
W: 24" - 60"
*82"H available up to 36"W



L-PYSE-S1/ L-PYSM-S1
Solid Single Gallery Panel
H: 34", 42", 50"
W: 26" - 74"



L-PYGE-S1/L-PYSM-S1
Woodgrain Single Gallery Panel
H: 34", 42", 50"
W: 26" - 56"



L-PD00
Hinge Door
H: 82"
W: 36", 42"



L-PDS
Sliding Door
H: 66"
W: 30", 36", 42"

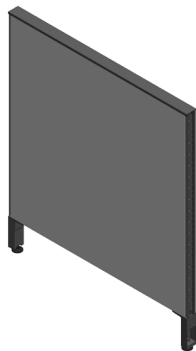

L-PEFO
Elevated Fabric Panel
H: 34", 42", 50", 66", 82"
W: 24" - 72"
*66"H available up to 60"W
*82"H available up to 48"W



L-PELO
Elevated Laminate Panel
H: 34", 42", 50", 66", 82"
W: 24" - 48"
*82"H available up to 36"W



L-PEFCA/LPEFCG
L-PEFFA/L-PEFFG
Elevated Glazed Fabric Panel
H: 34", 42", 50", 66", 82"
W: 24" - 60"
*82"H available up to 48"W



L-PELCA/LPELCG
L-PELFA/L-PELFG
Elevated Glazed Laminate Panel
H: 34", 42", 50", 66", 82"
W: 24" - 60"
*82"H available up to 36"W

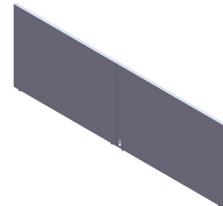

L-PYSE-D1/D2/ L-PYSM-D1/D2
Solid Double Gallery Panel
H: 34", 42", 50"
W: 42" - 146"



L-PYGE-01/02/ L-PYGM-D1/D2
Woodgrain Double Gallery Panel
H: 34", 42", 50"
W: 42" - 110"

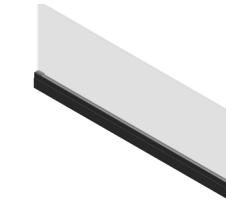

L-VG-P/ L-VA-P
Frameless Glass Standard Panel Mount
H: 8", 16", 20"
W: 24" - 72"

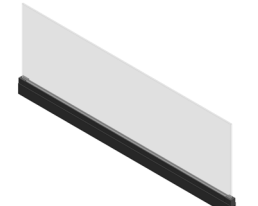

L-VG-Y/ L-VA-Y
Frameless Glass Gallery Panel Mount
H: 8", 16"
W: 24" - 60"

Worksurface & Supports

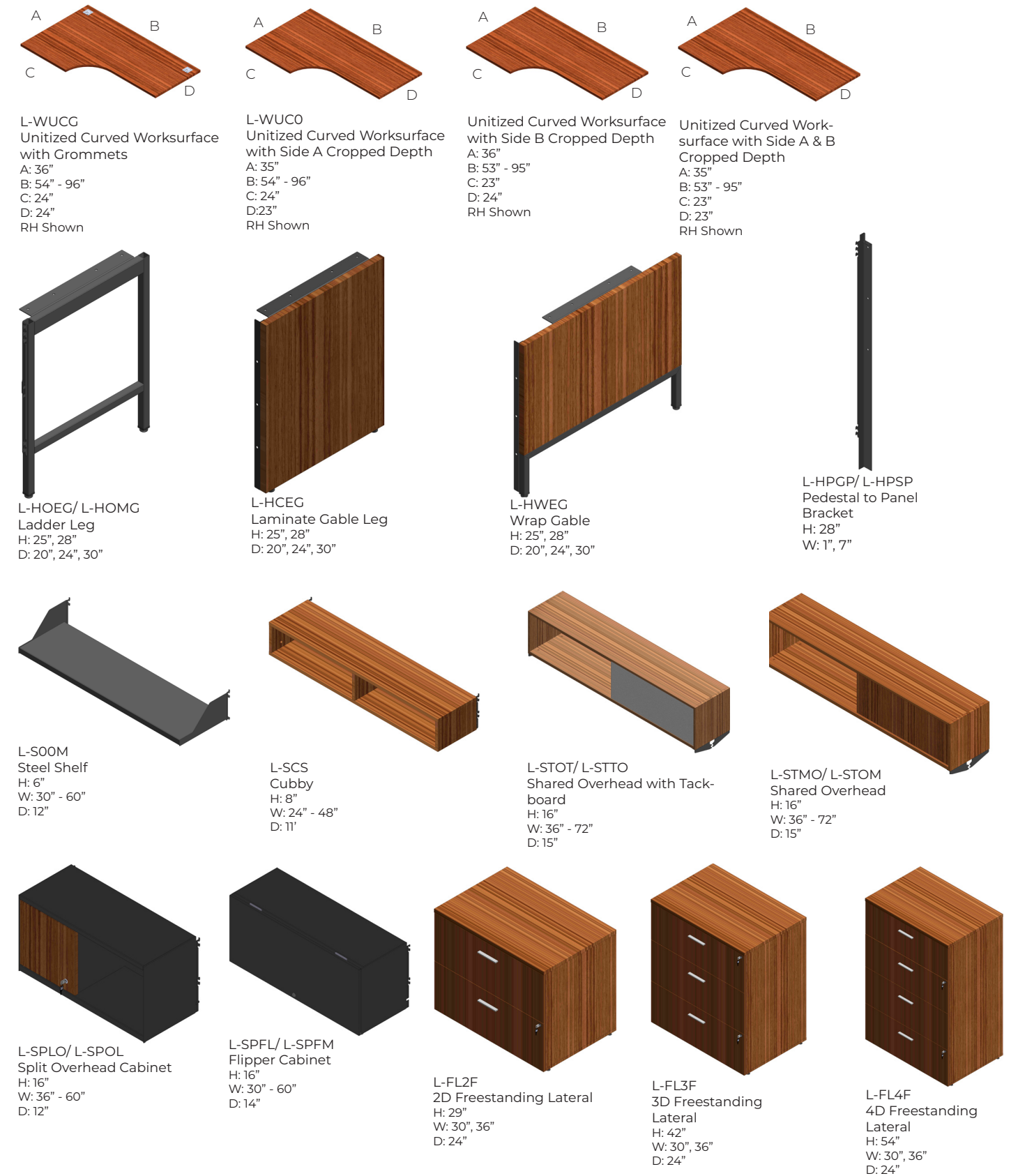
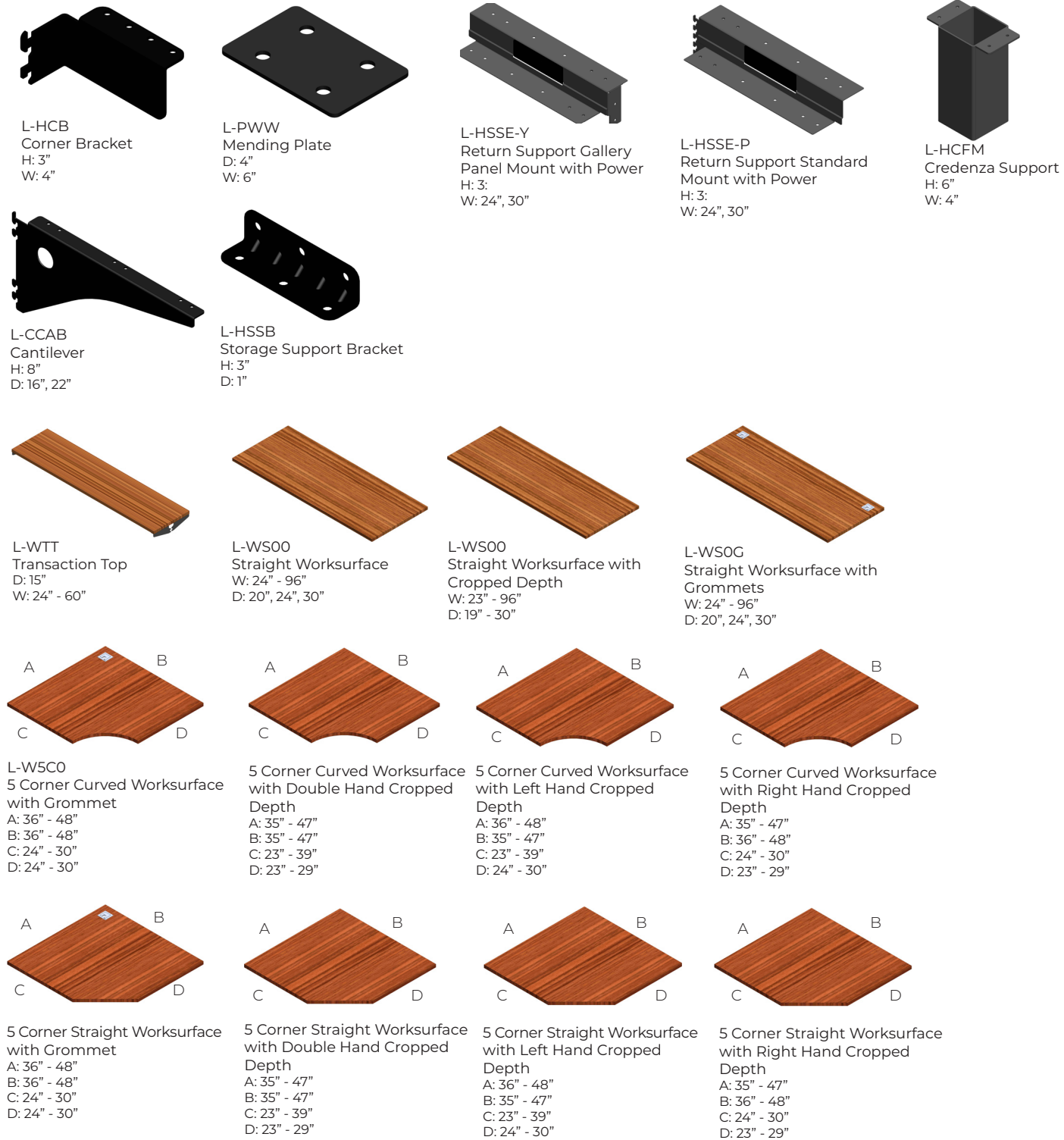

Connections & Trims

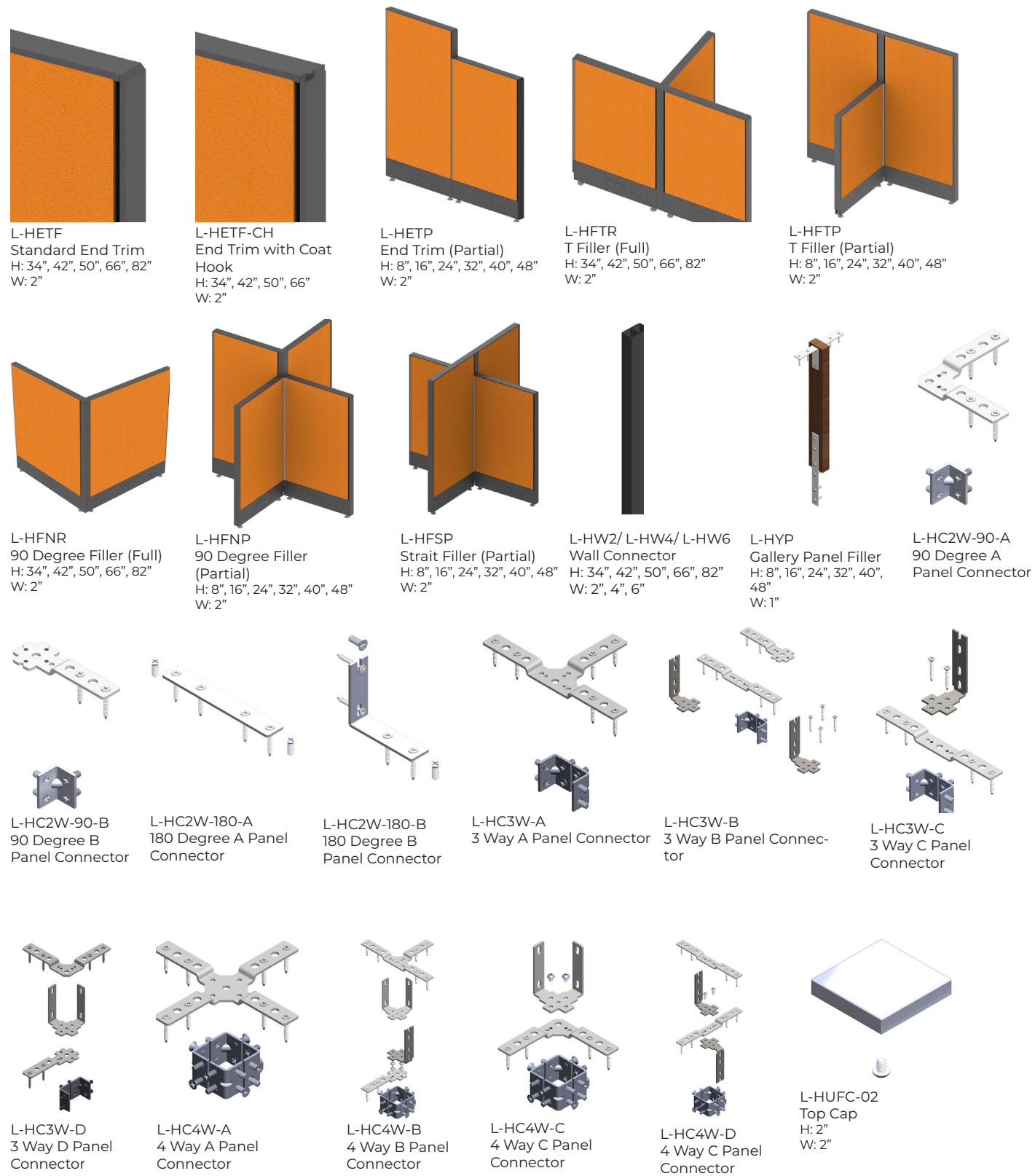

Storage

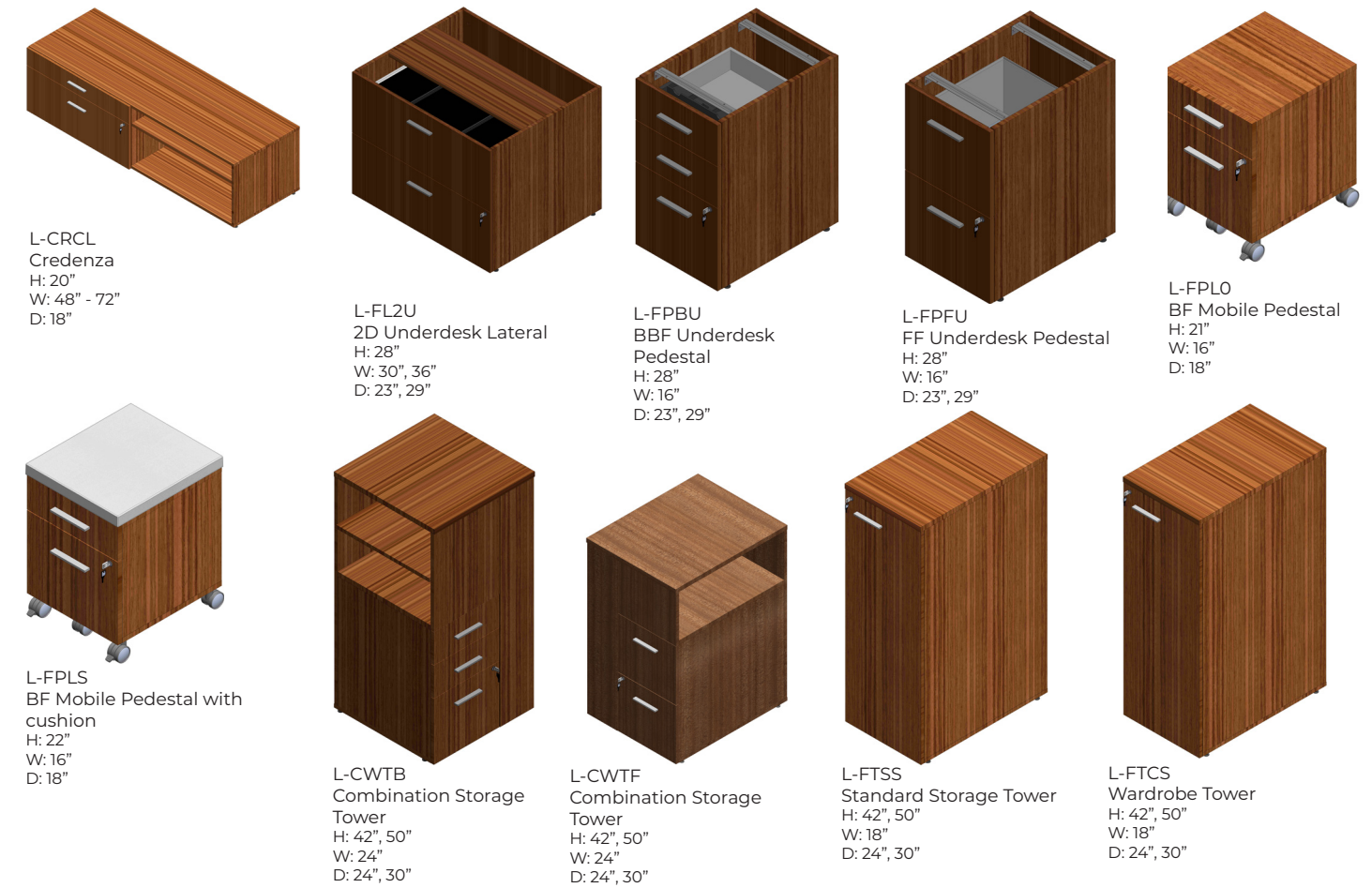

Electrics



Accessories

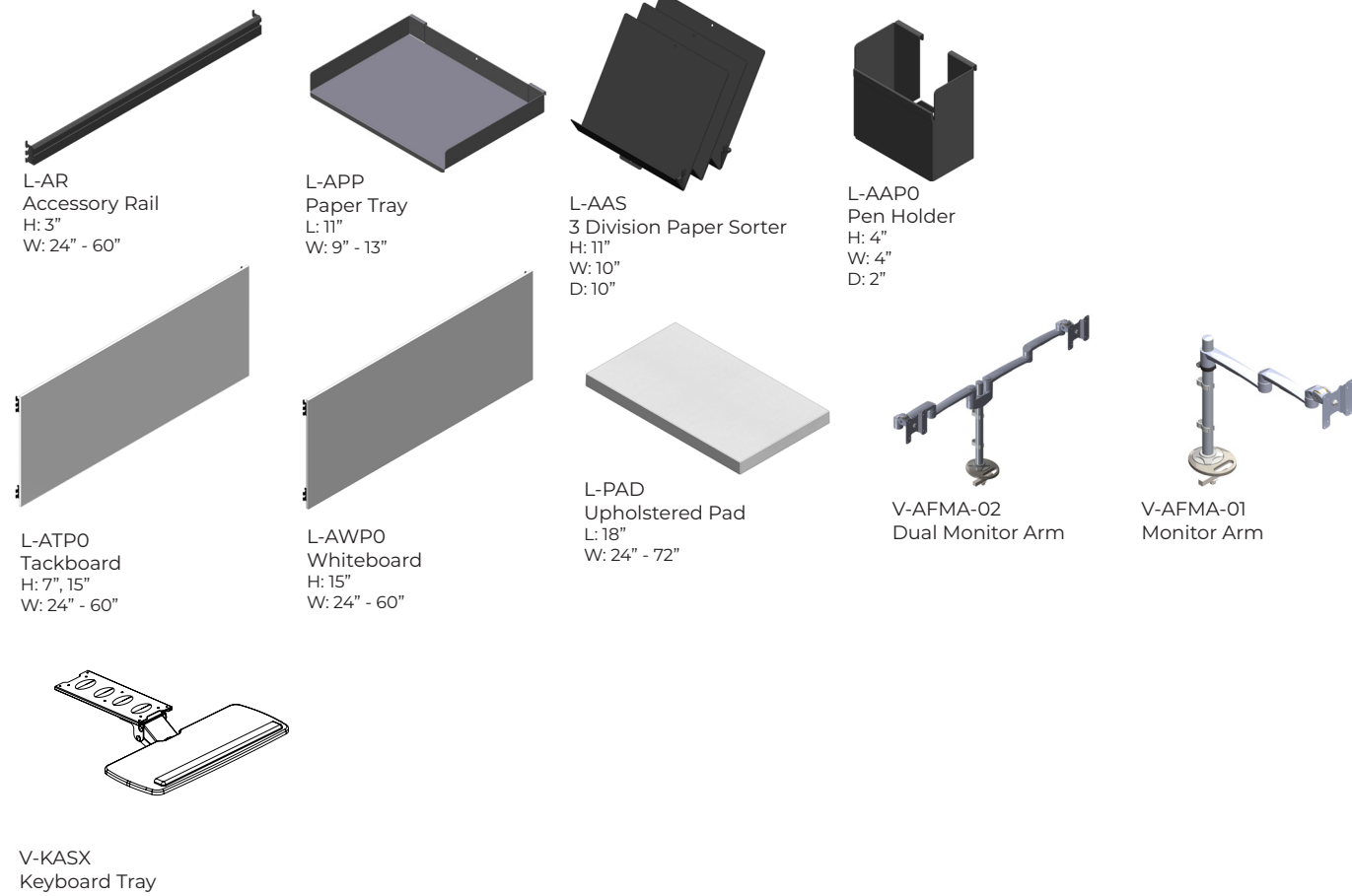

Segment Types

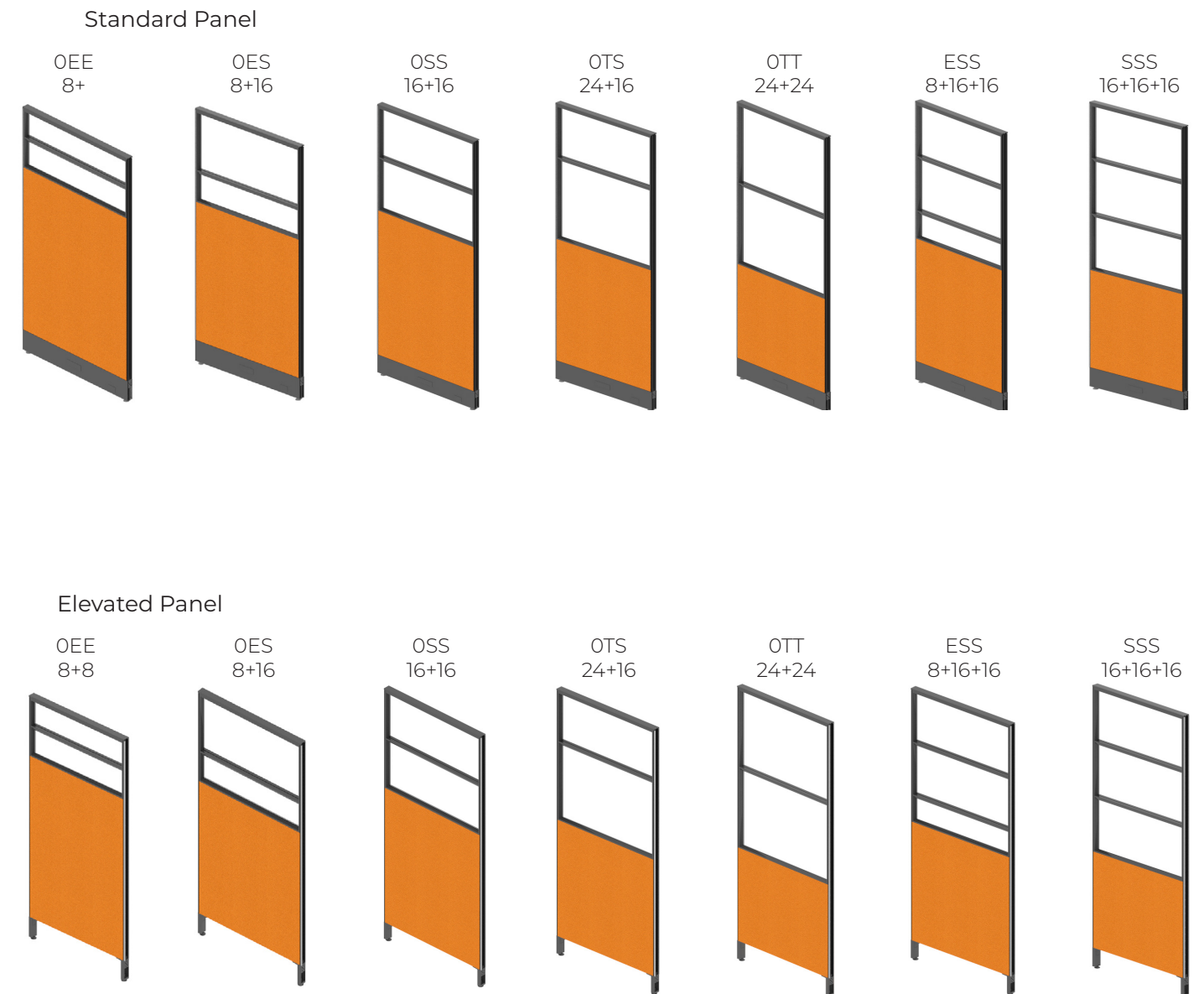

Caution

Load Bottom Drawer First

- Operate one drawer at a time
- Units may tip if loaded incorrectly
- Units should be attached to a wall or other furniture to reduce tipping hazard
- Always load the heaviest files in the bottom drawer

Heavy Load

- Some products must be anchored to wall to ensure stability & safety.
- It is the owner and installers responsibility to ensure that the wall type and construction is of sufficient strength to carry the loads of any wall mounted products and their contents.
- Failure of the wall and anchors to support all imposed loads may result in property damage and/or personal injury.
- Tayco can provide size and empty weight of its products only. As wall blocking is considered a building construction process, Tayco cannot provide recommendations in this respect and cannot be responsible for damage or injury that may occur as a result of improper installation and/or blocking.

Instability Hazard

Mobile items on casters such as flip top, personal and movable tables of any type and storage items of any type may present an instability hazard if not secured correctly while in use or in storage. Flip top tables or training tables of any type, are inherently more unstable when folded. Tayco provides the following guidelines & warnings when using mobile products:

- Lock casters immediately after moving. Do not leave the casters unlocked when in use or in storage.
- Motion may increase the instability of any item with casters. If the wheels hit an obstruction the table's forward momentum often causes overturn, especially if the item is not equipped with wheel extensions. Exercise strong caution while moving these items.
- Use caution when abrupt level changes in the floor are present (such as a doorway or room threshold) as caster failure or tipping may result.
- Do not stand, sit or lean on mobile items for support. They are not intended for this use and personal injury or property damage may result.
- Mobile units that feature height adjustable elements must be lowered to the minimum compressed height when moving to prevent instability. It is also recommended the user remove all computer equipment or other accessories to prevent possible weight imbalance or damage to equipment.
- Failure to follow the guidelines above may result in property damage or personal injury.

Application Guidelines

Types of Surfaces

no grommet

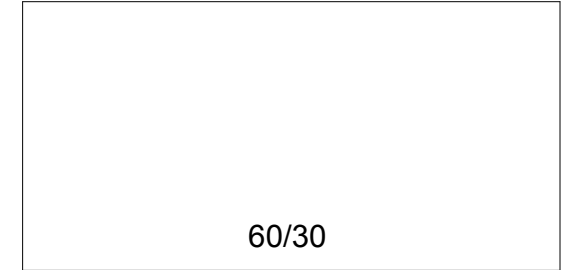
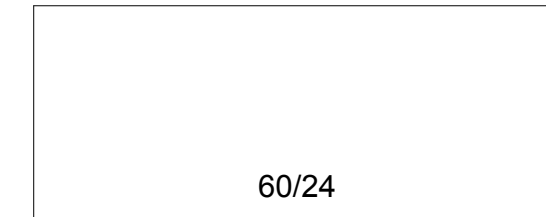

with grommet

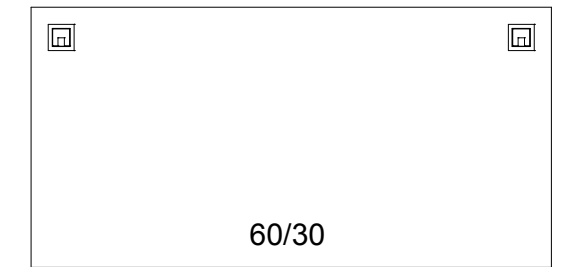
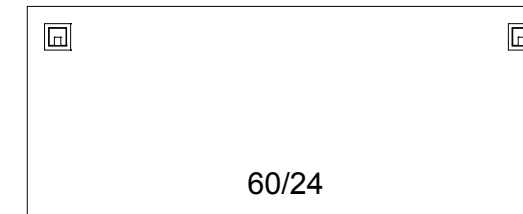

wireplay

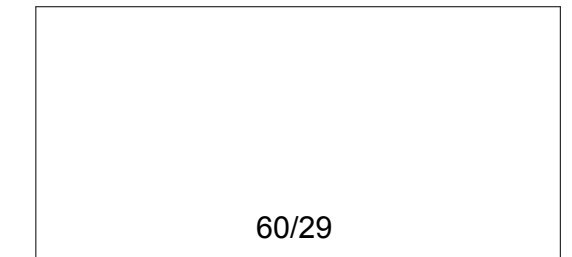
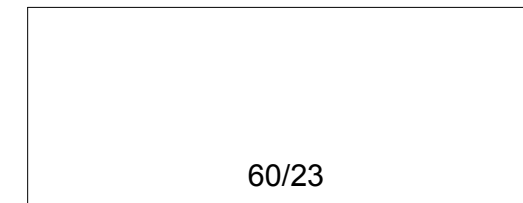

Gallery Panel Planning

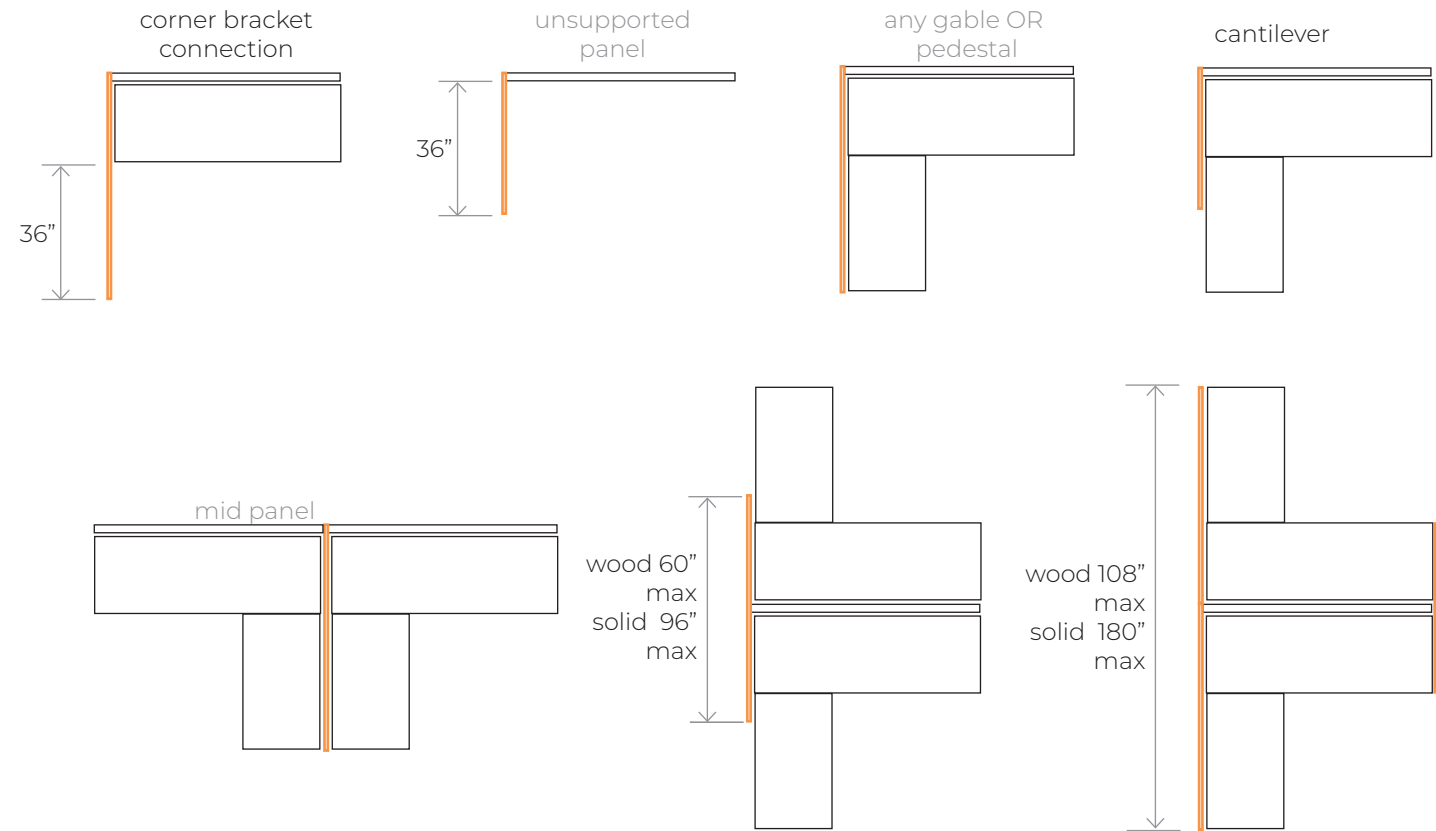

Connection Types - Panel Doors

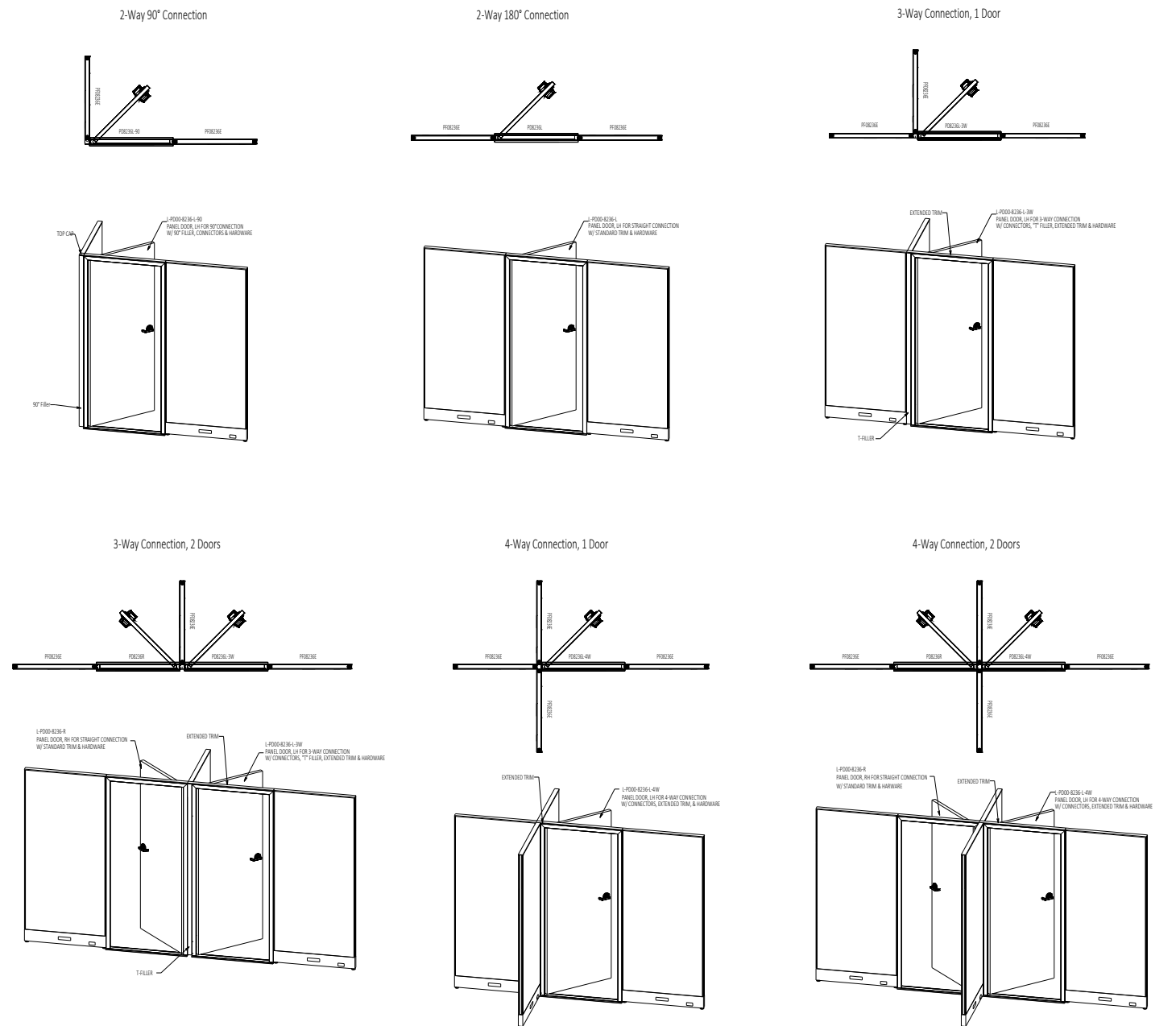

Connection Types - Sliding Doors

2-Way 90° Connection

2-Way 180° Connection

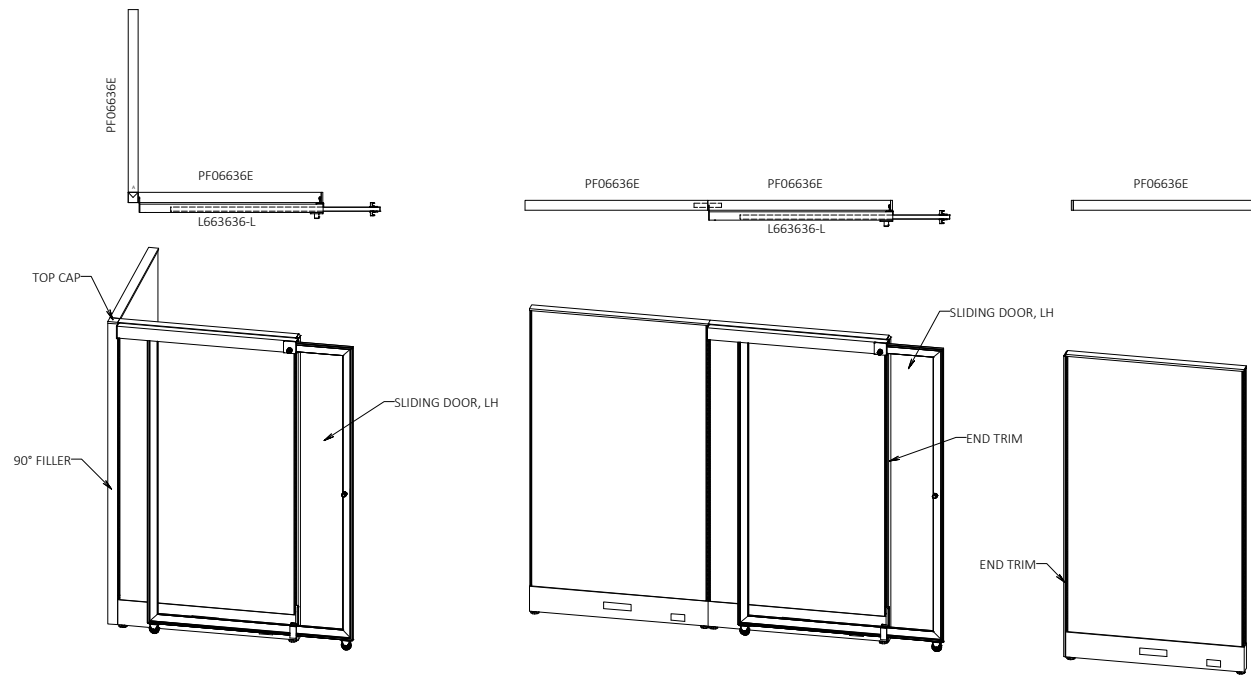

3-Way Connection, 1 Door

3-Way Connection, 2 Doors

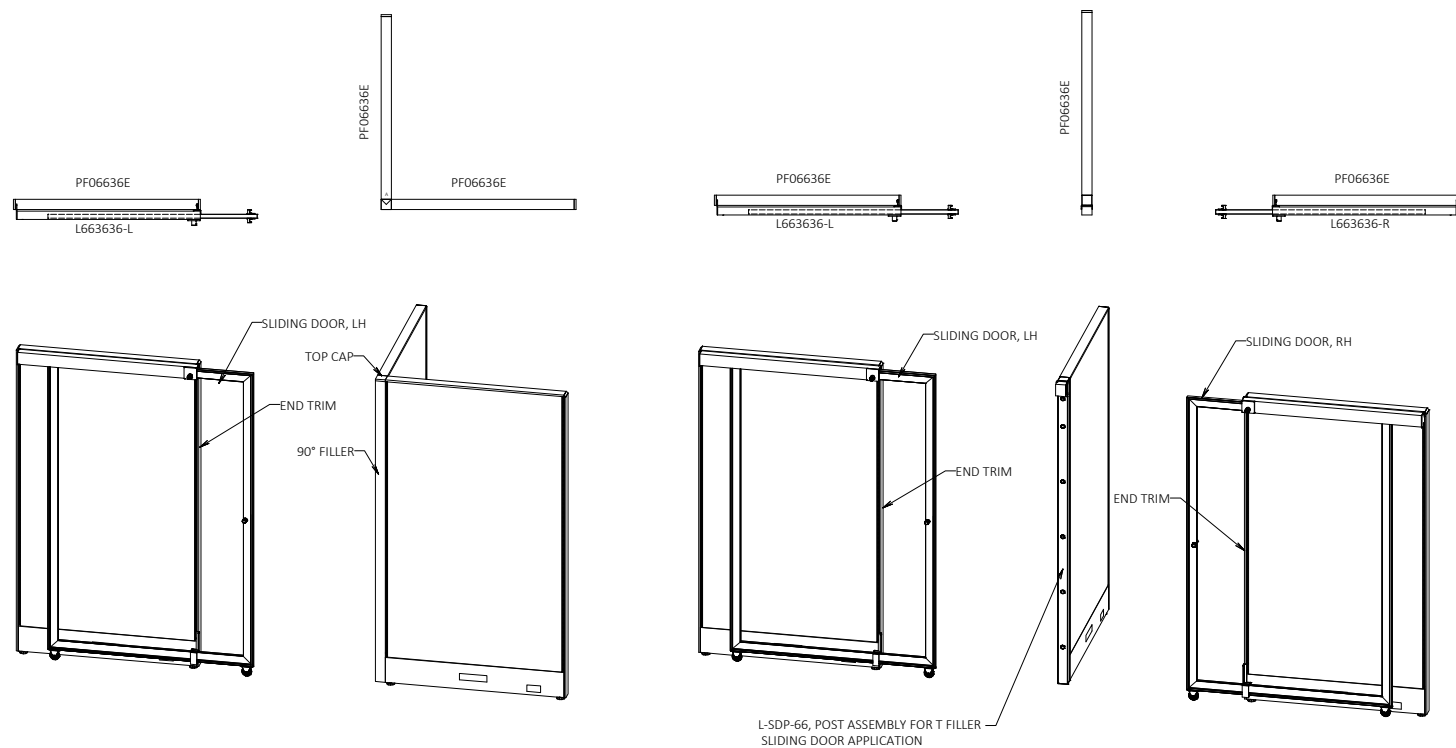

Connection Types - Fillers

2-Way 90° Connection

2-Way 180° Connection

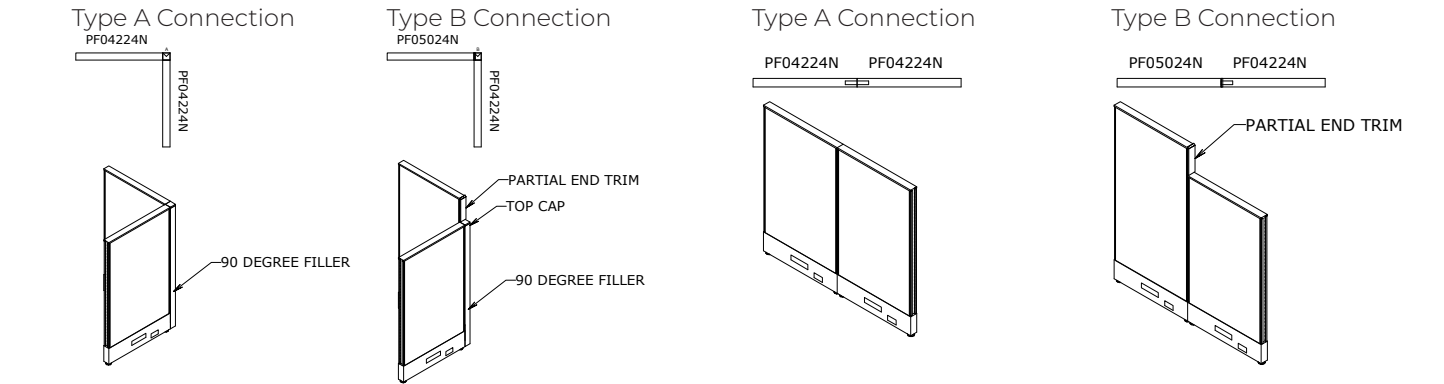

3-Way Connection

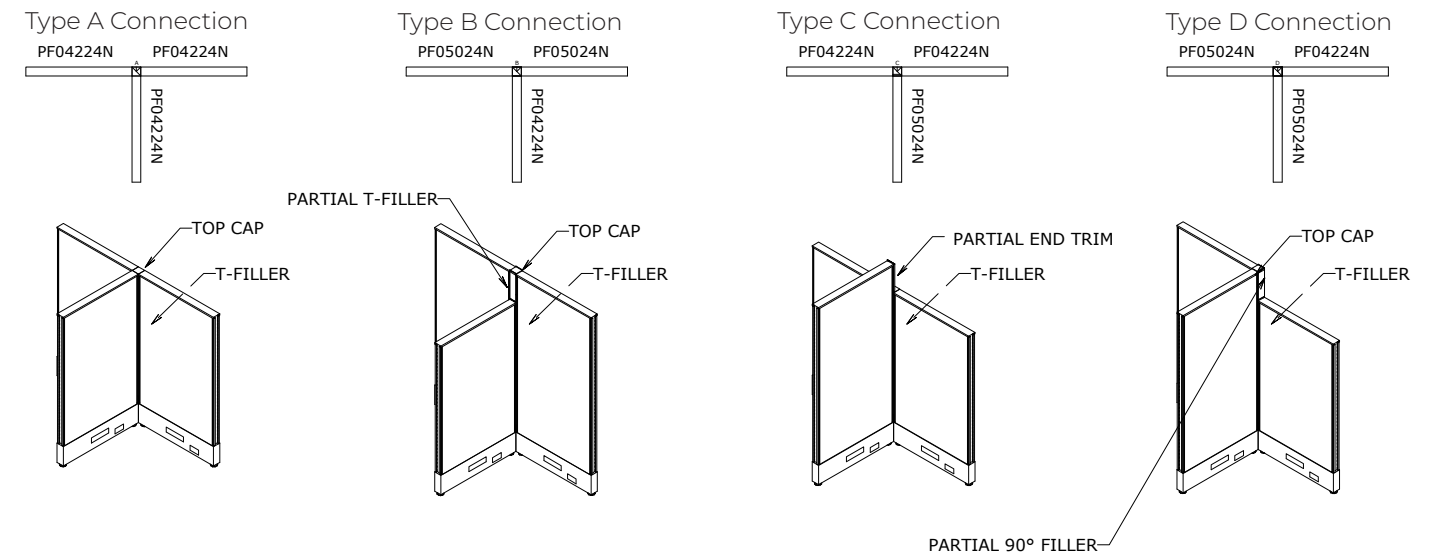

4-Way Connection

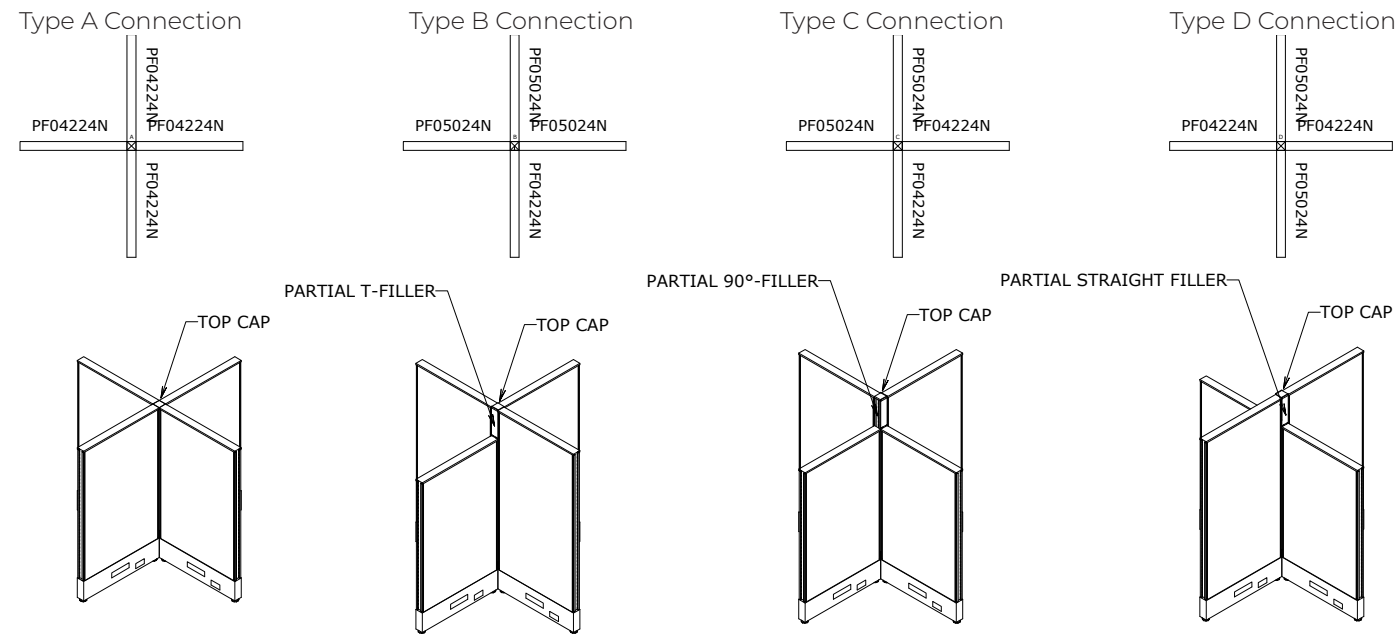

Wire Play Planning

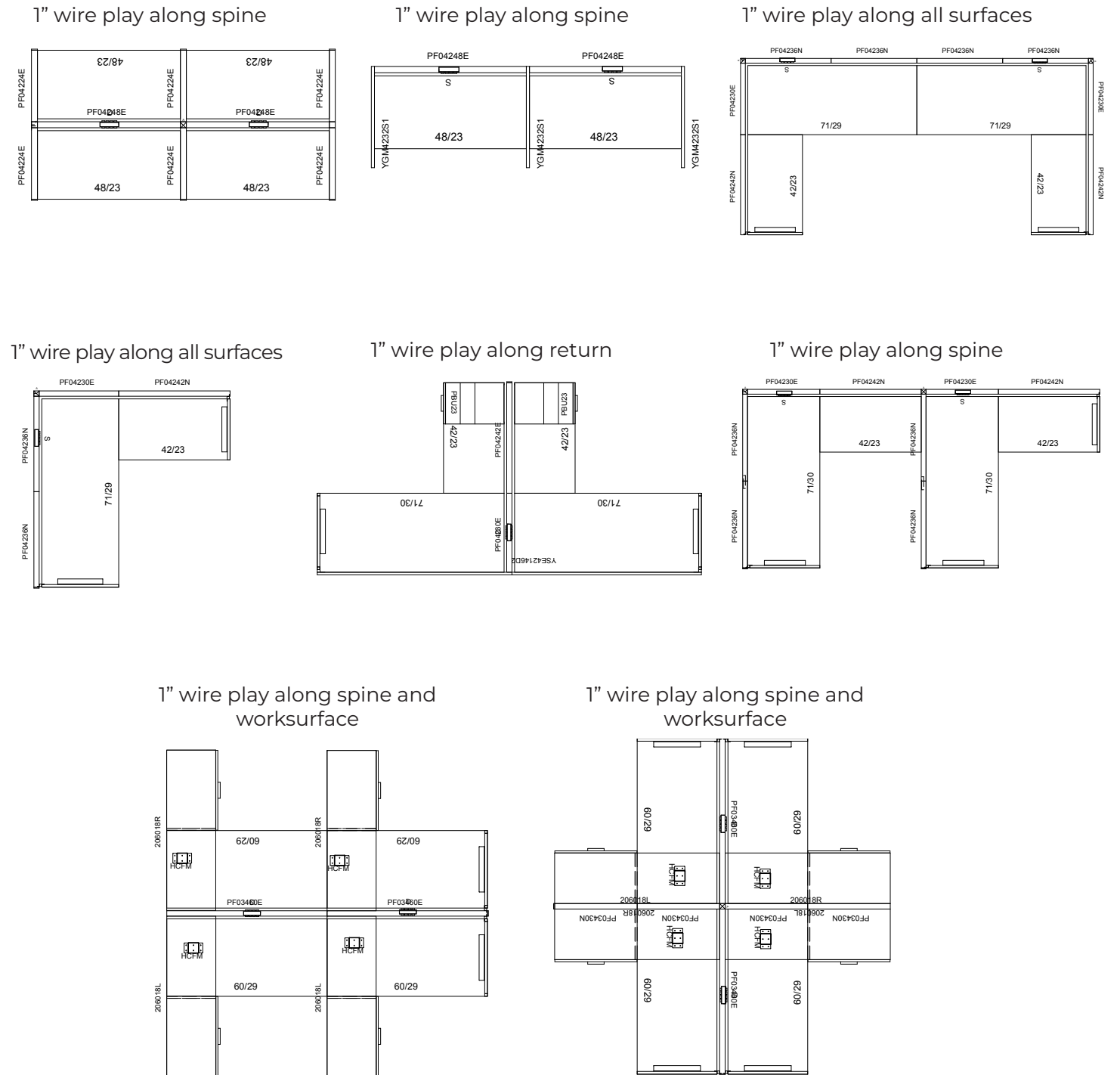



Switch Canada Pricebook
 April 2025
Panels

Panels

Standard Panel - Monolithic	4	Gallery - Woodgrain	64
Non Powered Capable	4	Horizontal Grain	64
Fabric	4	Single Span Middle	64
Laminate	6	Double Span Middle	66
Powered Capable	8	Single Span End /No Cutout	68
Fabric	8	Single Span End/w Cutout	70
Laminate	10	Double Span End /No Cutout	72
Standard - Glazed	12	Double Span End/w Cutout	74
Non Powered	12	Vertical Grain	76
Fabric/Clear Acrylic	12	Single Span Middle	76
Fabric/Frosted Acrylic	14	Double Span Middle	78
Fabric/Clear Glass	16	Single Span End /No Cutout	80
Fabric/Frosted Glass	18	Single Span End /w Cutout	82
Laminate/Clear Acrylic	20	Double Span End/No Cutout	84
Laminate/Frosted Acrylic	22	Double Span End /w Cutout	86
Laminate/Clear Glass	24	Gallery - Solid	88
Laminate/Frosted Glass	26	Single Span Middle	88
Powered	28	Double Span Middle	90
Fabric/Clear Acrylic	28	Single Span End /No Cutout	92
Fabric/Frosted Acrylic	30	Single Span End /w Cutout	94
Fabric/Clear Glass	32	Double Span End/No Cutout	96
Fabric/Frosted Glass	34	Double Span End /w Cutout	98
Laminate/Clear Acrylic	36	Frameless Blade	100
Laminate/Frosted Acrylic	38	Standard & Elevated	
Laminate/Clear Glass	40	Panel Mounted Glass	100
Laminate/Frosted Glass	42	Standard & Elevated	
Elevated - Monolithic	44	Panel Mounted Acrylic	102
Fabric	44	Gallery Panel Mounted Glass	104
Laminate	46	Gallery Panel Mounted Acrylic	106
Elevated - Glazed	48	Panel Mounted Add Ons	108
Fabric/Clear Acrylic	48	Whiteboard	108
Fabric/Frosted Acrylic	50	Tackboard	109
Fabric/Clear Glass	52	Doors	110
Fabric/Frosted Glass	54	Hinged	110
Laminate/Clear Acrylic	56	Sliding	112
Laminate/Frosted Acrylic	58	Clear Acrylic	113
Laminate/Clear Glass	60	Frosted Acrylic	114
Laminate/Frosted Glass	62	Fluted Acrylic	115

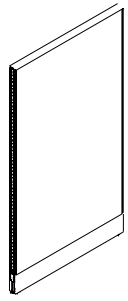

Standard Monolithic
Non-Powered Fabric Panel

What's Included:

One (1) 2" thick fabric panel with
1" incremented slotted channels,
Two (2) raceway covers,
One (1) top trim

How to Specify:

Refer to panel fabric cards for fabric selections
Choose White, Black, Silver, Charcoal for Panel
Frame colour

Notes:

Non-power capable panel.
Can be used in run with power-capable
panels and allows wires to pass through.
Panels are non tackable. For tackable
option see Panel Add-On section.
Fabric Upcharge
Grade 2 - \$226 per panel,
Grade 3- \$278 per panel

Options:

Height*:	34", 42", 50", 66", 82"
Width:	24", 30", 36", 42", 48", 54", 60", 66", 72"
Fabric	
Metal Powder Coat Paint:	White, Black, Silver, Charcoal

*34" high - 50" high available up to 72" wide, 66" high available up to 60" wide, 82" high available up to 48" wide

Code	Price	H	W	D	Weight (lb.)	Volume (ft ³)
L-PPF0-3424-N	590	34	24	2	16.32	0.94
L-PPF0-3430-N	630	34	30	2	20.4	1.18
L-PPF0-3436-N	717	34	36	2	24.48	1.42
L-PPF0-3442-N	753	34	42	2	28.56	1.65
L-PPF0-3448-N	786	34	48	2	32.64	1.89
L-PPF0-3454-N	825	34	54	2	36.72	2.13
L-PPF0-3460-N	856	34	60	2	40.8	2.36
L-PPF0-3466-N	1233	34	66	2		
L-PPF0-3472-N	1311	34	72	2		

Code	Price	H	W	D	Weight (lb.)	Volume (ft ³)
L-PPF0-4224-N	590	42	24	2	20.16	1.17
L-PPF0-4230-N	630	42	30	2	25.2	1.46
L-PPF0-4236-N	717	42	36	2	30.24	1.75
L-PPF0-4242-N	753	42	42	2	35.28	2.04
L-PPF0-4248-N	786	42	48	2	40.32	2.33
L-PPF0-4254-N	825	42	54	2	45.36	2.63
L-PPF0-4260-N	856	42	60	2	50.4	2.92
L-PPF0-4266-N	1233	42	66	2		
L-PPF0-4272-N	1311	42	72	2		
L-PPF0-5024-N	617	50	24	2	24	1.39
L-PPF0-5030-N	655	50	30	2	30	1.74
L-PPF0-5036-N	730	50	36	2	36	2.08
L-PPF0-5042-N	786	50	42	2	42	2.43
L-PPF0-5048-N	832	50	48	2	48	2.78
L-PPF0-5054-N	873	50	54	2	54	3.13
L-PPF0-5060-N	907	50	60	2	60	3.47
L-PPF0-5066-N	1270	50	66	2		
L-PPF0-5072-N	1339	50	72	2		
L-PPF0-6624-N	677	66	24	2	31.68	1.83
L-PPF0-6630-N	738	66	30	2	39.6	2.29
L-PPF0-6636-N	792	66	36	2	47.52	2.75
L-PPF0-6642-N	847	66	42	2	55.44	3.21
L-PPF0-6648-N	900	66	48	2	63.36	3.67
L-PPF0-6654-N	960	66	54	2	71.28	4.13
L-PPF0-6660-N	1013	66	60	2	79.2	4.58
L-PPF0-8224-N	983	82	24	2		
L-PPF0-8230-N	1054	82	30	2		
L-PPF0-8236-N	1277	82	36	2		
L-PPF0-8242-N	1344	82	42	2		
L-PPF0-8248-N	1413	82	48	2		



Standard Monolithic
Non-Powered Laminate
Panel

What's Included:

One (1) 2" thick laminate panel with
1" incremented slotted channels,
Two (2) raceway covers,
One (1) top trim

How to Specify:

Refer to laminate cards for laminate
selections Choose White, Black, Silver, Charcoal
for Panel Frame colour

Notes:

Non-power capable panel.
Can be used in run with power-capable
panels and allows wires to pass through.
Panels are non tackable. For tackable
option see Panel Add-On section.

Options:

Height*	34", 42", 50", 66", 82"
Width:	24", 30", 36", 42", 48
Fabric	
Metal Powder Coat Paint:	White, Black, Silver, Charcoal

*82" high available up to 36" wide

Code	Price	H	W	D	Weight (lb.)	Volume (ft ³)
L-PPL0-3424-N	677	34	24	2	16.32	0.94
L-PPL0-3430-N	734	34	30	2	20.4	1.18
L-PPL0-3436-N	791	34	36	2	24.48	1.42
L-PPL0-3442-N	856	34	42	2	28.56	1.65
L-PPL0-3448-N	921	34	48	2	32.64	1.89
L-PPL0-4224-N	724	42	24	2	20.16	1.17
L-PPL0-4230-N	782	42	30	2	25.2	1.46
L-PPL0-4236-N	836	42	36	2	30.24	1.75
L-PPL0-4242-N	923	42	42	2	35.28	2.04
L-PPL0-4248-N	966	42	48	2	40.32	2.33
L-PPL0-5024-N	795	50	24	2	24	1.39
L-PPL0-5030-N	860	50	30	2	30	1.74
L-PPL0-5036-N	924	50	36	2	36	2.08
L-PPL0-5042-N	1056	50	42	2	42	2.43
L-PPL0-5048-N	1086	50	48	2	48	2.78
L-PPL0-6624-N	890	66	24	2	31.68	1.83
L-PPL0-6630-N	971	66	30	2	39.6	2.29
L-PPL0-6636-N	1053	66	36	2	47.52	2.75
L-PPL0-6642-N	1210	66	42	2	55.44	3.21
L-PPL0-6648-N	1246	66	48	2	63.36	3.67
L-PPL0-8224-N	1097	82	24	2		
L-PPL0-8230-N	1114	82	30	2		
L-PPL0-8236-N	1396	82	36	2		

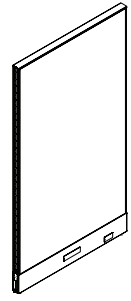

Standard Monolithic Powered Fabric Panel

What's Included:

One (1) 2" thick fabric panel with 1" incremented slotted channels, Two (2) raceway covers, One (1) top trim

How to Specify:

Refer to panel fabric cards for fabric selections
Choose White, Black, Silver, Charcoal for Panel Frame colour

Notes:

Power capable panel with bracket for power module.

Power module must be specified seperately.

Panels are non tackable. For tackable option see Panel Add-On section.

Fabric Upcharge
Grade 2 - \$226 per panel,
Grade 3- \$278 per panel

Options:

Height*: 34", 42", 50", 66", 82"

Width: 24", 30", 36", 42", 48", 54", 60", 66", 72"

Fabric

Metal Powder Coat Paint: White, Black, Silver, Charcoal

*34" high - 50" high available up to 72" wide, 66" high available up to 60" wide, 82" high available up to 48" wide

Code	Price	H	W	D	Weight (lb.)	Volume (ft ³)
L-PPF0-3424-E	619	34	24	2	16.32	0.94
L-PPF0-3430-E	654	34	30	2	20.4	1.18
L-PPF0-3436-E	742	34	36	2	24.48	1.42
L-PPF0-3442-E	782	34	42	2	28.56	1.65
L-PPF0-3448-E	810	34	48	2	32.64	1.89
L-PPF0-3454-E	851	34	54	2	36.72	2.13
L-PPF0-3460-E	883	34	60	2	40.8	2.36
L-PPF0-3466-E	1257	34	66	2		
L-PPF0-3472-E	1333	34	72	2		

Code	Price	H	W	D	Weight (lb.)	Volume (ft ³)
L-PPF0-4224-E	619	42	24	2	20.16	1.17
L-PPF0-4230-E	654	42	30	2	25.2	1.46
L-PPF0-4236-E	742	42	36	2	30.24	1.75
L-PPF0-4242-E	782	42	42	2	35.28	2.04
L-PPF0-4248-E	810	42	48	2	40.32	2.33
L-PPF0-4254-E	851	42	54	2	45.36	2.63
L-PPF0-4260-E	883	42	60	2	50.4	2.92
L-PPF0-4266-E	1257	42	66	2		
L-PPF0-4272-E	1333	42	72	2		
L-PPF0-5024-E	641	50	24	2	24	1.39
L-PPF0-5030-E	679	50	30	2	30	1.74
L-PPF0-5036-E	757	50	36	2	36	2.08
L-PPF0-5042-E	810	50	42	2	42	2.43
L-PPF0-5048-E	857	50	48	2	48	2.78
L-PPF0-5054-E	897	50	54	2	54	3.13
L-PPF0-5060-E	932	50	60	2	60	3.47
L-PPF0-5066-E	1293	50	66	2		
L-PPF0-5072-E	1363	50	72	2		
L-PPF0-6624-E	703	66	24	2	31.68	1.83
L-PPF0-6630-E	762	66	30	2	39.6	2.29
L-PPF0-6636-E	816	66	36	2	47.52	2.75
L-PPF0-6642-E	872	66	42	2	55.44	3.21
L-PPF0-6648-E	925	66	48	2	63.36	3.67
L-PPF0-6654-E	983	66	54	2	71.28	4.13
L-PPF0-6660-E	1038	66	60	2	79.2	4.58
L-PPF0-8224-E	1027	82	24	2		
L-PPF0-8230-E	1098	82	30	2		
L-PPF0-8236-E	1319	82	36	2		
L-PPF0-8242-E	1388	82	42	2		
L-PPF0-8248-E	1457	82	48	2		



Standard Monolithic Powered Laminate Panel

What's Included:

One (1) 2" thick flaminite panel with 1" incremented slotted channels,
Two (2) raceway covers,
One (1) top trim

How to Specify:

Refer to laminate cards for laminate selections
Choose White, Black, Silver, Charcoal for Panel Frame colour

Notes:

Power capable panel with bracket for power module.
Power module must be specified seperately.
Panels are non tackable. For tackable option see Panel Add-On section.

Options:

Height*: 34", 42", 50", 66", 82"

Width: 24", 30", 36", 42", 48",

Laminate

Metal Powder Coat Paint: White, Black, Silver, Charcoal

*82"H available up to 36"W

Code	Price	H	W	D	Weight (lb.)	Volume (ft ³)
L-PPL0-3424-E	702	34	24	2	16.32	0.94
L-PPL0-3430-E	758	34	30	2	20.4	1.18
L-PPL0-3436-E	815	34	36	2	24.48	1.42
L-PPL0-3442-E	880	34	42	2	28.56	1.65
L-PPL0-3448-E	945	34	48	2	32.64	1.89
L-PPL0-4224-E	747	42	24	2	20.16	1.17
L-PPL0-4230-E	804	42	30	2	25.2	1.46
L-PPL0-4236-E	860	42	36	2	30.24	1.75
L-PPL0-4242-E	948	42	42	2	35.28	2.04
L-PPL0-4248-E	992	42	48	2	40.32	2.33
L-PPL0-5024-E	818	50	24	2	24	1.39
L-PPL0-5030-E	885	50	30	2	30	1.74
L-PPL0-5036-E	948	50	36	2	36	2.08
L-PPL0-5042-E	1084	50	42	2	42	2.43
L-PPL0-5048-E	1110	50	48	2	48	2.78
L-PPL0-6624-E	915	66	24	2	31.68	1.83
L-PPL0-6630-E	998	66	30	2	39.6	2.29
L-PPL0-6636-E	1076	66	36	2	47.52	2.75
L-PPL0-6642-E	1233	66	42	2	55.44	3.21
L-PPL0-6648-E	1271	66	48	2	63.36	3.67
L-PPL0-8224-E	1111	82	24	2		
L-PPL0-8230-E	1128	82	30	2		
L-PPL0-8236-E	1420	82	36	2		

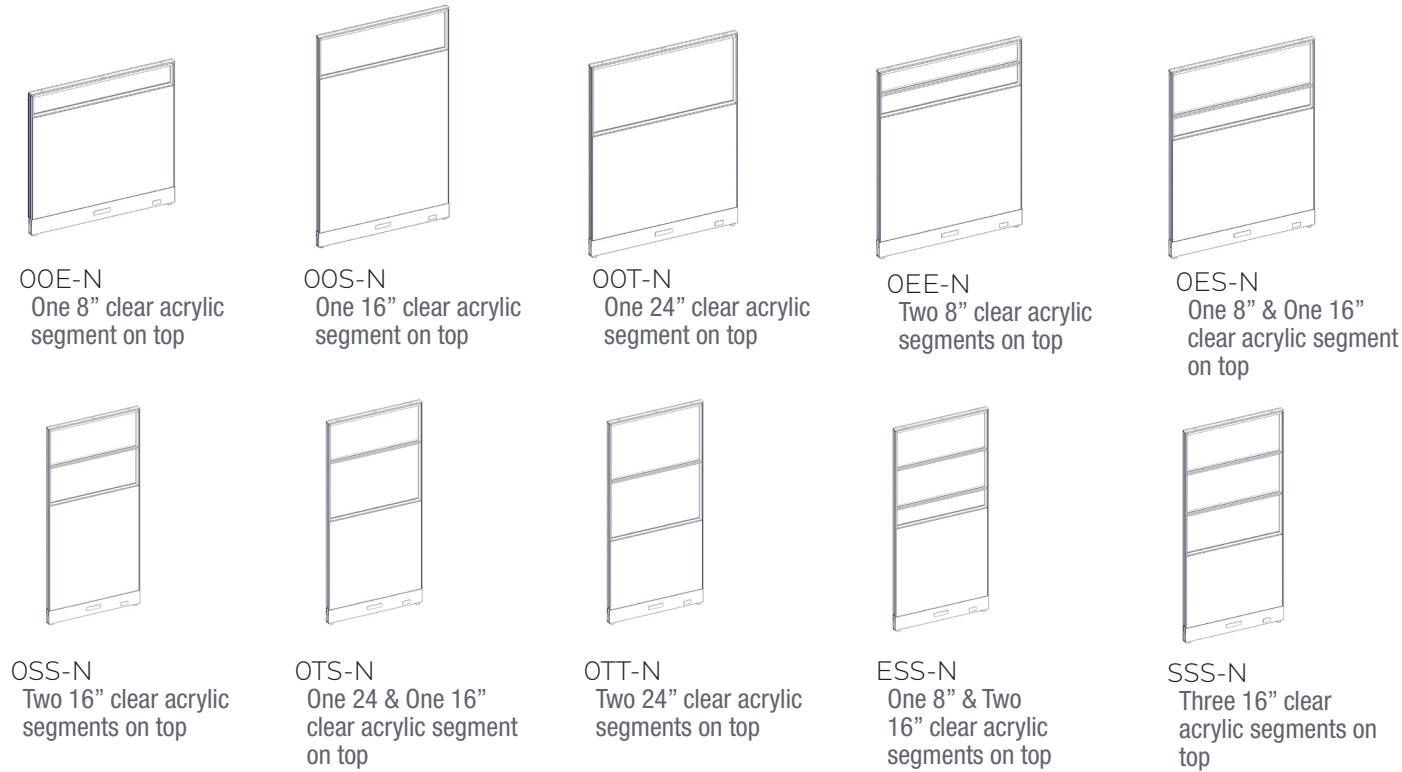

How to order and read your code

L - P P F C A - 42 24 - 00E - N

product line	standard	P=glazed E=Elevated	F=Fabric L=Laminate	C=Clear F=Frosted	A=Acrylic height G=Glass	width	O = No segment E = 8 inch segment S = 16 inch segment T = 24 inch segment	N=Non powered E=Powered
--------------	----------	------------------------	------------------------	----------------------	-----------------------------	-------	--	----------------------------

What's Included:

One (1) 2" thick fabric panel with 1" incremented slotted channels, Two (2) raceway covers, One (1) top trim

How to Specify:

Refer to panel fabric cards for fabric selections
Choose White, Black, Silver, Charcoal for Panel Frame colour

Options:

Height*:	34", 42", 50", 66", 82"
Width:	24", 30", 36", 42", 48", 54", 60", 66", 72"
Fabric	
Metal Powder Coat Paint:	White, Black, Silver, Charcoal

*34" high - 50" high available up to 72" wide, 66" high available up to 60" wide, 82" high available up to 48" wide

Code	Price	H	W	D
One 8" clear acrylic segment on top				
L-PPFCA-4224-00E-N	1140	42	24	2
L-PPFCA-4230-00E-N	1218	42	30	2
L-PPFCA-4236-00E-N	1267	42	36	2
L-PPFCA-4242-00E-N	1317	42	42	2
L-PPFCA-4248-00E-N	1370	42	48	2
L-PPFCA-4254-00E-N	1454	42	54	2
L-PPFCA-4260-00E-N	1484	42	60	2
L-PPFCA-5024-00E-N	1140	50	24	2
L-PPFCA-5030-00E-N	1218	50	30	2
L-PPFCA-5036-00E-N	1267	50	36	2
L-PPFCA-5042-00E-N	1317	50	42	2
L-PPFCA-5048-00E-N	1370	50	48	2
L-PPFCA-5054-00E-N	1454	50	54	2
L-PPFCA-5060-00E-N	1484	50	60	2
One 16" clear acrylic segment on top				
L-PPFCA-5024-00S-N	1140	50	24	2
L-PPFCA-5030-00S-N	1218	50	30	2
L-PPFCA-5036-00S-N	1267	50	36	2
L-PPFCA-5042-00S-N	1317	50	42	2
L-PPFCA-5048-00S-N	1370	50	48	2
L-PPFCA-5054-00S-N	1454	50	54	2
L-PPFCA-5060-00S-N	1484	50	60	2
L-PPFCA-6624-00S-N	1259	66	24	2
L-PPFCA-6630-00S-N	1351	66	30	2
L-PPFCA-6636-00S-N	1435	66	36	2
L-PPFCA-6642-00S-N	1515	66	42	2
L-PPFCA-6648-00S-N	1587	66	48	2
L-PPFCA-6654-00S-N	1721	66	54	2
L-PPFCA-6660-00S-N	1755	66	60	2
L-PPFCA-8224-00S-N	1606	82	24	2
L-PPFCA-8230-00S-N	1862	82	30	2
L-PPFCA-8236-00S-N	1961	82	36	2
L-PPFCA-8242-00S-N	2007	82	42	2
L-PPFCA-8248-00S-N	2095	82	48	2
One 24" clear acrylic segment on top				
L-PPFCA-6624-00T-N	1259	66	24	2
L-PPFCA-6630-00T-N	1351	66	30	2
L-PPFCA-6636-00T-N	1435	66	36	2
L-PPFCA-6642-00T-N	1515	66	42	2
L-PPFCA-6648-00T-N	1587	66	48	2
L-PPFCA-6654-00T-N	1721	66	54	2
L-PPFCA-6660-00T-N	1755	66	60	2
Two 8" clear acrylic segments on top				
L-PPFCA-6624-0EE-N	1585	66	24	2
L-PPFCA-6630-0EE-N	1796	66	30	2
L-PPFCA-6636-0EE-N	1872	66	36	2
L-PPFCA-6642-0EE-N	1932	66	42	2
L-PPFCA-6648-0EE-N	2017	66	48	2
L-PPFCA-6654-0EE-N	2145	66	54	2
L-PPFCA-6660-0EE-N	2202	66	60	2
One 8" & One 16" clear acrylic segment on top				
L-PPFCA-6624-0ES-N	1549	66	24	2
L-PPFCA-6630-0ES-N	1752	66	30	2
L-PPFCA-6636-0ES-N	1838	66	36	2
L-PPFCA-6642-0ES-N	1929	66	42	2
L-PPFCA-6648-0ES-N	2022	66	48	2
L-PPFCA-6654-0ES-N	2120	66	54	2
L-PPFCA-6660-0ES-N	2166	66	60	2
Two 16" clear acrylic segments on top				
L-PPFCA-8224-0SS-N	1649	82	24	2
L-PPFCA-8230-0SS-N	1919	82	30	2
L-PPFCA-8236-0SS-N	2057	82	36	2
L-PPFCA-8242-0SS-N	2117	82	42	2
L-PPFCA-8248-0SS-N	2201	82	48	2
One 24" & One 16" clear acrylic segment on top				
L-PPFCA-8224-0TS-N	1642	82	24	2
L-PPFCA-8230-0TS-N	1882	82	30	2
L-PPFCA-8236-0TS-N	1961	82	36	2
L-PPFCA-8242-0TS-N	2019	82	42	2
L-PPFCA-8248-0TS-N	2225	82	48	2
Two 24" clear acrylic segments on top				
L-PPFCA-8224-0TT-N	1638	82	24	2
L-PPFCA-8230-0TT-N	1857	82	30	2
L-PPFCA-8236-0TT-N	1954	82	36	2
L-PPFCA-8242-0TT-N	2082	82	42	2
L-PPFCA-8248-0TT-N	2165	82	48	2
One 8" & Two 16" clear acrylic segments on top				
L-PPFCA-8224-ESS-N	1708	82	24	2
L-PPFCA-8230-ESS-N	2029	82	30	2
L-PPFCA-8236-ESS-N	2117	82	36	2
L-PPFCA-8242-ESS-N	2119	82	42	2
L-PPFCA-8248-ESS-N	2321	82	48	2
Three 16" clear acrylic segments on top				
L-PPFCA-8224-SSS-N	1737	82	24	2
L-PPFCA-8230-SSS-N	1967	82	30	2
L-PPFCA-8236-SSS-N	2147	82	36	2
L-PPFCA-8242-SSS-N	2219	82	42	2
L-PPFCA-8248-SSS-N	2313	82	48	2

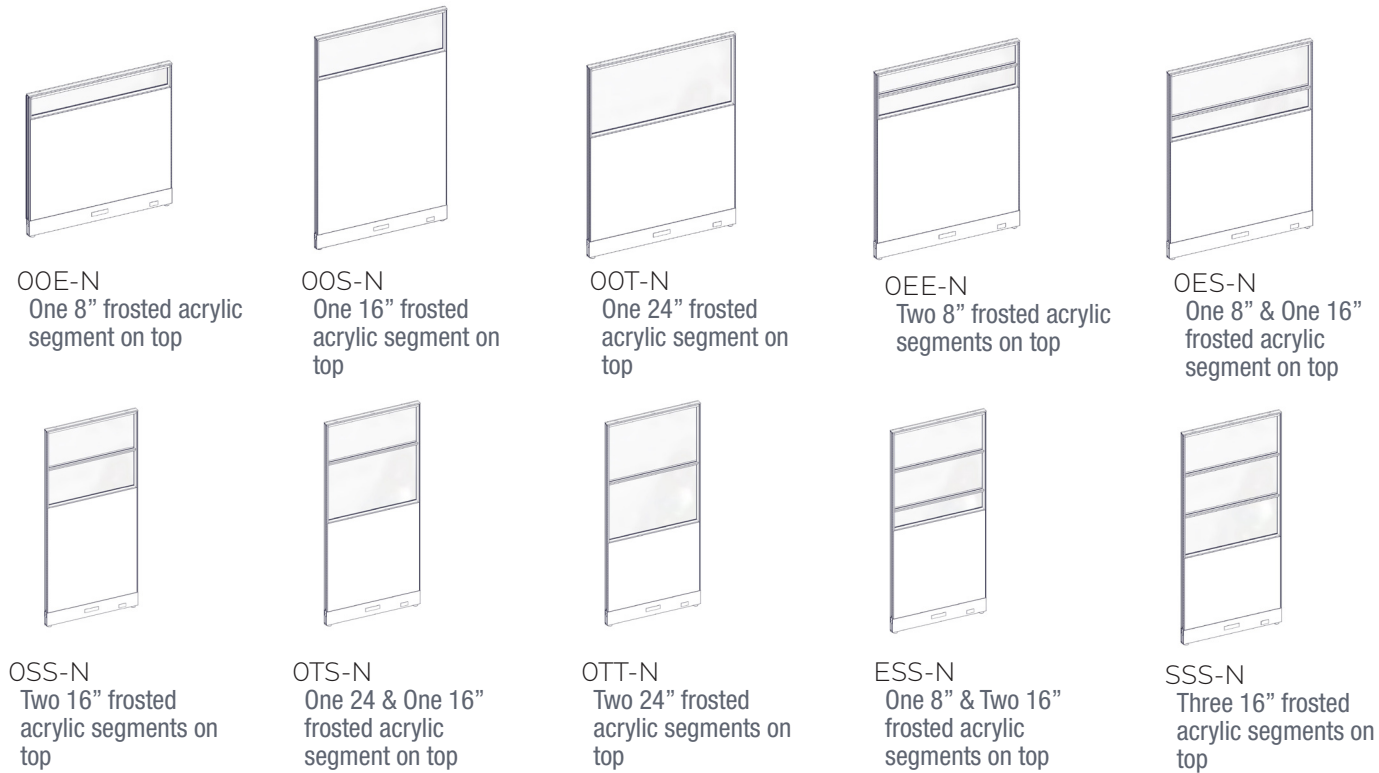

How to order and read your code

L - P P F F A - 42 24 - 00E - N

product standard P=glazed F=Fabric C=Clear A=Acrylic height width 0=No segment N=Non powered
 line E=Elevated L=Laminate F=Frosted G=Glass E=8 inch segment E=Powered
 S=16 inch segment T=24 inch segment

What's Included:

One (1) 2" thick fabric panel with 1" incremented slotted channels, Two (2) raceway covers, One (1) top trim

How to Specify:

Refer to panel fabric cards for fabric selections
 Choose White, Black, Silver, Charcoal for Panel Frame colour

Options:

Height*:	34", 42", 50", 66", 82"
Width:	24", 30", 36", 42", 48", 54", 60", 66", 72"
Fabric	
Metal Powder Coat Paint:	White, Black, Silver, Charcoal

*34" high - 50" high available up to 72" wide, 66" high available up to 60" wide, 82" high available up to 48" wide

Code	Price	H	W	D
One 8" frosted acrylic segment on top				
L-PPFFA-4224-00E-N	1247	42	24	2
L-PPFFA-4230-00E-N	1325	42	30	2
L-PPFFA-4236-00E-N	1374	42	36	2
L-PPFFA-4242-00E-N	1423	42	42	2
L-PPFFA-4248-00E-N	1476	42	48	2
L-PPFFA-4254-00E-N	1559	42	54	2
L-PPFFA-4260-00E-N	1590	42	60	2
L-PPFFA-5024-00E-N	1247	50	24	2
L-PPFFA-5030-00E-N	1325	50	30	2
L-PPFFA-5036-00E-N	1374	50	36	2
L-PPFFA-5042-00E-N	1423	50	42	2
L-PPFFA-5048-00E-N	1476	50	48	2
L-PPFFA-5054-00E-N	1559	50	54	2
L-PPFFA-5060-00E-N	1590	50	60	2
One 16" frosted acrylic segment on top				
L-PPFFA-5024-00S-N	1247	50	24	2
L-PPFFA-5030-00S-N	1325	50	30	2
L-PPFFA-5036-00S-N	1374	50	36	2
L-PPFFA-5042-00S-N	1423	50	42	2
L-PPFFA-5048-00S-N	1476	50	48	2
L-PPFFA-5054-00S-N	1559	50	54	2
L-PPFFA-5060-00S-N	1590	50	60	2
L-PPFFA-6624-00S-N	1365	50	24	2
L-PPFFA-6630-00S-N	1458	50	30	2
L-PPFFA-6636-00S-N	1540	50	36	2
L-PPFFA-6642-00S-N	1623	50	42	2
L-PPFFA-6648-00S-N	1693	50	48	2
L-PPFFA-6654-00S-N	1828	50	54	2
L-PPFFA-6660-00S-N	1861	50	60	2
L-PPFFA-8224-00S-N	1644	82	24	2
L-PPFFA-8230-00S-N	1912	82	30	2
L-PPFFA-8236-00S-N	2022	82	36	2
L-PPFFA-8242-00S-N	2082	82	42	2
L-PPFFA-8248-00S-N	2172	82	48	2
One 24" frosted acrylic segment on top				
L-PPFFA-6624-00T-N	1365	66	24	2
L-PPFFA-6630-00T-N	1458	66	30	2
L-PPFFA-6636-00T-N	1540	66	36	2
L-PPFFA-6642-00T-N	1610	66	42	2
L-PPFFA-6648-00T-N	1679	66	48	2
L-PPFFA-6654-00T-N	1828	66	54	2
L-PPFFA-6660-00T-N	1861	66	60	2
Two 8" frosted acrylic segments on top				
L-PPFFA-6624-0EE-N	1653	66	24	2
L-PPFFA-6630-0EE-N	1885	66	30	2
L-PPFFA-6636-0EE-N	1989	66	36	2
L-PPFFA-6642-0EE-N	2048	66	42	2
L-PPFFA-6648-0EE-N	2151	66	48	2
L-PPFFA-6654-0EE-N	2238	66	54	2
L-PPFFA-6660-0EE-N	2296	66	60	2
One 8" & One 16" frosted acrylic segment on top				
L-PPFFA-6624-0ES-N	1605	66	24	2
L-PPFFA-6630-0ES-N	1827	66	30	2
L-PPFFA-6636-0ES-N	1930	66	36	2
L-PPFFA-6642-0ES-N	2041	66	42	2
L-PPFFA-6648-0ES-N	2136	66	48	2
L-PPFFA-6654-0ES-N	2246	66	54	2
L-PPFFA-6660-0ES-N	2312	66	60	2
Two 16" frosted acrylic segments on top				
L-PPFFA-8224-0SS-N	1546	82	24	2
L-PPFFA-8230-0SS-N	1767	82	30	2
L-PPFFA-8236-0SS-N	1855	82	36	2
L-PPFFA-8242-0SS-N	1922	82	42	2
L-PPFFA-8248-0SS-N	1994	82	48	2
One 24" & One 16" frosted acrylic segment on top				
L-PPFFA-8224-0TS-N	1754	82	24	2
L-PPFFA-8230-0TS-N	2034	82	30	2
L-PPFFA-8236-0TS-N	2108	82	36	2
L-PPFFA-8242-0TS-N	2204	82	42	2
L-PPFFA-8248-0TS-N	2448	82	48	2
Two 24" frosted acrylic segments on top				
L-PPFFA-8224-0TT-N	1749	82	24	2
L-PPFFA-8230-0TT-N	2007	82	30	2
L-PPFFA-8236-0TT-N	2136	82	36	2
L-PPFFA-8242-0TT-N	2305	82	42	2
L-PPFFA-8248-0TT-N	2391	82	48	2
One 8" & Two 16" frosted acrylic segments on top				
L-PPFFA-8224-ESS-N	1821	82	24	2
L-PPFFA-8230-ESS-N	2179	82	30	2
L-PPFFA-8236-ESS-N	2265	82	36	2
L-PPFFA-8242-ESS-N	2339	82	42	2
L-PPFFA-8248-ESS-N	2470	82	48	2
Three 16" frosted acrylic segments on top				
L-PPFFA-8224-SSS-N	1851	82	24	2
L-PPFFA-8230-SSS-N	2118	82	30	2
L-PPFFA-8236-SSS-N	2374	82	36	2
L-PPFFA-8242-SSS-N	2445	82	42	2
L-PPFFA-8248-SSS-N	2540	82	48	2

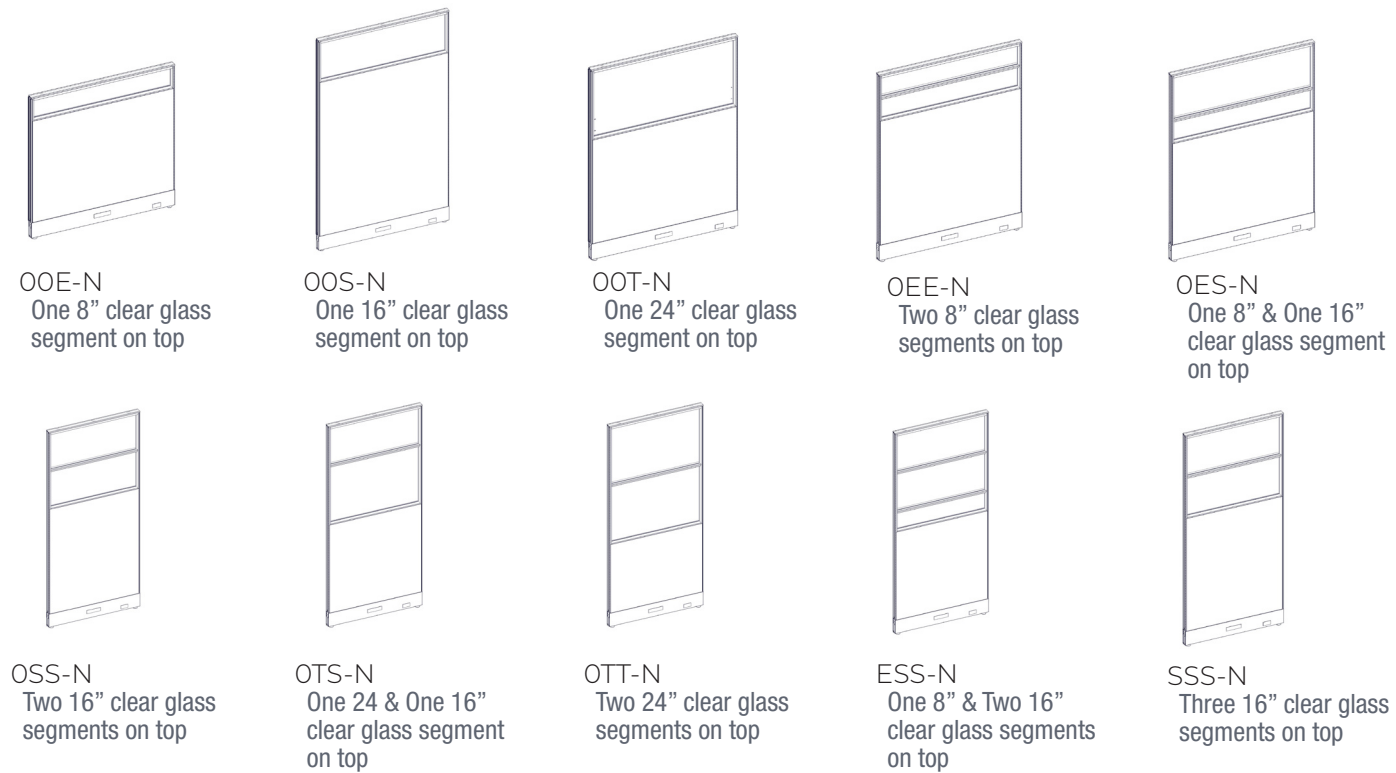

How to order and read your code

L - P P F C G - 42 24 - 00E - N

product standard line P=glazed E=Elevated F=Fabric L=Laminate C=Clear F=Frosted A=Acrylic G=Glass height width 0=No segment E=8 inch segment S=16 inch segment T=24 inch segment N=Non powered E=Powered

What's Included:

One (1) 2" thick fabric panel with 1" incremented slotted channels, Two (2) raceway covers, One (1) top trim

How to Specify:

Refer to panel fabric cards for fabric selections
Choose White, Black, Silver, Charcoal for Panel Frame colour

Notes:

Power capable panel with bracket for power module.
Power module must be specified seperately.
Panels are non tackable. For tackable option see Panel Add-On section.
Fabric Upcharge
Grade 2 - \$226 per panel,
Grade 3- \$278 per panel

Options:

Height*: 34", 42", 50", 66", 82"
Width: 24", 30", 36", 42", 48", 54", 60", 66", 72"
Fabric
Metal Powder Coat Paint: White, Black, Silver, Charcoal

*34" high - 50" high available up to 72" wide, 66" high available up to 60" wide, 82" high available up to 48" wide

Code	Price	H	W	D
One 8" clear glass segment on top				
L-PPFCG-4224-00E-N	1316	42	24	2
L-PPFCG-4230-00E-N	1397	42	30	2
L-PPFCG-4236-00E-N	1481	42	36	2
L-PPFCG-4242-00E-N	1562	42	42	2
L-PPFCG-4248-00E-N	1645	42	48	2
L-PPFCG-4254-00E-N	1727	42	54	2
L-PPFCG-4260-00E-N	1809	42	60	2
L-PPFCG-5024-00E-N	1316	50	24	2
L-PPFCG-5030-00E-N	1397	50	30	2
L-PPFCG-5036-00E-N	1481	50	36	2
L-PPFCG-5042-00E-N	1562	50	42	2
L-PPFCG-5048-00E-N	1645	50	48	2
L-PPFCG-5054-00E-N	1727	50	54	2
L-PPFCG-5060-00E-N	1809	50	60	2
One 16" clear glass segment on top				
L-PPFCG-5024-00S-N	1316	50	24	2
L-PPFCG-5030-00S-N	1397	50	30	2
L-PPFCG-5036-00S-N	1481	50	36	2
L-PPFCG-5042-00S-N	1562	50	42	2
L-PPFCG-5048-00S-N	1645	50	48	2
L-PPFCG-5054-00S-N	1727	50	54	2
L-PPFCG-5060-00S-N	1809	50	60	2
L-PPFCG-6624-00S-N	1370	66	24	2
L-PPFCG-6630-00S-N	1471	66	30	2
L-PPFCG-6636-00S-N	1577	66	36	2
L-PPFCG-6642-00S-N	1678	66	42	2
L-PPFCG-6648-00S-N	1784	66	48	2
L-PPFCG-6654-00S-N	1885	66	54	2
L-PPFCG-6660-00S-N	1988	66	60	2
L-PPFCG-8224-00S-N	1562	82	24	2
L-PPFCG-8230-00S-N	1845	82	30	2
L-PPFCG-8236-00S-N	1966	82	36	2
L-PPFCG-8242-00S-N	2031	82	42	2
L-PPFCG-8248-00S-N	2144	82	48	2
One 24" clear glass segment on top				
L-PPFCG-6624-00T-N	1370	66	24	2
L-PPFCG-6630-00T-N	1471	66	30	2
L-PPFCG-6636-00T-N	1577	66	36	2
L-PPFCG-6642-00T-N	1678	66	42	2
L-PPFCG-6648-00T-N	1784	66	48	2
L-PPFCG-6654-00T-N	1885	66	54	2
L-PPFCG-6660-00T-N	1988	66	60	2

Code	Price	H	W	D
Two 8" clear glass segments on top				
L-PPFCG-6624-0EE-N	1690	66	24	2
L-PPFCG-6630-0EE-N	1937	66	30	2
L-PPFCG-6636-0EE-N	2040	66	36	2
L-PPFCG-6642-0EE-N	2115	66	42	2
L-PPFCG-6648-0EE-N	2213	66	48	2
L-PPFCG-6654-0EE-N	2344	66	54	2
L-PPFCG-6660-0EE-N	2411	66	60	2
One 8" & One 16" clear glass segment on top				
L-PPFCG-6624-0ES-N	1646	66	24	2
L-PPFCG-6630-0ES-N	1863	66	30	2
L-PPFCG-6636-0ES-N	1970	66	36	2
L-PPFCG-6642-0ES-N	2069	66	42	2
L-PPFCG-6648-0ES-N	2191	66	48	2
L-PPFCG-6654-0ES-N	2331	66	54	2
L-PPFCG-6660-0ES-N	2406	66	60	2
Two 16" clear glass segments on top				
L-PPFCG-8224-0SS-N	1749	82	24	2
L-PPFCG-8230-0SS-N	2013	82	30	2
L-PPFCG-8236-0SS-N	2147	82	36	2
L-PPFCG-8242-0SS-N	2256	82	42	2
L-PPFCG-8248-0SS-N	2391	82	48	2
One 24" & One 16" clear glass segment on top				
L-PPFCG-8224-0TS-N	1736	82	24	2
L-PPFCG-8230-0TS-N	1978	82	30	2
L-PPFCG-8236-0TS-N	2112	82	36	2
L-PPFCG-8242-0TS-N	2232	82	42	2
L-PPFCG-8248-0TS-N	2382	82	48	2
Two 24" clear glass segments on top				
L-PPFCG-8224-0TT-N	1767	82	24	2
L-PPFCG-8230-0TT-N	2004	82	30	2
L-PPFCG-8236-0TT-N	2126	82	36	2
L-PPFCG-8242-0TT-N	2252	82	42	2
L-PPFCG-8248-0TT-N	2400	82	48	2
One 8" & Two 16" clear glass segments on top				
L-PPFCG-8224-ESS-N	1899	82	24	2
L-PPFCG-8230-ESS-N	2210	82	30	2
L-PPFCG-8236-ESS-N	2353	82	36	2
L-PPFCG-8242-ESS-N	2377	82	42	2
L-PPFCG-8248-ESS-N	2563	82	48	2
Three 16" clear glass segments on top				
L-PPFCG-8224-SSS-N	1938	82	24	2
L-PPFCG-8230-SSS-N	2165	82	30	2
L-PPFCG-8236-SSS-N	2313	82	36	2
L-PPFCG-8242-SSS-N	2457	82	42	2
L-PPFCG-8248-SSS-N	2623	82	48	2

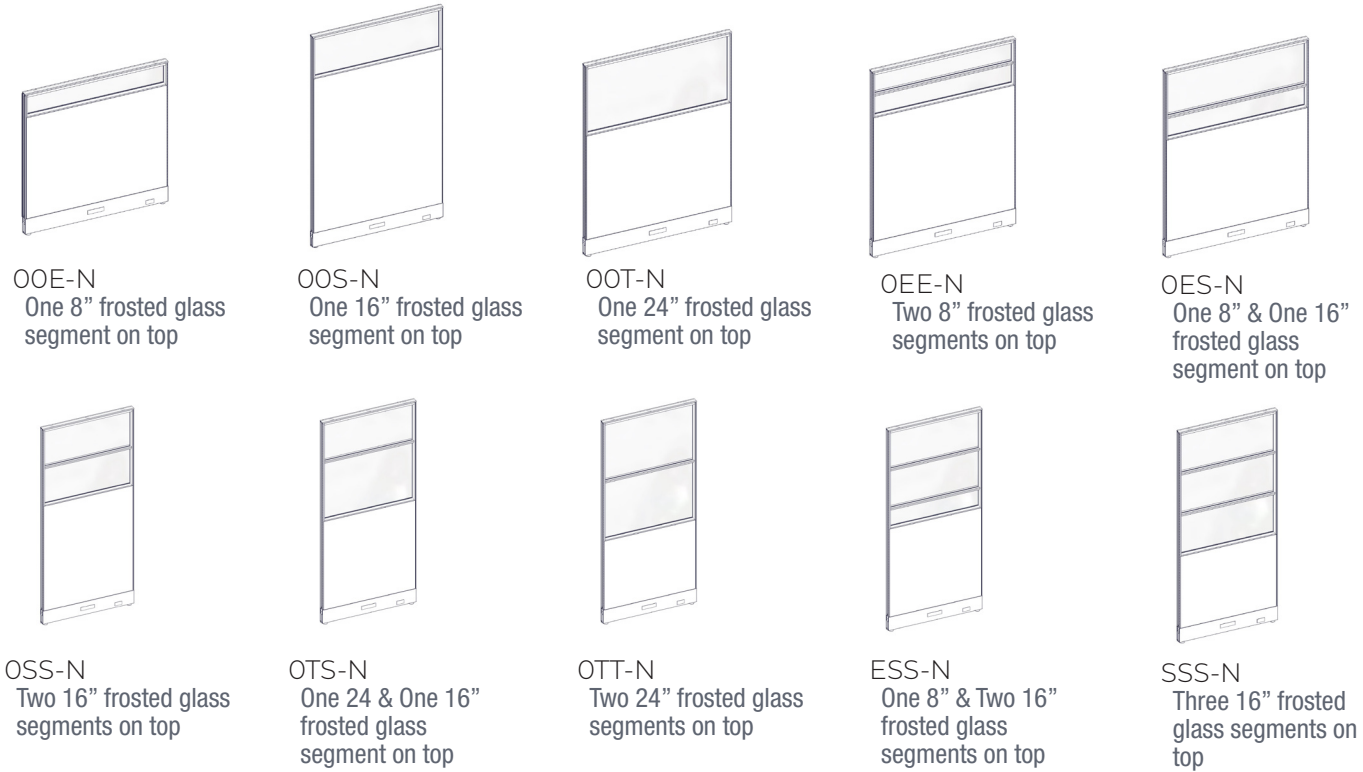

How to order and read your code

L - P P F F G - 42 24 - 00E - N

product standard P=glazed F=Fabric C=Clear A=Acrylic height width O = No segment N=Non powered
 line E = Elevated L=Laminate F=Frosted G=Glass E = 8 inch segment E=Powered
 S = 16 inch segment
 T = 24 inch segment

What's Included:

One (1) 2" thick fabric panel with 1" incremented slotted channels, Two (2) raceway covers, One (1) top trim

How to Specify:

Refer to panel fabric cards for fabric selections
 Choose White, Black, Silver, Charcoal for Panel Frame colour

Options:

Height*: 34", 42", 50", 66", 82"
 Width: 24", 30", 36", 42", 48", 54", 60", 66", 72"
 Fabric
 Metal Powder Coat Paint: White, Black, Silver, Charcoal

*34" high - 50" high available up to 72" wide, 66" high available up to 60" wide, 82" high available up to 48" wide

Code	Price	H	W	D
One 8" frosted glass segment on top				
L-PPFFG-4224-00E-N	1407	42	24	2
L-PPFFG-4230-00E-N	1505	42	30	2
L-PPFFG-4236-00E-N	1587	42	36	2
L-PPFFG-4242-00E-N	1669	42	42	2
L-PPFFG-4248-00E-N	1752	42	48	2
L-PPFFG-4254-00E-N	1834	42	54	2
L-PPFFG-4260-00E-N	1915	42	60	2
One 16" frosted glass segment on top				
L-PPFFG-5024-00E-N	1422	50	24	2
L-PPFFG-5030-00E-N	1505	50	30	2
L-PPFFG-5036-00E-N	1587	50	36	2
L-PPFFG-5042-00E-N	1669	50	42	2
L-PPFFG-5048-00E-N	1752	50	48	2
L-PPFFG-5054-00E-N	1834	50	54	2
L-PPFFG-5060-00E-N	1915	50	60	2
One 24" frosted glass segment on top				
L-PPFFG-5024-00S-N	1422	50	24	2
L-PPFFG-5030-00S-N	1505	50	30	2
L-PPFFG-5036-00S-N	1587	50	36	2
L-PPFFG-5042-00S-N	1669	50	42	2
L-PPFFG-5048-00S-N	1752	50	48	2
L-PPFFG-5054-00S-N	1834	50	54	2
L-PPFFG-5060-00S-N	1915	50	60	2
One 8" & One 16" frosted glass segment on top				
L-PPFFG-6624-00E-N	1476	66	24	2
L-PPFFG-6630-00E-N	1578	66	30	2
L-PPFFG-6636-00E-N	1683	66	36	2
L-PPFFG-6642-00E-N	1785	66	42	2
L-PPFFG-6648-00E-N	1889	66	48	2
L-PPFFG-6654-00E-N	1992	66	54	2
L-PPFFG-6660-00E-N	2094	66	60	2
One 16" & One 24" frosted glass segment on top				
L-PPFFG-8224-00S-N	1654	82	24	2
L-PPFFG-8230-00S-N	1945	82	30	2
L-PPFFG-8236-00S-N	2085	82	36	2
L-PPFFG-8242-00S-N	2172	82	42	2
L-PPFFG-8248-00S-N	2305	82	48	2
One 24" frosted glass segment on top				
L-PPFFG-6624-00T-N	1476	66	24	2
L-PPFFG-6630-00T-N	1578	66	30	2
L-PPFFG-6636-00T-N	1683	66	36	2
L-PPFFG-6642-00T-N	1785	66	42	2
L-PPFFG-6648-00T-N	1889	66	48	2
L-PPFFG-6654-00T-N	1992	66	54	2
L-PPFFG-6660-00T-N	2094	66	60	2
Two 8" clear glass segments on top				
L-PPFFG-6624-0EE-N	1872	66	24	2
L-PPFFG-6630-0EE-N	2119	66	30	2
L-PPFFG-6636-0EE-N	2224	66	36	2
L-PPFFG-6642-0EE-N	2296	66	42	2
L-PPFFG-6648-0EE-N	2398	66	48	2
L-PPFFG-6654-0EE-N	2526	66	54	2
L-PPFFG-6660-0EE-N	2614	66	60	2
One 8" & One 16" frosted glass segment on top				
L-PPFFG-6624-0ES-N	1828	66	24	2
L-PPFFG-6630-0ES-N	2057	66	30	2
L-PPFFG-6636-0ES-N	2185	66	36	2
L-PPFFG-6642-0ES-N	2300	66	42	2
L-PPFFG-6648-0ES-N	2445	66	48	2
L-PPFFG-6654-0ES-N	2604	66	54	2
L-PPFFG-6660-0ES-N	2710	66	60	2
Two 16" frosted glass segments on top				
L-PPFFG-8224-0SS-N	1930	82	24	2
L-PPFFG-8230-0SS-N	2213	82	30	2
L-PPFFG-8236-0SS-N	2392	82	36	2
L-PPFFG-8242-0SS-N	2540	82	42	2
L-PPFFG-8248-0SS-N	2713	82	48	2
One 24" & One 16" frosted glass segment on top				
L-PPFFG-8224-0TS-N	1948	82	24	2
L-PPFFG-8230-0TS-N	2232	82	30	2
L-PPFFG-8236-0TS-N	2413	82	36	2
L-PPFFG-8242-0TS-N	2585	82	42	2
L-PPFFG-8248-0TS-N	2786	82	48	2
Two 24" frosted glass segments on top				
L-PPFFG-8224-0TT-N	2011	82	24	2
L-PPFFG-8230-0TT-N	2305	82	30	2
L-PPFFG-8236-0TT-N	2489	82	36	2
L-PPFFG-8242-0TT-N	2675	82	42	2
L-PPFFG-8248-0TT-N	2885	82	48	2
One 8" & Two 16" frosted glass segments on top				
L-PPFFG-8224-ESS-N	2172	82	24	2
L-PPFFG-8230-ESS-N	2502	82	30	2
L-PPFFG-8236-ESS-N	2686	82	36	2
L-PPFFG-8242-ESS-N	2750	82	42	2
L-PPFFG-8248-ESS-N	2978	82	48	2
Three 16" frosted glass segments on top				
L-PPFFG-8224-SSS-N	2211	82	24	2
L-PPFFG-8230-SSS-N	2469	82	30	2
L-PPFFG-8236-SSS-N	2677	82	36	2
L-PPFFG-8242-SSS-N	2881	82	42	2
L-PPFFG-8248-SSS-N	3109	82	48	2

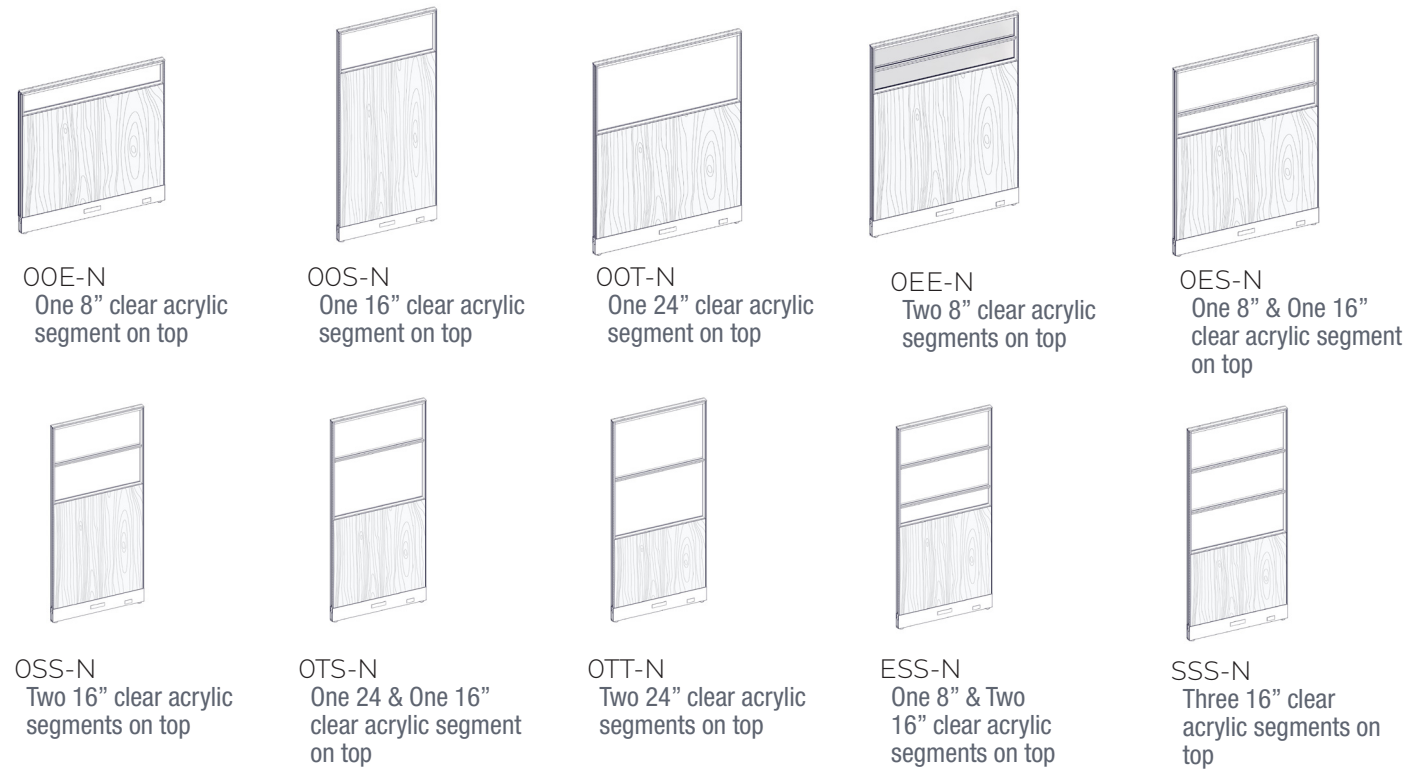

How to order and read your code

L - P P L C A - 42 24 - 00E - N

product line	standard	P=glazed E=Elevated	F=Fabric L=Laminate	C=Clear F=Frosted	A=Acrylic height G=Glass	width	0=No segment E=8 inch segment S=16 inch segment T=24 inch segment	N=Non powered E=Powered
--------------	----------	------------------------	------------------------	----------------------	-----------------------------	-------	--	----------------------------

What's Included:

One (1) 2" thick laminate panel with 1" incremented slotted channels,
Two (2) raceway covers,
One (1) top trim

How to Specify:

Refer to laminate cards for laminate selections
Choose White, Black, Silver, Charcoal for Panel Frame colour

Options:

Height*:	34", 42", 50", 66", 82"
Width:	24", 30", 36", 42", 48",
Laminate	
Metal Powder Coat Paint:	White, Black, Silver, Charcoal

*82"H available up to 36"W

Notes:

Power capable panel with bracket for power module.
Power module must be specified separately.
Panels are non tackable. For tackable option see Panel Add-On section.

Code	Price	H	W	D
One 8" clear acrylic segment on top				
L-PPLCA-4224-00E-N	1203	42	24	2
L-PPLCA-4230-00E-N	1257	42	30	2
L-PPLCA-4236-00E-N	1315	42	36	2
L-PPLCA-4242-00E-N	1429	42	42	2
L-PPLCA-4248-00E-N	1459	42	48	2
L-PPLCA-5024-00E-N	1240	50	24	2
L-PPLCA-5030-00E-N	1297	50	30	2
L-PPLCA-5036-00E-N	1352	50	36	2
L-PPLCA-5042-00E-N	1494	50	42	2
L-PPLCA-5048-00E-N	1526	50	48	2
One 16" clear acrylic segment on top				
L-PPLCA-5024-00S-N	1251	50	24	2
L-PPLCA-5030-00S-N	1310	50	30	2
L-PPLCA-5036-00S-N	1370	50	36	2
L-PPLCA-5042-00S-N	1517	50	42	2
L-PPLCA-5048-00S-N	1552	50	48	2
L-PPLCA-6624-00S-N	1357	66	24	2
L-PPLCA-6630-00S-N	1437	66	30	2
L-PPLCA-6636-00S-N	1517	66	36	2
L-PPLCA-6642-00S-N	1721	66	42	2
L-PPLCA-6648-00S-N	1763	66	48	2
L-PPLCA-8224-00S-N	1678	82	24	2
L-PPLCA-8230-00S-N	1696	82	30	2
L-PPLCA-8236-00S-N	2260	82	36	2
One 24" clear acrylic segment on top				
L-PPLCA-6624-00T-N	1357	66	24	2
L-PPLCA-6630-00T-N	1455	66	30	2
L-PPLCA-6636-00T-N	1551	66	36	2
L-PPLCA-6642-00T-N	1721	66	42	2
L-PPLCA-6648-00T-N	1777	66	48	2
Two 8" clear acrylic segments on top				
L-PPLCA-6624-0EE-N	1464	66	24	2
L-PPLCA-6630-0EE-N	1483	66	30	2
L-PPLCA-6636-0EE-N	1789	66	36	2
L-PPLCA-6642-0EE-N	1831	66	42	2
L-PPLCA-6648-0EE-N	1890	66	48	2
One 8" & One 16" clear acrylic segment on top				
L-PPLCA-6624-0ES-N	1471	66	24	2
L-PPLCA-6630-0ES-N	1534	66	30	2
L-PPLCA-6636-0ES-N	1863	66	36	2
L-PPLCA-6642-0ES-N	1927	66	42	2
L-PPLCA-6648-0ES-N	1989	66	48	2
Two 16" clear acrylic segments on top				
L-PPLCA-8224-0SS-N	1529	82	24	2
L-PPLCA-8230-0SS-N	1606	82	30	2
L-PPLCA-8236-0SS-N	1974	82	36	2
One 24" & One 16" clear acrylic segment on top				
L-PPLCA-8224-0TS-N	1562	82	24	2
L-PPLCA-8230-0TS-N	1664	82	30	2
L-PPLCA-8236-0TS-N	1983	82	36	2
Two 24" clear acrylic segments on top				
L-PPLCA-8224-0TT-N	1495	82	24	2
L-PPLCA-8230-0TT-N	1584	82	30	2
L-PPLCA-8236-0TT-N	1859	82	36	2
One 8" & Two 16" clear acrylic segments on top				
L-PPLCA-8224-0SS-N	1631	82	24	2
L-PPLCA-8230-0SS-N	1809	82	30	2
L-PPLCA-8236-0SS-N	2140	82	36	2
Three 16" clear acrylic segments on top				
L-PPLCA-8224-0SS-N	1598	82	24	2
L-PPLCA-8230-0SS-N	1694	82	30	2
L-PPLCA-8236-0SS-N	2051	82	36	2

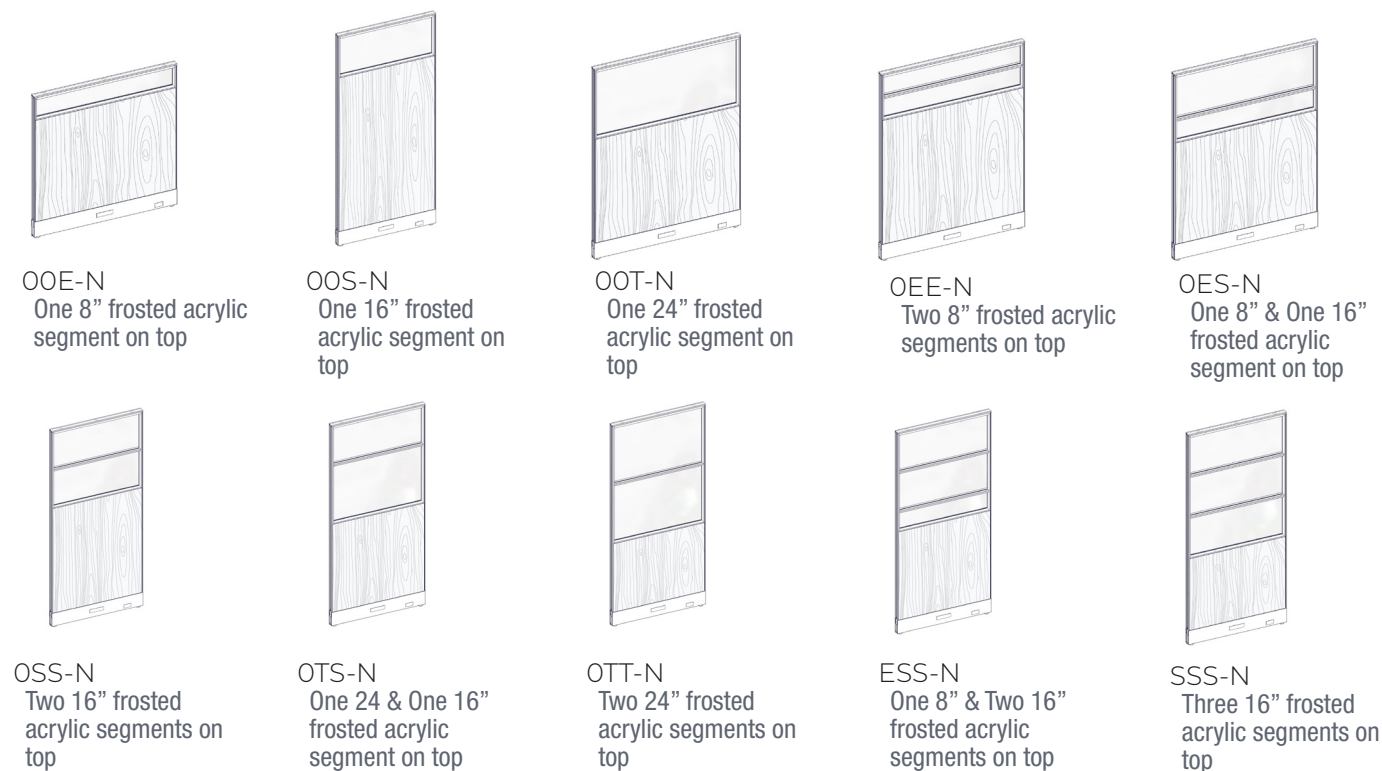

How to order and read your code

L - P P L F A - 42 24 - 00E - N

product standard P=glazed F=Fabric C=Clear A=Acrylic height width 0=No segment N=Non powered
 line E=Elevated L=Laminate F=Frosted G=Glass E=Powered
 S=16 inch segment
 T=24 inch segment

What's Included:

One (1) 2" thick laminate panel with 1" incremented slotted channels,
 Two (2) raceway covers,
 One (1) top trim

How to Specify:

Refer to laminate cards for laminate selections
 Choose White, Black, Silver, Charcoal for Panel Frame colour

Options:

Height*: 34", 42", 50", 66", 82"
 Width: 24", 30", 36", 42", 48",
 Laminate
 Metal Powder Coat Paint: White, Black, Silver, Charcoal

*82"H available up to 36"W

Code	Price	H	W	D
One 8" frosted acrylic segment on top				
L-PPLFA-4224-00E-N	1310	42	24	2
L-PPLFA-4230-00E-N	1364	42	30	2
L-PPLFA-4236-00E-N	1421	42	36	2
L-PPLFA-4242-00E-N	1535	42	42	2
L-PPLFA-4248-00E-N	1565	42	48	2
L-PPLFA-5024-00E-N	1347	50	24	2
L-PPLFA-5030-00E-N	1403	50	30	2
L-PPLFA-5036-00E-N	1459	50	36	2
L-PPLFA-5042-00E-N	1601	50	42	2
L-PPLFA-5048-00E-N	1631	50	48	2
One 16" frosted acrylic segment on top				
L-PPLFA-5024-00S-N	1357	50	24	2
L-PPLFA-5030-00S-N	1416	50	30	2
L-PPLFA-5036-00S-N	1476	50	36	2
L-PPLFA-5042-00S-N	1624	50	42	2
L-PPLFA-5048-00S-N	1658	50	48	2
L-PPLFA-6624-00S-N	1464	66	24	2
L-PPLFA-6630-00S-N	1546	66	30	2
L-PPLFA-6636-00S-N	1624	66	36	2
L-PPLFA-6642-00S-N	1828	66	42	2
L-PPLFA-6648-00S-N	1870	66	48	2
L-PPLFA-8224-00S-N	1716	82	24	2
L-PPLFA-8230-00S-N	1748	82	30	2
L-PPLFA-8236-00S-N	2325	82	36	2
One 24" frosted acrylic segment on top				
L-PPLFA-6624-00T-N	1464	66	24	2
L-PPLFA-6630-00T-N	1561	66	30	2
L-PPLFA-6636-00T-N	1611	66	36	2
L-PPLFA-6642-00T-N	1828	66	42	2
L-PPLFA-6648-00T-N	1884	66	48	2
Two 8" frosted acrylic segments on top				
L-PPLFA-6624-0EE-N	1532	66	24	2
L-PPLFA-6630-0EE-N	1573	66	30	2
L-PPLFA-6636-0EE-N	1906	66	36	2
L-PPLFA-6642-0EE-N	1944	66	42	2
L-PPLFA-6648-0EE-N	2025	66	48	2
One 8" & One 16" frosted acrylic segment on top				
L-PPLFA-6624-0ES-N	1528	66	24	2
L-PPLFA-6630-0ES-N	1606	66	30	2
L-PPLFA-6636-0ES-N	1954	66	36	2
L-PPLFA-6642-0ES-N	2039	66	42	2
L-PPLFA-6648-0ES-N	2103	66	48	2
Two 16" frosted acrylic segments on top				
L-PPLFA-8224-0SS-N	1423	82	24	2
L-PPLFA-8230-0SS-N	1455	82	30	2
L-PPLFA-8236-0SS-N	1771	82	36	2
One 24" & One 16" frosted acrylic segment on top				
L-PPLFA-8224-0TS-N	1677	82	24	2
L-PPLFA-8230-0TS-N	1814	82	30	2
L-PPLFA-8236-0TS-N	2133	82	36	2
Two 24" frosted acrylic segments on top				
L-PPLFA-8224-0TT-N	1609	82	24	2
L-PPLFA-8230-0TT-N	1733	82	30	2
L-PPLFA-8236-0TT-N	2039	82	36	2
One 8" & Two 16" frosted acrylic segments on top				
L-PPLFA-8224-ESS-N	1744	82	24	2
L-PPLFA-8230-ESS-N	1961	82	30	2
L-PPLFA-8236-ESS-N	2290	82	36	2
Three 16" frosted acrylic segments on top				
L-PPLFA-8224-SSS-N	1709	82	24	2
L-PPLFA-8230-SSS-N	1845	82	30	2
L-PPLFA-8236-SSS-N	2276	82	36	2

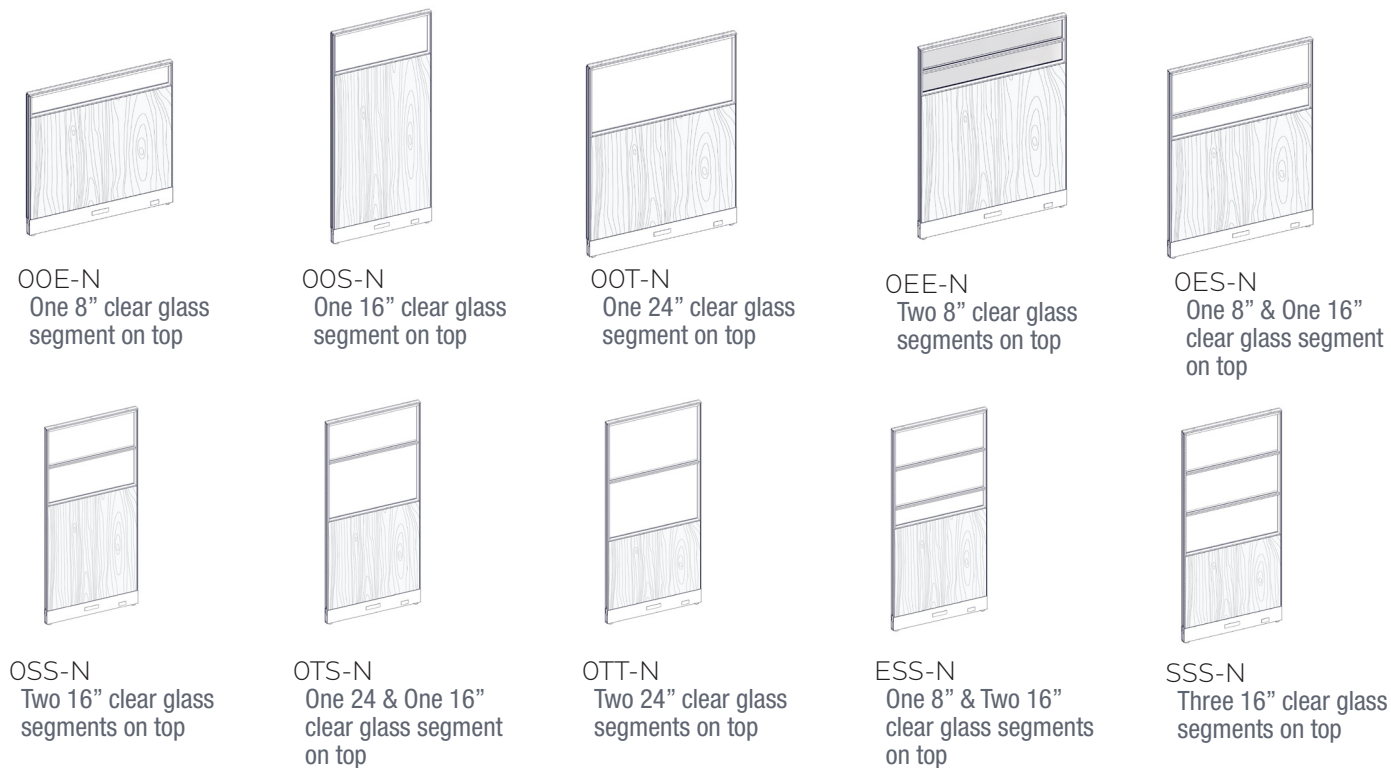

How to order and read your code

L - P P L C G - 42 24 - 00E - N

product standard P=glazed F=Fabric C=Clear A=Acrylic height width 0=No segment N=Non powered
 line E=Elevated L=Laminate F=Frosted G=Glass E=Powered
 S=16 inch segment
 T=24 inch segment

What's Included:

One (1) 2" thick laminate panel with 1" incremented slotted channels,
 Two (2) raceway covers,
 One (1) top trim

How to Specify:

Refer to laminate cards for laminate selections
 Choose White, Black, Silver, Charcoal for Panel Frame colour

Options:

Height*: 34", 42", 50", 66", 82"
 Width: 24", 30", 36", 42", 48",
 Laminate
 Metal Powder Coat Paint: White, Black, Silver, Charcoal

*82"H available up to 36"W

Code	Price	H	W	D
One 8" clear glass segment on top				
L-PPLCG-4224-00E-N	1305	42	24	2
L-PPLCG-4230-00E-N	1371	42	30	2
L-PPLCG-4236-00E-N	1435	42	36	2
L-PPLCG-4242-00E-N	1508	42	42	2
L-PPLCG-4248-00E-N	1581	42	48	2
L-PPLCG-5024-00E-N	1344	50	24	2
L-PPLCG-5030-00E-N	1407	50	30	2
L-PPLCG-5036-00E-N	1472	50	36	2
L-PPLCG-5042-00E-N	1547	50	42	2
L-PPLCG-5048-00E-N	1618	50	48	2
One 16" clear glass segment on top				
L-PPLCG-5024-00S-N	1427	50	24	2
L-PPLCG-5030-00S-N	1490	50	30	2
L-PPLCG-5036-00S-N	1553	50	36	2
L-PPLCG-5042-00S-N	1624	50	42	2
L-PPLCG-5048-00S-N	1700	50	48	2
L-PPLCG-6624-00S-N	1549	66	24	2
L-PPLCG-6630-00S-N	1629	66	30	2
L-PPLCG-6636-00S-N	1710	66	36	2
L-PPLCG-6642-00S-N	1809	66	42	2
L-PPLCG-6648-00S-N	1886	66	48	2
L-PPLCG-8224-00S-N	1635	82	24	2
L-PPLCG-8230-00S-N	1680	82	30	2
L-PPLCG-8236-00S-N	2266	82	36	2
One 24" clear glass segment on top				
L-PPLCG-6624-00T-N	1593	66	24	2
L-PPLCG-6630-00T-N	1674	66	30	2
L-PPLCG-6636-00T-N	1755	66	36	2
L-PPLCG-6642-00T-N	1862	66	42	2
L-PPLCG-6648-00T-N	1958	66	48	2
Two 8" clear glass segments on top				
L-PPLCG-6624-0EE-N	1568	66	24	2
L-PPLCG-6630-0EE-N	1623	66	30	2
L-PPLCG-6636-0EE-N	1958	66	36	2
L-PPLCG-6642-0EE-N	2011	66	42	2
L-PPLCG-6648-0EE-N	2087	66	48	2
One 8" & One 16" clear glass segment on top				
L-PPLCG-6624-0ES-N	1568	66	24	2
L-PPLCG-6630-0ES-N	1645	66	30	2
L-PPLCG-6636-0ES-N	1994	66	36	2
L-PPLCG-6642-0ES-N	2065	66	42	2
L-PPLCG-6648-0ES-N	2158	66	48	2
Two 16" clear glass segments on top				
L-PPLCG-8224-0SS-N	1626	82	24	2
L-PPLCG-8230-0SS-N	1700	82	30	2
L-PPLCG-8236-0SS-N	2069	82	36	2
One 24" & One 16" clear glass segment on top				
L-PPLCG-8224-0TS-N	1658	82	24	2
L-PPLCG-8230-0TS-N	1760	82	30	2
L-PPLCG-8236-0TS-N	2136	82	36	2
Two 24" clear glass segments on top				
L-PPLCG-8224-0TT-N	1625	82	24	2
L-PPLCG-8230-0TT-N	1731	82	30	2
L-PPLCG-8236-0TT-N	2029	82	36	2
One 8" & Two 16" clear glass segments on top				
L-PPLCG-8224-ESS-N	1821	82	24	2
L-PPLCG-8230-ESS-N	1990	82	30	2
L-PPLCG-8236-ESS-N	2377	82	36	2
Three 16" clear glass segments on top				
L-PPLCG-8224-SSS-N	1797	82	24	2
L-PPLCG-8230-SSS-N	1894	82	30	2
L-PPLCG-8236-SSS-N	2216	82	36	2

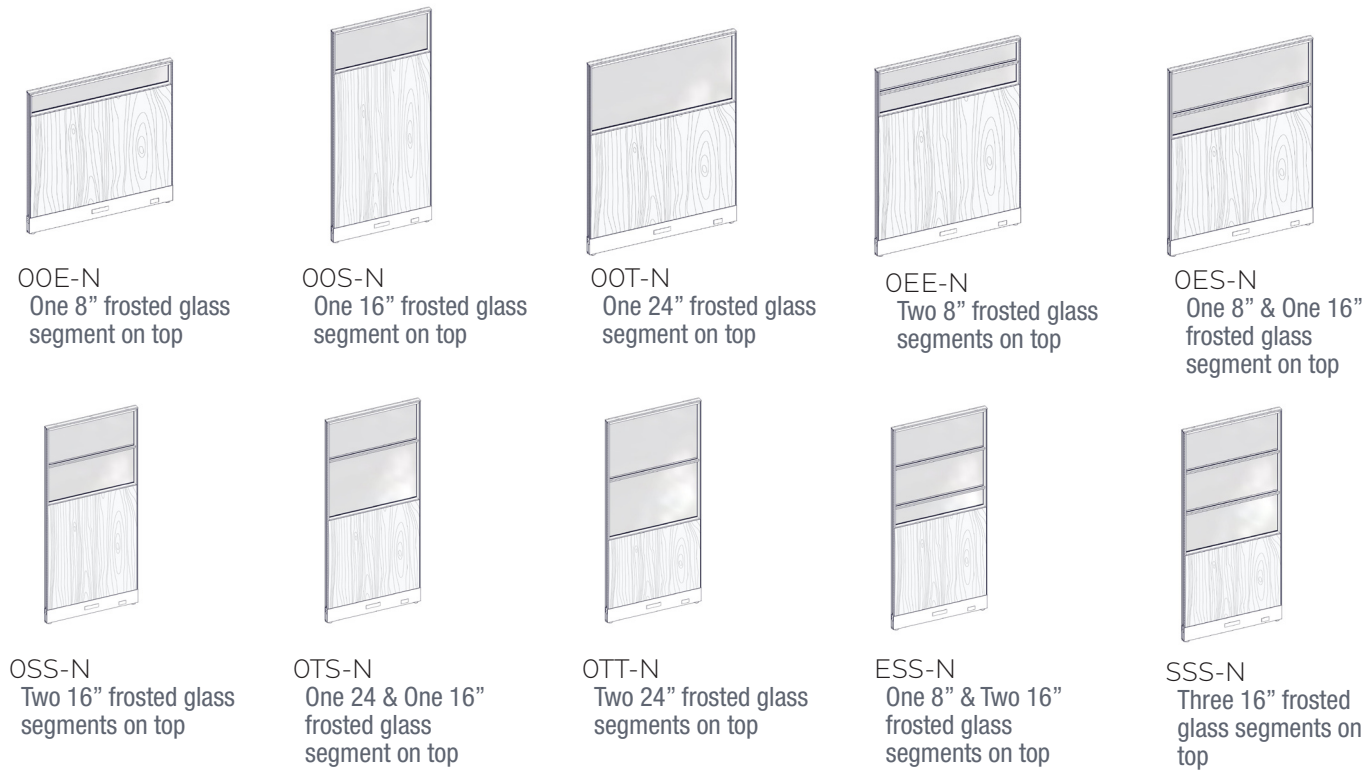

How to order and read your code

L - P P L F G - 42 24 - 00E - N

product line	standard	P=glazed E=Elevated	F=Fabric L=Laminate	C=Clear F=Frosted	A=Acrylic G=Glass	height	width	0=No segment E=8 inch segment S=16 inch segment T=24 inch segment	N=Non powered E=Powered
--------------	----------	------------------------	------------------------	----------------------	----------------------	--------	-------	--	----------------------------

What's Included:

One (1) 2" thick laminate panel with 1" incremented slotted channels,
Two (2) raceway covers,
One (1) top trim

How to Specify:

Refer to laminate cards for laminate selections
Choose White, Black, Silver, Charcoal for Panel Frame colour

Options:

Height*:	34", 42", 50", 66", 82"
Width:	24", 30", 36", 42", 48",
Laminate	
Metal Powder Coat Paint:	White, Black, Silver, Charcoal

*82"H available up to 36"W

Code	Price	H	W	D
One 8" frosted glass segment on top				
L-PPLFG-4224-00E-N	1413	42	24	2
L-PPLFG-4230-00E-N	1479	42	30	2
L-PPLFG-4236-00E-N	1540	42	36	2
L-PPLFG-4242-00E-N	1615	42	42	2
L-PPLFG-4248-00E-N	1689	42	48	2
L-PPLFG-5024-00E-N	1450	50	24	2
L-PPLFG-5030-00E-N	1513	50	30	2
L-PPLFG-5036-00E-N	1579	50	36	2
L-PPLFG-5042-00E-N	1653	50	42	2
L-PPLFG-5048-00E-N	1724	50	48	2
One 16" frosted glass segment on top				
L-PPLFG-5024-00S-N	1534	50	24	2
L-PPLFG-5030-00S-N	1598	50	30	2
L-PPLFG-5036-00S-N	1661	50	36	2
L-PPLFG-5042-00S-N	1731	50	42	2
L-PPLFG-5048-00S-N	1807	50	48	2
L-PPLFG-6624-00S-N	1655	66	24	2
L-PPLFG-6630-00S-N	1736	66	30	2
L-PPLFG-6636-00S-N	1818	66	36	2
L-PPLFG-6642-00S-N	1915	66	42	2
L-PPLFG-6648-00S-N	1993	66	48	2
L-PPLFG-8224-00S-N	1724	82	24	2
L-PPLFG-8230-00S-N	1781	82	30	2
L-PPLFG-8236-00S-N	2388	82	36	2
One 24" frosted glass segment on top				
L-PPLFG-6624-00T-N	1700	66	24	2
L-PPLFG-6630-00T-N	1780	66	30	2
L-PPLFG-6636-00T-N	1861	66	36	2
L-PPLFG-6642-00T-N	1969	66	42	2
L-PPLFG-6648-00T-N	2065	66	48	2
Two 8" frosted glass segments on top				
L-PPLFG-6624-0EE-N	1750	66	24	2
L-PPLFG-6630-0EE-N	1807	66	30	2
L-PPLFG-6636-0EE-N	2140	66	36	2
L-PPLFG-6642-0EE-N	2191	66	42	2
L-PPLFG-6648-0EE-N	2271	66	48	2
One 8" & One 16" frosted glass segment on top				
L-PPLFG-6624-0ES-N	1750	66	24	2
L-PPLFG-6630-0ES-N	1836	66	30	2
L-PPLFG-6636-0ES-N	2209	66	36	2
L-PPLFG-6642-0ES-N	2297	66	42	2
L-PPLFG-6648-0ES-N	2411	66	48	2
Two 16" frosted glass segments on top				
L-PPLFG-8224-0SS-N	1810	82	24	2
L-PPLFG-8230-0SS-N	1902	82	30	2
L-PPLFG-8236-0SS-N	2308	82	36	2
One 24" & One 16" frosted glass segment on top				
L-PPLFG-8224-0TS-N	1872	82	24	2
L-PPLFG-8230-0TS-N	2013	82	30	2
L-PPLFG-8236-0TS-N	2438	82	36	2
Two 24" frosted glass segments on top				
L-PPLFG-8224-0TT-N	1870	82	24	2
L-PPLFG-8230-0TT-N	2035	82	30	2
L-PPLFG-8236-0TT-N	2393	82	36	2
One 8" & Two 16" frosted glass segments on top				
L-PPLFG-8224-ESS-N	2094	82	24	2
L-PPLFG-8230-ESS-N	2283	82	30	2
L-PPLFG-8236-ESS-N	2711	82	36	2
Three 16" frosted glass segments on top				
L-PPLFG-8224-SSS-N	2071	82	24	2
L-PPLFG-8230-SSS-N	2197	82	30	2
L-PPLFG-8236-SSS-N	2580	82	36	2

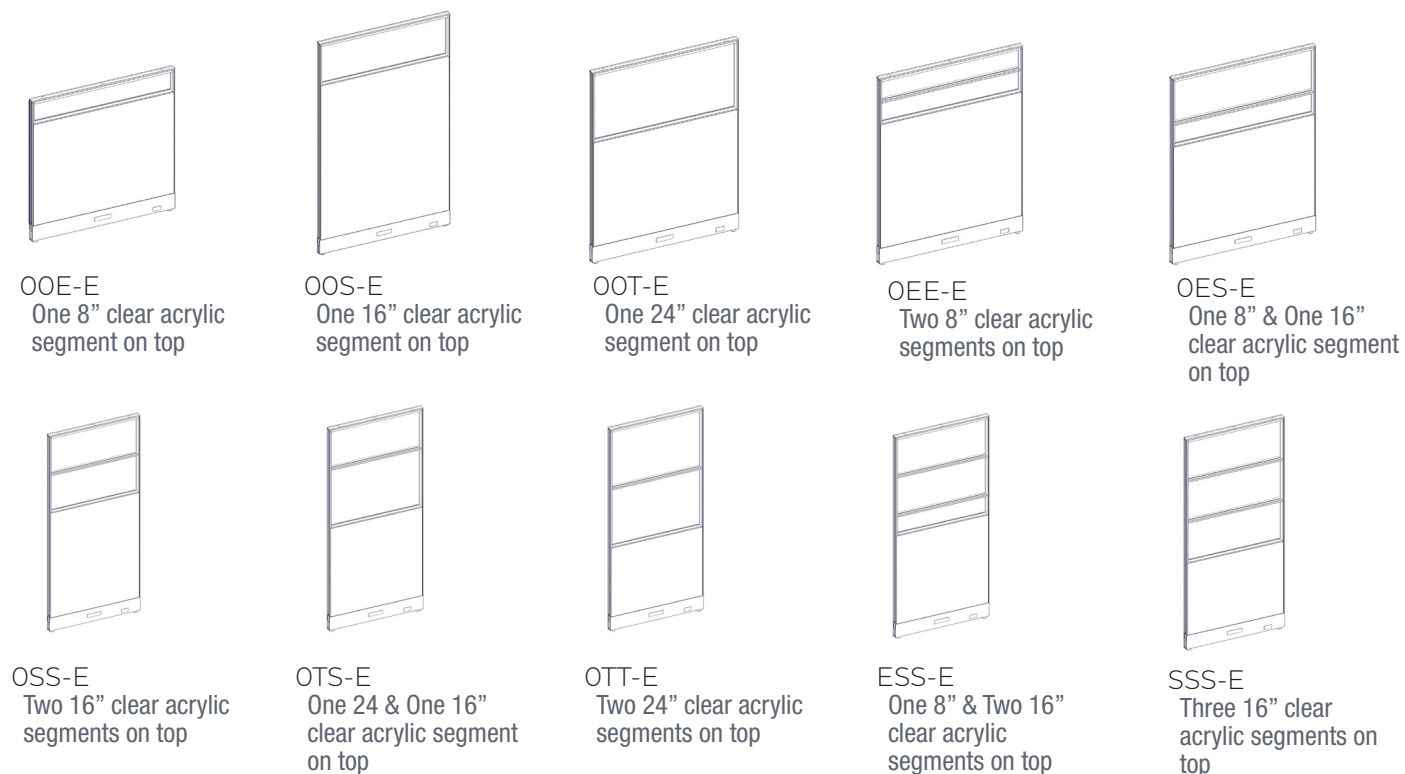

How to order and read your code

L - P P F C A - 42 24 - 00E - E

product standard P= glazed F=Fabric C=Clear A=Acrylic height width 0= No segment N=Non powered
 line E = Elevated L=Laminate F=Frosted G=Glass E = 8 inch segment E=Powered
 S = 16 inch segment
 T = 24 inch segment

What's Included:

One (1) 2" thick laminate panel with 1" incremented slotted channels,
 Two (2) raceway covers,
 One (1) top trim

How to Specify:

Refer to laminate cards for laminate selections
 Choose White, Black, Silver, Charcoal for Panel Frame colour

Options:

Height*: 34", 42", 50", 66", 82"

Width: 24", 30", 36", 42", 48",

Laminate

Metal Powder Coat Paint: White, Black, Silver, Charcoal

*82"H available up to 36"W

Notes:

Power capable panel with bracket for power module.
 Power module must be specified separately.
 Panels are non tackable. For tackable option see Panel Add-On section.
 Fabric Upcharge
 Grade 2 - \$226 per panel,
 Grade 3- \$278 per panel

Code	Price	H	W	D
One 8" clear acrylic segment on top				
L-PPFCA-4224-00E-E	1167	42	24	2
L-PPFCA-4230-00E-E	1243	42	30	2
L-PPFCA-4236-00E-E	1292	42	36	2
L-PPFCA-4242-00E-E	1342	42	42	2
L-PPFCA-4248-00E-E	1394	42	48	2
L-PPFCA-4254-00E-E	1479	42	54	2
L-PPFCA-4260-00E-E	1511	42	60	2
L-PPFCA-5024-00E-E	1167	50	24	2
L-PPFCA-5030-00E-E	1243	50	30	2
L-PPFCA-5036-00E-E	1292	50	36	2
L-PPFCA-5042-00E-E	1342	50	42	2
L-PPFCA-5048-00E-E	1394	50	48	2
L-PPFCA-5054-00E-E	1479	50	54	2
L-PPFCA-5060-00E-E	1511	50	60	2
One 16" clear acrylic segment on top				
L-PPFCA-5024-00S-E	1167	50	24	2
L-PPFCA-5030-00S-E	1243	50	30	2
L-PPFCA-5036-00S-E	1292	50	36	2
L-PPFCA-5042-00S-E	1342	50	42	2
L-PPFCA-5048-00S-E	1394	50	48	2
L-PPFCA-5054-00S-E	1479	50	54	2
L-PPFCA-5060-00S-E	1511	50	60	2
L-PPFCA-6624-00S-E	1286	66	24	2
L-PPFCA-6630-00S-E	1376	66	30	2
L-PPFCA-6636-00S-E	1460	66	36	2
L-PPFCA-6642-00S-E	1543	66	42	2
L-PPFCA-6648-00S-E	1611	66	48	2
L-PPFCA-6654-00S-E	1747	66	54	2
L-PPFCA-6660-00S-E	1779	66	60	2
L-PPFCA-8224-00S-E	1620	82	24	2
L-PPFCA-8230-00S-E	1877	82	30	2
L-PPFCA-8236-00S-E	1974	82	36	2
L-PPFCA-8242-00S-E	2020	82	42	2
L-PPFCA-8248-00S-E	2110	82	48	2
One 24" clear acrylic segment on top				
L-PPFCA-6624-00T-E	1286	66	24	2
L-PPFCA-6630-00T-E	1376	66	30	2
L-PPFCA-6636-00T-E	1460	66	36	2
L-PPFCA-6642-00T-E	1543	66	42	2
L-PPFCA-6648-00T-E	1611	66	48	2
L-PPFCA-6654-00T-E	1747	66	54	2
L-PPFCA-6660-00T-E	1779	66	60	2

Code	Price	H	W	D
Two 8" clear acrylic segments on top				
L-PPFCA-6624-0EE-E	1600	66	24	2
L-PPFCA-6630-0EE-E	1810	66	30	2
L-PPFCA-6636-0EE-E	1885	66	36	2
L-PPFCA-6642-0EE-E	1948	66	42	2
L-PPFCA-6648-0EE-E	2033	66	48	2
L-PPFCA-6654-0EE-E	2159	66	54	2
L-PPFCA-6660-0EE-E	2216	66	60	2
One 8" & One 16" clear acrylic segment on top				
L-PPFCA-6624-0ES-E	1562	66	24	2
L-PPFCA-6630-0ES-E	1766	66	30	2
L-PPFCA-6636-0ES-E	1855	66	36	2
L-PPFCA-6642-0ES-E	1943	66	42	2
L-PPFCA-6648-0ES-E	2037	66	48	2
L-PPFCA-6654-0ES-E	2134	66	54	2
L-PPFCA-6660-0ES-E	2182	66	60	2
Two 16" clear acrylic segments on top				
L-PPFCA-8224-0SS-E	1664	82	24	2
L-PPFCA-8230-0SS-E	1932	82	30	2
L-PPFCA-8236-0SS-E	2071	82	36	2
L-PPFCA-8242-0SS-E	2130	82	42	2
L-PPFCA-8248-0SS-E	2214	82	48	2
One 24" & One 16" clear acrylic segment on top				
L-PPFCA-8224-0TS-E	1655	82	24	2
L-PPFCA-8230-0TS-E	1898	82	30	2
L-PPFCA-8236-0TS-E	1974	82	36	2
L-PPFCA-8242-0TS-E	2034	82	42	2
L-PPFCA-8248-0TS-E	2237	82	48	2
Two 24" clear acrylic segments on top				
L-PPFCA-8224-0TT-E	1650	82	24	2
L-PPFCA-8230-0TT-E	1870	82	30	2
L-PPFCA-8236-0TT-E	1969	82	36	2
L-PPFCA-8242-0TT-E	2095	82	42	2
L-PPFCA-8248-0TT-E	2180	82	48	2
One 8" & Two 16" clear acrylic segments on top				
L-PPFCA-8224-ESS-E	1721	82	24	2
L-PPFCA-8230-ESS-E	2043	82	30	2
L-PPFCA-8236-ESS-E	2130	82	36	2
L-PPFCA-8242-ESS-E	2133	82	42	2
L-PPFCA-8248-ESS-E	2336	82	48	2
Three 16" clear acrylic segments on top				
L-PPFCA-8224-SSS-E	1752	82	24	2
L-PPFCA-8230-SSS-E	1980	82	30	2
L-PPFCA-8236-SSS-E	2163	82	36	2
L-PPFCA-8242-SSS-E	2234	82	42	2
L-PPFCA-8248-SSS-E	2328	82	48	2

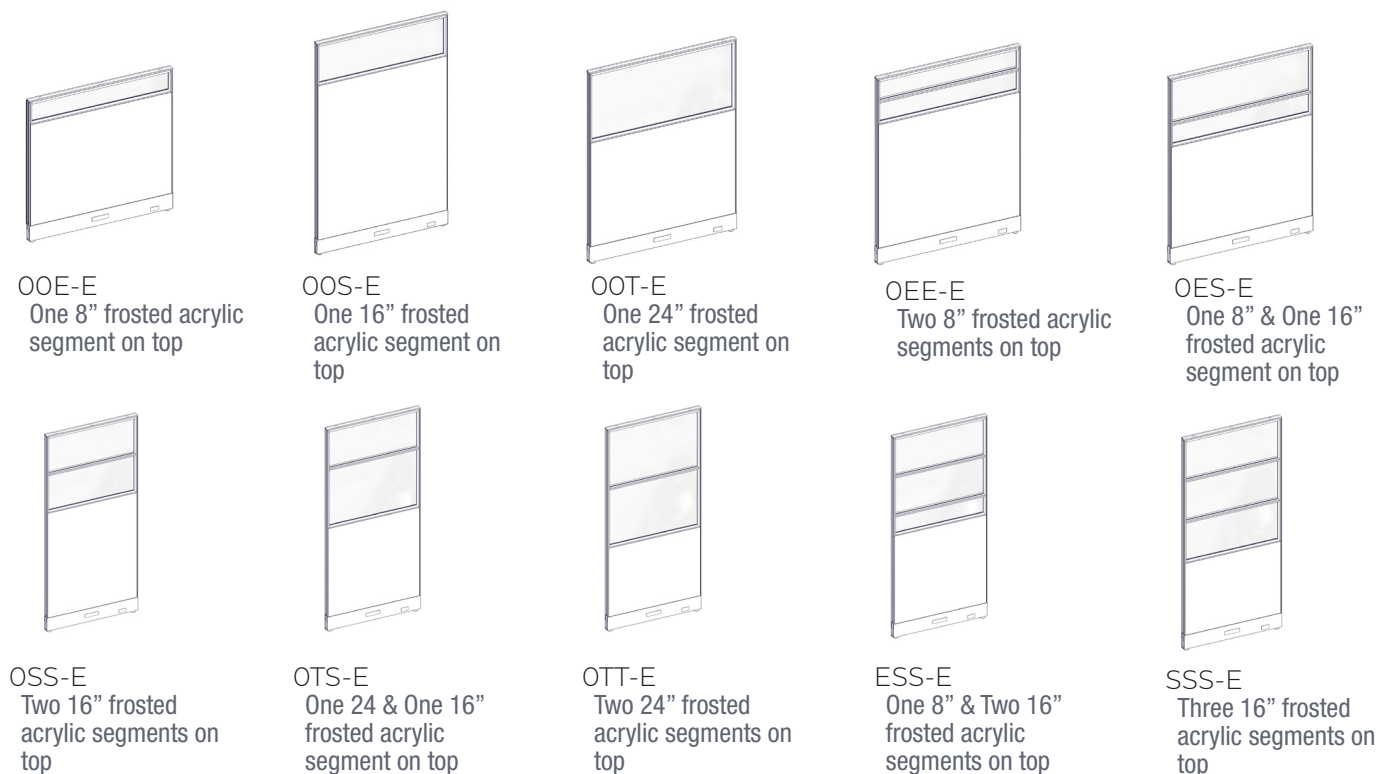

How to order and read your code

L - P P F F A - 42 24 - 00 E - E

product standard P=glazed F=Fabric C=Clear A=Acrylic height width O=No segment N=Non powered
 line E=Elevated L=Laminate F=Frosted G=Glass E=8 inch segment E=Powered
 S=16 inch segment
 T=24 inch segment

What's Included:

One (1) 2" thick laminate panel with 1" incremented slotted channels,
 Two (2) raceway covers,
 One (1) top trim

How to Specify:

Refer to laminate cards for laminate selections
 Choose White, Black, Silver, Charcoal for Panel Frame colour

Options:

Height*:	34", 42", 50", 66", 82"
Width:	24", 30", 36", 42", 48",
Laminate	
Metal Powder Coat Paint:	White, Black, Silver, Charcoal

*82"H available up to 36"W

Notes:

Power capable panel with bracket for power module.
 Power module must be specified separately.
 Panels are non tackable. For tackable option see Panel Add-On section.
 Fabric Upcharge
 Grade 2 - \$226 per panel,
 Grade 3- \$278 per panel

Code	Price	H	W	D
One 8" frosted acrylic segment on top				
L-PPFFA-4224-00E-E	1273	42	24	2
L-PPFFA-4230-00E-E	1350	42	30	2
L-PPFFA-4236-00E-E	1398	42	36	2
L-PPFFA-4242-00E-E	1448	42	42	2
L-PPFFA-4248-00E-E	1501	42	48	2
L-PPFFA-4254-00E-E	1584	42	54	2
L-PPFFA-4260-00E-E	1618	42	60	2
One 16" frosted acrylic segment on top				
L-PPFFA-5024-00E-E	1273	50	24	2
L-PPFFA-5030-00E-E	1350	50	30	2
L-PPFFA-5036-00E-E	1398	50	36	2
L-PPFFA-5042-00E-E	1448	50	42	2
L-PPFFA-5048-00E-E	1501	50	48	2
L-PPFFA-5054-00E-E	1584	50	54	2
L-PPFFA-5060-00E-E	1618	50	60	2
One 24" frosted acrylic segment on top				
L-PPFFA-6624-00E-E	1393	66	24	2
L-PPFFA-6630-00E-E	1483	66	30	2
L-PPFFA-6636-00E-E	1566	66	36	2
L-PPFFA-6642-00E-E	1623	66	42	2
L-PPFFA-6648-00E-E	1693	66	48	2
L-PPFFA-6654-00E-E	1854	66	54	2
L-PPFFA-6660-00E-E	1885	66	60	2
One 8" & One 16" frosted acrylic segment on top				
L-PPFFA-6224-00E-E	1619	66	24	2
L-PPFFA-6230-00E-E	1839	66	30	2
L-PPFFA-6236-00E-E	1944	66	36	2
L-PPFFA-6242-00E-E	2057	66	42	2
L-PPFFA-6248-00E-E	2150	66	48	2
L-PPFFA-6254-00E-E	2258	66	54	2
L-PPFFA-6260-00E-E	2327	66	60	2
One 8" & Two 16" frosted acrylic segments on top				
L-PPFFA-6224-00S-E	1558	82	24	2
L-PPFFA-6230-00S-E	1781	82	30	2
L-PPFFA-6236-00S-E	1867	82	36	2
L-PPFFA-6242-00S-E	1934	82	42	2
L-PPFFA-6248-00S-E	2010	82	48	2
One 8" & One 24" frosted acrylic segment on top				
L-PPFFA-8224-00S-E	1767	82	24	2
L-PPFFA-8230-00S-E	2047	82	30	2
L-PPFFA-8236-00S-E	2122	82	36	2
L-PPFFA-8242-00S-E	2219	82	42	2
L-PPFFA-8248-00S-E	2463	82	48	2
One 16" & One 24" frosted acrylic segment on top				
L-PPFFA-8224-00T-E	1763	82	24	2
L-PPFFA-8230-00T-E	2020	82	30	2
L-PPFFA-8236-00T-E	2150	82	36	2
L-PPFFA-8242-00T-E	2320	82	42	2
L-PPFFA-8248-00T-E	2405	82	48	2
One 16" & Two 16" frosted acrylic segments on top				
L-PPFFA-8224-00SS-E	1835	82	24	2
L-PPFFA-8230-00SS-E	2191	82	30	2
L-PPFFA-8236-00SS-E	2280	82	36	2
L-PPFFA-8242-00SS-E	2353	82	42	2
L-PPFFA-8248-00SS-E	2485	82	48	2
Three 16" frosted acrylic segments on top				
L-PPFFA-8224-00SSS-E	1863	82	24	2
L-PPFFA-8230-00SSS-E	2131	82	30	2
L-PPFFA-8236-00SSS-E	2389	82	36	2
L-PPFFA-8242-00SSS-E	2459	82	42	2
L-PPFFA-8248-00SSS-E	2554	82	48	2

Code	Price	H	W	D
Two 8" frosted acrylic segments on top				
L-PPFFA-6624-00E-E	1666	66	24	2
L-PPFFA-6630-00E-E	1901	66	30	2
L-PPFFA-6636-00E-E	2004	66	36	2
L-PPFFA-6642-00E-E	2062	66	42	2
L-PPFFA-6648-00E-E	2165	66	48	2
L-PPFFA-6654-00E-E	2253	66	54	2
L-PPFFA-6660-00E-E	2309	66	60	2
One 8" & One 16" frosted acrylic segment on top				
L-PPFFA-6624-00S-E	1619	66	24	2
L-PPFFA-6630-00S-E	1839	66	30	2
L-PPFFA-6636-00S-E	1944	66	36	2
L-PPFFA-6642-00S-E	2057	66	42	2
L-PPFFA-6648-00S-E	2150	66	48	2
L-PPFFA-6654-00S-E	2258	66	54	2
L-PPFFA-6660-00S-E	2327	66	60	2
Two 16" frosted acrylic segments on top				
L-PPFFA-8224-00S-E	1558	82	24	2
L-PPFFA-8230-00S-E	1781	82	30	2
L-PPFFA-8236-00S-E	1867	82	36	2
L-PPFFA-8242-00S-E	1934	82	42	2
L-PPFFA-8248-00S-E	2010	82	48	2
One 24" & One 16" frosted acrylic segment on top				
L-PPFFA-8224-00T-E	1767	82	24	2
L-PPFFA-8230-00T-E	2047	82	30	2
L-PPFFA-8236-00T-E	2122	82	36	2
L-PPFFA-8242-00T-E	2219	82	42	2
L-PPFFA-8248-00T-E	2463	82	48	2
Two 24" frosted acrylic segments on top				
L-PPFFA-8224-00TT-E	1763	82	24	2
L-PPFFA-8230-00TT-E	2020	82	30	2
L-PPFFA-8236-00TT-E	2150	82	36	2
L-PPFFA-8242-00TT-E	2320	82	42	2
L-PPFFA-8248-00TT-E	2405	82	48	2
One 8" & Two 16" frosted acrylic segments on top				
L-PPFFA-8224-00SS-E	1835	82	24	2
L-PPFFA-8230-00SS-E	2191	82	30	2
L-PPFFA-8236-00SS-E	2280	82	36	2
L-PPFFA-8242-00SS-E	2353	82	42	2
L-PPFFA-8248-00SS-E	2485	82	48	2
Three 16" frosted acrylic segments on top				
L-PPFFA-8224-00SSS-E	1863	82	24	2
L-PPFFA-8230-00SSS-E	2131	82	30	2
L-PPFFA-8236-00SSS-E	2389	82	36	2
L-PPFFA-8242-00SSS-E	2459	82	42	2
L-PPFFA-8248-00SSS-E	2554	82	48	2

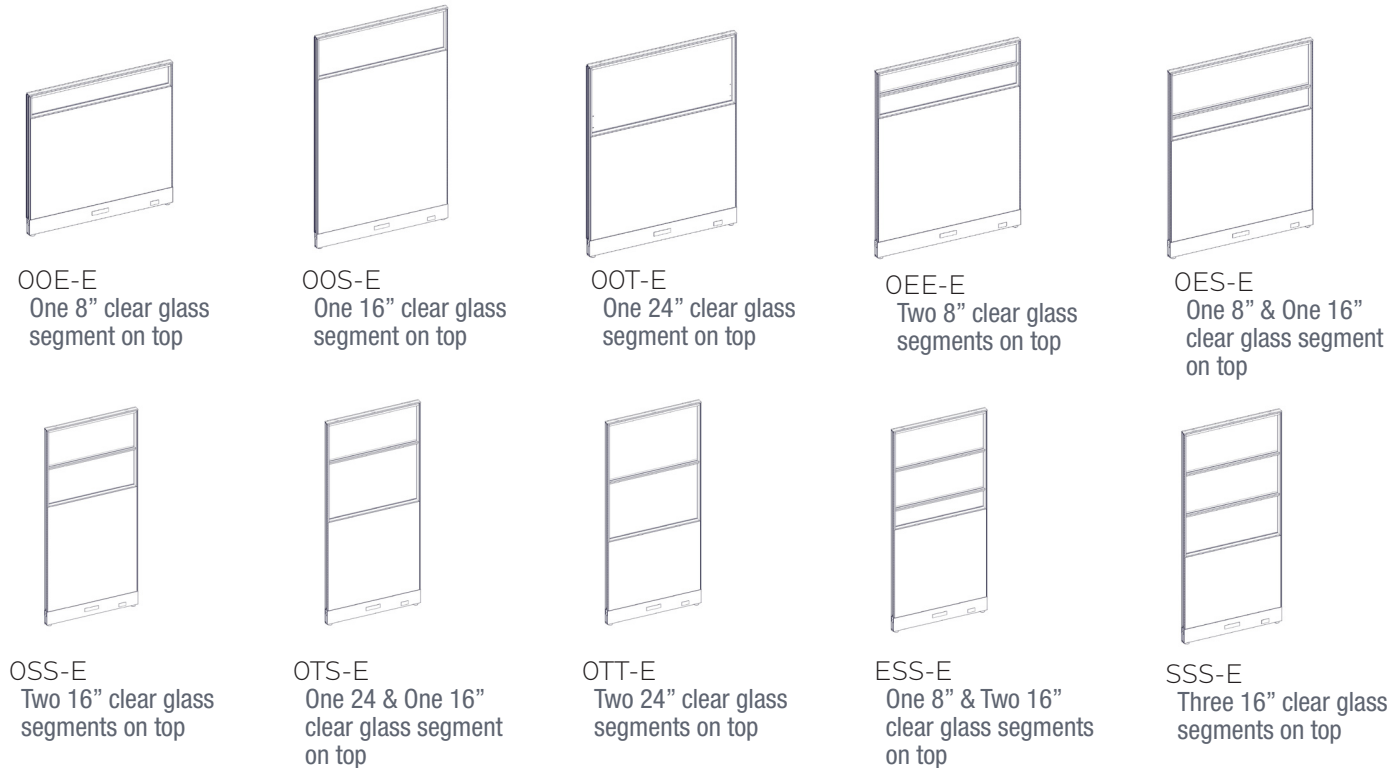

How to order and read your code

L - P P F C G - 42 24 - 00E - E

product standard P= glazed F=Fabric C=Clear A=Acrylic height width 0= No segment N=Non powered
 line line E = Elevated L=Laminate F=Frosted G=Glass E = 8 inch segment E=Powered
 S = 16 inch segment
 T = 24 inch segment

What's Included:

One (1) 2" thick laminate panel with 1" incremented slotted channels,
 Two (2) raceway covers,
 One (1) top trim

How to Specify:

Refer to laminate cards for laminate selections
 Choose White, Black, Silver, Charcoal for Panel Frame colour

Options:

Height*: 34", 42", 50", 66", 82"
 Width: 24", 30", 36", 42", 48",
 Laminate
 Metal Powder Coat Paint: White, Black, Silver, Charcoal
 *82"H available up to 36"W

Code	Price	H	W	D
One 8" clear glass segment on top				
L-PPFCG-4224-00E-E	1339	42	24	2
L-PPFCG-4230-00E-E	1423	42	30	2
L-PPFCG-4236-00E-E	1505	42	36	2
L-PPFCG-4242-00E-E	1639	42	42	2
L-PPFCG-4248-00E-E	1701	42	48	2
L-PPFCG-4254-00E-E	1752	42	54	2
L-PPFCG-4260-00E-E	1833	42	60	2
L-PPFCG-5024-00E-E	1339	50	24	2
L-PPFCG-5030-00E-E	1423	50	30	2
L-PPFCG-5036-00E-E	1505	50	36	2
L-PPFCG-5042-00E-E	1639	50	42	2
L-PPFCG-5048-00E-E	1701	50	48	2
L-PPFCG-5054-00E-E	1752	50	54	2
L-PPFCG-5060-00E-E	1833	50	60	2
One 16" clear glass segment on top				
L-PPFCG-5024-00S-E	1339	50	24	2
L-PPFCG-5030-00S-E	1423	50	30	2
L-PPFCG-5036-00S-E	1505	50	36	2
L-PPFCG-5042-00S-E	1639	50	42	2
L-PPFCG-5048-00S-E	1701	50	48	2
L-PPFCG-5054-00S-E	1752	50	54	2
L-PPFCG-5060-00S-E	1833	50	60	2
L-PPFCG-6624-00S-E	1394	66	24	2
L-PPFCG-6630-00S-E	1496	66	30	2
L-PPFCG-6636-00S-E	1600	66	36	2
L-PPFCG-6642-00S-E	1702	66	42	2
L-PPFCG-6648-00S-E	1807	66	48	2
L-PPFCG-6654-00S-E	1909	66	54	2
L-PPFCG-6660-00S-E	2014	66	60	2
L-PPFCG-8224-00S-E	1577	82	24	2
L-PPFCG-8230-00S-E	1860	82	30	2
L-PPFCG-8236-00S-E	1978	82	36	2
L-PPFCG-8242-00S-E	2044	82	42	2
L-PPFCG-8248-00S-E	2158	82	48	2
One 24" clear glass segment on top				
L-PPFCG-6624-00T-E	1394	66	24	2
L-PPFCG-6630-00T-E	1496	66	30	2
L-PPFCG-6636-00T-E	1600	66	36	2
L-PPFCG-6642-00T-E	1702	66	42	2
L-PPFCG-6648-00T-E	1807	66	48	2
L-PPFCG-6654-00T-E	1909	66	54	2
L-PPFCG-6660-00T-E	2014	66	60	2
Two 8" clear glass segments on top				
L-PPFCG-6624-0EE-E	1703	66	24	2
L-PPFCG-6630-0EE-E	1951	66	30	2
L-PPFCG-6636-0EE-E	2054	66	36	2
L-PPFCG-6642-0EE-E	2128	66	42	2
L-PPFCG-6648-0EE-E	2228	66	48	2
L-PPFCG-6654-0EE-E	2359	66	54	2
L-PPFCG-6660-0EE-E	2425	66	60	2
One 8" & One 16" clear glass segment on top				
L-PPFCG-6624-0ES-E	1661	66	24	2
L-PPFCG-6630-0ES-E	1878	66	30	2
L-PPFCG-6636-0ES-E	1984	66	36	2
L-PPFCG-6642-0ES-E	2082	66	42	2
L-PPFCG-6648-0ES-E	2205	66	48	2
L-PPFCG-6654-0ES-E	2344	66	54	2
L-PPFCG-6660-0ES-E	2419	66	60	2
Two 16" clear glass segments on top				
L-PPFCG-8224-0SS-E	1763	82	24	2
L-PPFCG-8230-0SS-E	2026	82	30	2
L-PPFCG-8236-0SS-E	2163	82	36	2
L-PPFCG-8242-0SS-E	2271	82	42	2
L-PPFCG-8248-0SS-E	2405	82	48	2
One 24" & One 16" clear glass segment on top				
L-PPFCG-8224-0TS-E	1750	82	24	2
L-PPFCG-8230-0TS-E	1993	82	30	2
L-PPFCG-8236-0TS-E	2126	82	36	2
L-PPFCG-8242-0TS-E	2248	82	42	2
L-PPFCG-8248-0TS-E	2396	82	48	2
Two 24" clear glass segments on top				
L-PPFCG-8224-0TT-E	1781	82	24	2
L-PPFCG-8230-0TT-E	2017	82	30	2
L-PPFCG-8236-0TT-E	2140	82	36	2
L-PPFCG-8242-0TT-E	2266	82	42	2
L-PPFCG-8248-0TT-E	2413	82	48	2
One 8" & Two 16" clear glass segments on top				
L-PPFCG-8224-0SS-E	1912	82	24	2
L-PPFCG-8230-0SS-E	2225	82	30	2
L-PPFCG-8236-0SS-E	2366	82	36	2
L-PPFCG-8242-0SS-E	2391	82	42	2
L-PPFCG-8248-0SS-E	2578	82	48	2
Three 16" clear glass segments on top				
L-PPFCG-8224-0SS-E	1952	82	24	2
L-PPFCG-8230-0SS-E	2180	82	30	2
L-PPFCG-8236-0SS-E	2328	82	36	2
L-PPFCG-8242-0SS-E	2471	82	42	2
L-PPFCG-8248-0SS-E	2639	82	48	2

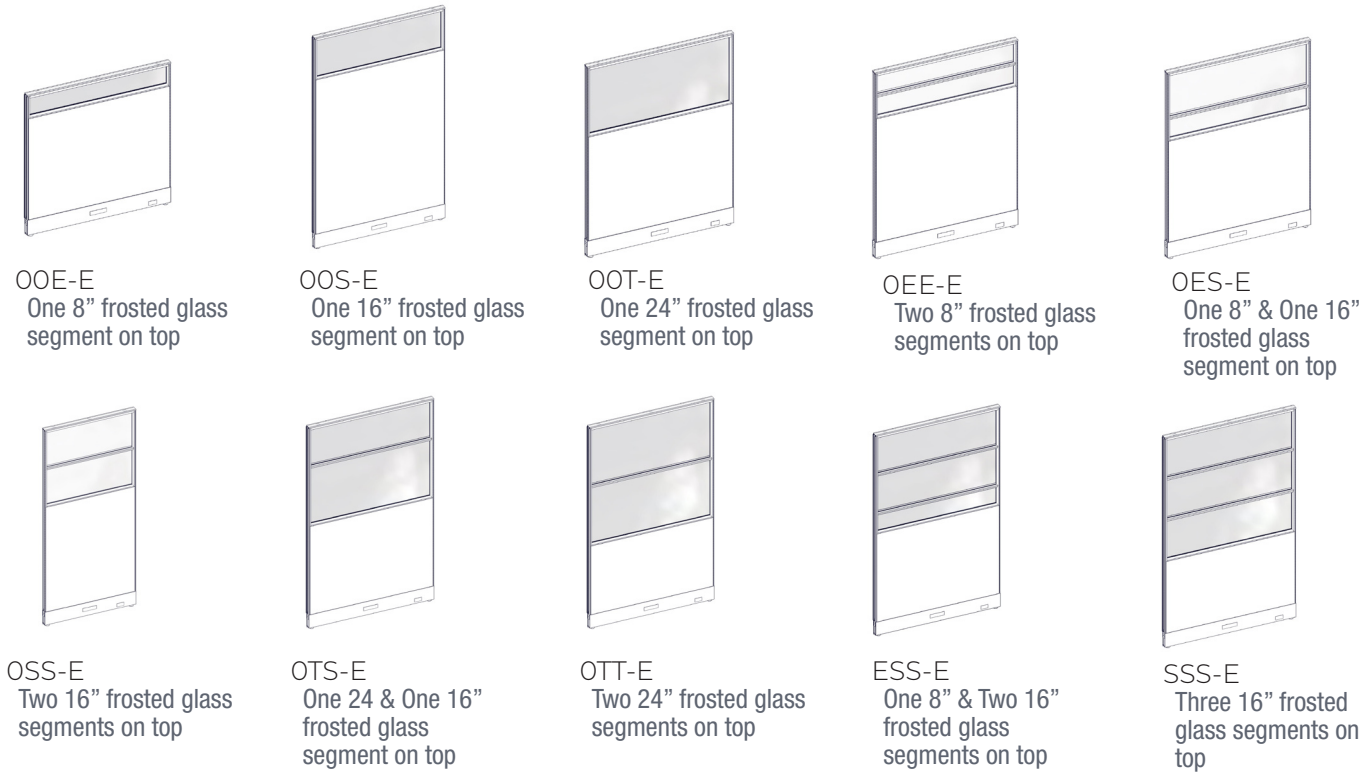

How to order and read your code

L - P P F F G - 42 24 - 00E - E

product standard P=glazed F=Fabric C=Clear A=Acrylic height width 0=No segment N=Non powered
line E=Elevated L=Laminate F=Frosted G=Glass E=8 inch segment E=Powered
S=16 inch segment
T=24 inch segment

What's Included:

One (1) 2" thick laminate panel with 1" incremented slotted channels,
Two (2) raceway covers,
One (1) top trim

How to Specify:

Refer to laminate cards for laminate selections
Choose White, Black, Silver, Charcoal for Panel Frame colour

Options:

Height*: 34", 42", 50", 66", 82"

Width: 24", 30", 36", 42", 48",

Laminate

Metal Powder Coat Paint: White, Black, Silver, Charcoal

*82"H available up to 36"W

Notes:

Power capable panel with bracket for power module.
Power module must be specified seperately.
Panels are non tackable. For tackable option see Panel Add-On section.
Fabric Upcharge
Grade 2 - \$226 per panel,
Grade 3- \$278 per panel

Code	Price	H	W	D
One 8" frosted glass segment on top				
L-PPFFG-4224-00E-E	1445	42	24	2
L-PPFFG-4230-00E-E	1531	42	30	2
L-PPFFG-4236-00E-E	1611	42	36	2
L-PPFFG-4242-00E-E	1745	42	42	2
L-PPFFG-4248-00E-E	1808	42	48	2
L-PPFFG-4254-00E-E	1859	42	54	2
L-PPFFG-4260-00E-E	1940	42	60	2
L-PPFFG-5024-00E-E	1445	50	24	2
L-PPFFG-5030-00E-E	1531	50	30	2
L-PPFFG-5036-00E-E	1611	50	36	2
L-PPFFG-5042-00E-E	1745	50	42	2
L-PPFFG-5048-00E-E	1808	50	48	2
L-PPFFG-5054-00E-E	1859	50	54	2
L-PPFFG-5060-00E-E	1940	50	60	2
One 16" frosted glass segment on top				
L-PPFFG-5024-00S-E	1445	50	24	2
L-PPFFG-5030-00S-E	1531	50	30	2
L-PPFFG-5036-00S-E	1611	50	36	2
L-PPFFG-5042-00S-E	1745	50	42	2
L-PPFFG-5048-00S-E	1808	50	48	2
L-PPFFG-5054-00S-E	1859	50	54	2
L-PPFFG-5060-00S-E	1940	50	60	2
L-PPFFG-6624-00S-E	1501	66	24	2
L-PPFFG-6630-00S-E	1603	66	30	2
L-PPFFG-6636-00S-E	1706	66	36	2
L-PPFFG-6642-00S-E	1809	66	42	2
L-PPFFG-6648-00S-E	1912	66	48	2
L-PPFFG-6654-00S-E	2016	66	54	2
L-PPFFG-6660-00S-E	2120	66	60	2
L-PPFFG-8224-00S-E	1667	82	24	2
L-PPFFG-8230-00S-E	1963	82	30	2
L-PPFFG-8236-00S-E	2099	82	36	2
L-PPFFG-8242-00S-E	2186	82	42	2
L-PPFFG-8248-00S-E	2320	82	48	2
One 24" frosted glass segment on top				
L-PPFFG-6624-00T-E	1501	66	24	2
L-PPFFG-6630-00T-E	1603	66	30	2
L-PPFFG-6636-00T-E	1706	66	36	2
L-PPFFG-6642-00T-E	1809	66	42	2
L-PPFFG-6648-00T-E	1912	66	48	2
L-PPFFG-6654-00T-E	2016	66	54	2
L-PPFFG-6660-00T-E	2120	66	60	2

Code	Price	H	W	D
Two 8" frosted glass segments on top				
L-PPFFG-6624-0EE-E	1885	66	24	2
L-PPFFG-6630-0EE-E	2133	66	30	2
L-PPFFG-6636-0EE-E	2236	66	36	2
L-PPFFG-6642-0EE-E	2309	66	42	2
L-PPFFG-6648-0EE-E	2411	66	48	2
L-PPFFG-6654-0EE-E	2541	66	54	2
L-PPFFG-6660-0EE-E	2627	66	60	2
One 8" & One 16" frosted glass segment on top				
L-PPFFG-6624-0ES-E	1843	66	24	2
L-PPFFG-6630-0ES-E	2071	66	30	2
L-PPFFG-6636-0ES-E	2198	66	36	2
L-PPFFG-6642-0ES-E	2316	66	42	2
L-PPFFG-6648-0ES-E	2459	66	48	2
L-PPFFG-6654-0ES-E	2618	66	54	2
L-PPFFG-6660-0ES-E	2722	66	60	2
Two 16" frosted glass segments on top				
L-PPFFG-8224-0SS-E	1944	82	24	2
L-PPFFG-8230-0SS-E	2228	82	30	2
L-PPFFG-8236-0SS-E	2406	82	36	2
L-PPFFG-8242-0SS-E	2554	82	42	2
L-PPFFG-8248-0SS-E	2726	82	48	2
One 24" & One 16" frosted glass segment on top				
L-PPFFG-8224-0TS-E	1964	82	24	2
L-PPFFG-8230-0TS-E	2248	82	30	2
L-PPFFG-8236-0TS-E	2428	82	36	2
L-PPFFG-8242-0TS-E	2602	82	42	2
L-PPFFG-8248-0TS-E	2801	82	48	2
Two 24" frosted glass segments on top				
L-PPFFG-8224-0TT-E	2025	82	24	2
L-PPFFG-8230-0TT-E	2320	82	30	2
L-PPFFG-8236-0TT-E	2503	82	36	2
L-PPFFG-8242-0TT-E	2690	82	42	2
L-PPFFG-8248-0TT-E	2900	82	48	2
One 8" & Two 16" frosted glass segments on top				
L-PPFFG-8224-0SS-E	2186	82	24	2
L-PPFFG-8230-0SS-E	2516	82	30	2
L-PPFFG-8236-0SS-E	2699	82	36	2
L-PPFFG-8242-0SS-E	2763	82	42	2
L-PPFFG-8248-0SS-E	2992	82	48	2
Three 16" frosted glass segments on top				
L-PPFFG-8224-0SS-E	2226	82	24	2
L-PPFFG-8230-0SS-E	2482	82	30	2
L-PPFFG-8236-0SS-E	2691	82	36	2
L-PPFFG-8242-0SS-E	2896	82	42	2
L-PPFFG-8248-0SS-E	3122	82	48	2

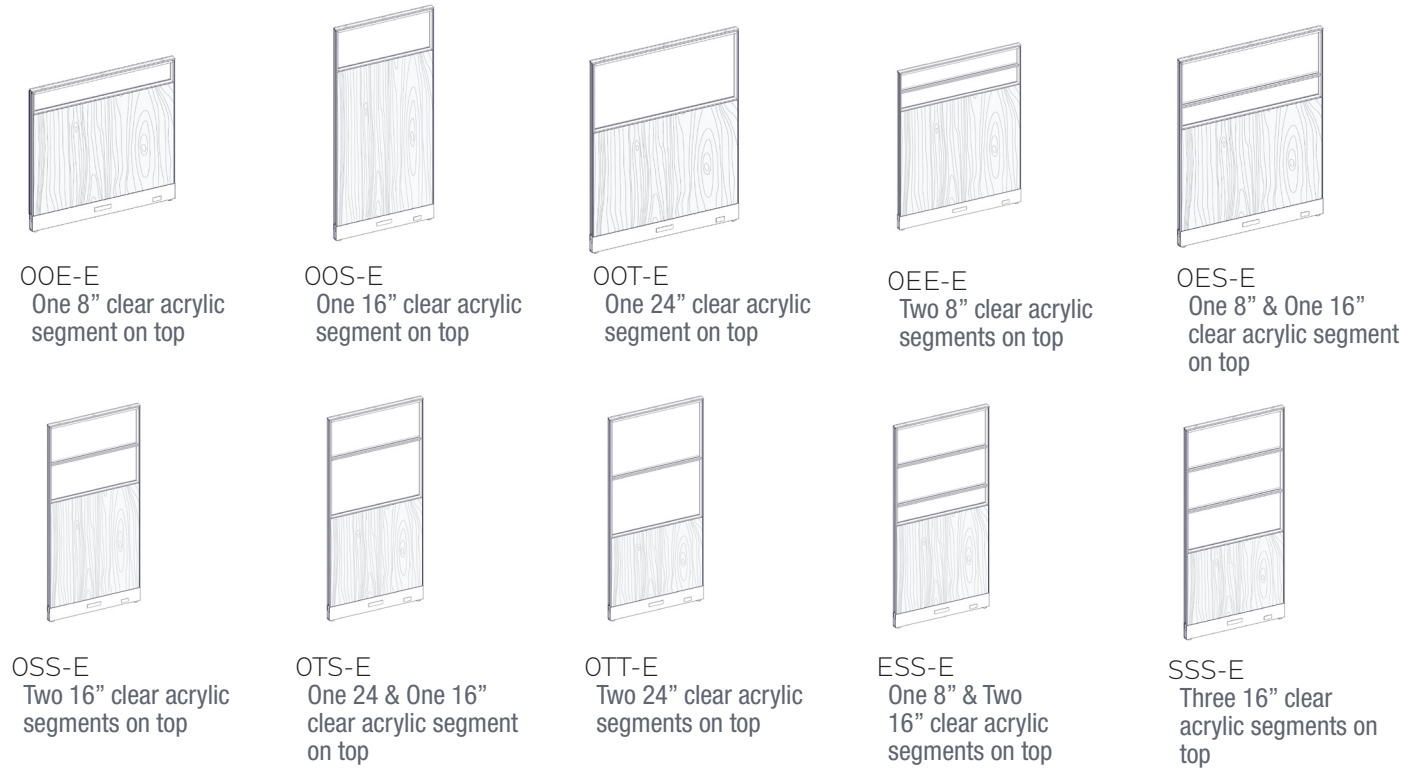

How to order and read your code

L - P P L C A - 42 24 - 00E - E

product standard P=glazed F=Fabric C=Clear A=Acrylic height width 0=No segment N=Non powered
 line line E=Elevated L=Laminate F=Frosted G=Glass E=8 inch segment E=Powered
 S=16 inch segment
 T=24 inch segment

What's Included:

One (1) 2" thick laminate panel with 1" incremented slotted channels,
 Two (2) raceway covers,
 One (1) top trim

How to Specify:

Refer to laminate cards for laminate selections
 Choose White, Black, Silver, Charcoal for Panel Frame colour

Options:

Height*: 34", 42", 50", 66", 82"

Width: 24", 30", 36", 42", 48"

Laminate

Metal Powder Coat Paint: White, Black, Silver, Charcoal

*82"H available up to 36"W

Notes:

Power capable panel with bracket for power module.
 Power module must be specified separately.
 Panels are non tackable. For tackable option see Panel Add-On section.

Code	Price	H	W	D
One 8" clear acrylic segment on top				
L-PPLCA-4224-00E-E	1226	42	24	2
L-PPLCA-4230-00E-E	1283	42	30	2
L-PPLCA-4236-00E-E	1338	42	36	2
L-PPLCA-4242-00E-E	1454	42	42	2
L-PPLCA-4248-00E-E	1467	42	48	2
L-PPLCA-5024-00E-E	1264	50	24	2
L-PPLCA-5030-00E-E	1319	50	30	2
L-PPLCA-5036-00E-E	1376	50	36	2
L-PPLCA-5042-00E-E	1515	50	42	2
L-PPLCA-5048-00E-E	1550	50	48	2
One 16" clear acrylic segment on top				
L-PPLCA-5024-00S-E	1276	50	24	2
L-PPLCA-5030-00S-E	1332	50	30	2
L-PPLCA-5036-00S-E	1394	50	36	2
L-PPLCA-5042-00S-E	1546	50	42	2
L-PPLCA-5048-00S-E	1579	50	48	2
L-PPLCA-6624-00S-E	1380	66	24	2
L-PPLCA-6630-00S-E	1461	66	30	2
L-PPLCA-6636-00S-E	1543	66	36	2
L-PPLCA-6642-00S-E	1747	66	42	2
L-PPLCA-6648-00S-E	1789	66	48	2
L-PPLCA-8224-00S-E	1692	82	24	2
L-PPLCA-8230-00S-E	1710	82	30	2
L-PPLCA-8236-00S-E	2275	82	36	2
One 24" clear acrylic segment on top				
L-PPLCA-6624-00T-E	1380	66	24	2
L-PPLCA-6630-00T-E	1480	66	30	2
L-PPLCA-6636-00T-E	1577	66	36	2
L-PPLCA-6642-00T-E	1747	66	42	2
L-PPLCA-6648-00T-E	1789	66	48	2

Code	Price	H	W	D
Two 8" clear acrylic segments on top				
L-PPLCA-6624-0EE-E	1480	66	24	2
L-PPLCA-6630-0EE-E	1496	66	30	2
L-PPLCA-6636-0EE-E	1802	66	36	2
L-PPLCA-6642-0EE-E	1844	66	42	2
L-PPLCA-6648-0EE-E	1905	66	48	2
One 8" & One 16" clear acrylic segment on top				
L-PPLCA-6624-0ES-E	1486	66	24	2
L-PPLCA-6630-0ES-E	1548	66	30	2
L-PPLCA-6636-0ES-E	1878	66	36	2
L-PPLCA-6642-0ES-E	1941	66	42	2
L-PPLCA-6648-0ES-E	2004	66	48	2
Two 16" clear acrylic segments on top				
L-PPLCA-8224-0SS-E	1543	82	24	2
L-PPLCA-8230-0SS-E	1620	82	30	2
L-PPLCA-8236-0SS-E	1988	82	36	2
One 24" & One 16" clear acrylic segment on top				
L-PPLCA-8224-0TS-E	1577	82	24	2
L-PPLCA-8230-0TS-E	1678	82	30	2
L-PPLCA-8236-0TS-E	1997	82	36	2
Two 24" clear acrylic segments on top				
L-PPLCA-8224-0TT-E	1510	82	24	2
L-PPLCA-8230-0TT-E	1599	82	30	2
L-PPLCA-8236-0TT-E	1873	82	36	2
One 8" & Two 16" clear acrylic segments on top				
L-PPLCA-8224-ESS-E	1645	82	24	2
L-PPLCA-8230-ESS-E	1822	82	30	2
L-PPLCA-8236-ESS-E	2153	82	36	2
Three 16" clear acrylic segments on top				
L-PPLCA-8224-SSS-E	1611	82	24	2
L-PPLCA-8230-SSS-E	1709	82	30	2
L-PPLCA-8236-SSS-E	2067	82	36	2

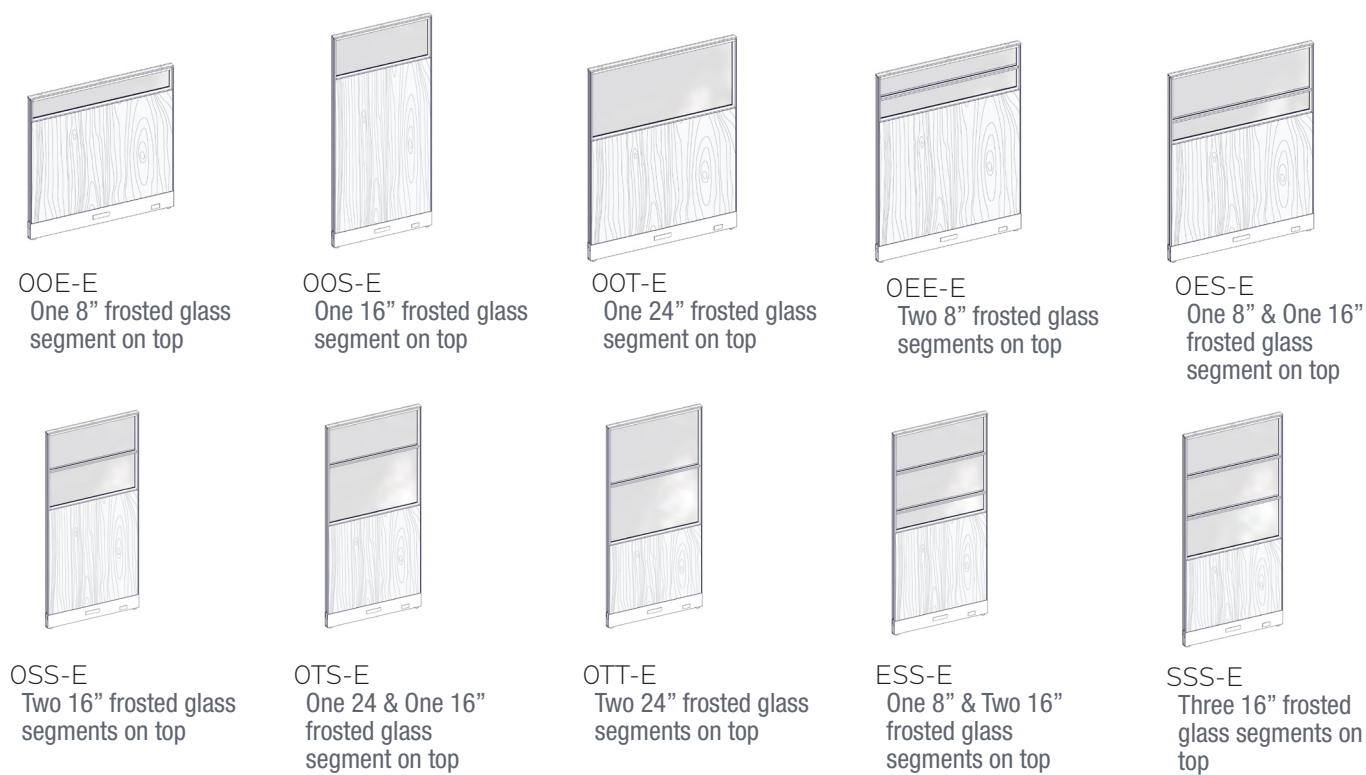

How to order and read your code

L - P P L F A - 42 24 - 00E - E

product standard P=glazed F=Fabric C=Clear A=Acrylic height width 0 = No segment N=Non powered
 line E = Elevated L=Laminate F=Frosted G=Glass E = 8 inch segment E=Powered
 S = 16 inch segment
 T = 24 inch segment

What's Included:

One (1) 2" thick laminate panel with 1" incremented slotted channels,
 Two (2) raceway covers,
 One (1) top trim

How to Specify:

Refer to laminate cards for laminate selections
 Choose White, Black, Silver, Charcoal for Panel Frame colour

Options:

Height*: 34", 42", 50", 66", 82"

Width: 24", 30", 36", 42", 48",

Laminate

Metal Powder Coat Paint: White, Black, Silver, Charcoal

*82"H available up to 36"W

Code	Price	H	W	D
One 8" frosted acrylic segment on top				
L-PPLFA-4224-00E-E	1332	42	24	2
L-PPLFA-4230-00E-E	1390	42	30	2
L-PPLFA-4236-00E-E	1444	42	36	2
L-PPLFA-4242-00E-E	1559	42	42	2
L-PPLFA-4248-00E-E	1574	42	48	2
L-PPLFA-5024-00E-E	1371	50	24	2
L-PPLFA-5030-00E-E	1427	50	30	2
L-PPLFA-5036-00E-E	1483	50	36	2
L-PPLFA-5042-00E-E	1623	50	42	2
L-PPLFA-5048-00E-E	1656	50	48	2
One 16" frosted acrylic segment on top				
L-PPLFA-5024-00S-E	1383	50	24	2
L-PPLFA-5030-00S-E	1440	50	30	2
L-PPLFA-5036-00S-E	1501	50	36	2
L-PPLFA-5042-00S-E	1650	50	42	2
L-PPLFA-5048-00S-E	1688	50	48	2
L-PPLFA-6624-00S-E	1487	66	24	2
L-PPLFA-6630-00S-E	1568	66	30	2
L-PPLFA-6636-00S-E	1649	66	36	2
L-PPLFA-6642-00S-E	1854	66	42	2
L-PPLFA-6648-00S-E	1897	66	48	2
L-PPLFA-8224-00S-E	1729	82	24	2
L-PPLFA-8230-00S-E	1762	82	30	2
L-PPLFA-8236-00S-E	2340	82	36	2
One 24" frosted acrylic segment on top				
L-PPLFA-6624-00T-E	1487	66	24	2
L-PPLFA-6630-00T-E	1585	66	30	2
L-PPLFA-6636-00T-E	1624	66	36	2
L-PPLFA-6642-00T-E	1854	66	42	2
L-PPLFA-6648-00T-E	1897	66	48	2

Code	Price	H	W	D
Two 8" frosted acrylic segments on top				
L-PPLFA-6624-0EE-E	1547	66	24	2
L-PPLFA-6630-0EE-E	1587	66	30	2
L-PPLFA-6636-0EE-E	1922	66	36	2
L-PPLFA-6642-0EE-E	1961	66	42	2
L-PPLFA-6648-0EE-E	2039	66	48	2
One 8" & One 16" frosted acrylic segment on top				
L-PPLFA-6624-0ES-E	1540	66	24	2
L-PPLFA-6630-0ES-E	1620	66	30	2
L-PPLFA-6636-0ES-E	1969	66	36	2
L-PPLFA-6642-0ES-E	2052	66	42	2
L-PPLFA-6648-0ES-E	2118	66	48	2
Two 16" frosted acrylic segments on top				
L-PPLFA-8224-0SS-E	1437	82	24	2
L-PPLFA-8230-0SS-E	1469	82	30	2
L-PPLFA-8236-0SS-E	1786	82	36	2
One 24" & One 16" frosted acrylic segment on top				
L-PPLFA-8224-0TS-E	1691	82	24	2
L-PPLFA-8230-0TS-E	1828	82	30	2
L-PPLFA-8236-0TS-E	2146	82	36	2
Two 24" frosted acrylic segments on top				
L-PPLFA-8224-0TT-E	1622	82	24	2
L-PPLFA-8230-0TT-E	1749	82	30	2
L-PPLFA-8236-0TT-E	2052	82	36	2
One 8" & Two 16" frosted acrylic segments on top				
L-PPLFA-8224-ESS-E	1757	82	24	2
L-PPLFA-8230-ESS-E	1974	82	30	2
L-PPLFA-8236-ESS-E	2303	82	36	2
Three 16" frosted acrylic segments on top				
L-PPLFA-8224-SSS-E	1723	82	24	2
L-PPLFA-8230-SSS-E	1860	82	30	2
L-PPLFA-8236-SSS-E	2292	82	36	2

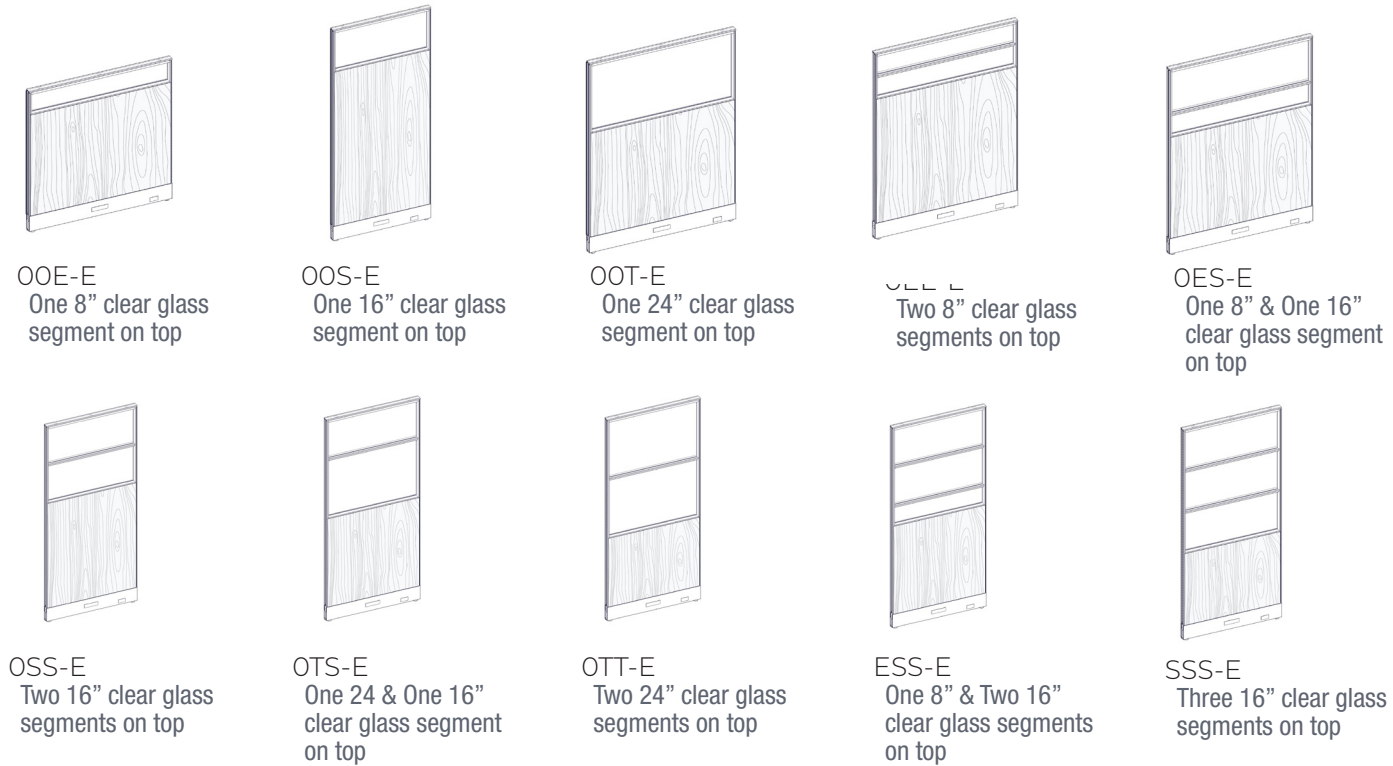

How to order and read your code

L - P P L C G - 42 24 - 00E - E

product standard P=glazed F=Fabric C=Clear A=Acrylic height width 0=No segment N=Non powered
 line line E=Elevated L=Laminate F=Frosted G=Glass E=8 inch segment E=Powered
 S=16 inch segment
 T=24 inch segment

What's Included:

One (1) 2" thick laminate panel with 1" incremented slotted channels,
 Two (2) raceway covers,
 One (1) top trim

How to Specify:

Refer to laminate cards for laminate selections
 Choose White, Black, Silver, Charcoal for Panel Frame colour

Options:

Height*: 34", 42", 50", 66", 82"
 Width: 24", 30", 36", 42", 48",
 Laminate
 Metal Powder Coat Paint: White, Black, Silver, Charcoal

*82"H available up to 36"W

Code	Price	H	W	D
One 8" clear glass segment on top				
L-PPLCG-4224-00E-E	1777	42	24	2
L-PPLCG-4230-00E-E	1395	42	30	2
L-PPLCG-4236-00E-E	1459	42	36	2
L-PPLCG-4242-00E-E	1532	42	42	2
L-PPLCG-4248-00E-E	1605	42	48	2
L-PPLCG-5024-00E-E	1370	50	24	2
L-PPLCG-5030-00E-E	1434	50	30	2
L-PPLCG-5036-00E-E	1500	50	36	2
L-PPLCG-5042-00E-E	1572	50	42	2
L-PPLCG-5048-00E-E	1644	50	48	2
One 16" clear glass segment on top				
L-PPLCG-5024-00S-E	1448	50	24	2
L-PPLCG-5030-00S-E	1513	50	30	2
L-PPLCG-5036-00S-E	1579	50	36	2
L-PPLCG-5042-00S-E	1650	50	42	2
L-PPLCG-5048-00S-E	1724	50	48	2
L-PPLCG-6624-00S-E	1573	66	24	2
L-PPLCG-6630-00S-E	1653	66	30	2
L-PPLCG-6636-00S-E	1732	66	36	2
L-PPLCG-6642-00S-E	1834	66	42	2
L-PPLCG-6648-00S-E	1910	66	48	2
L-PPLCG-8224-00S-E	1648	82	24	2
L-PPLCG-8230-00S-E	1694	82	30	2
L-PPLCG-8236-00S-E	2281	82	36	2
One 24" clear glass segment on top				
L-PPLCG-6624-00T-E	1617	66	24	2
L-PPLCG-6630-00T-E	1697	66	30	2
L-PPLCG-6636-00T-E	1779	66	36	2
L-PPLCG-6642-00T-E	1887	66	42	2
L-PPLCG-6648-00T-E	1981	66	48	2

Code	Price	H	W	D
Two 8" clear glass segments on top				
L-PPLCG-6624-0EE-E	1583	66	24	2
L-PPLCG-6630-0EE-E	1639	66	30	2
L-PPLCG-6636-0EE-E	1972	66	36	2
L-PPLCG-6642-0EE-E	2025	66	42	2
L-PPLCG-6648-0EE-E	2103	66	48	2
One 8" & One 16" clear glass segment on top				
L-PPLCG-6624-0ES-E	1583	66	24	2
L-PPLCG-6630-0ES-E	1658	66	30	2
L-PPLCG-6636-0ES-E	2010	66	36	2
L-PPLCG-6642-0ES-E	2080	66	42	2
L-PPLCG-6648-0ES-E	2174	66	48	2
Two 16" clear glass segments on top				
L-PPLCG-8224-0SS-E	1643	82	24	2
L-PPLCG-8230-0SS-E	1714	82	30	2
L-PPLCG-8236-0SS-E	2082	82	36	2
One 24" & One 16" clear glass segment on top				
L-PPLCG-8224-0TS-E	1674	82	24	2
L-PPLCG-8230-0TS-E	1773	82	30	2
L-PPLCG-8236-0TS-E	2150	82	36	2
Two 24" clear glass segments on top				
L-PPLCG-8224-0TT-E	1642	82	24	2
L-PPLCG-8230-0TT-E	1747	82	30	2
L-PPLCG-8236-0TT-E	2043	82	36	2
One 8" & Two 16" clear glass segments on top				
L-PPLCG-8224-ESS-E	1835	82	24	2
L-PPLCG-8230-ESS-E	2005	82	30	2
L-PPLCG-8236-ESS-E	2391	82	36	2
Three 16" clear glass segments on top				
L-PPLCG-8224-SSS-E	1811	82	24	2
L-PPLCG-8230-SSS-E	1908	82	30	2
L-PPLCG-8236-SSS-E	2230	82	36	2

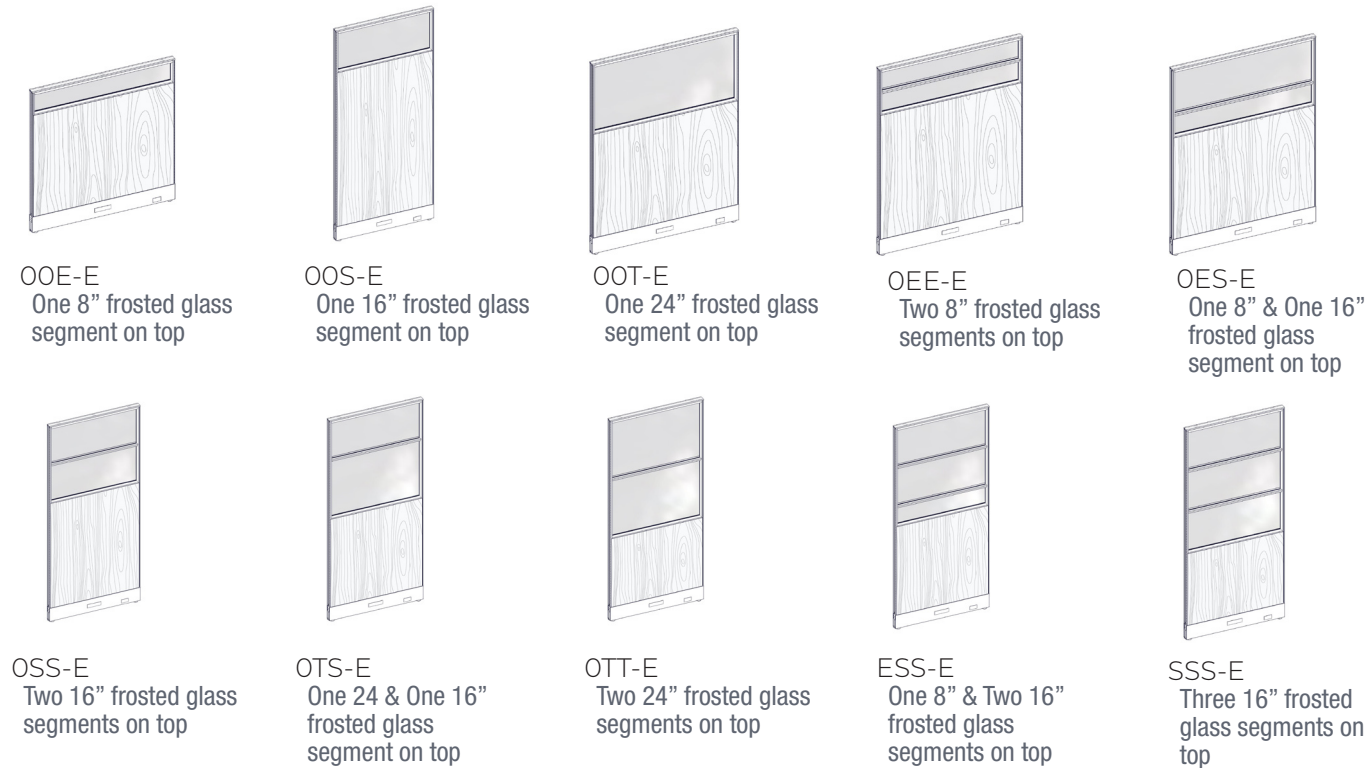

How to order and read your code

L - P P L F G - 42 24 - 00E - E

product standard P=glazed F=Fabric C=Clear A=Acrylic height width 0=No segment N=Non powered
 line line E=Elevated L=Laminate F=Frosted G=Glass E=8 inch segment E=Powered
 S=16 inch segment
 T=24 inch segment

What's Included:

One (1) 2" thick laminate panel with 1" incremented slotted channels,
 Two (2) raceway covers,
 One (1) top trim

How to Specify:

Refer to laminate cards for laminate selections
 Choose White, Black, Silver, Charcoal for Panel Frame colour

Options:

Height*: 34", 42", 50", 66", 82"

Width: 24", 30", 36", 42", 48",

Laminate

Metal Powder Coat Paint: White, Black, Silver, Charcoal

*82"H available up to 36"W

Code	Price	H	W	D
One 8" frosted glass segment on top				
L-PPLFG-4224-00E-E	1884	42	24	2
L-PPLFG-4230-00E-E	1502	42	30	2
L-PPLFG-4236-00E-E	1565	42	36	2
L-PPLFG-4242-00E-E	1639	42	42	2
L-PPLFG-4248-00E-E	1712	42	48	2
L-PPLFG-5024-00E-E	1476	50	24	2
L-PPLFG-5030-00E-E	1539	50	30	2
L-PPLFG-5036-00E-E	1605	50	36	2
L-PPLFG-5042-00E-E	1678	50	42	2
L-PPLFG-5048-00E-E	1750	50	48	2
One 16" frosted glass segment on top				
L-PPLFG-5024-00S-E	1557	50	24	2
L-PPLFG-5030-00S-E	1620	50	30	2
L-PPLFG-5036-00S-E	1688	50	36	2
L-PPLFG-5042-00S-E	1757	50	42	2
L-PPLFG-5048-00S-E	1832	50	48	2
L-PPLFG-6624-00S-E	1679	66	24	2
L-PPLFG-6630-00S-E	1759	66	30	2
L-PPLFG-6636-00S-E	1838	66	36	2
L-PPLFG-6642-00S-E	1941	66	42	2
L-PPLFG-6648-00S-E	2017	66	48	2
L-PPLFG-8224-00S-E	1739	82	24	2
L-PPLFG-8230-00S-E	1796	82	30	2
L-PPLFG-8236-00S-E	2401	82	36	2
One 24" frosted glass segment on top				
L-PPLFG-6624-00T-E	1723	66	24	2
L-PPLFG-6630-00T-E	1804	66	30	2
L-PPLFG-6636-00T-E	1885	66	36	2
L-PPLFG-6642-00T-E	1994	66	42	2
L-PPLFG-6648-00T-E	2087	66	48	2

Code	Price	H	W	D
Two 8" frosted glass segments on top				
L-PPLFG-6624-0EE-E	1765	66	24	2
L-PPLFG-6630-0EE-E	1820	66	30	2
L-PPLFG-6636-0EE-E	2153	66	36	2
L-PPLFG-6642-0EE-E	2205	66	42	2
L-PPLFG-6648-0EE-E	2284	66	48	2
One 8" & One 16" frosted glass segment on top				
L-PPLFG-6624-0ES-E	1765	66	24	2
L-PPLFG-6630-0ES-E	1852	66	30	2
L-PPLFG-6636-0ES-E	2224	66	36	2
L-PPLFG-6642-0ES-E	2312	66	42	2
L-PPLFG-6648-0ES-E	2425	66	48	2
Two 16" frosted glass segments on top				
L-PPLFG-8224-0SS-E	1824	82	24	2
L-PPLFG-8230-0SS-E	1915	82	30	2
L-PPLFG-8236-0SS-E	2323	82	36	2
One 24" & One 16" frosted glass segment on top				
L-PPLFG-8224-0TS-E	1885	82	24	2
L-PPLFG-8230-0TS-E	2026	82	30	2
L-PPLFG-8236-0TS-E	2452	82	36	2
Two 24" frosted glass segments on top				
L-PPLFG-8224-0TT-E	1884	82	24	2
L-PPLFG-8230-0TT-E	2048	82	30	2
L-PPLFG-8236-0TT-E	2407	82	36	2
One 8" & Two 16" frosted glass segments on top				
L-PPLFG-8224-ESS-E	2108	82	24	2
L-PPLFG-8230-ESS-E	2297	82	30	2
L-PPLFG-8236-ESS-E	2724	82	36	2
Three 16" frosted glass segments on top				
L-PPLFG-8224-SSS-E	2084	82	24	2
L-PPLFG-8230-SSS-E	2211	82	30	2
L-PPLFG-8236-SSS-E	2595	82	36	2

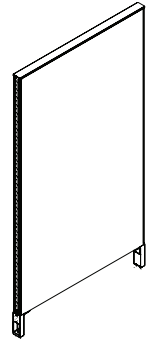

Elevated Non-Powered Fabric Panel

What's Included:

One (1) 2" thick fabric panel with 1" incremented slotted channels, One (1) top trim

How to Specify:

Refer to panel fabric cards for fabric selections

Choose White, Black, Silver, Charcoal for Panel Frame colour

Notes:

Non-power capable panel.

Can be used in run with power-capable panels and allows wires to pass through.

Panels are non tackable. For tackable option see Panel Add-On section.

Fabric Upcharge
Grade 2 - \$226 per panel,
Grade 3- \$278 per panel

Options:

Height*: 34", 42", 50", 66", 82"

Width: 24", 30", 36", 42", 48", 54", 60", 66", 72"

Fabric

Metal Powder Coat Paint: White, Black, Silver, Charcoal

*34" high - 50" high available up to 72" wide, 66" high available up to 60" wide, 82" high available up to 48" wide

Code	Price	H	W	D	Weight (lb.)	Volume (ft ³)
L-PEF0-3424	619	34	24	2	14.836364	0.94
L-PEF0-3430	654	34	30	2	18.545455	1.18
L-PEF0-3436	742	34	36	2	22.26	1.42
L-PEF0-3442	782	34	42	2	25.963636	1.65
L-PEF0-3448	810	34	48	2	29.672727	1.89
L-PEF0-3454	845	34	54	2	33.381818	2.13
L-PEF0-3460	883	34	60	2	37.090909	2.36
L-PEF0-4224	619	42	24	2	18.327273	1.17
L-PEF0-4230	654	42	30	2	22.909091	1.46
L-PEF0-4236	742	42	36	2	27.490909	1.75
L-PEF0-4242	782	42	42	2	32.072727	2.04
L-PEF0-4248	810	42	48	2	36.66	2.33
L-PEF0-4254	851	42	54	2	41.236364	2.63
L-PEF0-4260	883	42	60	2	45.818182	2.92
L-PEF0-5024	666	50	24	2	21.818182	1.39
L-PEF0-5030	703	50	30	2	27.272727	1.74
L-PEF0-5036	781	50	36	2	32.727273	2.08
L-PEF0-5042	831	50	42	2	38.181818	2.43
L-PEF0-5048	884	50	48	2	43.636364	2.78
L-PEF0-5054	936	50	54	2	49.090909	3.13
L-PEF0-5060	971	50	60	2	54.545455	3.47
L-PEF0-6624	703	66	24	2	28.8	1.83
L-PEF0-6630	762	66	30	2	36	2.29
L-PEF0-6636	816	66	36	2	43.2	2.75
L-PEF0-6642	872	66	42	2	50.4	3.21
L-PEF0-6648	925	66	48	2	57.6	3.67
L-PEF0-6654	983	66	54	2	64.8	4.13
L-PEF0-6660	1038	66	60	2	72	4.58
L-PEF0-8224	983	82	24	2		
L-PEF0-8230	1054	82	30	2		
L-PEF0-8236	1277	82	36	2		
L-PEF0-8242	1344	82	42	2		
L-PEF0-8248	1413	82	48	2		

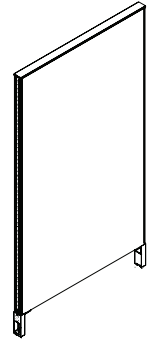

Elevated Monolithic
Non-powered
Laminate Panel

What's Included:

One (1) 2" thick laminate panel with
1" incremented slotted channels,
One (1) top trim

How to Specify:

Refer to laminate cards for laminate selections
Choose White, Black, Silver, Charcoal for Panel
Frame colour

Notes:

Non-power capable panel.
Can be used in run with power-capable
panels and allows wires to pass through.
Panels are non tackable. For tackable
option see Panel Add-On section.

Options:

Height*: 34", 42", 50", 66", 82"

Width: 24", 30", 36", 42", 48",

Laminate

Metal Powder Coat Paint: White, Black, Silver, Charcoal

*82"H available up to 36"W

Code	Price	H	W	D	Weight (lb.)	Volume (ft ³)
L-PELO-3424	677	34	24	2	14.836364	0.94
L-PELO-3430	734	34	30	2	18.545455	1.18
L-PELO-3436	791	34	36	2	22.26	1.42
L-PELO-3442	856	34	42	2	25.963636	1.65
L-PELO-3448	921	34	48	2	29.672727	1.89
L-PELO-4224	724	42	24	2	18.327273	1.17
L-PELO-4230	782	42	30	2	22.909091	1.46
L-PELO-4236	836	42	36	2	27.490909	1.75
L-PELO-4242	923	42	42	2	32.072727	2.04
L-PELO-4248	966	42	48	2	36.66	2.33
L-PELO-5024	795	50	24	2	21.818182	1.39
L-PELO-5030	860	50	30	2	27.272727	1.74
L-PELO-5036	924	50	36	2	32.727273	2.08
L-PELO-5042	1056	50	42	2	38.181818	2.43
L-PELO-5048	1086	50	48	2	43.636364	2.78
L-PELO-6624	890	66	24	2	28.8	1.83
L-PELO-6630	971	66	30	2	36	2.29
L-PELO-6636	1053	66	36	2	43.2	2.75
L-PELO-6642	1210	66	42	2	50.4	3.21
L-PELO-6648	1246	66	48	2	57.6	3.67
L-PELO-8224	1089	82	24	2		
L-PELO-8230	1096	82	30	2		
L-PELO-8236	1396	82	36	2		

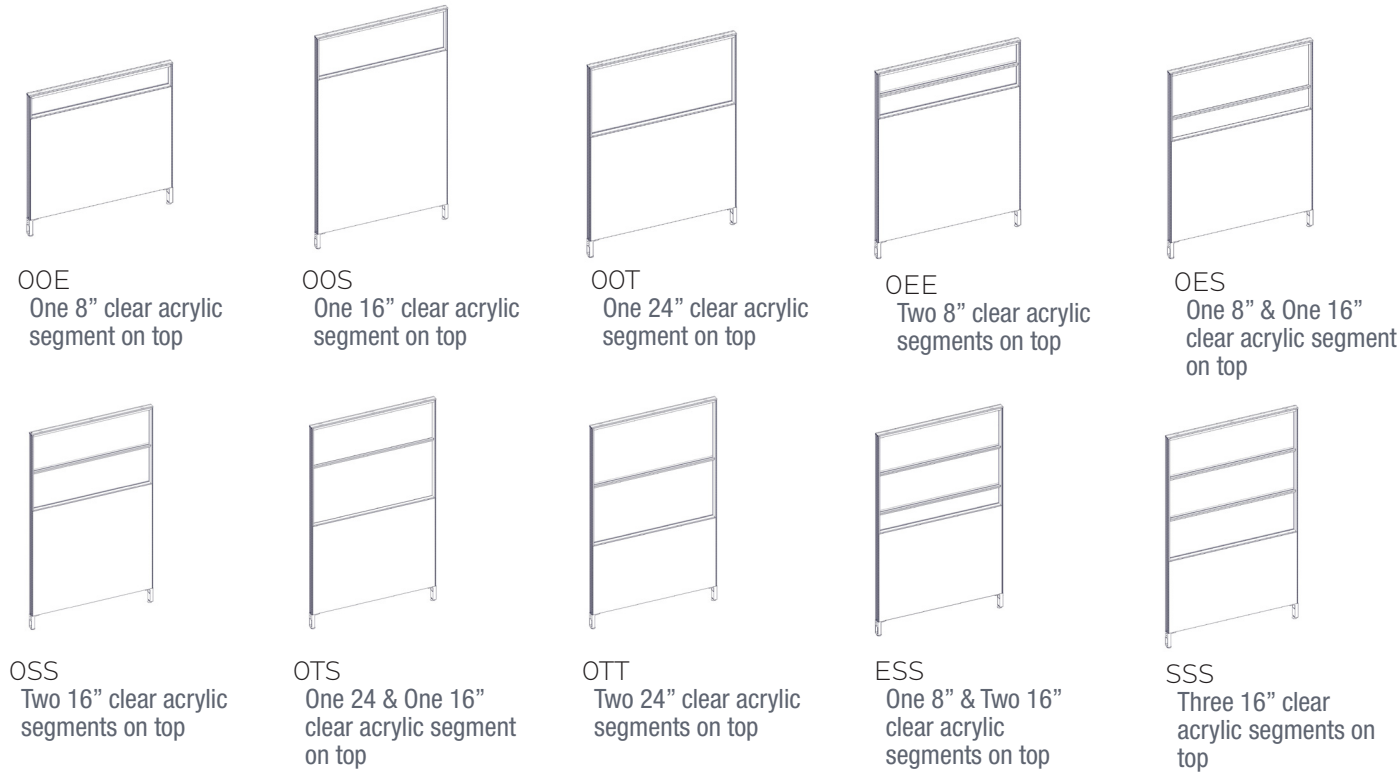

How to order and read your code

L - P E F C A - 42 24 - 0 0 E

product standard line P=glazed E=Elevated F=Fabric L=Laminate C=Clear F=Frosted A=Acrylic height G=Glass width 0 = No segment E = 8 inch segment S = 16 inch segment T = 24 inch segment

What's Included:

One (1) 2" thick fabric panel with glazed glass top and laminate bottom, also with 1" incremented slotted channels, One (1) top trim

How to Specify:

Refer to panel fabric cards for fabric selections
Choose White, Black, Silver, Charcoal for Panel Frame colour

Options:

Height*	34", 42", 50", 66", 82"
Width:	24", 30", 36", 42", 48", 54", 60", 66", 72"
Fabric	
Glass/Acrylic	
Metal Powder Coat Paint:	White, Black, Silver, Charcoal

*34" high - 50" high available up to 72" wide, 66" high available up to 60" wide, 82" high available up to 48" wide

Code	Price	H	W	D
One 8" clear acrylic segment on top				
L-PEFCA-4224-00E	1117	42	24	2
L-PEFCA-4230-00E	1188	42	30	2
L-PEFCA-4236-00E	1243	42	36	2
L-PEFCA-4242-00E	1292	42	42	2
L-PEFCA-4248-00E	1342	42	48	2
L-PEFCA-4254-00E	1429	42	54	2
L-PEFCA-4260-00E	1460	42	60	2
L-PEFCA-5024-00E	1117	50	24	2
L-PEFCA-5030-00E	1188	50	30	2
L-PEFCA-5036-00E	1243	50	36	2
L-PEFCA-5042-00E	1292	50	42	2
L-PEFCA-5048-00E	1342	50	48	2
L-PEFCA-5054-00E	1429	50	54	2
L-PEFCA-5060-00E	1460	50	60	2
One 16" clear acrylic segment on top				
L-PEFCA-5024-00S	1117	50	24	2
L-PEFCA-5030-00S	1188	50	30	2
L-PEFCA-5036-00S	1243	50	36	2
L-PEFCA-5042-00S	1292	50	42	2
L-PEFCA-5048-00S	1342	50	48	2
L-PEFCA-5054-00S	1429	50	54	2
L-PEFCA-5060-00S	1460	50	60	2
L-PEFCA-6624-00S	1233	66	24	2
L-PEFCA-6630-00S	1327	66	30	2
L-PEFCA-6636-00S	1408	66	36	2
L-PEFCA-6642-00S	1494	66	42	2
L-PEFCA-6648-00S	1561	66	48	2
L-PEFCA-6654-00S	1694	66	54	2
L-PEFCA-6660-00S	1728	66	60	2
L-PEFCA-8224-00S	1599	82	24	2
L-PEFCA-8230-00S	1844	82	30	2
L-PEFCA-8236-00S	1929	82	36	2
L-PEFCA-8242-00S	1967	82	42	2
L-PEFCA-8248-00S	2046	82	48	2
One 24" clear acrylic segment on top				
L-PEFCA-6624-00T	1233	66	24	2
L-PEFCA-6630-00T	1327	66	30	2
L-PEFCA-6636-00T	1408	66	36	2
L-PEFCA-6642-00T	1494	66	42	2
L-PEFCA-6648-00T	1561	66	48	2
L-PEFCA-6654-00T	1694	66	54	2
L-PEFCA-6660-00T	1728	66	60	2

Code	Price	H	W	D
Two 8" clear acrylic segments on top				
L-PEFCA-6624-0EE	1577	66	24	2
L-PEFCA-6630-0EE	1777	66	30	2
L-PEFCA-6636-0EE	1843	66	36	2
L-PEFCA-6642-0EE	1897	66	42	2
L-PEFCA-6648-0EE	1967	66	48	2
L-PEFCA-6654-0EE	2084	66	54	2
L-PEFCA-6660-0EE	2131	66	60	2
One 8" & One 16" clear acrylic segment on top				
L-PEFCA-6624-0ES	1540	66	24	2
L-PEFCA-6630-0ES	1732	66	30	2
L-PEFCA-6636-0ES	1811	66	36	2
L-PEFCA-6642-0ES	1889	66	42	2
L-PEFCA-6648-0ES	1972	66	48	2
L-PEFCA-6654-0ES	2059	66	54	2
L-PEFCA-6660-0ES	2094	66	60	2
Two 16" clear acrylic segments on top				
L-PEFCA-8224-0SS	1643	82	24	2
L-PEFCA-8230-0SS	1902	82	30	2
L-PEFCA-8236-0SS	2028	82	36	2
L-PEFCA-8242-0SS	2075	82	42	2
L-PEFCA-8248-0SS	2150	82	48	2
One 24" & One 16" clear acrylic segment on top				
L-PEFCA-8224-0TS	1633	82	24	2
L-PEFCA-8230-0TS	1865	82	30	2
L-PEFCA-8236-0TS	1929	82	36	2
L-PEFCA-8242-0TS	1978	82	42	2
L-PEFCA-8248-0TS	2174	82	48	2
Two 24" clear acrylic segments on top				
L-PEFCA-8224-0TT	1626	82	24	2
L-PEFCA-8230-0TT	1836	82	30	2
L-PEFCA-8236-0TT	1927	82	36	2
L-PEFCA-8242-0TT	2041	82	42	2
L-PEFCA-8248-0TT	2115	82	48	2
One 8" & Two 16" clear acrylic segments on top				
L-PEFCA-8224-ESS	1701	82	24	2
L-PEFCA-8230-ESS	2011	82	30	2
L-PEFCA-8236-ESS	2085	82	36	2
L-PEFCA-8242-ESS	2080	82	42	2
L-PEFCA-8248-ESS	2271	82	48	2
Three 16" clear acrylic segments on top				
L-PEFCA-8224-SSS	1729	82	24	2
L-PEFCA-8230-SSS	1948	82	30	2
L-PEFCA-8236-SSS	2120	82	36	2
L-PEFCA-8242-SSS	2180	82	42	2
L-PEFCA-8248-SSS	2262	82	48	2

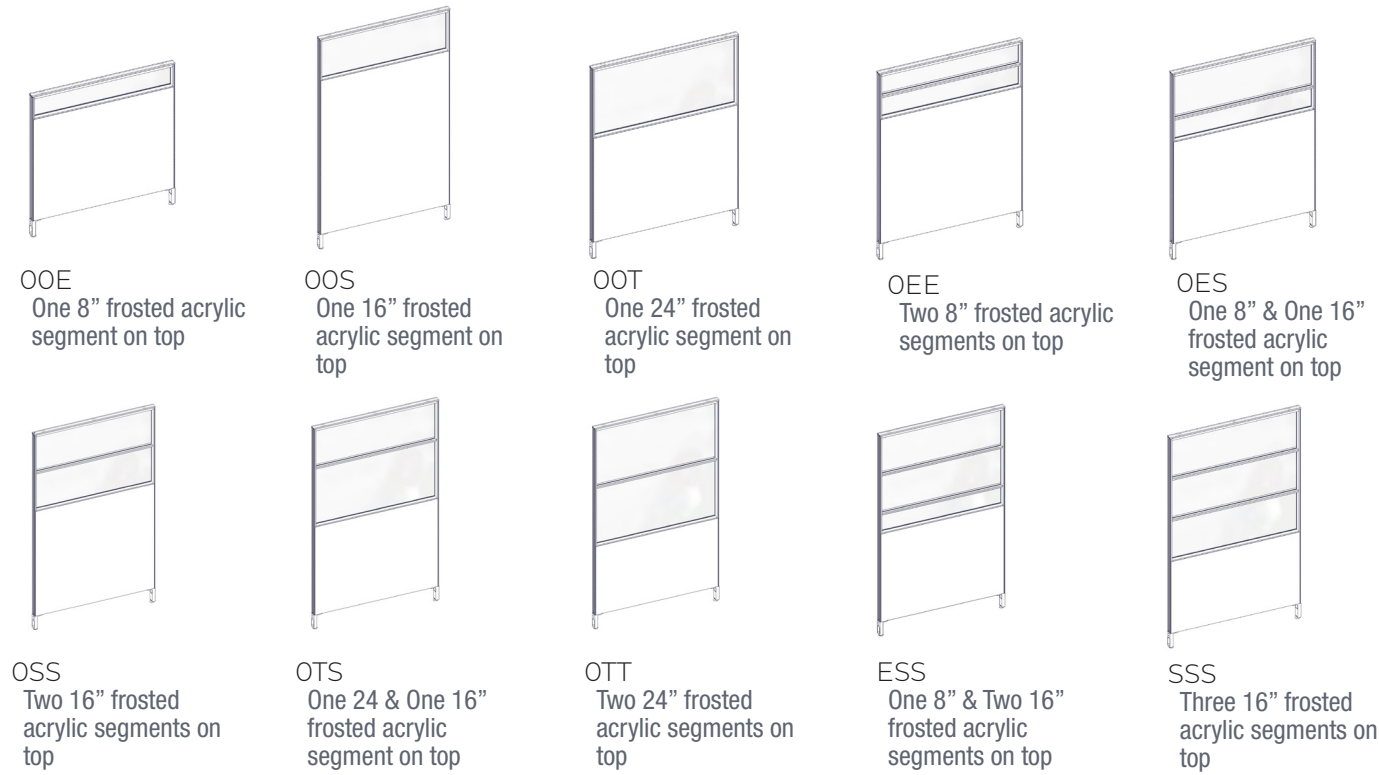

How to order and read your code

L - P E F F A - 42 24 - 0 0 E

product standard line P=glazed E=Elevated F=Fabric L=Laminate C=Clear F=Frosted A=Acrylic height G=Glass width 0 = No segment E = 8 inch segment S = 16 inch segment T = 24 inch segment

What's Included:

One (1) 2" thick fabric panel with glazed glass top and laminate bottom, also with 1" incremented slotted channels, One (1) top trim

How to Specify:

Refer to panel fabric cards for fabric selections
Choose White, Black, Silver, Charcoal for Panel Frame colour

Options:

Height*	34", 42", 50", 66", 82"
Width:	24", 30", 36", 42", 48", 54", 60", 66" 72"
Fabric	
Glass/Acrylic	
Metal Powder Coat Paint:	White, Black, Silver, Charcoal

*34" high - 50" high available up to 72" wide, 66" high available up to 60" wide, 82" high available up to 48" wide

Code	Price	H	W	D
One 8" frosted acrylic segment on top				
L-PEFFA-4224-00E	1224	42	24	2
L-PEFFA-4230-00E	1297	42	30	2
L-PEFFA-4236-00E	1350	42	36	2
L-PEFFA-4242-00E	1398	42	42	2
L-PEFFA-4248-00E	1448	42	48	2
L-PEFFA-4254-00E	1535	42	54	2
L-PEFFA-4260-00E	1566	42	60	2
L-PEFFA-5024-00E	1224	50	24	2
L-PEFFA-5030-00E	1297	50	30	2
L-PEFFA-5036-00E	1350	50	36	2
L-PEFFA-5042-00E	1398	50	42	2
L-PEFFA-5048-00E	1448	50	48	2
L-PEFFA-5054-00E	1535	50	54	2
L-PEFFA-5060-00E	1566	50	60	2
One 16" frosted acrylic segment on top				
L-PEFFA-5024-00S	1224	50	24	2
L-PEFFA-5030-00S	1297	50	30	2
L-PEFFA-5036-00S	1350	50	36	2
L-PEFFA-5042-00S	1398	50	42	2
L-PEFFA-5048-00S	1448	50	48	2
L-PEFFA-5054-00S	1535	50	54	2
L-PEFFA-5060-00S	1566	50	60	2
One 24" frosted acrylic segment on top				
L-PEFFA-6624-00S	1340	66	24	2
L-PEFFA-6630-00S	1434	66	30	2
L-PEFFA-6636-00S	1514	66	36	2
L-PEFFA-6642-00S	1601	66	42	2
L-PEFFA-6648-00S	1667	66	48	2
L-PEFFA-6654-00S	1801	66	54	2
L-PEFFA-6660-00S	1835	66	60	2
One 8" & Two 16" frosted acrylic segments on top				
L-PEFFA-8224-00S	1638	82	24	2
L-PEFFA-8230-00S	1894	82	30	2
L-PEFFA-8236-00S	1994	82	36	2
L-PEFFA-8242-00S	2041	82	42	2
L-PEFFA-8248-00S	2121	82	48	2
One 24" frosted acrylic segment on top				
L-PEFFA-6624-00T	1340	66	24	2
L-PEFFA-6630-00T	1434	66	30	2
L-PEFFA-6636-00T	1514	66	36	2
L-PEFFA-6642-00T	1601	66	42	2
L-PEFFA-6648-00T	1667	66	48	2
L-PEFFA-6654-00T	1801	66	54	2
L-PEFFA-6660-00T	1835	66	60	2

Code	Price	H	W	D
Two 8" frosted acrylic segments on top				
L-PEFFA-6624-0EE	1644	66	24	2
L-PEFFA-6630-0EE	1866	66	30	2
L-PEFFA-6636-0EE	1963	66	36	2
L-PEFFA-6642-0EE	2010	66	42	2
L-PEFFA-6648-0EE	2099	66	48	2
L-PEFFA-6654-0EE	2179	66	54	2
L-PEFFA-6660-0EE	2226	66	60	2
One 8" & One 16" frosted acrylic segment on top				
L-PEFFA-6624-0ES	1598	66	24	2
L-PEFFA-6630-0ES	1809	66	30	2
L-PEFFA-6636-0ES	1902	66	36	2
L-PEFFA-6642-0ES	2004	66	42	2
L-PEFFA-6648-0ES	2084	66	48	2
L-PEFFA-6654-0ES	2185	66	54	2
L-PEFFA-6660-0ES	2239	66	60	2
Two 16" frosted acrylic segments on top				
L-PEFFA-8224-0SS	1536	82	24	2
L-PEFFA-8230-0SS	1749	82	30	2
L-PEFFA-8236-0SS	1824	82	36	2
L-PEFFA-8242-0SS	1882	82	48	2
L-PEFFA-8248-0SS	1944	82	48	2
One 24" & One 16" frosted acrylic segment on top				
L-PEFFA-8224-0TS	1745	82	24	2
L-PEFFA-8230-0TS	2015	82	30	2
L-PEFFA-8236-0TS	2081	82	36	2
L-PEFFA-8242-0TS	2166	82	42	2
L-PEFFA-8248-0TS	2399	82	48	2
Two 24" frosted acrylic segments on top				
L-PEFFA-8224-0TT	1743	82	24	2
L-PEFFA-8230-0TT	1988	82	30	2
L-PEFFA-8236-0TT	2106	82	36	2
L-PEFFA-8242-0TT	2266	82	42	2
L-PEFFA-8248-0TT	2340	82	48	2
One 8" & Two 16" frosted acrylic segments on top				
L-PEFFA-8224-ESS	1813	82	24	2
L-PEFFA-8230-ESS	2159	82	30	2
L-PEFFA-8236-ESS	2236	82	36	2
L-PEFFA-8242-ESS	2297	82	42	2
L-PEFFA-8248-ESS	2419	82	48	2
Three 16" frosted acrylic segments on top				
L-PEFFA-8224-SSS	1843	82	24	2
L-PEFFA-8230-SSS	2097	82	30	2
L-PEFFA-8236-SSS	2344	82	36	2
L-PEFFA-8242-SSS	2405	82	36	2
L-PEFFA-8248-SSS	2488	82	48	2

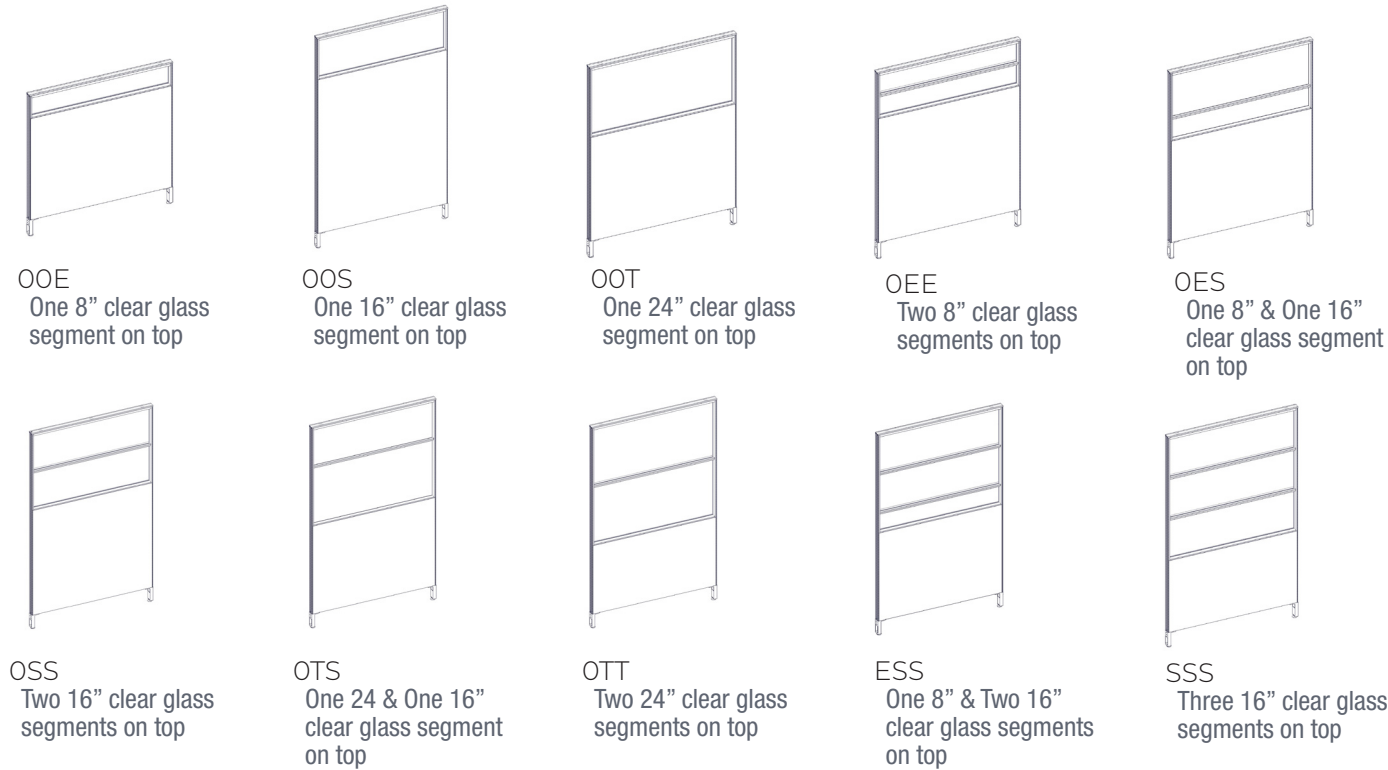

How to order and read your code

L - P E F C G - 42 24 - 0 0 E

product standard line P=glazed E=Elevated F=Fabric L=Laminate C=Clear F=Frosted A=Acrylic height width 0=No segment E=8 inch segment S=16 inch segment T=24 inch segment

What's Included:

One (1) 2" thick fabric panel with glazed glass top and laminate bottom, also with 1" incremented slotted channels, One (1) top trim

How to Specify:

Refer to panel fabric cards for fabric selections
Choose White, Black, Silver, Charcoal for Panel Frame colour

Options:

Height*	34", 42", 50", 66", 82"
Width:	24", 30", 36", 42", 48", 54", 60", 66", 72"
Fabric	
Glass/Acrylic	
Metal Powder Coat Paint:	White, Black, Silver, Charcoal

*34" high - 50" high available up to 72" wide, 66" high available up to 60" wide, 82" high available up to 48" wide

Code	Price	H	W	D
One 8" clear glass segment on top				
L-PEFCG-4224-00E	1316	42	24	2
L-PEFCG-4230-00E	1397	42	30	2
L-PEFCG-4236-00E	1481	42	36	2
L-PEFCG-4242-00E	1562	42	42	2
L-PEFCG-4248-00E	1645	42	48	2
L-PEFCG-4254-00E	1727	42	54	2
L-PEFCG-4260-00E	1809	42	60	2
L-PEFCG-5024-00E	1316	50	24	2
L-PEFCG-5030-00E	1397	50	30	2
L-PEFCG-5036-00E	1481	50	36	2
L-PEFCG-5042-00E	1562	50	42	2
L-PEFCG-5048-00E	1645	50	48	2
L-PEFCG-5054-00E	1727	50	54	2
L-PEFCG-5060-00E	1809	50	60	2
One 16" clear glass segment on top				
L-PEFCG-5024-00S	1316	50	24	2
L-PEFCG-5030-00S	1397	50	30	2
L-PEFCG-5036-00S	1481	50	36	2
L-PEFCG-5042-00S	1562	50	42	2
L-PEFCG-5048-00S	1645	50	48	2
L-PEFCG-5054-00S	1727	50	54	2
L-PEFCG-5060-00S	1809	50	60	2
L-PEFCG-6624-00S	1370	66	24	2
L-PEFCG-6630-00S	1471	66	30	2
L-PEFCG-6636-00S	1577	66	36	2
L-PEFCG-6642-00S	1678	66	42	2
L-PEFCG-6648-00S	1784	66	48	2
L-PEFCG-6654-00S	1885	66	54	2
L-PEFCG-6660-00S	1988	66	60	2
L-PEFCG-8224-00S	1553	82	24	2
L-PEFCG-8230-00S	1827	82	30	2
L-PEFCG-8236-00S	1937	82	36	2
L-PEFCG-8242-00S	1990	82	42	2
L-PEFCG-8248-00S	2093	82	48	2
One 24" clear glass segment on top				
L-PEFCG-6624-00T	1370	66	24	2
L-PEFCG-6630-00T	1471	66	30	2
L-PEFCG-6636-00T	1577	66	36	2
L-PEFCG-6642-00T	1678	66	42	2
L-PEFCG-6648-00T	1784	66	48	2
L-PEFCG-6654-00T	1885	66	54	2
L-PEFCG-6660-00T	1988	66	60	2

Code	Price	H	W	D
Two 8" clear glass segments on top				
L-PEFCG-6624-0EE	1682	66	24	2
L-PEFCG-6630-0EE	1918	66	30	2
L-PEFCG-6636-0EE	2011	66	36	2
L-PEFCG-6642-0EE	2074	66	42	2
L-PEFCG-6648-0EE	2164	66	48	2
L-PEFCG-6654-0EE	2283	66	54	2
L-PEFCG-6660-0EE	2341	66	60	2
One 8" & One 16" clear glass segment on top				
L-PEFCG-6624-0ES	1639	66	24	2
L-PEFCG-6630-0ES	1845	66	30	2
L-PEFCG-6636-0ES	1942	66	36	2
L-PEFCG-6642-0ES	2028	66	42	2
L-PEFCG-6648-0ES	2141	66	48	2
L-PEFCG-6654-0ES	2270	66	54	2
L-PEFCG-6660-0ES	2335	66	60	2
Two 16" clear glass segments on top				
L-PEFCG-8224-0SS	1742	82	24	2
L-PEFCG-8230-0SS	1993	82	30	2
L-PEFCG-8236-0SS	2120	82	36	2
L-PEFCG-8242-0SS	2216	82	42	2
L-PEFCG-8248-0SS	2340	82	48	2
One 24" & One 16" clear glass segment on top				
L-PEFCG-8224-0TS	1728	82	24	2
L-PEFCG-8230-0TS	1963	82	30	2
L-PEFCG-8236-0TS	2083	82	36	2
L-PEFCG-8242-0TS	2191	82	42	2
L-PEFCG-8248-0TS	2332	82	48	2
Two 24" clear glass segments on top				
L-PEFCG-8224-0TT	1760	82	24	2
L-PEFCG-8230-0TT	1984	82	30	2
L-PEFCG-8236-0TT	2096	82	36	2
L-PEFCG-8242-0TT	2212	82	42	2
L-PEFCG-8248-0TT	2348	82	48	2
One 8" & Two 16" clear glass segments on top				
L-PEFCG-8224-ESS	1890	82	24	2
L-PEFCG-8230-ESS	2190	82	30	2
L-PEFCG-8236-ESS	2323	82	36	2
L-PEFCG-8242-ESS	2336	82	42	2
L-PEFCG-8248-ESS	2512	82	48	2
Three 16" clear glass segments on top				
L-PEFCG-8224-SSS	1930	82	24	2
L-PEFCG-8230-SSS	2146	82	30	2
L-PEFCG-8236-SSS	2284	82	36	2
L-PEFCG-8242-SSS	2417	82	42	2
L-PEFCG-8248-SSS	2574	82	48	2

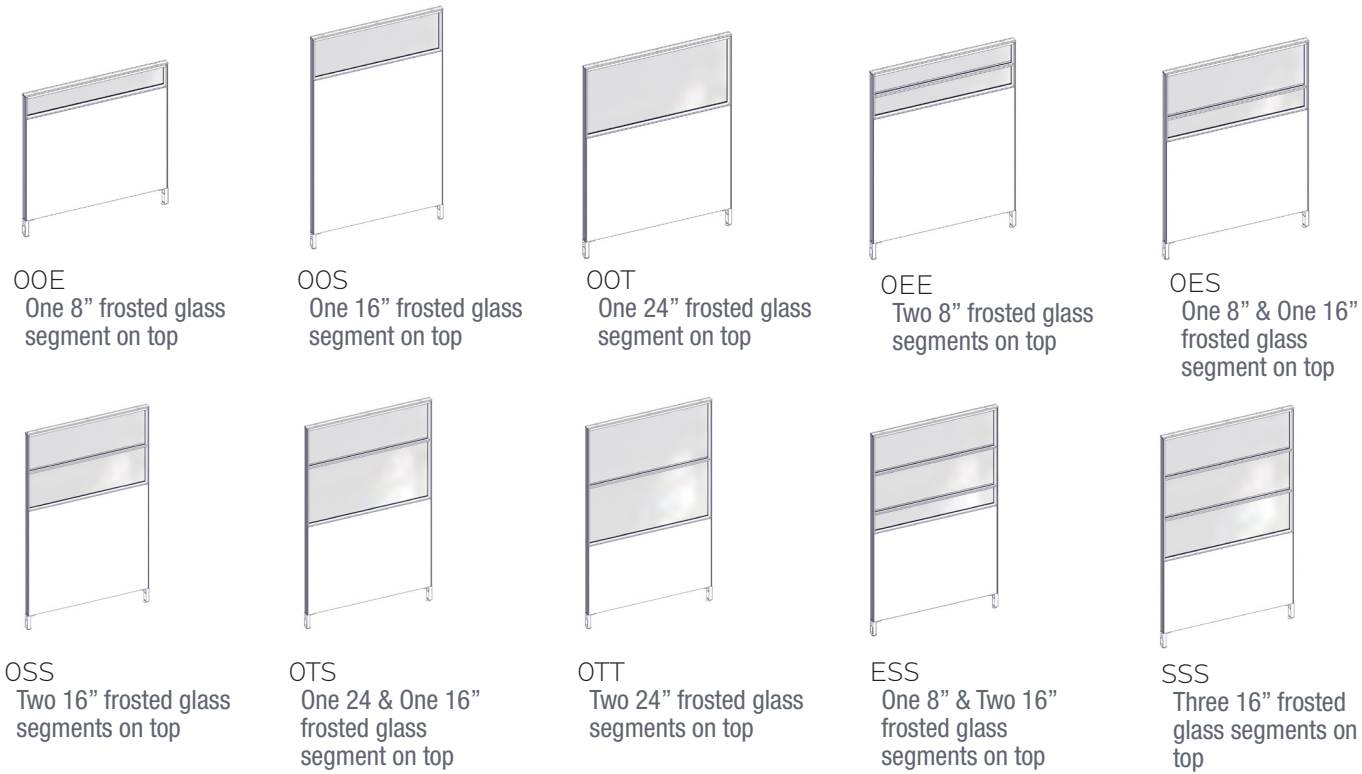

How to order and read your code

L - P E F F G - 42 24 - 00 E

product standard line P=glazed E=Elevated F=Fabric L=Laminate C=Clear F=Frosted A=Acrylic height G=Glass width O=No segment E=8 inch segment S=16 inch segment T=24 inch segment

What's Included:

One (1) 2" thick fabric panel with glazed glass top and laminate bottom, also with 1" incremented slotted channels, One (1) top trim

How to Specify:

Refer to panel fabric cards for fabric selections
Choose White, Black, Silver, Charcoal for Panel Frame colour

Options:

Height*	34", 42", 50", 66", 82"
Width:	24", 30", 36", 42", 48", 54", 60", 66", 72"
Fabric	
Glass/Acrylic	
Metal Powder Coat Paint:	White, Black, Silver, Charcoal

*34" high - 50" high available up to 72" wide, 66" high available up to 60" wide, 82" high available up to 48" wide

Code	Price	H	W	D
One 8" frosted glass segment on top				
L-PEFFG-4224-00E	1422	42	24	2
L-PEFFG-4230-00E	1505	42	30	2
L-PEFFG-4236-00E	1587	42	36	2
L-PEFFG-4242-00E	1669	42	42	2
L-PEFFG-4248-00E	1752	42	48	2
L-PEFFG-4254-00E	1834	42	54	2
L-PEFFG-4260-00E	1915	42	60	2
L-PEFFG-5024-00E	1422	50	24	2
L-PEFFG-5030-00E	1505	50	30	2
L-PEFFG-5036-00E	1587	50	36	2
L-PEFFG-5042-00E	1669	50	42	2
L-PEFFG-5048-00E	1752	50	48	2
L-PEFFG-5054-00E	1834	50	54	2
L-PEFFG-5060-00E	1915	50	60	2
One 16" frosted glass segment on top				
L-PEFFG-5024-00S	1422	50	24	2
L-PEFFG-5030-00S	1505	50	30	2
L-PEFFG-5036-00S	1587	50	36	2
L-PEFFG-5042-00S	1669	50	42	2
L-PEFFG-5048-00S	1752	50	48	2
L-PEFFG-5054-00S	1834	50	54	2
L-PEFFG-5060-00S	1915	50	60	2
L-PEFFG-6624-00S	1476	66	24	2
L-PEFFG-6630-00S	1578	66	30	2
L-PEFFG-6636-00S	1683	66	36	2
L-PEFFG-6642-00S	1785	66	42	2
L-PEFFG-6648-00S	1889	66	48	2
L-PEFFG-6654-00S	1992	66	54	2
L-PEFFG-6660-00S	2094	66	60	2
L-PEFFG-8224-00S	1752	82	24	2
L-PEFFG-8230-00S	2035	82	30	2
L-PEFFG-8236-00S	2164	82	36	2
L-PEFFG-8242-00S	2237	82	42	2
L-PEFFG-8248-00S	2361	82	48	2
One 24" frosted glass segment on top				
L-PEFFG-6624-00T	1476	66	24	2
L-PEFFG-6630-00T	1578	66	30	2
L-PEFFG-6636-00T	1683	66	36	2
L-PEFFG-6642-00T	1785	66	42	2
L-PEFFG-6648-00T	1889	66	48	2
L-PEFFG-6654-00T	1992	66	54	2
L-PEFFG-6660-00T	2094	66	60	2

Code	Price	H	W	D
Two 8" frosted glass segments on top				
L-PEFFG-6624-0EE	1863	66	24	2
L-PEFFG-6630-0EE	2099	66	30	2
L-PEFFG-6636-0EE	2191	66	36	2
L-PEFFG-6642-0EE	2257	66	42	2
L-PEFFG-6648-0EE	2345	66	48	2
L-PEFFG-6654-0EE	2465	66	54	2
L-PEFFG-6660-0EE	2542	66	60	2
One 8" & One 16" frosted glass segment on top				
L-PEFFG-6624-0ES	1820	66	24	2
L-PEFFG-6630-0ES	2037	66	30	2
L-PEFFG-6636-0ES	2153	66	36	2
L-PEFFG-6642-0ES	2260	66	42	2
L-PEFFG-6648-0ES	2394	66	48	2
L-PEFFG-6654-0ES	2542	66	54	2
L-PEFFG-6660-0ES	2639	66	60	2
Two 16" frosted glass segments on top				
L-PEFFG-8224-0SS	1923	82	24	2
L-PEFFG-8230-0SS	2195	82	30	2
L-PEFFG-8236-0SS	2361	82	36	2
L-PEFFG-8242-0SS	2501	82	42	2
L-PEFFG-8248-0SS	2664	82	48	2
One 24" & One 16" frosted glass segment on top				
L-PEFFG-8224-0TS	1941	82	24	2
L-PEFFG-8230-0TS	2213	82	30	2
L-PEFFG-8236-0TS	2387	82	36	2
L-PEFFG-8242-0TS	2547	82	42	2
L-PEFFG-8248-0TS	2735	82	48	2
Two 24" frosted glass segments on top				
L-PEFFG-8224-0TT	2003	82	24	2
L-PEFFG-8230-0TT	2289	82	30	2
L-PEFFG-8236-0TT	2462	82	36	2
L-PEFFG-8242-0TT	2635	82	42	2
L-PEFFG-8248-0TT	2836	82	48	2
One 8" & Two 16" frosted glass segments on top				
L-PEFFG-8224-ESS	2164	82	24	2
L-PEFFG-8230-ESS	2485	82	30	2
L-PEFFG-8236-ESS	2656	82	36	2
L-PEFFG-8242-ESS	2711	82	42	2
L-PEFFG-8248-ESS	2928	82	48	2
Three 16" frosted glass segments on top				
L-PEFFG-8224-SSS	2203	82	24	2
L-PEFFG-8230-SSS	2451	82	30	2
L-PEFFG-8236-SSS	2649	82	36	2
L-PEFFG-8242-SSS	2841	82	42	2
L-PEFFG-8248-SSS	3058	82	48	2

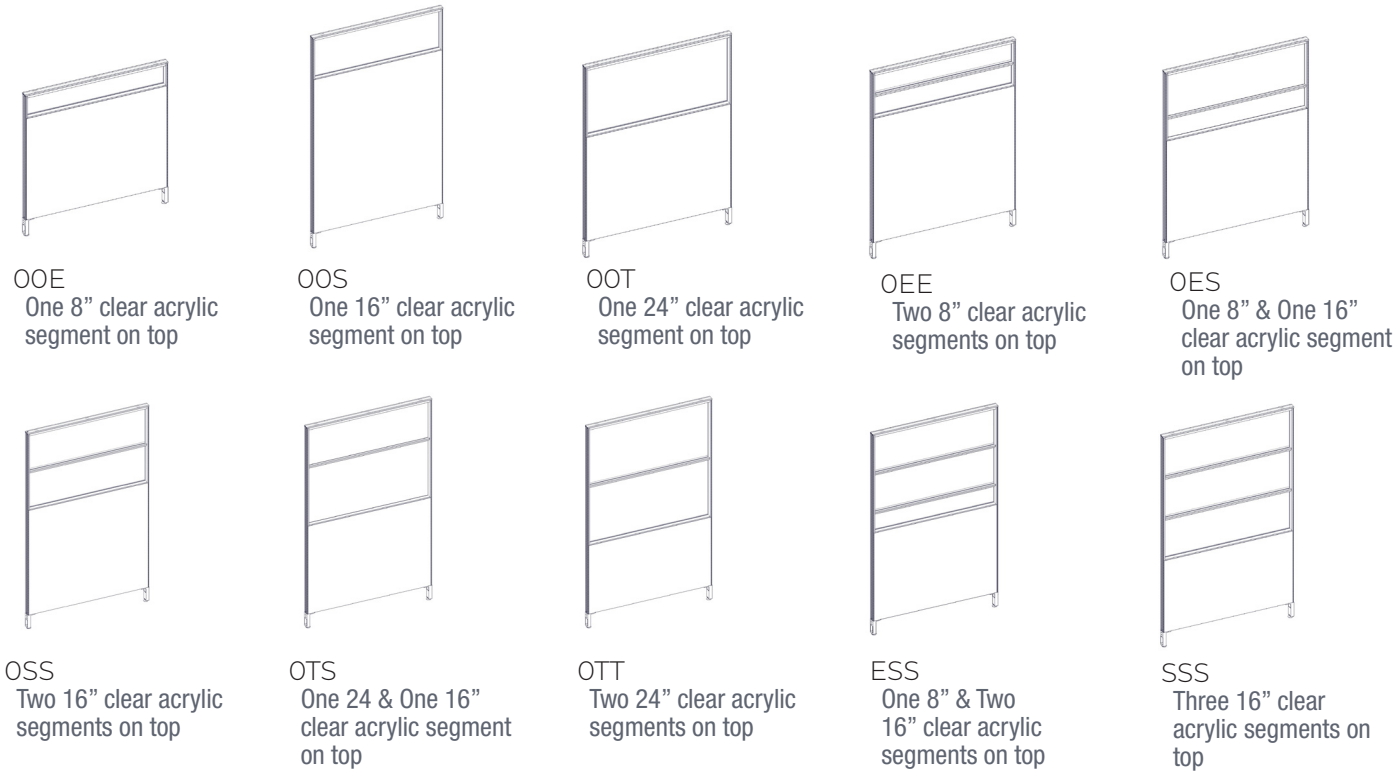

How to order and read your code

L - P E L C A - 42 24 - 0 0 E

product standard line P=glazed E=Elevated F=Fabric L=Laminate C=Clear F=Frosted A=Acrylic G=Glass height width 0 = No segment E = 8 inch segment S = 16 inch segment T = 24 inch segment

What's Included:

One (1) 2" thick panel with glazed glass top and laminate bottom, also 1" incremented slotted channels, One (1) top trim

How to Specify:

Refer to laminate cards for laminate selections
 Choose glass or acrylic
 Choose White, Black, Silver, Charcoal for Panel Frame colour

Options:

Height*:	34", 42", 50", 66", 82"
Width:	24", 30", 36", 42", 48",
Laminate	
Glass/Acrylic	
Metal Powder Coat Paint:	White, Black, Silver, Charcoal

*82"H available up to 36"W

Code	Price	H	W	D
One 8" clear acrylic segment on top				
L-PELCA-4224-00E	1203	42	24	2
L-PELCA-4230-00E	1257	42	30	2
L-PELCA-4236-00E	1315	42	36	2
L-PELCA-4242-00E	1400	42	42	2
L-PELCA-4248-00E	1443	42	48	2
L-PELCA-5024-00E	1240	50	24	2
L-PELCA-5030-00E	1297	50	30	2
L-PELCA-5036-00E	1352	50	36	2
L-PELCA-5042-00E	1467	50	42	2
L-PELCA-5048-00E	1501	50	48	2
One 16" clear acrylic segment on top				
L-PELCA-5024-00S	1251	50	24	2
L-PELCA-5030-00S	1310	50	30	2
L-PELCA-5036-00S	1365	50	36	2
L-PELCA-5042-00S	1495	50	42	2
L-PELCA-5048-00S	1528	50	48	2
L-PELCA-6624-00S	1357	66	24	2
L-PELCA-6630-00S	1437	66	30	2
L-PELCA-6636-00S	1517	66	36	2
L-PELCA-6642-00S	1694	66	42	2
L-PELCA-6648-00S	1737	66	48	2
L-PELCA-8224-00S	1670	82	24	2
L-PELCA-8230-00S	1679	82	30	2
L-PELCA-8236-00S	2230	82	36	2
One 24" clear acrylic segment on top				
L-PELCA-6624-00T	1357	66	24	2
L-PELCA-6630-00T	1455	66	30	2
L-PELCA-6636-00T	1551	66	36	2
L-PELCA-6642-00T	1694	66	42	2
L-PELCA-6648-00T	1777	66	48	2
Two 8" clear acrylic segments on top				
L-PELCA-6624-0EE	1458	66	24	2
L-PELCA-6630-0EE	1464	66	30	2
L-PELCA-6636-0EE	1760	66	36	2
L-PELCA-6642-0EE	1791	66	42	2
L-PELCA-6648-0EE	1839	66	48	2
One 8" & One 16" clear acrylic segment on top				
L-PELCA-6624-0ES	1463	66	24	2
L-PELCA-6630-0ES	1513	66	30	2
L-PELCA-6636-0ES	1835	66	36	2
L-PELCA-6642-0ES	1886	66	42	2
L-PELCA-6648-0ES	1940	66	48	2
Two 16" clear acrylic segments on top				
L-PELCA-8224-0SS	1523	82	24	2
L-PELCA-8230-0SS	1588	82	30	2
L-PELCA-8236-0SS	1944	82	36	2
One 24" & One 16" clear acrylic segment on top				
L-PELCA-8224-0TS	1554	82	24	2
L-PELCA-8230-0TS	1645	82	30	2
L-PELCA-8236-0TS	1953	82	36	2
Two 24" clear acrylic segments on top				
L-PELCA-8224-0TT	1487	82	24	2
L-PELCA-8230-0TT	1565	82	30	2
L-PELCA-8236-0TT	1828	82	36	2
One 8" & Two 16" clear acrylic segments on top				
L-PELCA-8224-ESS	1623	82	24	2
L-PELCA-8230-ESS	1792	82	30	2
L-PELCA-8236-ESS	2110	82	36	2
Three 16" clear acrylic segments on top				
L-PELCA-8224-SSS	1589	82	24	2
L-PELCA-8230-SSS	1677	82	30	2
L-PELCA-8236-SSS	2022	82	36	2

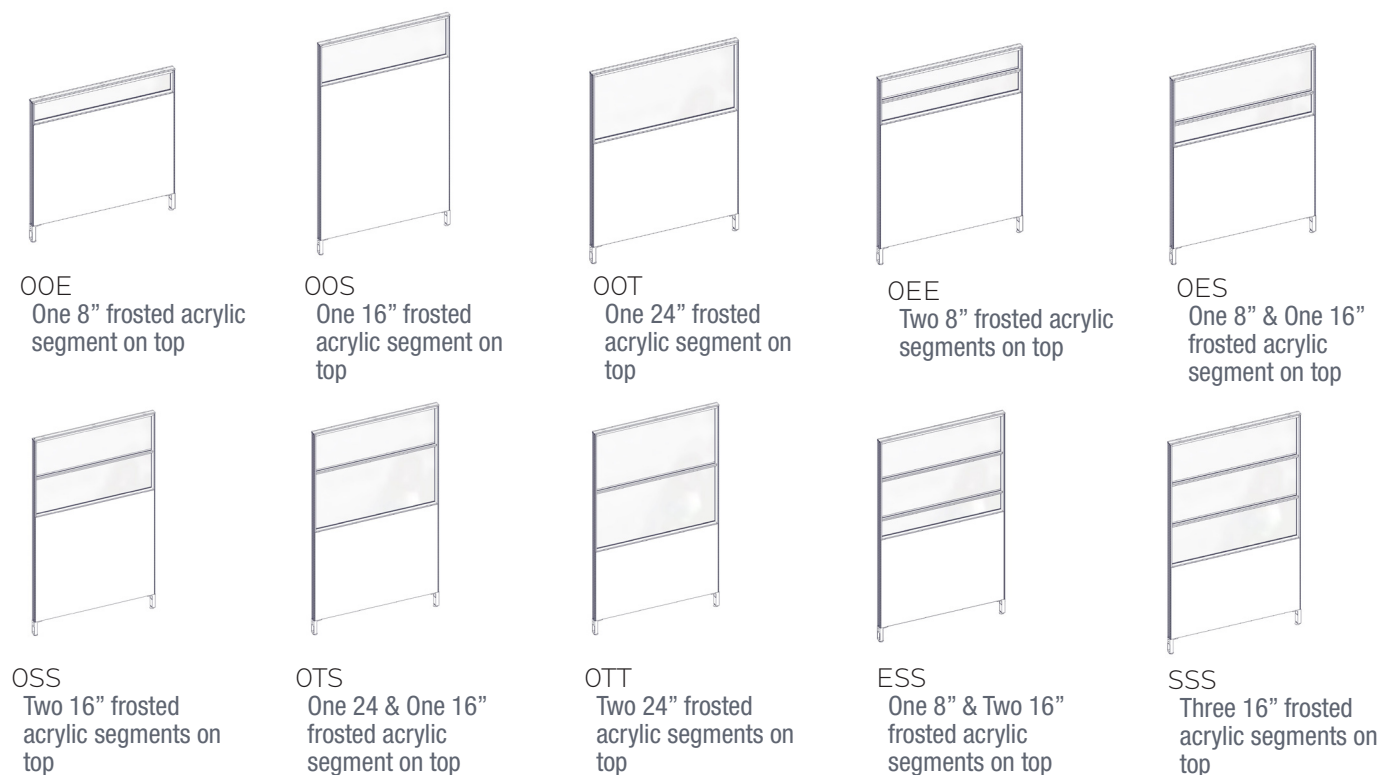

How to order and read your code

L - P E L F A - 4 2 2 4 - 0 0 E

product standard line P=glazed E=Elevated F=Fabric L=Laminate C=Clear F=Frosted A=Acrylic height G=Glass width 0 = No segment E = 8 inch segment S = 16 inch segment T = 24 inch segment

What's Included:

One (1) 2" thick panel with glazed glass top and laminate bottom, also 1" incremented slotted channels, One (1) top trim

How to Specify:

Refer to laminate cards for laminate selections
 Choose glass or acrylic
 Choose White, Black, Silver, Charcoal for Panel Frame colour

Options:

Height*:	34", 42", 50", 66", 82"
Width:	24", 30", 36", 42", 48",
Laminate	
Glass/Acrylic	
Metal Powder Coat Paint:	White, Black, Silver, Charcoal

*82"H available up to 36"W

Notes:

Non-power capable panel.
 Can be used in run with power-capable panels and allows wires to pass through.
 Panels are non tackable. For tackable option see Panel Add-On section.

Code	Price	H	W	D
One 8" frosted acrylic segment on top				
L-PELFA-4224-00E	1310	24	42	2
L-PELFA-4230-00E	1364	30	42	2
L-PELFA-4236-00E	1421	36	42	2
L-PELFA-4242-00E	1507	42	42	2
L-PELFA-4248-00E	1550	48	42	2
L-PELFA-5024-00E	1347	24	50	2
L-PELFA-5030-00E	1403	30	50	2
L-PELFA-5036-00E	1459	36	50	2
L-PELFA-5042-00E	1574	42	50	2
L-PELFA-5048-00E	1606	48	50	2
One 16" frosted acrylic segment on top				
L-PELFA-5024-00S	1357	24	50	2
L-PELFA-5030-00S	1416	30	50	2
L-PELFA-5036-00S	1471	36	50	2
L-PELFA-5042-00S	1602	42	50	2
L-PELFA-5048-00S	1635	48	50	2
L-PELFA-6624-00S	1464	24	66	2
L-PELFA-6630-00S	1546	30	66	2
L-PELFA-6636-00S	1624	36	66	2
L-PELFA-6642-00S	1801	42	66	2
L-PELFA-6648-00S	1844	48	66	2
L-PELFA-8224-00S	1708	24	82	2
L-PELFA-8230-00S	1728	30	82	2
L-PELFA-8236-00S	2296	36	82	2
One 24" frosted acrylic segment on top				
L-PELFA-6624-00T	1464	24	66	2
L-PELFA-6630-00T	1561	30	66	2
L-PELFA-6636-00T	1657	36	66	2
L-PELFA-6642-00T	1801	42	66	2
L-PELFA-6648-00T	1884	48	66	2

Code	Price	H	W	D
Two 8" frosted acrylic segments on top				
L-PELFA-6624-0EE	1526	24	66	2
L-PELFA-6630-0EE	1553	30	66	2
L-PELFA-6636-0EE	1878	36	66	2
L-PELFA-6642-0EE	1905	42	66	2
L-PELFA-6648-0EE	1975	48	66	2
One 8" & One 16" frosted acrylic segment on top				
L-PELFA-6624-0ES	1518	24	66	2
L-PELFA-6630-0ES	1589	30	66	2
L-PELFA-6636-0ES	1926	36	66	2
L-PELFA-6642-0ES	1998	42	66	2
L-PELFA-6648-0ES	2051	48	66	2
Two 16" frosted acrylic segments on top				
L-PELFA-8224-0SS	1418	24	82	2
L-PELFA-8230-0SS	1436	30	82	2
L-PELFA-8236-0SS	1744	36	82	2
One 24" & One 16" frosted acrylic segment on top				
L-PELFA-8224-0TS	1667	24	82	2
L-PELFA-8230-0TS	1796	30	82	2
L-PELFA-8236-0TS	2105	36	82	2
Two 24" frosted acrylic segments on top				
L-PELFA-8224-0TT	1601	24	82	2
L-PELFA-8230-0TT	1716	30	82	2
L-PELFA-8236-0TT	2010	36	82	2
One 8" & Two 16" frosted acrylic segments on top				
L-PELFA-8224-ESS	1736	24	82	2
L-PELFA-8230-ESS	1941	30	82	2
L-PELFA-8236-ESS	2260	36	82	2
Three 16" frosted acrylic segments on top				
L-PELFA-8224-SSS	1702	24	82	2
L-PELFA-8230-SSS	1827	30	82	2
L-PELFA-8236-SSS	2249	36	82	2

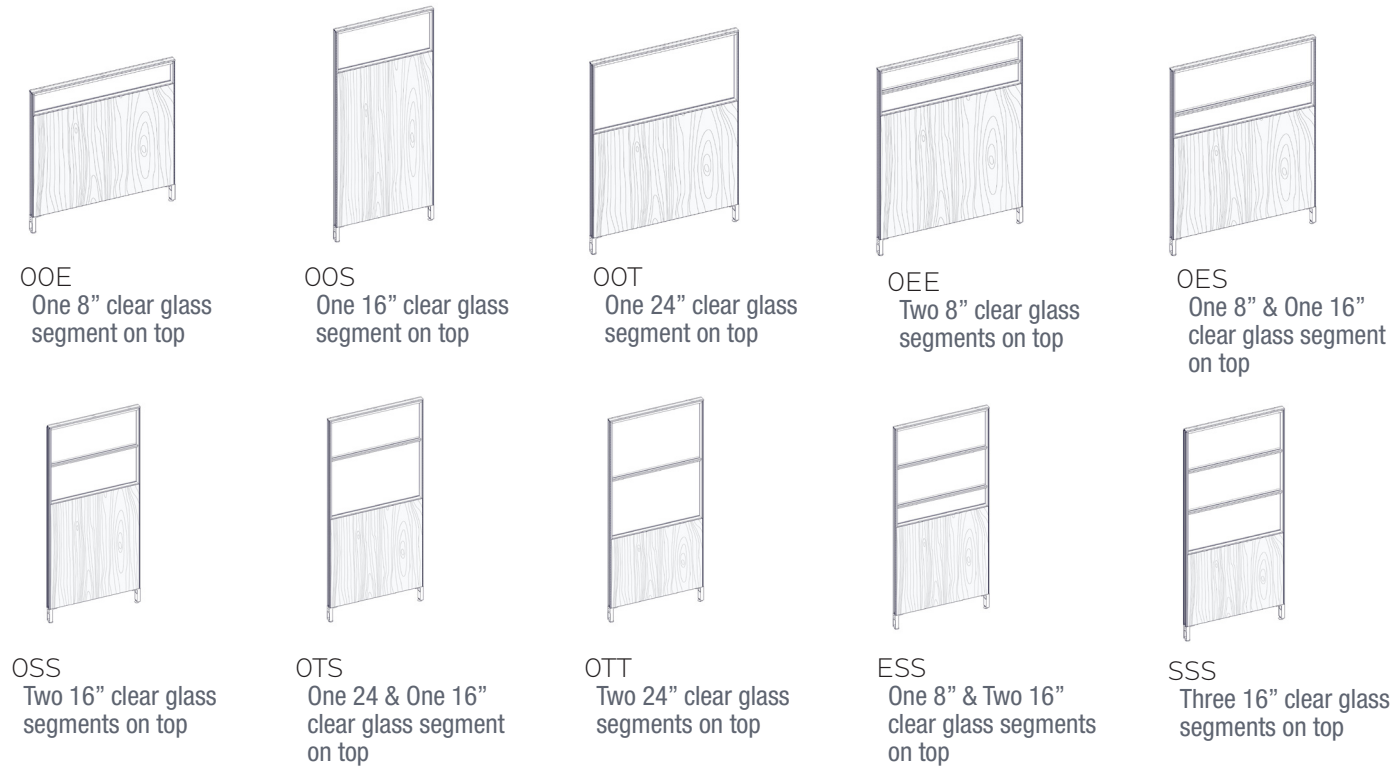

How to order and read your code

L - P E L C G - 42 24 - 00 E

product standard line P=glazed E=Elevated F=Fabric L=Laminate C=Clear F=Frosted A=Acrylic G=Glass height width O = No segment E = 8 inch segment S = 16 inch segment T = 24 inch segment

What's Included:

One (1) 2" thick panel with glazed glass top and laminate bottom, also 1" incremented slotted channels, One (1) top trim

How to Specify:

Refer to laminate cards for laminate selections
 Choose glass or acrylic
 Choose White, Black, Silver, Charcoal for Panel Frame color

Options:

Height*:	34", 42", 50", 66", 82"
Width:	24", 30", 36", 42", 48",
Laminate	
Glass/Acrylic	
Metal Powder Coat Paint:	White, Black, Silver, Charcoal

*82"H available up to 36"W

Notes:

Non-power capable panel.
 Can be used in run with power-capable panels and allows wires to pass through.
 Panels are non tackable. For tackable option see Panel Add-On section.

Code	Price	H	W	D
One 8" clear glass segment on top				
L-PELCG-4224-00E	1305	42	24	2
L-PELCG-4230-00E	1371	42	30	2
L-PELCG-4236-00E	1435	42	36	2
L-PELCG-4242-00E	1508	42	42	2
L-PELCG-4248-00E	1581	42	48	2
L-PELCG-5024-00E	1344	50	24	2
L-PELCG-5030-00E	1407	50	30	2
L-PELCG-5036-00E	1472	50	36	2
L-PELCG-5042-00E	1547	50	42	2
L-PELCG-5048-00E	1618	50	48	2
One 16" clear glass segment on top				
L-PELCG-5024-00S	1427	50	24	2
L-PELCG-5030-00S	1490	50	30	2
L-PELCG-5036-00S	1553	50	36	2
L-PELCG-5042-00S	1624	50	42	2
L-PELCG-5048-00S	1700	50	48	2
L-PELCG-6624-00S	1549	66	24	2
L-PELCG-6630-00S	1629	66	30	2
L-PELCG-6636-00S	1710	66	36	2
L-PELCG-6642-00S	1809	66	42	2
L-PELCG-6648-00S	1886	66	48	2
L-PELCG-8224-00S	1625	82	24	2
L-PELCG-8230-00S	1662	82	30	2
L-PELCG-8236-00S	2237	82	36	2
One 24" clear glass segment on top				
L-PELCG-6624-00T	1593	66	24	2
L-PELCG-6630-00T	1674	66	30	2
L-PELCG-6636-00T	1755	66	36	2
L-PELCG-6642-00T	1862	66	42	2
L-PELCG-6648-00T	1958	66	48	2
Two 8" clear glass segments on top				
L-PELCG-6624-0EE	1561	66	24	2
L-PELCG-6630-0EE	1605	66	30	2
L-PELCG-6636-0EE	1929	66	36	2
L-PELCG-6642-0EE	1970	66	42	2
L-PELCG-6648-0EE	2037	66	48	2
One 8" & One 16" clear glass segment on top				
L-PELCG-6624-0ES	1561	66	24	2
L-PELCG-6630-0ES	1625	66	30	2
L-PELCG-6636-0ES	1967	66	36	2
L-PELCG-6642-0ES	2025	66	42	2
L-PELCG-6648-0ES	2108	66	48	2
Two 16" clear glass segments on top				
L-PELCG-8224-0SS	1619	82	24	2
L-PELCG-8230-0SS	1680	82	30	2
L-PELCG-8236-0SS	2037	82	36	2
One 24" & One 16" clear glass segment on top				
L-PELCG-8224-0TS	1653	82	24	2
L-PELCG-8230-0TS	1743	82	30	2
L-PELCG-8236-0TS	2107	82	36	2
Two 24" clear glass segments on top				
L-PELCG-8224-0TT	1619	82	24	2
L-PELCG-8230-0TT	1714	82	30	2
L-PELCG-8236-0TT	2000	82	36	2
One 8" & Two 16" clear glass segments on top				
L-PELCG-8224-ESS	1814	82	24	2
L-PELCG-8230-ESS	1972	82	30	2
L-PELCG-8236-ESS	2346	82	36	2
Three 16" clear glass segments on top				
L-PELCG-8224-SSS	1791	82	24	2
L-PELCG-8230-SSS	1875	82	30	2
L-PELCG-8236-SSS	2188	82	36	2

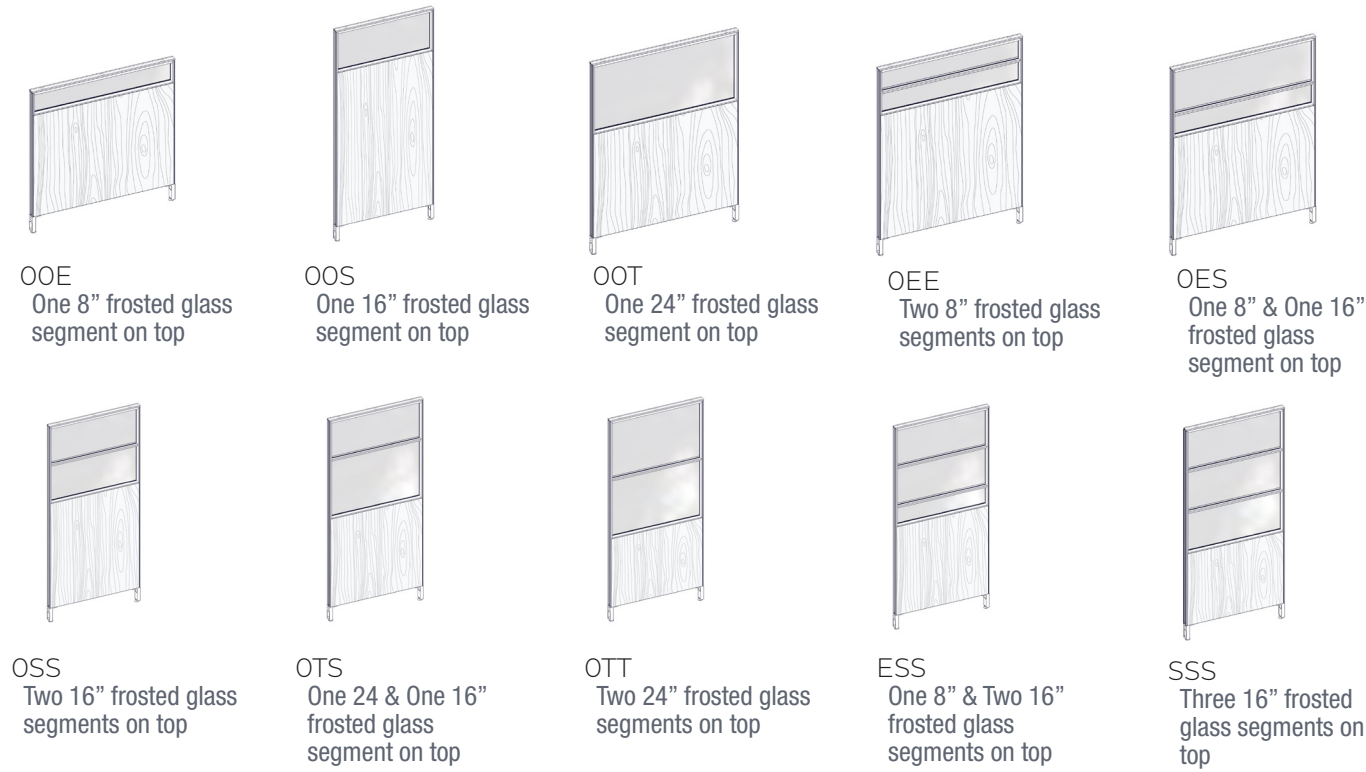

How to order and read your code

L - P E L F G - 42 24 - 00 E

product standard line P=glazed E=Elevated F=Fabric L=Laminate C=Clear F=Frosted A=Acrylic G=Glass height width 0 = No segment E = 8 inch segment S = 16 inch segment T = 24 inch segment

What's Included:

One (1) 2" thick panel with glazed glass top and laminate bottom, also 1" incremented slotted channels, One (1) top trim

How to Specify:

Refer to laminate cards for laminate selections
 Choose glass or acrylic
 Choose White, Black, Silver, Charcoal for Panel Frame colour

Options:

Height*:	34", 42", 50", 66", 82"
Width:	24", 30", 36", 42", 48",
Laminate	
Glass/Acrylic	
Metal Powder Coat Paint:	White, Black, Silver, Charcoal

*82"H available up to 36"W

Notes:

Non-power capable panel.
 Can be used in run with power-capable panels and allows wires to pass through.
 Panels are non tackable. For tackable option see Panel Add-On section.

Code	Price	H	W	D
One 8" frosted glass segment on top				
L-PELFG-4224-00E	1413	24	42	2
L-PELFG-4230-00E	1479	30	42	2
L-PELFG-4236-00E	1540	36	42	2
L-PELFG-4242-00E	1615	42	42	2
L-PELFG-4248-00E	1689	48	42	2
L-PELFG-5024-00E	1450	24	50	2
L-PELFG-5030-00E	1513	30	50	2
L-PELFG-5036-00E	1579	36	50	2
L-PELFG-5042-00E	1653	42	50	2
L-PELFG-5048-00E	1724	48	50	2
One 16" frosted glass segment on top				
L-PELFG-5024-00S	1534	24	50	2
L-PELFG-5030-00S	1598	30	50	2
L-PELFG-5036-00S	1661	36	50	2
L-PELFG-5042-00S	1731	42	50	2
L-PELFG-5048-00S	1807	48	50	2
L-PELFG-6624-00S	1655	24	66	2
L-PELFG-6630-00S	1736	30	66	2
L-PELFG-6636-00S	1818	36	66	2
L-PELFG-6642-00S	1915	42	66	2
L-PELFG-6648-00S	1993	48	66	2
L-PELFG-8224-00S	1824	24	82	2
L-PELFG-8230-00S	1870	30	82	2
L-PELFG-8236-00S	2465	36	82	2
One 24" frosted glass segment on top				
L-PELFG-6624-00T	1700	24	66	2
L-PELFG-6630-00T	1780	30	66	2
L-PELFG-6636-00T	1861	36	66	2
L-PELFG-6642-00T	1969	42	66	2
L-PELFG-6648-00T	2065	48	66	2

Code	Price	H	W	D
Two 8" frosted glass segments on top				
L-PELFG-6624-0EE	1744	24	66	2
L-PELFG-6630-0EE	1787	30	66	2
L-PELFG-6636-0EE	2112	36	66	2
L-PELFG-6642-0EE	2152	42	66	2
L-PELFG-6648-0EE	2219	48	66	2
One 8" & One 16" frosted glass segment on top				
L-PELFG-6624-0ES	1744	24	66	2
L-PELFG-6630-0ES	1819	30	66	2
L-PELFG-6636-0ES	2179	36	66	2
L-PELFG-6642-0ES	2257	42	66	2
L-PELFG-6648-0ES	2361	48	66	2
Two 16" frosted glass segments on top				
L-PELFG-8224-0SS	1801	24	82	2
L-PELFG-8230-0SS	1882	30	82	2
L-PELFG-8236-0SS	2281	36	82	2
One 24" & One 16" frosted glass segment on top				
L-PELFG-8224-0TS	1863	24	82	2
L-PELFG-8230-0TS	1993	30	82	2
L-PELFG-8236-0TS	2410	36	82	2
Two 24" frosted glass segments on top				
L-PELFG-8224-0TT	1861	24	82	2
L-PELFG-8230-0TT	2016	30	82	2
L-PELFG-8236-0TT	2365	36	82	2
One 8" & Two 16" frosted glass segments on top				
L-PELFG-8224-ESS	2086	24	82	2
L-PELFG-8230-ESS	2265	30	82	2
L-PELFG-8236-ESS	2683	36	82	2
Three 16" frosted glass segments on top				
L-PELFG-8224-SSS	2062	24	82	2
L-PELFG-8230-SSS	2180	30	82	2
L-PELFG-8236-SSS	2553	36	82	2

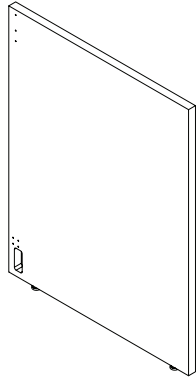

Single Span Middle
Horizontal Woodgrain
Gallery Panel

What's Included:

One (1) 1" thick laminate gallery panel, two (2) gallery panel top brackets

How to Specify:

Refer to laminate cards for laminate selections

Notes:

Gallery panels come with pre-drilled holes on each side and bottom notch for wire routing

Gallery panels must be used between two standard fabric or laminate panels

Gallery panels must be the same height or lower than the connecting standard fabric or laminate panel

Options:

Height: 34", 42", 50"

Width: 26", 32", 38", 44", 50", 56", 62", 68", 74"

Laminate color

Code	Price	H	W	D	Weight (lb.)	Volume (ft ³)
L-PYHM-3426-S1	302	34	26	2		
L-PYHM-3432-S1	333	34	32	2		
L-PYHM-3438-S1	366	34	38	2		
L-PYHM-3444-S1	393	34	44	2		
L-PYHM-3450-S1	427	34	50	2		
L-PYHM-3456-S1	458	34	50	2		
L-PYHM-3462-S1	487	34	62	2		
L-PYHM-3468-S1	518	34	68	2		
L-PYHM-3474-S1	548	34	74	2		
L-PYHM-4226-S1	333	42	26	2		
L-PYHM-4232-S1	373	42	32	2		
L-PYHM-4238-S1	411	42	38	2		
L-PYHM-4244-S1	450	42	44	2		
L-PYHM-4250-S1	486	42	50	2		
L-PYHM-4256-S1	521	42	50	2		
L-PYHM-4262-S1	561	42	62	2		
L-PYHM-4268-S1	597	42	68	2		
L-PYHM-4274-S1	637	42	74	2		
L-PYHM-5026-S1	368	50	26	2		
L-PYHM-5032-S1	414	50	32	2		
L-PYHM-5038-S1	457	50	38	2		
L-PYHM-5044-S1	500	50	44	2		
L-PYHM-5050-S1	544	50	50	2		
L-PYHM-5056-S1	588	50	50	2		
L-PYHM-5062-S1	635	50	62	2		
L-PYHM-5068-S1	676	50	68	2		
L-PYHM-5074-S1	723	50	74	2		

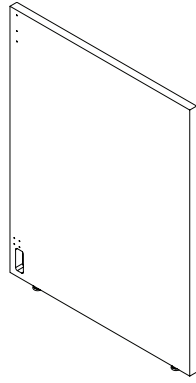

Double Span Middle
Horizontal Woodgrain
Gallery Panel

What's Included:

- X"-X": One (1) 1"thick laminate gallery panel, two (2) gallery panel top brackets
- X"-X": Two (2) 1"thick laminate gallery panel, four (4) gallery panel top brackets

How to Specify:

Refer to laminate cards for laminate selections

Notes:

- Gallery panels come with pre-drilled holes on each side and bottom notch for wire routing
- Gallery panels must be used between two standard fabric or laminate panels
- Gallery panels must be the same height or lower than the connecting standard fabric or laminate panel

Options:

Height:	34", 42", 50"
Width:	26", 32", 38", 44", 50", 56", 62", 68", 74"
Laminate color	

Code	Price	H	W	D	Weight (lb.)	Volume (ft ³)
1 Piece						
L-PYHM-3442-D1	386	34	42	2		
L-PYHM-3450-D1	427	34	50	2		
L-PYHM-3462-D1	487	34	62	2		
L-PYHM-3474-D1	548	34	74	2		
L-PYHM-3486-D1	611	34	86	2		
L-PYHM-4242-D1	434	42	42	2		
L-PYHM-4250-D1	486	42	50	2		
L-PYHM-4262-D1	561	42	62	2		
L-PYHM-4274-D1	637	42	74	2		
L-PYHM-4286-D1	712	42	86	2		
L-PYHM-5042-D1	486	50	42	2		
L-PYHM-5050-D1	544	50	50	2		
L-PYHM-5062-D1	635	50	62	2		
L-PYHM-5074-D1	723	50	74	2		
L-PYHM-5086-D1	810	50	86	2		
2 Pieces						
L-PYHM-3498-D2	786	34	98	2		
L-PYHM-4298-D2	900	42	98	2		
L-PYHM-5098-D2	1016	50	98	2		
L-PYHM-34110-D2	850	34	110	2		
L-PYHM-34122-D2	910	34	122	2		
L-PYHM-34134-D2	969	34	134	2		
L-PYHM-34146-D2	1031	34	146	2		
L-PYHM-42110-D2	975	42	110	2		
L-PYHM-42122-D2	1052	42	122	2		
L-PYHM-42134-D2	1128	42	134	2		
L-PYHM-42146-D2	1206	42	146	2		
L-PYHM-50110-D2	1106	50	110	2		
L-PYHM-50122-D2	1193	50	122	2		
L-PYHM-50134-D2	1286	50	134	2		
L-PYHM-50146-D2	1372	50	146	2		



Single Span End Horizontal Woodgrain Gallery Panel No Power Cutout

What's Included:

One (1) 1" thick laminate gallery panel, two (2) gallery panel top brackets

How to Specify:

Refer to laminate cards for laminate selections

Choose option for power cut out or no power cut out

Options:

Height: 34", 42", 50"

Width: 26", 32", 38", 44", 50", 56", 62", 68", 74"

Laminate color

Power cut out

Notes:

Gallery panels come with pre-drilled holes on each side and bottom notch for wire routing

Gallery panels must be used between two standard fabric or laminate panels

Gallery panels must be the same height or lower than the connecting standard fabric or laminate panel

Code	Price	H	W	D	Weight (lb.)	Volume (ft ³)
left hand						
L-PYHE-3426-S1L	260	34	26	2		
L-PYHE-3432-S1L	291	34	32	2		
L-PYHE-3438-S1L	322	34	38	2		
L-PYHE-3444-S1L	352	34	44	2		
L-PYHE-3450-S1L	381	34	50	2		
L-PYHE-3456-S1L	415	34	56	2		
L-PYHE-3462-S1L	444	34	62	2		
L-PYHE-3468-S1L	477	34	68	2		
L-PYHE-3474-S1L	506	34	74	2		
L-PYHE-4226-S1L	291	42	26	2		
L-PYHE-4232-S1L	329	42	32	2		
L-PYHE-4238-S1L	367	42	38	2		
L-PYHE-4244-S1L	405	42	44	2		
L-PYHE-4250-S1L	441	42	50	2		
L-PYHE-4256-S1L	480	42	56	2		

Code	Price	H	W	D	Weight (lb.)	Volume (ft ³)
L-PYHE-4262-S1L	517	42	62	2		
L-PYHE-4268-S1L	554	42	68	2		
L-PYHE-4274-S1L	590	42	74	2		
L-PYHE-5026-S1L	324	50	26	2		
L-PYHE-5032-S1L	368	50	32	2		
L-PYHE-5038-S1L	414	50	38	2		
L-PYHE-5044-S1L	458	50	44	2		
L-PYHE-5050-S1L	500	50	50	2		
L-PYHE-5056-S1L	545	50	56	2		
L-PYHE-5062-S1L	588	50	62	2		
L-PYHE-5068-S1L	635	50	68	2		
L-PYHE-5074-S1L	677	50	74	2		
right hand						
L-PYHE-3426-S1R	260	34	26	2		
L-PYHE-3432-S1R	291	34	32	2		
L-PYHE-3438-S1R	322	34	38	2		
L-PYHE-3444-S1R	352	34	44	2		
L-PYHE-3450-S1R	381	34	50	2		
L-PYHE-3456-S1R	415	34	56	2		
L-PYHE-3462-S1R	444	34	62	2		
L-PYHE-3468-S1R	477	34	68	2		
L-PYHE-3474-S1R	506	34	74	2		
L-PYHE-4226-S1R	291	42	26	2		
L-PYHE-4232-S1R	329	42	32	2		
L-PYHE-4238-S1R	367	42	38	2		
L-PYHE-4244-S1R	405	42	44	2		
L-PYHE-4250-S1R	441	42	50	2		
L-PYHE-4256-S1R	480	42	56	2		
L-PYHE-4262-S1R	517	42	62	2		
L-PYHE-4268-S1R	554	42	68	2		
L-PYHE-4274-S1R	590	42	74	2		
L-PYHE-5026-S1R	324	50	26	2		
L-PYHE-5032-S1R	368	50	32	2		
L-PYHE-5038-S1R	414	50	38	2		
L-PYHE-5044-S1R	458	50	44	2		
L-PYHE-5050-S1R	500	50	50	2		
L-PYHE-5056-S1R	545	50	56	2		
L-PYHE-5062-S1R	588	50	62	2		
L-PYHE-5068-S1R	635	50	68	2		
L-PYHE-5074-S1R	677	50	74	2		



Single Span End Horizontal Woodgrain Gallery Panel with Power Cutout

What's Included:

One (1) 1" thick laminate gallery panel, two (2) gallery panel top brackets

How to Specify:

Refer to laminate cards for laminate selections

Choose option for power cut out or no power cut out

Options:

Height: 34", 42", 50"

Width: 26", 32", 38", 44", 50", 56", 62", 68", 74"

Laminate color

No power cut out

Code	Price	H	W	D	Weight (lb.)	Volume (ft ³)
left hand						
L-PCHE-3426-S1L	260	34	26	1		
L-PCHE-3432-S1L	291	34	32	1		
L-PCHE-3438-S1L	322	34	38	1		
L-PCHE-3444-S1L	352	34	44	1		
L-PCHE-3450-S1L	381	34	50	1		
L-PCHE-3456-S1L	415	34	56	1		
L-PCHE-3462-S1L	444	34	62	1		
L-PCHE-3468-S1L	477	34	68	1		
L-PCHE-3474-S1L	506	34	74	1		
L-PCHE-4226-S1L	291	42	26	1		
L-PCHE-4232-S1L	329	42	32	1		
L-PCHE-4238-S1L	367	42	38	1		
L-PCHE-4244-S1L	405	42	44	1		
L-PCHE-4250-S1L	441	42	50	1		
L-PCHE-4256-S1L	480	42	56	1		

Code	Price	H	W	D	Weight (lb.)	Volume (ft ³)
L-PCHE-4262-S1L	517	42	62	1		
L-PCHE-4268-S1L	554	42	68	1		
L-PCHE-4274-S1L	590	42	74	1		
L-PCHE-5026-S1L	324	50	26	1		
L-PCHE-5032-S1L	368	50	32	1		
L-PCHE-5038-S1L	414	50	38	1		
L-PCHE-5044-S1L	458	50	44	1		
L-PCHE-5050-S1L	500	50	50	1		
L-PCHE-5056-S1L	545	50	56	1		
L-PCHE-5062-S1L	588	50	62	1		
L-PCHE-5068-S1L	635	50	68	1		
L-PCHE-5074-S1L	677	50	74	1		
right hand						
L-PCHE-3426-S1R	260	34	26	1		
L-PCHE-3432-S1R	291	34	32	1		
L-PCHE-3438-S1R	322	34	38	1		
L-PCHE-3444-S1R	352	34	44	1		
L-PCHE-3450-S1R	381	34	50	1		
L-PCHE-3456-S1R	415	34	56	1		
L-PCHE-3462-S1R	444	34	62	1		
L-PCHE-3468-S1R	477	34	68	1		
L-PCHE-3474-S1R	506	34	74	1		
L-PCHE-4226-S1R	291	42	26	1		
L-PCHE-4232-S1R	329	42	32	1		
L-PCHE-4238-S1R	367	42	38	1		
L-PCHE-4244-S1R	405	42	44	1		
L-PCHE-4250-S1R	441	42	50	1		
L-PCHE-4256-S1R	480	42	56	1		
L-PCHE-4262-S1R	517	42	62	1		
L-PCHE-4268-S1R	554	42	68	1		
L-PCHE-4274-S1R	590	42	74	1		
L-PCHE-5026-S1R	324	50	26	1		
L-PCHE-5032-S1R	368	50	32	1		
L-PCHE-5038-S1R	414	50	38	1		
L-PCHE-5044-S1R	458	50	44	1		
L-PCHE-5050-S1R	500	50	50	1		
L-PCHE-5056-S1R	545	50	56	1		
L-PCHE-5062-S1R	588	50	62	1		
L-PCHE-5068-S1R	635	50	68	1		
L-PCHE-5074-S1R	677	50	74	1		



Single piece
Double Span End
Horizontal Woodgrain
Gallery Panel
No Power Cutout



Two pieces
Double Span End
Horizontal Woodgrain
Gallery Panel
No Power Cutout

What's Included:

- X"-X": One (1) 1"thick laminate gallery panel, two (2) gallery panel top brackets
- X"-X": Two (2) 1"thick laminate gallery panel, four (4) gallery panel top brackets

How to Specify:

- Refer to laminate cards for laminate selections
- Choose option for power cut out or no power cut out

Options:

Height:

Width:

Laminate color

Power cut out

Notes:

- Gallery panels come with pre-drilled holes on each side and bottom notch for wire routing
- Gallery panels must be used between two standard fabric or laminate panels
- Gallery panels must be the same height or lower than the connecting standard fabric or laminate panel

Code	Price	H	W	D	Weight (lb.)	Volume (ft ³)
single piece						
L-PYHE-3442-D1	342	34	42	2		
L-PYHE-3450-D1	381	34	50	2		
L-PYHE-3462-D1	444	34	62	2		
L-PYHE-3474-D1	506	34	74	2		
L-PYHE-3486-D1	570	34	86	2		
L-PYHE-4242-D1	391	42	42	2		
L-PYHE-4250-D1	441	42	50	2		
L-PYHE-4262-D1	517	42	62	2		
L-PYHE-4274-D1	590	42	74	2		
L-PYHE-4286-D1	670	42	86	2		
L-PYHE-5042-D1	441	50	42	2		
L-PYHE-5050-D1	500	50	50	2		
L-PYHE-5062-D1	588	50	62	2		
L-PYHE-5074-D1	677	50	74	2		
L-PYHE-5086-D1	767	50	86	2		
2 pieces						
L-PYHE-3498-D2	786	34	98	2		
L-PYHE-4298-D2	900	42	98	2		
L-PYHE-5098-D2	1016	50	98	2		
L-PYHE-34110-D2	850	34	110	2		
L-PYHE-34122-D2	910	34	122	2		
L-PYHE-34134-D2	969	34	134	2		
L-PYHE-34146-D2	1031	34	146	2		
L-PYHE-42110-D2	975	42	110	2		
L-PYHE-42122-D2	1052	42	122	2		
L-PYHE-42134-D2	1128	42	134	2		
L-PYHE-42146-D2	1206	42	146	2		
L-PYHE-50110-D2	1106	50	110	2		
L-PYHE-50122-D2	1193	50	122	2		
L-PYHE-50134-D2	1286	50	134	2		
L-PYHE-50146-D2	1372	50	146	2		

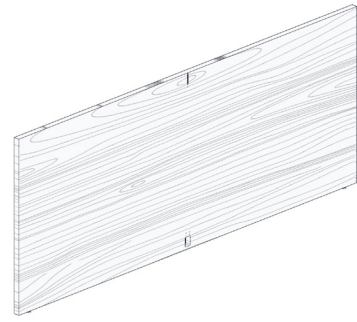

Single piece

Double Span End Horizontal Woodgrain Gallery Panel with Power Cutout



2 pieces

What's Included:

X"-X": One (1) 1"thick laminate gallery panel, two (2) gallery panel top brackets

X"-X": Two (2) 1"thick laminate gallery panel, four (4) gallery panel top brackets

How to Specify:

Refer to laminate cards for laminate selections

Choose option for power cut out or no power cut out

Notes:

Gallery panels come with pre-drilled holes on each side and bottom notch for wire routing

Gallery panels must be used between two standard fabric or laminate panels

Gallery panels must be the same height or lower than the connecting standard fabric or laminate panel

Options:

Height: 34", 42", 50"

Width: 26", 32", 38", 44", 50", 56", 62", 68", 74"

Laminate color

No power cut out

Code	Price	H	W	D	Weight (lb.)	Volume (ft ³)
single piece						
L-PCHE-3442-D1	342	34	42	1		
L-PCHE-3450-D1	381	34	50	1		
L-PCHE-3462-D1	444	34	62	1		
L-PCHE-3474-D1	506	34	74	1		
L-PCHE-3486-D1	570	34	86	1		
L-PCHE-4242-D1	391	42	42	1		
L-PCHE-4250-D1	441	42	50	1		
L-PCHE-4262-D1	517	42	62	1		
L-PCHE-4274-D1	590	42	74	1		
L-PCHE-4286-D1	670	42	86	1		
L-PCHE-5042-D1	441	50	42	1		
L-PCHE-5050-D1	500	50	50	1		
L-PCHE-5062-D1	588	50	62	1		
L-PCHE-5074-D1	677	50	74	1		
L-PCHE-5086-D1	767	50	86	1		
2 pieces						
L-PCHE-3498-D2	786	34	98	1		
L-PCHE-34110-D2	850	34	110	1		
L-PCHE-34122-D2	910	34	122	1		
L-PCHE-34134-D2	969	34	134	1		
L-PCHE-34146-D2	1031	34	146	1		
L-PCHE-4298-D2	900	42	98	1		
L-PCHE-42110-D2	975	42	110	1		
L-PCHE-42122-D2	1052	42	122	1		
L-PCHE-42134-D2	1128	42	134	1		
L-PCHE-42146-D2	1206	42	146	1		
L-PCHE-5098-D2	1016	50	98	1		
L-PCHE-50110-D2	1106	50	110	1		
L-PCHE-50122-D2	1193	50	122	1		
L-PCHE-50134-D2	1286	50	134	1		
L-PCHE-50146-D2	1372	50	146	1		

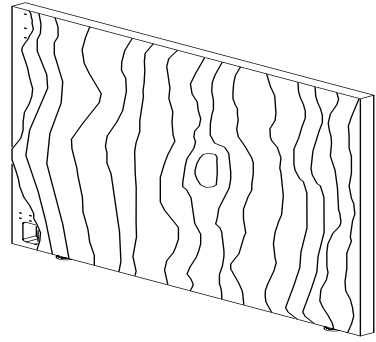

Single Span Middle
Vertical Woodgrain
Gallery Panel

What's Included:

One (1) 1" thick laminate gallery panel,
two (2) gallery panel top brackets

How to Specify:

Refer to laminate cards for laminate selections

Notes:

Gallery panels come with pre-drilled holes on each side and bottom notch for wire routing

Gallery panels must be used between two standard fabric or laminate panels

Gallery panels must be the same height or lower than the connecting standard fabric or laminate panel

Options:

Height: 34", 42", 50"

Width: 26", 32", 38", 44", 50", 56", 62", 68", 74"

Laminate color

Code	Price	H	W	D	Weight (lb.)	Volume (ft ³)
L-PYGM-3426-S1	302	34	26	1	17.68	0.51
L-PYGM-3432-S1	333	34	32	1	21.76	0.63
L-PYGM-3438-S1	366	34	38	1	25.84	0.75
L-PYGM-3444-S1	393	34	44	1	29.92	0.87
L-PYGM-3450-S1	427	34	50	1	34	0.98
L-PYGM-3456-S1	458	34	56	1	38.08	1.10
L-PYGM-4226-S1	333	42	26	1	21.84	0.63
L-PYGM-4232-S1	373	42	32	1	26.88	0.78
L-PYGM-4238-S1	411	42	38	1	31.92	0.92
L-PYGM-4244-S1	450	42	44	1	36.96	1.07
L-PYGM-4250-S1	486	42	50	1	42	1.22
L-PYGM-4256-S1	521	42	56	1	47.04	1.36
L-PYGM-5026-S1	368	50	26	1	26	0.75
L-PYGM-5032-S1	414	50	32	1	32	0.93
L-PYGM-5038-S1	457	50	38	1	38	1.10
L-PYGM-5044-S1	500	50	44	1	44	1.27
L-PYGM-5050-S1	544	50	50	1	50	1.45
L-PYGM-5056-S1	588	50	56	1	56	1.62

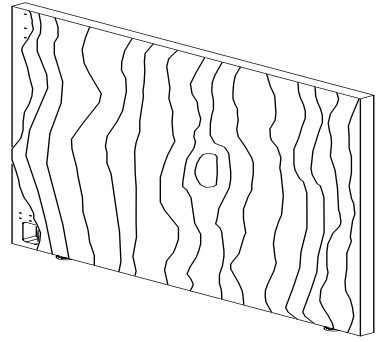

Double Span Middle
Vertical Woodgrain
Gallery Panel

What's Included:

X"-X": One (1) 1"thick laminate gallery panel, two (2) gallery panel top brackets

X"-X": Two (2) 1"thick laminate gallery panel, four (4) gallery panel top brackets

How to Specify:

Refer to laminate cards for laminate selections

Notes:

Gallery panels come with pre-drilled holes on each side and bottom notch for wire routing

Gallery panels must be used between two standard fabric or laminate panels

Gallery panels must be the same height or lower than the connecting standard fabric or laminate panel

Options:

Height: 34", 42", 50"

Width: 26", 32", 38", 44", 50", 56", 62", 68", 74"

Laminate color

Code	Price	H	W	D	Weight (lb.)	Volume (ft ³)
single piece						
L-PYGM-3442-D1	386	34	42	1	28.56	0.83
L-PYGM-3450-D1	427	34	50	1	34	0.98
L-PYGM-4242-D1	434	42	42	1	28.56	1.02
L-PYGM-4250-D1	486	42	50	1	42	1.22
L-PYGM-5042-D1	486	50	42	1	28.56	1.22
L-PYGM-5050-D1	544	50	50	1	50	1.45
2 pieces						
L-PYGM-3462-D2	600	34	62	1	42.16	1.22
L-PYGM-3474-D2	661	34	74	1	50.32	1.46
L-PYGM-3486-D2	724	34	86	1	58.48	1.69
L-PYGM-3498-D2	786	34	98	1	66.64	1.93
L-PYGM-4262-D2	676	42	62	1	52.08	1.51
L-PYGM-4274-D2	750	42	74	1	62.16	1.80
L-PYGM-4286-D2	826	42	86	1	72.24	2.09
L-PYGM-4298-D2	900	42	98	1	82.32	2.38
L-PYGM-5062-D2	752	50	62	1	62	1.79
L-PYGM-5074-D2	840	50	74	1	74	2.14
L-PYGM-5086-D2	930	50	86	1	86	2.49
L-PYGM-5098-D2	1016	50	98	1	98	2.84
L-PYGM-34110-D2	850	34	110	1	74.8	2.16
L-PYGM-42110-D2	975	42	110	1	92.4	2.67
L-PYGM-50110-D2	1106	50	110	1	110	3.18

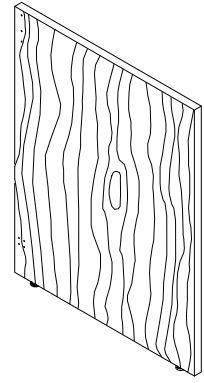

Single Span End
Vertical Woodgrain
Gallery Panel
No Power Cutout

What's Included:

One (1) 1"thick laminate gallery panel,
two (2) gallery panel top brackets

How to Specify:

Refer to laminate cards for laminate selections

Choose option for power cut out or no power cut out

Notes:

Gallery panels come with pre-drilled holes on each side and bottom notch for wire routing

Gallery panels must be used between two standard fabric or laminate panels

Gallery panels must be the same height or lower than the connecting standard fabric or laminate panel

Options:

Height: 34", 42", 50"

Width: 26", 32", 38", 44", 50", 56", 62", 68", 74"

Laminate color

Power cut out, No power cut out

Code	Price	H	W	D	Weight (lb.)	Volume (ft ³)
left hand						
L-PYGE-3426-S1L	260	34	26	1	17.68	0.51
L-PYGE-3432-S1L	291	34	32	1	21.76	0.63
L-PYGE-3438-S1L	322	34	38	1	25.84	0.75
L-PYGE-3444-S1L	352	34	44	1	29.92	0.87
L-PYGE-3450-S1L	381	34	50	1	34	0.98
L-PYGE-3456-S1L	415	34	56	1	38.08	1.10
L-PYGE-4226-S1L	291	42	26	1	21.84	0.63
L-PYGE-4232-S1L	329	42	32	1	26.88	0.78
L-PYGE-4238-S1L	367	42	38	1	31.92	0.92
L-PYGE-4244-S1L	405	42	44	1	36.96	1.07
L-PYGE-4250-S1L	441	42	50	1	42	1.22
L-PYGE-4256-S1L	480	42	56	1	47.04	1.36
L-PYGE-5026-S1L	324	50	26	1	26	0.75
L-PYGE-5032-S1L	368	50	32	1	32	0.93
L-PYGE-5038-S1L	414	50	38	1	38	1.10
L-PYGE-5044-S1L	458	50	44	1	44	1.27
L-PYGE-5050-S1L	500	50	50	1	50	1.45
L-PYGE-5056-S1L	545	50	56	1	56	1.62
right hand						
L-PYGE-3426-S1R	260	34	26	1	17.68	0.51
L-PYGE-3432-S1R	291	34	32	1	21.76	0.63
L-PYGE-3438-S1R	322	34	38	1	25.84	0.75
L-PYGE-3444-S1R	352	34	44	1	29.92	0.87
L-PYGE-3450-S1R	381	34	50	1	34	0.98
L-PYGE-3456-S1R	415	34	56	1	38.08	1.10
L-PYGE-4226-S1R	291	42	26	1	21.84	0.63
L-PYGE-4232-S1R	329	42	32	1	26.88	0.78
L-PYGE-4238-S1R	367	42	38	1	31.92	0.92
L-PYGE-4244-S1R	405	42	44	1	36.96	1.07
L-PYGE-4250-S1R	441	42	50	1	42	1.22
L-PYGE-4256-S1R	480	42	56	1	47.04	1.36
L-PYGE-5026-S1R	324	50	26	1	26	0.75
L-PYGE-5032-S1R	368	50	32	1	32	0.93
L-PYGE-5038-S1R	414	50	38	1	38	1.10
L-PYGE-5044-S1R	458	50	44	1	44	1.27
L-PYGE-5050-S1R	500	50	50	1	50	1.45
L-PYGE-5056-S1R	545	50	56	1	56	1.62

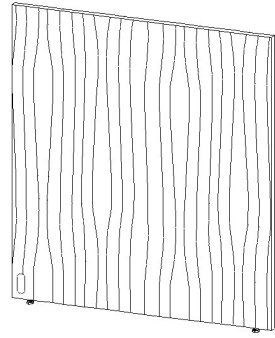

Single Span End
Vertical Woodgrain
Gallery Panel
with Power Cutout

What's Included:

One (1) 1"thick laminate gallery panel,
two (2) gallery panel top brackets

How to Specify:

Refer to laminate cards for laminate selections

Choose option for power cut out or no power cut out

Notes:

Gallery panels come with pre-drilled holes on each side and bottom notch for wire routing

Gallery panels must be used between two standard fabric or laminate panels

Gallery panels must be the same height or lower than the connecting standard fabric or laminate panel

Options:

Height: 34", 42", 50"

Width: 26", 32", 38", 44", 50", 56", 62", 68", 74"

Laminate color

Power cut out, No power cut out

Code	Price	H	W	D	Weight (lb.)	Volume (ft ³)
left hand						
L-PCGE-3426-S1L	260	34	26	1	17.68	0.51
L-PCGE-3432-S1L	291	34	32	1	21.76	0.63
L-PCGE-3438-S1L	322	34	38	1	25.84	0.75
L-PCGE-3444-S1L	352	34	44	1	29.92	0.87
L-PCGE-3450-S1L	381	34	50	1	34	0.98
L-PCGE-3456-S1L	415	34	56	1	38.08	1.10
L-PCGE-4226-S1L	291	42	26	1	21.84	0.63
L-PCGE-4232-S1L	329	42	32	1	26.88	0.78
L-PCGE-4238-S1L	367	42	38	1	31.92	0.92
L-PCGE-4244-S1L	405	42	44	1	36.96	1.07
L-PCGE-4250-S1L	441	42	50	1	42	1.22
L-PCGE-4256-S1L	480	42	56	1	47.04	1.36
L-PCGE-5026-S1L	324	50	26	1	26	0.75
L-PCGE-5032-S1L	368	50	32	1	32	0.93
L-PCGE-5038-S1L	414	50	38	1	38	1.10
L-PCGE-5044-S1L	458	50	44	1	44	1.27
L-PCGE-5050-S1L	500	50	50	1	50	1.45
L-PCGE-5056-S1L	545	50	56	1	56	1.62
right hand						
L-PCGE-3426-S1R	260	34	26	1	17.68	0.51
L-PCGE-3432-S1R	291	34	32	1	21.76	0.63
L-PCGE-3438-S1R	322	34	38	1	25.84	0.75
L-PCGE-3444-S1R	352	34	44	1	29.92	0.87
L-PCGE-3450-S1R	381	34	50	1	34	0.98
L-PCGE-3456-S1R	415	34	56	1	38.08	1.10
L-PCGE-4226-S1R	291	42	26	1	21.84	0.63
L-PCGE-4232-S1R	329	42	32	1	26.88	0.78
L-PCGE-4238-S1R	367	42	38	1	31.92	0.92
L-PCGE-4244-S1R	405	42	44	1	36.96	1.07
L-PCGE-4250-S1R	441	42	50	1	42	1.22
L-PCGE-4256-S1R	480	42	56	1	47.04	1.36
L-PCGE-5026-S1R	324	50	26	1	26	0.75
L-PCGE-5032-S1R	368	50	32	1	32	0.93
L-PCGE-5038-S1R	414	50	38	1	38	1.10
L-PCGE-5044-S1R	458	50	44	1	44	1.27
L-PCGE-5050-S1R	500	50	50	1	50	1.45
L-PCGE-5056-S1R	545	50	56	1	56	1.62

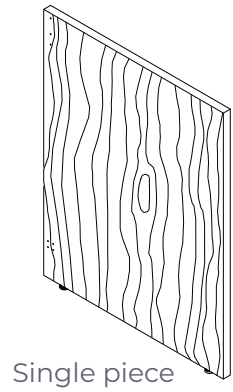

Double Span End
Vertical Woodgrain
Gallery Panel
No Power Cutout

Single piece

What's Included:

X"-X": One (1) 1"thick laminate gallery panel, two (2) gallery panel top brackets

X"-X": Two (2) 1"thick laminate gallery panel, four (4) gallery panel top brackets

How to Specify:

Refer to laminate cards for laminate selections

Choose option for power cut out or no power cut out

Notes:

Gallery panels come with pre-drilled holes on each side and bottom notch for wire routing

Gallery panels must be used between two standard fabric or laminate panels

Gallery panels must be the same height or lower than the connecting standard fabric or laminate panel

Options:

Height: 34", 42", 50"

Width: 26", 32", 38", 44", 50", 56", 62", 68", 74"

Laminate color

Power cut out, no power cut out

Code	Price	H	W	D	Weight (lb.)	Volume (ft ³)
single piece						
L-PYGE-3442-D1	342	34	42	1	28.56	0.83
L-PYGE-3450-D1	381	34	50	1	34	0.98
L-PYGE-4242-D1	391	42	42	1	28.56	1.02
L-PYGE-4250-D1	441	42	50	1	42	1.22
L-PYGE-5042-D1	441	50	42	1	28.56	1.22
L-PYGE-5050-D1	500	50	50	1	50	1.45
2 pieces						
L-PYGE-3462-D2	600	34	62	1	42.16	1.22
L-PYGE-3474-D2	661	34	74	1	50.32	1.46
L-PYGE-3486-D2	724	34	86	1	58.48	1.69
L-PYGE-3498-D2	786	34	98	1	66.64	1.93
L-PYGE-4262-D2	676	42	62	1	52.08	1.51
L-PYGE-4274-D2	750	42	74	1	62.16	1.80
L-PYGE-4286-D2	826	42	86	1	72.24	2.09
L-PYGE-4298-D2	900	42	98	1	82.32	2.38
L-PYGE-5062-D2	752	50	62	1	62	1.79
L-PYGE-5074-D2	840	50	74	1	74	2.14
L-PYGE-5086-D2	930	50	86	1	86	2.49
L-PYGE-5098-D2	1016	50	98	1	98	2.84
L-PYGE-34110-D2	850	34	110	1	74.8	2.16
L-PYGE-42110-D2	975	42	110	1	92.4	2.67
L-PYGE-50110-D2	1106	50	110	1	110	3.18

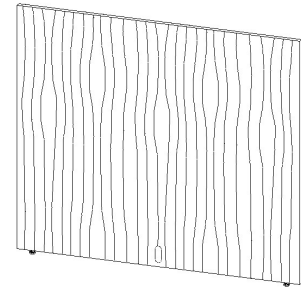

Single piece

Double Span End
Vertical Woodgrain
Gallery Panel
with Power Cutout

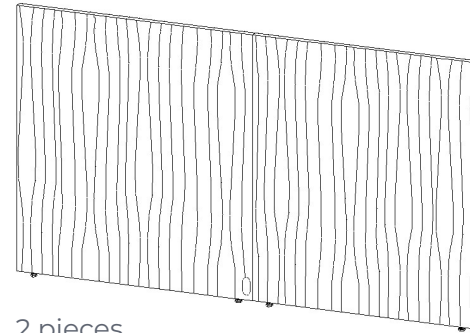

2 pieces

What's Included:

X"-X": One (1) 1"thick laminate gallery panel, two (2) gallery panel top brackets

X"-X": Two (2) 1"thick laminate gallery panel, four (4) gallery panel top brackets

How to Specify:

Refer to laminate cards for laminate selections

Choose option for power cut out or no power cut out

Notes:

Gallery panels come with pre-drilled holes on each side and bottom notch for wire routing

Gallery panels must be used between two standard fabric or laminate panels

Gallery panels must be the same height or lower than the connecting standard fabric or laminate panel

Options:

Height: 34", 42", 50"

Width: 26", 32", 38", 44", 50", 56", 62", 68", 74"

Laminate color

Power cut out, no power cut out

Code	Price	H	W	D	Weight (lb.)	Volume (ft ³)
single piece						
L-PCGE-3442-D1	342	34	42	1	28.56	0.83
L-PCGE-3450-D1	381	34	50	1	34	0.98
L-PCGE-4242-D1	391	42	42	1	28.56	1.02
L-PCGE-4250-D1	441	42	50	1	42	1.22
L-PCGE-5042-D1	441	50	42	1	28.56	1.22
L-PCGE-5050-D1	500	50	50	1	50	1.45
2 pieces						
L-PCGE-3462-D2	600	34	62	1	42.16	1.22
L-PCGE-3474-D2	661	34	74	1	50.32	1.46
L-PCGE-3486-D2	724	34	86	1	58.48	1.69
L-PCGE-3498-D2	786	34	98	1	66.64	1.93
L-PCGE-34110-D2	850	34	110	1	52.08	1.51
L-PCGE-4262-D2	676	42	62	1	62.16	1.80
L-PCGE-4274-D2	750	42	74	1	72.24	2.09
L-PCGE-4286-D2	826	42	86	1	82.32	2.38
L-PCGE-4298-D2	900	42	98	1	62	1.79
L-PCGE-42110-D2	975	42	110	1	74	2.14
L-PCGE-5062-D2	752	50	62	1	86	2.49
L-PCGE-5074-D2	840	50	74	1	98	2.84
L-PCGE-5086-D2	930	50	86	1	74.8	2.16
L-PCGE-5098-D2	1016	50	98	1	92.4	2.67
L-PCGE-50110-D2	1106	50	110	1	110	3.18

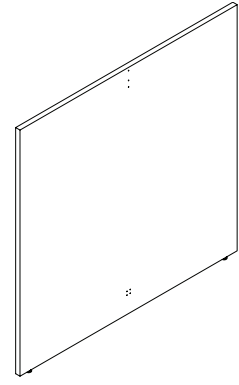

Single Span Middle
Solid Gallery Panel

What's Included:

One (1) 1"thick laminate gallery panel,
two (2) gallery panel top brackets

How to Specify:

Refer to laminate cards for laminate selections

Options:

Height: 34", 42", 50"

Width: 26", 32", 38", 44", 50", 56", 62", 68", 74"

Laminate color

Notes:

Gallery panels come with pre-drilled holes on each side and bottom notch for wire routing

Gallery panels must be used between two standard fabric or laminate panels

Gallery panels must be the same height or lower than the connecting standard fabric or laminate panel

Code	Price	H	W	D	Weight (lb.)	Volume (ft ³)
L-PYSM-3426-S1	302	34	26	1	17.68	0.51
L-PYSM-3432-S1	333	34	32	1	21.76	0.63
L-PYSM-3438-S1	366	34	38	1	25.84	0.75
L-PYSM-3444-S1	393	34	44	1	29.92	0.87
L-PYSM-3450-S1	427	34	50	1	34	0.98
L-PYSM-3456-S1	458	34	56	1	38.08	1.10
L-PYSM-3462-S1	487	34	62	1	42.16	1.22
L-PYSM-3468-S1	518	34	68	1	46.24	1.34
L-PYSM-3474-S1	548	34	74	1	50.32	1.46
L-PYSM-4226-S1	333	42	26	1	21.84	0.63
L-PYSM-4232-S1	373	42	32	1	26.88	0.78
L-PYSM-4238-S1	411	42	38	1	31.92	0.92
L-PYSM-4244-S1	450	42	44	1	36.96	1.07
L-PYSM-4250-S1	486	42	50	1	42	1.22
L-PYSM-4256-S1	521	42	56	1	47.04	1.36
L-PYSM-4262-S1	561	42	62	1	52.08	1.51
L-PYSM-4268-S1	597	42	68	1	57.12	1.65
L-PYSM-4274-S1	637	42	74	1	62.16	1.80
L-PYSM-5026-S1	368	50	26	1	26	0.75
L-PYSM-5032-S1	414	50	32	1	32	0.93
L-PYSM-5038-S1	457	50	38	1	38	1.10
L-PYSM-5044-S1	500	50	44	1	44	1.27
L-PYSM-5050-S1	544	50	50	1	50	1.45
L-PYSM-5056-S1	588	50	56	1	56	1.62
L-PYSM-5062-S1	635	50	62	1	62	1.79
L-PYSM-5068-S1	676	50	68	1	68	1.97
L-PYSM-5074-S1	723	50	74	1	74	2.14

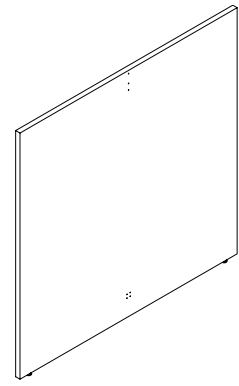

Single piece

Double Span Middle Solid Gallery Panel

What's Included:

X"-X": One (1) 1"thick laminate gallery panel, two (2) gallery panel top brackets

X"-X": Two (2) 1"thick laminate gallery panel, four (4) gallery panel top brackets

How to Specify:

Refer to laminate cards for laminate selections

Notes:

Gallery panels come with pre-drilled holes on each side and bottom notch for wire routing

Gallery panels must be used between two standard fabric or laminate panels

Gallery panels must be the same height or lower than the connecting standard fabric or laminate panel

Options:

Height: 34", 42", 50"

Width: 26", 32", 38", 44", 50", 56", 62", 68", 74"

Laminate color

Power cut out, no power cut out

Code	Price	H	W	D	Weight (lb.)	Volume (ft ³)
single piece						
L-PYSM-3442-D1	386	34	42	1	28.56	0.83
L-PYSM-3450-D1	427	34	50	1	34	0.98
L-PYSM-3462-D1	487	34	62	1	42.16	1.22
L-PYSM-3474-D1	548	34	74	1	50.32	1.46
L-PYSM-3486-D1	611	34	86	1	58.48	1.69
L-PYSM-4242-D1	434	42	42	1	35.28	1.02
L-PYSM-4250-D1	486	42	50	1	42	1.22
L-PYSM-4262-D1	561	42	62	1	52.08	1.51
L-PYSM-4274-D1	637	42	74	1	62.16	1.80
L-PYSM-4286-D1	712	42	86	1	72.24	2.09
L-PYSM-5042-D1	486	50	42	1	42	1.22
L-PYSM-5050-D1	544	50	50	1	50	1.45
L-PYSM-5062-D1	635	50	62	1	62	1.79
L-PYSM-5074-D1	723	50	74	1	74	2.14
L-PYSM-5086-D1	810	50	86	1	86	2.49
2 pieces						
L-PYSM-3498-D2	786	34	98	1	66.64	1.93
L-PYSM-4298-D2	900	42	98	1	82.32	2.38
L-PYSM-5098-D2	1016	50	98	1	98	2.84
L-PYSM-34110-D2	850	34	110	1	74.8	2.16
L-PYSM-34122-D2	910	34	122	1	82.96	2.40
L-PYSM-34134-D2	969	34	134	1	91.12	2.64
L-PYSM-34146-D2	1031	34	146	1	99.28	2.87
L-PYSM-42110-D2	975	42	110	1	92.4	2.67
L-PYSM-42122-D2	1052	42	122	1	102.48	2.97
L-PYSM-42134-D2	1128	42	134	1	112.56	3.26
L-PYSM-42146-D2	1206	42	146	1	122.64	3.55
L-PYSM-50110-D2	1106	50	110	1	110	3.18
L-PYSM-50122-D2	1193	50	122	1	122	3.53
L-PYSM-50134-D2	1286	50	134	1	134	3.88
L-PYSM-50146-D2	1372	50	146	1	146	4.22

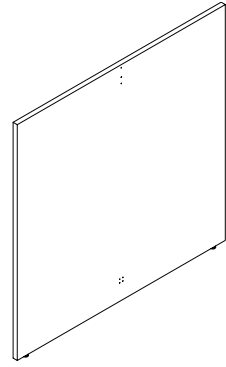

Single Span End Solid Gallery Panel

What's Included:

One (1) 1"thick laminate gallery panel, two (2) gallery panel top brackets

How to Specify:

Refer to laminate cards for laminate selections

Choose option for power cut out or no power cut out

Options:

Height: 34", 42", 50"

Width: 26", 32", 38", 44", 50", 56", 62", 68", 74"

Laminate color

Power cut out, No power cut out

Code	Price	H	W	D	Weight (lb.)	Volume (ft ³)
left hand						
L-PYSE-3426-S1L	260	34	26	1	17.68	0.51
L-PYSE-3432-S1L	291	34	32	1	21.76	0.63
L-PYSE-3438-S1L	322	34	38	1	25.84	0.75
L-PYSE-3444-S1L	352	34	44	1	29.92	0.87
L-PYSE-3450-S1L	381	34	50	1	34	0.98
L-PYSE-3456-S1L	415	34	56	1	38.08	1.10
L-PYSE-3462-S1L	444	34	62	1	42.16	1.22
L-PYSE-3468-S1L	477	34	68	1	46.24	1.34
L-PYSE-3474-S1L	506	34	74	1	50.32	1.46
L-PYSE-4226-S1L	291	42	26	1	21.84	0.63
L-PYSE-4232-S1L	329	42	32	1	26.88	0.78
L-PYSE-4238-S1L	367	42	38	1	31.92	0.92
L-PYSE-4244-S1L	405	42	44	1	36.96	1.07
L-PYSE-4250-S1L	441	42	50	1	42	1.22
L-PYSE-4256-S1L	480	42	56	1	47.04	1.36

Notes:

Gallery panels come with pre-drilled holes on each side and bottom notch for wire routing

Gallery panels must be used between two standard fabric or laminate panels

Gallery panels must be the same height or lower than the connecting standard fabric or laminate panel

Code	Price	H	W	D	Weight (lb.)	Volume (ft ³)
L-PYSE-4262-S1L	517	42	62	1	52.08	1.51
L-PYSE-4268-S1L	554	42	68	1	57.12	1.65
L-PYSE-4274-S1L	590	42	74	1	62.16	1.80
L-PYSE-5026-S1L	324	50	26	1	26	0.75
L-PYSE-5032-S1L	368	50	32	1	32	0.93
L-PYSE-5038-S1L	414	50	38	1	38	1.10
L-PYSE-5044-S1L	458	50	44	1	44	1.27
L-PYSE-5050-S1L	500	50	50	1	50	1.45
L-PYSE-5056-S1L	545	50	56	1	56	1.62
L-PYSE-5062-S1L	588	50	62	1	62	1.79
L-PYSE-5068-S1L	635	50	68	1	68	1.97
L-PYSE-5074-S1L	677	50	74	1	74	2.14
right hand						
L-PYSE-3426-S1R	260	34	26	1	17.68	0.51
L-PYSE-3432-S1R	291	34	32	1	21.76	0.63
L-PYSE-3438-S1R	322	34	38	1	25.84	0.75
L-PYSE-3444-S1R	352	34	44	1	29.92	0.87
L-PYSE-3450-S1R	381	34	50	1	34	0.98
L-PYSE-3456-S1R	415	34	56	1	38.08	1.10
L-PYSE-3462-S1R	444	34	62	1	42.16	1.22
L-PYSE-3468-S1R	477	34	68	1	46.24	1.34
L-PYSE-3474-S1R	506	34	74	1	50.32	1.46
L-PYSE-4226-S1R	291	42	26	1	21.84	0.63
L-PYSE-4232-S1R	329	42	32	1	26.88	0.78
L-PYSE-4238-S1R	367	42	38	1	31.92	0.92
L-PYSE-4244-S1R	405	42	44	1	36.96	1.07
L-PYSE-4250-S1R	441	42	50	1	42	1.22
L-PYSE-4256-S1R	480	42	56	1	47.04	1.36
L-PYSE-4262-S1R	517	42	62	1	52.08	1.51
L-PYSE-4268-S1R	554	42	68	1	57.12	1.65
L-PYSE-4274-S1R	590	42	74	1	62.16	1.80
L-PYSE-5026-S1R	324	50	26	1	26	0.75
L-PYSE-5032-S1R	368	50	32	1	32	0.93
L-PYSE-5038-S1R	414	50	38	1	38	1.10
L-PYSE-5044-S1R	458	50	44	1	44	1.27
L-PYSE-5050-S1R	500	50	50	1	50	1.45
L-PYSE-5056-S1R	545	50	56	1	56	1.62
L-PYSE-5062-S1R	588	50	62	1	62	1.79
L-PYSE-5068-S1R	635	50	68	1	68	1.97
L-PYSE-5074-S1R	677	50	74	1	74	2.14

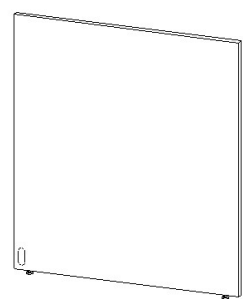

Single Span End Solid Gallery Panel with Power Cutout

What's Included:

One (1) 1"thick laminate gallery panel, two (2) gallery panel top brackets

How to Specify:

Refer to laminate cards for laminate selections

Choose option for power cut out or no power cut out

Options:

Height: 34", 42", 50"

Width: 26", 32", 38", 44", 50", 56", 62", 68", 74"

Laminate color

Power cut out, No power cut out

Notes:

Gallery panels come with pre-drilled holes on each side and bottom notch for wire routing

Gallery panels must be used between two standard fabric or laminate panels

Gallery panels must be the same height or lower than the connecting standard fabric or laminate panel

Code	Price	H	W	D	Weight (lb.)	Volume (ft ³)
left hand						
L-PCSE-3426-S1L	260	34	26	1	17.68	0.51
L-PCSE-3432-S1L	291	34	32	1	21.76	0.63
L-PCSE-3438-S1L	322	34	38	1	25.84	0.75
L-PCSE-3444-S1L	352	34	44	1	29.92	0.87
L-PCSE-3450-S1L	381	34	50	1	34	0.98
L-PCSE-3456-S1L	415	34	56	1	38.08	1.10
L-PCSE-3462-S1L	444	34	62	1	42.16	1.22
L-PCSE-3468-S1L	477	34	68	1	46.24	1.34
L-PCSE-3474-S1L	506	34	74	1	50.32	1.46
L-PCSE-4226-S1L	291	42	26	1	21.84	0.63
L-PCSE-4232-S1L	329	42	32	1	26.88	0.78
L-PCSE-4238-S1L	367	42	38	1	31.92	0.92
L-PCSE-4244-S1L	405	42	44	1	36.96	1.07
L-PCSE-4250-S1L	441	42	50	1	42	1.22
L-PCSE-4256-S1L	480	42	56	1	47.04	1.36

Code	Price	H	W	D	Weight (lb.)	Volume (ft ³)
L-PCSE-4262-S1L	517	42	62	1	52.08	1.51
L-PCSE-4268-S1L	554	42	68	1	57.12	1.65
L-PCSE-4274-S1L	590	42	74	1	62.16	1.80
L-PCSE-5026-S1L	324	50	26	1	26	0.75
L-PCSE-5032-S1L	368	50	32	1	32	0.93
L-PCSE-5038-S1L	414	50	38	1	38	1.10
L-PCSE-5044-S1L	458	50	44	1	44	1.27
L-PCSE-5050-S1L	500	50	50	1	50	1.45
L-PCSE-5056-S1L	545	50	56	1	56	1.62
L-PCSE-5062-S1L	588	50	62	1	62	1.79
L-PCSE-5068-S1L	635	50	68	1	68	1.97
L-PCSE-5074-S1L	677	50	74	1	74	2.14
right hand						
L-PCSE-3426-S1R	260	34	26	1	17.68	0.51
L-PCSE-3432-S1R	291	34	32	1	21.76	0.63
L-PCSE-3438-S1R	322	34	38	1	25.84	0.75
L-PCSE-3444-S1R	352	34	44	1	29.92	0.87
L-PCSE-3450-S1R	381	34	50	1	34	0.98
L-PCSE-3456-S1R	415	34	56	1	38.08	1.10
L-PCSE-3462-S1R	444	34	62	1	42.16	1.22
L-PCSE-3468-S1R	477	34	68	1	46.24	1.34
L-PCSE-3474-S1R	506	34	74	1	50.32	1.46
L-PCSE-4226-S1R	291	42	26	1	21.84	0.63
L-PCSE-4232-S1R	329	42	32	1	26.88	0.78
L-PCSE-4238-S1R	367	42	38	1	31.92	0.92
L-PCSE-4244-S1R	405	42	44	1	36.96	1.07
L-PCSE-4250-S1R	441	42	50	1	42	1.22
L-PCSE-4256-S1R	480	42	56	1	47.04	1.36
L-PCSE-4262-S1R	517	42	62	1	52.08	1.51
L-PCSE-4268-S1R	554	42	68	1	57.12	1.65
L-PCSE-4274-S1R	590	42	74	1	62.16	1.80
L-PCSE-5026-S1R	324	50	26	1	26	0.75
L-PCSE-5032-S1R	368	50	32	1	32	0.93
L-PCSE-5038-S1R	414	50	38	1	38	1.10
L-PCSE-5044-S1R	458	50	44	1	44	1.27
L-PCSE-5050-S1R	500	50	50	1	50	1.45
L-PCSE-5056-S1R	545	50	56	1	56	1.62
L-PCSE-5062-S1R	588	50	62	1	62	1.79
L-PCSE-5068-S1R	635	50	68	1	68	1.97
L-PCSE-5074-S1R	677	50	74	1	74	2.14

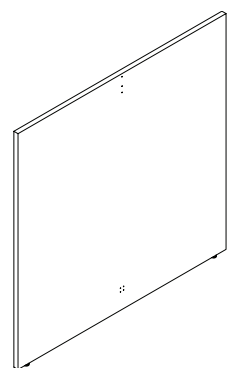

Single piece

Double Span End
Solid Gallery Panel
No Power Cutout

What's Included:

X"-X": One (1) 1"thick laminate gallery panel, two (2) gallery panel top brackets

X"-X": Two (2) 1"thick laminate gallery panel, four (4) gallery panel top brackets

How to Specify:

Refer to laminate cards for laminate selections

Choose option for power cut out or no power cut out

Notes:

Gallery panels come with pre-drilled holes on each side and bottom notch for wire routing

Gallery panels must be used between two standard fabric or laminate panels

Gallery panels must be the same height or lower than the connecting standard fabric or laminate panel

Options:

Height: 34", 42", 50"

Width: 26", 32", 38", 44", 50", 56", 62", 68", 74"

Laminate color

Power cut out, no power cut out

Code	Price	H	W	D	Weight (lb.)	Volume (ft ³)
single piece						
L-PYSE-3442-D1	342	34	42	1	28.56	0.83
L-PYSE-3450-D1	381	34	50	1	34	0.98
L-PYSE-3462-D1	444	34	62	1	42.16	1.22
L-PYSE-3474-D1	506	34	74	1	50.32	1.46
L-PYSE-3486-D1	570	34	86	1	58.48	1.69
L-PYSE-4242-D1	391	42	42	1	35.28	1.02
L-PYSE-4250-D1	441	42	50	1	42	1.22
L-PYSE-4262-D1	517	42	62	1	52.08	1.51
L-PYSE-4274-D1	590	42	74	1	62.16	1.80
L-PYSE-4286-D1	670	42	86	1	72.24	2.09
L-PYSE-5042-D1	441	50	42	1	42	1.22
L-PYSE-5050-D1	500	50	50	1	50	1.45
L-PYSE-5062-D1	588	50	62	1	62	1.79
L-PYSE-5074-D1	677	50	74	1	74	2.14
L-PYSE-5086-D1	767	50	86	1	86	2.49
2 pieces						
L-PYSE-3498-D2	786	34	98	1	66.64	1.93
L-PYSE-4298-D2	900	42	98	1	82.32	2.38
L-PYSE-5098-D2	1016	50	98	1	98	2.84
L-PYSE-34110-D2	850	34	110	1	74.8	2.16
L-PYSE-34122-D2	910	34	122	1	82.96	2.40
L-PYSE-34134-D2	969	34	134	1	91.12	2.64
L-PYSE-34146-D2	1031	34	146	1	99.28	2.87
L-PYSE-42110-D2	975	42	110	1	92.4	2.67
L-PYSE-42122-D2	1052	42	122	1	102.48	2.97
L-PYSE-42134-D2	1128	42	134	1	112.56	3.26
L-PYSE-42146-D2	1206	42	146	1	122.64	3.55
L-PYSE-50110-D2	1106	50	110	1	110	3.18
L-PYSE-50122-D2	1193	50	122	1	122	3.53
L-PYSE-50134-D2	1286	50	134	1	134	3.88
L-PYSE-50146-D2	1372	50	146	1	146	4.22

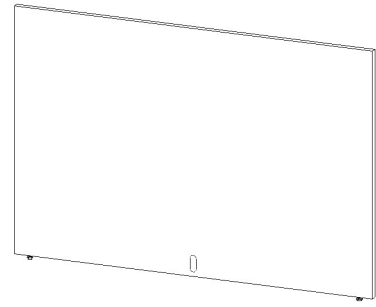

Single piece

Double Span End Solid Gallery Panel with Power Cutout

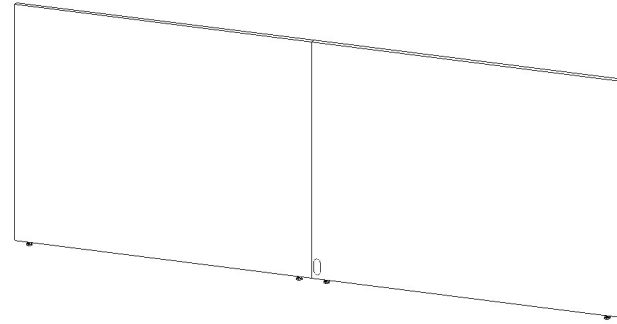

2 pieces

What's Included:

X"-X": One (1) 1"thick laminate gallery panel, two (2) gallery panel top brackets

X"-X": Two (2) 1"thick laminate gallery panel, four (4) gallery panel top brackets

How to Specify:

Refer to laminate cards for laminate selections

Choose option for power cut out or no power cut out

Notes:

Gallery panels come with pre-drilled holes on each side and bottom notch for wire routing

Gallery panels must be used between two standard fabric or laminate panels

Gallery panels must be the same height or lower than the connecting standard fabric or laminate panel

Options:

Height: 34", 42", 50"

Width: 26", 32", 38", 44", 50", 56", 62", 68", 74"

Laminate color

Power cut out, no power cut out

Code	Price	H	W	D	Weight (lb.)	Volume (ft ³)
single piece						
L-PCSE-3442-D1	342	34	42	1	28.6	0.80
L-PCSE-3450-D1	381	34	50	1	34	1.00
L-PCSE-3462-D1	444	34	62	1	42.2	1.20
L-PCSE-3474-D1	506	34	74	1	50.3	1.50
L-PCSE-3486-D1	570	34	86	1	58.5	1.70
L-PCSE-4242-D1	391	42	42	1	35.3	1.00
L-PCSE-4250-D1	441	42	50	1	42	1.20
L-PCSE-4262-D1	517	42	62	1	52.1	1.50
L-PCSE-4274-D1	590	42	74	1	62.2	1.80
L-PCSE-4286-D1	670	42	86	1	72.2	2.10
L-PCSE-5042-D1	441	50	42	1	42	1.20
L-PCSE-5050-D1	500	50	50	1	50	1.40
L-PCSE-5062-D1	588	50	62	1	62	1.80
L-PCSE-5074-D1	677	50	74	1	74	2.10
L-PCSE-5086-D1	767	50	86	1	86	2.50
2 pieces						
L-PCSE-3498-D2	786	34	98	1	66.6	1.90
L-PCSE-34110-D2	850	34	110	1	82.3	2.40
L-PCSE-34122-D2	910	34	122	1	98	2.80
L-PCSE-34134-D2	969	34	134	1	74.8	2.20
L-PCSE-34146-D2	1031	34	146	1	83	2.40
L-PCSE-4298-D2	900	42	98	1	91.1	2.60
L-PCSE-42110-D2	975	42	110	1	99.3	2.90
L-PCSE-42122-D2	1052	42	122	1	92.4	2.70
L-PCSE-42134-D2	1128	42	134	1	102.5	3.00
L-PCSE-42146-D2	1206	42	146	1	112.6	3.30
L-PCSE-5098-D2	1016	50	98	1	122.6	3.50
L-PCSE-50110-D2	1106	50	110	1	110	3.20
L-PCSE-50122-D2	1193	50	122	1	122	3.50
L-PCSE-50134-D2	1286	50	134	1	134	3.90
L-PCSE-50146-D2	1372	50	146	1	146	4.20

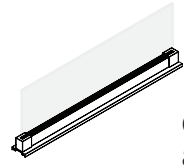

Glass Frameless Blade for Standard and Elevated Panels

Double span panel top mounted privacy screen can be placed across the width of two equal sized panels

What's Included:

One (1) tempered glass piece, One (1) channel extrusion, Two (2) end caps, One (1) top trim

How to Specify:

Refer to metal finish card for metal finish options

Notes:

One (1) glass piece can span the width of one or two panels up to 72"W

Glass is tempered

Options:

Height: 8", 16", 20"

Width: 24", 30", 36", 42", 48", 54", 60", 66", 72"

Clear, Frosted

Code	Price	H	W	D	Weight (lb.)	Volume (ft ³)
Glass screen - Clear						
L-VG-P-0824-C	494	8	24	0.75		
L-VG-P-0830-C	523	8	30	0.75		
L-VG-P-0836-C	572	8	36	0.75		
L-VG-P-0842-C	611	8	42	0.75		
L-VG-P-0848-C	617	8	48	0.75		
L-VG-P-0854-C	666	8	54	0.75		
L-VG-P-0860-C	676	8	60	0.75		
L-VG-P-0866-C	725	8	66	0.75		
L-VG-P-0872-C	732	8	72	0.75		
L-VG-P-1624-C	536	16	24	0.75		
L-VG-P-1630-C	570	16	30	0.75		
L-VG-P-1636-C	622	16	36	0.75		
L-VG-P-1642-C	665	16	42	0.75		
L-VG-P-1648-C	673	16	48	0.75		
L-VG-P-1654-C	725	16	54	0.75		
L-VG-P-1660-C	729	16	60	0.75		

Code	Price	H	W	D	Weight (lb.)	Volume (ft ³)
L-VG-P-1666-C	765	16	66	0.75		
L-VG-P-1672-C	795	16	72	0.75		
L-VG-P-2024-C	573	20	24	0.75		
L-VG-P-2030-C	614	20	30	0.75		
L-VG-P-2036-C	693	20	36	0.75		
L-VG-P-2042-C	738	20	42	0.75		
L-VG-P-2048-C	742	20	48	0.75		
L-VG-P-2054-C	795	20	54	0.75		
L-VG-P-2060-C	805	20	60	0.75		
L-VG-P-2066-C	847	20	66	0.75		
L-VG-P-2072-C	862	20	72	0.75		

Code	Price	H	W	D	Weight (lb.)	Volume (ft ³)
Glass screen - Frosted						
L-VG-P-0824-F	641	8	24	0.75		
L-VG-P-0830-F	678	8	30	0.75		
L-VG-P-0836-F	742	8	36	0.75		
L-VG-P-0842-F	795	8	42	0.75		
L-VG-P-0848-F	803	8	48	0.75		
L-VG-P-0854-F	866	8	54	0.75		
L-VG-P-0860-F	873	8	60	0.75		
L-VG-P-0866-F	933	8	66	0.75		
L-VG-P-0872-F	950	8	72	0.75		
L-VG-P-1624-F	698	16	24	0.75		
L-VG-P-1630-F	739	16	30	0.75		
L-VG-P-1636-F	808	16	36	0.75		
L-VG-P-1642-F	864	16	42	0.75		
L-VG-P-1648-F	873	16	48	0.75		
L-VG-P-1654-F	943	16	54	0.75		
L-VG-P-1660-F	948	16	60	0.75		
L-VG-P-1666-F	1014	16	66	0.75		
L-VG-P-1672-F	1034	16	72	0.75		
L-VG-P-2024-F	743	20	24	0.75		
L-VG-P-2030-F	799	20	30	0.75		
L-VG-P-2036-F	900	20	36	0.75		
L-VG-P-2042-F	958	20	42	0.75		
L-VG-P-2048-F	963	20	48	0.75		
L-VG-P-2054-F	1034	20	54	0.75		
L-VG-P-2060-F	1046	20	60	0.75		
L-VG-P-2066-F	1102	20	66	0.75		
L-VG-P-2072-F	1121	20	72	0.75		

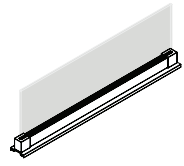

Acrylic Frameless Blade for Standard and Elevated Panels

What's Included:

One (1) acrylic piece, One (1) channel extrusion, Two (2) end caps, One (1) top trim

How to Specify:

Refer to metal finish card for metal finish options

Options:

Height: 8", 16"

Width: 24", 30", 36", 42", 48", 54", 60", 66", 72"

Clear, Frosted

Notes:

One (1) acrylic piece can span the width of one or two panels up to 72"W

Code	Price	H	W	D	Weight (lb.)	Volume (ft ³)
Acrylic screen - Frosted						
L-VA-P-0824-F	641	8	24	0.75		
L-VA-P-0830-F	678	8	30	0.75		
L-VA-P-0836-F	742	8	36	0.75		
L-VA-P-0842-F	795	8	42	0.75		
L-VA-P-0848-F	803	8	48	0.75		
L-VA-P-0854-F	866	8	54	0.75		
L-VA-P-0860-F	873	8	60	0.75		
L-VA-P-0866-F	933	8	66	0.75		
L-VA-P-0872-F	950	8	72	0.75		
L-VA-P-1624-F	698	16	24	0.75		
L-VA-P-1630-F	739	16	30	0.75		
L-VA-P-1636-F	808	16	36	0.75		
L-VA-P-1642-F	864	16	42	0.75		
L-VA-P-1648-F	873	16	48	0.75		
L-VA-P-1654-F	943	16	54	0.75		
L-VA-P-1660-F	948	16	60	0.75		
L-VA-P-1666-F	1014	16	66	0.75		
L-VA-P-1672-F	1034	16	72	0.75		

Code	Price	H	W	D	Weight (lb.)	Volume (ft ³)
Acrylic screen - Clear						
L-VA-P-0824-C	494	8	24	0.75		
L-VA-P-0830-C	523	8	30	0.75		
L-VA-P-0836-C	572	8	36	0.75		
L-VA-P-0842-C	611	8	42	0.75		
L-VA-P-0848-C	617	8	48	0.75		
L-VA-P-0854-C	666	8	54	0.75		
L-VA-P-0860-C	673	8	60	0.75		
L-VA-P-0866-C	725	16	66	0.75		
L-VA-P-0872-C	732	16	72	0.75		
L-VA-P-1624-C	536	16	24	0.75		
L-VA-P-1630-C	570	16	30	0.75		
L-VA-P-1636-C	622	16	36	0.75		
L-VA-P-1642-C	665	16	42	0.75		
L-VA-P-1648-C	673	16	48	0.75		
L-VA-P-1654-C	725	16	54	0.75		
L-VA-P-1660-C	729	16	60	0.75		
L-VA-P-1666-C	765	16	66	0.75		
L-VA-P-1672-C	795	16	72	0.75		

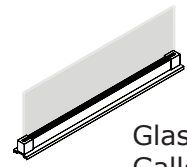

Glass Frameless Blade for Gallery Panels

What's Included:

One (1) tempered glass piece, One (1) accessory rail channel extrusion, Two (2) end caps

How to Specify:

Refer to metal finish card for metal finish options

Notes:

One (1) glass piece can span the width of one or two panels up to 72"W

Glass is tempered

Accessory rail channel extrusion can accommodate all Tayco accessories except for the paper sorter

Options:

Height: 8", 16"

Width: 24", 30", 36", 42", 48", 54", 60"

Clear, Frosted

Code	Price	H	W	D	Weight (lb.)	Volume (ft ³)
Glass screen - Frosted						
L-VG-Y-0824-F	739	8	24	0.75	5	0.08
L-VG-Y-0830-F	777	8	30	0.75	6	0.10
L-VG-Y-0836-F	838	8	36	0.75	7	0.13
L-VG-Y-0842-F	895	8	42	0.75	8	0.15
L-VG-Y-0848-F	900	8	48	0.75	10	0.17
L-VG-Y-0854-F	963	8	54	0.75	11	0.19
L-VG-Y-0860-F	971	8	60	0.75	12	0.21
L-VG-Y-1624-F	795	16	24	0.75	10	0.17
L-VG-Y-1630-F	836	16	30	0.75	12	0.21
L-VG-Y-1636-F	906	16	36	0.75	14	0.25
L-VG-Y-1642-F	962	16	42	0.75	17	0.29
L-VG-Y-1648-F	971	16	48	0.75	19	0.33
L-VG-Y-1654-F	1041	16	54	0.75	22	0.38
L-VG-Y-1660-F	1045	16	60	0.75	24	0.42

Code	Price	H	W	D	Weight (lb.)	Volume (ft ³)
Glass screen - Clear						
L-VG-Y-0824-C	641	8	30	0.75	6	0.10
L-VG-Y-0830-C	678	8	36	0.75	7	0.13
L-VG-Y-0836-C	742	8	42	0.75	8	0.15
L-VG-Y-0842-C	795	8	48	0.75	10	0.17
L-VG-Y-0848-C	803	8	54	0.75	11	0.19
L-VG-Y-0854-C	866	8	60	0.75	12	0.21
L-VG-Y-0860-C	873	16	24	0.75	10	0.17
L-VG-Y-1624-C	698	16	30	0.75	12	0.21
L-VG-Y-1630-C	739	16	36	0.75	14	0.25
L-VG-Y-1636-C	808	16	42	0.75	17	0.29
L-VG-Y-1642-C	864	16	48	0.75	19	0.33
L-VG-Y-1648-C	873	16	54	0.75	22	0.38
L-VG-Y-1654-C	943	16	60	0.75	24	0.42
L-VG-Y-1660-C	948	16	60	0.75	24	0.42

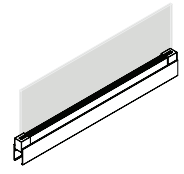

Acrylic Frameless Blade for Gallery Panels

What's Included:

One (1) acrylic piece, One (1) accessory rail channel extrusion, Two (2) end caps

How to Specify:

Refer to metal finish card for metal finish options

Notes:

One (1) acrylic piece can span the width of one or two panels up to 72"W

Accessory rail channel extrusion can accommodate all Tayco accessories except for the paper sorter

Options:

Height:	8", 16"
Width:	24", 30", 36", 42", 48", 54", 60"
Clear, Frosted	

Code	Price	H	W	D	Weight (lb.)	Volume (ft ³)
Acrylic screen - Frosted						
L-VA-Y-0824-F	739	8	24	0.75	4	0.08
L-VA-Y-0830-F	777	8	30	0.75	5	0.10
L-VA-Y-0836-F	838	8	36	0.75	5	0.13
L-VA-Y-0842-F	895	8	42	0.75	6	0.15
L-VA-Y-0848-F	900	8	48	0.75	7	0.17
L-VA-Y-0854-F	963	8	54	0.75	8	0.19
L-VA-Y-0860-F	971	8	60	0.75	9	0.21
L-VA-Y-1624-F	795	16	24	0.75	7	0.17
L-VA-Y-1630-F	836	16	30	0.75	9	0.21
L-VA-Y-1636-F	906	16	36	0.75	11	0.25
L-VA-Y-1642-F	962	16	42	0.75	13	0.29
L-VA-Y-1648-F	971	16	48	0.75	14	0.33
L-VA-Y-1654-F	1041	16	54	0.75	16	0.38
L-VA-Y-1660-F	1045	16	60	0.75	18	0.42

Code	Price	H	W	D	Weight (lb.)	Volume (ft ³)
Acrylic screen - Clear						
L-VA-Y-0824-C	641	8	24	0.75	4	0.08
L-VA-Y-0830-C	678	8	30	0.75	5	0.10
L-VA-Y-0836-C	742	8	36	0.75	5	0.13
L-VA-Y-0842-C	795	8	42	0.75	6	0.15
L-VA-Y-0848-C	803	8	48	0.75	7	0.17
L-VA-Y-0854-C	866	8	54	0.75	8	0.19
L-VA-Y-0860-C	873	8	60	0.75	9	0.21
L-VA-Y-1624-C	698	16	24	0.75	7	0.17
L-VA-Y-1630-C	739	16	30	0.75	9	0.21
L-VA-Y-1636-C	808	16	36	0.75	11	0.25
L-VA-Y-1642-C	864	16	42	0.75	13	0.29
L-VA-Y-1648-C	873	16	48	0.75	14	0.33
L-VA-Y-1654-C	943	16	54	0.75	16	0.38
L-VA-Y-1660-C	948	16	60	0.75	18	0.42

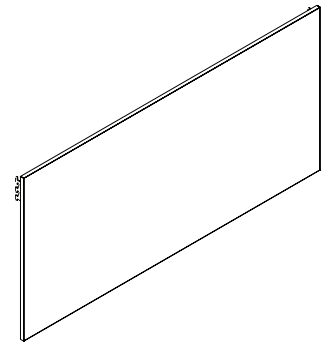

Panel Mounted Whiteboard

What's Included:

One (1) whiteboard, Two (2) slotted channel brackets

How to Specify:

Specify width of whiteboard to match the width of the panel
Choose White, Black, Silver, Charcoal for bracket color

Options:

Height: 15"

Width: 24", 30", 36", 42", 48", 54", 60"

Notes:

Panel Mounted Whiteboard is compatible with fabric and laminate panels only

Code	Price	H	W	D	Weight (lb.)	Volume (ft ³)
L-AWP0-1524	321	15	24	0.75	3.74	
L-AWP0-1530	353	15	30	0.75	4.86	
L-AWP0-1536	387	15	36	0.75	6.22	
L-AWP0-1542	421	15	42	0.75	7.48	
L-AWP0-1548	455	15	48	0.75	8.72	
L-AWP0-1554	487	15	54	0.75	9.96	
L-AWP0-1560	519	15	60	0.75	11.22	

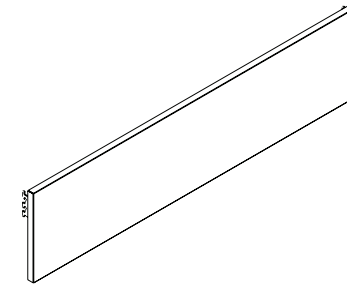

Panel Mounted Tackboard

What's Included:

One (1) tackboard, Two (2) slotted channel brackets

How to Specify:

Specify width of tackboard to match the width of the panel
Refer to panel fabric cards for fabric selections
Choose White, Black, Silver, Charcoal for bracket color

Options:

Height: 7", 15"

Width: 24", 30", 36", 42", 48", 54", 60"

Notes:

Panel Mounted Tackboard is compatible with fabric and laminate panels only

Code	Price	H	W	D	Weight (lb.)	Volume (ft ³)
L-ATP0-0724	295	7	24	0.75	1.87	
L-ATP0-0730	302	7	30	0.75	2.43	
L-ATP0-0736	310	7	36	0.75	3.11	
L-ATP0-0742	321	7	42	0.75	3.74	
L-ATP0-0748	328	7	48	0.75	4.36	
L-ATP0-0754	334	7	54	0.75	4.98	
L-ATP0-0760	344	7	60	0.75	5.61	
L-ATP0-1524	334	15	24	0.75	4	
L-ATP0-1530	353	15	30	0.75	4.86	
L-ATP0-1536	369	15	36	0.75	6.22	
L-ATP0-1542	387	15	42	0.75	7.48	
L-ATP0-1548	403	15	48	0.75	8.72	
L-ATP0-1554	421	15	54	0.75	9.96	
L-ATP0-1560	435	15	60	0.75	11.22	

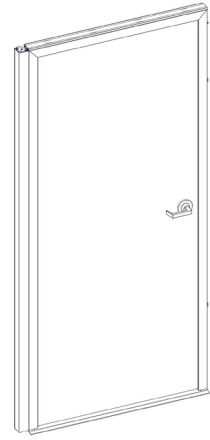

Hinged Door

What's Included:

Hinged Door laminate available in white and black

How to Specify:

Options:

Height: 82"

Width: 36", 42",

Left handed, Right handed

Straight connection, 90 degree connection, 3-way connection and 4-way connection

Notes:

Code	Price	H	W	D	Weight (lb.)	Volume (ft ³)
Straight connection						
L-PD00-8236-L	3740	82	36			
L-PD00-8236-R	3740	82	36			
L-PD00-8242-L	3812	82	42			
L-PD00-8242-R	3812	82	42			
3-way connection						
L-PD00-8236-L-3W	4532	82	36			
L-PD00-8236-R-3W	4532	82	36			
L-PD00-8242-L-3W	4604	82	42			
L-PD00-8242-R-3W	4604	82	42			
4-way connection						
L-PD00-8236-L-4W	4274	82	36			
L-PD00-8236-R-4W	4274	82	36			
L-PD00-8242-L-4W	4346	82	42			
L-PD00-8242-R-4W	4346	82	42			
90 degree connection						
L-PD00-8236-L-90	4293	82	36			
L-PD00-8236-R-90	4293	82	36			
L-PD00-8242-L-90	4365	82	42			
L-PD00-8242-R-90	4365	82	42			

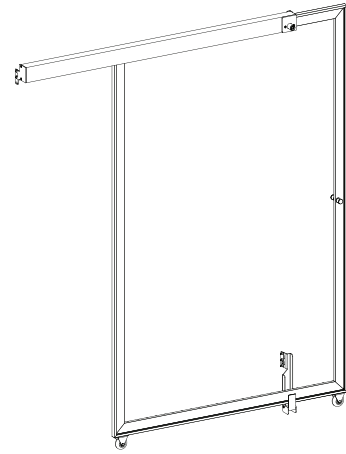

Sliding Door - Acrylic

What's Included:

Sliding door acrylic available in white and black

How to Specify:

Notes:

Options:

Height:	66"
Bracket Width:	30", 36", 42", 48", 54", 60"
Door Width:	30", 36", 42"
Left handed, Right handed	
Clear, Frosted, Fluted	

Code	Price	H	W	D	Weight (lb.)	Volume (ft ³)
Clear Acrylic - left hand						
L-PDSC-663030-L	2512	66	30			
L-PDSC-663036-L	2526	66	36			
L-PDSC-663042-L	2534	66	42			
L-PDSC-663048-L	2541	66	48			
L-PDSC-663054-L	2548	66	54			
L-PDSC-663060-L	2555	66	60			
L-PDSC-663636-L	2521	66	36			
L-PDSC-663642-L	2535	66	42			
L-PDSC-663648-L	2542	66	48			
L-PDSC-663654-L	2550	66	54			
L-PDSC-663660-L	2556	66	60			
L-PDSC-664242-L	2530	66	42			
L-PDSC-664248-L	2544	66	48			
L-PDSC-664254-L	2552	66	54			
L-PDSC-664260-L	2557	66	60			
Clear Acrylic - right hand						
L-PDSC-663030-R	2512	66	30			
L-PDSC-663036-R	2526	66	36			
L-PDSC-663042-R	2534	66	42			
L-PDSC-663048-R	2541	66	48			
L-PDSC-663054-R	2548	66	54			
L-PDSC-663060-R	#N/A	66	60			
L-PDSC-663636-R	2521	66	36			
L-PDSC-663642-R	2535	66	42			
L-PDSC-663648-R	2542	66	48			
L-PDSC-663654-R	2550	66	54			
L-PDSC-663660-R	2556	66	60			
L-PDSC-664242-R	2530	66	42			
L-PDSC-664248-R	2544	66	48			
L-PDSC-664254-R	2552	66	54			
L-PDSC-664260-R	2557	66	60			

Code	Price	H	W	D	Weight (lb.)	Volume (ft ³)
Frosted Acrylic - left hand						
L-PDSF-663030-L	2765	66	30			
L-PDSF-663036-L	2779	66	36			
L-PDSF-663042-L	2786	66	42			
L-PDSF-663048-L	2794	66	48			
L-PDSF-663054-L	2801	66	54			
L-PDSF-663060-L	2808	66	60			
L-PDSF-663636-L	2773	66	36			
L-PDSF-663642-L	2787	66	42			
L-PDSF-663648-L	2795	66	48			
L-PDSF-663654-L	2802	66	54			
L-PDSF-663660-L	2809	66	60			
L-PDSF-664242-L	2784	66	42			
L-PDSF-664248-L	2797	66	48			
L-PDSF-664254-L	2805	66	54			
L-PDSF-664260-L	2813	66	60			
Frosted Acrylic - right hand						
L-PDSF-663030-R	2765	66	30			
L-PDSF-663036-R	2779	66	36			
L-PDSF-663042-R	2786	66	42			
L-PDSF-663048-R	2794	66	48			
L-PDSF-663054-R	2801	66	54			
L-PDSF-663060-R	2808	66	60			
L-PDSF-663636-R	2773	66	36			
L-PDSF-663642-R	2787	66	42			
L-PDSF-663648-R	2795	66	48			
L-PDSF-663654-R	2802	66	54			
L-PDSF-663660-R	2809	66	60			
L-PDSF-664242-R	2784	66	42			
L-PDSF-664248-R	2797	66	48			
L-PDSF-664254-R	2805	66	54			
L-PDSF-664260-R	2813	66	60			

Code	Price	H	W	D	Weight (lb.)	Volume (ft ³)
Fluted acrylic - left hand						
L-PDSL-663030-L	2512	66	30			
L-PDSL-663036-L	2526	66	36			
L-PDSL-663042-L	2534	66	42			
L-PDSL-663048-L	2541	66	48			
L-PDSL-663054-L	2548	66	54			
L-PDSL-663060-L	2555	66	60			
L-PDSL-663636-L	2521	66	36			
L-PDSL-663642-L	2535	66	42			
L-PDSL-663648-L	2542	66	48			
L-PDSL-663654-L	2550	66	54			
L-PDSL-663660-L	2556	66	60			
L-PDSL-664242-L	2530	66	42			
L-PDSL-664248-L	2544	66	48			
L-PDSL-664254-L	2552	66	54			
L-PDSL-664260-L	2557	66	60			
Fluted acrylic - right hand						
L-PDSL-663030-R	2512	66	30			
L-PDSL-663036-R	2526	66	36			
L-PDSL-663042-R	2534	66	42			
L-PDSL-663048-R	2541	66	48			
L-PDSL-663054-R	2548	66	54			
L-PDSL-663060-R	2555	66	60			
L-PDSL-663636-R	2521	66	36			
L-PDSL-663642-R	2535	66	42			
L-PDSL-663648-R	2542	66	48			
L-PDSL-663654-R	2550	66	54			
L-PDSL-663660-R	2556	66	60			
L-PDSL-664242-R	2530	66	42			
L-PDSL-664248-R	2544	66	48			
L-PDSL-664254-R	2552	66	54			
L-PDSL-664260-R	2557	66	60			



Switch Canada Pricebook
April 2025

Connections & Trims

Connections & Trims

2-Way Connection	118
3-Way T Connection	119
4-Way X Connection	120
Top Cap	121
Full Height End Trim	122
Partial Height End Trim	123
Full Height T Filler	124
Partial Height T Filler	125
90 Degree Filler-Full Height	126
90 Degree Filler- Partial Height	127
Straight Filler	128
Gallery Panel Filler	129
Adjustable Wall Connector	130

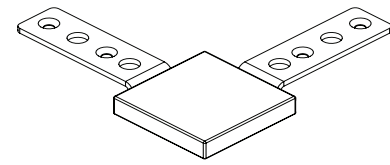

2-Way 90 degree Connection

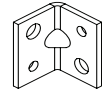

What's Included:

One (1) type A or type B straight or 90 degree connection bracket, accompanying screws

How to Specify:

Refer to page X for connection type application guide

Code	Price	H	W	D	Weight (lb.)	Volume (ft ³)
2-Way Straight Connection						
L-HC2W-180-A	23	1	2	3	0.02	0.00
L-HC2W-180-B	21	1	2	3	0.02	0.00
2-Way 90 degree Connection						
L-HC2W-90-A	54	1	2	3	0.02	0.00
L-HC2W-90-B	54	1	2	3	0.02	0.00

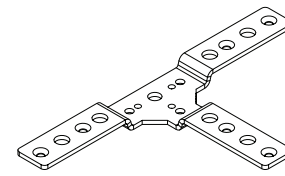

L-HC3W-A

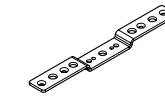

L-HC3W-B

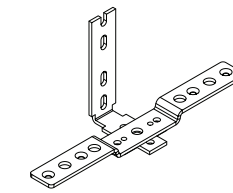

L-HC3W-C

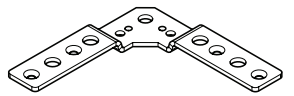

L-HC3W-D

What's Included:

One (1) type A or type B straight or 90 degree connection bracket, accompanying screws

How to Specify:

Refer to page X for connection type application guide

Notes:

Code	Price	H	W	D	Weight (lb.)	Volume (ft ³)
3 Way T Connectors						
L-HC3W-A	91	1	2	3	0.02	0.00
L-HC3W-B	118	1	2	3	0.02	0.00
L-HC3W-C	86	1	2	3	0.02	0.00
L-HC3W-D	113	1	2	3	0.02	0.00

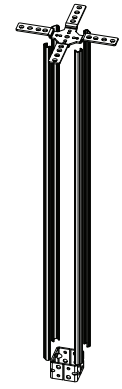

L-HC4W-A

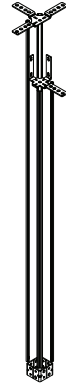

L-HC4W-B

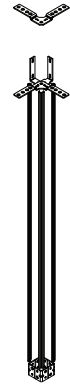

L-HC4W-C

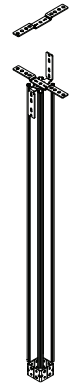

L-HC4W-D

What's Included:

One (1) type A, B, C or D 4-Way X connection bracket, accompanying screws

How to Specify:

Refer to page X for connection type application guide

Notes:

Code	Price	H	W	D	Weight (lb.)	Volume (ft ³)
4 way connectors						
L-HC4W-A	145	1	2	3	0.02	0.00
L-HC4W-B	184	1	2	3	0.02	0.00
L-HC4W-C	166	1	2	3	0.02	0.00
L-HC4W-D	172	1	2	3	0.02	0.00

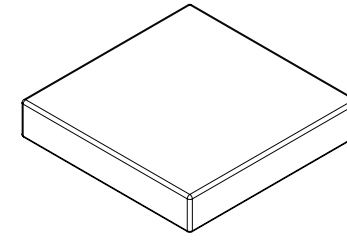

What's Included:

One (1) Top Cap

How to Specify:

Choose White, Black, Silver, Charcoal for Top Cap

Options:

Width: 2"

Depth: 2"

Notes:

Code	Price	H	W	D	Weight (lb.)	Volume (ft ³)
L-HUFC-02	11	1	2	2	0.02	0.00

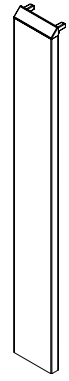

Standard

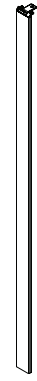

with coat hook

What's Included:

One (1) Full Height End Trim

How to Specify:

Choose White, Black, Silver, Charcoal for Full Height End Trim Colour

Options:

Height: 34", 42", 50", 66", 82"

Width: 2"

Standard, Coat Hook

Notes:

Code	Price	H	W	D	Weight (lb.)	Volume (ft ³)
standard						
L-HETF-34	85	34	2	1	0.68	0.04
L-HETF-42	86	42	2	1	0.84	0.05
L-HETF-50	91	50	2	1	1	0.06
L-HETF-66	109	66	2	1	1.32	0.08
L-HETF-82	206	82	2	2	1.32	0.19
with coat hook						
L-HETF-34-CH	101	34	2	1	0.68	0.04
L-HETF-42-CH	107	42	2	1	0.84	0.05
L-HETF-50-CH	116	50	2	1	1	0.06
L-HETF-66-CH	139	66	2	1	1.32	0.08

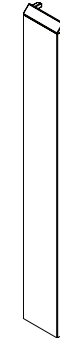

What's Included:

One (1) Partial Height End Trim

How to Specify:

Choose White, Black, Silver, Charcoal for Partial Height End Trim Colour

Options:

Height: 8", 16", 24", 32", 40", 48"

Width: 2"

Notes:

Code	Price	H	W	D	Weight (lb.)	Volume (ft ³)
L-HETP-08	77	8	2	1	0.16	0.01
L-HETP-16	82	16	2	1	0.32	0.02
L-HETP-24	83	24	2	1	0.48	0.03
L-HETP-32	85	32	2	1	0.64	0.04
L-HETP-40	156	40	2	1	0.72	0.05
L-HETP-48	170	48	2	1	0.84	0.06



Full Height T Filler

What's Included:

One (1) Full Height T Filler

How to Specify:

Choose White, Black, Silver, Charcoal for Full Height T Filler

Options:

Height: 34", 42", 50", 66", 82"
 Width: 2"

Notes:

Code	Price	H	W	D	Weight (lb.)	Volume (ft ³)
L-HFTR-34	192	34	2	1	0.68	0.04
L-HFTR-42	192	42	2	1	0.84	0.05
L-HFTR-50	201	50	2	1	1	0.06
L-HFTR-66	201	66	2	1	1.32	0.08
L-HFTR-82	391	82	2	1	1.64	0.09

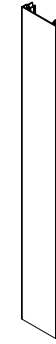

Partial Height T Filler

What's Included:

One (1) Partial Height T Filler

How to Specify:

Choose White, Black, Silver, Charcoal for Partial Height T Filler

Options:

Height: 8", 16", 24", 32", 40", 48"
 Width: 2"

Notes:

Code	Price	H	W	D	Weight (lb.)	Volume (ft ³)
L-HFTP-08	150	8	2	1	0.16	0.01
L-HFTP-16	150	16	2	1	0.32	0.02
L-HFTP-24	156	24	2	1	0.48	0.03
L-HFTP-32	156	32	2	1	0.64	0.04
L-HFTP-40	255	40	2	1	0.72	0.05



Full Height 90 Degree Filler

What's Included:

One (1) Full Height 90 Degree Filler

How to Specify:

Choose White, Black, Silver, Charcoal for Full Height 90 Degree Filler

Options:

Height: 34", 42", 50", 66", 82"
 Width: 2"

Notes:

Code	Price	H	W	D	Weight (lb.)	Volume (ft ³)
L-HFNR-34	157	34	2	1	0.68	0.04
L-HFNR-42	166	42	2	1	0.72	0.05
L-HFNR-50	177	50	2	1	1	0.06
L-HFNR-66	192	66	2	1	1.32	0.08
L-HFNR-82	391	82	2	1	1.64	0.09



Partial Height 90 Degree Filler

What's Included:

One (1) Partial Height 90 Degree Filler

How to Specify:

Choose White, Black, Silver, Charcoal for Partial Height 90 Degree Filler

Options:

Height: 8", 16", 24", 32", 40", 48"
 Width: 2"

Notes:

Code	Price	H	W	D	Weight (lb.)	Volume (ft ³)
L-HFNP-08	66	8	2	1	0.16	0.01
L-HFNP-16	114	16	2	1	0.32	0.02
L-HFNP-24	124	24	2	1	0.48	0.03
L-HFNP-32	168	32	2	1	0.64	0.04
L-HFNP-40	255	40	2	1	0.72	0.05
L-HFNP-48	271	48	2	1	0.84	0.05

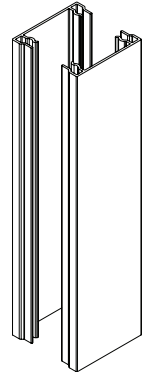

What's Included:

Partial Height Straight Filler

How to Specify:

Choose White, Black, Silver, Charcoal for Partial Height Straight Filler

Options:

Height: 8", 16", 24", 32", 40", 48"
 Width: 2"

Notes:

Code	Price	H	W	D	Weight (lb.)	Volume (ft ³)
L-HFSP-08	50	8	2	1	0.16	0.01
L-HFSP-16	86	16	2	1	0.32	0.02
L-HFSP-24	93	24	2	1	0.48	0.03
L-HFSP-32	96	32	2	1	0.64	0.04
L-HFSP-40	255	40	2	1	0.8	0.05
L-HFSP-48	271	48	2	1	0.96	0.06

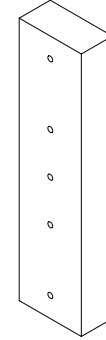

Partial Height Gallery Panel Filler

What's Included:

One (1)Partial Height Gallery Panel Filler

How to Specify:

Gallery Panel Filler matches laminate finish chosen on Gallery Panel

Options:

Height: 8", 16", 24", 32", 40", 48"
 Width: 2"
 Thickness: 1"

Notes:

Code	Price	H	W	D	Weight (lb.)	Volume (ft ³)
L-HYP-08	77	8	1	1	0.08	0.00
L-HYP-16	82	16	1	1	0.16	0.01
L-HYP-24	103	24	1	1	0.24	0.01
L-HYP-32	121	32	1	1	0.32	0.02
L-HYP-40	255	40	1	1	0.44	0.03
L-HYP-48	271	48	1	1	0.56	0.04



138



mount 4



mount 6

Code	Price	H	W	D	Weight (lb.)	Volume (ft ³)
mount 2						
L-HW2-34	135	34	2	2	1.36	0.08
L-HW2-42	162	42	2	2	1.68	0.10
L-HW2-50	191	50	2	2	2	0.12
L-HW2-66	241	66	2	2	2.64	0.15
L-HW2-82	333	82	2	2	3.2	0.18
mount 4						
L-HW4-34	156	34	2	4	2.72	0.16
L-HW4-42	182	42	2	4	3.36	0.19
L-HW4-50	211	50	2	4	4	0.23
L-HW4-66	261	66	2	4	5.28	0.31
L-HW4-82	367	82	2	4	6.56	0.40
mount 6						
L-HW6-34	177	34	2	6	4.08	0.24
L-HW6-42	192	42	2	6	5.04	0.29
L-HW6-50	220	50	2	6	6	0.35
L-HW6-66	279	66	2	6	7.92	0.46
L-HW6-82	391	82	2	6	9.84	0.57

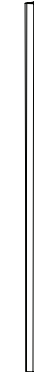

What's Included:

Spline for Switch panels

How to Specify:

Specify black, white, silver or charcoal

Notes:

Splines are sold in pairs and will come in 82"H lengths that can be cut to size on-site.

All 2-way 90 degree, 3-way T, and 4-way X connections will still come automatically with the splines.

Code	Price	H	W	D	Weight (lb.)	Volume (ft ³)
L-XSPL-S-82	215	82				



Switch Canada Pricebook
April 2025

Worksurfaces

Worksurface

<u>Straight /w grommet</u>	134
<u>Straight Worksurface w/o Grommet</u>	136
<u>Straight Worksurface w/ Wire Play</u>	140
<u>5-Sided w Grommet</u>	144
<u>Straight Worksurface with Wire Play</u>	146
<u>Unitized w/ Grommet</u>	148
<u>Unitized w/ Wire Play</u>	150
<u>Transaction Top</u>	152

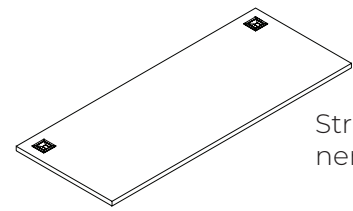

Straight Worksurface with Grommet5-Sided Corner

What's Included:

- One (1) worksurface
- 24"-48" - One (1) grommet cover for centre grommet
- 54"-96" - Two (2) grommet covers for grommet on each end

Notes:

- 24"-48" - One (1) grommet hole in the centre of the worksurface
- 54"-96" - Two (2) grommet holes on each end of the worksurface

How to Specify:

Refer to laminate card for laminate options

Options:

- Width: 24", 30", 36", 42", 48", 54", 60", 66", 72", 78", 84", 90", 96"
- Depth: 20", 24", 30"
- Thickness: 1"

Code	Price	H	W	D	Weight (lb.)	Volume (ft ³)
L-WS0G-2420	204	24	20	1	9.6	0.28
L-WS0G-3020	234	30	20	1	12	0.35
L-WS0G-3620	286	36	20	1	14.4	0.42
L-WS0G-4220	298	42	20	1	16.8	0.49
L-WS0G-4820	322	48	20	1	19.2	0.56
L-WS0G-5420	373	54	20	1	21.6	0.62
L-WS0G-6020	394	60	20	1	24	0.69
L-WS0G-6620	428	66	20	1	26.4	0.76
L-WS0G-7220	457	72	20	1	28.8	0.83
L-WS0G-7820	482	78	20	1	31.2	0.90
L-WS0G-8420	541	84	20	1	33.6	0.97
L-WS0G-9020	549	90	20	1	36	1.04
L-WS0G-9620	588	96	20	1	38.4	1.11
L-WS0G-2424	204	24	24	1	11.52	0.33

Code	Price	H	W	D	Weight (lb.)	Volume (ft ³)
L-WS0G-3024	234	30	24	1	14.4	0.42
L-WS0G-3624	286	36	24	1	17.28	0.50
L-WS0G-4224	298	42	24	1	20.16	0.58
L-WS0G-4824	322	48	24	1	23.04	0.67
L-WS0G-5424	373	54	24	1	25.92	0.75
L-WS0G-6024	394	60	24	1	28.8	0.83
L-WS0G-6624	428	66	24	1	31.68	0.92
L-WS0G-7224	457	72	24	1	34.56	1.00
L-WS0G-7824	482	78	24	1	37.44	1.08
L-WS0G-8424	541	84	24	1	40.32	1.17
L-WS0G-9024	549	90	24	1	43.2	1.25
L-WS0G-9624	588	96	24	1	46.08	1.33
L-WS0G-2430	234	24	30	1	14.4	0.42
L-WS0G-3030	264	30	30	1	18	0.52
L-WS0G-3630	300	36	30	1	21.6	0.62
L-WS0G-4230	328	42	30	1	25.2	0.73
L-WS0G-4830	368	48	30	1	28.8	0.83
L-WS0G-5430	403	54	30	1	32.4	0.94
L-WS0G-6030	437	60	30	1	36	1.04
L-WS0G-6630	475	66	30	1	39.6	1.15
L-WS0G-7230	509	72	30	1	43.2	1.25
L-WS0G-7830	545	78	30	1	46.8	1.35
L-WS0G-8430	573	84	30	1	50.4	1.46
L-WS0G-9030	607	90	30	1	54	1.56
L-WS0G-9630	642	96	30	1	57.6	1.67

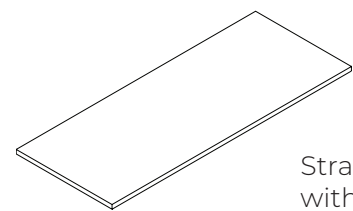

Straight Worksurface without Full Depth without Grommet

What's Included:

One (1) worksurface

How to Specify:

Refer to laminate card for laminate options

Notes:

Worksurface is full depth to sit flush against panel with no grommet

Options:

Width:	24", 30", 36", 42", 48", 54", 60", 66", 72", 78", 84", 90", 96"
Depth:	20", 24", 30"
Thickness:	1"

Code	Price	Height	Depth	Thickness	Weight (lb.)	Volume (ft ³)
Straight Worksurface without Full Depth without Grommet						
L-WS00-2320	157	23	20	1	9.2	0.27
L-WS00-2420	157	24	20	1	9.6	0.28
L-WS00-2920	189	29	20	1	11.6	0.34
L-WS00-3020	189	30	20	1	12	0.35
L-WS00-3520	235	35	20	1	14	0.41
L-WS00-3620	235	36	20	1	14.4	0.42
L-WS00-4120	243	41	20	1	16.4	0.47
L-WS00-4220	243	42	20	1	16.8	0.49
L-WS00-4720	268	47	20	1	18.8	0.54
L-WS00-4820	268	48	20	1	19.2	0.56
L-WS00-5320	321	53	20	1	21.2	0.61

Code	Price	Height	Depth	Thickness	Weight (lb.)	Volume (ft ³)
L-WS00-5420	321	54	20	1	21.6	0.62
L-WS00-5920	321	59	20	1	23.6	0.68
L-WS00-6020	321	60	20	1	24	0.69
L-WS00-6520	373	65	20	1	26	0.75
L-WS00-6620	373	66	20	1	26.4	0.76
L-WS00-7120	402	71	20	1	28.4	0.82
L-WS00-7220	402	72	20	1	28.8	0.83
L-WS00-7620	428	76	20	1	30.4	0.88
L-WS00-7720	428	77	20	1	30.8	0.89
L-WS00-7820	428	78	20	1	31.2	0.90
L-WS00-8220	458	82	20	1	32.8	0.95
L-WS00-8320	458	83	20	1	33.2	0.96
L-WS00-8420	458	84	20	1	33.6	0.97
L-WS00-8820	475	88	20	1	35.2	1.02
L-WS00-8920	475	89	20	1	35.6	1.03
L-WS00-9020	475	90	20	1	36	1.04
L-WS00-9420	505	94	20	1	37.6	1.09
L-WS00-9520	505	95	20	1	38	1.10
L-WS00-9620	505	96	20	1	38.4	1.11
L-WS00-2324	157	23	24	1	11.04	0.32
L-WS00-2424	157	24	24	1	11.52	0.33
L-WS00-2924	189	29	24	1	13.92	0.40
L-WS00-3024	189	30	24	1	14.4	0.42
L-WS00-3524	235	35	24	1	16.8	0.49
L-WS00-3624	235	36	24	1	17.28	0.50
L-WS00-4124	243	41	24	1	19.68	0.57

[2 of 4] continued on next page

Worksurface continued [3 of 4]

Code	Price	Height	Depth	Thickness	Weight (lb.)	Volume (ft ³)
L-WS00-4224	243	42	24	1	20.16	0.58
L-WS00-4724	268	47	24	1	22.56	0.65
L-WS00-4824	268	48	24	1	23.04	0.67
L-WS00-5324	321	53	24	1	25.44	0.74
L-WS00-5424	321	54	24	1	25.92	0.75
L-WS00-5924	343	59	24	1	28.32	0.82
L-WS00-6024	343	60	24	1	28.8	0.83
L-WS00-6524	373	65	24	1	31.2	0.90
L-WS00-6624	373	66	24	1	31.68	0.92
L-WS00-7124	402	71	24	1	34.08	0.99
L-WS00-7224	402	72	24	1	34.56	1.00
L-WS00-7624	428	76	24	1	36.48	1.06
L-WS00-7724	428	77	24	1	36.96	1.07
L-WS00-7824	428	78	24	1	37.44	1.08
L-WS00-8224	458	82	24	1	39.36	1.14
L-WS00-8324	458	83	24	1	39.84	1.15
L-WS00-8424	458	84	24	1	40.32	1.17
L-WS00-8824	475	88	24	1	42.24	1.22
L-WS00-8924	475	89	24	1	42.72	1.24
L-WS00-9024	475	90	24	1	43.2	1.25
L-WS00-9424	505	94	24	1	45.12	1.31
L-WS00-9524	505	95	24	1	45.6	1.32
L-WS00-9624	505	96	24	1	46.08	1.33
L-WS00-2330	189	23	30	1	13.8	0.40
L-WS00-2430	189	24	30	1	14.4	0.42
L-WS00-2930	219	29	30	1	17.4	0.50

Worksurface continued [4 of 4]

Code	Price	Height	Depth	Thickness	Weight (lb.)	Volume (ft ³)
L-WS00-3030	219	30	30	1	18	0.52
L-WS00-3530	256	35	30	1	21	0.61
L-WS00-3630	256	36	30	1	21.6	0.62
L-WS00-4130	284	41	30	1	24.6	0.71
L-WS00-4230	284	42	30	1	25.2	0.73
L-WS00-4730	324	47	30	1	28.2	0.82
L-WS00-4830	324	48	30	1	28.8	0.83
L-WS00-5330	358	53	30	1	31.8	0.92
L-WS00-5430	358	54	30	1	32.4	0.94
L-WS00-5930	392	59	30	1	35.4	1.02
L-WS00-6030	392	60	30	1	36	1.04
L-WS00-6530	429	65	30	1	39	1.13
L-WS00-6630	429	66	30	1	39.6	1.15
L-WS00-7130	463	71	30	1	42.6	1.23
L-WS00-7230	463	72	30	1	43.2	1.25
L-WS00-7630	504	76	30	1	45.6	1.32
L-WS00-7730	504	77	30	1	46.2	1.34
L-WS00-7830	504	78	30	1	46.8	1.35
L-WS00-8230	530	82	30	1	49.2	1.42
L-WS00-8330	530	83	30	1	49.8	1.44
L-WS00-8430	530	84	30	1	50.4	1.46
L-WS00-8830	565	88	30	1	52.8	1.53
L-WS00-8930	565	89	30	1	53.4	1.55
L-WS00-9030	565	90	30	1	54	1.56
L-WS00-9430	597	94	30	1	56.4	1.63
L-WS00-9530	597	95	30	1	57	1.65
L-WS00-9630	597	96	30	1	57.6	1.67

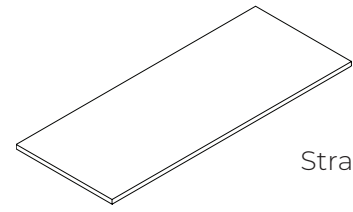

Straight Workspace with 1" Wire Play

What's Included:

One (1) workspace

How to Specify:

Refer to laminate card for laminate options

Notes:

Workspace sits 1" from the panel to allow for wire routing. No grommet is included with this workspace

Options:

Width: 23", 24", 29", 30", 35", 36", 41", 42", 47", 48", 53", 54", 59", 60", 65", 66", 71", 72", 77", 78", 83", 84", 89", 90", 95", 96"

Depth: 19", 20", 23", 24", 29", 30"

Thickness: 1"

Code	Price	Height	Depth	Thickness	Weight (lb.)	Volume (ft ³)
Straight Workspace with 1" Wire Play						
L-WS00-2319	157	23	19	1	8.74	0.25
L-WS00-2419	157	24	19	1	9.12	0.26
L-WS00-2919	189	29	19	1	11.02	0.32
L-WS00-3019	189	30	19	1	11.4	0.33
L-WS00-3519	235	35	19	1	13.3	0.38
L-WS00-3619	235	36	19	1	13.68	0.40
L-WS00-4119	243	41	19	1	15.58	0.45
L-WS00-4219	243	42	19	1	15.96	0.46
L-WS00-4719	268	47	19	1	17.86	0.52
L-WS00-4819	268	48	19	1	18.24	0.53
L-WS00-5319	321	53	19	1	20.14	0.58
L-WS00-5419	321	54	19	1	20.52	0.59

Code	Price	Height	Depth	Thickness	Weight (lb.)	Volume (ft ³)
L-WS00-5919	321	59	19	1	22.42	0.65
L-WS00-6019	321	60	19	1	22.8	0.66
L-WS00-6519	373	65	19	1	24.7	0.71
L-WS00-6619	373	66	19	1	25.08	0.73
L-WS00-7119	402	71	19	1	26.98	0.78
L-WS00-7219	402	72	19	1	27.36	0.79
L-WS00-7619	428	76	19	1	28.88	0.84
L-WS00-7719	428	77	19	1	29.26	0.85
L-WS00-7819	428	78	19	1	29.64	0.86
L-WS00-8219	458	82	19	1	31.16	0.90
L-WS00-8319	458	83	19	1	31.54	0.91
L-WS00-8419	458	84	19	1	31.92	0.92
L-WS00-8819	475	88	19	1	33.44	0.97
L-WS00-8919	475	89	19	1	33.82	0.98
L-WS00-9019	475	90	19	1	34.2	0.99
L-WS00-9419	505	94	19	1	35.72	1.03
L-WS00-9519	505	95	19	1	36.1	1.04
L-WS00-9619	505	96	19	1	36.48	1.06
L-WS00-2323	157	23	23	1	10.58	0.31
L-WS00-2423	157	24	23	1	11.04	0.32
L-WS00-2923	189	29	23	1	13.34	0.39
L-WS00-3023	189	30	23	1	13.8	0.40
L-WS00-3523	235	35	23	1	16.1	0.47
L-WS00-3623	235	36	23	1	16.56	0.48
L-WS00-4123	243	41	23	1	18.86	0.55
L-WS00-4223	243	42	23	1	19.32	0.56
L-WS00-4723	268	47	23	1	21.62	0.63

[2 of 4] continued on next page

Worksurface continued [3 of 4]

Code	Price	Height	Depth	Thickness	Weight (lb.)	Volume (ft ³)
L-WS00-4823	268	48	23	1	22.08	0.64
L-WS00-5323	321	53	23	1	24.38	0.71
L-WS00-5423	321	54	23	1	24.84	0.72
L-WS00-5923	321	59	23	1	27.14	0.79
L-WS00-6023	321	60	23	1	27.6	0.80
L-WS00-6523	373	65	23	1	29.9	0.87
L-WS00-6623	373	66	23	1	30.36	0.88
L-WS00-7123	402	71	23	1	32.66	0.95
L-WS00-7223	402	72	23	1	33.12	0.96
L-WS00-7623	428	76	23	1	34.96	1.01
L-WS00-7723	428	77	23	1	35.42	1.02
L-WS00-7823	428	78	23	1	35.88	1.04
L-WS00-8223	458	82	23	1	37.72	1.09
L-WS00-8323	458	83	23	1	38.18	1.10
L-WS00-8423	458	84	23	1	38.64	1.12
L-WS00-8823	475	88	23	1	40.48	1.17
L-WS00-8923	475	89	23	1	40.94	1.18
L-WS00-9023	475	90	23	1	41.4	1.20
L-WS00-9423	505	94	23	1	43.24	1.25
L-WS00-9523	505	95	23	1	43.7	1.26
L-WS00-9623	505	96	23	1	44.16	1.28
L-WS00-2329	189	23	29	1	13.34	0.39
L-WS00-2429	189	24	29	1	13.92	0.40
L-WS00-2929	219	29	29	1	16.82	0.49
L-WS00-3029	219	30	29	1	17.4	0.50
L-WS00-3529	256	35	29	1	20.3	0.59
L-WS00-3629	256	36	29	1	20.88	0.60
L-WS00-4129	284	41	29	1	23.78	0.69

Worksurface continued [4 of 4]

Code	Price	Height	Depth	Thickness	Weight (lb.)	Volume (ft ³)
L-WS00-4229	284	42	29	1	24.36	0.70
L-WS00-4729	324	47	29	1	27.26	0.79
L-WS00-4829	324	48	29	1	27.84	0.81
L-WS00-5329	358	53	29	1	30.74	0.89
L-WS00-5429	358	54	29	1	31.32	0.91
L-WS00-5929	392	59	29	1	34.22	0.99
L-WS00-6029	392	60	29	1	34.8	1.01
L-WS00-6529	429	65	29	1	37.7	1.09
L-WS00-6629	429	66	29	1	38.28	1.11
L-WS00-7129	463	71	29	1	41.18	1.19
L-WS00-7229	463	72	29	1	41.76	1.21
L-WS00-7629	504	76	29	1	44.08	1.28
L-WS00-7729	504	77	29	1	44.66	1.29
L-WS00-7829	504	78	29	1	45.24	1.31
L-WS00-8229	530	82	29	1	47.56	1.38
L-WS00-8329	530	83	29	1	48.14	1.39
L-WS00-8429	530	84	29	1	48.72	1.41
L-WS00-8829	565	88	29	1	51.04	1.48
L-WS00-8929	565	89	29	1	51.62	1.49
L-WS00-9029	565	90	29	1	52.2	1.51
L-WS00-9429	597	94	29	1	54.52	1.58
L-WS00-9529	597	95	29	1	55.1	1.59
L-WS00-9629	597	96	29	1	55.68	1.61

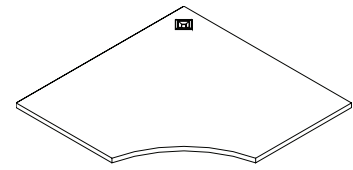

Curved 5-Sided Workspace with Grommet

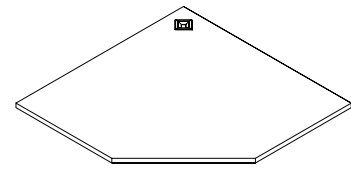

Straight 5-Sided Workspace with Grommet

What's Included:

One (1) workspace, One (1) grommet

How to Specify:

Refer to laminate card for laminate options

Notes:

Workspace sits 1" from the panel to allow for wire routing. No grommet is included with this workspace

Surface has a curved front

Options:

Side A*: 36", 42", 48"

Side B: 24", 30"

Thickness: 1"

Straight, Curved Front

Grommet Type & Color: Square (Silver, Black, White), Oval (Silver, Black)

*36" on side A only available in 24" on side B

Code	Price	Height	Depth	Thickness	Weight (lb.)	Volume (ft ³)
curved front with grommet						
L-W5CG-3624	428	36	24	1	30	0.50
L-W5CG-4224	510	42	24	1	33	0.58
L-W5CG-4824	612	48	24	1	36	0.67
L-W5CG-4230	510	42	30	1	35	0.73
L-W5CG-4830	612	48	30	1	38	0.83
straight front with grommet						
L-W5SG-3624	428	36	24	1	30	0.50
L-W5SG-4224	510	42	24	1	33	0.58
L-W5SG-4824	612	48	24	1	36	0.67
L-W5SG-4230	510	42	30	1	35	0.73
L-W5SG-4830	612	48	30	1	38	0.83

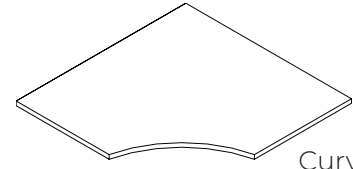

Curved 5-Sided Workspace with 1" Wire Play

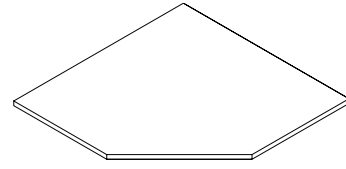

Straight 5-Sided Workspace with 1" Wire Play

What's Included:

One (1) workspace

How to Specify:

Refer to laminate card for laminate options

Options:

Side A & C*: 35", 36", 41", 42", 47", 48"

Side B & D: 23", 24", 29", 30"

Thickness: 1"

Straight, Curved Front

*35" & 36" on side A & C only available in 23" & 24" on side B & D

Notes:

Workspace sits 1" from the panel to allow for wire routing. No grommet is included with this workspace

Code	Price	Height	Depth	Thickness	Weight (lb.)	Volume (ft ³)
Left hand curved front						
L-W5C0-3624-L	428	36	24	1	30	0.50
L-W5C0-4224-L	510	42	24	1	33	0.58
L-W5C0-4824-L	612	48	24	1	36	0.67
L-W5C0-4230-L	510	42	30	1	35	0.73
L-W5C0-4830-L	612	48	30	1	38	0.83
Right hand curved front						
L-W5C0-3624-R	428	36	24	1	30	0.50
L-W5C0-4224-R	510	42	24	1	33	0.58
L-W5C0-4824-R	612	48	24	1	36	0.67
L-W5C0-4230-R	510	42	30	1	35	0.73
L-W5C0-4830-R	612	48	30	1	38	0.83
Double curved front						
L-W5C0-3523-D	428	35	23	1	30	0.47
L-W5C0-4123-D	510	41	23	1	33	0.55
L-W5C0-4723-D	612	47	23	1	36	0.63
L-W5C0-4129-D	510	41	29	1	35	0.69
L-W5C0-4729-D	612	47	29	1	38	0.79

Code	Price	Height	Depth	Thickness	Weight (lb.)	Volume (ft ³)
Left hand straight front						
L-W5S0-3624-L	428	36	24	1	30	0.50
L-W5S0-4224-L	510	42	24	1	33	0.58
L-W5S0-4824-L	612	48	24	1	36	0.67
L-W5S0-4230-L	510	42	30	1	35	0.73
L-W5S0-4830-L	612	48	30	1	38	0.83
Right hand straight front						
L-W5S0-3624-R	428	36	24	1	30	0.50
L-W5S0-4224-R	510	42	24	1	33	0.58
L-W5S0-4824-R	612	48	24	1	36	0.67
L-W5S0-4230-R	510	42	30	1	35	0.73
L-W5S0-4830-R	612	48	30	1	38	0.83
Double straight front						
L-W5S0-3523-D	428	35	23	1	30	0.47
L-W5S0-4123-D	510	41	23	1	33	0.55
L-W5S0-4723-D	612	47	23	1	36	0.63
L-W5S0-4129-D	510	41	29	1	35	0.69
L-W5S0-4729-D	612	47	29	1	38	0.79

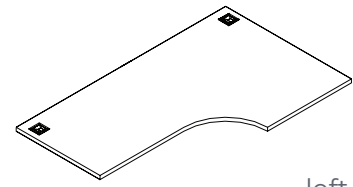

left hand shown with grommet

What's Included:

One (1) workspace, Two(2) grommets

How to Specify:

Refer to laminate card for laminate options

Notes:

Surface has a curved front

Options:

Side A:	36"
Side B:	24"
Side C:	54", 60", 66", 72", 78", 84", 90", 96"
Thickness:	1"
Left Hand, Right Hand	
Grommet Type & Color: Square (Silver, Black, White), Oval (Silver, Black)	

Code	Price	Height	Depth	Thickness	Weight (lb.)	Volume (ft ³)
Left hand with grommet						
L-WUCG-543624-L	575	54	36	1	24.88	1.12
L-WUCG-603624-L	606	60	36	1	26.88	1.25
L-WUCG-663624-L	673	66	36	1	28.88	1.38
L-WUCG-723624-L	714	72	36	1	30.88	1.50
L-WUCG-783624-L	769	78	36	1	32.88	1.62
L-WUCG-843624-L	825	84	36	1	34.88	1.75
L-WUCG-903624-L	947	90	36	1	36.88	1.88
L-WUCG-963624-L	998	96	36	1	38.88	2.00
Right hand with grommet						
L-WUCG-543624-R	575	54	36	1	24.88	1.12
L-WUCG-603624-R	606	60	36	1	26.88	1.25
L-WUCG-663624-R	673	66	36	1	28.88	1.38
L-WUCG-723624-R	714	72	36	1	30.88	1.50
L-WUCG-783624-R	769	78	36	1	32.88	1.62
L-WUCG-843624-R	825	84	36	1	34.88	1.75
L-WUCG-903624-R	947	90	36	1	36.88	1.88
L-WUCG-963624-R	998	96	36	1	38.88	2.00

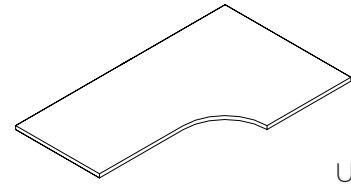

Unitized Workspace with 1" Wire Play

What's Included:

One (1) workspace

How to Specify:

Refer to laminate card for laminate options

Notes:

Workspace sits 1" from the panel to allow for wire routing. No grommet is included with this workspace

Surface has a curved front

Options:

Side A:	53", 54", 59", 60", 65", 66", 71", 72", 77", 78", 83", 84", 89", 90", 95", 96"
Side B:	23", 24"
Side C:	35", 36"
Side D:	23", 24"

Code	Price	Height	Depth	Thickness	Weight (lb)	Volume (ft ³)
Left hand						
L-WUC0-543524-L	575	54	35	1	24.88	1.09
L-WUC0-603524-L	606	60	35	1	26.88	1.22
L-WUC0-663524-L	673	66	35	1	28.88	1.34
L-WUC0-723524-L	714	72	35	1	30.88	1.46
L-WUC0-783524-L	769	78	35	1	32.88	1.58
L-WUC0-843524-L	825	84	35	1	34.88	1.70
L-WUC0-903524-L	947	90	35	1	36.88	1.82
L-WUC0-963524-L	998	96	35	1	38.88	1.94
L-WUC0-533624-L	575	53	36	1	24.88	1.10
L-WUC0-593624-L	606	59	36	1	26.88	1.23
L-WUC0-653624-L	673	65	36	1	28.88	1.35
L-WUC0-713624-L	714	71	36	1	30.88	1.48
L-WUC0-773624-L	769	77	36	1	32.88	1.60
L-WUC0-833624-L	825	83	36	1	34.88	1.73
L-WUC0-893624-L	947	89	36	1	36.88	1.85

Code	Price	Height	Depth	Thickness	Weight (lb)	Volume (ft ³)
L-WUC0-953624-L	998	95	36	1	38.88	1.98
L-WUC0-533523-L	575	53	35	1	24.88	1.07
L-WUC0-593523-L	606	59	35	1	26.88	1.20
L-WUC0-653523-L	673	65	35	1	28.88	1.32
L-WUC0-713523-L	714	71	35	1	30.88	1.44
L-WUC0-773523-L	769	77	35	1	32.88	1.56
L-WUC0-833523-L	825	83	35	1	34.88	1.68
L-WUC0-893523-L	947	89	35	1	36.88	1.80
L-WUC0-953523-L	998	95	35	1	38.88	1.92
Right hand						
L-WUC0-543524-R	575	54	35	1	24.88	1.09
L-WUC0-603524-R	606	60	35	1	26.88	1.22
L-WUC0-663524-R	673	66	35	1	28.88	1.34
L-WUC0-723524-R	714	72	35	1	30.88	1.46
L-WUC0-783524-R	769	78	35	1	32.88	1.58
L-WUC0-843524-R	825	84	35	1	34.88	1.70
L-WUC0-903524-R	947	90	35	1	36.88	1.82
L-WUC0-963524-R	998	96	35	1	38.88	1.94
L-WUC0-533624-R	575	53	36	1	24.88	1.10
L-WUC0-593624-R	606	59	36	1	26.88	1.23
L-WUC0-653624-R	673	65	36	1	28.88	1.35
L-WUC0-713624-R	714	71	36	1	30.88	1.48
L-WUC0-773624-R	769	77	36	1	32.88	1.60
L-WUC0-833624-R	825	83	36	1	34.88	1.73
L-WUC0-893624-R	947	89	36	1	36.88	1.85
L-WUC0-953624-R	998	95	36	1	38.88	1.98
L-WUC0-533523-R	575	53	35	1	24.88	1.07
L-WUC0-593523-R	606	59	35	1	26.88	1.20
L-WUC0-653523-R	673	65	35	1	28.88	1.32
L-WUC0-713523-R	714	71	35	1	30.88	1.44
L-WUC0-773523-R	769	77	35	1	32.88	1.56
L-WUC0-833523-R	825	83	35	1	34.88	1.68
L-WUC0-893523-R	947	89	35	1	36.88	1.80
L-WUC0-953523-R	998	95	35	1	38.88	1.92

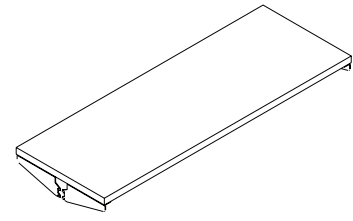

What's Included:

One (1) transaction top, Four (4) cantilever brackets

How to Specify:

Match the transaction top to the corresponding panel width

Refer to laminate card for laminate options

Choose White, Black, Silver, Charcoal for cantilever color

Notes:

Options:

Width: 24", 30", 36", 42", 48", 54", 60"

Depth: 15"

Thickness: 1"

Cantilever Paint Color: Silver, White, Black, Charcoal

Code	Price	H	W	D	Weight (lb.)	Volume (ft ³)
L-WTT-2415	262	24	15	1	5.76	0.21
L-WTT-3015	284	30	15	1	7.2	0.26
L-WTT-3615	297	36	15	1	8.64	0.31
L-WTT-4215	312	42	15	1	10.08	0.36
L-WTT-4815	327	48	15	1	11.52	0.42
L-WTT-5415	344	54	15	1	12.96	0.47
L-WTT-6015	355	60	15	1	14.4	0.52



Switch Canada Pricebook
April 2025

Supports

Supports

Ladder Gable	156
Standard Panel	156
Gallery Panel	158
Freestanding Panel	160
Laminate Gable	161
Standard Panel	161
Gallery Panel	162
Freestanding	163
Wrap Gable	164
Standard Panel	164
Gallery Panel	165
Tech Drop	166
Cantilever	167
Standard Panel	167
Gallery Panel	168
Standard Panel Mount Corner Bracket	170
Flush Plates	171
Storage Support Bracket	172
Fixed Credenza Support Bracket	173
90 Degree Storage Bracket	174
Horizontal Surface Support	175

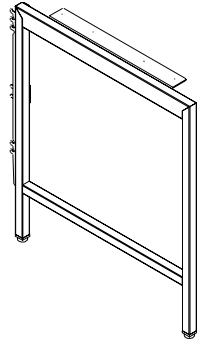

Standard Panel Ladder Gable

What's Included:

One (1) ladder gable, one (1) standard panel mount bracket, (1) surface to gable connector

How to Specify:

Choose White, Black, Silver, Charcoal for ladder gable colour

Notes:

Ladder Gable can be used with worksurface with grommet, worksurface without grommet, worksurface for 1" wire play

Mid gable is used at the surface joint

Options:

Heights*: 25", 28"

Depth: 20", 24", 30"

Ladder Gable Paint Colour:: Silver, White, Black, Charcoal

End gable: (Left hand, right hand) or mid gable

*25" high to be used to Tech Drop surface

Code	Price	H	W	D	Weight (lb.)	Volume (ft ³)
Left hand						
L-HOEG-P-2520-L	478	25	20	2	10	0.58
L-HOEG-P-2524-L	483	25	24	2	12	0.69
L-HOEG-P-2530-L	518	25	30	2	15	0.87
L-HOEG-P-2820-L	485	28	20	2	11.2	0.65
L-HOEG-P-2824-L	489	28	24	2	13.44	0.78
L-HOEG-P-2830-L	529	28	30	2	16.8	0.97
Right hand						
L-HOEG-P-2520-R	478	25	20	2	10	0.58
L-HOEG-P-2524-R	483	25	24	2	12	0.69
L-HOEG-P-2530-R	518	25	30	2	15	0.87
L-HOEG-P-2820-R	485	28	20	2	11.2	0.65
L-HOEG-P-2824-R	489	28	24	2	13.44	0.78
Mid						
L-HOMG-P-2520	478	25	20	2	10	0.58
L-HOMG-P-2524	483	25	24	2	12	0.69
L-HOMG-P-2530	518	25	30	2	15	0.87
L-HOMG-P-2820	485	28	20	2	11.2	0.65
L-HOMG-P-2824	489	28	24	2	13.44	0.78
L-HOMG-P-2830	529	28	30	2	16.8	0.97

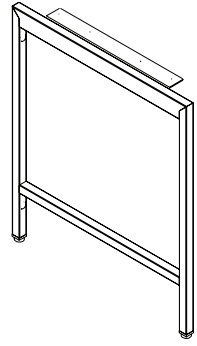

Gallery Panel Ladder Gable

What's Included:

One (1) ladder gable, one (1) gallery panel mount bracket, (1) surface to gable connector

How to Specify:

Choose White, Black, Silver, Charcoal for ladder gable colour

Notes:

Ladder Gable can be used with worksurface with grommet, worksurface without grommet, worksurface for 1" wire play

Mid gable is used at the surface joint

Options:

Heights*:	25", 28"
Depth:	20", 24", 30"
Ladder Gable Paint Colour::	Silver, White, Black, Charcoal
End gable:	(Left hand, right hand) or mid gable

*25" high to be used to Tech Drop surface

Code	Price	H	W	D	Weight (lb.)	Volume (ft ³)
Left hand						
L-HOEG-Y-2520-L	478	25	20	2	10	0.58
L-HOEG-Y-2524-L	483	25	24	2	12	0.69
L-HOEG-Y-2530-L	518	25	30	2	15	0.87
L-HOEG-Y-2820-L	485	28	20	2	11.2	0.65
L-HOEG-Y-2824-L	489	28	24	2	13.44	0.78
L-HOEG-Y-2830-L	529	28	30	2	16.8	0.97
Right hand						
L-HOEG-Y-2520-R	478	25	20	2	10	0.58
L-HOEG-Y-2524-R	483	25	24	2	12	0.69
L-HOEG-Y-2530-R	518	25	30	2	15	0.87
L-HOEG-Y-2820-R	485	28	20	2	11.2	0.65
L-HOEG-Y-2824-R	489	28	24	2	13.44	0.78
L-HOEG-Y-2830-R	529	28	30	2	16.8	0.97
Mid						
L-HOMG-Y-2520	478	25	20	2	10	0.58
L-HOMG-Y-2524	483	25	24	2	12	0.69
L-HOMG-Y-2530	518	25	30	2	15	0.87
L-HOMG-Y-2820	485	28	20	2	11.2	0.65
L-HOMG-Y-2824	489	28	24	2	13.44	0.78
L-HOMG-Y-2830	529	28	30	2	16.8	0.97

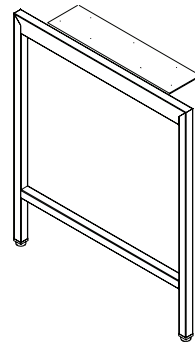

Freestanding

What's Included:

One (1) 90 degree bracket

How to Specify:

Available in black only

Notes:

90 degree bracket is used to connect a worksurface to a gallery panel

Options:

Heights*: 25", 28"

Depth: 20", 24", 30"

Ladder Gable Paint Colour:: Silver, White, Black, Charcoal

End gable: (Left hand, right hand)

*25" high to be used to Tech Drop surface

Code	Price	H	W	D	Weight (lb.)	Volume (ft ³)
Freestanding						
L-HOEG-S-2520	478	25	20	2	10	0.58
L-HOEG-S-2524	483	25	24	2	12	0.69
L-HOEG-S-2530	518	25	30	2	15	0.87
L-HOEG-S-2820	485	28	20	2	11.2	0.65
L-HOEG-S-2824	489	28	24	2	13.44	0.78
L-HOEG-S-2830	529	28	30	2	16.8	0.97

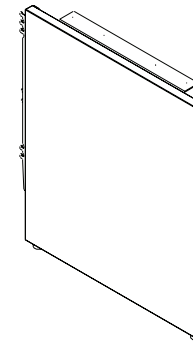

Standard Panel Laminate Gable

What's Included:

One (1) ladder gable, one (1) standard panel mount bracket, (1) surface to gable connector

How to Specify:

Laminate Gable Paint Colour: Silver, White, Black, Charcoal

Laminate Gable Laminate Colour: Refer to laminate card for laminate options

End gable (Left hand, right hand)

Options:

Heights*: 25", 28"

Depth: 20", 24", 30"

*25" high to be used to Tech Drop surface

Notes:

Ladder Gable can be used with worksurface with grommet, worksurface without grommet, worksurface for 1" wire play

Code	Price	H	W	D	Weight (lb.)	Volume (ft ³)
Left hand						
L-HCEG-P-2520-L	224	25	20	2	10	0.58
L-HCEG-P-2524-L	246	25	24	2	12	0.69
L-HCEG-P-2530-L	263	25	30	2	15	0.87
L-HCEG-P-2812-L	211	28	12	2	10	0.39
L-HCEG-P-2820-L	236	28	20	2	11.2	0.65
L-HCEG-P-2824-L	252	28	24	2	13.44	0.78
L-HCEG-P-2830-L	277	28	30	2	16.8	0.97
Right hand						
L-HCEG-P-2520-R	224	25	20	2	10	0.58
L-HCEG-P-2524-R	246	25	24	2	12	0.69
L-HCEG-P-2530-R	263	25	30	2	15	0.87
L-HCEG-P-2812-R	211	28	12	2	10	0.39
L-HCEG-P-2820-R	236	28	20	2	11.2	0.65
L-HCEG-P-2824-R	252	28	24	2	13.44	0.78
L-HCEG-P-2830-R	277	28	30	2	16.8	0.97

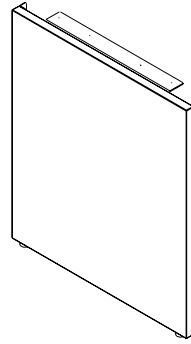

Gallery Panel Laminate Gable

What's Included:

One (1) ladder gable, one (1) gallery panel mount bracket, (1) surface to gable connector

How to Specify:

Laminate Gable Paint Colour: Silver, White, Black, Charcoal

Laminate Gable Laminate Colour: Refer to laminate card for laminate options

End gable (Left hand, right hand)

Options:

Heights*: 25", 28"

Depth: 20", 24", 30"

*25" high to be used to Tech Drop surface

Notes:

Ladder Gable can be used with worksurface with grommet, worksurface without grommet, worksurface for 1" wire play

Code	Price	H	W	D	Weight (lb.)	Volume (ft ³)
Left hand						
L-HCEG-Y-2520-L	217	25	20	2	10	0.58
L-HCEG-Y-2524-L	235	25	24	2	12	0.69
L-HCEG-Y-2530-L	258	25	30	2	15	0.87
L-HCEG-Y-2812-L	204	28	12	2	11.2	0.39
L-HCEG-Y-2820-L	224	28	20	2	11.2	0.65
L-HCEG-Y-2824-L	246	28	24	2	13.44	0.78
L-HCEG-Y-2830-L	271	28	30	2	16.8	0.97
Right hand						
L-HCEG-Y-2520-R	217	25	20	2	10	0.58
L-HCEG-Y-2524-R	235	25	24	2	12	0.69
L-HCEG-Y-2530-R	258	25	30	2	15	0.87
L-HCEG-Y-2812-R	204	28	12	2	11.2	0.39
L-HCEG-Y-2820-R	224	28	20	2	11.2	0.65
L-HCEG-Y-2824-R	246	28	24	2	13.44	0.78
L-HCEG-Y-2830-R	271	28	30	2	16.8	0.97

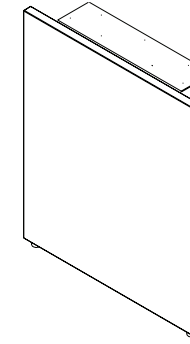

Freestanding Laminate Gable

What's Included:

One (1) ladder gable, (1) surface to gable connector

How to Specify:

Laminate Gable Paint Colour: Silver, White, Black, Charcoal

Laminate Gable Laminate Colour: Refer to laminate card for laminate options

Options:

Heights*: 25", 28"

Depth: 20", 24", 30"

*25" is used with the 20" deep surface

Notes:

Laminate Gable can be used with worksurface with grommet, worksurface without grommet, worksurface for 1" wire play

Freestanding gable is used when one side of the surface is connected to a panel and the other is open

Code	Price	H	W	D	Weight (lb.)	Volume (ft ³)
L-HCEG-S-2520	236	25	20	2	10	0.58
L-HCEG-S-2524	250	25	24	2	12	0.69
L-HCEG-S-2530	275	25	30	2	15	0.87
L-HCEG-S-2820	246	28	20	2	11.2	0.65
L-HCEG-S-2824	262	28	24	2	13.44	0.78
L-HCEG-S-2830	286	28	30	2	16.8	0.97

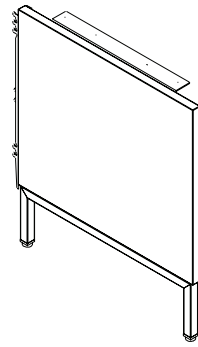

Standard Panel
Wrap Laminate Gable

What's Included:

One (1) wrap gable, one (1) standard panel mount bracket, (1) surface to gable connector

How to Specify:

Laminate Gable Paint Colour: Silver, White, Black, Charcoal

Laminate Gable Laminate Colour: Refer to laminate card for laminate options

End gable (Left hand, right hand)

Options:

Heights*: 25", 28"

Depth: 20", 24", 30"

*25" high to be used to Tech Drop surface

Notes:

Laminate Gable can be used with worksurface with grommet, worksurface without grommet, worksurface for 1" wire play

Freestanding gable is used when one side of the surface is connected to a panel and the other is open

Code	Price	H	W	D	Weight (lb.)	Volume (ft ³)
Left hand						
L-HWEG-P-2520-L	435	25	20	2	10	0.58
L-HWEG-P-2524-L	451	25	24	2	12	0.69
L-HWEG-P-2530-L	495	25	30	2	15	0.87
L-HWEG-P-2820-L	450	28	20	2	11.2	0.65
L-HWEG-P-2824-L	461	28	24	2	13.44	0.78
L-HWEG-P-2830-L	509	28	30	2	16.8	0.97
Right hand						
L-HWEG-P-2520-R	435	25	20	2	10	0.58
L-HWEG-P-2524-R	451	25	24	2	12	0.69
L-HWEG-P-2530-R	495	25	30	2	15	0.87
L-HWEG-P-2820-R	450	28	20	2	11.2	0.65
L-HWEG-P-2824-R	461	28	24	2	13.44	0.78
L-HWEG-P-2830-R	509	28	30	2	16.8	0.97

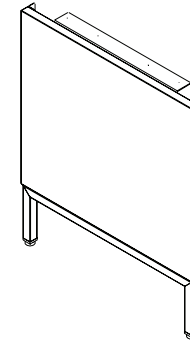

Gallery Panel
Wrap Laminate Gable

What's Included:

One (1) wrap gable, one (1) gallery panel mount bracket, (1) surface to gable connector

How to Specify:

Laminate Gable Paint Colour: Silver, White, Black, Charcoal

Laminate Gable Laminate Colour: Refer to laminate card for laminate options

End gable (Left hand, right hand)

Options:

Heights*: 25", 28"

Depth: 20", 24", 30"

*25" high to be used to Tech Drop surface

Notes:

Laminate Gable can be used with worksurface with grommet, worksurface without grommet, worksurface for 1" wire play

Freestanding gable is used when one side of the surface is connected to a panel and the other is open

Code	Price	H	W	D	Weight (lb.)	Volume (ft ³)
Left hand						
L-HWEG-Y-2520-L	435	25	20	2	10	0.58
L-HWEG-Y-2524-L	451	25	24	2	12	0.69
L-HWEG-Y-2530-L	495	25	30	2	15	0.87
L-HWEG-Y-2820-L	450	28	20	2	11.2	0.65
L-HWEG-Y-2824-L	461	28	24	2	13.44	0.78
L-HWEG-Y-2830-L	511	28	30	2	16.8	0.97
Right hand						
L-HWEG-Y-2520-R	435	25	20	2	10	0.58
L-HWEG-Y-2524-R	451	25	24	2	12	0.69
L-HWEG-Y-2530-R	495	25	30	2	15	0.87
L-HWEG-Y-2820-R	450	28	20	2	11.2	0.65
L-HWEG-Y-2824-R	461	28	24	2	13.44	0.78
L-HWEG-Y-2830-R	511	28	30	2	16.8	0.97

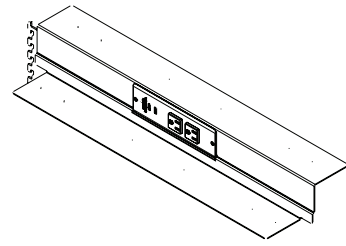

Standard Panel Tech Drop

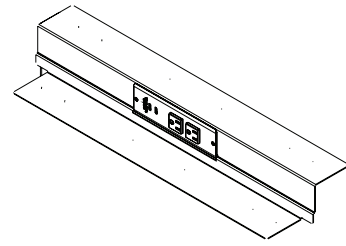

Gallery Panel Tech Drop

What's Included:

One (1) tech drop, one (1) power module with two (2) AC outlets and two (2) USB-A outlets, one (1) panel connector hardware

How to Specify:

Choose White, Black, Silver, Charcoal for Tech Drop

Left, right

Options:

Heights: 3"

Depth*: 19", 23"

*19" is used with the 20" deep surface

Notes:

Tech drop offers a 3" drop between main surface and return surface

Tech drop must be mounted to the panel

Code	Price	H	W	D	Weight (lb.)	Volume (ft ³)
Standard Panel Tech Drop - left hand						
L-HSSE-P-19-L	417	3	19.875	4	6.33	0.14
L-HSSE-P-23-L	427	3	23.875	4	7.67	0.17
Standard Panel Tech Drop - right hand						
L-HSSE-P-19-R	417	3	19.875	4	6.33	0.14
L-HSSE-P-23-R	427	3	23.875	4	7.67	0.17
Gallery Panel Tech Drop - left hand						
L-HSSE-Y-19-L	421	3	19.875	4	6.33	0.14
L-HSSE-Y-23-L	429	3	23.875	4	7.67	0.17
Gallery Panel Tech Drop - right hand						
L-HSSE-Y-19-R	421	3	19.875	4	6.33	0.14
L-HSSE-Y-23-R	429	3	23.875	4	7.67	0.17

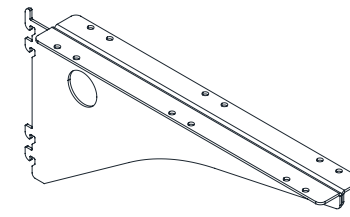

Standard Panel Mounted Cantilever Arm

What's Included:

One (1) standard panel mounted cantilever arm

How to Specify:

Left, right, mid

Options:

Depth: 16", 22"

Notes:

Cantilever available in black only

Code	Price	H	W	D	Weight (lb.)	Volume (ft ³)
intermediate						
L-CCAB-P-16	44	8	16	2	2.56	0.15
L-CCAB-P-22	78	8	22	2	3.52	0.21
left hand						
L-CCAB-P-16-L	44	8	16	1.5	1.92	0.11
L-CCAB-P-22-L	78	8	22	1.5	2.64	0.15
right hand						
L-CCAB-P-16-R	44	8	16	1.5	1.92	0.11
L-CCAB-P-22-R	78	8	22	1.5	2.64	0.15

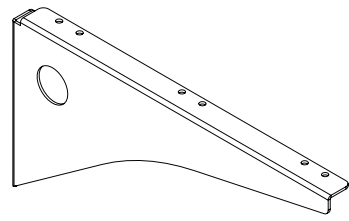

Gallery Panel Mounted Cantilever Arm

What's Included:

One (1) gallery panel mounted cantilever arm

How to Specify:

Left, right, mid

Options:

Depth: 16", 22"

Notes:

Cantilever available in black only

Code	Price	H	W	D	Weight (lb.)	Volume (ft ³)
intermediate						
L-CCAB-Y-16	44	8	16	2	2.56	0.15
L-CCAB-Y-22	78	8	22	2	3.52	0.21
left hand						
L-CCAB-Y-16-L	44	8	16	1.5	1.92	0.11
L-CCAB-Y-22-L	78	8	22	1.5	2.64	0.15
right hand						
L-CCAB-Y-16-R	44	8	16	1.5	1.92	0.11
L-CCAB-Y-22-R	78	8	22	1.5	2.64	0.15

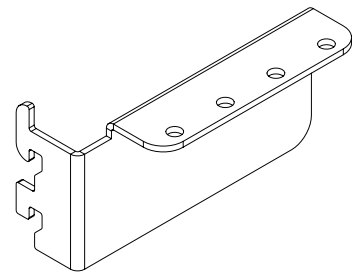

L-HCB
left hand shown

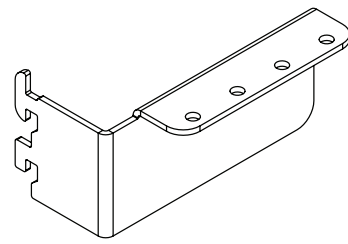

L-HCB1
left hand shown

What's Included:

One (1) standard panel mounted corner bracket

How to Specify:

Left, right
Full depth surface, surface with 1" wire play

Notes:

Worksurface with 1" wire play requires 1" offset bracket

Corner bracket available in black only

Options:

Code	Price	H	W	D	Weight (lb.)	Volume (ft ³)
L-HCB-P-L	8	3	4	2	0.05	0.01
L-HCB1-P-L	19	3	4	2	0.05	0.01
L-HCB-P-R	8	3	4	2	0.05	0.01
L-HCB1-P-R	19	3	4	2	0.05	0.01

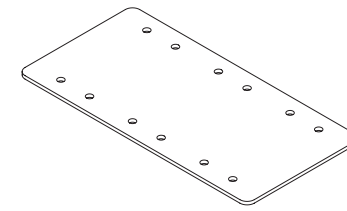

What's Included:

One (1) flush plate

How to Specify:

Flush Plate Paint Colour: Silver only

Notes:

Flush plate is used at surface joint to connect two surfaces together

Options:

Width: 5.5"
Depth: 3"

Code	Price	H	W	D	Weight (lb.)	Volume (ft ³)
L-PWW	44	3	5.5	0.125	1	0.00

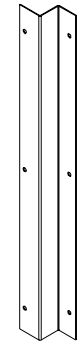

for standard panel

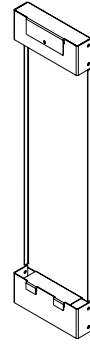

for gallery panel

What's Included:

panel to storage support bracket

How to Specify:

Available in white, black, charcoal, and silver

Notes:

Storage support bracket is used to connect off-modular storage to a surface

24" bracket is used to close 1" gap between storage and panel

30" bracket is used to close 7" gap between storage and panel

Options:

Width: 1", 7"

Code	Price	H	W	Weight (lb.)	Volume (ft ³)
for standard panel - left hand					
L-HPSP-24-L	62	28	1	8.57	0.39
L-HPSP-30-L	111	28	1	10.71	0.49
for standard panel -right hand					
L-HPSP-24-R	62	28	1	8.57	0.39
L-HPSP-30-R	111	28	1	10.71	0.49
for gallery panel					
L-HPGP-24	82	28	1	8.57	0.39
L-HPGP-30	154	2828	1	10.72	0.49

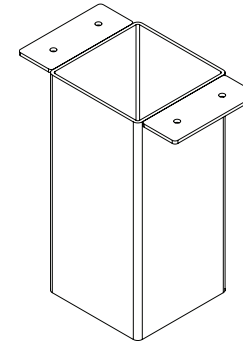

What's Included:

One (1) 90 degree bracket

How to Specify:

Flush Plate Paint Colour: Silver, White, Black, Charcoal

Options:

Height: 6"

Width: 4"

Depth: 4"

Notes:

Code	Price	H	W	D	Weight (lb.)	Volume (ft ³)
L-HCFM6	184	6.375	7	4	6	0.14

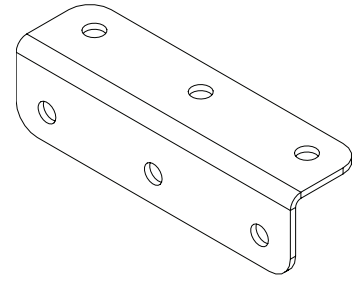

What's Included:

One (1) 90 degree bracket

How to Specify:

Available in black only

Options:

Depth: 3"

Notes:

90 degree bracket is used to connect a worksurface to a gallery panel

24" deep surface: two (2) brackets
30" deep surface: three (3) brackets

Code	Price	Specifications	Weight (lb.)	Volume (ft ³)
L-HSSB	3	3", 6 Holes	0.5	0.09
L-HSSB-24	8	For 24"Deep	2.19	0.09
L-HSSB-30	15	For 30"Deep	3	0.09

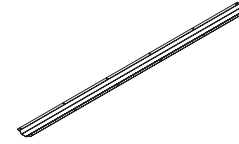

What's Included:

Horizontal Surface Support, installation hardware.

How to Specify:

The horizontal surface support is available only in silver.

Options:

width 51, 57, 63, 69, 75

Notes:

The horizontal surface support is used to support worksurfaces 54-inches and longer.

This item is mounted to the underside of a worksurface.

Code	Price	W (in)	Weight (lb)	Volume (ft ³)
L-CH00-54	74	51	4	0.05
L-CH00-60	80	57	4.5	0.05
L-CH00-66	86	63	5	0.06
L-CH00-72	90	69	5.5	0.06
L-CH00-78	95	75	6	0.07



Switch Canada Pricebook
April 2025
Electrics

Electrics

Power Module	178
Starter Harness	179
Connector Harness	180
Male to Female Extension Harness	182
New York Junction Box	183
Chicago Electrical Box	184
Power Pole	185
Communication Kit	186
Conversion Kit	187

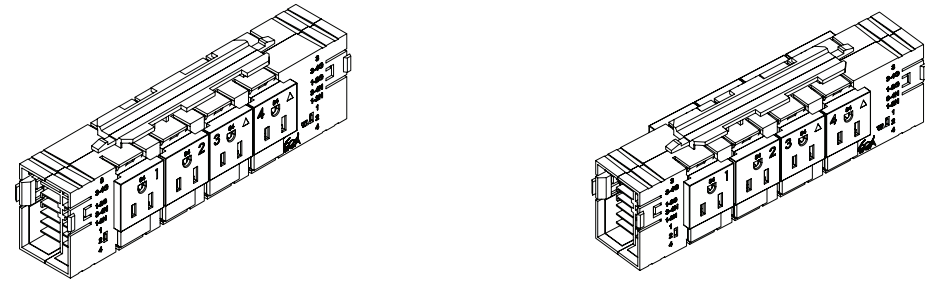

What's Included:

One (1) single power module with four (4) ac outlets or one (1) double sided power module with eight (8) ac outlets (four on each side)

How to Specify:

Available in grey only
Single sided, double sided

Options:

Width: 8"

Notes:

Power modules are installed in the center cut out power capable panels only

Double sided power module has four (4) ac outlets on each side

Refer to Switch electrical specification guide for more information

Code	Price	H	W	D	Weight (lb.)	Volume (ft ³)
single sided						
L-EM84-S	220	3	6	3	1.7	0.03
double sided						
L-EM84-D	321	3	6	3	2	0.03

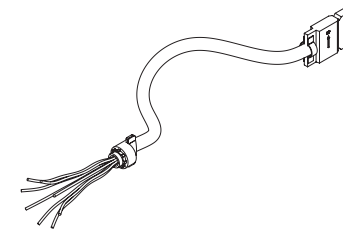

What's Included:

One (1) open wire starter harness

How to Specify:

Available in grey only
Single sided, double sided

Options:

Length: 72", 168"

Notes:

Switch electrical system is rated for 20 amps

Tayco recommends up to 8 workstations hardwired to one power source

Code	Price	L	D	Weight (lb.)	Volume (ft ³)
L-ES84-072-0	334	72	0.75	2.61	0.40
L-ES84-168-0	487	168	0.75	5.12	0.50

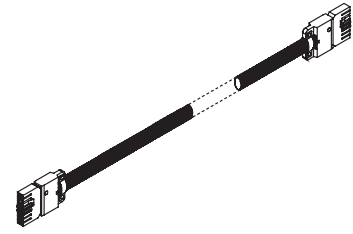

What's Included:

One (1) connector harness

How to Specify:

Available in grey only

Single sided, double sided

Options:

Length: 22"-181" in 3" increments

Notes:

Connector harness is used to connect two power modules together

Refer to installation guide for connector harness length calculation

Code	Price	Length	D	Weight (lb.)	Volume (ft ³)
L-EH84-22	182	22	0.75	0.6	0.20
L-EH84-25	191	25	0.75	0.7	0.20
L-EH84-28	196	28	0.75	0.8	0.20
L-EH84-31	204	31	0.75	0.8	0.20
L-EH84-34	211	34	0.75	0.9	0.20
L-EH84-37	215	37	0.75	1	0.20
L-EH84-40	220	40	0.75	1.1	0.20
L-EH84-43	224	43	0.75	1.2	0.20
L-EH84-46	236	46	0.75	1.3	0.20
L-EH84-49	241	49	0.75	1.5	0.20
L-EH84-52	247	52	0.75	1.5	0.20
L-EH84-55	252	55	0.75	1.6	0.20
L-EH84-58	260	58	0.75	1.7	0.20
L-EH84-61	264	61	0.75	1.8	0.20
L-EH84-64	272	64	0.75	1.9	0.20
L-EH84-67	279	67	0.75	1.9	0.20
L-EH84-70	291	70	0.75	2	0.20
L-EH84-73	298	73	0.75	1.95	0.20
L-EH84-76	303	76	0.75	2.04	0.20
L-EH84-79	311	79	0.75	2.12	0.20
L-EH84-82	317	82	0.75	2.12	0.20
L-EH84-85	323	85	0.75	2.37	0.20
L-EH84-88	328	88	0.75	2.37	0.20
L-EH84-91	333	91	0.75	2.37	0.20

Power & Data continued

Code	Price	Length	D	Weight (lb.)	Volume (ft ³)
L-EH84-94	342	94	0.75	2.53	0.20
L-EH84-97	348	97	0.75	2.53	0.20
L-EH84-100	353	100	0.75	2.7	0.20
L-EH84-103	358	103	0.75	2.7	0.20
L-EH84-106	367	106	0.75	2.86	0.20
L-EH84-109	369	109	0.75	2.86	0.20
L-EH84-112	375	112	0.75	3.03	0.20
L-EH84-115	386	115	0.75	3.03	0.20
L-EH84-118	391	118	0.75	3.19	0.20
L-EH84-121	394	121	0.75	3.36	0.20
L-EH84-124	403	124	0.75	3.36	0.20
L-EH84-127	409	127	0.75	3.52	0.20
L-EH84-130	416	130	0.75	3.52	0.20
L-EH84-133	422	133	0.75	3.39	0.20
L-EH84-136	428	136	0.75	3.69	0.20
L-EH84-139	433	139	0.75	3.85	0.20
L-EH84-142	595	142	0.75	3.85	0.20
L-EH84-145	601	145	0.75	3.85	0.20
L-EH84-148	610	148	0.75	3.85	0.20
L-EH84-151	614	151	0.75	4.18	0.20
L-EH84-154	623	154	0.75	4.26	0.20
L-EH84-157	629	157	0.75	4.35	0.20
L-EH84-160	635	160	0.75	4.43	0.20
L-EH84-163	640	163	0.75	4.51	0.20
L-EH84-166	648	166	0.75	4.59	0.20
L-EH84-169	652	169	0.75	4.68	0.20
L-EH84-172	658	172	0.75	4.76	0.20
L-EH84-175	665	175	0.75	4.84	0.20
L-EH84-178	673	178	0.75	4.92	0.20
L-EH84-181	677	181	0.75	5.01	0.20

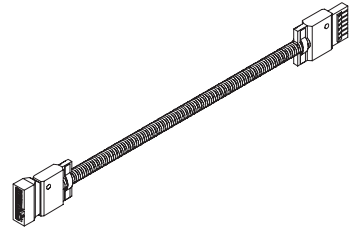

What's Included:

One (1) male to female extension harness

How to Specify:

Available in grey only
Single sided, double sided

Options:

Length: 44",122"

Notes:

Male to female extension harness is used to extend length of the starter harness

Code	Price	Length	D	Weight (lb.)
L-E8FM-044	252	44	0.75	0.3
L-E8FM-122	441	122	0.75	0.6

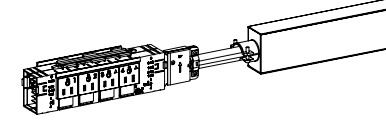

What's Included:

Panels 24", 30", 36" wide: One (1) New York junction box

Panels 42" or wider: One (1) New York junction box with single or double power module

How to Specify:

Panels 24", 30", 36" wide: Specify junction box without power module. Power module and starter harness must be specified speratley

Panels 42" or wider: Specify single or double power module with junction box

Options:

Junction Box width: 9"

Junction Box with power module width: 18"

Notes:

Male to female extension harness is used to extend length of the starter harness

Code	Price	Length	D	Weight (lb.)
L-NY84-004-D	758			
L-NY84-004-S	620			
L-NYEJ-84	215			

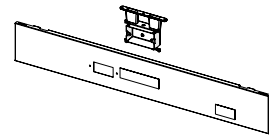

Single sided

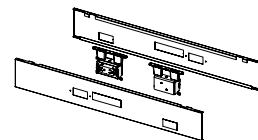

Double sided

What's Included:

Single Sided: One (1) electrical box with two (2) ac outlets and one (1) panel raceway

Double Sided: Two (2) single sided electrical boxes each with two (2) ac outlets and two (2) panel raceways

How to Specify:

Select corresponding size to match the panel width

Options:

Width: 30", 36", 42", 48", 54", 60", 72"

Notes:

Junction box is located on the left hand side of the panel

Code	Price	Length	W	Weight (lb.)
Single Sided				
L-JB0X-30-S	355	30		
L-JB0X-36-S	355	36		
L-JB0X-42-S	355	42		
L-JB0X-48-S	355	48		
L-JB0X-54-S	355	54		
L-JB0X-60-S	355	60		
Double Sided				
L-JB0X-30-D	709	30		
L-JB0X-36-D	709	36		
L-JB0X-42-D	709	42		
L-JB0X-48-D	709	48		
L-JB0X-54-D	709	54		
L-JB0X-60-D	709	60		



for 3 way connection(3W)



for 4 way connection(4W)



For 90 Degree Connection (N)

What's Included:

One (1) power pole, chosen mounting hardware

How to Specify:

Specify type based on panel connection: 90 degree, 3-way T, 4 way X and gallery panel mount

90 degree, 3-way T and 4-way X must be used with same height connecting panels

Use gallery panel mount type at the end of a run

Notes:

Options:

Connector type height: 96", 120"

Gallery panel height: 144"

Code	Price	H	W	D	Weight (lb.)	Volume (ft ³)
standard panel						
L-EP-P-120-3W	612	120	2	2	2	0.28
L-EP-P-120-4W	612	120	2	2	2	0.28
L-EP-P-120-N	612	120	2	2	2	0.28
L-EP-P-96-3W	533	96	2	2	1.5	0.22
L-EP-P-96-4W	533	96	2	2	1.5	0.22
L-EP-P-96-N	533	96	2	2	2	0.22
gallery panel						
L-EP-Y-144	734	144	2	2	2	0.33

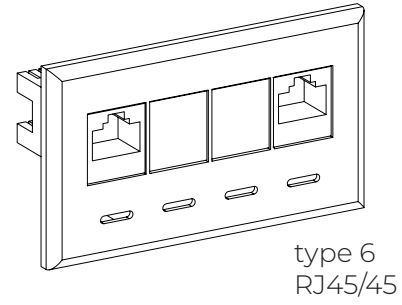
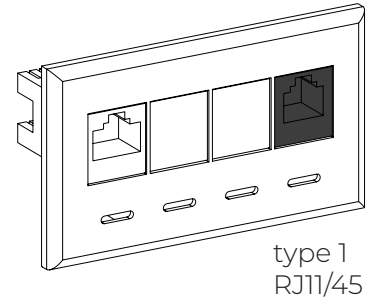

What's Included:

One (1) data plate with three (3) openings and chosen combination of RJ11/RJ45

How to Specify:

Specify RJ11 for phone connection
Specify RJ45 for data connection

Notes:

Data is placed on the right hand side of the cutout in the panel raceway

Options:

Panel cutout width: 2 3/4"

Panel cutout height: 1 3/8"

Code	Price	H	W	D	Weight (lb.)	Volume (ft ³)
type 1						
L-ECK1	281	2	4	1	0.24	0.00
type 6						
L-ECK6	241	2	4	1	0.24	0.00

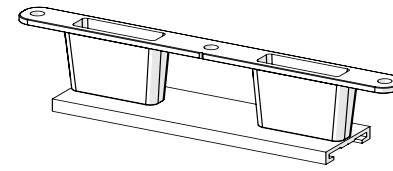

Non-Power Capable to Power Capable Panel Conversion Kit

What's Included:

One (1) power module mounting bracket

How to Specify:

Specify RJ11 for phone connection
Specify RJ45 for data connection

Notes:

Used to convert a non-power capable panel to a power capable panel

To be placed in the of the non-power capable panel raceway to convert to a power capable

Power module to be specified seperately

Options:

Code	Price	Weight (lb.)	Volume (ft ³)
RI-0300	25		



Switch Canada Pricebook
April 2025
Storage

Storage

Pedestals	190
Underdesk Pedestal	190
Mobile	191
Upholstered Seat Pad	192
Lateral File	193
Underdesk	193
Freestanding	194
Credenza	195
Open Lateral	195
Storage Tower	196
Wardrobe Tower	197
Combo Tower	198
w/ Front Access	198
w/ Side Access	200
Panel Mounted Overheads - Cabinet	202
Flipper	202
Hinged Door	203
Shared	204
Cubby	206
Metal Shelf	207

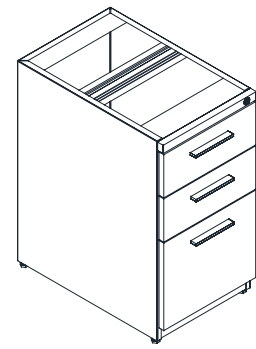

box/box/file

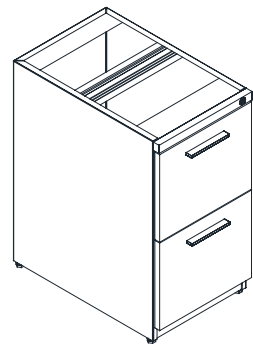

file/file

What's Included:

One (1) box/box/file or one (1) file/file underdesk pedestal

How to Specify:

Pedestal type: box/box/file, file/file

Notes:

Pedestal brackets must be ordered seperately

Locks can be keyed alike or random

Options:

Height: 28"

Width: 16"

Depth: 23", 29"

Code	Price	H	W	D	Weight (lb.)	Volume (ft ³)
box/box/file						
L-FPBU-281623	922	28	16	23	64.4	5.96
L-FPBU-281629	1076	28	16	29	81.2	7.52
file/file						
L-FPFU-281623	922	28	16	23	64.4	5.96
L-FPFU-281629	968	28	16	29	81.2	7.52

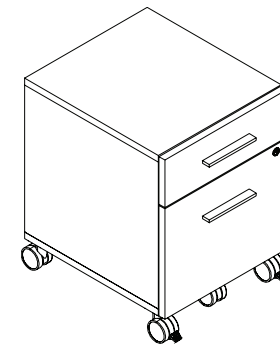

box/ file/no cushion

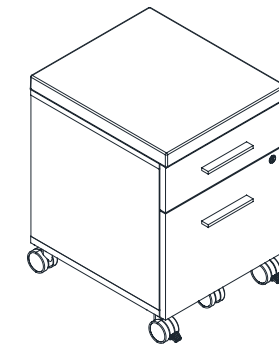

box/file w/ cushion

What's Included:

One (1) box/file mobile pedestal or one (1) box/file mobile pedestal with cushion, five (5) lockable casters

How to Specify:

With or without cushion

Refer to seating fabric card for cushion fabric selection

Choose handle type and finish

Choose depth

Choose silver or white for caster finish

Notes:

Locks can be keyed alike or random

Options:

Height: 21" without cushion, 22" with cushion

Width: 16"

Depth: 18"

Code	Price	H	W	D	Weight (lb.)	Volume (ft ³)
box/file/no cushion						
L-FPL0-211618	1220	21	16	18	43.2	3.50
box/file w/ cushion						
L-FPLS-221618	1270	22	16	18	45.26	3.67

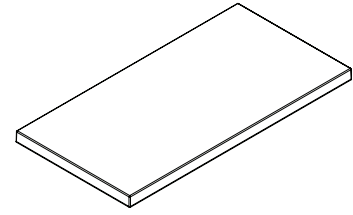

What's Included:

One (1) upholstered seat pad

How to Specify:

Refer to seating fabric card for fabric selection

Notes:

Options:

Height:	1"
Width:	24", 30", 36", 48", 60", 72"
Depth:	18"

Code	Price	H	W	D	Weight (lb.)	Volume (ft ³)
L-PAD-1824	387	24	24	2	2.4	0.67
L-PAD-1830	445	24	30	2	3	0.83
L-PAD-1836	511	24	36	2	3.6	1.00
L-PAD-1848	603	24	48	2	4.8	1.33
L-PAD-1860	698	24	60	2	6	1.67
L-PAD-1872	790	24	72	2	7.2	2.00

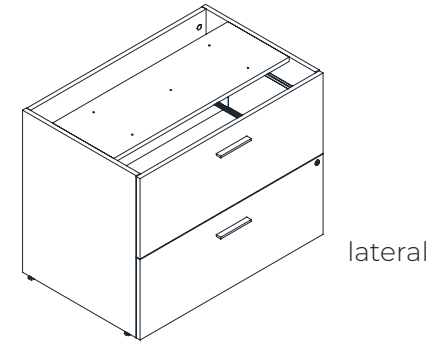

What's Included:

One (1) two drawer underdesk lateral filing cabinet, each drawer is equipped with (2) bars for front to back filing

How to Specify:

Refer to laminate card for laminate selection
 Choose handle type and finish
 Choose depth

Notes:

Lateral brackets must be ordered separately
 Locks can be keyed alike or random

Options:

Height:	28"
Width:	30", 36"
Depth:	23", 29"

Code	Price	H	W	D	Weight (lb.)	Volume (ft ³)
underdesk 2 Drawer						
L-FL2U-283023	2014	28	30	23	107.33	11.18
L-FL2U-283029	2047	28	30	29	135.33	14.10
L-FL2U-283623	2201	28	36	23	128.8	13.42
L-FL2U-283629	2236	28	36	29	162.4	16.92

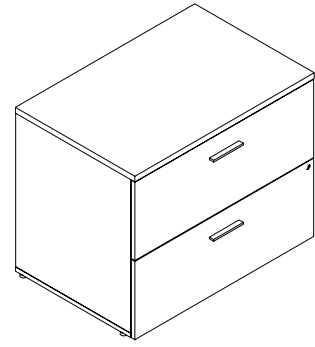

2 Drawer

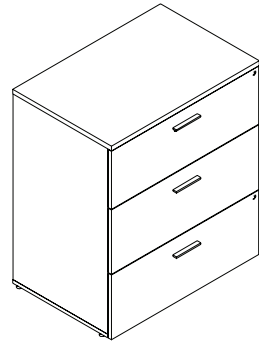

3 drawer

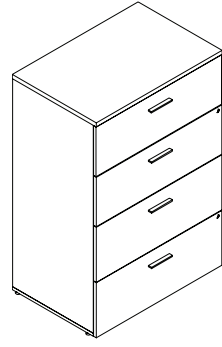

4 drawer

What's Included:

One (1) two drawer, three drawer or four drawer freestanding lateral filing cabinet with finished top, each drawer is equipped with (2) bars for front to back filing

How to Specify:

- Refer to laminate card for laminate selection
- Choose two drawer, three drawer or four drawers
- Choose handle type and finish
- Choose silver or white for caster finish

Options:

- Height: 29" for 2 drawer, 42" for 3 drawer, 54" for 4 drawer
- Width: 30", 36"
- Depth: 24"

Notes:

Locks can be keyed alike or random

Code	Price	H	W	D	Weight (lb.)	Volume (ft ³)
2 Drawer						
L-FL2F-293024	1917	29	30	24	116	12.08
L-FL2F-293624	1917	29	36	24	139.2	14.50
3 drawer						
L-FL3F-423024	2052	42	30	24	168	17.50
L-FL3F-423624	2176	42	36	24	201.6	21.00
4 drawer						
L-FL4F-543024	2577	54	30	24	216	22.50
L-FL4F-543624	2730	54	36	24	259.2	27.00

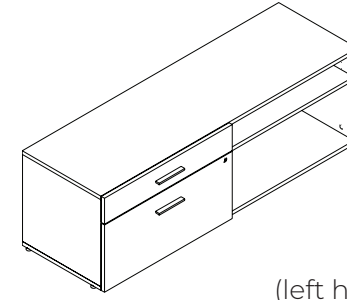

(left hand shown)

What's Included:

One (1) open lateral credenza, one (1) adjustable shelf for open cabinet

How to Specify:

- Choose right hand or left hand
- Refer to laminate card for laminate selection
- Choose handle type and finish

Options:

- Height: 22"
- Width: 48", 60", 72"
- Depth: 18"

Notes:

- Locks can be keyed alike or random
- Right handed has lateral on right side
- Left handed has lateral on left side
- Can be used as a surface support credenza, with credenza fixed support specified separately

Code	Price	H	W	D	Weight (lb.)	Volume (ft ³)
Left hand						
L-CRCL-224818-L	1176	22	48	18	115.2	11.00
L-CRCL-226018-L	1288	22	60	18	144	13.75
L-CRCL-227218-L	1427	22	72	18	172.8	16.50
Right hand						
L-CRCL-224818-R	1176	22	48	18	115.2	11.00
L-CRCL-226018-R	1288	22	60	18	144	13.75
L-CRCL-227218-R	1427	22	72	18	172.8	16.50

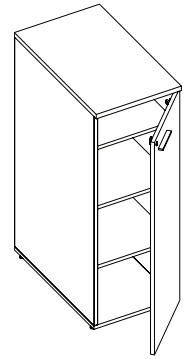

left hand shown

What's Included:

One (1) storage tower with one (1) adjustable shelf and (1) fixed shelf for 42" high or two (2) adjustable shelves and (1) fixed shelf for 50" high

How to Specify:

- Choose right hand or left hand
- Refer to laminate card for laminate selection
- Choose handle type and finish

Options:

Height:	42", 50"
Width:	18"
Depth:	24", 30"

Notes:

- Locks can be keyed alike or random
- Right handed has hinge on right side
- Left handed has hinge on left side

Code	Price	H	W	D	Weight (lb.)	Volume (ft ³)
Left hand						
L-FTSS-421824-L	1508	42	18	24	86.4	10.50
L-FTSS-421830-L	1535	42	18	30	108	13.13
L-FTSS-501824-L	1535	50	18	24	102.86	12.50
L-FTSS-501830-L	1551	50	18	30	128.57	15.63
Right hand						
L-FTSS-421824-R	1508	42	18	24	86.4	10.50
L-FTSS-421830-R	1535	42	18	30	108	13.13
L-FTSS-501824-R	1535	50	18	24	102.86	12.50
L-FTSS-501830-R	1551	50	18	30	128.57	15.63

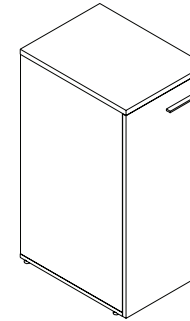

left hand shown

What's Included:

One (1) wardrobe tower, one (1) coat bar

How to Specify:

- Choose right hand or left hand
- Refer to laminate card for laminate selection
- Choose handle type and finish

Options:

Height:	42", 50"
Width:	18"
Depth:	24", 30"

Notes:

- Locks can be keyed alike or random
- Right handed has hinge on right side
- Left handed has hinge on left side

Code	Price	H	W	D	Weight (lb.)	Volume (ft ³)
Left hand						
L-FTCS-421824-L	1168	42	18	24	86.4	10.50
L-FTCS-421830-L	1246	42	18	30	108	13.13
L-FTCS-501824-L	1291	50	18	24	102.86	12.50
L-FTCS-501830-L	1398	50	18	30	128.57	15.63
Right hand						
L-FTCS-421824-R	1168	42	18	24	86.4	10.50
L-FTCS-421830-R	1246	42	18	30	108	13.13
L-FTCS-501824-R	1291	50	18	24	102.86	12.50
L-FTCS-501830-R	1398	50	18	30	128.57	15.63

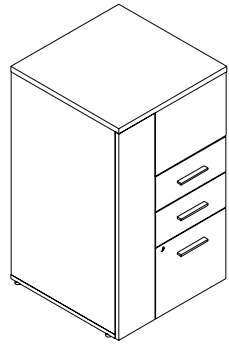

(left hand shown)

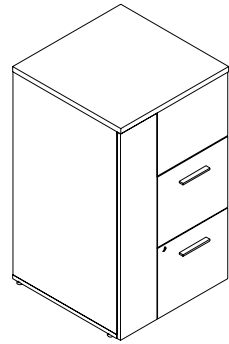

(left hand shown)

What's Included:

One (1) combo tower with front access, one (1) coat bar, one (1) adjustable shelf and (1) fixed shelf for 42" high or two (2) adjustable shelves and (1) fixed shelf for 50" high

How to Specify:

- Choose right hand or left hand
- Refer to laminate card for laminate selection
- Choose handle type and finish
- Choose box/box/file, file/file drawers

Notes:

- Locks can be keyed alike or random
- Right handed has door on right side
- Left handed has door on left side

Options:

Height:	42", 50"
Width:	24"
Depth:	24", 30"

Code	Price	H	W	D	Weight (lb.)	Volume (ft ³)
box/box/file pedestal -left hand						
L-CWTB-422424-L	2571	42	24	24	127	14.00
L-CWTB-422430-L	2582	42	24	30	159	18.00
L-CWTB-502424-L	2582	50	24	24	152	17.00
L-CWTB-502430-L	2592	50	24	30	189	21.00
box/box/file pedestal - right hand						
L-CWTB-422424-R	2571	42	24	24	127	14.00
L-CWTB-422430-R	2582	42	24	30	159	18.00
L-CWTB-502424-R	2582	50	24	24	152	17.00
L-CWTB-502430-R	2592	50	24	30	189	21.00
file/file pedestal - left hand						
L-CWTF-422424-L	2474	42	24	24	127	14.00
L-CWTF-422430-L	2474	42	24	30	159	18.00
L-CWTF-502424-L	2474	50	24	24	152	17.00
L-CWTF-422430-L	2474	42	24	30	159	18.00
file/file pedestal - right hand						
L-CWTF-422424-R	2474	42	24	24	127	14.00
L-CWTF-422430-R	2474	42	24	30	159	18.00
L-CWTF-502424-R	2474	50	24	24	152	17.00
L-CWTF-502430-R	2474	50	24	30	189	21.00

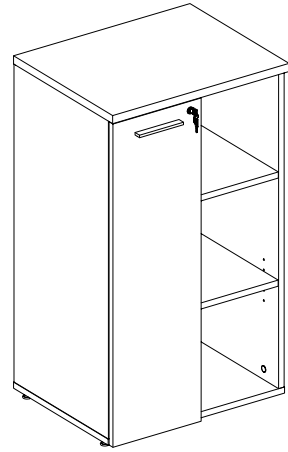

left hand shown

What's Included:

One (1) combo tower with side access, one (1) coat bar, (1) box/box/file or (1) file/file drawers, (1) cubby for 42" high or two (2) cubbies for 50" high

How to Specify:

- Choose right hand or left hand
- Refer to laminate card for laminate selection
- Choose handle type and finish
- Choose box/box/file, file/file drawers

Notes:

- Locks can be keyed alike or random
- Right handed has door on right side
- Left handed has door on left side

Options:

Height:	42", 50"
Width:	24"
Depth:	18.75", 24", 30"

Code	Price	H	W	D	Weight (lb.)	Volume (ft ³)
Left Hand						
L-FTCO-422418-L	1518	41	24	18.75	85	11.00
L-FTCO-422424-L	1683	41	24	24	101	14.00
L-FTCO-422430-L	1890	41	24	30	121	17.00
L-FTCO-502418-L	1747	49	24	18.75	97	13.00
L-FTCO-502424-L	1941	49	24	24	115	16.00
L-FTCO-502430-L	2180	49	24	30	138	21.00
Right hand						
L-FTCO-422418-R	1518	41	24	18.75	85	11.00
L-FTCO-422424-R	1683	41	24	24	101	14.00
L-FTCO-422430-R	1890	41	24	30	121	17.00
L-FTCO-502418-R	1747	49	24	18.75	97	13.00
L-FTCO-502424-R	1941	49	24	24	115	16.00

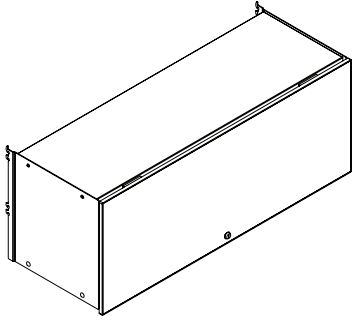

What's Included:

One (1) flipper cabinet

How to Specify:

Choose metal or laminate face

Choose white, black, silver, charcoal for metal face and body

Refer to laminate card for laminate face options

Notes:

Locks can be keyed alike or random

Flipper cabinet slides are easy-down pneumatic

Options:

Height*: 16"

Width: 30", 36", 42", 48", 54", 60"

Depth**: 15"

* Internal cabinet height is 13"

** Internal cabinet depth is 13"

Code	Price	H	W	D	Weight (lb.)	Volume (ft ³)
laminate face w/pneumatic slides						
L-SPFL-1530-P	1353	16	30	15	32.727273	4.17
L-SPFL-1536-P	1430	16	36	15	39.272727	5.00
L-SPFL-1542-P	1503	16	42	15	45.818182	5.83
L-SPFL-1548-P	1578	16	48	15	52.363636	6.67
L-SPFL-1554-P	1649	16	54	15	58.909091	7.50
L-SPFL-1560-P	1724	16	60	15	65.46	8.33
metal face w/pneumatic slides						
L-SPFM-1530-P	1461	16	30	15	32.727273	4.17
L-SPFM-1536-P	1536	16	36	15	39.272727	5.00
L-SPFM-1542-P	1610	16	42	15	45.818182	5.83
L-SPFM-1548-P	1685	16	48	15	52.363636	6.67
L-SPFM-1554-P	1759	16	54	15	58.909091	7.50
L-SPFM-1560-P	1833	16	60	15	65.46	8.33

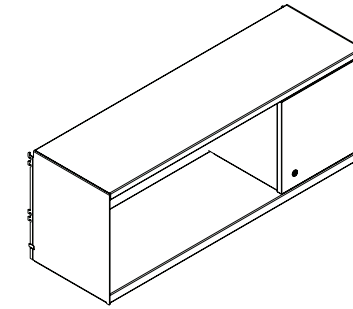
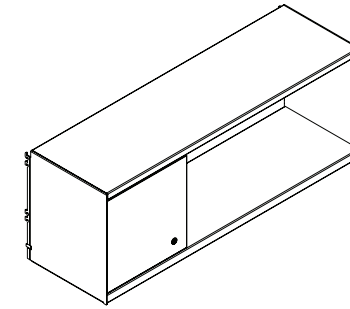

What's Included:

One (1) hinged cabinet, one (1) 12" wide hinged door

How to Specify:

Choose white, black, silver, charcoal for metal body

Refer to laminate card for laminate face options

Door on right or left side

Notes:

Locks can be keyed alike or random

OL refers to open on left side

LO refers to open on right side

Options:

Height*: 16"

Width: 36", 42", 48", 54", 60"

Depth**: 12"

* Internal cabinet height is 13"

** Internal cabinet depth is 12"

Code	Price	H	W	D	Weight (lb.)	Volume (ft ³)
closed/open						
L-SPLO-1536	1025	16	36	15	43.2	5.00
L-SPLO-1542	1091	16	42	15	50.4	5.83
L-SPLO-1548	1117	16	48	15	57.6	6.67
L-SPLO-1554	1188	16	54	15	64.8	7.50
L-SPLO-1560	1210	16	60	15	72	8.33
open/closed						
L-SPOL-1536	1025	16	36	15	43.2	5.00
L-SPOL-1542	1091	16	42	15	50.4	5.83
L-SPOL-1548	1117	16	48	15	57.6	6.67
L-SPOL-1554	1188	16	54	15	64.8	7.50
L-SPOL-1560	1210	16	60	15	72	8.33

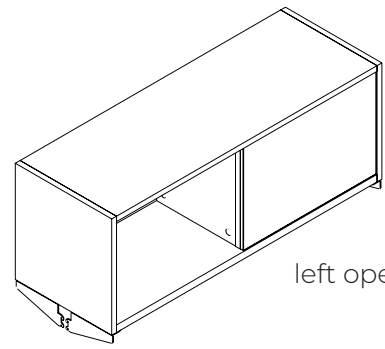

left open/right tackboard

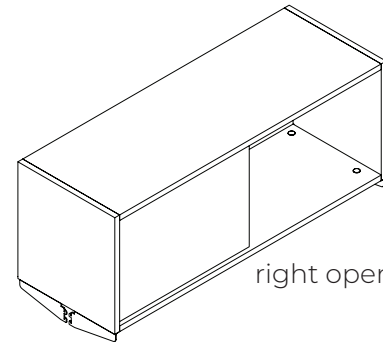

right open/ left melamine

What's Included:

One (1) shared cabinet, (1) tackboard if tackboard option is selected, four (4) panel mount cantilevers for up to 60"W or six (6) panel mount cantilevers for 66", 72"W

How to Specify:

- Choose white, black, silver, charcoal for cantilever
- Refer to laminate card for laminate face options
- Refer to panel fabric card for tackboard fabric options

Notes:

- OM refers to open on left side
- MO refers to open on right side
- OT refers to open on left side with tackboard on right side
- TO refers to open on right side with tackboard on left side

Options:

Height*:	16"
Width:	36", 42", 48", 54", 60", 66", 72
Depth**:	15"

* Internal cabinet height is 13" ** Internal cabinet depth is 13.5"

Code	Price	H	W	D	Weight (lb.)	Volume (ft ³)
left open/right tackboard						
L-STOT-161536	883	16	36	15	43.2	5.00
L-STOT-161542	939	16	42	15	50.4	5.83
L-STOT-161548	1001	16	48	15	57.6	6.67
L-STOT-161554	1056	16	54	15	64.8	7.50
L-STOT-161560	1117	16	60	15	72	8.33
L-STOT-161566	1176	16	66	15	79.2	9.17
L-STOT-161572	1233	16	72	15	86.4	10.00
right open/ left tackboard						
L-STTO-161536	883	16	36	15	43.2	5.00
L-STTO-161542	939	16	42	15	50.4	5.83
L-STTO-161548	1001	16	48	15	57.6	6.67
L-STTO-161554	1056	16	54	15	64.8	7.50
L-STTO-161560	1117	16	60	15	72	8.33
L-STTO-161566	1176	16	66	15	79.2	9.17
L-STTO-161572	1233	16	72	15	86.4	10.00

Code	Price	H	W	D	Weight (lb.)	Volume (ft ³)
right open/left melamine						
L-STMO-161536	663	16	36	15	43.2	5.00
L-STMO-161542	714	16	42	15	50.4	5.83
L-STMO-161548	764	16	48	15	57.6	6.67
L-STMO-161554	813	16	54	15	64.8	7.50
L-STMO-161560	864	16	60	15	72	8.33
L-STMO-161566	915	16	66	15	79.2	9.17
L-STMO-161572	966	16	72	15	86.4	10.00
left open/right melamine						
L-STOM-161536	663	16	36	15	43.2	5.00
L-STOM-161542	714	16	42	15	50.4	5.83
L-STOM-161548	764	16	48	15	57.6	6.67
L-STOM-161554	813	16	54	15	64.8	7.50
L-STOM-161560	864	16	60	15	72	8.33
L-STOM-161566	915	16	66	15	79.2	9.17
L-STOM-161572	966	16	72	15	86.4	10.00

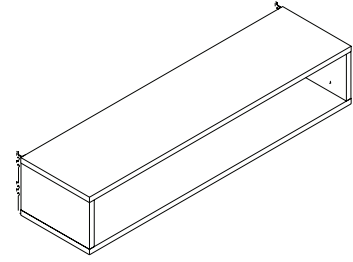

What's Included:

One (1) open cubby, two (2) mounting brackets

How to Specify:

Refer to laminate card for laminate face options

Notes:

Options:

Height*:	8"
Width:	24", 30", 36", 42", 48"
Depth**:	11"

* Internal cabinet height is 6.5"

** Internal cabinet depth is 11"

Code	Price	H	W	D	Weight (lb.)	Volume (ft ³)
L-SCS-081124	388	8	24	15	24	1.67
L-SCS-081130	403	8	30	15	27	2.08
L-SCS-081136	421	8	36	15	30	2.50
L-SCS-081142	435	8	42	15	33	2.92
L-SCS-081148	455	8	48	15	36	3.33

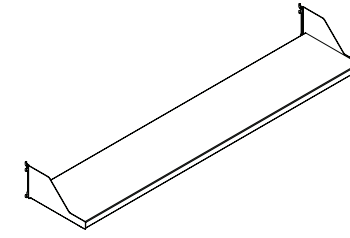

What's Included:

One (1) metal shelf

How to Specify:

Choose white, black, silver, charcoal for metal shelf

Notes:

Options:

Height:	6"
Width:	30", 36", 42", 48", 54", 60"
Depth:	12"

Code	Price	H	W	D	Weight (lb.)	Volume (ft ³)
L-SOOM-1230	317	2	30	12	14.4	0.42
L-SOOM-1236	332	2	36	12	17.28	0.50
L-SOOM-1242	350	2	42	12	20.16	0.58
L-SOOM-1248	368	2	48	12	23.04	0.67
L-SOOM-1254	375	2	54	12	25.92	0.75
L-SOOM-1260	402	2	60	12	28.8	0.83



Switch Canada Pricebook
April 2025

Accessories

Accessories

<u>Cable manager</u>	210
<u>Desktop Power Module</u>	211
<u>Tasklight</u>	212
<u>Monitor Arm</u>	213
<u>Keyboard Tray</u>	214
<u>Work Organizers</u>	215
<u>Accessory Rail</u>	216
<u>Pencil Tray</u>	217

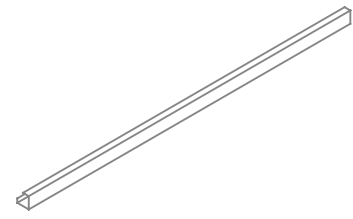

What's Included:

One (1) cable manager

How to Specify:

Available in black only

Dimensions:

length 12", 18", 24", 30", 36", 42", 48", 54", 60", 66", 72"

Notes:

Code	Price	H	W	D	Weight (lb.)	Volume (ft ³)
L-EWHB-12	8	1.5	12	1.5	0.15	0.02
L-EWHB-18	11	1.5	18	1.5	0.25	0.02
L-EWHB-24	16	1.5	24	1.5	0.35	0.03
L-EWHB-30	21	1.5	30	1.5	0.45	0.04
L-EWHB-36	24	1.5	36	1.5	0.55	0.05
L-EWHB-42	27	1.5	42	1.5	0.65	0.05
L-EWHB-48	30	1.5	48	1.5	0.75	0.06
L-EWHB-54	33	1.5	54	1.5	0.85	0.07
L-EWHB-60	38	1.5	60	1.5	0.95	0.08
L-EWHB-66	42	1.5	66	1.5	1.05	0.09
L-EWHB-72	44	1.5	72	1.5	1.15	0.09

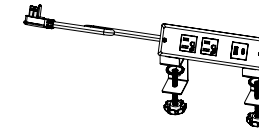

What's Included:

Clamp mount desktop power module equipped with two ac outlets, one USB A and one USB C charging ports, and one (1) three prong cord

How to Specify:

Can be used on freestanding surface or surface with 1" wireplay if connected to a panel

Available in black only

Dimensions:

Cord length: 120"

Power Module Width: 8"

Notes:

Clamp requires 1 3/4" x 8 1/8" undersurface clearance

Code	Price	H	W	D	Weight (lb.)	Volume (ft ³)
V-EMW-2AC	191	6	4	3	1.0	0.04

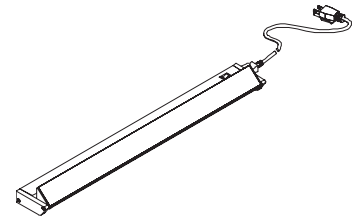

What's Included:

One (1) fluorescent task light

How to Specify:

One size smaller than the width of the overhead

Available in silver only

Dimensions:

Length: 24", 36", 48"

Notes:

Task light can be mounted to metal or laminate overheads

Task light mounts to metal overheads using supplied magnets

Code	Price	H	W	D	Weight (lb.)	Volume (ft ³)
V-ELU-24	316	3	24	1	9.5	0.04
V-ELU-36	355	3	36	1	13.7	0.06
V-ELU-48	446	3	48	1	17.9	0.08

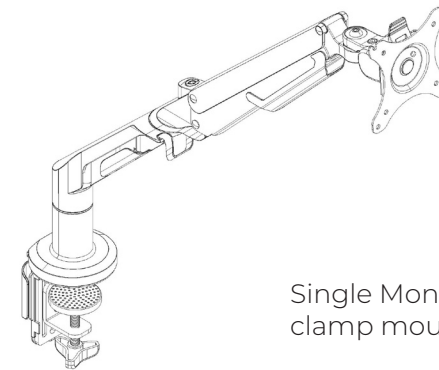

Single Monitor Arm - clamp mount

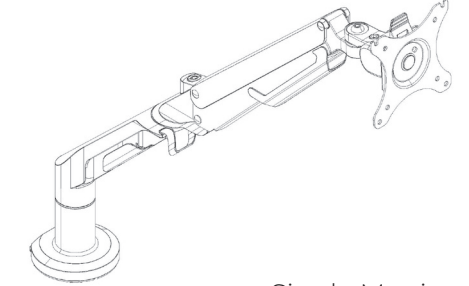

Single Monitor Arm - grommet mount

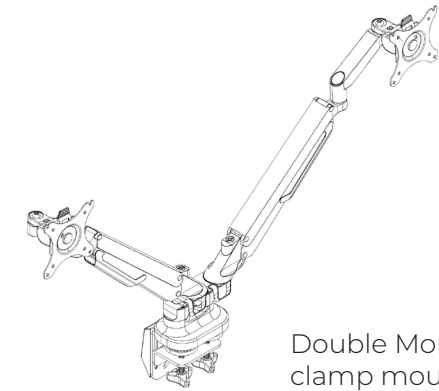

Double Monitor Arm - clamp mount

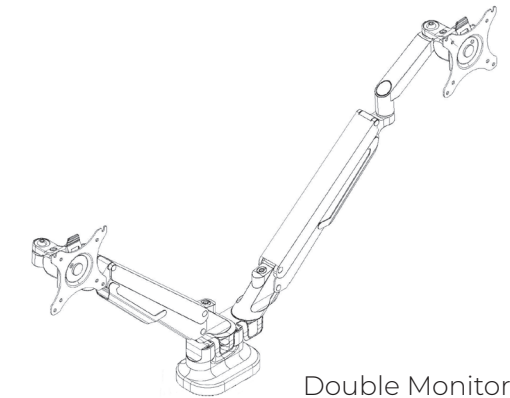

Double Monitor Arm - grommet mount

What's Included:

One monitor arm and installation hardware for both clamp and grommet mount

How to Specify:

- Specify type

Notes:

Available in silver only

Single Monitor Arm

- Screen Size - 17"-36"
- Load Capacity - 6.6-26.4lbs/3-12kg
- Tilt Range - -90 degrees - -15 degrees

Dual Monitor Arm

- Screen Size - 17"-32"
- Load Capacity - 4.4-19.8lbs/2-9kg
- Tilt Range - -90 degrees - -15 degrees

Dimensions:

Vesa: 75x75 and 100x100

Code	Price
Monitor Arm - Single Mount	
V-AFMA-01	391
Monitor Arm - Double Mount	
V-AFMA-02	652

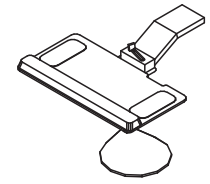

Articulating Keyboard Tray w/Mouse Tray

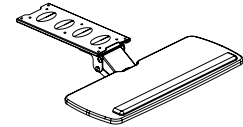

Articulating Keyboard Tray

What's Included:

Keyboard Tray, installation hardware.

How to Specify:

Specify laminate color for retractable keyboard. The vinyl trim color will default to match the laminate color unless otherwise specified. See the laminate finish card for details.

For articulating keyboard with mouse, right or left hand must be specified.

The articulating keyboards are available only in black.

Notes:

Keyboard trays provide adjustable ergonomic support for individuals in multi-task environments

Options:

Hand: **R** right **L** left (for adjustable keyboard with mouse only)

Code	Price	H	W	D	Volume (ft ³)	Weight (lb)
Articulating Keyboard Tray w/Mouse Tray						
V-KAS0-2011-L	657	0	20	11	0	3
V-KAS0-2011-R	657	0	20	11	0	3
Articulating Keyboard Tray						
V-KASX-2510	421	0	25	10	0	15

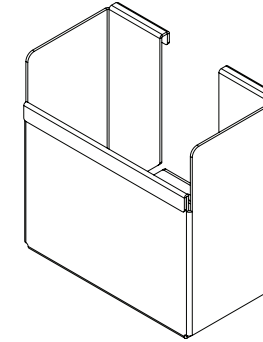

pencil holder

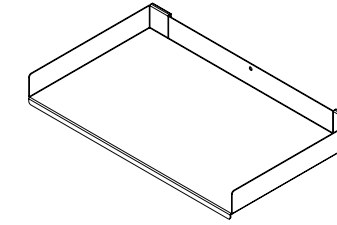

paper tray - legal

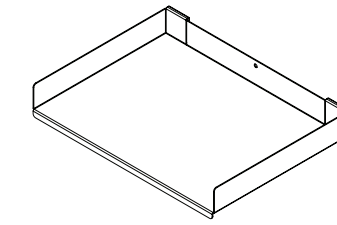

paper tray - letter

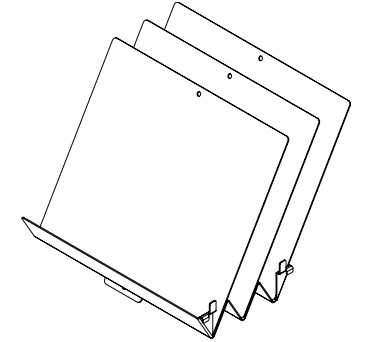

document sorter

What's Included:

One (1) paper tray or one (1) paper holder or one (1) paper sorter

How to Specify:

Refer to metal paint card for metal paint colors

Notes:

Dimensions:

Code	Price	H	W	D	Weight (lb.)	Volume (ft ³)
pen holder						
L-AAP0	139	6	4	2	0.32	
paper tray - legal						
L-AAP-13	164	11	13	1	3.2	
paper tray - letter						
L-AAP-9	144	11	9	1	2.1	
paper sorter						
L-AAS	247	10	10	10	3.2	

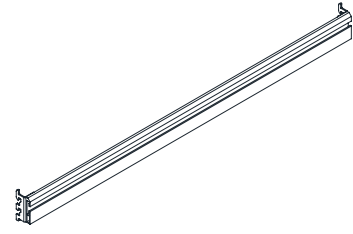

What's Included:

One (1) panel mount or wall mount accessory rail

How to Specify:

Panel mount, wall mount

Refer to metal paint card for metal paint colours

Notes:

Dimensions:

Width: 24", 30", 36", 42", 48", 54", 60"

Code	Price	H	W	D	Weight (lb.)	Volume (ft ³)
Panel Mounted						
L-AR-24	236	3	24	0.75	0.77	
L-AR-30	245	3	30	0.75	0.86	
L-AR-36	250	3	36	0.75	0.95	
L-AR-42	261	3	42	0.75	1.04	
L-AR-48	270	3	48	0.75	1.13	
L-AR-54	277	3	54	0.75	1.22	
L-AR-60	285	3	60	0.75	1.31	
Wall Mounted						
L-AR-24-W	236	3	24	0.75	0.77	
L-AR-30-W	245	3	30	0.75	0.86	
L-AR-36-W	250	3	36	0.75	0.95	
L-AR-42-W	261	3	42	0.75	1.04	
L-AR-48-W	270	3	48	0.75	1.13	
L-AR-54-W	277	3	54	0.75	1.22	
L-AR-60-W	285	3	60	0.75	1.31	

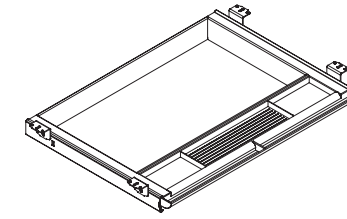

What's Included:

One (1) pencil tray

How to Specify:

Available in black only

Notes:

Available in black only

Dimensions:

Width: 24"

Depth: 16"

Code	Price	H	W	D	Weight (lb.)	Volume (ft ³)
V-ADPP	92	14	21	2	1.8	0.34