



# Metro Collab Pricebook August 2024

TIPS Contract 240301  
Furniture, Furnishings, and Services

# Contents

overview	9
application guidelines Step 1	10
application guidelines Step 2	11
application guidelines Step 3	12
application guidelines Step 4	13
application guidelines Step 5	14
application guidelines Map	15
application guidelines Grain direction	16
caution	17
straight desk	19
straight desk   executive	20
straight desk   professional	22
straight partial modesty   executive	24
straight partial modesty   professional	26
straight full recessed modesty   executive	28
straight full recessed modesty   professional	30
arc full recessed modesty   executive	32
arc full recessed modesty   professional	33
tables	35
D-table   executive	36
D-table   professional	37
K-table   executive	38

K-table   professional	39
J-table   executive	40
J-table   professional	41
P-table   executive	42
P-table   professional	43
F-table   executive	44
F-table   professional	45
U-table   executive	46
U-table   professional	47
C-table   executive	48
C-table   professional	49
corners	51
straight front corner surface   full modesty   executive	52
straight front corner surface   full modesty   professional	53
straight front corner surface   partial modesty   executive	54
straight front corner surface   partial modesty   professional	55
curved front corner surface   full modesty   executive	56
curved front corner surface   full modesty   professional	57
curved front corner surface   partial modesty   executive	58
curved front corner surface   partial modesty   professional	59
unitized desks	61
curved front unitized desk   full modesty   executive	62
curved front unitized desk   full modesty   professional	63
curved front unitized desk   partial modesty   executive	64
curved front unitized desk   partial modesty   professional	65

**bridges 67**

straight bridge   full modesty   executive	68
straight bridge   full modesty   professional	69
straight bridge   partial modesty   executive	70
straight bridge   partial modesty   professional	71
notched bridge   full modesty   executive	72
notched bridge   full modesty   professional	73
notched bridge   partial modesty   executive	74
notched bridge   partial modesty   professional	75
bowed bridge   full modesty   executive	76
bowed bridge   full modesty   professional	77
bowed bridge   partial modesty   executive	78
bowed bridge   partial modesty   professional	79

**returns 81**

straight return   full modesty   executive	82
straight return   full modesty   professional	84
straight return   partial modesty   executive	86
straight return   partial modesty   professional	88
notched return   full modesty   executive	90
notched return   full modesty   professional	92
notched return   partial modesty   executive	94
notched return   partial modesty   professional	96
bowed return   full modesty   executive	98
bowed return   full modesty   professional	100

bowed return   partial modesty   executive	102
bowed return   partial modesty   professional	104
intermediate support & cantilever	107

**filing and storage 109**

pedestals	110
underdesk storage cabinet	111
underdesk combo pedestal BBF & FF	112
underdesk 2-drawer lateral file	113
freestanding storage cabinet   executive	114
freestanding storage cabinet   professional	115
freestanding combo pedestal BBF & FF   executive	116
freestanding combo pedestal BBF & FF   professional	117
freestanding 2-drawer lateral file   executive	118
freestanding 2-drawer lateral file   professional	119
freestanding 3-drawer lateral file   executive	120
freestanding 3-drawer lateral file   professional	121
freestanding 4-drawer lateral file   executive	122
freestanding 4-drawer lateral file   professional	123
freestanding storage tower   executive	124
freestanding storage tower   professional	125
freestanding combo storage tower BBF   executive	126
freestanding combo storage tower BBF   professional	127
freestanding wardrobe storage tower   executive	128
freestanding wardrobe storage tower   professional	129

freestanding storage tower glazed door   executive	130
freestanding storage tower glazed door   professional	131
freestanding combo storage tower FF   executive	132
freestanding combo storage tower FF   professional	133
freestanding storage tower double door   executive	134
freestanding storage tower double door   professional	135
freestanding combo lateral storage tower double door   executive	136
freestanding combo lateral storage tower double door   professional	137
freestanding combo storage tower double door   executive	138
freestanding combo storage tower double door   professional	139
freestanding storage tower glazed double door   executive	140
freestanding storage tower glazed double door   professional	141
freestanding combo lateral storage tower glazed double door   executive	142
freestanding combo lateral storage tower glazed double door   professional	143
freestanding combo storage tower glazed double door   executive	144
freestanding combo storage tower glazed double door   professional	145
radius corner bookcase short   executive	146
radius corner bookcase short   professional	147
<b>overhead storage</b>	<b>149</b>
open hutch   executive	150
open hutch   professional	151
hinged door overhead storage   executive	152
hinged door overhead storage   professional	153

hinged door overhead storage glazed doors   executive	154
hinged door overhead storage glazed doors   professional	155
<b>posts</b>	<b>157</b>
large vertical aluminum post	158
small vertical aluminum post	159
<b>electrics</b>	<b>161</b>
power box	162
data box	163
electrical starter harness	164
electrical splitter harness	165
electrical harness	166
<b>screens</b>	<b>169</b>
lamine screens	170
fabric screens	175
glazed screens	180
whiteboard screens	185
accessory screen	189
<b>counter tops</b>	<b>191</b>
glass	192
lamine 1.5 inch	193
boat lamine 1 inch	194
straight lamine 1 inch	195

wire management 197

vertical wire manager 198

horizontal wire manager 199

wire clip 200

accessories 203

keyboard tray 204

work organizer 205

monitor arm 206

task light 207

OVERVIEW

Tayco introduces Metropolis Collaborate, a full line of casegoods with a post and screen component that refreshes open spaces, private, and semi-private work areas for today's office environment. Collaborate is divided into two distinct product groups for specifying: Executive and Professional. Executive offers surfaces and tops that are 1.5" thick, Professional offers 1" thick. Listed below are features and benefits of collaborate along with a typical layout.

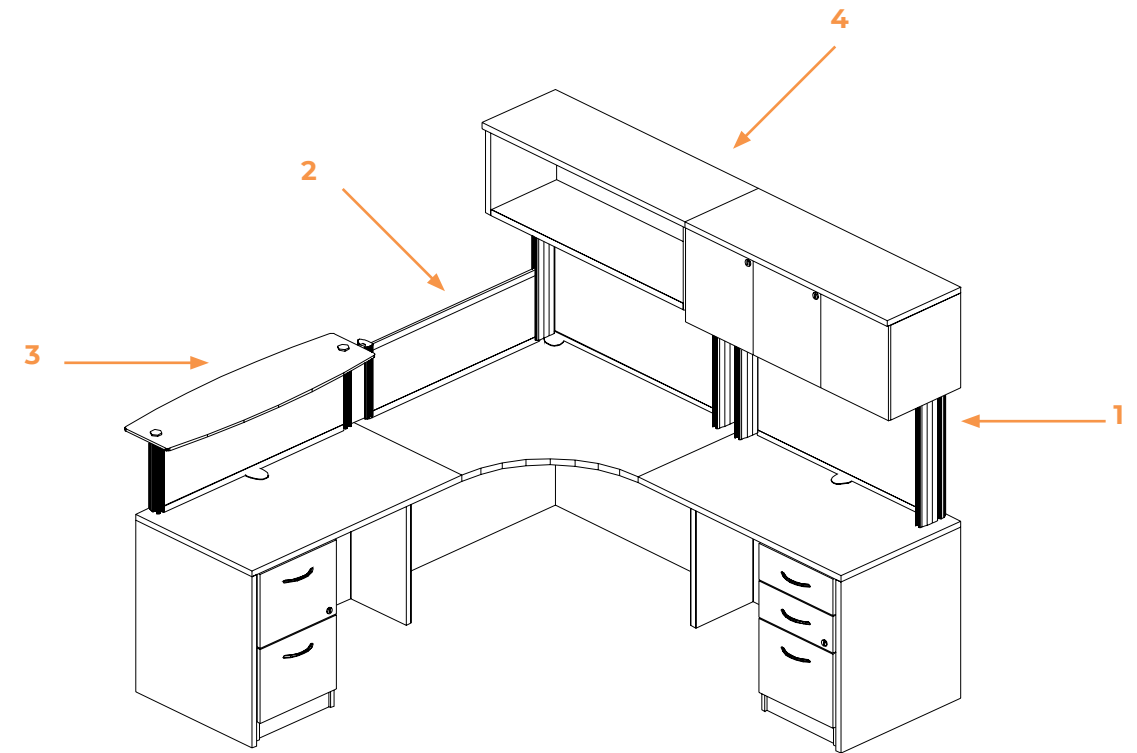

1

- a. Aluminum posts are available in 8, 12, 16, 24, 32 inches high.
- b. Large posts are required to support overhead storage.
- c. Hutches 54 inches and wider require 4 posts in a single span.
- d. Transaction countertops 54 inches and wider require 4 small aluminum posts.
- e. Posts are available in silver, black, and ginger.

2

- a. Screens are available in tackable fabric, laminate, whiteboard, glazed or with accessory slots.
- b. Heights are available in 4, 8, 12, 16, 20, 24, 32 inches high.

3

- a. Countertops are available in tempered glass and laminate finishes.
- b. They are supported by small aluminum posts.

4

- a. Overhead storage is available for assorted desk layouts, optional features include: open, hinged doors, glazed and open laminate.

# application guidelines Step 1

## STEP

## EXPLAINED

## NEXT

# 1

First select the appropriate base components to fit the space planning needs of your customer. Below is a typical corner workstation that consists of the basic items commonly used in today's office environment.

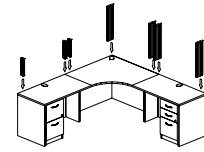

### CURVED FRONT CORNER

This item is for use in corners when connected to returns or bridges.

### GROMMET

Grommets are available in black or silver. Black is the standard grommet option unless otherwise specified on your Purchase Order.

### HANDLES

Six handle options are available in several styles and colors. Melbourne is the standard handle option unless otherwise specified on your Purchase Order.

### STRAIGHT RETURNS

This return is semi-supported, it must be connected to a freestanding desk, corner desk or credenza. Allows for fixed and modular underdesk storage.

### UNDERDESK FF PEDESTAL

This return is semi-supported, it must be connected to a freestanding desk, corner desk or credenza. Allows for fixed and modular underdesk storage. All pedestals come standard with locks.

### UNDERDESK BBF PEDESTAL

This product includes box and file drawers and can be used under a desk, return or credenza for storage. Its full extension drawers can accommodate both letter and legal-size paper. All pedestals come standard with locks and pencil trays.

- | COLORS  |  |
|---|--|
|  | MELBOUNRE<br>Brushed Nickel (standard) |
|  | MANHATTAN<br>Ginger                    |
|  | CLIFTON<br>Espresso                    |
|  | BROOKLYN<br>Black                      |
|  | HUMBER<br>Polished Metal               |
|  | ROSEDALE<br>Silver                     |

# application guidelines Step 2

## STEP

## EXPLAINED

## NEXT

# 2

Select the appropriate post heights to fit the specification needs by your customer. There are only two post structures to work with. Small posts support countertops and all screen heights. Large posts support overheads in conjunction with large screens.

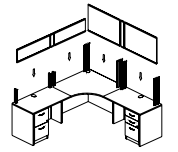

### SMALL POSTS

These posts will support a screen only since the transaction top will only span the return. Available in silver, black and ginger.

### LARGE POSTS

Large aluminum posts are required to support overhead storage. Hutches 54" and wider require 4 posts in a single span. These posts will also hold the appropriate screen in place. Available in silver, black and ginger.

### SMALL POSTS

These small posts will support a glass transaction top and screen. Countertops 54" and wider require 4 small posts. Available in silver, black and ginger.

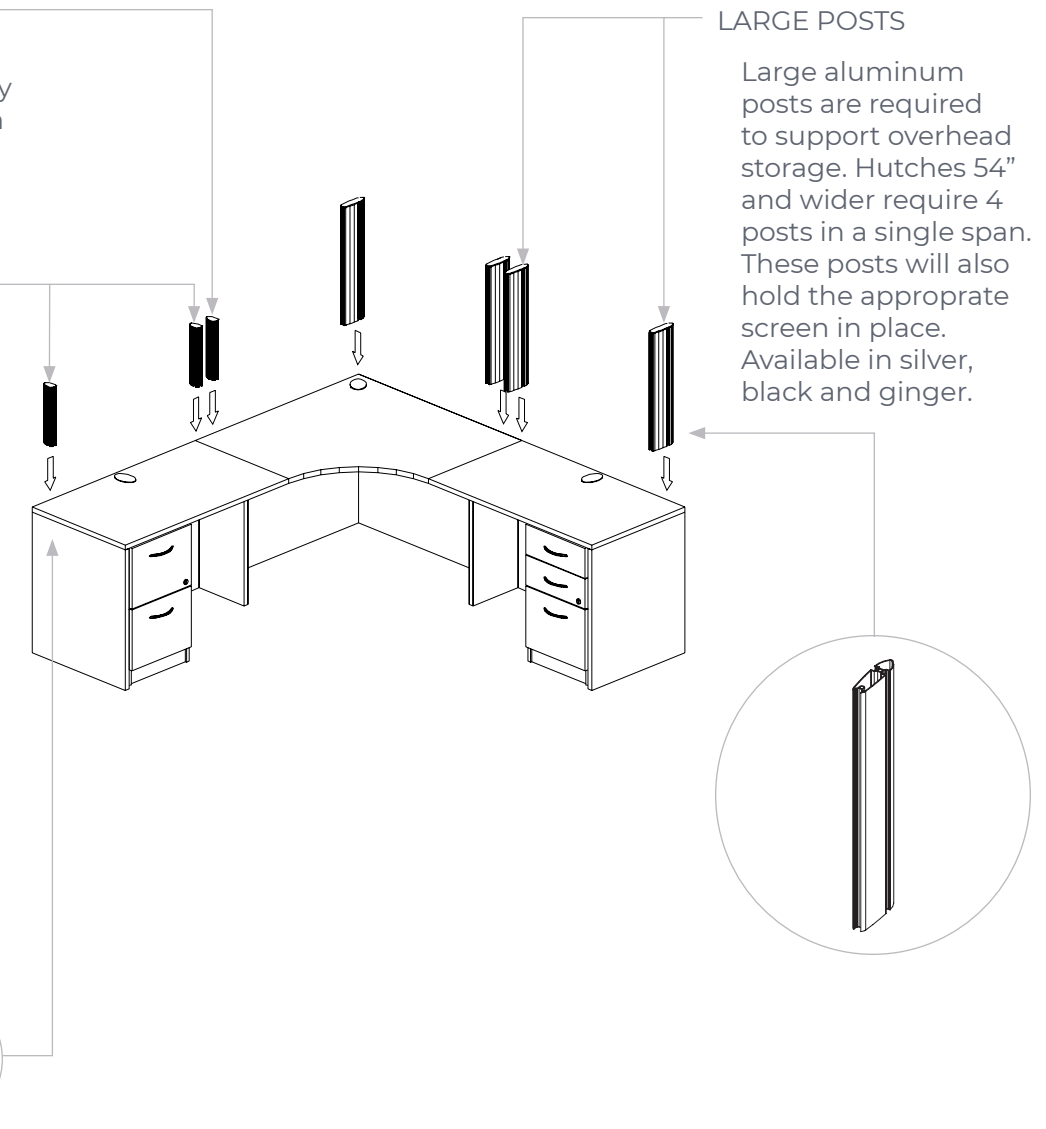

## application guidelines Step 3

### STEP

# 3

### EXPLAINED

Choose the appropriate screen heights based on post heights. Metropolis Collaborate offers several screen types: laminate, fabric, glazed, whiteboard, and accessory.

### NEXT

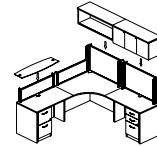

#### SCREENS

Screens selected in conjunction with corresponding post height and surface width.

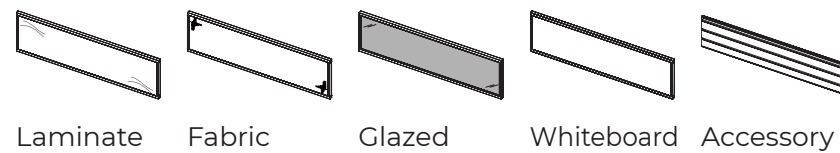
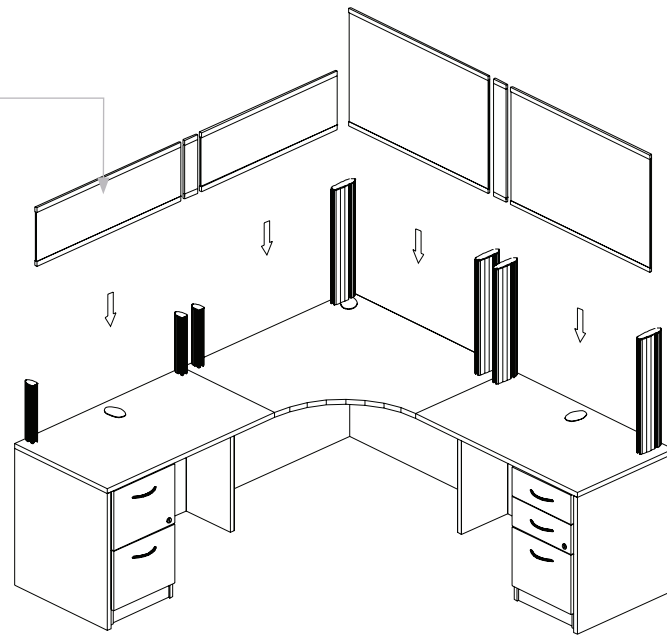

## application guidelines Step 4

### STEP

# 4

### EXPLAINED

Overhead storage and hutches can now be added to any 24" large vertical posts. In this case an Open and Hinged Door Hutch are being used for storage. A transaction top is placed on the smaller posts.

### COMPLETE

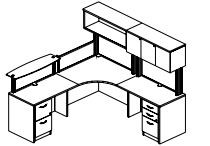

#### OPEN HUTCH

Provides overhead storage within the workstation. Overheads 54 inches and wider require 4 large vertical posts for support.

#### HINGED DOOR HUTCH

Provides overhead storage within the workstation. Overheads 54 inches and wider require 4 large vertical posts for support.

#### TRANSACTION TOP

Transaction tops are available in tempered glass, 1 & 1.5 inches thick laminate surfaces. Transaction tops 54 inches and wider require 4 small vertical posts for support.

#### HINGED DOOR HUTCH GLAZED

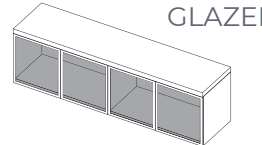

#### OPEN LAMINATE SHELF

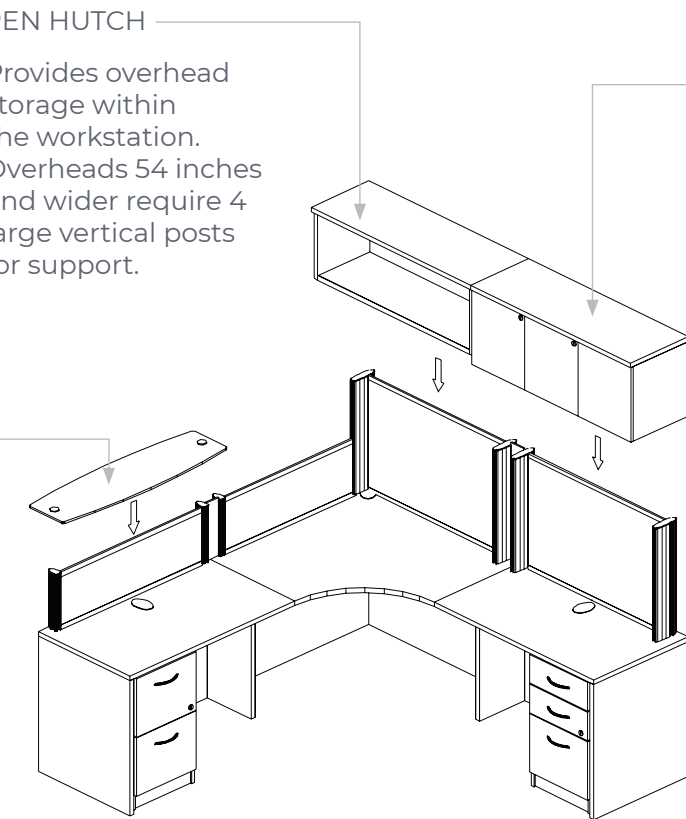
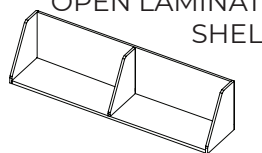



STEP

5

EXPLAINED

The workstation is now complete. Providing detailed floorplans with each order will help avoid errors when quoting Metropolis Collaborate. Tayco can assist with space planning needs by generating proper layouts and pricing.

FLOORPLAN

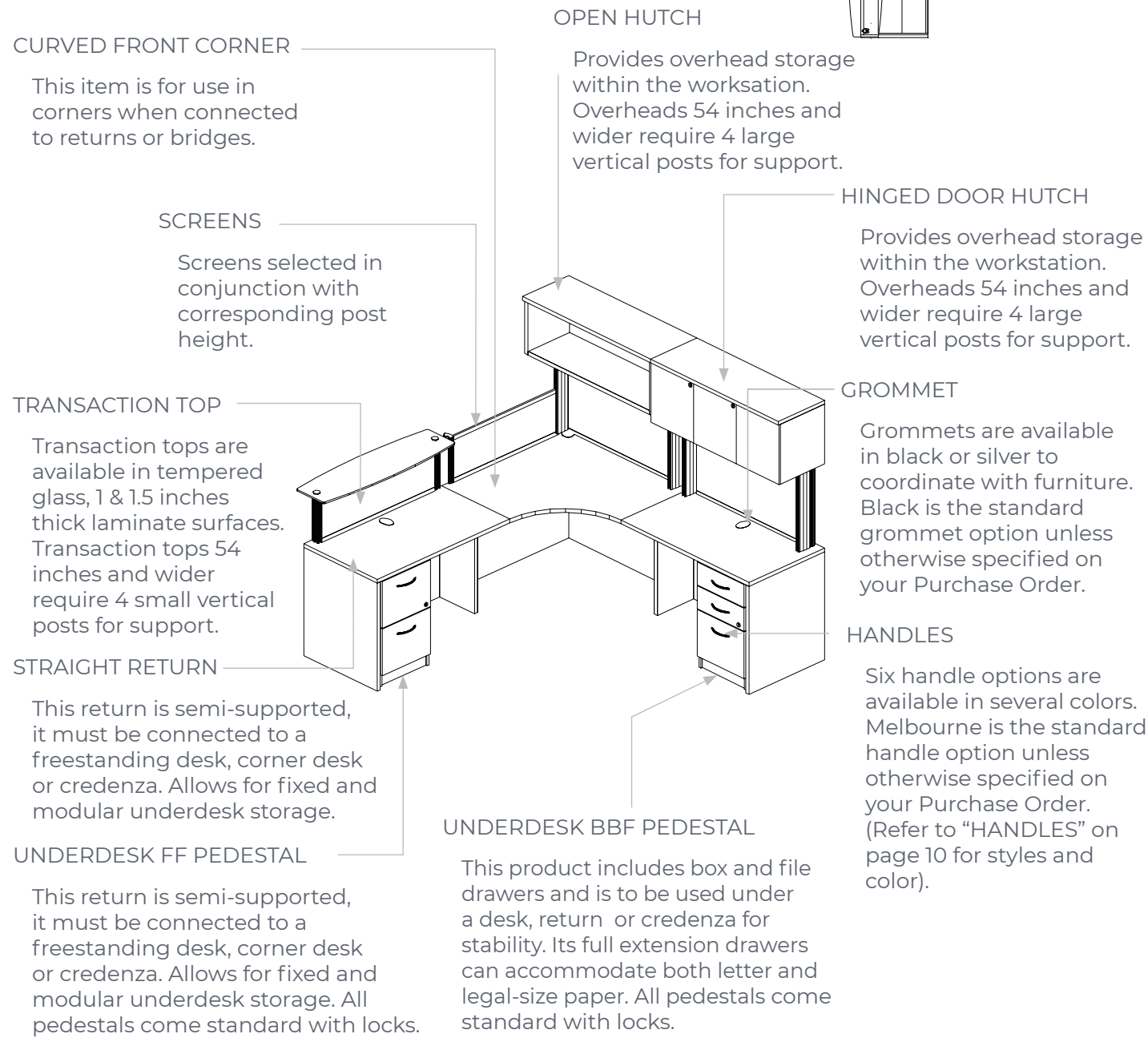
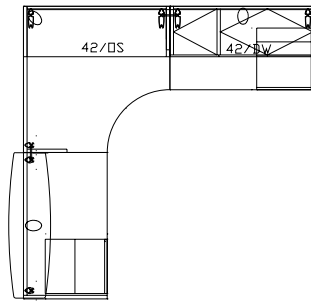

BRIEF

This map contains all the components referred to in this section for easy reference.

MAP

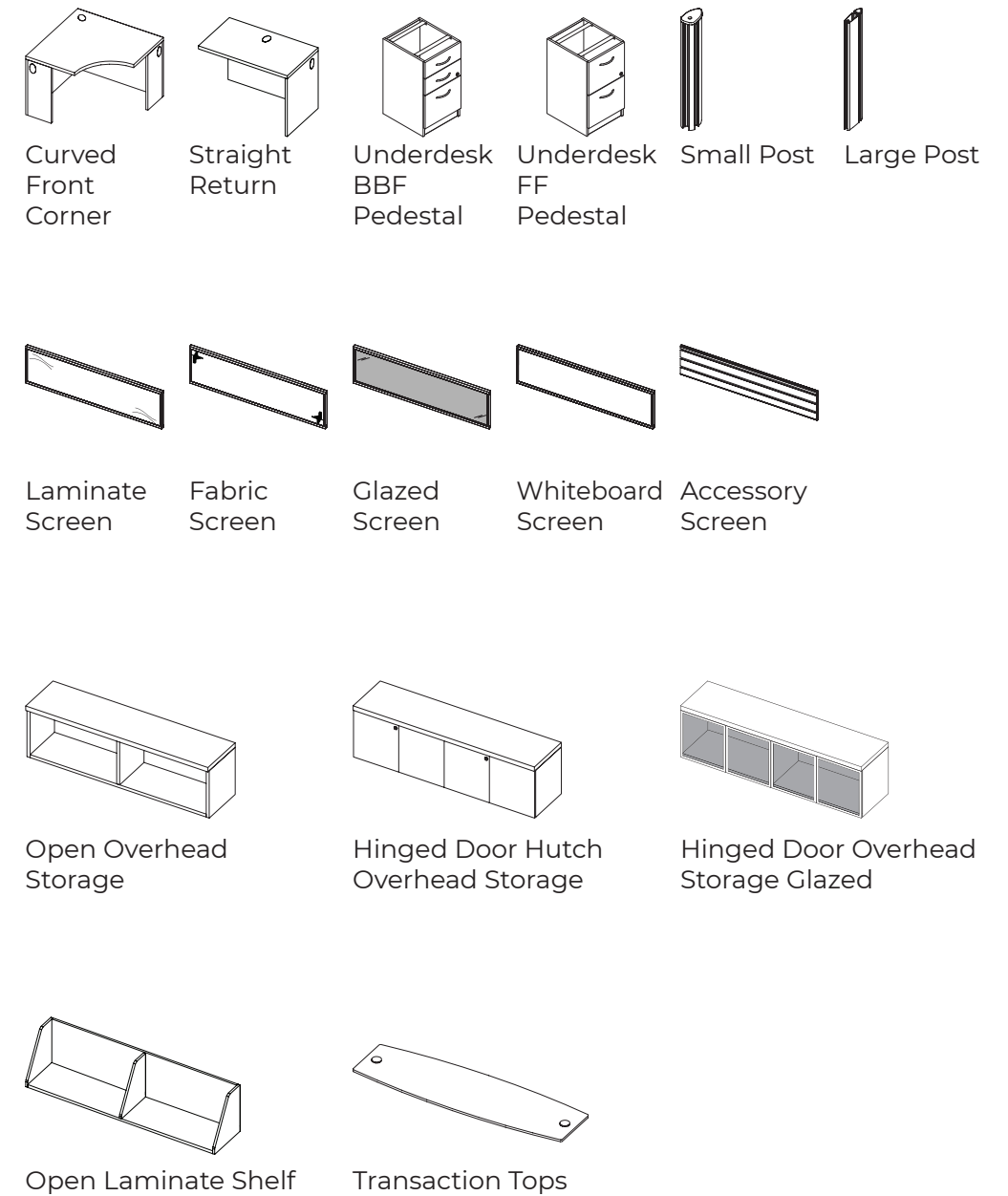



## application guidelines Grain direction

### HORIZONTAL SURFACES

When ordering a directional laminate, the grain will run the direction of the width of the worksurface (excluding bridge surfaces), hutch or storage top. Grain on bridge modesty run vertically so the grain will run the same direction on the entire suite.

### VERTICAL SURFACES

Directional laminates run vertically on vertical surfaces such as cabinet doors, pedestal drawer fronts and gables, as well as all cabinet, lateral file and pedestal kick-plates. The grain runs horizontally across the width of modesty panels.

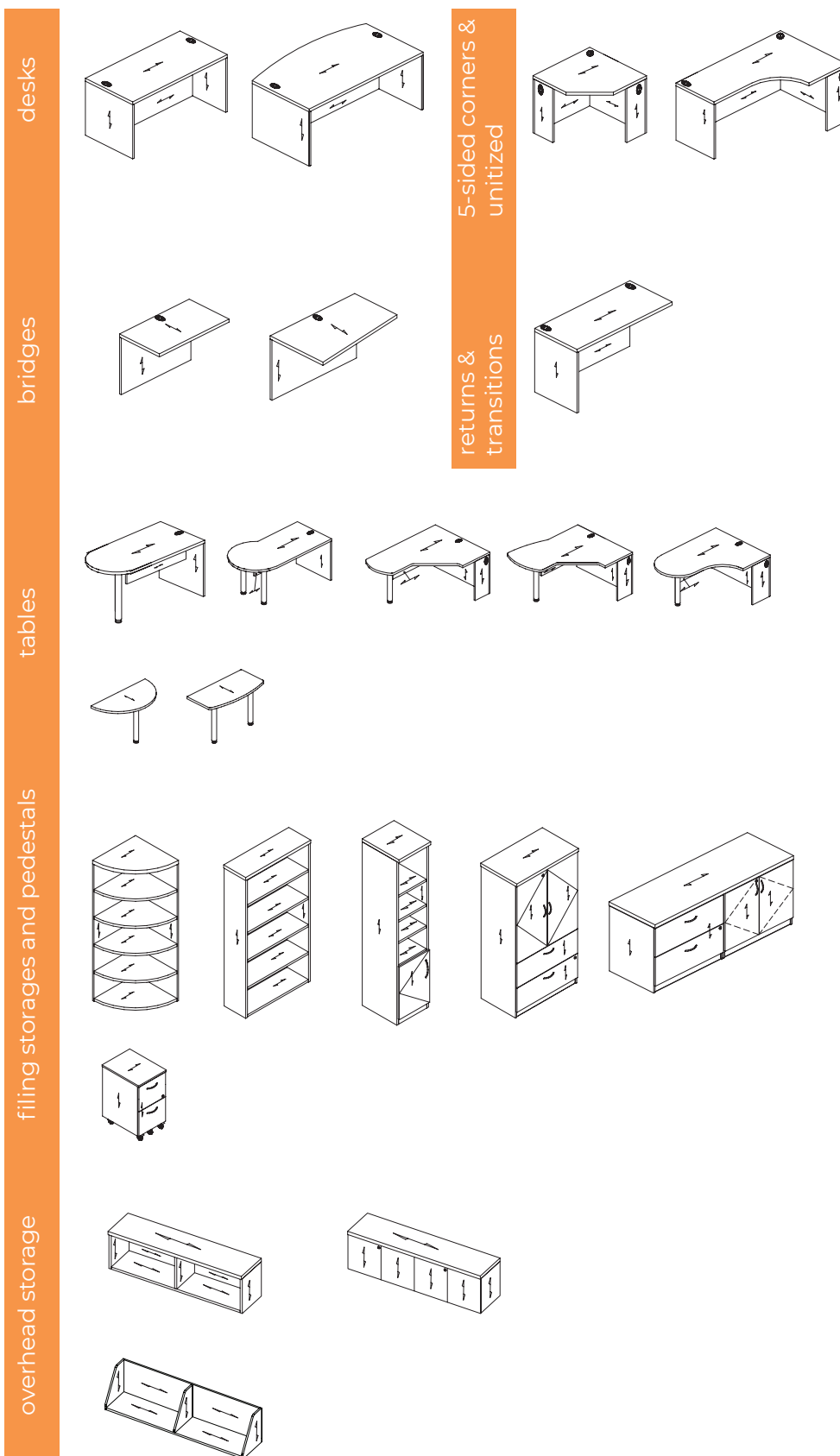

## Caution

### Load Bottom Drawer First

- Operate one drawer at a time
- Units may tip if loaded incorrectly
- Units should be attached to a wall or other furniture to reduce tipping hazard
- Always load the heaviest files in the bottom drawer

### Heavy Load

- Some products must be anchored to wall to ensure stability & safety.
- It is the owner and installers responsibility to ensure that the wall type and construction is of sufficient strength to carry the loads of any wall mounted products and their contents.
- Failure of the wall and anchors to support all imposed loads may result in property damage and/or personal injury.
- Tayco can provide size and empty weight of its products only. As wall blocking is considered a building construction process, Tayco cannot provide recommendations in this respect and cannot be responsible for damage or injury that may occur as a result of improper installation and/or blocking.

### Instability Hazard

Mobile items on casters such as flip top, personal and movable tables of any type and storage items of any type may present an instability hazard if not secured correctly while in use or in storage. Flip top tables or training tables of any type, are inherently more unstable when folded. Tayco provides the following guidelines & warnings when using mobile products:

- Lock casters immediately after moving. Do not leave the casters unlocked when in use or in storage.
- Motion may increase the instability of any item with casters. If the wheels hit an obstruction the table's forward momentum often causes overturn, especially if the item is not equipped with wheel extensions. Exercise strong caution while moving these items.
- Use caution when abrupt level changes in the floor are present (such as a doorway or room threshold) as caster failure or tipping may result.
- Do not stand, sit or lean on mobile items for support. They are not intended for this use and personal injury or property damage may result.
- Mobile units that feature height adjustable elements must be lowered to the minimum compressed height when moving to prevent instability. It is also recommended the user remove all computer equipment or other accessories to prevent possible weight imbalance or damage to equipment.
- Failure to follow the guidelines above may result in property damage or personal injury.



Metro Collab  
August 2024  
**Desks**

straight desk

Executive

<u>straight desk</u>	20
<u>straight partial modesty</u>	24
<u>straight full recessed modesty</u>	28
<u>arc full recessed modesty</u>	32

Professional

<u>straight desk</u>	22
<u>straight partial modesty</u>	26
<u>straight full recessed modesty</u>	30
<u>arc full recessed modesty</u>	33

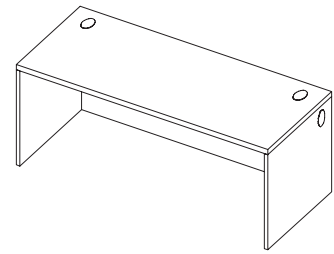

Straight Desk Full Modesty, 1.5" Thick Surface

This desk can be used alone or connected to a bridge or return to complete a full workstation. Allows for fixed and modular underdesk storage.

**Ordering Options:**

Use the following checklist to customize the finishes on your order:

- laminate
- trim color
- edge profile
- grommet color

Each laminate comes with matching vinyl trim color unless otherwise specified on your purchase order. Refer to the laminate finish card for our current offering.

**Details:**

Modesty is full height.

Grommets are available in black or silver. Black is the standard grommet option unless otherwise specified on your purchase order.

Surfaces up to and including 48" wide have one grommet located at the back center of the surface. Surfaces 54" wide and greater have two grommets at either side of the back of the surface.

All gables include grommets

Code	Price	H	W	D	Volume (ft <sup>3</sup> )	Weight (lb)
K-TS0G-6021	946	29.5	60	21	4.63	122.55
K-TS0G-6621	997	29.5	66	21	5.06	131.97
K-TS0G-7221	1037	29.5	72	21	5.5	141.39
K-TS0G-7821	1082	29.5	78	21	5.93	150.81
K-TS0G-8421	1144	29.5	84	21	6.37	160.23
K-TS0G-3024	754	29.5	30	24	2.75	92.02
K-TS0G-3624	800	29.5	36	24	3.24	111.14
K-TS0G-4224	834	29.5	42	24	3.73	130.26
K-TS0G-4824	883	29.5	48	24	4.21	149.38
K-TS0G-5424	934	29.5	54	24	4.7	168.5
K-TS0G-6024	986	29.5	60	24	5.19	187.62
K-TS0G-6624	1037	29.5	66	24	5.67	206.74
K-TS0G-7224	1075	29.5	72	24	6.16	225.86
K-TS0G-7824	1128	29.5	78	24	6.64	244.98
K-TS0G-8424	1188	29.5	84	24	7.13	264.1
K-TS0G-3030	793	29.5	30	30	3.34	99.05
K-TS0G-3630	855	29.5	36	30	3.94	110.58
K-TS0G-4230	905	29.5	42	30	4.53	122.11
K-TS0G-4830	965	29.5	48	30	5.12	133.64
K-TS0G-5430	1037	29.5	54	30	5.71	145.17
K-TS0G-6030	1082	29.5	60	30	6.3	156.7
K-TS0G-6630	1128	29.5	66	30	6.89	168.23
K-TS0G-7230	1172	29.5	72	30	7.48	179.76
K-TS0G-8430	1307	29.5	84	30	8.66	202.82

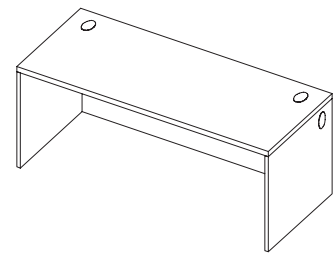

This desk can be used alone or connected to a bridge or return to complete a full workstation. Allows for fixed and modular underdesk storage.

**Ordering Options:**

Use the following checklist to customize the finishes on your order:

- laminate
- trim color
- grommet color

Each laminate comes with matching vinyl trim color unless otherwise specified on your purchase order. Refer to the laminate finish card for our current offering.

**Details:**

Modesty is full height.

Grommets are available in black or silver. Black is the standard grommet option unless otherwise specified on your purchase order.

Surfaces up to and including 48" wide have one grommet located at the back center of the surface. Surfaces 54" wide and greater have two grommets at either side of the back of the surface.

All gables include grommets

Code	Price	H	W	D	Volume (ft <sup>3</sup> )	Weight (lb)
KL-TS0G-6021	872	29	60	21	4.63	107.7
KL-TS0G-6621	922	29	66	21	5.06	117.12
KL-TS0G-7221	957	29	72	21	5.5	126.54
KL-TS0G-7821	1005	29	78	21	5.93	135.96
KL-TS0G-8421	1061	29	84	21	6.37	145.38
KL-TS0G-3024	697	29	30	24	2.75	77.17
KL-TS0G-3624	745	29	36	24	3.24	96.29
KL-TS0G-4224	773	29	42	24	3.73	115.41
KL-TS0G-4824	817	29	48	24	4.21	134.53
KL-TS0G-5424	863	29	54	24	4.7	153.65
KL-TS0G-6024	911	29	60	24	5.19	172.77
KL-TS0G-6624	957	29	66	24	5.67	191.89
KL-TS0G-7224	997	29	72	24	6.16	211.01
KL-TS0G-7824	1041	29	78	24	6.64	230.13
KL-TS0G-8424	1098	29	84	24	7.13	249.25
KL-TS0G-3030	736	29	30	30	3.34	84.2
KL-TS0G-3630	792	29	36	30	3.94	95.73
KL-TS0G-4230	838	29	42	30	4.53	107.26
KL-TS0G-4830	896	29	48	30	5.12	118.79
KL-TS0G-5430	956	29	54	30	5.71	130.32
KL-TS0G-6030	1005	29	60	30	6.3	141.85
KL-TS0G-6630	1041	29	66	30	6.89	153.38
KL-TS0G-7230	1085	29	72	30	7.48	164.91
KL-TS0G-7830	1150	29	78	30	8.07	176.44
KL-TS0G-8430	1211	29	84	30	8.66	187.97

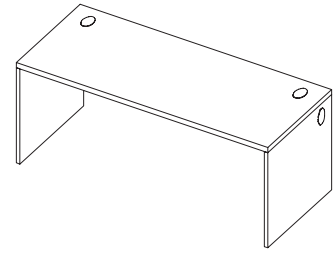

Straight Desk Partial Modesty, 1.5" Thick Surface

**Ordering Options:**

Use the following checklist to customize the finishes on your order:

- laminate
- trim color
- edge profile
- grommet color

Each laminate comes with matching vinyl trim color unless otherwise specified on your purchase order. Refer to the laminate finish card for our current offering.

**Details:**

Partial modesty height 12".

Grommets are available in black or silver. Black is the standard grommet option unless otherwise specified on your purchase order.

Surfaces up to and including 48" wide have one grommet located at the back center of the surface. Surfaces 54" wide and greater have two grommets at either side of the back of the surface.

All gables include grommets.

Code	Price	H	W	D	Volume (ft <sup>3</sup> )	Weight (lb)
K-TS0Z-6021	946	29.5	60	21	4.63	97.81
K-TS0Z-6621	997	29.5	66	21	5.06	104.54
K-TS0Z-7221	1037	29.5	72	21	5.5	111.27
K-TS0Z-7821	1082	29.5	78	21	5.93	118
K-TS0Z-8421	1144	29.5	84	21	6.37	124.73
K-TS0Z-3024	754	29.5	30	24	2.75	71.33
K-TS0Z-3624	800	29.5	36	24	3.24	78.75
K-TS0Z-4224	834	29.5	42	24	3.73	86.17
K-TS0Z-4824	883	29.5	48	24	4.21	93.59
K-TS0Z-5424	934	29.5	54	24	4.7	101.01
K-TS0Z-6024	986	29.5	60	24	5.19	108.43
K-TS0Z-6624	1037	29.5	66	24	5.67	115.85
K-TS0Z-7224	1075	29.5	72	24	6.16	123.27
K-TS0Z-7824	1128	29.5	78	24	6.64	130.69
K-TS0Z-8424	1188	29.5	84	24	7.13	138.11
K-TS0Z-3030	793	29.5	30	30	3.34	75.35
K-TS0Z-3630	855	29.5	36	30	3.94	83.98
K-TS0Z-4230	905	29.5	42	30	4.53	92.6
K-TS0Z-4830	965	29.5	48	30	5.12	101.23
K-TS0Z-5430	1037	29.5	54	30	5.71	109.85
K-TS0Z-6030	1082	29.5	60	30	6.3	118.48
K-TS0Z-6630	1128	29.5	66	30	6.89	127.1
K-TS0Z-7230	1172	29.5	72	30	7.48	135.73
K-TS0Z-7830	1246	29.5	78	30	8.07	144.35
K-TS0Z-8430	1307	29.5	84	30	8.66	152.98

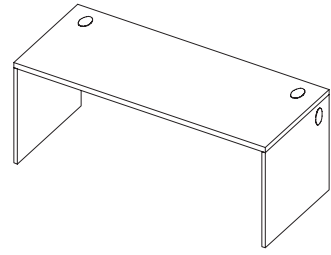

**Ordering Options:**

Use the following checklist to customize the finishes on your order:

- laminate
- trim color
- grommet color

Each laminate comes with matching vinyl trim color unless otherwise specified on your purchase order. Refer to the laminate finish card for our current offering.

**Details:**

Partial modesty height 12".

Grommets are available in black or silver. Black is the standard grommet option unless otherwise specified on your purchase order.

Surfaces up to and including 48" wide have one grommet located at the back center of the surface. Surfaces 54" wide and greater have two grommets at either side of the back of the surface.

All gables include grommets.

Code	Price	H	W	D	Volume (ft <sup>3</sup> )	Weight (lb)
KL-TS0Z-3030	736	29	30	30	3.34	63.48
KL-TS0Z-3624	745	29	36	24	3.24	67.5
KL-TS0Z-3630	792	29	36	30	3.94	69.97
KL-TS0Z-3630-UW	793	29	36	30	3.94	69.97
KL-TS0Z-4224	773	29	42	24	3.73	73.05
KL-TS0Z-4224-UW	773	29	42	24	3.73	73.05
KL-TS0Z-4230	838	29	42	30	4.53	76.46
KL-TS0Z-4230-UW	838	29	42	30	4.53	76.46
KL-TS0Z-4821	779	29	48	21	0	140
KL-TS0Z-4824	817	29	48	24	4.21	78.6
KL-TS0Z-4824-UW	818	29	48	24	4.21	78.6

Code	Price	H	W	D	Volume (ft <sup>3</sup> )	Weight (lb)
KL-TS0Z-4830	896	29	48	30	5.12	82.95
KL-TS0Z-5124	863	29	51	24	4.7	84.15
KL-TS0Z-5324	863	29	53	24	0	174.45
KL-TS0Z-5421	851	29	54	24	0	157.5
KL-TS0Z-5424	863	29	54	24	4.7	84.15
KL-TS0Z-5424-UW	863	29	54	24	0	157.5
KL-TS0Z-5430	956	29	54	30	5.71	89.44
KL-TS0Z-5430-UW	956	29	54	30	5.71	89.44
KL-TS0Z-6021	872	29	60	21	4.63	81.41
KL-TS0Z-6021-UW	875	29	60	21	4.63	81.41
KL-TS0Z-6024	911	29	60	24	5.19	89.7
KL-TS0Z-6024-UW	912	29	60	24	5.19	89.7
KL-TS0Z-6030	1005	29	60	30	6.3	95.93
KL-TS0Z-6030-UW	1005	29	60	30	6.3	95.93
KL-TS0Z-6618	922	29	66	18	0	25
KL-TS0Z-6621	922	29	66	21	5.06	86.6
KL-TS0Z-6624	957	29	66	24	5.67	95.25
KL-TS0Z-6624-UW	957	29	66	24	5.67	95.25
KL-TS0Z-6630	1041	29	66	30	6.89	102.42
KL-TS0Z-6630-UW	1041	29	66	30	6.89	102.42
KL-TS0Z-6636	1135	29	66	36	0	168
KL-TS0Z-7221	957	29	72	21	5.5	91.79
KL-TS0Z-7224	997	29	72	24	6.16	100.8
KL-TS0Z-7224-UW	999	29	72	24	6.16	100.8
KL-TS0Z-7230	1085	29	72	30	7.48	108.91
KL-TS0Z-7821	1005	29	78	21	5.93	96.98
KL-TS0Z-7824	1041	29	78	24	6.64	106.35
KL-TS0Z-7830	1150	29	78	30	8.07	115.4
KL-TS0Z-8421	1061	29	84	21	6.37	102.17
KL-TS0Z-8424	1098	29	84	24	7.13	111.9
KL-TS0Z-8430	1211	29	84	30	8.66	121.89

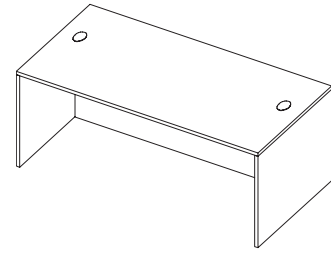

This desk can be used alone or connected to a bridge or return to complete a full workstation. Full modesty recessed in 8 inches for guests. Allows for fixed and modular underdesk storage.

**Ordering Options:**

Use the following checklist to customize the finishes on your order:

- laminate
- trim color
- edge profile
- grommet color

Each laminate comes with matching vinyl trim color unless otherwise specified on your purchase order. Refer to the laminate finish card for our current offering.

**Details:**

Full modesty recessed in 8 inches.

Grommets are available in black or silver. Black is the standard grommet option unless otherwise specified on your purchase order

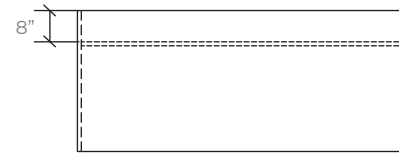

Code	Price	H	W	D	Volume (ft <sup>3</sup> )	Weight (lb)
K-TSRG-6030	1103	29.5	60	30	6.3	156.7
K-TSRG-6630	1144	29.5	66	30	6.89	168.23
K-TSRG-7230	1197	29.5	72	30	7.48	179.76
K-TSRG-7830	1266	29.5	78	30	8.07	191.29
K-TSRG-8430	1326	29.5	84	30	8.66	202.82
K-TSRG-6036	1278	29.5	60	36	7.41	178.2
K-TSRG-6636	1326	29.5	66	36	8.1	190.8
K-TSRG-7236	1377	29.5	72	36	8.8	203.4
K-TSRG-7836	1437	29.5	78	36	9.49	216
K-TSRG-8436	1489	29.5	84	36	10.19	228.6



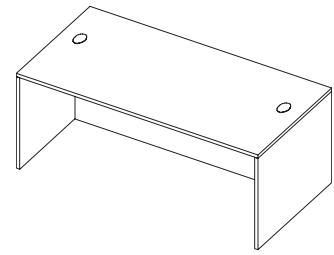

**Ordering Options:**

Use the following checklist to customize the finishes on your order:

- laminate
- trim color
- grommet color

Each laminate comes with matching vinyl trim color unless otherwise specified on your purchase order. Refer to the laminate finish card for our current offering.

**Details:**

Full modesty recessed in 8 inches.

Grommets are available in black or silver. Black is the standard grommet option unless otherwise specified on your purchase order

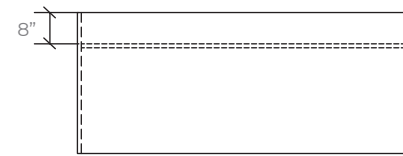

Code	Price	H	W	D	Volume (ft <sup>3</sup> )	Weight (lb)
KL-TSRG-6030	1022	29	60	30	6.3	137.93
KL-TSRG-6630	1061	29	66	30	6.89	149.46
KL-TSRG-7230	1108	29	72	30	7.48	160.99
KL-TSRG-7830	1169	29	78	30	8.07	172.52
KL-TSRG-8430	1227	29	84	30	8.66	184.05
KL-TSRG-6036	1184	29	60	36	7.41	150.3
KL-TSRG-6636	1227	29	66	36	8.1	160.2
KL-TSRG-7236	1274	29	72	36	8.8	170.1
KL-TSRG-7836	1330	29	78	36	9.49	180
KL-TSRG-8436	1379	29	84	36	10.19	189.9

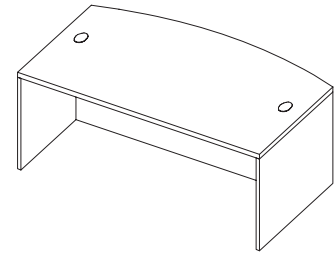

This desk can be used alone or connected to a bridge or return to complete a full workstation. Full modesty recessed in 8 inches for guests. Allows for fixed and modular underdesk storage.

**Ordering Options:**

Use the following checklist to customize the finishes on your order:

- laminate
- trim color
- edge profile
- grommet color

Each laminate comes with matching vinyl trim color unless otherwise specified on your purchase order. Refer to the laminate finish card for our current offering.

**Details:**

Full modesty recessed in 8 inches. Grommets are available in black or silver. Black is the standard grommet option unless otherwise specified on your purchase order

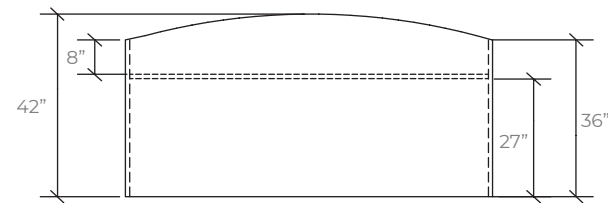

Code	Price	H	W	D	Volume (ft <sup>3</sup> )	Weight (lb)
K-TARG-7236	1597	29.5	72	36	8.8	216.17
K-TARG-7836	1671	29.5	78	36	9.49	230.43
K-TARG-8436	1745	29.5	84	36	10.19	244.69

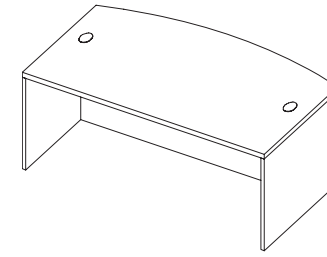

**Ordering Options:**

Use the following checklist to customize the finishes on your order:

- laminate
- trim color
- grommet color

Each laminate comes with matching vinyl trim color unless otherwise specified on your purchase order. Refer to the laminate finish card for our current offering.

**Details:**

Full modesty recessed in 8 inches. Grommets are available in black or silver. Black is the standard grommet option unless otherwise specified on your purchase order

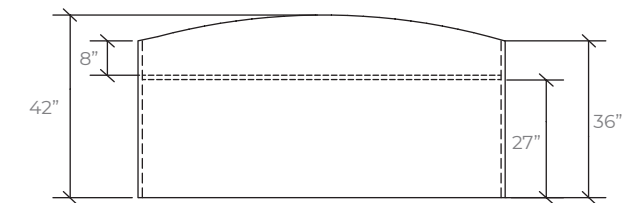

Code	Price	H	W	D	Volume (ft <sup>3</sup> )	Weight (lb)
KL-TARG-7236	1485	29	72	36	8.8	178.09
KL-TARG-7836	1559	29	78	36	9.49	188.84
KL-TARG-8436	1636	29	84	36	10.19	199.59

Metro Collab  
August 2024  
**Tables**

Executive

D-table	36
K-table	38
J-table	40
P-table	42
F-table	44
U-table	46
C-table	48

Professional

D-table	37
K-table	39
J-table	41
P-table	43
F-table	45
U-table	47
C-table	49

This table is semi-supported and must be used with two freestanding desks or credenzas.

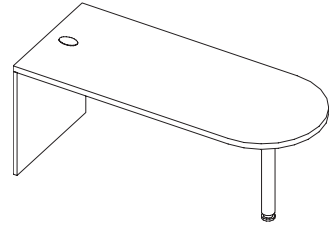

D-Table, 1.5" Thick Surface

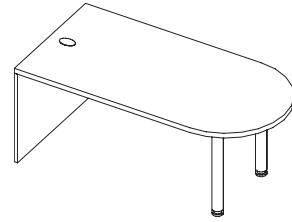

36" depth come with 2 posts

**Ordering Options:**

Use the following checklist to customize the finishes on your order:

- laminate
- trim color
- edge profile
- grommet color
- metal color (posts)

Each laminate comes with matching vinyl trim color unless otherwise specified on your purchase order. Refer to the laminate finish card for our current offering.

**Details:**

Grommets are available in black or silver. Black is the standard grommet option unless otherwise specified on your purchase order.

36 inch surface depth requires 2 posts.

Code	Price	H	W	D	Volume (ft <sup>3</sup> )	Weight (lb)
K-TD0G-6030	1319	29.5	60	30	5.04	108.29
K-TD0G-6630	1361	29.5	66	30	5.51	117.27
K-TD0G-7230	1408	29.5	72	30	5.98	126.25
K-TD0G-7830	1450	29.5	78	30	6.45	135.23
K-TD0G-8430	1492	29.5	84	30	6.93	144.21
K-TD0G-6036	1415	29.5	60	36	5.93	131.34
K-TD0G-6636	1471	29.5	66	36	6.48	141.76
K-TD0G-7236	1502	29.5	72	36	7.04	152.18
K-TD0G-7836	1542	29.5	78	36	7.59	162.6
K-TD0G-8436	1587	29.5	84	36	8.15	173.02

This table is semi-supported and must be used with two freestanding desks or credenzas.

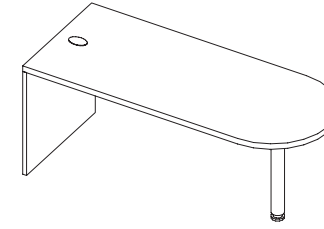

D-Table, 1.5" Thick Surface

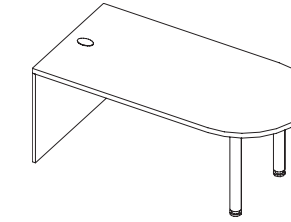

36" depth come with 2 posts

**Ordering Options:**

Use the following checklist to customize the finishes on your order:

- laminate
- trim color
- grommet color
- metal color (posts)

Each laminate comes with matching vinyl trim color unless otherwise specified on your purchase order. Refer to the laminate finish card for our current offering.

**Details:**

Grommets are available in black or silver. Black is the standard grommet option unless otherwise specified on your purchase order.

36 inch surface depth requires 2 posts.

Code	Price	H	W	D	Volume (ft <sup>3</sup> )	Weight (lb)
KL-TD0G-6030	1081	29	60	30	5.04	86.48
KL-TD0G-6630	1128	29	66	30	5.51	92.95
KL-TD0G-7230	1168	29	72	30	5.98	99.42
KL-TD0G-7830	1211	29	78	30	6.45	105.9
KL-TD0G-8430	1257	29	84	30	6.93	112.38
KL-TD0G-6036	1180	29	60	36	5.93	107.18
KL-TD0G-6636	1232	29	66	36	6.48	115.76
KL-TD0G-7236	1266	29	72	36	7.04	124.34
KL-TD0G-7836	1308	29	78	36	7.59	132.92
KL-TD0G-8436	1354	29	84	36	8.15	141.5

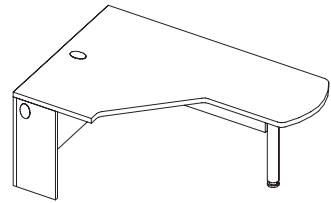

This table should be connected to a bridge or return to complete a full workstation (right hand shown).

K-Table, 1.5" Thick Surface

**Ordering Options:**

Use the following checklist to customize the finishes on your order:

- laminate
- trim color
- edge profile
- grommet color
- metal color (posts)

Each laminate comes with matching vinyl trim color unless otherwise specified on your purchase order. Refer to the laminate finish card for our current offering.

**Details:**

Grommets are available in black or silver. Black is the standard grommet option unless otherwise specified on your purchase order.

Code	Price	H	W	D	Volume (ft <sup>3</sup> )	Weight (lb)
<b>Left Hand</b>						
K-TKSG-604824-L	1742	29.5	60	24	5.19	149.13
K-TKSG-664824-L	1860	29.5	66	24	5.67	156.85
K-TKSG-724824-L	1955	29.5	72	24	6.16	164.57
K-TKSG-784824-L	2050	29.5	78	24	6.64	172.29
K-TKSG-844824-L	2147	29.5	84	24	7.13	180.01
<b>Right Hand</b>						
K-TKSG-604824-R	1742	29.5	60	24	5.19	149.13
K-TKSG-664824-R	1860	29.5	66	24	5.67	156.85
K-TKSG-724824-R	1955	29.5	72	24	6.16	164.57
K-TKSG-784824-R	2050	29.5	78	24	6.64	172.29
K-TKSG-844824-R	2147	29.5	84	24	7.13	180.01

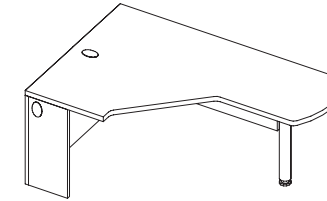

This table should be connected to a bridge or return to complete a full workstation (right hand shown).

**Ordering Options:**

Use the following checklist to customize the finishes on your order:

- laminate
- trim color
- grommet color
- metal color (posts)

Each laminate comes with matching vinyl trim color unless otherwise specified on your purchase order. Refer to the laminate finish card for our current offering.

**Details:**

Grommets are available in black or silver. Black is the standard grommet option unless otherwise specified on your purchase order.

Code	Price	H	W	D	Volume (ft <sup>3</sup> )	Weight (lb)
<b>Left Hand</b>						
KL-TKSG-604824L	1630	29	60	24	5.19	120.33
KL-TKSG-664824L	1746	29	66	24	5.67	125.88
KL-TKSG-724824L	1843	29	72	24	6.16	131.43
KL-TKSG-784824L	1937	29	78	24	6.64	136.98
KL-TKSG-844824L	2031	29	84	24	7.13	142.53
<b>Right Hand</b>						
KL-TKSG-604824R	1630	29	60	24	5.19	120.33
KL-TKSG-664824R	1746	29	66	24	5.67	125.88
KL-TKSG-724824R	1843	29	72	24	6.16	131.43
KL-TKSG-784824R	1937	29	78	24	6.64	136.98
KL-TKSG-844824R	2031	29	84	24	7.13	142.53

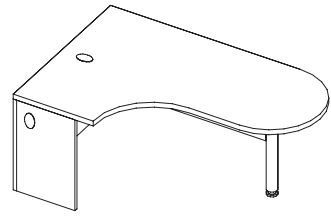

This table should be connected to a bridge or return to complete a full workstation (right hand shown).

J-Table, 1.5" Thick Surface

**Ordering Options:**

Use the following checklist to customize the finishes on your order:

- laminate
- trim color
- edge profile
- grommet color
- metal color (posts)

Each laminate comes with matching vinyl trim color unless otherwise specified on your purchase order. Refer to the laminate finish card for our current offering.

**Details:**

Grommets are available in black or silver. Black is the standard grommet option unless otherwise specified on your purchase order.

Item includes worksurface, 1 post leg, and mounting hardware.

All gables include grommets.

Code	Price	H	W	D	Volume (ft <sup>3</sup> )	Weight (lb)
<b>Left Hand</b>						
K-TJ0G-604824-L	1738	29.5	60	24	6.22	149.48
K-TJ0G-664824-L	1854	29.5	66	24	6.81	158.56
K-TJ0G-724824-L	1948	29.5	72	24	7.39	167.64
K-TJ0G-784824-L	2050	29.5	78	24	7.97	176.72
K-TJ0G-844824-L	2147	29.5	84	24	8.56	185.8
<b>Right Hand</b>						
K-TJ0G-604824-R	1738	29.5	60	24	6.22	149.48
K-TJ0G-664824-R	1854	29.5	66	24	6.81	158.56
K-TJ0G-724824-R	1948	29.5	72	24	7.39	167.64
K-TJ0G-784824-R	2050	29.5	78	24	7.97	176.72
K-TJ0G-844824-R	2147	29.5	84	24	8.56	185.8

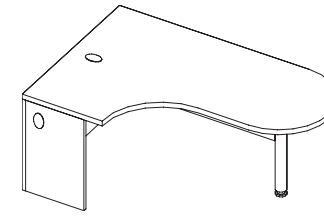

This table should be connected to a bridge or return to complete a full workstation (right hand shown).

**Ordering Options:**

Use the following checklist to customize the finishes on your order:

- laminate
- trim color
- grommet color
- metal color (posts)

Each laminate comes with matching vinyl trim color unless otherwise specified on your purchase order. Refer to the laminate finish card for our current offering.

**Details:**

Grommets are available in black or silver. Black is the standard grommet option unless otherwise specified on your purchase order.

Item includes worksurface, 1 post leg, and mounting hardware.

All gables include grommets.

Code	Price	H	W	D	Volume (ft <sup>3</sup> )	Weight (lb)
<b>Left Hand</b>						
KL-TJ0G-604824L	1621	29	60	24	6.22	120.67
KL-TJ0G-664824L	1739	29	66	24	6.81	127.15
KL-TJ0G-724824L	1833	29	72	24	7.39	133.63
KL-TJ0G-784824L	1937	29	78	24	7.97	140.11
KL-TJ0G-844824L	2031	29	84	24	8.56	146.59
<b>Right Hand</b>						
KL-TJ0G-604824R	1621	29	60	24	6.22	120.67
KL-TJ0G-664824R	1739	29	66	24	6.81	127.15
KL-TJ0G-724824R	1833	29	72	24	7.39	133.63
KL-TJ0G-784824R	1937	29	78	24	7.97	140.11
KL-TJ0G-844824R	2031	29	84	24	8.56	146.59

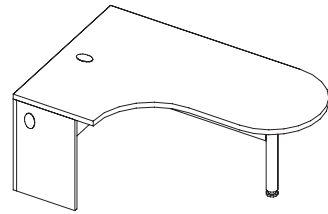

This table should be connected to a bridge or return to complete a full workstation (right hand shown).

J-Table, 1.5" Thick Surface

**Ordering Options:**

Use the following checklist to customize the finishes on your order:

- laminate
- trim color
- edge profile
- grommet color
- metal color (posts)

Each laminate comes with matching vinyl trim color unless otherwise specified on your purchase order. Refer to the laminate finish card for our current offering.

**Details:**

Grommets are available in black or silver. Black is the standard grommet option unless otherwise specified on your purchase order.

Item includes worksurface, 1 post leg, and mounting hardware.

All gables include grommets.

Code	Price	H	W	D	Volume (ft <sup>3</sup> )	Weight (lb)
<b>Left Hand</b>						
K-TP0G-6030-L	1597	29.5	60	30	7.56	119.92
K-TP0G-6630-L	1671	29.5	66	30	8.26	128.78
K-TP0G-7230-L	1727	29.5	72	30	8.97	137.64
K-TP0G-7830-L	1796	29.5	78	30	9.68	146.5
K-TP0G-8430-L	1860	29.5	84	30	10.39	155.36
<b>Right Hand</b>						
K-TP0G-6030-R	1597	29.5	60	30	7.56	119.92
K-TP0G-6630-R	1671	29.5	66	30	8.26	128.78
K-TP0G-7230-R	1727	29.5	72	30	8.97	137.64
K-TP0G-7830-R	1796	29.5	78	30	9.68	146.5
K-TP0G-8430-R	1860	29.5	84	30	10.39	155.36

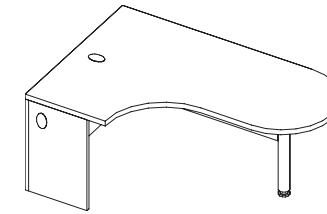

This table should be connected to a bridge or return to complete a full workstation (right hand shown).

**Ordering Options:**

Use the following checklist to customize the finishes on your order:

- laminate
- trim color
- grommet color
- metal color (posts)

Each laminate comes with matching vinyl trim color unless otherwise specified on your purchase order. Refer to the laminate finish card for our current offering.

**Details:**

Grommets are available in black or silver. Black is the standard grommet option unless otherwise specified on your purchase order.

Item includes worksurface, 1 post leg, and mounting hardware.

All gables include grommets.

Code	Price	H	W	D	Volume (ft <sup>3</sup> )	Weight (lb)
<b>Left Hand</b>						
KL-TP0G-6030-L	1485	29	60	30	7.56	96.51
KL-TP0G-6630-L	1559	29	66	30	8.26	103.34
KL-TP0G-7230-L	1613	29	72	30	8.97	110.17
KL-TP0G-7830-L	1683	29	78	30	9.68	117
KL-TP0G-8430-L	1746	29	84	30	10.39	123.83
<b>Right Hand</b>						
KL-TP0G-6030-R	1485	29	60	30	7.56	96.51
KL-TP0G-6630-R	1559	29	66	30	8.26	103.34
KL-TP0G-7230-R	1613	29	72	30	8.97	110.17
KL-TP0G-7830-R	1683	29	78	30	9.68	117
KL-TP0G-8430-R	1746	29	84	30	10.39	123.83



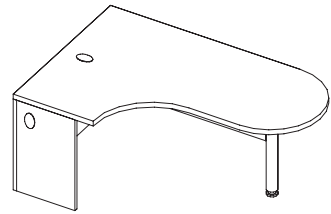

This table should be connected to a bridge or return to complete a full workstation (right hand shown).

F-Table, 1.5" Thick Surface

**Ordering Options:**

Use the following checklist to customize the finishes on your order:

- laminate
- trim color
- edge profile
- grommet color
- metal color (posts)

Each laminate comes with matching vinyl trim color unless otherwise specified on your purchase order. Refer to the laminate finish card for our current offering.

**Details:**

Grommets are available in black or silver. Black is the standard grommet option unless otherwise specified on your purchase order.

Item includes worksurface, 1 post leg, and mounting hardware.

All gables include grommets.

Code	Price	H	W	D	Volume (ft <sup>3</sup> )	Weight (lb)
<b>Left Hand</b>						
K-TFSG-604824-L	2044	29.5	60	24	7.26	152.9
K-TFSG-664824-L	2087	29.5	66	24	7.94	161.05
K-TFSG-724824-L	2131	29.5	72	24	8.62	169.2
K-TFSG-784824-L	2171	29.5	78	24	9.3	177.35
K-TFSG-844824-L	2215	29.5	84	24	9.98	185.5
<b>Right Hand</b>						
K-TFSG-604824-R	2044	29.5	60	24	7.26	152.9
K-TFSG-664824-R	2087	29.5	66	24	7.94	161.05
K-TFSG-724824-R	2131	29.5	72	24	8.62	169.2
K-TFSG-784824-R	2171	29.5	78	24	9.3	177.35
K-TFSG-844824-R	2215	29.5	84	24	9.98	185.5

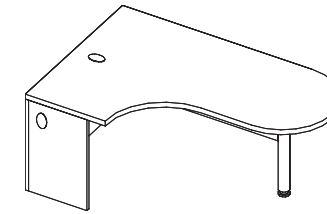

This table should be connected to a bridge or return to complete a full workstation (right hand shown).

**Ordering Options:**

Use the following checklist to customize the finishes on your order:

- laminate
- trim color
- grommet color
- metal color (posts)

Each laminate comes with matching vinyl trim color unless otherwise specified on your purchase order. Refer to the laminate finish card for our current offering.

**Details:**

Grommets are available in black or silver. Black is the standard grommet option unless otherwise specified on your purchase order.

Item includes worksurface, 1 post leg, and mounting hardware.

All gables include grommets.

Code	Price	H	W	D	Volume (ft <sup>3</sup> )	Weight (lb)
<b>Left Hand</b>						
KL-TFSG-604824L	1979	29	60	24	7.26	123.35
KL-TFSG-664824L	2012	29	66	24	7.94	129.35
KL-TFSG-724824L	2048	29	72	24	8.62	135.35
KL-TFSG-784824L	2083	29	78	24	9.3	141.35
KL-TFSG-844824L	2118	29	84	24	9.98	147.35
<b>Right Hand</b>						
KL-TFSG-604824R	1979	29	60	24	7.26	123.35
KL-TFSG-664824R	2012	29	66	24	7.94	129.35
KL-TFSG-724824R	2048	29	72	24	8.62	135.35
KL-TFSG-784824R	2083	29	78	24	9.3	141.35
KL-TFSG-844824R	2118	29	84	24	9.98	147.35

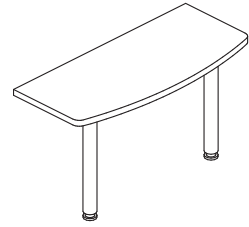

This table is semi-supported and must be used against freestanding furniture. It is typically used as an additional surface in conjunction with two workstation returns.

U-Table, 1.5" Thick Surface

**Ordering Options:**

Use the following checklist to customize the finishes on your order:

- laminate
- trim color
- edge profile
- grommet color
- metal color (posts)

Each laminate comes with matching vinyl trim color unless otherwise specified on your purchase order. Refer to the laminate finish card for our current offering.

**Details:**

Item includes worksurface, 2 post legs, and mounting hardware.

Code	Price	H	W	D	Volume (ft <sup>3</sup> )	Weight (lb)
T-WEU0-4224	976	29.5	42	24	2.98	51.19
T-WEU0-4824	1009	29.5	48	24	3.37	56.54
T-WEU0-6024	1190	29.5	60	24	4.15	61.88

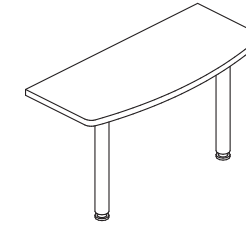

This table is semi-supported and must be used against freestanding furniture. It is typically used as an additional surface in conjunction with two workstation returns.

**Ordering Options:**

Use the following checklist to customize the finishes on your order:

- laminate
- trim color
- grommet color
- metal color (posts)

Each laminate comes with matching vinyl trim color unless otherwise specified on your purchase order. Refer to the laminate finish card for our current offering.

**Details:**

Code	Price	H	W	D	Volume (ft <sup>3</sup> )	Weight (lb)
TL-WEU0-4224	843	29	42	24	2.98	38.79
TL-WEU0-4824	876	29	48	24	3.37	42.36
TL-WEU0-6024	1057	29	60	24	4.15	45.92

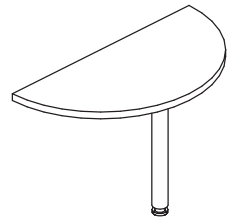

This table is semi-supported and must be used against freestanding furniture. It is typically used as an additional surface in conjunction with two workstation returns.

D-Table, 1.5" Thick Surface

**Ordering Options:**

Use the following checklist to customize the finishes on your order:

- laminate
- trim color
- edge profile
- grommet color
- metal color (posts)

Each laminate comes with matching vinyl trim color unless otherwise specified on your purchase order. Refer to the laminate finish card for our current offering.

**Details:**

Item includes worksurface, one post leg, and mounting hardware.

Code	Price	H	W	D	Volume (ft <sup>3</sup> )	Weight (lb)
T-TC00-4221	703	29.5	42	21	2	34
T-TC00-4824	809	29.5	48	24	2.53	42.1
T-TC00-6030	911	29.5	60	30	3.78	50

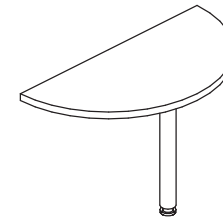

This table is semi-supported and must be used against freestanding furniture. It is typically used as an additional surface in conjunction with two workstation returns.

**Ordering Options:**

Use the following checklist to customize the finishes on your order:

- laminate
- trim color
- grommet color
- metal color (posts)

Each laminate comes with matching vinyl trim color unless otherwise specified on your purchase order. Refer to the laminate finish card for our current offering.

**Details:**

Item includes worksurface, one post leg, and mounting hardware.

Code	Price	H	W	D	Volume (ft <sup>3</sup> )	Weight (lb)
TL-TC00-4221	654	29	42	21	2	25
TL-TC00-4824	757	29	48	24	2.53	30.56
TL-TC00-6030	862	29	60	30	3.78	36.12

Executive

<u>straight front corner surface</u>	
<u>full modesty</u>	52
<u>partial modesty</u>	54
<u>curved front corner surface</u>	
<u>full modesty</u>	56
<u>partial modesty</u>	58

Professional

<u>straight front corner surface</u>	
<u>full modesty</u>	53
<u>partial modesty</u>	55
<u>curved front corner surface</u>	
<u>full modesty</u>	57
<u>partial modesty</u>	59

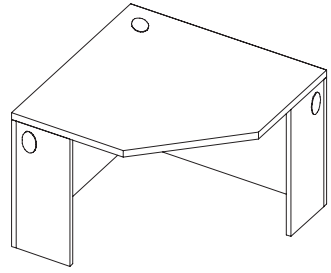

This item is for use in corners when connected to returns or bridges.

Straight Front Corner Surface  
Full Modesty, 1.5" Thick Surface

**Ordering Options:**

Use the following checklist to customize the finishes on your order:

- laminate
- trim color
- edge profile
- grommet color

Each laminate comes with matching vinyl trim color unless otherwise specified on your purchase order. Refer to the laminate finish card for our current offering.

**Details:**

Grommets are available in black or silver. Black is the standard grommet option unless otherwise specified on your purchase order.

All gables include grommets.

Code	Price	H	W	D	Volume (ft <sup>3</sup> )	Weight (lb)
K-W5S0-3618	1082	29.5	36	18	2.55	112.69
K-W5S0-3621	1082	29.5	36	21	2.89	114.3
K-W5S0-3624	1082	29.5	36	24	3.24	116.21
K-W5S0-4221	1274	29.5	42	21	3.33	137.24
K-W5S0-4224	1274	29.5	42	24	3.73	139.52
K-W5S0-4830	1487	29.5	48	30	5.12	177.72

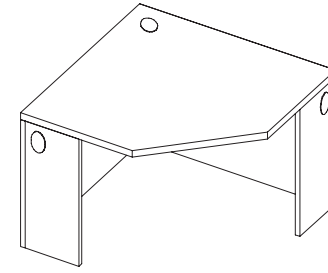

This item is for use in corners when connected to returns or bridges.

Straight Front Corner Surface  
Full Modesty, 1" Thick Surface

**Ordering Options:**

Use the following checklist to customize the finishes on your order:

- laminate
- trim color
- grommet color

Each laminate comes with matching vinyl trim color unless otherwise specified on your purchase order. Refer to the laminate finish card for our current offering.

**Details:**

Grommets are available in black or silver. Black is the standard grommet option unless otherwise specified on your purchase order.

All gables include grommets.

Code	Price	H	W	D	Volume (ft <sup>3</sup> )	Weight (lb)
KL-W5S0-3618	1005	29	36	18	2.55	97.93
KL-W5S0-3621	1005	29	36	21	2.89	99.2
KL-W5S0-3624	1005	29	36	24	3.24	100.27
KL-W5S0-4221	1181	29	42	21	3.33	117.14
KL-W5S0-4224	1181	29	42	24	3.73	118.66
KL-W5S0-4830	1376	29	48	30	5.12	149.83

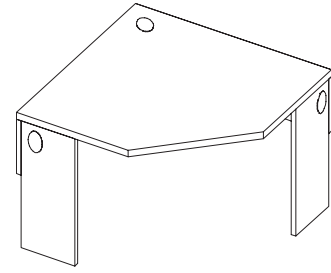

This item is for use in corners when connected to returns or bridges. Partial modesty allows access to electrical outlets when installed against walls.

Straight Front Corner Surface Partial Modesty & Post, 1.5" Thick Surface

**Ordering Options:**

Use the following checklist to customize the finishes on your order:

- laminate
- trim color
- edge profile
- grommet color

Each laminate comes with matching vinyl trim color unless otherwise specified on your purchase order. Refer to the laminate finish card for our current offering.

**Details:**

Partial modesty height 12 inches.  
 Grommets are available in black or silver. Black is the standard grommet option unless otherwise specified on your purchase order.  
 All gables include grommets.  
 Metal post leg included.

Code	Price	H	W	D	Volume (ft <sup>3</sup> )	Weight (lb)
K-W5S0-3618-P	1082	29.5	36	18	2.55	83.12
K-W5S0-3621-P	1082	29.5	36	21	2.89	84.74
K-W5S0-3624-P	1082	29.5	36	24	3.24	86.65
K-W5S0-4221-P	1274	29.5	42	21	3.33	102.88
K-W5S0-4224-P	1274	29.5	42	24	3.73	105.16
K-W5S0-4830-P	1487	29.5	48	30	5.12	138.56

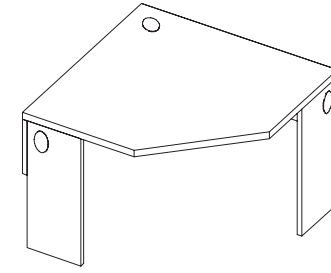

This item is for use in corners when connected to returns or bridges. Partial modesty allows access to electrical outlets when installed against walls.

Straight Front Corner Surface Partial Modesty & Post, 1." Thick Surface

**Ordering Options:**

Use the following checklist to customize the finishes on your order:

- laminate
- trim color
- grommet color

Each laminate comes with matching vinyl trim color unless otherwise specified on your purchase order. Refer to the laminate finish card for our current offering.

**Details:**

Partial modesty height 12 inches.  
 Grommets are available in black or silver. Black is the standard grommet option unless otherwise specified on your purchase order.  
 All gables include grommets.  
 Metal post leg included.

Code	Price	H	W	D	Volume (ft <sup>3</sup> )	Weight (lb)
KL-W5S0-3618-P	1005	29	36	18	2.55	68.37
KL-W5S0-3621-P	1005	29	36	21	2.89	69.94
KL-W5S0-3624-P	1005	29	36	24	3.24	70.71
KL-W5S0-4221-P	1181	29	42	21	3.33	82.78
KL-W5S0-4224-P	1181	29	42	24	3.73	84.3
KL-W5S0-4830-P	1376	29	48	30	5.12	110.67

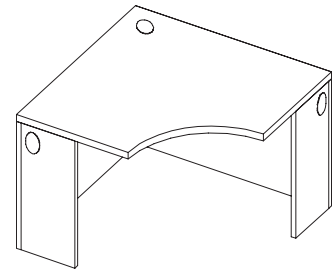

This item is for use in corners when connected to returns or bridges.

Curved Front Corner Surface  
Full Modesty, 1.5" Thick Surface

**Ordering Options:**

Use the following checklist to customize the finishes on your order:

- laminate
- trim color
- edge profile
- grommet color

Each laminate comes with matching vinyl trim color unless otherwise specified on your purchase order. Refer to the laminate finish card for our current offering.

**Details:**

Grommets are available in black or silver. Black is the standard grommet option unless otherwise specified on your purchase order.

All gables include grommets

Code	Price	H	W	D	Volume (ft <sup>3</sup> )	Weight (lb)
K-W5C0-3618	1082	29.5	36	18	2.55	108.9
K-W5C0-3621	1082	29.5	36	21	2.89	112.21
K-W5C0-3624	1082	29.5	36	24	3.24	114.6
K-W5C0-4221	1274	29.5	42	21	3.33	132.52
K-W5C0-4224	1274	29.5	42	24	3.73	136.12
K-W5C0-4830	1487	29.5	48	30	5.12	174.1

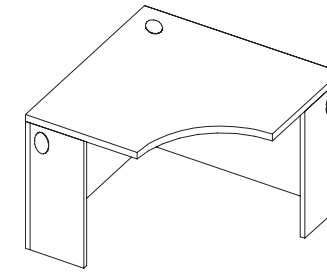

This item is for use in corners when connected to returns or bridges.

Curved Front Corner Surface Full Modesty, 1" Thick Surface

**Ordering Options:**

Use the following checklist to customize the finishes on your order:

- laminate
- trim color
- grommet color

Each laminate comes with matching vinyl trim color unless otherwise specified on your purchase order. Refer to the laminate finish card for our current offering.

**Details:**

Grommets are available in black or silver. Black is the standard grommet option unless otherwise specified on your purchase order.

All gables include grommets

Code	Price	H	W	D	Volume (ft <sup>3</sup> )	Weight (lb)
KL-W5C0-3618	1005	29	36	18	2.55	94.5
KL-W5C0-3621	1005	29	36	21	2.89	97.54
KL-W5C0-3624	1005	29	36	24	3.24	98.3
KL-W5C0-4221	1181	29	42	21	3.33	113.86
KL-W5C0-4224	1181	29	42	24	3.73	116.26
KL-W5C0-4830	1376	29	48	30	5.12	147.42



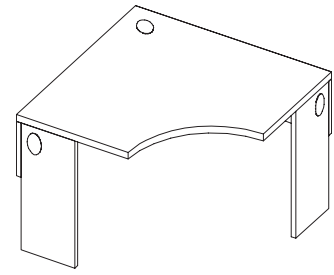

This item is for use in corners when connected to returns or bridges. Partial modesty give access to electrical outlets when installed against walls.

Curved Front Corner Surface  
Partial Modesty & Post,  
1.5" Thick Surface

**Ordering Options:**

Use the following checklist to customize the finishes on your order:

- laminate
- trim color
- edge profile
- grommet color

Each laminate comes with matching vinyl trim color unless otherwise specified on your purchase order. Refer to the laminate finish card for our current offering.

**Details:**

Partial modesty height 12 inches.  
Grommets are available in black or silver. Black is the standard grommet option unless otherwise specified on your purchase order.  
All gables include grommets.  
Metal post included.

Code	Price	H	W	D	Volume (ft <sup>3</sup> )	Weight (lb)
K-W5C0-3618-P	1082	29.5	36	18	2.55	79.33
K-W5C0-3621-P	1082	29.5	36	21	2.89	82.62
K-W5C0-3624-P	1082	29.5	36	24	3.24	85.1
K-W5C0-4221-P	1274	29.5	42	21	3.33	94.27
K-W5C0-4224-P	1274	29.5	42	24	3.73	97.87
K-W5C0-4830-P	1487	29.5	48	30	5.12	127.3

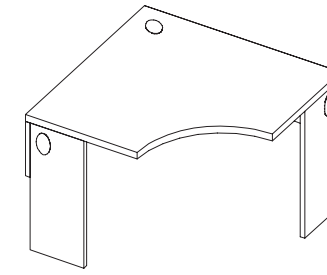

This item is for use in corners when connected to returns or bridges. Partial modesty give access to electrical outlets when installed against walls.

**Ordering Options:**

Use the following checklist to customize the finishes on your order:

- laminate
- trim color
- grommet color

Each laminate comes with matching vinyl trim color unless otherwise specified on your purchase order. Refer to the laminate finish card for our current offering.

**Details:**

Partial modesty height 12 inches.  
Grommets are available in black or silver. Black is the standard grommet option unless otherwise specified on your purchase order.  
All gables include grommets.  
Metal post included.

Code	Price	H	W	D	Volume (ft <sup>3</sup> )	Weight (lb)
KL-W5C0-3618-P	1005	29	36	18	2.55	65
KL-W5C0-3621-P	1005	29	36	21	2.89	67.98
KL-W5C0-3624-P	1005	29	36	24	3.24	68.74
KL-W5C0-4221-P	1181	29	42	21	3.33	75.61
KL-W5C0-4224-P	1181	29	42	24	3.73	78.01
KL-W5C0-4830-P	1376	29	48	30	5.12	100.62

Code	Price	W	D	Description
KL-WTLC-3636	669	36	36	0 29CORNER C/T,F/36X36,1" T8
KL-WTLC-4242	694	42	42	0 CORNER C/T,F/42X42,1" T10
KL-WTLC-4848	732	48	48	0 CORNER C/T,F/48X48,1" T12



Metro Collab  
August 2024  
**Unitized  
Desks**

unitized desks

Executive

curved front unitized desk

full modesty 62

partial modesty 64

Professional

curved front unitized desk

full modesty 63

partial modesty 65

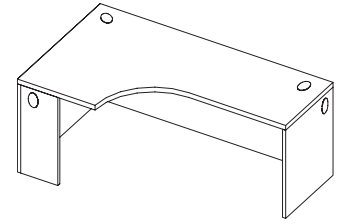

This item is for use in corners when connected to returns or bridges (right hand shown).

Curved Front Unitized Desk Full Modesty, 1.5" Thick Surface

**Ordering Options:**

Use the following checklist to customize the finishes on your order:

- laminate
- trim color
- edge profile
- grommet color

Each laminate comes with matching vinyl trim color unless otherwise specified on your purchase order. Refer to the laminate finish card for our current offering.

**Details:**

Grommets are available in black or silver. Black is the standard grommet option unless otherwise specified on your purchase order.

All gables include grommets.

Code	Price	H	W	D	Volume (ft <sup>3</sup> )	Weight (lb)
K-UC4G-6639-L	1668	29.5	66	39	10.45	146.65
K-UC4G-7239-L	1777	29.5	72	39	11.35	181.17
K-UC4G-6639-R	1668	29.5	66	39	10.45	146.65
K-UC4G-7239-R	1777	29.5	72	39	11.35	181.17
K-UC4G-6642-L	1738	29.5	66	42	11.18	184.39
K-UC4G-7242-L	2083	29.5	72	42	12.14	194.16
K-UC4G-6642-R	1738	29.5	66	42	11.18	184.39
K-UC4G-7242-R	2083	29.5	72	42	12.14	194.16

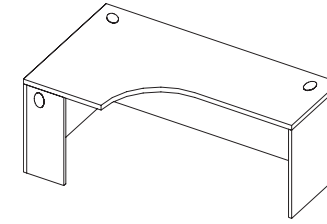

This item is for use in corners when connected to returns or bridges (right hand shown).

**Ordering Options:**

Use the following checklist to customize the finishes on your order:

- laminate
- trim color
- grommet color

Each laminate comes with matching vinyl trim color unless otherwise specified on your purchase order. Refer to the laminate finish card for our current offering.

**Details:**

Grommets are available in black or silver. Black is the standard grommet option unless otherwise specified on your purchase order.

All gables include grommets.

Code	Price	H	W	D	Volume (ft <sup>3</sup> )	Weight (lb)
KL-UC4G-6639-L	1547	29	66	39	10.45	120.6
KL-UC4G-7239-L	1645	29	72	39	11.35	153.9
KL-UC4G-6639-R	1547	29	66	39	10.45	120.6
KL-UC4G-7239-R	1645	29	72	39	11.35	153.9
KL-UC4G-6642-L	1610	29	66	42	11.18	161.1
KL-UC4G-7242-L	1931	29	72	42	12.14	170.55
KL-UC4G-6642-R	1610	29	66	42	11.18	161.1
KL-UC4G-7242-R	1931	29	72	42	12.14	170.55

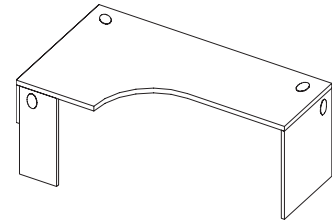

This item is for use in corners when connected to returns or bridges. Partial modesty gives access to electrical outlets when placed against walls (right hand shown).

Curved Front Unitized Desk  
Partial Modesty, 1.5" Thick Surface

**Ordering Options:**

Use the following checklist to customize the finishes on your order:

- laminate
- trim color
- edge profile
- grommet color

Each laminate comes with matching vinyl trim color unless otherwise specified on your purchase order. Refer to the laminate finish card for our current offering.

**Details:**

Partial modesty height 12 inches.  
Grommets are available in black or silver. Black is the standard grommet option unless otherwise specified on your purchase order.  
All gables include grommets

Code	Price	H	W	D	Volume (ft <sup>3</sup> )	Weight (lb)
K-UC4Z-6639-L	1668	29.5	66	39	10.45	146.65
K-UC4Z-7239-L	1777	29.5	72	39	11.35	181.17
K-UC4Z-6639-R	1668	29.5	66	39	10.45	146.65
K-UC4Z-7239-R	1777	29.5	72	39	11.35	181.17
K-UC4Z-6642-L	1738	29.5	66	42	11.18	184.39
K-UC4Z-7242-L	2083	29.5	72	42	12.14	194.16
K-UC4Z-6642-R	1738	29.5	66	42	11.18	184.39
K-UC4Z-7242-R	2083	29.5	72	42	12.14	194.16

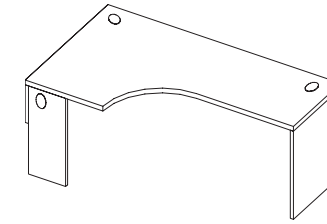

This item is for use in corners when connected to returns or bridges. Partial modesty gives access to electrical outlets when placed against walls (right hand shown).

Curved Front Unitized Desk  
Partial Modesty, 1" Thick Surface

**Ordering Options:**

Use the following checklist to customize the finishes on your order:

- laminate
- trim color
- grommet color

Each laminate comes with matching vinyl trim color unless otherwise specified on your purchase order. Refer to the laminate finish card for our current offering.

**Details:**

Partial modesty height 12 inches.  
Grommets are available in black or silver. Black is the standard grommet option unless otherwise specified on your purchase order.  
All gables include grommets

Code	Price	H	W	D	Volume (ft <sup>3</sup> )	Weight (lb)
KL-UC4Z-6639-L	1547	29	66	39	10.45	99.79
KL-UC4Z-7239-L	1645	29	72	39	11.35	108.77
KL-UC4Z-6639-R	1547	29	66	39	10.45	99.79
KL-UC4Z-7239-R	1645	29	72	39	11.35	108.77
KL-UC4Z-6642-L	1610	29	66	42	11.18	114.66
KL-UC4Z-7242-L	1931	29	72	42	12.14	126.11
KL-UC4Z-6642-R	1610	29	66	42	11.18	114.66
KL-UC4Z-7242-R	1931	29	72	42	12.14	126.11



Metro Collab  
August 2024  
**Bridges**

Executive

straight bridge	
full modesty	68
partial modesty	70
notched bridge	
full modesty	72
partial modesty	74
bowed bridge	
full modesty	76
partial modesty	78

Professional

straight bridge	
full modesty	69
partial modesty	71
notched bridge	
full modesty	73
partial modesty	75
bowed bridge	
full modesty	77
partial modesty	79

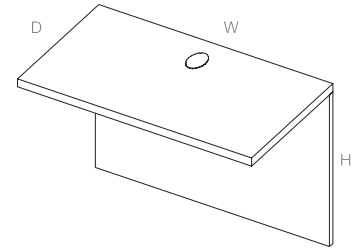

This bridge must be connected to two freestanding desks or credenza. Corners and unitized desks with matching depths can also be connected on either side to complete a workstation.

Straight Bridge Full Modesty, 1.5" Thick Surface

**Ordering Options:**

Use the following checklist to customize the finishes on your order:

- laminate
- trim color
- edge profile
- grommet color

Each laminate comes with matching vinyl trim color unless otherwise specified on your purchase order. Refer to the laminate finish card for our current offering.

**Details:**

Grommets are available in black or silver. Black is the standard grommet option unless otherwise specified on your purchase order.

Code	Price	H	W	D	Volume (ft <sup>3</sup> )	Weight (lb)
K-BS0G-3021	502	29.5	30	21	1.48	46.17
K-BS0G-3621	541	29.5	36	21	1.74	55.5
K-BS0G-4221	603	29.5	42	21	2	64.83
K-BS0G-4821	641	29.5	48	21	2.26	74.16
K-BS0G-3024	525	29.5	30	24	1.65	49.5
K-BS0G-3624	564	29.5	36	24	1.94	60
K-BS0G-4224	625	29.5	42	24	2.24	70.5
K-BS0G-4824	703	29.5	48	24	2.53	81
K-BS0G-3030	564	29.5	30	30	2.01	56.75
K-BS0G-3630	618	29.5	36	30	2.36	68.28
K-BS0G-4230	683	29.5	42	30	2.72	79.81
K-BS0G-4830	770	29.5	48	30	3.07	91.34

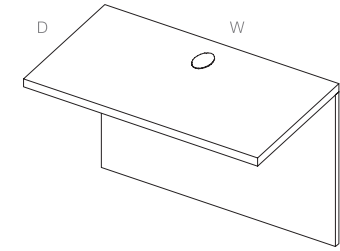

This bridge must be connected to two freestanding desks or credenza. Corners and unitized desks with matching depths can also be connected on either side to complete a workstation.

Straight Bridge Full Modesty, 1" Thick Surface

**Ordering Options:**

Use the following checklist to customize the finishes on your order:

- laminate
- trim color
- grommet color

Each laminate comes with matching vinyl trim color unless otherwise specified on your purchase order. Refer to the laminate finish card for our current offering.

**Details:**

Grommets are available in black or silver. Black is the standard grommet option unless otherwise specified on your purchase order.

Code	Price	H	W	D	Volume (ft <sup>3</sup> )	Weight (lb)
KL-BS0G-1824	474	29	18	24	0	35
KL-BS0G-2421	454	29	24	21	0	40.35
KL-BS0G-2424	474	29	24	24	0	40.35
KL-BS0G-3021	474	29	30	21	1.48	38
KL-BS0G-3024	496	29	30	24	1.65	40.35
KL-BS0G-3030	531	29	30	30	2.01	45.03
KL-BS0G-3621	511	29	36	21	1.74	45.78
KL-BS0G-3624	531	29	36	24	1.94	48.6
KL-BS0G-3630	580	29	36	30	2.36	54.22
KL-BS0G-4221	568	29	42	21	2	53.56
KL-BS0G-4224	586	29	42	24	2.24	56.85
KL-BS0G-4230	641	29	42	30	2.72	63.41
KL-BS0G-4821	607	29	48	21	2.26	61.34
KL-BS0G-4824	665	29	48	24	2.53	65.1
KL-BS0G-4830	725	29	48	30	3.07	72.6
KL-BS0G-5421	726	29	54	21	0	54
KL-BS0G-5424	726	29	54	24	0	0
KL-BS0G-6024	726	29	60	24	0	0

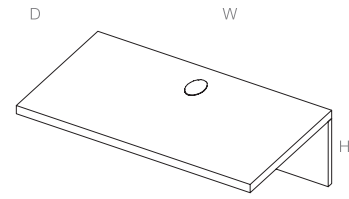

This bridge must be connected to two freestanding desks or credenza. Corners and unitized desks with matching depths can also be connected on either side. Partial modesty gives access to electrical outlets when installed against walls.

Straight Bridge Partial Modesty, 1.5" Thick Surface

**Ordering Options:**

Use the following checklist to customize the finishes on your order:

- laminate
- trim color
- edge profile
- grommet color

Each laminate comes with matching vinyl trim color unless otherwise specified on your purchase order. Refer to the laminate finish card for our current offering.

**Details:**

Partial modesty height 12 inches.

Grommets are available in black or silver. Black is the standard grommet option unless otherwise specified on your purchase order.

Code	Price	H	W	D	Volume (ft <sup>3</sup> )	Weight (lb)
K-BS0Z-3021	502	29.5	30	21	1.48	33.67
K-BS0Z-3621	541	29.5	36	21	1.74	43
K-BS0Z-4221	603	29.5	42	21	2	52.33
K-BS0Z-4821	641	29.5	48	21	2.26	61.66
K-BS0Z-3024	525	29.5	30	24	1.65	33.3
K-BS0Z-3624	564	29.5	36	24	1.94	43.8
K-BS0Z-4224	625	29.5	42	24	2.24	54.3
K-BS0Z-4824	703	29.5	48	24	2.53	64.8
K-BS0Z-3030	564	29.5	30	30	2.01	44.1
K-BS0Z-3630	618	29.5	36	30	2.36	55.63
K-BS0Z-4230	683	29.5	42	30	2.72	67.16
K-BS0Z-4830	770	29.5	48	30	3.07	78.69

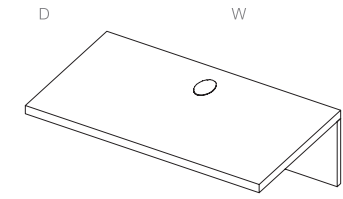

This bridge must be connected to two freestanding desks or credenza. Corners and unitized desks with matching depths can also be connected on either side. Partial modesty gives access to electrical outlets when installed against walls.

Straight Bridge Partial Modesty, 1" Thick Surface

**Ordering Options:**

Use the following checklist to customize the finishes on your order:

- laminate
- trim color
- grommet color

Each laminate comes with matching vinyl trim color unless otherwise specified on your purchase order. Refer to the laminate finish card for our current offering.

**Details:**

Grommets are available in black or silver. Black is the standard grommet option unless otherwise specified on your purchase order.

Code	Price	H	W	D	Volume (ft <sup>3</sup> )	Weight (lb)
KL-BS0Z-1818	416	29	18	18	0	40
KL-BS0Z-1824	439	29	18	24	0	52.5
KL-BS0Z-2421	454	29	24	21	0	27.75
KL-BS0Z-2424	474	29	24	24	0	27.75
KL-BS0Z-2924	496	29	29	24	0	27.75
KL-BS0Z-3021	474	29	30	21	1.48	25.4
KL-BS0Z-3024	496	29	30	24	1.65	27.75
KL-BS0Z-3030	531	29	30	30	2.01	32.43
KL-BS0Z-3621	511	29	36	21	1.74	33.18
KL-BS0Z-3624	531	29	36	24	1.94	36
KL-BS0Z-3630	580	29	36	30	2.36	41.62
KL-BS0Z-4221	568	29	42	21	2	40.96



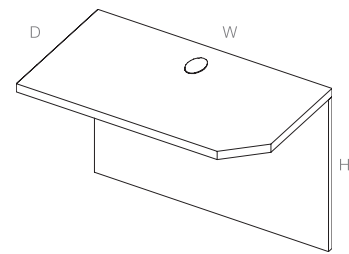

This bridge must be connected to two freestanding desks or credenza. Corners and unitized desks with matching depths can also be connected on either side to complete a workstation. Works with Straight Front Corners

(left hand shown).

Notched Bridge Full Modesty, 1.5" Thick Surface

**Ordering Options:**

Use the following checklist to customize the finishes on your order:

- laminate
- trim color
- edge profile
- grommet color

Each laminate comes with matching vinyl trim color unless otherwise specified on your purchase order. Refer to the laminate finish card for our current offering.

**Details:**

Grommets are available in black or silver. Black is the standard grommet option unless otherwise specified on your purchase order.

Code	Price	H	W	D	Volume (ft <sup>3</sup> )	Weight (lb)
K-BN0G-3624-L	618	29.5	36	24	1.94	59.1
K-BN0G-4224-L	683	29.5	42	24	2.24	68.87
K-BN0G-4824-L	770	29.5	48	24	2.53	78.64
K-BN0G-3624-R	618	29.5	36	24	1.94	59.1
K-BN0G-4224-R	683	29.5	42	24	2.24	68.87
K-BN0G-4824-R	770	29.5	48	24	2.53	78.64
K-BN0G-3630-L	638	29.5	36	30	2.36	67.58
K-BN0G-4230-L	703	29.5	42	30	2.72	79.11
K-BN0G-4830-L	790	29.5	48	30	3.07	90.64
K-BN0G-3630-R	638	29.5	36	30	2.36	67.58
K-BN0G-4230-R	703	29.5	42	30	2.72	79.11
K-BN0G-4830-R	790	29.5	48	30	3.07	90.64

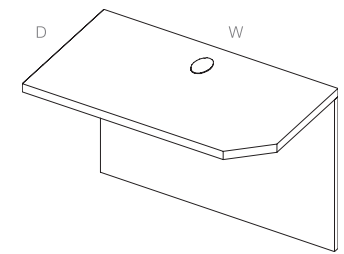

This bridge must be connected to two freestanding desks or credenza. Corners and unitized desks with matching depths can also be connected on either side to complete a workstation. Works with Straight Front Corners

(left hand shown).

Notched Bridge Full Modesty, 1.5" Thick Surface

**Ordering Options:**

Use the following checklist to customize the finishes on your order:

- laminate
- trim color
- grommet color

Each laminate comes with matching vinyl trim color unless otherwise specified on your purchase order. Refer to the laminate finish card for our current offering.

**Details:**

Grommets are available in black or silver. Black is the standard grommet option unless otherwise specified on your purchase order.

Code	Price	H	W	D	Volume (ft <sup>3</sup> )	Weight (lb)
KL-BN0G-3624-L	580	29	36	24	1.94	48.13
KL-BN0G-3624-R	580	29	36	24	1.94	48.13
KL-BN0G-3630-L	603	29	36	30	2.36	58.25
KL-BN0G-3630-R	603	29	36	30	2.36	58.25
KL-BN0G-4224-L	641	29	42	24	2.24	56.38
KL-BN0G-4224-R	641	29	42	24	2.24	56.38
KL-BN0G-4230-L	665	29	42	30	2.72	66.48
KL-BN0G-4230-R	665	29	42	30	2.72	66.48
KL-BN0G-4824-L	725	29	48	24	2.53	64.63
KL-BN0G-4824-R	725	29	48	24	2.53	64.63
KL-BN0G-4830-L	744	29	48	30	3.07	74.71
KL-BN0G-4830-R	744	29	48	30	3.07	74.71

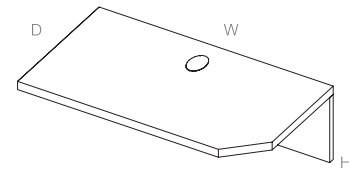

This bridge must be connected to two freestanding desks or credenza. Corners and unitized desks with matching depths can also be connected on either side. Partial modesty gives access to electrical outlets when installed against walls.

Notched Bridge Partial Modesty, 1.5" Thick Surface

**Ordering Options:**

Use the following checklist to customize the finishes on your order:

- laminate
- trim color
- edge profile
- grommet color

Each laminate comes with matching vinyl trim color unless otherwise specified on your purchase order. Refer to the laminate finish card for our current offering.

**Details:**

Partial modesty height 12 inches.

Grommets are available in black or silver. Black is the standard grommet option unless otherwise specified on your purchase order.

Code	Price	H	W	D	Volume (ft <sup>3</sup> )	Weight (lb)
K-BN0Z-3624-L	618	29.5	36	24	1.94	44.29
K-BN0Z-4224-L	683	29.5	42	24	2.24	54.06
K-BN0Z-4824-L	770	29.5	48	24	2.53	63.83
K-BN0Z-3624-R	618	29.5	36	24	1.94	44.29
K-BN0Z-4224-R	683	29.5	42	24	2.24	54.06
K-BN0Z-4824-R	770	29.5	48	24	2.53	63.83
K-BN0Z-3630-L	638	29.5	36	30	2.36	52.65
K-BN0Z-4230-L	703	29.5	42	30	2.72	64.18
K-BN0Z-4830-L	790	29.5	48	30	3.07	75.71
K-BN0Z-3630-R	638	29.5	36	30	2.36	52.65
K-BN0Z-4230-R	703	29.5	42	30	2.72	64.18
K-BN0Z-4830-R	790	29.5	48	30	3.07	75.71

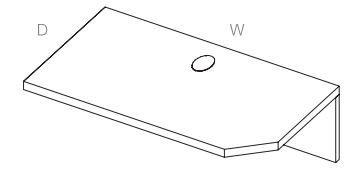

This bridge must be connected to two freestanding desks or credenza. Corners and unitized desks with matching depths can also be connected on either side. Partial modesty gives access to electrical outlets when installed against walls.

Notched Bridge Partial Modesty, 1" Thick Surface

**Ordering Options:**

Use the following checklist to customize the finishes on your order:

- laminate
- trim color
- grommet color

Each laminate comes with matching vinyl trim color unless otherwise specified on your purchase order. Refer to the laminate finish card for our current offering.

**Details:**

Partial modesty height 12 inches.

Grommets are available in black or silver. Black is the standard grommet option unless otherwise specified on your purchase order.

Code	Price	H	W	D	Volume (ft <sup>3</sup> )	Weight (lb)
KL-BN0Z-3624-L	580	29	36	24	1.94	32.85
KL-BN0Z-3624-R	580	29	36	24	1.94	32.85
KL-BN0Z-3630-L	603	29	36	30	2.36	38.9
KL-BN0Z-3630-R	603	29	36	30	2.36	38.9
KL-BN0Z-4224-L	641	29	42	24	2.24	41.1
KL-BN0Z-4224-R	641	29	42	24	2.24	41.1
KL-BN0Z-4230-L	665	29	42	30	2.72	47.13
KL-BN0Z-4230-R	665	29	42	30	2.72	47.13
KL-BN0Z-4824-L	725	29	48	24	2.53	49.35
KL-BN0Z-4824-R	725	29	48	24	2.53	49.35
KL-BN0Z-4830-L	744	29	48	30	3.07	55.36
KL-BN0Z-4830-R	744	29	48	30	3.07	55.36
No Grommet						
KL-BS00-4830	690	29	48	30	3.07	55.36

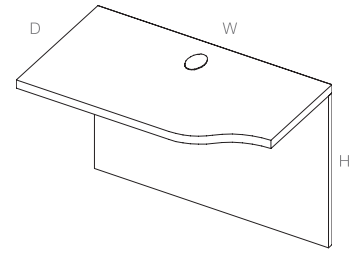

This bridge must be connected to two freestanding desks or credenza. Corners and unitized desks with matching depths can also be connected on either side. Partial modesty gives access to electrical outlets when installed against walls. Works with Curved Front Corners (left hand shown).

Bowed Bridge Full Modesty, 1.5" Thick Surface

**Ordering Options:**

Use the following checklist to customize the finishes on your order:

- laminate
- trim color
- edge profile
- grommet color

Each laminate comes with matching vinyl trim color unless otherwise specified on your purchase order. Refer to the laminate finish card for our current offering.

**Details:**

Grommets are available in black or silver. Black is the standard grommet option unless otherwise specified on your purchase order.

Code	Price	H	W	D	Volume (ft <sup>3</sup> )	Weight (lb)
K-BB0G-3624-L	618	29.5	36	24	1.94	58.03
K-BB0G-4224-L	683	29.5	42	24	2.24	68.16
K-BB0G-4824-L	770	29.5	48	24	2.53	78.29
K-BB0G-3624-R	618	29.5	36	24	1.94	58.03
K-BB0G-4224-R	683	29.5	42	24	2.24	68.16
K-BB0G-4824-R	770	29.5	48	24	2.53	78.29
K-BB0G-3630-L	638	29.5	36	30	2.36	66.47
K-BB0G-4230-L	703	29.5	42	30	2.72	78
K-BB0G-4830-L	790	29.5	48	30	3.07	89.53
K-BB0G-3630-R	638	29.5	36	30	2.36	66.47
K-BB0G-4230-R	703	29.5	42	30	2.72	78
K-BB0G-4830-R	790	29.5	48	30	3.07	89.53

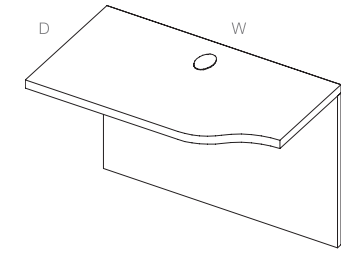

This bridge must be connected to two freestanding desks or credenza. Corners and unitized desks with matching depths can also be connected on either side. Partial modesty gives access to electrical outlets when installed against walls. Works with Curved Front Corners (left hand shown).

Bowed Bridge Full Modesty, 1" Thick Surface

**Ordering Options:**

Use the following checklist to customize the finishes on your order:

- laminate
- trim color
- grommet color

Each laminate comes with matching vinyl trim color unless otherwise specified on your purchase order. Refer to the laminate finish card for our current offering.

**Details:**

Grommets are available in black or silver. Black is the standard grommet option unless otherwise specified on your purchase order.

Code	Price	H	W	D	Volume (ft <sup>3</sup> )	Weight (lb)
KL-BB0G-2430-L	605	29	24	30	0	48
KL-BB0G-2430-R	605	29	24	30	0	48
KL-BB0G-3624-L	580	29	36	24	1.94	47.39
KL-BB0G-3624-R	580	29	36	24	1.94	47.39
KL-BB0G-3630-L	603	29	36	30	2.36	53
KL-BB0G-3630-R	603	29	36	30	2.36	53
KL-BB0G-4224-L	641	29	42	24	2.24	55.64
KL-BB0G-4224-R	641	29	42	24	2.24	55.64
KL-BB0G-4230-L	665	29	42	30	2.72	62.2
KL-BB0G-4230-R	665	29	42	30	2.72	62.2
KL-BB0G-4824-L	725	29	48	24	2.53	63.89
KL-BB0G-4824-R	725	29	48	24	2.53	63.89
KL-BB0G-4830-L	744	29	48	30	3.07	71.4
KL-BB0G-4830-R	744	29	48	30	3.07	71.4

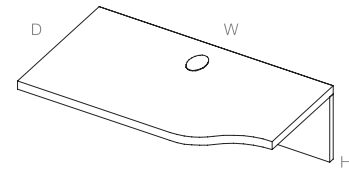

Bowed Bridge Partial Modesty, 1.5" Thick Surface

This bridge must be connected to two freestanding desks or credenza. Corners and unitized desks with matching depths can also be connected on either side. Partial modesty gives access to electrical outlets when installed against walls.

**Ordering Options:**

Use the following checklist to customize the finishes on your order:

- laminate
- trim color
- edge profile
- grommet color

Each laminate comes with matching vinyl trim color unless otherwise specified on your purchase order. Refer to the laminate finish card for our current offering.

**Details:**

Partial modesty height 12 inches.

Grommets are available in black or silver. Black is the standard grommet option unless otherwise specified on your purchase order.

Code	Price	H	W	D	Volume (ft <sup>3</sup> )	Weight (lb)
K-BB0Z-3624-L	618	29.5	36	24	1.94	42.75
K-BB0Z-4224-L	683	29.5	42	24	2.24	52.88
K-BB0Z-4824-L	770	29.5	48	24	2.53	63.01
K-BB0Z-3624-R	618	29.5	36	24	1.94	42.75
K-BB0Z-4224-R	683	29.5	42	24	2.24	52.88
K-BB0Z-4824-R	770	29.5	48	24	2.53	63.01
K-BB0Z-3630-L	638	29.5	36	30	2.36	51.13
K-BB0Z-4230-L	703	29.5	42	30	2.72	62.66
K-BB0Z-4830-L	790	29.5	48	30	3.07	74.19
K-BB0Z-3630-R	638	29.5	36	30	2.36	51.13
K-BB0Z-4230-R	703	29.5	42	30	2.72	62.66
K-BB0Z-4830-R	790	29.5	48	30	3.07	74.19

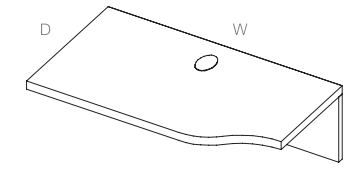

Bowed Bridge Partial Modesty, 1" Thick Surface

This bridge must be connected to two freestanding desks or credenza. Corners and unitized desks with matching depths can also be connected on either side. Partial modesty gives access to electrical outlets when installed against walls.

**Ordering Options:**

Use the following checklist to customize the finishes on your order:

- laminate
- trim color
- grommet color

Each laminate comes with matching vinyl trim color unless otherwise specified on your purchase order. Refer to the laminate finish card for our current offering.

**Details:**

Partial modesty height 12 inches.

Grommets are available in black or silver. Black is the standard grommet option unless otherwise specified on your purchase order.

Code	Price	H	W	D	Volume (ft <sup>3</sup> )	Weight (lb)
KL-BB0Z-3624-L	580	29	36	24	1.94	30.29
KL-BB0Z-3624-R	580	29	36	24	1.94	30.29
KL-BB0Z-3630-L	603	29	36	30	2.36	38.16
KL-BB0Z-3630-R	603	29	36	30	2.36	38.16
KL-BB0Z-4224-L	641	29	42	24	2.24	38.54
KL-BB0Z-4224-R	641	29	42	24	2.24	38.54
KL-BB0Z-4230-L	665	29	42	30	2.72	47.36
KL-BB0Z-4230-R	665	29	42	30	2.72	47.36
KL-BB0Z-4824-L	725	29	48	24	2.53	46.79
KL-BB0Z-4824-R	725	29	48	24	2.53	46.79
KL-BB0Z-4830-L	744	29	48	30	3.07	56.56
KL-BB0Z-4830-R	744	29	48	30	3.07	56.56



Metro Collab  
August 2024  
**Returns**

returns

Executive

straight return	
full modesty	82
partial modesty	86
notched return	
full modesty	90
partial modesty	94
bowed return	
full modesty	98
partial modesty	102

Professional

straight return	
full modesty	84
partial modesty	88
notched return	
full modesty	92
partial modesty	96
bowed return	
full modesty	100
partial modesty	104

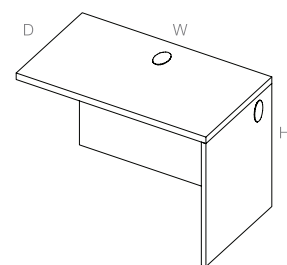

This return is semi-supported, it must be connected to a freestanding desk, corner desk or credenza. Allows for fixed and modular underdesk storage (right hand shown).

Straight Return Full Modesty, 1.5" Thick Surface

**Ordering Options:**

Use the following checklist to customize the finishes on your order:

- laminate
- trim color
- edge profile
- grommet color

Each laminate comes with matching vinyl trim color unless otherwise specified on your purchase order. Refer to the laminate finish card for our current offering.

**Details:**

Grommets are available in black or silver. Black is the standard grommet option unless otherwise specified on your purchase order.

Surfaces up to and including 48" wide have one grommet located at the back center of the surface. Surfaces 54" wide and greater have two grommets at either side of the back of the surface.

All gables include grommets.

Code	Price	H	W	D	Volume (ft <sup>3</sup> )	Weight (lb)
K-WS1G-2421-L	736	29.5	24	21	1.62	51.3
K-WS1G-2421-R	736	29.5	24	21	1.62	51.3
K-WS1G-2424-L	745	29.5	24	24	1.81	56.65
K-WS1G-2424-R	745	29.5	24	24	1.81	56.65
K-WS1G-2430-L	811	29.5	24	30	2.2	66.42
K-WS1G-2430-R	811	29.5	24	30	2.2	66.42
K-WS1G-3021-L	745	29.5	30	21	1.97	60.74
K-WS1G-3021-R	745	29.5	30	21	1.97	60.74
K-WS1G-3024-L	756	29.5	30	24	2.2	65.92
K-WS1G-3024-R	756	29.5	30	24	2.2	65.92
K-WS1G-3030-L	831	29.5	30	30	2.68	77.42
K-WS1G-3030-R	831	29.5	30	30	2.68	77.42

Code	Price	H	W	D	Volume (ft <sup>3</sup> )	Weight (lb)
K-WS1G-3621-L	756	29.5	36	21	2.31	70.18
K-WS1G-3621-R	756	29.5	36	21	2.31	70.18
K-WS1G-3624-L	770	29.5	36	24	2.59	75.19
K-WS1G-3624-R	770	29.5	36	24	2.59	75.19
K-WS1G-3630-L	862	29.5	36	30	3.15	88.42
K-WS1G-3630-R	862	29.5	36	30	3.15	88.42
K-WS1G-4221-L	770	29.5	42	21	2.66	79.62
K-WS1G-4221-R	770	29.5	42	21	2.66	79.62
K-WS1G-4224-L	790	29.5	42	24	2.98	84.46
K-WS1G-4224-R	790	29.5	42	24	2.98	84.46
K-WS1G-4230-L	897	29.5	42	30	3.62	99.42
K-WS1G-4230-R	897	29.5	42	30	3.62	99.42
K-WS1G-4821-L	811	29.5	48	21	3.01	89.06
K-WS1G-4821-R	811	29.5	48	21	3.01	89.06
K-WS1G-4824-L	831	29.5	48	24	3.37	93.73
K-WS1G-4824-R	831	29.5	48	24	3.37	93.73
K-WS1G-4830-L	925	29.5	48	30	4.09	110.42
K-WS1G-4830-R	925	29.5	48	30	4.09	110.42
K-WS1G-5421-L	851	29.5	54	21	3.36	98.5
K-WS1G-5421-R	851	29.5	54	21	3.36	98.5
K-WS1G-5424-L	872	29.5	54	24	3.76	103
K-WS1G-5424-R	872	29.5	54	24	3.76	103
K-WS1G-5430-L	957	29.5	54	30	4.56	121.42
K-WS1G-5430-R	957	29.5	54	30	4.56	121.42
K-WS1G-6021-L	897	29.5	60	21	3.7	107.94
K-WS1G-6021-R	897	29.5	60	21	3.7	107.94
K-WS1G-6024-L	918	29.5	60	24	4.15	112.27
K-WS1G-6024-R	918	29.5	60	24	4.15	112.27
K-WS1G-6030-L	1011	29.5	60	30	5.04	132.42
K-WS1G-6030-R	1011	29.5	60	30	5.04	132.42

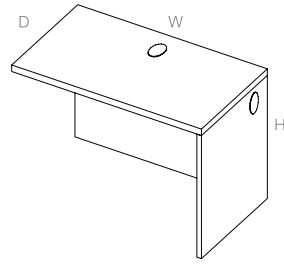

This return is semi-supported, it must be connected to a freestanding desk, corner desk or credenza. Allows for fixed and modular underdesk storage (right hand shown).

Straight Return Full Modesty, 1" Thick Surface

**Ordering Options:**

Use the following checklist to customize the finishes on your order:

- laminate
- trim color
- grommet color

Each laminate comes with matching vinyl trim color unless otherwise specified on your purchase order. Refer to the laminate finish card for our current offering.

**Details:**

Grommets are available in black or silver. Black is the standard grommet option unless otherwise specified on your purchase order.

Surfaces up to and including 48" wide have one grommet located at the back center of the surface. Surfaces 54" wide and greater have two grommets at either side of the back of the surface.

All gables include grommets.

Code	Price	H	W	D	Volume (ft <sup>3</sup> )	Weight (lb)
KL-WS1G-3621-L	625	29	36	21	2.31	59.8
KL-WS1G-3621-R	625	29	36	21	2.31	59.8
KL-WS1G-3624-L	633	29	36	24	2.59	64.35
KL-WS1G-3624-R	633	29	36	24	2.59	64.35
KL-WS1G-3630-L	730	29	36	30	3.15	74.76
KL-WS1G-3630-R	730	29	36	30	3.15	74.76
KL-WS1G-4221-L	633	29	42	21	2.66	67.2
KL-WS1G-4221-R	633	29	42	21	2.66	67.2
KL-WS1G-4224-L	655	29	42	24	2.98	72.15
KL-WS1G-4224-R	655	29	42	24	2.98	72.15
KL-WS1G-4230-L	759	29	42	30	3.62	83.79
KL-WS1G-4230-R	759	29	42	30	3.62	83.79

Code	Price	H	W	D	Volume (ft <sup>3</sup> )	Weight (lb)
KL-WS1G-4821-L	676	29	48	21	3.01	74.6
KL-WS1G-4821-R	676	29	48	21	3.01	74.6
KL-WS1G-4824-L	696	29	48	24	3.37	79.95
KL-WS1G-4824-R	696	29	48	24	3.37	79.95
KL-WS1G-4830-L	793	29	48	30	4.09	92.82
KL-WS1G-4830-R	793	29	48	30	4.09	92.82
KL-WS1G-5421-L	719	29	54	21	3.36	82
KL-WS1G-5421-R	719	29	54	21	3.36	82
KL-WS1G-5424-L	741	29	54	24	3.76	87.75
KL-WS1G-5424-R	741	29	54	24	3.76	87.75
KL-WS1G-5430-L	828	29	54	30	4.56	101.85
KL-WS1G-5430-R	828	29	54	30	4.56	101.85
KL-WS1G-6021-L	759	29	60	21	3.7	89.4
KL-WS1G-6021-R	759	29	60	21	3.7	89.4
KL-WS1G-6024-L	783	29	60	24	4.15	95.55
KL-WS1G-6024-R	783	29	60	24	4.15	95.55
KL-WS1G-6030-L	881	29	60	30	5.04	110.88
KL-WS1G-6030-R	881	29	60	30	5.04	110.88
KL-WS1Z-1824-L	614	29	18	24	0	30
K-WS1G-5421-R	851	29.5	54	21	3.36	98.5
K-WS1G-5424-L	872	29.5	54	24	3.76	103
K-WS1G-5424-R	872	29.5	54	24	3.76	103
K-WS1G-5430-L	957	29.5	54	30	4.56	121.42
K-WS1G-5430-R	957	29.5	54	30	4.56	121.42
K-WS1G-6021-L	897	29.5	60	21	3.7	107.94
K-WS1G-6021-R	897	29.5	60	21	3.7	107.94
K-WS1G-6024-L	918	29.5	60	24	4.15	112.27
K-WS1G-6024-R	918	29.5	60	24	4.15	112.27
K-WS1G-6030-L	1011	29.5	60	30	5.04	132.42
K-WS1G-6030-R	1011	29.5	60	30	5.04	132.42



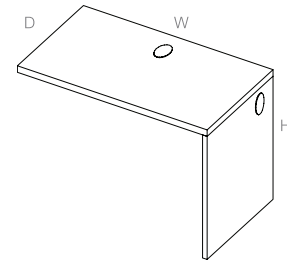

This return is semi-supported, it must be connected to a freestanding desk, corner desk or credenza. Allows for fixed and modular underdesk storage. Partial modesty gives access to electrical outlets when installed against walls (right hand shown).

Straight Return Partial Modesty, 1.5" Thick Surface

**Ordering Options:**

Use the following checklist to customize the finishes on your order:

- laminate
- trim color
- edge profile
- grommet color

Each laminate comes with matching vinyl trim color unless otherwise specified on your purchase order. Refer to the laminate finish card for our current offering.

**Details:**

Grommets are available in black or silver. Black is the standard grommet option unless otherwise specified on your purchase order.

Surfaces up to and including 48" wide have one grommet located at the back center of the surface. Surfaces 54" wide and greater have two grommets at either side of the back of the surface.

All gables include grommets.

Code	Price	H	W	D	Volume (ft <sup>3</sup> )	Weight (lb)
K-WS1Z-2421-L	736	29.5	24	21	1.62	41.4
K-WS1Z-2421-R	736	29.5	24	21	1.62	41.4
K-WS1Z-2424-L	745	29.5	24	24	1.81	46.35
K-WS1Z-2424-R	745	29.5	24	24	1.81	46.35
K-WS1Z-2430-L	811	29.5	24	30	2.2	58.5
K-WS1Z-2430-R	811	29.5	24	30	2.2	58.5
K-WS1Z-3021-L	745	29.5	30	21	1.97	48.66
K-WS1Z-3021-R	745	29.5	30	21	1.97	48.66
K-WS1Z-3024-L	756	29.5	30	24	2.2	55.62
K-WS1Z-3024-R	756	29.5	30	24	2.2	55.62
K-WS1Z-3030-L	831	29.5	30	30	2.68	69.5
K-WS1Z-3030-R	831	29.5	30	30	2.68	69.5

Code	Price	H	W	D	Volume (ft <sup>3</sup> )	Weight (lb)
K-WS1Z-3621-L	756	29.5	36	21	2.31	58.1
K-WS1Z-3621-R	756	29.5	36	21	2.31	58.1
K-WS1Z-3624-L	770	29.5	36	24	2.59	64.89
K-WS1Z-3624-R	770	29.5	36	24	2.59	64.89
K-WS1Z-3630-L	862	29.5	36	30	3.15	80.5
K-WS1Z-3630-R	862	29.5	36	30	3.15	80.5
K-WS1Z-4221-L	770	29.5	42	21	2.66	67.54
K-WS1Z-4221-R	770	29.5	42	21	2.66	67.54
K-WS1Z-4224-L	790	29.5	42	24	2.98	74.16
K-WS1Z-4224-R	790	29.5	42	24	2.98	74.16
K-WS1Z-4230-L	897	29.5	42	30	3.62	91.5
K-WS1Z-4230-R	897	29.5	42	30	3.62	91.5
K-WS1Z-4821-L	811	29.5	48	21	3.01	76.98
K-WS1Z-4821-R	811	29.5	48	21	3.01	76.98
K-WS1Z-4824-L	831	29.5	48	24	3.37	83.43
K-WS1Z-4824-R	831	29.5	48	24	3.37	83.43
K-WS1Z-4830-L	925	29.5	48	30	4.09	102.5
K-WS1Z-4830-R	925	29.5	48	30	4.09	102.5
K-WS1Z-5421-L	851	29.5	54	21	3.36	86.42
K-WS1Z-5421-R	851	29.5	54	21	3.36	86.42
K-WS1Z-5424-L	872	29.5	54	24	3.76	92.7
K-WS1Z-5424-R	872	29.5	54	24	3.76	92.7
K-WS1Z-5430-L	957	29.5	54	30	4.56	113.5
K-WS1Z-5430-R	957	29.5	54	30	4.56	113.5
K-WS1Z-6021-L	897	29.5	60	21	3.7	95.86
K-WS1Z-6021-R	897	29.5	60	21	3.7	95.86
K-WS1Z-6024-L	918	29.5	60	24	4.15	101.97
K-WS1Z-6024-R	918	29.5	60	24	4.15	101.97
K-WS1Z-6030-L	1011	29.5	60	30	5.04	124.5
K-WS1Z-6030-R	1011	29.5	60	30	5.04	124.5



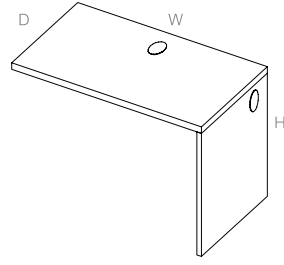

This return is semi-supported, it must be connected to a freestanding desk, corner desk or credenza. Allows for fixed and modular underdesk storage. Partial modesty gives access to electrical outlets when installed against walls

(right hand shown).

Straight Return Partial Modesty,  
1" Thick Surface

**Ordering Options:**

Use the following checklist to customize the finishes on your order:

- laminate
- trim color
- grommet color

Each laminate comes with matching vinyl trim color unless otherwise specified on your purchase order. Refer to the laminate finish card for our current offering.

**Details:**

Grommets are available in black or silver. Black is the standard grommet option unless otherwise specified on your purchase order.

Surfaces up to and including 48" wide have one grommet located at the back center of the surface. Surfaces 54" wide and greater have two grommets at either side of the back of the surface.

All gables include grommets.

Code	Price	H	W	D	Volume (ft <sup>3</sup> )	Weight (lb)
KL-WS1Z-1824-R	614	29	18	24	0	35.5
KL-WS1Z-2424-R-UW	614	29	24	24	0	36.9
KL-WS1Z-3024-R-UW	625	29	30	24	2.2	44.7
KL-WS1Z-3624-R-UW	637	29	36	24	2.59	52.5
KL-WS1Z-3636-L	832	29	36	36	0	75
KL-WS1Z-4024-R	655	29	40	24	0	60
KL-WS1Z-4221-L-UW	637	29	42	21	2.66	57.3
KL-WS1Z-4221-R-UW	637	29	42	21	2.66	57.3
KL-WS1Z-4224-L-UW	655	29	42	24	2.98	60.3
KL-WS1Z-4224-R-UW	655	29	42	24	2.98	60.3

Code	Price	H	W	D	Volume (ft <sup>3</sup> )	Weight (lb)
KL-WS1Z-4230-L-UW	760	29	42	30	3.62	76.44
KL-WS1Z-4230-R-UW	760	29	42	30	3.62	76.44
KL-WS1Z-4818-L	676	29	48	18	0	58
KL-WS1Z-4818-R	676	29	48	18	0	58
KL-WS1Z-4821-L-UW	676	29	48	21	3.01	64.7
KL-WS1Z-4821-R-UW	676	29	48	21	3.01	64.7
KL-WS1Z-4824-L-UW	697	29	48	24	3.37	68.1
KL-WS1Z-4824-R-UW	697	29	48	24	3.37	68.1
KL-WS1Z-4830-L-UW	794	29	48	30	4.09	85.47
KL-WS1Z-4830-R-UW	794	29	48	30	4.09	85.47
KL-WS1Z-5424-L-UW	741	29	54	24	3.76	75.9
KL-WS1Z-5424-R-UW	741	29	54	24	3.76	75.9
KL-WS1Z-5430-L-UW	828	29	54	30	4.56	94.5
KL-WS1Z-5430-R-UW	828	29	54	30	4.56	94.5
KL-WS1Z-6024-L-UW	784	29	60	24	4.15	83.7
KL-WS1Z-6024-R-UW	784	29	60	24	4.15	83.7
KL-WS1Z-6030-L-UW	882	29	60	30	5.04	103.53
KL-WS1Z-6030-R-UW	882	29	60	30	0	103.53
KL-WS1Z-6621-L	879	29	66	21	0	80
KL-WS1Z-6621-R	879	29	66	21	0	80
KL-WS1Z-6624-L	879	29	66	24	0	83.7
KL-WS1Z-6624-L-UW	879	29	66	24	0	83.7
KL-WS1Z-6624-R	879	29	66	24	0	83.7
KL-WS1Z-6624-R-UW	879	29	66	24	0	83.7
KL-WS1Z-6630-L	1060	29	66	30	0	83.7
KL-WS1Z-6630-R	1060	29	66	30	0	83.7

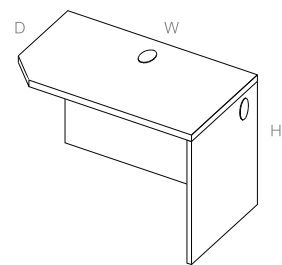

This return is semi-supported, it must be connected to a freestanding desk, corner desk or credenza. Allows for fixed and modular underdesk storage. Works with Straight Front Corners (right hand shown).

Notched Return Full Modesty, 1.5" Thick Surface

**Ordering Options:**

Use the following checklist to customize the finishes on your order:

- laminate
- trim color
- edge profile
- grommet color

Each laminate comes with matching vinyl trim color unless otherwise specified on your purchase order. Refer to the laminate finish card for our current offering.

**Details:**

Grommets are available in black or silver. Black is the standard grommet option unless otherwise specified on your purchase order.

Surfaces up to and including 48" wide have one grommet located at the back center of the surface. Surfaces 54" wide and greater have two grommets at either side of the back of the surface.

All gables include grommets.

Code	Price	H	W	D	Volume (ft <sup>3</sup> )	Weight (lb)
K-WN0G-2424-L	756	29.5	24	24	1.81	55.75
K-WN0G-2424-R	756	29.5	24	24	1.81	55.75
K-WN0G-2430-L	906	29.5	24	30	2.2	65.52
K-WN0G-2430-R	906	29.5	24	30	2.2	65.52
K-WN0G-3024-L	797	29.5	30	24	2.2	65.22
K-WN0G-3024-R	797	29.5	30	24	2.2	65.22
K-WN0G-3030-L	936	29.5	30	30	2.68	76.75
K-WN0G-3030-R	936	29.5	30	30	2.68	76.75
K-WN0G-3624-L	843	29.5	36	24	2.59	74.69
K-WN0G-3624-R	843	29.5	36	24	2.59	74.69
K-WN0G-3630-L	1001	29.5	36	30	3.15	87.98
K-WN0G-3630-R	1001	29.5	36	30	3.15	87.98
K-WN0G-4224-L	883	29.5	42	24	2.98	84.16
K-WN0G-4224-R	883	29.5	42	24	2.98	84.16
K-WN0G-4230-L	1041	29.5	42	30	3.62	99.21
K-WN0G-4230-R	1041	29.5	42	30	3.62	99.21
K-WN0G-4824-L	925	29.5	48	24	3.37	93.63
K-WN0G-4824-R	925	29.5	48	24	3.37	93.63
K-WN0G-4830-L	1108	29.5	48	30	4.09	110.44
K-WN0G-4830-R	1108	29.5	48	30	4.09	110.44
K-WN0G-5424-L	957	29.5	54	24	3.76	103.1
K-WN0G-5424-R	957	29.5	54	24	3.76	103.1
K-WN0G-5430-L	1146	29.5	54	30	4.56	121.67
K-WN0G-5430-R	1146	29.5	54	30	4.56	121.67
K-WN0G-6024-L	982	29.5	60	24	4.15	112.57
K-WN0G-6024-R	982	29.5	60	24	4.15	112.57
K-WN0G-6030-L	1181	29.5	60	30	5.04	132.9
K-WN0G-6030-R	1181	29.5	60	30	5.04	132.9

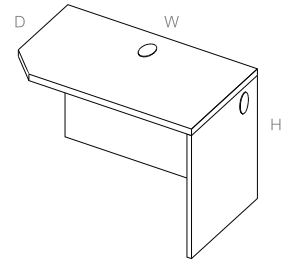

This return is semi-supported, it must be connected to a freestanding desk, corner desk or credenza. Allows for fixed and modular underdesk storage. Works with Straight Front Corners (right hand shown).

Notched Return Full Modesty, 1" Thick Surface

**Ordering Options:**

Use the following checklist to customize the finishes on your order:

- laminate
- trim color
- grommet color

Each laminate comes with matching vinyl trim color unless otherwise specified on your purchase order. Refer to the laminate finish card for our current offering.

**Details:**

Grommets are available in black or silver. Black is the standard grommet option unless otherwise specified on your purchase order.

Surfaces up to and including 48" wide have one grommet located at the back center of the surface. Surfaces 54" wide and greater have two grommets at either side of the back of the surface.

All gables include grommets.

Code	Price	H	W	D	Volume (ft <sup>3</sup> )	Weight (lb)
KL-WN0G-2424-L	714	29	24	24	1.81	48.28
KL-WN0G-2424-R	714	29	24	24	1.81	48.28
KL-WN0G-2430-L	855	29	24	30	2.2	56.08
KL-WN0G-2430-R	855	29	24	30	2.2	56.08
KL-WN0G-3024-L	754	29	30	24	2.2	56.08
KL-WN0G-3024-R	754	29	30	24	2.2	56.08
KL-WN0G-3030-L	883	29	30	30	2.68	63.88
KL-WN0G-3030-R	883	29	30	30	2.68	63.88
KL-WN0G-3624-L	793	29	36	24	2.59	63.88
KL-WN0G-3624-R	793	29	36	24	2.59	63.88
KL-WN0G-3630-L	946	29	36	30	3.15	71.68
KL-WN0G-3630-R	946	29	36	30	3.15	71.68
KL-WN0G-4224-L	834	29	42	24	2.98	71.68
KL-WN0G-4224-R	834	29	42	24	2.98	71.68
KL-WN0G-4230-L	986	29	42	30	3.62	79.48
KL-WN0G-4230-R	986	29	42	30	3.62	79.48
KL-WN0G-4824-L	872	29	48	24	3.37	79.48
KL-WN0G-4824-R	872	29	48	24	3.37	79.48
KL-WN0G-4830-L	1042	29	48	30	4.09	87.28
KL-WN0G-4830-R	1042	29	48	30	4.09	87.28
KL-WN0G-5424-L	905	29	54	24	3.76	87.28
KL-WN0G-5424-R	905	29	54	24	3.76	87.28
KL-WN0G-5430-L	1082	29	54	30	4.56	95.08
KL-WN0G-5430-R	1082	29	54	30	4.56	95.08
KL-WN0G-6024-L	924	29	60	24	4.15	95.08
KL-WN0G-6024-R	924	29	60	24	4.15	95.08
KL-WN0G-6030-L	1115	29	60	30	5.04	102.88
KL-WN0G-6030-R	1115	29	60	30	5.04	102.88

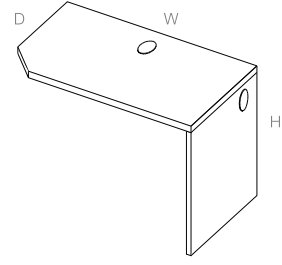

This return is semi-supported, it must be connected to a freestanding desk, corner desk or credenza. Allows for fixed and modular underdesk storage. Partial modesty gives access to electrical outlets when installed against walls

Works with Straight Front Corners (right hand shown).

Notched Return Partial Modesty, 1.5" Thick Surface

**Ordering Options:**

Use the following checklist to customize the finishes on your order:

- laminate
- trim color
- edge profile
- grommet color

Each laminate comes with matching vinyl trim color unless otherwise specified on your purchase order. Refer to the laminate finish card for our current offering.

**Details:**

Grommets are available in black or silver. Black is the standard grommet option unless otherwise specified on your purchase order.

Surfaces up to and including 48" wide have one grommet located at the back center of the surface. Surfaces 54" wide and greater have two grommets at either side of the back of the surface.

All gables include grommets.

Code	Price	H	W	D	Volume (ft <sup>3</sup> )	Weight (lb)
K-WN0Z-2424-L	756	29.5	24	24	1.81	45.45
K-WN0Z-2424-R	756	29.5	24	24	1.81	45.45
K-WN0Z-2430-L	906	29.5	24	30	2.2	55.35
K-WN0Z-2430-R	906	29.5	24	30	2.2	55.35
K-WN0Z-3024-L	797	29.5	30	24	2.2	54.92
K-WN0Z-3024-R	797	29.5	30	24	2.2	54.92
K-WN0Z-3030-L	936	29.5	30	30	2.68	66.58
K-WN0Z-3030-R	936	29.5	30	30	2.68	66.58
K-WN0Z-3624-L	843	29.5	36	24	2.59	64.39
K-WN0Z-3624-R	843	29.5	36	24	2.59	64.39
K-WN0Z-3630-L	1001	29.5	36	30	3.15	77.81
K-WN0Z-3630-R	1001	29.5	36	30	3.15	77.81
K-WN0Z-4224-L	883	29.5	42	24	2.98	73.86
K-WN0Z-4224-R	883	29.5	42	24	2.98	73.86
K-WN0Z-4230-L	1041	29.5	42	30	3.62	89.04
K-WN0Z-4230-R	1041	29.5	42	30	3.62	89.04
K-WN0Z-4824-L	925	29.5	48	24	3.37	83.33
K-WN0Z-4824-R	925	29.5	48	24	3.37	83.33
K-WN0Z-4830-L	1108	29.5	48	30	4.09	100.27
K-WN0Z-4830-R	1108	29.5	48	30	4.09	100.27
K-WN0Z-5424-L	957	29.5	54	24	3.76	92.8
K-WN0Z-5424-R	957	29.5	54	24	3.76	92.8
K-WN0Z-5430-L	1146	29.5	54	30	4.56	111.5
K-WN0Z-5430-R	1146	29.5	54	30	4.56	111.5
K-WN0Z-6024-L	982	29.5	60	24	4.15	102.27
K-WN0Z-6024-R	982	29.5	60	24	4.15	102.27
K-WN0Z-6030-L	1181	29.5	60	30	5.04	122.73
K-WN0Z-6030-R	1181	29.5	60	30	5.04	122.73

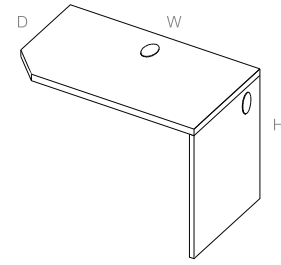

This return is semi-supported, it must be connected to a freestanding desk, corner desk or credenza. Allows for fixed and modular underdesk storage. Partial modesty gives access to electrical outlets when installed against walls

Works with Straight Front Corners (right hand shown).

Notched Return Partial Modesty, 1" Thick Surface

**Ordering Options:**

Use the following checklist to customize the finishes on your order:

- laminate
- trim color
- grommet color

Each laminate comes with matching vinyl trim color unless otherwise specified on your purchase order. Refer to the laminate finish card for our current offering.

**Details:**

Grommets are available in black or silver. Black is the standard grommet option unless otherwise specified on your purchase order.

Surfaces up to and including 48" wide have one grommet located at the back center of the surface. Surfaces 54" wide and greater have two grommets at either side of the back of the surface.

All gables include grommets.

Code	Price	H	W	D	Volume (ft <sup>3</sup> )	Weight (lb)
KL-WN0Z-2424-L	714	29	24	24	1.81	38.25
KL-WN0Z-2424-R	714	29	24	24	1.81	38.25
KL-WN0Z-2430-L	855	29	24	30	2.2	51.81
KL-WN0Z-2430-R	855	29	24	30	2.2	51.81
KL-WN0Z-3024-L	754	29	30	24	2.2	46.05
KL-WN0Z-3024-R	754	29	30	24	2.2	46.05
KL-WN0Z-3030-L	883	29	30	30	2.68	59.61
KL-WN0Z-3030-R	883	29	30	30	2.68	59.61
KL-WN0Z-3624-L	793	29	36	24	2.59	53.85
KL-WN0Z-3624-R	793	29	36	24	2.59	53.85
KL-WN0Z-3630-L	946	29	36	30	3.15	67.41
KL-WN0Z-3630-R	946	29	36	30	3.15	67.41
KL-WN0Z-4224-L	834	29	42	24	2.98	61.65
KL-WN0Z-4224-R	834	29	42	24	2.98	61.65
KL-WN0Z-4230-L	986	29	42	30	3.62	75.21
KL-WN0Z-4230-R	986	29	42	30	3.62	75.21
KL-WN0Z-4824-L	872	29	48	24	3.37	69.45
KL-WN0Z-4824-R	872	29	48	24	3.37	69.45
KL-WN0Z-4830-L	1042	29	48	30	4.09	56.53
KL-WN0Z-4830-R	1042	29	48	30	4.09	56.53
KL-WN0Z-5424-L	905	29	54	24	3.76	77.25
KL-WN0Z-5424-R	905	29	54	24	3.76	77.25
KL-WN0Z-5430-L	1082	29	54	30	4.56	65.26
KL-WN0Z-5430-R	1082	29	54	30	4.56	65.26
KL-WN0Z-6024-L	924	29	60	24	4.15	85.05
KL-WN0Z-6024-R	924	29	60	24	4.15	85.05
KL-WN0Z-6030-L	1115	29	60	30	5.04	73.99
KL-WN0Z-6030-R	1115	29	60	30	5.04	73.99

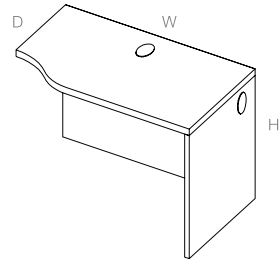

This return is semi-supported, it must be connected to a freestanding desk, corner desk or credenza. Allows for fixed and modular underdesk storage. Works with Curved Front Corners (right hand shown).

Bowed Return Full Modesty, 1.5" Thick Surface

**Ordering Options:**

Use the following checklist to customize the finishes on your order:

- laminate
- trim color
- edge profile
- grommet color

Each laminate comes with matching vinyl trim color unless otherwise specified on your purchase order. Refer to the laminate finish card for our current offering.

**Details:**

Grommets are available in black or silver. Black is the standard grommet option unless otherwise specified on your purchase order.

Surfaces up to and including 48" wide have one grommet located at the back center of the surface. Surfaces 54" wide and greater have two grommets at either side of the back of the surface.

All gables include grommets.

Code	Price	H	W	D	Volume (ft <sup>3</sup> )	Weight (lb)
K-WB0G-2424-L	756	29.5	24	24	1.81	54.43
K-WB0G-2424-R	756	29.5	24	24	1.81	54.43
K-WB0G-2430-L	906	29.5	24	30	2.2	64.35
K-WB0G-2430-R	906	29.5	24	30	2.2	64.35
K-WB0G-3024-L	797	29.5	30	24	2.2	64.11
K-WB0G-3024-R	797	29.5	30	24	2.2	64.11
K-WB0G-3030-L	936	29.5	30	30	2.68	71.14
K-WB0G-3030-R	936	29.5	30	30	2.68	71.14
K-WB0G-3624-L	843	29.5	36	24	2.59	73.79
K-WB0G-3624-R	843	29.5	36	24	2.59	73.79
K-WB0G-3630-L	1001	29.5	36	30	3.15	77.93
K-WB0G-3630-R	1001	29.5	36	30	3.15	77.93
K-WB0G-4224-L	883	29.5	42	24	2.98	83.47
K-WB0G-4224-R	883	29.5	42	24	2.98	83.47
K-WB0G-4230-L	1041	29.5	42	30	3.62	84.72
K-WB0G-4230-R	1041	29.5	42	30	3.62	84.72
K-WB0G-4824-L	925	29.5	48	24	3.37	93.15
K-WB0G-4824-R	925	29.5	48	24	3.37	93.15
K-WB0G-4830-L	1108	29.5	48	30	4.09	91.51
K-WB0G-4830-R	1108	29.5	48	30	4.09	91.51
K-WB0G-5424-L	957	29.5	54	24	3.76	102.83
K-WB0G-5424-R	957	29.5	54	24	3.76	102.83
K-WB0G-5430-L	1146	29.5	54	30	4.56	98.3
K-WB0G-5430-R	1146	29.5	54	30	4.56	98.3
K-WB0G-6024-L	982	29.5	60	24	4.15	112.51
K-WB0G-6024-R	982	29.5	60	24	4.15	112.51
K-WB0G-6030-L	1181	29.5	60	30	5.04	105.09
K-WB0G-6030-R	1181	29.5	60	30	5.04	105.09



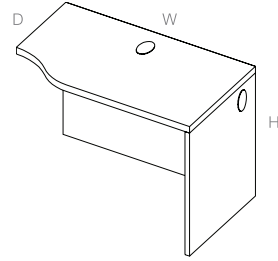

This return is semi-supported, it must be connected to a freestanding desk, corner desk or credenza. Allows for fixed and modular underdesk storage. Works with Curved Front Corners (right hand shown).

Bowed Return Full Modesty, 1" Thick Surface

**Ordering Options:**

Use the following checklist to customize the finishes on your order:

- laminate
- trim color
- grommet color

Each laminate comes with matching vinyl trim color unless otherwise specified on your purchase order. Refer to the laminate finish card for our current offering.

**Details:**

Grommets are available in black or silver. Black is the standard grommet option unless otherwise specified on your purchase order.

Surfaces up to and including 48" wide have one grommet located at the back center of the surface. Surfaces 54" wide and greater have two grommets at either side of the back of the surface.

All gables include grommets.

Code	Price	H	W	D	Volume (ft <sup>3</sup> )	Weight (lb)
KL-WB0G-2424-L	714	29	24	24	1.81	47.54
KL-WB0G-2424-R	714	29	24	24	1.81	47.54
KL-WB0G-2430-L	855	29	24	30	2.2	55.79
KL-WB0G-2430-R	855	29	24	30	2.2	55.79
KL-WB0G-3024-L	754	29	30	24	2.2	55.34
KL-WB0G-3024-R	754	29	30	24	2.2	55.34
KL-WB0G-3030-L	883	29	30	30	2.68	64.09
KL-WB0G-3030-R	883	29	30	30	2.68	64.09
KL-WB0G-3624-L	793	29	36	24	2.59	63.14
KL-WB0G-3624-R	793	29	36	24	2.59	63.14
KL-WB0G-3630-L	946	29	36	30	3.15	72.39
KL-WB0G-3630-R	946	29	36	30	3.15	72.39
KL-WB0G-4224-L	834	29	42	24	2.98	70.94
KL-WB0G-4224-R	834	29	42	24	2.98	70.94
KL-WB0G-4230-L	986	29	42	30	3.62	80.69
KL-WB0G-4230-R	986	29	42	30	3.62	80.69
KL-WB0G-4824-L	872	29	48	24	3.37	78.74
KL-WB0G-4824-R	872	29	48	24	3.37	78.74
KL-WB0G-4830-L	1042	29	48	30	4.09	88.99
KL-WB0G-4830-R	1042	29	48	30	4.09	88.99
KL-WB0G-5424-L	905	29	54	24	3.76	86.54
KL-WB0G-5424-R	905	29	54	24	3.76	86.54
KL-WB0G-5430-L	1082	29	54	30	4.56	97.29
KL-WB0G-5430-R	1082	29	54	30	4.56	97.29
KL-WB0G-6024-L	924	29	60	24	4.15	94.34
KL-WB0G-6024-R	924	29	60	24	4.15	94.34
KL-WB0G-6030-L	1115	29	60	30	5.04	105.59
KL-WB0G-6030-R	1115	29	60	30	5.04	105.59

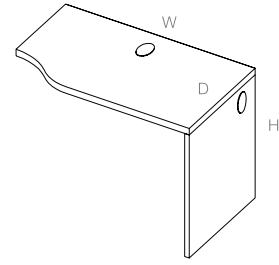

Bowed Return Partial Modesty, 1.5" Thick Surface

This return is semi-supported, it must be connected to a freestanding desk, corner desk or credenza. Allows for fixed and modular underdesk storage. Partial modesty gives access to electrical outlets when planned against walls

Works with Curved Front Corners (right hand shown).

**Ordering Options:**

Use the following checklist to customize the finishes on your order:

- laminate
- trim color
- edge profile
- grommet color

Each laminate comes with matching vinyl trim color unless otherwise specified on your purchase order. Refer to the laminate finish card for our current offering.

**Details:**

Grommets are available in black or silver. Black is the standard grommet option unless otherwise specified on your purchase order.

Surfaces up to and including 48" wide have one grommet located at the back center of the surface. Surfaces 54" wide and greater have two grommets at either side of the back of the surface.

All gables include grommets.

Code	Price	H	W	D	Volume (ft <sup>3</sup> )	Weight (lb)
K-WB0Z-2424-L	756	29.5	24	24	1.81	44.1
K-WB0Z-2424-R	756	29.5	24	24	1.81	44.1
K-WB0Z-2430-L	906	29.5	24	30	2.2	54.45
K-WB0Z-2430-R	906	29.5	24	30	2.2	54.45
K-WB0Z-3024-L	797	29.5	30	24	2.2	53.78
K-WB0Z-3024-R	797	29.5	30	24	2.2	53.78
K-WB0Z-3030-L	936	29.5	30	30	2.68	61.24
K-WB0Z-3030-R	936	29.5	30	30	2.68	61.24
K-WB0Z-3624-L	843	29.5	36	24	2.59	63.46
K-WB0Z-3624-R	843	29.5	36	24	2.59	63.46
K-WB0Z-3630-L	1001	29.5	36	30	3.15	68.03
K-WB0Z-3630-R	1001	29.5	36	30	3.15	68.03
K-WB0Z-4224-L	883	29.5	42	24	2.98	73.14
K-WB0Z-4224-R	883	29.5	42	24	2.98	73.14
K-WB0Z-4230-L	1041	29.5	42	30	3.62	74.82
K-WB0Z-4230-R	1041	29.5	42	30	3.62	74.82
K-WB0Z-4824-L	925	29.5	48	24	3.37	82.82
K-WB0Z-4824-R	925	29.5	48	24	3.37	82.82
K-WB0Z-4830-L	1108	29.5	48	30	4.09	81.61
K-WB0Z-4830-R	1108	29.5	48	30	4.09	81.61
K-WB0Z-5424-L	957	29.5	54	24	3.76	92.5
K-WB0Z-5424-R	957	29.5	54	24	3.76	92.5
K-WB0Z-5430-L	1146	29.5	54	30	4.56	88.4
K-WB0Z-5430-R	1146	29.5	54	30	4.56	88.4
K-WB0Z-6024-L	982	29.5	60	24	4.15	102.18
K-WB0Z-6024-R	982	29.5	60	24	4.15	102.18
K-WB0Z-6030-L	1181	29.5	60	30	5.04	95.19
K-WB0Z-6030-R	1181	29.5	60	30	5.04	95.19



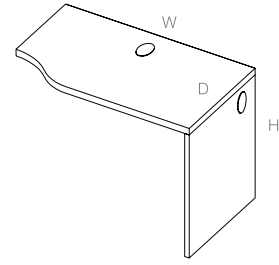

Bowed Return Partial Modesty, 1.5" Thick Surface

This return is semi-supported, it must be connected to a freestanding desk, corner desk or credenza. Allows for fixed and modular underdesk storage. Partial modesty gives access to electrical outlets when planned against walls

Works with Curved Front Corners (right hand shown).

**Ordering Options:**

Use the following checklist to customize the finishes on your order:

- laminate
- trim color
- grommet color

Each laminate comes with matching vinyl trim color unless otherwise specified on your purchase order. Refer to the laminate finish card for our current offering.

**Details:**

Grommets are available in black or silver. Black is the standard grommet option unless otherwise specified on your purchase order.

Surfaces up to and including 48" wide have one grommet located at the back center of the surface. Surfaces 54" wide and greater have two grommets at either side of the back of the surface.

All gables include grommets.

Code	Price	H	W	D	Volume (ft <sup>3</sup> )	Weight (lb)
KL-WB0Z-2424-L	714	29	24	24	1.81	37.64
KL-WB0Z-2424-R	714	29	24	24	1.81	37.64
KL-WB0Z-2430-L	855	29	24	30	2.2	45.75
KL-WB0Z-2430-R	855	29	24	30	2.2	45.75
KL-WB0Z-3024-L	754	29	30	24	2.2	45.44
KL-WB0Z-3024-R	754	29	30	24	2.2	45.44
KL-WB0Z-3030-L	883	29	30	30	2.68	54.05
KL-WB0Z-3030-R	883	29	30	30	2.68	54.05
KL-WB0Z-3624-L	793	29	36	24	2.59	53.24
KL-WB0Z-3624-R	793	29	36	24	2.59	53.24
KL-WB0Z-3630-L	946	29	36	30	3.15	62.35
KL-WB0Z-3630-R	946	29	36	30	3.15	62.35
KL-WB0Z-4224-L	834	29	42	24	2.98	61.04
KL-WB0Z-4224-R	834	29	42	24	2.98	61.04
KL-WB0Z-4230-L	986	29	42	30	3.62	70.65
KL-WB0Z-4230-R	986	29	42	30	3.62	70.65
KL-WB0Z-4824-L	872	29	48	24	3.37	68.84
KL-WB0Z-4824-R	872	29	48	24	3.37	68.84
KL-WB0Z-4830-L	1042	29	48	30	4.09	78.95
KL-WB0Z-4830-R	1042	29	48	30	4.09	78.95
KL-WB0Z-5424-L	905	29	54	24	3.76	76.64
KL-WB0Z-5424-R	905	29	54	24	3.76	76.64
KL-WB0Z-5430-L	1082	29	54	30	4.56	87.25
KL-WB0Z-5430-R	1082	29	54	30	4.56	87.25
KL-WB0Z-6024-L	924	29	60	24	4.15	84.44
KL-WB0Z-6024-R	924	29	60	24	4.15	84.44
KL-WB0Z-6030-L	1115	29	60	30	5.04	95.55
KL-WB0Z-6030-R	1115	29	60	30	5.04	95.55

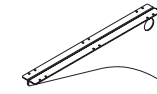

Cantilever



Intermediate Gable

# Metro Collab August 2024 Supports

Code	Price	H	W	D	Volume (ft <sup>3</sup> )	Weight (lb)
cantilever						
K-CCAB-16	105	0	16	0	3	0.1
K-CCAB-22	113	0	22	0	3	0.1
intermediate						
T-CGU0-12	201	28	12	1	1.48	8.75
T-CGU0-18	214	28	18	1	2.04	13.12

Metro Collab  
August 2024  
**Filing &  
Storage**

Executive & Professional

pedestals	110
underdesk storage cabinet	111
underdesk combo pedestal BBF & FF	112
underdesk storage cabinet	113

Executive

freestanding storage cabinet	114
freestanding combo pedestal BBF & FF	116
freestanding 2-drawer lateral file	118
freestanding 3-drawer lateral file	120
freestanding 4-drawer lateral file	122
freestanding storage tower	124
freestanding combo storage tower BBF	126
freestanding wardrobe storage tower	128
freestanding storage tower glazed door	130
freestanding combo storage tower FF	132
freestanding storage tower double door	134
freestanding combo lateral storage tower double door	136
freestanding combo storage tower double door	138
freestanding storage tower glazed double door	140
freestanding combo lateral storage tower glazed double door	142
freestanding combo storage tower glazed double door	144
radius corner bookcase short	146

Professional

freestanding storage cabinet	115
freestanding combo pedestal BBF & FF	117
freestanding 2-drawer lateral file	119
freestanding 3-drawer lateral file	121
freestanding 4-drawer lateral file	123
freestanding storage tower	125
freestanding combo storage tower BBF	127
freestanding wardrobe storage tower	129
freestanding storage tower glazed door	131
freestanding combo storage tower FF	133
freestanding storage tower double door	135
freestanding combo lateral storage tower double door	137
freestanding combo storage tower double door	139
freestanding storage tower glazed double door	141
freestanding combo lateral storage tower glazed double door	143
freestanding combo storage tower glazed double door	145
radius corner bookcase short	147

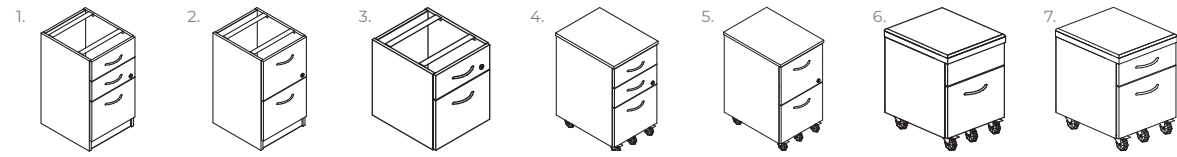

- 1. T-FPBU-1618 Underdesk BBF Pedestal
- 2. T-FPFU-1618 Underdesk FF Pedestal
- 3. T-FPSU-1618 Suspended Underdesk BF Pedestal
- 4. T-FPBM-1621 Mobile BBF Pedestal
- 5. T-FPFM-1621 Mobile FF Pedestal
- 6. T-1020-1618 Mobile Top Load w/ Seat Cushion Pedestal
- 7. T-1030-1618 Mobile BF w/ Seat Cushion Pedestal

**Ordering Options:**

Use the following checklist to customize the finishes on your order:

- laminate
- trim color
- handle color
- handle style
- fabric color (seats)

Each laminate comes with matching vinyl trim color unless otherwise specified on your purchase order.

Refer to the laminate & fabric finish cards for our current offering.

Code	Price	H	W	D	Volume (ft <sup>3</sup> )	Weight (lb)
T-FPBU-1618	923	28	16	18	8.15	55
T-FPBM-1621	1213	28	16	21	9.26	74
T-FPFU-1618	923	28	16	18	8.15	55
T-FPFM-1621	1213	28	16	21	9.26	68
T-FPSU-1618	655	16	16	18	5.09	44
T-1030-1618	1480	23	16	18	6.88	55

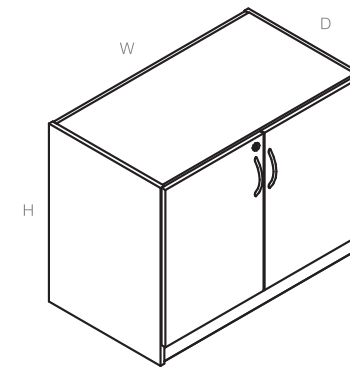

This underdesk storage cabinet provides private storage and shelving. This product is to be used under a desk, return or credenza.

**Ordering Options:**

Use the following checklist to customize the finishes on your order:

- laminate
- trim color
- handle color
- handle style

Each laminate comes with matching vinyl trim color unless otherwise specified on your purchase order.

Refer to the laminate & fabric finish cards for our current offering.

**Details:**

Includes locks, keys, and an adjustable shelf.

Code	Price	H	W	D	Volume (ft <sup>3</sup> )	Weight (lb)
T-FSU0-3020	1132	28	30	20	15.11	88
T-FSU0-3620	1226	28	36	20	17.78	102
T-FSU0-4220	1319	28	42	20	20.44	117
T-FSU0-3021	1132	28	30	21	15.74	92
T-FSU0-3621	1226	28	36	21	18.52	107
T-FSU0-4221	1319	28	42	21	21.3	122

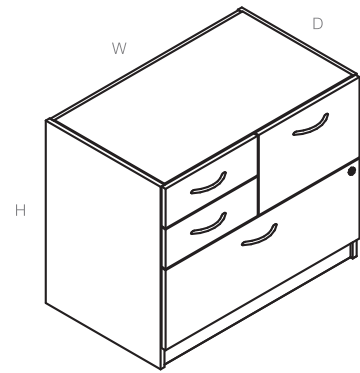

This product includes box and file drawers and is to be used under a desk, return or credenza for legal-sized paper.

**Ordering Options:**

Use the following checklist to customize the finishes on your order:

- laminate
- trim color
- handle color
- handle style

Each laminate comes with matching vinyl trim color unless otherwise specified on your purchase order.

Refer to the laminate & fabric finish cards for our current offering.

**Details:**

1. Includes locks and keys.
2. Comes equipped with drawer dividers, hanging file bars and levelers.
3. Hanging bars are installed along the depth only.
4. Includes a pencil tray.

Code	Price	H	W	D	Volume (ft <sup>3</sup> )	Weight (lb)
T-FPJU-3620-L	1785	28	36	20	17.78	121
T-FPJU-3621-L	1785	28	36	21	18.52	122
T-FPJU-3620-R	1785	28	36	20	17.78	121
T-FPJU-3621-R	1785	28	36	21	18.52	122

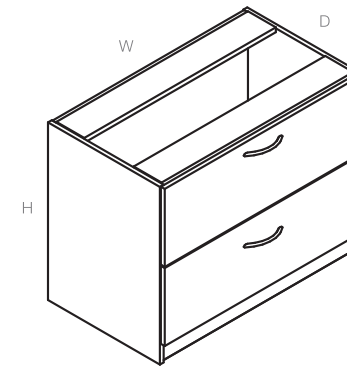

This lateral file provides large capacity filing and organized storage possibilities. It is to be used under a desk, return or credenza shell for stability. Its full extension drawers can accommodate both letter- and legal-sized paper.

Disclaimer: Please note that lateral file drawers are intended for filing letter and legal size paper front to back or side to side only. For details and weight restrictions please contact customer service.

**Ordering Options:**

Use the following checklist to customize the finishes on your order:

- laminate
- trim color
- handle color
- handle style

Each laminate comes with matching vinyl trim color unless otherwise specified on your purchase order.

Refer to the laminate & fabric finish cards for our current offering.

**Details:**

1. Includes locks and keys.
2. Comes equipped with drawer dividers, hanging file bars and levelers.
3. Hanging bars are installed along the depth only.

Code	Price	H	W	D	Volume (ft <sup>3</sup> )	Weight (lb)
T-FL2U-3020	1460	28	30	20	15.11	82.06
T-FL2U-3620	1513	28	36	20	17.78	86.64
T-FL2U-4220	1597	28	42	20	20.44	89.35
T-FL2U-3021	1460	28	30	21	15.74	84.6
T-FL2U-3621	1513	28	36	21	18.52	88.02
T-FL2U-4221	1597	28	42	21	21.3	91.44

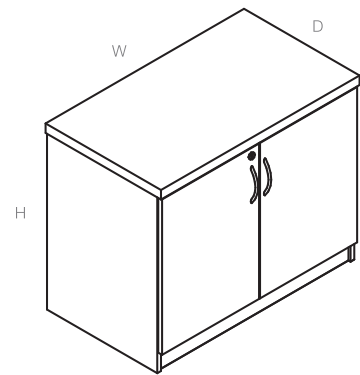

This freestanding storage cabinet provides private storage and shelving.

Freestanding Storage Cabinet, 1.5" Thick Top

**Ordering Options:**

Use the following checklist to customize the finishes on your order:

- laminate
- trim color
- edge profile
- handle color
- handle style

Each laminate comes with matching vinyl trim color unless otherwise specified on your purchase order.

Refer to the laminate & fabric finish cards for our current offering.

**Details:**

1. Includes locks and keys.
2. Comes equipped with drawer dividers, hanging file bars and levelers.
3. Hanging bars are installed along the depth only.

Code	Price	H	W	D	Volume (ft <sup>3</sup> )	Weight (lb)
T-FSF0-3021	1246	29.5	30	21	16.48	98
T-FSF0-3621	1336	29.5	36	21	19.39	111
T-FSF0-4221	1427	29.5	42	21	22.29	124

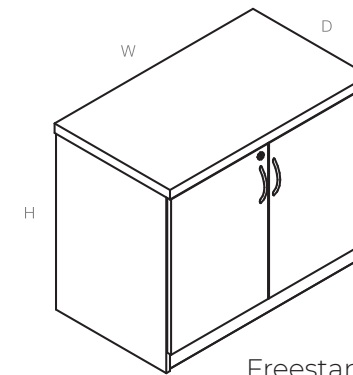

This freestanding storage cabinet provides private storage and shelving.

Freestanding Storage Cabinet, 1" Thick Top

**Ordering Options:**

Use the following checklist to customize the finishes on your order:

- laminate
- trim color
- handle color
- handle style

Each laminate comes with matching vinyl trim color unless otherwise specified on your purchase order.

Refer to the laminate & fabric finish cards for our current offering.

**Details:**

Includes locks, keys, and an adjustable shelf.

Code	Price	H	W	D	Volume (ft <sup>3</sup> )	Weight (lb)
TL-FSF0-3021	1190	29	30	21	16.23	88
TL-FSF0-3621	1283	29	36	21	19.1	97
TL-FSF0-4221	1374	29	42	21	21.96	106

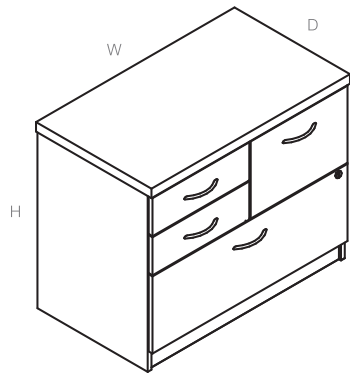

This product includes box and file drawers and is to be used as freestanding furniture. Its full extension drawers can accommodate both letter- and legal-sized paper.

Freestanding Combo Pedestal BBF & FF, 1.5" Thick Top

**Ordering Options:**

Use the following checklist to customize the finishes on your order:

- laminate
- trim color
- edge profile
- handle color
- handle style

Each laminate comes with matching vinyl trim color unless otherwise specified on your purchase order.

Refer to the laminate & fabric finish cards for our current offering.

**Details:**

1. Includes locks and keys.
2. Comes equipped with drawer dividers, hanging file bars and levelers.
3. Hanging bars are installed along the depth only.

Code	Price	H	W	D	Volume (ft <sup>3</sup> )	Weight (lb)
T-FPJF-3621-L	1869	29.5	36	21	19.39	130
T-FPJF-3621-R	1869	29.5	36	21	19.39	130

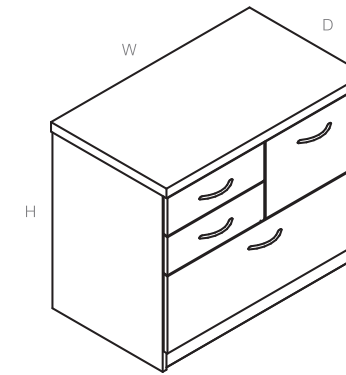

This product includes box and file drawers and is to be used as freestanding furniture. Its full extension drawers can accommodate both letter- and legal-sized paper.

Freestanding Combo Pedestal BBF & FF, 1" Thick Top

**Ordering Options:**

Use the following checklist to customize the finishes on your order:

- laminate
- trim color
- handle color
- handle style

Each laminate comes with matching vinyl trim color unless otherwise specified on your purchase order.

Refer to the laminate & fabric finish cards for our current offering.

**Details:**

1. Includes locks and keys.
2. Comes equipped with drawer dividers, hanging file bars and levelers.
3. Hanging bars are installed along the depth only.

Code	Price	H	W	D	Volume (ft <sup>3</sup> )	Weight (lb)
TL-FPJF-3621-L	1830	29	36	21	19.1	130
TL-FPJF-3621-R	1830	29	36	21	19.1	130

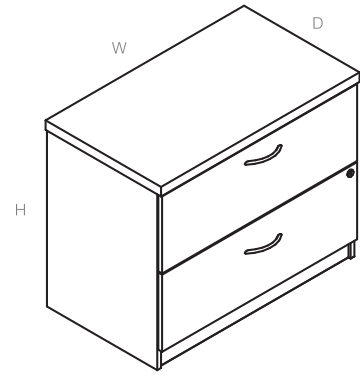

This lateral file with two drawers provides large capacity filing and organized storage. It is to be used as freestanding furniture. Its full extension drawers can accommodate both letter and legal-sized paper.

Disclaimer: Please note that lateral file drawers are intended for filing letter and legal size paper front to back or side to side only. For details and weight restrictions please contact customer service.

Freestanding 2-Drawer Lateral File, 1.5" Thick Top

**Ordering Options:**

Use the following checklist to customize the finishes on your order:

- laminate
- trim color
- edge profile
- handle color
- handle style

Each laminate comes with matching vinyl trim color unless otherwise specified on your purchase order.

Refer to the laminate & fabric finish cards for our current offering.

**Details:**

1. Includes locks and keys.
2. Comes equipped with drawer dividers, hanging file bars and levelers.
3. Hanging bars are installed along the depth only.

Code	Price	H	W	D	Volume (ft <sup>3</sup> )	Weight (lb)
T-FL2F-3021	1559	29.5	30	21	16.48	108.9
T-FL2F-3621	1610	29.5	36	21	19.39	117.27
T-FL2F-4221	1688	29.5	42	21	22.29	125.64

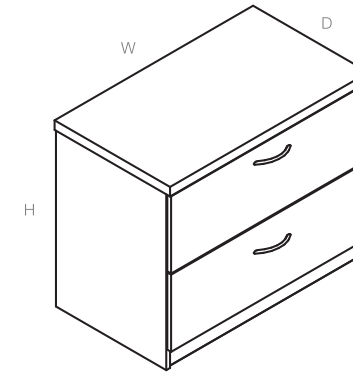

This lateral file with two drawers provides large capacity filing and organized storage. It is to be used as freestanding furniture. Its full extension drawers can accommodate both letter and legal-sized paper.

Disclaimer: Please note that lateral file drawers are intended for filing letter and legal size paper front to back or side to side only. For details and weight restrictions please contact customer service.

Freestanding 2-Drawer Lateral File, 1" Thick Top

**Ordering Options:**

Use the following checklist to customize the finishes on your order:

- laminate
- trim color
- handle color
- handle style

Each laminate comes with matching vinyl trim color unless otherwise specified on your purchase order.

Refer to the laminate & fabric finish cards for our current offering.

**Details:**

1. Includes locks and keys.
2. Comes equipped with drawer dividers, hanging file bars and levelers.
3. Hanging bars are installed along the depth only.

Code	Price	H	W	D	Volume (ft <sup>3</sup> )	Weight (lb)
TL-FL2F-3021	1511	29	30	21	16.23	92.7
TL-FL2F-3621	1560	29	36	21	19.1	107.1
TL-FL2F-4221	1643	29	42	21	21.96	121.5



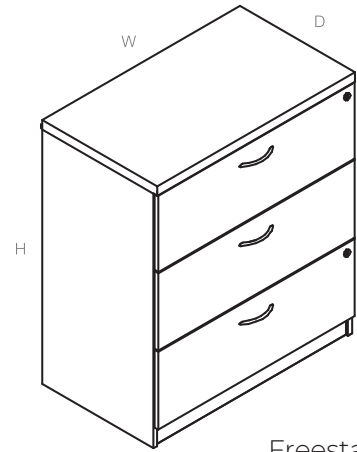

Freestanding 3-Drawer Lateral File, 1.5" Thick Top

This lateral file with two drawers provides large capacity filing and organized storage. It is to be used as freestanding furniture. Its full extension drawers can accommodate both letter and legal-sized paper.

Disclaimer: Please note that lateral file drawers are intended for filing letter and legal size paper front to back or side to side only. For details and weight restrictions please contact customer service.

**Ordering Options:**

Use the following checklist to customize the finishes on your order:

- laminate
- trim color
- edge profile
- handle color
- handle style

Each laminate comes with matching vinyl trim color unless otherwise specified on your purchase order.

Refer to the laminate & fabric finish cards for our current offering.

**Details:**

1. Includes locks and keys.
2. Comes equipped with drawer dividers, hanging file bars and levelers.
3. Hanging bars are installed along the depth only.

Code	Price	H	W	D	Volume (ft <sup>3</sup> )	Weight (lb)
T-FL3F-3021	1938	40.5	30	21	21.89	145
T-FL3F-3621	2021	40.5	36	21	25.75	154.96

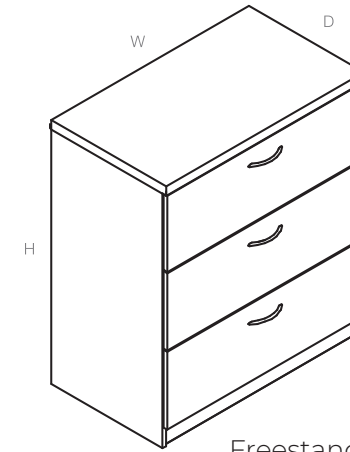

Freestanding 3-Drawer Lateral File, 1" Thick Top

This lateral file with two drawers provides large capacity filing and organized storage. It is to be used as freestanding furniture. Its full extension drawers can accommodate both letter and legal-sized paper.

Disclaimer: Please note that lateral file drawers are intended for filing letter and legal size paper front to back or side to side only. For details and weight restrictions please contact customer service.

**Ordering Options:**

Use the following checklist to customize the finishes on your order:

- laminate
- trim color
- handle color
- handle style

Each laminate comes with matching vinyl trim color unless otherwise specified on your purchase order.

Refer to the laminate & fabric finish cards for our current offering.

**Details:**

1. Includes locks and keys.
2. Comes equipped with drawer dividers, hanging file bars and levelers.
3. Hanging bars are installed along the depth only.

Code	Price	H	W	D	Volume (ft <sup>3</sup> )	Weight (lb)
TL-FL3F-3021	1702	40	30	21	21.64	136.5
TL-FL3F-3621	1785	40	36	21	25.46	144.25

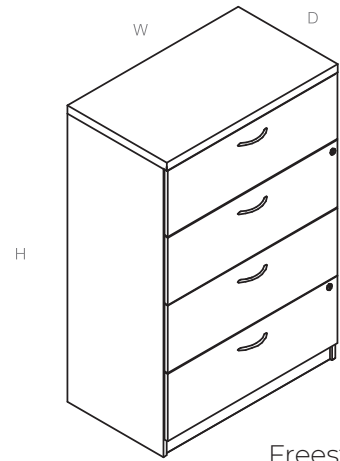

Freestanding 4-Drawer Lateral File, 1.5" Thick Top

This lateral file with two drawers provides large capacity filing and organized storage. It is to be used as freestanding furniture. Its full extension drawers can accommodate both letter and legal-sized paper.

Disclaimer: Please note that lateral file drawers are intended for filing letter and legal size paper front to back or side to side only. For details and weight restrictions please contact customer service.

**Ordering Options:**

Use the following checklist to customize the finishes on your order:

- laminate
- trim color
- edge profile
- handle color
- handle style

Each laminate comes with matching vinyl trim color unless otherwise specified on your purchase order.

Refer to the laminate & fabric finish cards for our current offering.

**Details:**

1. Includes locks and keys.
2. Comes equipped with drawer dividers, hanging file bars and levelers.
3. Hanging bars are installed along the depth only.

Code	Price	H	W	D	Volume (ft <sup>3</sup> )	Weight (lb)
T-FL4F-3021	2537	52.5	30	21	27.79	171.3
T-FL4F-3621	2619	52.5	36	21	32.7	183.24

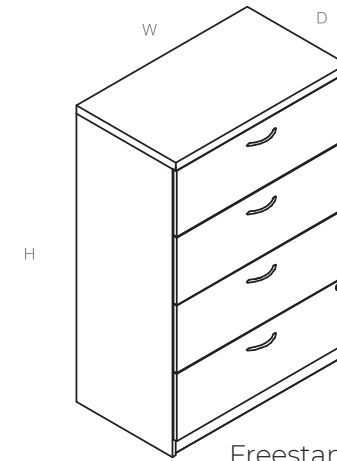

Freestanding 4-Drawer Lateral File, 1" Thick Top

This lateral file with two drawers provides large capacity filing and organized storage. It is to be used as freestanding furniture. Its full extension drawers can accommodate both letter and legal-sized paper.

Disclaimer: Please note that lateral file drawers are intended for filing letter and legal size paper front to back or side to side only. For details and weight restrictions please contact customer service.

**Ordering Options:**

Use the following checklist to customize the finishes on your order:

- laminate
- trim color
- handle color
- handle style

Each laminate comes with matching vinyl trim color unless otherwise specified on your purchase order.

Refer to the laminate & fabric finish cards for our current offering.

**Details:**

1. Includes locks and keys.
2. Comes equipped with drawer dividers, hanging file bars and levelers.
3. Hanging bars are installed along the depth only.

Code	Price	H	W	D	Volume (ft <sup>3</sup> )	Weight (lb)
TL-FL4F-3021	2298	52	30	21	27.55	153.1
TL-FL4F-3621	2382	52	36	21	32.41	162.98

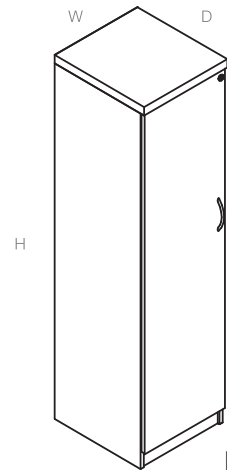

This lockable storage tower functions the same way as a storage cabinet but with more vertical space. Shelves are adjustable for user to customize with levelers (left hand shown).

Freestanding Storage Tower, 1.5" Thick Top

**Ordering Options:**

Use the following checklist to customize the finishes on your order:

- laminate
- trim color
- edge profile
- handle color
- handle style

Each laminate comes with matching vinyl trim color unless otherwise specified on your purchase order.

Refer to the laminate & fabric finish cards for our current offering.

**Details:**

1. Includes locks and keys.
2. Comes equipped with drawer dividers, hanging file bars and levelers.

Code	Price	H	W	D	Volume (ft <sup>3</sup> )	Weight (lb)
T-FSDS-1821-L	1382	68	18	21	22.92	133.65
T-FSDS-1821-R	1382	68	18	21	22.92	133.65

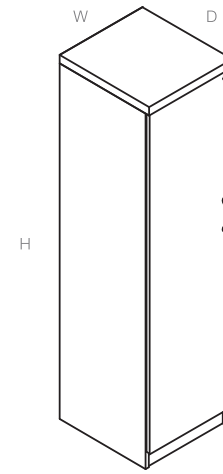

This lockable storage tower functions the same way as a storage cabinet but with more vertical space. Shelves are adjustable for user to customize with levelers (left hand shown).

Freestanding Storage Tower, 1" Thick Top

**Ordering Options:**

Use the following checklist to customize the finishes on your order:

- laminate
- trim color
- handle color
- handle style

Each laminate comes with matching vinyl trim color unless otherwise specified on your purchase order.

Refer to the laminate & fabric finish cards for our current offering.

**Details:**

1. Includes locks and keys.
2. Comes equipped with drawer dividers, hanging file bars and levelers.

Code	Price	H	W	D	Volume (ft <sup>3</sup> )	Weight (lb)
TL-FSDS-1821-L	1326	67	18	21	22.6	128.7
TL-FSDS-1821-R	1326	67	18	21	22.6	128.7

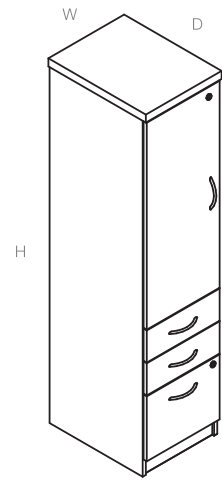

This storage tower combines the filing capabilities of a BBF with the flexibility of a cabinet. Drawers accept both letter and legal-sized paper (left hand shown).

Freestanding Combo Storage Tower BBF, 1.5" Thick Top

**Ordering Options:**

Use the following checklist to customize the finishes on your order:

- laminate
- trim color
- edge profile
- handle color
- handle style

Each laminate comes with matching vinyl trim color unless otherwise specified on your purchase order.

Refer to the laminate & fabric finish cards for our current offering.

**Details:**

1. Includes locks and keys.
2. Comes equipped with levelers and adjustable shelves.

Code	Price	H	W	D	Volume (ft <sup>3</sup> )	Weight (lb)
T-FCSB-1821-L	2171	68	18	21	22.92	168
T-FCSB-1821-R	2171	68	18	21	22.92	168

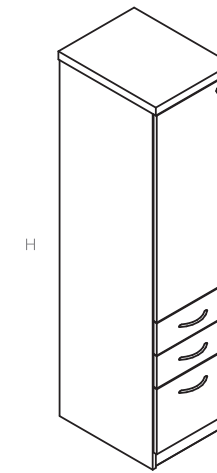

This storage tower combines the filing capabilities of a BBF with the flexibility of a cabinet. Drawers accept both letter and legal-sized paper (left hand shown).

Freestanding Combo Storage Tower BBF, 1" Thick Top

**Ordering Options:**

Use the following checklist to customize the finishes on your order:

- laminate
- trim color
- handle color
- handle style

Each laminate comes with matching vinyl trim color unless otherwise specified on your purchase order.

Refer to the laminate & fabric finish cards for our current offering.

**Details:**

1. Includes locks and keys.
2. Comes equipped with levelers and adjustable shelves.

Code	Price	H	W	D	Volume (ft <sup>3</sup> )	Weight (lb)
TL-FCSB-1821-L	1936	67	18	21	22.6	163
TL-FCSB-1821-R	1936	67	18	21	22.6	163

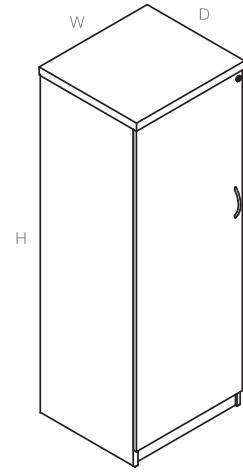

This unit provides a lockable storage area for apparel and other personal items. Includes a coat bar and adjustable shelves with levelers (left hand shown).

Freestanding Wardrobe Storage Tower, 1.5" Thick Top

**Ordering Options:**

Use the following checklist to customize the finishes on your order:

- laminate
- trim color
- edge profile
- handle color
- handle style

Each laminate comes with matching vinyl trim color unless otherwise specified on your purchase order.

Refer to the laminate & fabric finish cards for our current offering.

**Details:**

1. Includes locks and keys.
2. Comes equipped with levelers and adjustable shelves.

Code	Price	H	W	D	Volume (ft <sup>3</sup> )	Weight (lb)
T-FSDC-2421-L	1490	68	24	21	29.17	179.64
T-FSDC-2421-R	1490	68	24	21	29.17	179.64

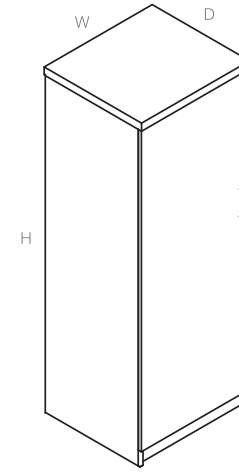

This unit provides a lockable storage area for apparel and other personal items. Includes a coat bar and adjustable shelves with levelers (left hand shown).

Freestanding Wardrobe Storage Tower, 1" Thick Top

**Ordering Options:**

Use the following checklist to customize the finishes on your order:

- laminate
- trim color
- handle color
- handle style

Each laminate comes with matching vinyl trim color unless otherwise specified on your purchase order.

Refer to the laminate & fabric finish cards for our current offering.

**Details:**

1. Includes locks and keys.
2. Comes equipped with levelers and adjustable shelves.

Code	Price	H	W	D	Volume (ft <sup>3</sup> )	Weight (lb)
TL-FSDC-2421-L	1434	67	24	21	28.76	169.95
TL-FSDC-2421-R	1434	67	24	21	28.76	169.95

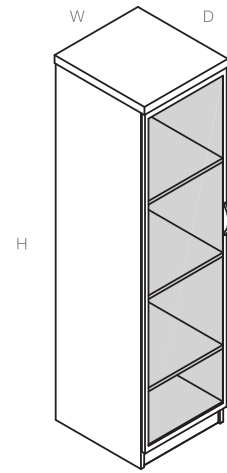

This storage tower functions the same way as a storage cabinet but with more vertical space and a glazed door. Shelves are adjustable for user to customize with levelers (left hand shown).

Freestanding Storage Tower Glazed Door, 1.5" Thick Top

**Ordering Options:**

Use the following checklist to customize the finishes on your order:

- laminate
- trim color
- edge profile
- handle color
- handle style

Each laminate comes with matching vinyl trim color unless otherwise specified on your purchase order.

Refer to the laminate & fabric finish cards for our current offering.

**Details:**

1. Includes locks and keys.
2. Comes equipped with levelers and adjustable shelves.

Code	Price	H	W	D	Volume (ft <sup>3</sup> )	Weight (lb)
T-FSDS-1821-L-G	2923	68	18	21	22.92	119.81

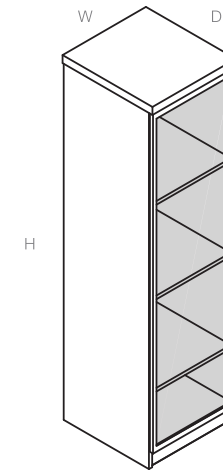

This storage tower functions the same way as a storage cabinet but with more vertical space and a glazed door. Shelves are adjustable for user to customize with levelers (left hand shown).

Freestanding Storage Tower Glazed Door, 1" Thick Top

**Ordering Options:**

Use the following checklist to customize the finishes on your order:

- laminate
- trim color
- handle color
- handle style

Each laminate comes with matching vinyl trim color unless otherwise specified on your purchase order.

Refer to the laminate & fabric finish cards for our current offering.

**Details:**

1. Includes locks and keys.
2. Comes equipped with levelers and adjustable shelves.

Code	Price	H	W	D	Volume (ft <sup>3</sup> )	Weight (lb)
TL-FSDS-1821-LG	2867	67	18	21	22.6	113.85
TL-FSDS-1821-RG	2867	67	18	21	22.6	113.85

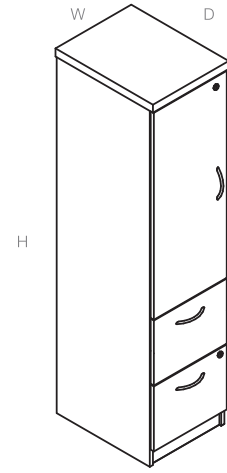

This storage tower combines the filing capabilities of a FF with the flexibility of a cabinet. Drawers accept both letter and legal-sized paper (left hand shown).

Freestanding Combo Storage Tower FF, 1.5" Thick Top

**Ordering Options:**

Use the following checklist to customize the finishes on your order:

- laminate
- trim color
- edge profile
- handle color
- handle style

Each laminate comes with matching vinyl trim color unless otherwise specified on your purchase order.

Refer to the laminate & fabric finish cards for our current offering.

**Details:**

1. Includes locks and keys.
2. Comes equipped with levelers and adjustable shelves.

Code	Price	H	W	D	Volume (ft <sup>3</sup> )	Weight (lb)
T-FCSF-1821-L	2171	68	18	21	22.92	162
T-FCSF-1821-R	2171	68	18	21	22.92	162

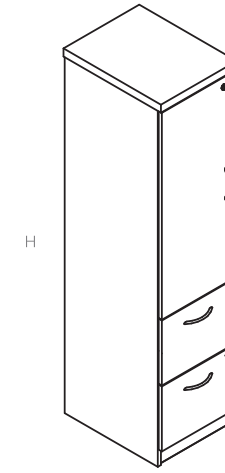

This storage tower combines the filing capabilities of a FF with the flexibility of a cabinet. Drawers accept both letter and legal-sized paper (left hand shown).

Freestanding Combo Storage Tower FF, 1" Thick Top

**Ordering Options:**

Use the following checklist to customize the finishes on your order:

- laminate
- trim color
- handle color
- handle style

Each laminate comes with matching vinyl trim color unless otherwise specified on your purchase order.

Refer to the laminate & fabric finish cards for our current offering.

**Details:**

1. Includes locks and keys.
2. Comes equipped with levelers and adjustable shelves.

Code	Price	H	W	D	Volume (ft <sup>3</sup> )	Weight (lb)
TL-FCSF-1821-L	1936	67	18	21	22.6	129
TL-FCSF-1821-R	1936	67	18	21	22.6	129

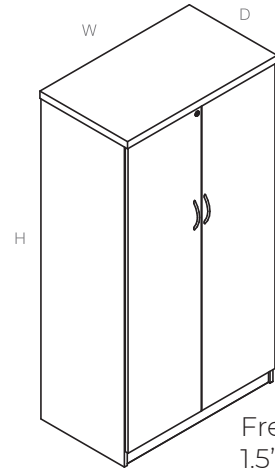

This lockable storage tower with double doors functions the same way as a storage cabinet but with more vertical space. Shelves are adjustable for user to customize with levelers.

Freestanding Storage Tower Double Door, 1.5" Thick Top

**Ordering Options:**

Use the following checklist to customize the finishes on your order:

- laminate
- trim color
- edge profile
- handle color
- handle style

Each laminate comes with matching vinyl trim color unless otherwise specified on your purchase order.

Refer to the laminate & fabric finish cards for our current offering.

**Details:**

1. Includes locks and keys.
2. Comes equipped with levelers and adjustable shelves.

Code	Price	H	W	D	Volume (ft <sup>3</sup> )	Weight (lb)
T-FSDS-3621	2171	68	36	21	41.67	204.96

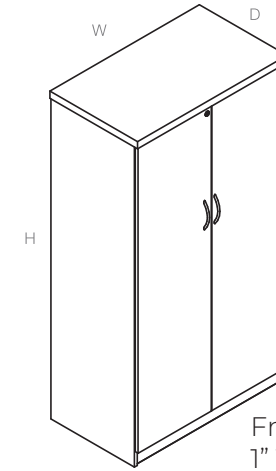

This lockable storage tower with double doors functions the same way as a storage cabinet but with more vertical space. Shelves are adjustable for user to customize with levelers.

Freestanding Storage Tower Double Door, 1" Thick Top

**Ordering Options:**

Use the following checklist to customize the finishes on your order:

- laminate
- trim color
- handle color
- handle style

Each laminate comes with matching vinyl trim color unless otherwise specified on your purchase order.

Refer to the laminate & fabric finish cards for our current offering.

**Details:**

1. Includes locks and keys.
2. Comes equipped with levelers and adjustable shelves.

Code	Price	H	W	D	Volume (ft <sup>3</sup> )	Weight (lb)
TL-FSDS-3621	2020	67	36	21	41.09	195.39



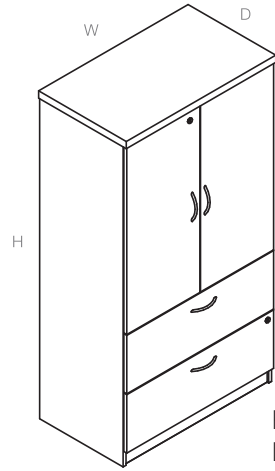

This storage tower combines the filing capabilities of a lateral storage unit with the flexibility of a cabinet. Drawers accept both letter and legal-sized paper.

Freestanding Combo Lateral Storage Tower Double Door, 1.5" Thick Top

**Ordering Options:**

Use the following checklist to customize the finishes on your order:

- laminate
- trim color
- edge profile
- handle color
- handle style

Each laminate comes with matching vinyl trim color unless otherwise specified on your purchase order.

Refer to the laminate & fabric finish cards for our current offering.

**Details:**

1. Includes locks and keys.
2. Comes equipped with levelers and adjustable shelves.

Code	Price	H	W	D	Volume (ft <sup>3</sup> )	Weight (lb)
T-FCSL-3621	2577	68	36	21	41.67	260.82

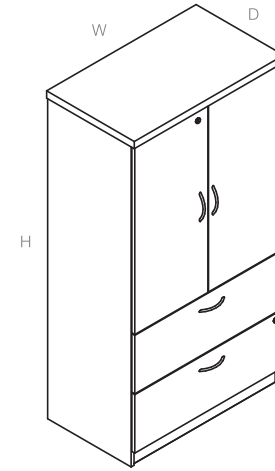

This storage tower combines the filing capabilities of a lateral storage unit with the flexibility of a cabinet. Drawers accept both letter and legal-sized paper.

Freestanding Combo Lateral Storage Tower Double Door, 1" Thick Top

**Ordering Options:**

Use the following checklist to customize the finishes on your order:

- laminate
- trim color
- handle color
- handle style

Each laminate comes with matching vinyl trim color unless otherwise specified on your purchase order.

Refer to the laminate & fabric finish cards for our current offering.

**Details:**

1. Includes locks and keys.
2. Comes equipped with levelers and adjustable shelves.

Code	Price	H	W	D	Volume (ft <sup>3</sup> )	Weight (lb)
TL-FCSL-3621	2342	67	36	21	41.09	251.25

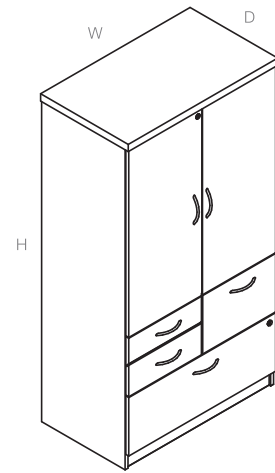

This storage tower combines the filing capabilities of lateral and underdesk storage with the flexibility of a cabinet. Drawers accept both letter and legal-sized paper.

Freestanding Combo Storage Tower Double Door, 1.5" Thick Top

**Ordering Options:**

Use the following checklist to customize the finishes on your order:

- laminate
- trim color
- edge profile
- handle color
- handle style

Each laminate comes with matching vinyl trim color unless otherwise specified on your purchase order.

Refer to the laminate & fabric finish cards for our current offering.

**Details:**

1. Includes locks and keys.
2. Comes equipped with levelers and adjustable shelves.

Code	Price	H	W	D	Volume (ft <sup>3</sup> )	Weight (lb)
T-FCSJ-3621	2851	68	36	21	41.67	266.82

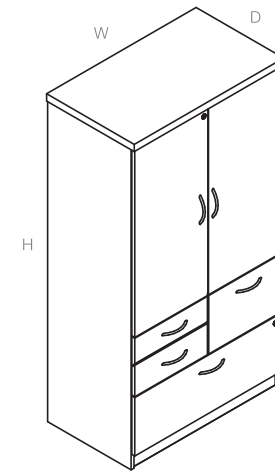

This storage tower combines the filing capabilities of lateral and underdesk storage with the flexibility of a cabinet. Drawers accept both letter and legal-sized paper.

Freestanding Combo Storage Tower Double Door, 1" Thick Top

**Ordering Options:**

Use the following checklist to customize the finishes on your order:

- laminate
- trim color
- handle color
- handle style

Each laminate comes with matching vinyl trim color unless otherwise specified on your purchase order.

Refer to the laminate & fabric finish cards for our current offering.

**Details:**

1. Includes locks and keys.
2. Comes equipped with levelers and adjustable shelves.

Code	Price	H	W	D	Volume (ft <sup>3</sup> )	Weight (lb)
TL-FCSJ-3621	2615	67	36	21	41.09	257.35

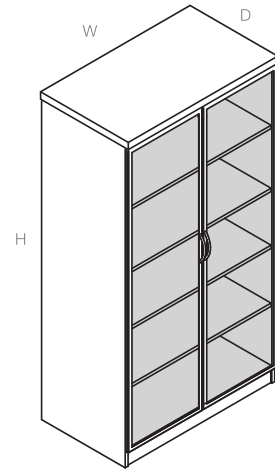

Freestanding Storage Tower Glazed Double Door, 1.5" Thick Top

This lockable storage tower with glazed double doors functions the same way as a storage cabinet but with more vertical space. Shelves are adjustable for user to customize with levelers.

**Ordering Options:**

Use the following checklist to customize the finishes on your order:

- laminate
- trim color
- edge profile
- handle color
- handle style

Each laminate comes with matching vinyl trim color unless otherwise specified on your purchase order.

Refer to the laminate & fabric finish cards for our current offering.

**Details:**

1. Includes locks and keys.
2. Comes equipped with levelers and adjustable shelves.

Code	Price	H	W	D	Volume (ft <sup>3</sup> )	Weight (lb)
T-FSDS-3621-G	3693	68	36	21	41.67	210.6

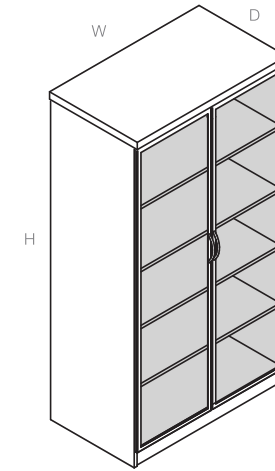

Freestanding Storage Tower Glazed Double Door, 1" Thick Top

This lockable storage tower with glazed double doors functions the same way as a storage cabinet but with more vertical space. Shelves are adjustable for user to customize with levelers.

**Ordering Options:**

Use the following checklist to customize the finishes on your order:

- laminate
- trim color
- handle color
- handle style

Each laminate comes with matching vinyl trim color unless otherwise specified on your purchase order.

Refer to the laminate & fabric finish cards for our current offering.

**Details:**

1. Includes locks and keys.
2. Comes equipped with levelers and adjustable shelves.

Code	Price	H	W	D	Volume (ft <sup>3</sup> )	Weight (lb)
TL-FSDS-3621-G	3544	67	36	21	41.09	210.6

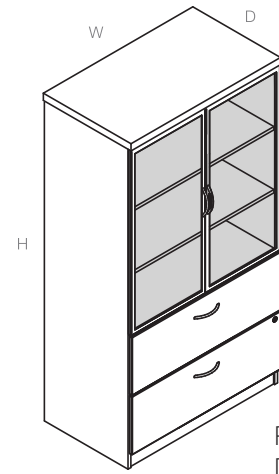

This storage tower combines the filing capabilities of a lateral storage unit with the flexibility of a cabinet. Drawers accept both letter and legal-sized paper.

Freestanding Combo Lateral Storage Tower Glazed Double Door, 1.5" Thick Top

**Ordering Options:**

Use the following checklist to customize the finishes on your order:

- laminate
- trim color
- edge profile
- handle color
- handle style

Each laminate comes with matching vinyl trim color unless otherwise specified on your purchase order.

Refer to the laminate & fabric finish cards for our current offering.

**Details:**

1. Includes locks and keys.
2. Comes equipped with levelers and adjustable shelves.

Code	Price	H	W	D	Volume (ft <sup>3</sup> )	Weight (lb)
T-FCSL-3621-G	4151	68	36	21	41.67	222.62

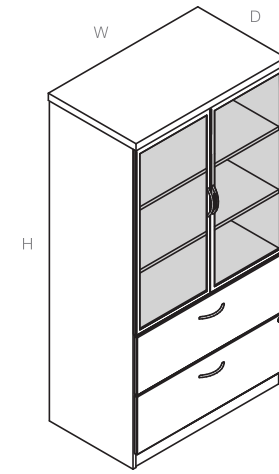

This storage tower combines the filing capabilities of a lateral storage unit with the flexibility of a cabinet. Drawers accept both letter and legal-sized paper.

Freestanding Combo Lateral Storage Tower Glazed Double Door, 1" Thick Top

**Ordering Options:**

Use the following checklist to customize the finishes on your order:

- laminate
- trim color
- handle color
- handle style

Each laminate comes with matching vinyl trim color unless otherwise specified on your purchase order.

Refer to the laminate & fabric finish cards for our current offering.

**Details:**

1. Includes locks and keys.
2. Comes equipped with levelers and adjustable shelves.

Code	Price	H	W	D	Volume (ft <sup>3</sup> )	Weight (lb)
TL-FCSL-3621-G	3928	67	36	21	41.09	213.05

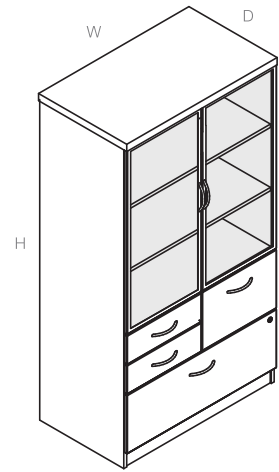

This storage tower combines the filing capabilities of lateral and underdesk storage with the flexibility of a cabinet. Drawers accept both letter and legal-sized paper.

Freestanding Combo Storage Tower Glazed Double Door, 1.5" Thick Top

**Ordering Options:**

Use the following checklist to customize the finishes on your order:

- laminate
- trim color
- edge profile
- handle color
- handle style

Each laminate comes with matching vinyl trim color unless otherwise specified on your purchase order.

Refer to the laminate & fabric finish cards for our current offering.

**Details:**

1. Includes locks and keys.
2. Comes equipped with levelers and adjustable shelves.

Code	Price	H	W	D	Volume (ft <sup>3</sup> )	Weight (lb)
T-FCSJ-3621-G	4429	68	36	21	41.67	229.87

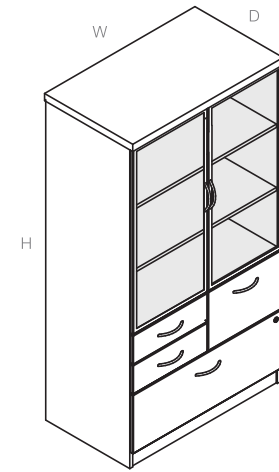

This storage tower combines the filing capabilities of lateral and underdesk storage with the flexibility of a cabinet. Drawers accept both letter and legal-sized paper.

Freestanding Combo Storage Tower Glazed Double Door, 1" Thick Top

**Ordering Options:**

Use the following checklist to customize the finishes on your order:

- laminate
- trim color
- handle color
- handle style

Each laminate comes with matching vinyl trim color unless otherwise specified on your purchase order.

Refer to the laminate & fabric finish cards for our current offering.

**Details:**

1. Includes locks and keys.
2. Comes equipped with levelers and adjustable shelves.

Code	Price	H	W	D	Volume (ft <sup>3</sup> )	Weight (lb)
TL-FCSJ-3621-G	4193	67	36	21	41.09	219.87

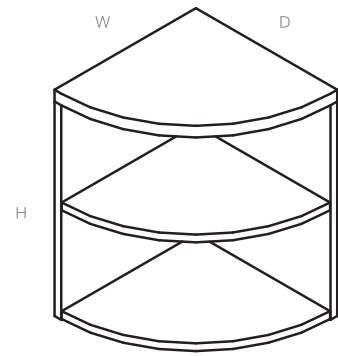

This bookcase provides open storage space within the workstation. Sits nicely against credenzas and other freestanding furniture.

Radius Corner Bookcase Short, 1.5" Thick Top

**Ordering Options:**

Use the following checklist to customize the finishes on your order:

- laminate
- trim color
- edge profile

Each laminate comes with matching vinyl trim color unless otherwise specified on your purchase order.

Refer to the laminate & fabric finish cards for our current offering.

**Details:**

1. Comes equipped with levelers and adjustable shelf.
2. Aligns with desk height.

Code	Price	H	W	D	Volume (ft <sup>3</sup> )	Weight (lb)
K-SBRC-292121	725	29.5	21	21	12.12	71
K-SBRC-292424	843	29.5	24	24	13.57	95.5

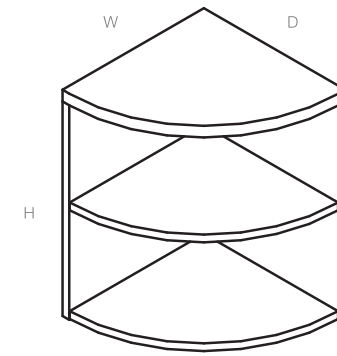

This bookcase provides open storage space within the workstation. Sits nicely against credenzas and other freestanding furniture.

Radius Corner Bookcase Short, 1" Thick Top

**Ordering Options:**

Use the following checklist to customize the finishes on your order:

- laminate
- trim color

Each laminate comes with matching vinyl trim color unless otherwise specified on your purchase order.

Refer to the laminate & fabric finish cards for our current offering.

**Details:**

1. Comes equipped with levelers and adjustable shelf.
2. Aligns with desk height.

Code	Price	H	W	D	Volume (ft <sup>3</sup> )	Weight (lb)
KL-SBRC-292121	630	29	21	21	11.94	50
KL-SBRC-292424	746	29	24	24	14.97	58



Metro Collab  
August 2024  
**Overhead  
Storage**

overhead storage

Executive

<u>open hutch</u>	150
<u>hinged door overhead storage</u>	152
<u>hinged door overhead storage glazed doors</u>	154

Professional

<u>open hutch</u>	151
<u>hinged door overhead storage</u>	153
<u>hinged door overhead storage glazed doors</u>	155

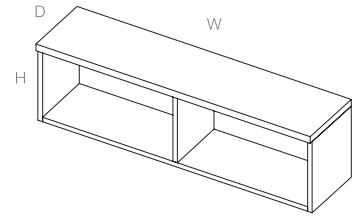

This open hutch provides open overhead storage within the workstation.

Open Hutch, 1.5" Thick Top

**Ordering Options:**

Use the following checklist to customize the finishes on your order:

- laminate
- trim color
- edge profile

Each laminate comes with matching vinyl trim color unless otherwise specified on your purchase order. Refer to the laminate finish card for our current offering.

**Details:**

1. Overheads 54 inches and wider require 4 large vertical posts for support.
2. Overheads 48 inches and smaller require 2 large vertical posts for support.
3. The 54, 60, 66, and 72 inch open hutches come with a divider.

Code	Price	H	W	D	Volume (ft <sup>3</sup> )	Weight (lb)
K-SHO-1524	523	17	24	15	8	32
K-SHO-1530	563	17	30	15	9	36
K-SHO-1536	601	17	36	15	10	40
K-SHO-1542	668	17	42	15	11	44
K-SHO-1548	707	17	48	15	12	48
K-SHO-1554	745	17	54	15	13	52
K-SHO-1560	811	17	60	15	14	55
K-SHO-1566	848	17	66	15	16	59
K-SHO-1572	886	17	72	15	17	63

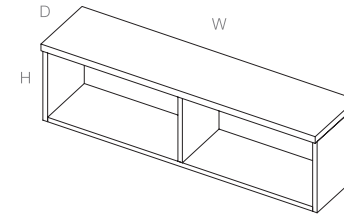

This open hutch provides open overhead storage within the workstation.

Open Hutch, 1" Thick Top

**Ordering Options:**

Use the following checklist to customize the finishes on your order:

- laminate
- trim color

Each laminate comes with matching vinyl trim color unless otherwise specified on your purchase order. Refer to the laminate finish card for our current offering.

**Details:**

1. Overheads 54 inches and wider require 4 large vertical posts for support.
2. Overheads 48 inches and smaller require 2 large vertical posts for support.

Code	Price	H	W	D	Volume (ft <sup>3</sup> )	Weight (lb)
KL-SHO-1524	497	17	24	15	8	31
KL-SHO-1530	529	17	30	15	9	35
KL-SHO-1536	563	17	36	15	10	39
KL-SHO-1542	625	17	42	15	11	43
KL-SHO-1548	655	17	48	15	12	47
KL-SHO-1554	690	17	54	15	13	51
KL-SHO-1560	746	17	60	15	14	54
KL-SHO-1566	782	17	66	15	16	58
KL-SHO-1572	813	17	72	15	17	62



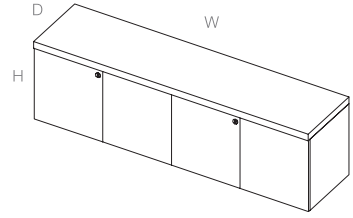

This hinged door hutch provides overhead storage within the workstation.

Hinged Door Overhead Storage, 1.5" Thick Top

**Ordering Options:**

Use the following checklist to customize the finishes on your order:

- laminate
- trim color
- edge profile

Each laminate comes with matching vinyl trim color unless otherwise specified on your purchase order. Refer to the laminate finish card for our current offering.

**Details:**

1. Overheads 54 inches and wider require 4 large vertical posts for support.
2. Overheads 48 inches and smaller require 2 large vertical posts for support.
3. The 54, 60, 66, and 72 inch open hutches come with a divider.

Code	Price	H	W	D	Volume (ft <sup>3</sup> )	Weight (lb)
K-SHH-1524-L	688	17	24	15	8	41
K-SHH-1530-L	758	17	30	15	9	47
K-SHH-1536-L	795	17	36	15	10	53
K-SHH-1542-L	965	17	42	15	11	59
K-SHH-1548-L	1022	17	48	15	12	65
K-SHH-1554-L	1079	17	54	15	13	71
K-SHH-1560-L	1180	17	60	15	14	77
K-SHH-1566-L	1240	17	66	15	16	82
K-SHH-1572-L	1293	17	72	15	17	88

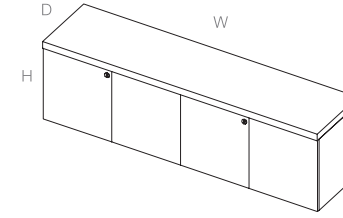

This hinged door hutch provides overhead storage within the workstation.

Hinged Door Overhead Storage, 1" Thick Top

**Ordering Options:**

Use the following checklist to customize the finishes on your order:

- laminate
- trim color

Each laminate comes with matching vinyl trim color unless otherwise specified on your purchase order. Refer to the laminate finish card for our current offering.

**Details:**

1. Overheads 54 inches and wider require 4 large vertical posts for support.
2. Overheads 48 inches and smaller require 2 large vertical posts for support.

Code	Price	H	W	D	Volume (ft <sup>3</sup> )	Weight (lb)
KL-SHH-1524-L	661	17	24	15	8	40
KL-SHH-1530-L	725	17	30	15	9	46
KL-SHH-1536-L	756	17	36	15	10	52
KL-SHH-1542-L	921	17	42	15	11	58
KL-SHH-1548-L	966	17	48	15	12	64
KL-SHH-1554-L	1021	17	54	15	13	70
KL-SHH-1560-L	1114	17	60	15	14	76
KL-SHH-1566-L	1167	17	66	15	16	82
KL-SHH-1572-L	1213	17	72	15	17	88

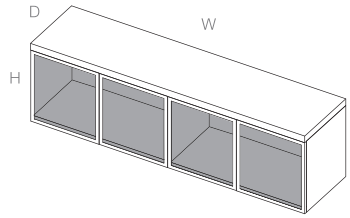

This hinged door hutch provides overhead storage within the workstation.

Hinged Door Overhead Storage Glazed Doors, 1.5" Thick Top

**Ordering Options:**

Use the following checklist to customize the finishes on your order:

- laminate
- trim color
- edge profile

Each laminate comes with matching vinyl trim color unless otherwise specified on your purchase order. Refer to the laminate finish card for our current offering.

**Details:**

1. Overheads 54 inches and wider require 4 large vertical posts for support.
2. Overheads 48 inches and smaller require 2 large vertical posts for support.
3. The 54, 60, 66, and 72 inch open hutches come with a divider.

Code	Price	H	W	D	Volume (ft <sup>3</sup> )	Weight (lb)
K-SHH-1524-G	1003	17	24	15	8	41
K-SHH-1530-G	1074	17	30	15	9	47
K-SHH-1536-G	1143	17	36	15	10	53
K-SHH-1542-G	1377	17	42	15	11	59
K-SHH-1548-G	1445	17	48	15	12	65
K-SHH-1554-G	1515	17	54	15	13	71
K-SHH-1560-G	1759	17	60	15	14	77
K-SHH-1566-G	1826	17	66	15	16	83
K-SHH-1572-G	1893	17	72	15	17	89

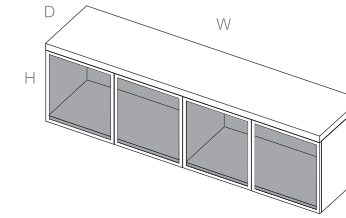

This hinged door hutch provides overhead storage within the workstation.

Hinged Door Overhead Storage Glazed Doors, 1" Thick Top

**Ordering Options:**

Use the following checklist to customize the finishes on your order:

- laminate
- trim color

Each laminate comes with matching vinyl trim color unless otherwise specified on your purchase order. Refer to the laminate finish card for our current offering.

**Details:**

1. Overheads 54 inches and wider require 4 large vertical posts for support.
2. Overheads 48 inches and smaller require 2 large vertical posts for support.

Code	Price	H	W	D	Volume (ft <sup>3</sup> )	Weight (lb)
KL-SHH-1524-G	974	17	24	15	8	40
KL-SHH-1530-G	1047	17	30	15	9	46
KL-SHH-1536-G	1123	17	36	15	10	52
KL-SHH-1542-G	1339	17	42	15	11	58
KL-SHH-1548-G	1413	17	48	15	12	64
KL-SHH-1554-G	1488	17	54	15	13	70
KL-SHH-1560-G	1706	17	60	15	14	76
KL-SHH-1566-G	1781	17	66	15	16	82
KL-SHH-1572-G	1855	17	72	15	17	88



Metro Collab  
August 2024  
**Posts**

<u>large vertical aluminum post</u>	158
<u>small vertical aluminum post</u>	159



This large post supports overhead storage and screens.

Large Vertical Aluminum Post

**Ordering Options:**

Use the following checklist to customize the finishes on your order:

- metal color

**Details:**

1. Large vertical aluminum posts support overheads and hutches.
2. Surfaces 54 inches and wider require 4 posts in a span.

Code	Price	H	W	D	Volume (ft <sup>3</sup> )	Weight (lb)
K-PO-24	155	24	0	5	0.1	1.41



This small post supports countertops and screens.

Small Vertical Aluminum Post

**Ordering Options:**

Use the following checklist to customize the finishes on your order:

- metal color

**Details:**

1. Large vertical aluminum posts support overheads and hutches.
2. Surfaces 54 inches and wider require 4 posts in a span.

Code	Price	H	W	D	Volume (ft <sup>3</sup> )	Weight (lb)
K-PS-08	71	8	0	2.5	0.08	0.24
K-PS-12	77	12	0	2.5	0.03	0.36
K-PS-16	80	16	0	2.5	0.04	0.48
K-PS-24	94	24	0	2.5	0.05	0.75
K-PS-32	111	32	0	2.5	0.07	0.95



Metro Collab  
August 2024  
**Electrics**

electrics

<u>power box</u>	162
<u>data box</u>	163
<u>electrical starter harness</u>	164
<u>electrical splitter harness</u>	165
<u>electrical harness</u>	166

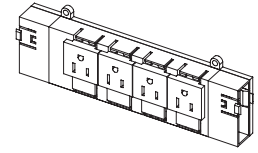

**Ordering Options:**

There are no ordering options for these items

Code	Price	H	W	D	Volume (ft <sup>3</sup> )	Weight (lb)
K-EM84-M	210	3	80	2	0.02	0.6

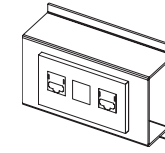

**Ordering Options:**

There are no ordering options for these items

Code	Price	H	W	D	Volume (ft <sup>3</sup> )	Weight (lb)
K-ECK1-M	178	3	4	1	0.02	0.6

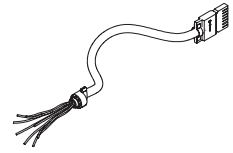

**Ordering Options:**

There are no ordering options for these items

Code	Price	H	W	D	Volume (ft <sup>3</sup> )	Weight (lb)
K-ES84-072	350	0	72	0	2.96	2.48
K-ES84-168	597	0	168	0	5.12	4.59

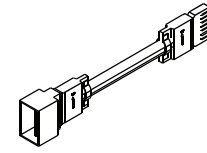

**Ordering Options:**

There are no ordering options for these items

Code	Price	H	W	D	Volume (ft <sup>3</sup> )	Weight (lb)
K-EX84-12	133	0	12	0	0.05	0.9

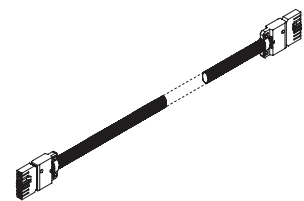

**Ordering Options:**

There are no ordering options for these items

Code	Price	H	W	D	Volume (ft <sup>3</sup> )	Weight (lb)
K-EH-22	205	0	22	0	0.6	0.7
K-EH-25	210	0	25	0	0.7	0.7
K-EH-28	216	0	28	0	0.8	0.7
K-EH-31	220	0	31	0	0.8	0.8
K-EH-34	231	0	34	0	0.9	0.8
K-EH-37	241	0	37	0	1	1
K-EH-40	244	0	40	0	1.1	1
K-EH-43	254	0	43	0	1.2	1.2
K-EH-46	264	0	46	0	1.3	1.5
K-EH-49	270	0	49	0	1.5	1.5
K-EH-52	279	0	52	0	1.5	1.6
K-EH-55	282	0	55	0	1.6	1.6
K-EH-58	293	0	58	0	1.7	1.8
K-EH-61	299	0	61	0	1.8	1.8
K-EH-64	305	0	64	0	1.9	1.9
K-EH-67	311	0	67	0	1.9	1.9
K-EH-70	324	0	70	0	2	1.95
K-EH-73	329	0	73	0	1.95	1.95
K-EH-76	335	0	76	0	2.04	2.12
K-EH-79	347	0	79	0	2.12	2.12
K-EH-82	350	0	82	0	2.12	2.37
K-EH-85	359	0	85	0	2.37	2.37
K-EH-88	370	0	88	0	2.37	2.37
K-EH-91	375	0	91	0	2.37	2.37

continued on next page

electrical harness continued [2 of 2]

Code	Price	H	W	D	Volume (ft <sup>3</sup> )	Weight (lb)
K-EH-94	383	0	94	0	2.53	2.53
K-EH-97	389	0	97	0	2.53	2.53
K-EH-100	400	0	100	0	2.7	2.7
K-EH-103	407	0	103	0	2.7	2.7
K-EH-106	414	0	106	0	2.86	2.86
K-EH-109	421	0	109	0	2.86	2.86
K-EH-112	428	0	112	0	3.03	3.03
K-EH-115	438	0	115	0	3.03	3.03
K-EH-118	444	0	118	0	3.19	3.36
K-EH-121	451	0	121	0	3.36	3.36
K-EH-124	458	0	124	0	3.36	3.46
K-EH-127	469	0	127	0	3.52	3.46
K-EH-130	473	0	130	0	3.52	3.56
K-EH-133	478	0	133	0	3.39	3.56
K-EH-136	489	0	136	0	3.68	3.76
K-EH-139	497	0	139	0	3.85	3.76
K-EH-142	502	0	142	0	3.85	3.86
K-EH-145	664	0	145	0	3.85	3.86
K-EH-148	669	0	148	0	3.85	3.86
K-EH-151	679	0	151	0	4.18	4.06
K-EH-154	685	0	154	0	4.26	4.06
K-EH-157	690	0	157	0	4.35	4.16
K-EH-160	697	0	160	0	4.43	4.16
K-EH-163	708	0	163	0	4.51	4.26
K-EH-166	714	0	166	0	4.59	4.26
K-EH-169	719	0	169	0	4.68	4.46
K-EH-172	730	0	172	0	4.76	4.46
K-EH-175	736	0	175	0	4.84	4.46
K-EH-178	741	0	178	0	4.92	4.66
K-EH-181	747	0	181	0	5.01	4.66





Metro Collab  
August 2024  
**Screens**

screens

<u>laminare screens</u>	170
<u>fabric screens</u>	175
<u>glazed screens</u>	180
<u>whiteboard screens</u>	185
<u>accessory screen</u>	189

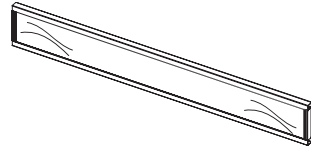

**Ordering Options:**

Use the following checklist to customize the finishes on your order:

- laminate color

**Details:**

1. Specify screen width to match surface width.
2. Surfaces 78 inches and wider require 2 screens and filler.

Code	Price	H	W	D	Volume (ft <sup>3</sup> )	Weight (lb.)
K-SL0-0418	48	4	18	0	0.02	1.2
K-SL0-0421	49	4	21	0	0.03	1.4
K-SL0-0424	51	4	24	0	0.03	1.6
K-SL0-0427	55	4	27	0	0.03	1.8
K-SL0-0430	58	4	30	0	0.04	2
K-SL0-0433	59	4	33	0	0.04	2.3
K-SL0-0436	60	4	36	0	0.05	2.5
K-SL0-0439	65	4	39	0	0.05	2.7
K-SL0-0442	67	4	42	0	0.06	2.9
K-SL0-0445	69	4	45	0	0.06	3.1
K-SL0-0448	71	4	48	0	0.07	3.3
K-SL0-0451	76	4	51	0	0.07	3.5
K-SL0-0454	77	4	54	0	0.08	3.7
K-SL0-0457	81	4	57	0	0.08	3.9

continued on next page

laminate screens 2 of 5 continued

Code	Price	H	W	D	Volume (ft <sup>3</sup> )	Weight (lb.)
K-SL0-0460	82	4	60	0	0.09	4.1
K-SL0-0463	86	4	63	0	0.09	4.3
K-SL0-0466	90	4	66	0	0.1	4.5
K-SL0-0469	90	4	69	0	0.1	4.7
K-SL0-0472	91	4	72	0	0.11	4.9
K-SL0-0804	37	8	4	0	0.01	1
K-SL0-0818	55	8	18	0	0.04	2.4
K-SL0-0821	59	8	21	0	0.06	2.8
K-SL0-0824	63	8	24	0	0.06	3.2
K-SL0-0827	67	8	27	0	0.06	3.6
K-SL0-0830	69	8	30	0	0.08	4
K-SL0-0833	72	8	33	0	0.08	4.6
K-SL0-0836	77	8	36	0	0.1	5
K-SL0-0839	81	8	39	0	0.1	5.4
K-SL0-0842	84	8	42	0	0.12	5.8
K-SL0-0845	88	8	45	0	0.12	6.2
K-SL0-0848	91	8	48	0	0.14	6.6
K-SL0-0851	94	8	51	0	0.14	7
K-SL0-0854	100	8	54	0	0.16	7.4
K-SL0-0857	105	8	57	0	0.16	7.8
K-SL0-0860	109	8	60	0	0.18	8.2
K-SL0-0863	112	8	63	0	0.18	8.6
K-SL0-0866	114	8	66	0	0.2	9
K-SL0-0869	120	8	69	0	0.2	9.4
K-SL0-0872	124	8	72	0	0.2	9.8
K-SL0-1204	41	12	4	0	0.01	1.1
K-SL0-1218	63	12	18	0	0.06	3.6
K-SL0-1221	68	12	21	0	0.09	4.2
K-SL0-1224	69	12	24	0	0.09	4.8
K-SL0-1227	77	12	27	0	0.09	5.4
K-SL0-1230	81	12	30	0	0.12	6

laminate screens 3 of 5 continued

Code	Price	H	W	D	Volume (ft³)	Weight (lb.)
K-SL0-1233	86	12	33	0	0.12	6.9
K-SL0-1236	91	12	36	0	0.15	7.5
K-SL0-1239	94	12	39	0	0.15	8.1
K-SL0-1242	101	12	42	0	0.18	8.7
K-SL0-1245	107	12	45	0	0.18	9.3
K-SL0-1248	112	12	48	0	0.21	9.9
K-SL0-1251	116	12	51	0	0.21	10.5
K-SL0-1254	123	12	54	0	0.24	11.1
K-SL0-1257	127	12	57	0	0.24	11.7
K-SL0-1260	131	12	60	0	0.27	12.3
K-SL0-1263	138	12	63	0	0.27	12.9
K-SL0-1266	143	12	66	0	0.3	13.5
K-SL0-1269	151	12	69	0	0.3	14.1
K-SL0-1272	154	12	72	0	0.33	14.7
K-SL0-1604	42	16	4	0	0.02	1.2
K-SL0-1618	69	16	18	0	0.08	4.8
K-SL0-1621	77	16	21	0	0.12	5.6
K-SL0-1624	81	16	24	0	0.12	6.4
K-SL0-1627	88	16	27	0	0.12	7.2
K-SL0-1630	93	16	30	0	0.16	8
K-SL0-1633	101	16	33	0	0.16	9.2
K-SL0-1636	107	16	36	0	0.2	10
K-SL0-1639	113	16	39	0	0.2	10.8
K-SL0-1642	120	16	42	0	0.24	11.6
K-SL0-1645	126	16	45	0	0.24	12.4
K-SL0-1648	131	16	48	0	0.28	13.2
K-SL0-1651	139	16	51	0	0.28	14
K-SL0-1654	148	16	54	0	0.32	14.8
K-SL0-1657	153	16	57	0	0.32	15.6
K-SL0-1660	158	16	60	0	0.36	16.4
K-SL0-1663	165	16	63	0	0.36	17.2

laminate screens 4 of 5 continued

Code	Price	H	W	D	Volume (ft³)	Weight (lb.)
K-SL0-1666	171	16	66	0	0.4	18
K-SL0-1669	178	16	69	0	0.4	18.8
K-SL0-1672	187	16	72	0	0.44	19.6
K-SL0-2004	47	20	4	0	0.03	1.4
K-SL0-2018	77	20	18	0	0.1	6
K-SL0-2021	86	20	21	0	0.15	7
K-SL0-2024	90	20	24	0	0.15	8
K-SL0-2027	100	20	27	0	0.15	9
K-SL0-2030	109	20	30	0	0.2	10
K-SL0-2033	114	20	33	0	0.2	11.5
K-SL0-2036	123	20	36	0	0.25	12.5
K-SL0-2039	129	20	39	0	0.25	13.5
K-SL0-2042	138	20	42	0	0.3	14.5
K-SL0-2045	148	20	45	0	0.3	15.5
K-SL0-2048	154	20	48	0	0.35	16.5
K-SL0-2051	161	20	51	0	0.35	17.5
K-SL0-2054	167	20	54	0	0.4	18.5
K-SL0-2057	176	20	57	0	0.4	19.5
K-SL0-2060	184	20	60	0	0.45	20.5
K-SL0-2063	193	20	63	0	0.45	21.5
K-SL0-2066	202	20	66	0	0.5	22.5
K-SL0-2069	210	20	69	0	0.5	23.5
K-SL0-2072	216	20	72	0	0.55	24.5
K-SL0-2404	48	24	4	0	0.03	1.6
K-SL0-2418	86	24	18	0	0.12	7.2
K-SL0-2421	94	24	21	0	0.18	8.4
K-SL0-2424	101	24	24	0	0.18	9.6
K-SL0-2427	112	24	27	0	0.18	10.8
K-SL0-2430	120	24	30	0	0.24	12
K-SL0-2433	128	24	33	0	0.24	13.8
K-SL0-2436	138	24	36	0	0.3	15

laminate screens 5 of 5 continued

Code	Price	H	W	D	Volume (ft³)	Weight (lb.)
K-SL0-2439	149	24	39	0	0.3	16.2
K-SL0-2442	155	24	42	0	0.36	17.4
K-SL0-2445	165	24	45	0	0.36	18.6
K-SL0-2448	174	24	48	0	0.42	19.8
K-SL0-2451	181	24	51	0	0.42	21
K-SL0-2454	193	24	54	0	0.48	22.2
K-SL0-2457	205	24	57	0	0.48	23.4
K-SL0-2460	212	24	60	0	0.54	24.6
K-SL0-2463	218	24	63	0	0.54	25.8
K-SL0-2466	230	24	66	0	0.6	27
K-SL0-2469	240	24	69	0	0.6	28.2
K-SL0-2472	246	24	72	0	0.66	29.4
K-SL0-3204	51	32	4	0	0.04	2.3
K-SL0-3218	102	32	18	0	0.16	9.6
K-SL0-3221	114	32	21	0	0.24	11.2
K-SL0-3224	124	32	24	0	0.24	12.8
K-SL0-3227	137	32	27	0	0.24	14.4
K-SL0-3230	149	32	30	0	0.32	16
K-SL0-3233	158	32	33	0	0.32	18.4
K-SL0-3236	170	32	36	0	0.4	20
K-SL0-3239	181	32	39	0	0.4	21.6
K-SL0-3242	193	32	42	0	0.48	23.2
K-SL0-3245	208	32	45	0	0.48	24.8
K-SL0-3248	216	32	48	0	0.56	26.4
K-SL0-3251	230	32	51	0	0.56	28
K-SL0-3254	241	32	54	0	0.64	29.6
K-SL0-3257	252	32	57	0	0.64	31.2
K-SL0-3260	264	32	60	0	0.72	32.8
K-SL0-3263	277	32	63	0	0.72	34.4
K-SL0-3266	286	32	66	0	0.8	36
K-SL0-3269	298	32	69	0	0.8	37.6
K-SL0-3272	307	32	72	0	0.88	39.2

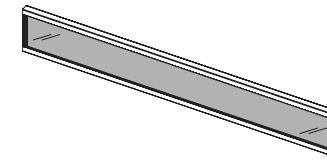

**Ordering Options:**

Use the following checklist to customize the finishes on your order:

- glazing

**Details:**

1. Specify screen width to match surface width.
2. Surfaces 78 inches and wider require 2 screens and filler.

Code	Price	H	W	D	Volume (ft³)	Weight (lb.)
K-SF0-0418	126	4	18	0	0.02	1.3
K-SF0-0421	127	4	21	0	0.03	1.4
K-SF0-0424	127	4	24	0	0.03	1.5
K-SF0-0427	128	4	27	0	0.03	1.6
K-SF0-0430	129	4	30	0	0.04	1.7
K-SF0-0433	131	4	33	0	0.04	1.8
K-SF0-0436	133	4	36	0	0.05	1.8
K-SF0-0439	137	4	39	0	0.05	1.9
K-SF0-0442	154	4	42	0	0.06	2
K-SF0-0445	155	4	45	0	0.06	2.1
K-SF0-0448	158	4	48	0	0.07	2.2
K-SF0-0451	158	4	51	0	0.07	2.3
K-SF0-0454	161	4	54	0	0.08	2.3
K-SF0-0457	163	4	57	0	0.08	2.4
K-SF0-0460	165	4	60	0	0.09	2.5

continued on next page

**fabric screens 2 of 5 continued**

Code	Price	H	W	D	Volume (ft³)	Weight (lb.)
K-SF0-0463	166	4	63	0	0.09	2.6
K-SF0-0466	167	4	66	0	0.1	2.7
K-SF0-0469	170	4	69	0	0.1	2.8
K-SF0-0472	171	4	72	0	0.11	2.8
K-SF0-0804	116	8	4	0	0.01	0.7
K-SF0-0818	141	8	18	0	0.04	2.7
K-SF0-0821	143	8	21	0	0.06	2.9
K-SF0-0824	143	8	24	0	0.06	3
K-SF0-0827	149	8	27	0	0.06	3.2
K-SF0-0830	151	8	30	0	0.08	3.3
K-SF0-0833	152	8	33	0	0.08	3.5
K-SF0-0836	153	8	36	0	0.1	3.7
K-SF0-0839	154	8	39	0	0.1	3.9
K-SF0-0842	187	8	42	0	0.12	4
K-SF0-0845	189	8	45	0	0.12	4.2
K-SF0-0848	191	8	48	0	0.14	4.3
K-SF0-0851	191	8	51	0	0.14	4.5
K-SF0-0854	193	8	54	0	0.16	4.7
K-SF0-0857	197	8	57	0	0.16	4.9
K-SF0-0860	201	8	60	0	0.18	5
K-SF0-0863	202	8	63	0	0.18	5.2
K-SF0-0866	205	8	66	0	0.2	5.3
K-SF0-0869	208	8	69	0	0.2	5.5
K-SF0-0872	209	8	72	0	0.22	5.7
K-SF0-1204	117	12	4	0	0.01	1
K-SF0-1218	155	12	18	0	0.06	4
K-SF0-1221	158	12	21	0	0.09	4.3
K-SF0-1224	158	12	24	0	0.09	4.5
K-SF0-1227	163	12	27	0	0.09	4.8
K-SF0-1230	165	12	30	0	0.12	5
K-SF0-1233	166	12	33	0	0.12	5.3

**fabric screens 3 of 5 continued**

Code	Price	H	W	D	Volume (ft³)	Weight (lb.)
K-SF0-1236	167	12	36	0	0.15	5.5
K-SF0-1239	171	12	39	0	0.15	5.8
K-SF0-1242	217	12	42	0	0.18	6
K-SF0-1245	218	12	45	0	0.18	6.3
K-SF0-1248	220	12	48	0	0.21	6.5
K-SF0-1251	220	12	51	0	0.21	6.8
K-SF0-1254	228	12	54	0	0.24	7
K-SF0-1257	231	12	57	0	0.24	7.3
K-SF0-1260	233	12	60	0	0.27	7.5
K-SF0-1263	234	12	63	0	0.27	7.8
K-SF0-1266	240	12	66	0	0.3	8
K-SF0-1269	241	12	69	0	0.3	8.3
K-SF0-1272	243	12	72	0	0.33	8.5
K-SF0-1604	117	16	4	0	0.02	1.3
K-SF0-1618	171	16	18	0	0.08	5.3
K-SF0-1621	175	16	21	0	0.12	5.7
K-SF0-1624	175	16	24	0	0.12	6
K-SF0-1627	178	16	27	0	0.12	6.4
K-SF0-1630	179	16	30	0	0.16	6.7
K-SF0-1633	184	16	33	0	0.16	7.1
K-SF0-1636	187	16	36	0	0.2	7.3
K-SF0-1639	190	16	39	0	0.2	7.7
K-SF0-1642	248	16	42	0	0.24	8
K-SF0-1645	252	16	45	0	0.24	8.4
K-SF0-1648	259	16	48	0	0.28	8.7
K-SF0-1651	260	16	51	0	0.28	9.1
K-SF0-1654	261	16	54	0	0.32	9.3
K-SF0-1657	265	16	57	0	0.32	9.7
K-SF0-1660	270	16	60	0	0.36	10
K-SF0-1663	271	16	63	0	0.36	10.4
K-SF0-1666	275	16	66	0	0.4	10.7

**fabric screens 4 of 5 continued**

Code	Price	H	W	D	Volume (ft³)	Weight (lb.)
K-SF0-1669	279	16	69	0	0.4	11.1
K-SF0-1672	281	16	72	0	0.44	11.3
K-SF0-2004	120	20	4	0	0.03	1.4
K-SF0-2018	189	20	18	0	0.1	6.7
K-SF0-2021	191	20	21	0	0.15	7.2
K-SF0-2024	191	20	24	0	0.15	7.5
K-SF0-2027	194	20	27	0	0.15	8
K-SF0-2030	201	20	30	0	0.2	8.3
K-SF0-2033	205	20	33	0	0.2	8.8
K-SF0-2036	208	20	36	0	0.25	9.2
K-SF0-2039	209	20	39	0	0.25	9.7
K-SF0-2042	284	20	42	0	0.3	10
K-SF0-2045	287	20	45	0	0.3	10.5
K-SF0-2048	293	20	48	0	0.35	10.8
K-SF0-2051	295	20	51	0	0.35	11.3
K-SF0-2054	296	20	54	0	0.4	11.7
K-SF0-2057	299	20	57	0	0.4	12.2
K-SF0-2060	303	20	60	0	0.45	12.5
K-SF0-2063	306	20	63	0	0.45	13
K-SF0-2066	311	20	66	0	0.5	13.3
K-SF0-2069	317	20	69	0	0.5	13.8
K-SF0-2072	319	20	72	0	0.55	14.2
K-SF0-2404	120	24	4	0	0.03	2
K-SF0-2418	207	24	18	0	0.12	8
K-SF0-2421	209	24	21	0	0.18	8.6
K-SF0-2424	209	24	24	0	0.18	9
K-SF0-2427	213	24	27	0	0.18	9.6
K-SF0-2430	216	24	30	0	0.24	10
K-SF0-2433	218	24	33	0	0.24	10.6
K-SF0-2436	220	24	36	0	0.3	11
K-SF0-2439	228	24	39	0	0.3	11.6

**fabric screens 5 of 5 continued**

Code	Price	H	W	D	Volume (ft³)	Weight (lb.)
K-SF0-2442	319	24	42	0	0.36	12
K-SF0-2445	323	24	45	0	0.36	12.6
K-SF0-2448	325	24	48	0	0.42	13
K-SF0-2451	329	24	51	0	0.42	13.6
K-SF0-2454	333	24	54	0	0.48	14
K-SF0-2457	336	24	57	0	0.48	14.6
K-SF0-2460	340	24	60	0	0.54	15
K-SF0-2463	345	24	63	0	0.54	15.6
K-SF0-2466	348	24	66	0	0.6	16
K-SF0-2469	350	24	69	0	0.6	26.6
K-SF0-2472	357	24	72	0	0.66	17
K-SF0-3204	124	32	4	0	0.04	2.7
K-SF0-3218	237	32	18	0	0.16	10.7
K-SF0-3221	242	32	21	0	0.24	11.5
K-SF0-3224	243	32	24	0	0.24	12
K-SF0-3227	246	32	27	0	0.24	12.8
K-SF0-3230	252	32	30	0	0.32	13.3
K-SF0-3233	259	32	33	0	0.32	14.1
K-SF0-3236	261	32	36	0	0.4	14.7
K-SF0-3239	265	32	39	0	0.4	15.5
K-SF0-3242	385	32	42	0	0.48	16
K-SF0-3245	387	32	45	0	0.48	16.8
K-SF0-3248	395	32	48	0	0.56	17.3
K-SF0-3251	398	32	51	0	0.56	18.1
K-SF0-3254	401	32	54	0	0.64	18.7
K-SF0-3257	407	32	57	0	0.64	19.5
K-SF0-3260	412	32	60	0	0.72	20
K-SF0-3263	416	32	63	0	0.72	20.8
K-SF0-3266	421	32	66	0	0.8	21.3
K-SF0-3269	423	32	69	0	0.8	22.1
K-SF0-3272	428	32	72	0	0.88	22.7

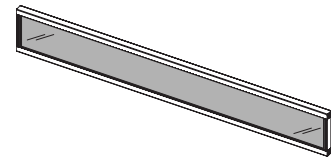

**Ordering Options:**

Use the following checklist to customize the finishes on your order:

- glazing color

**Details:**

1. Specify screen width to match surface width.
2. Surfaces 78 inches and wider require 2 screens and filler.

Code	Price	H	W	D	Volume (ft <sup>3</sup> )	Weight (lb.)
K-SG0-0418	153	4	18	0	0.02	0.8
K-SG0-0421	165	4	21	0	0.03	0.9
K-SG0-0424	176	4	24	0	0.03	0.98
K-SG0-0427	191	4	27	0	0.03	1.1
K-SG0-0430	207	4	30	0	0.04	1.23
K-SG0-0433	216	4	33	0	0.04	1.3
K-SG0-0436	231	4	36	0	0.05	1.47
K-SG0-0439	243	4	39	0	0.05	1.6
K-SG0-0442	259	4	42	0	0.06	1.72
K-SG0-0445	271	4	45	0	0.06	1.8
K-SG0-0448	282	4	48	0	0.07	1.96
K-SG0-0451	296	4	51	0	0.07	2.1
K-SG0-0454	307	4	54	0	0.08	2.21
K-SG0-0457	324	4	57	0	0.08	2.3
K-SG0-0460	336	4	60	0	0.09	2.45

continued on next page

glazed screens 2 of 5 continued

Code	Price	H	W	D	Volume (ft <sup>3</sup> )	Weight (lb.)
K-SG0-0463	350	4	63	0	0.09	2.6
K-SG0-0466	363	4	66	0	0.1	2.8
K-SG0-0469	379	4	69	0	0.1	3
K-SG0-0472	388	4	72	0	0.11	3.2
K-SG0-0804	56	8	4	0	0.01	0.4
K-SG0-0818	171	8	18	0	0.04	1.6
K-SG0-0821	190	8	21	0	0.06	1.8
K-SG0-0824	209	8	24	0	0.06	1.96
K-SG0-0827	222	8	27	0	0.06	2.2
K-SG0-0830	243	8	30	0	0.08	2.46
K-SG0-0833	261	8	33	0	0.08	2.6
K-SG0-0836	280	8	36	0	0.1	2.94
K-SG0-0839	296	8	39	0	0.1	3.2
K-SG0-0842	317	8	42	0	0.12	3.44
K-SG0-0845	333	8	45	0	0.12	3.6
K-SG0-0848	350	8	48	0	0.14	3.92
K-SG0-0851	368	8	51	0	0.14	4.2
K-SG0-0854	387	8	54	0	0.16	4.42
K-SG0-0857	407	8	57	0	0.16	4.6
K-SG0-0860	423	8	60	0	0.18	4.9
K-SG0-0863	443	8	63	0	0.18	5.2
K-SG0-0866	458	8	66	0	0.2	5.6
K-SG0-0869	477	8	69	0	0.2	6
K-SG0-0872	497	8	72	0	0.22	6.4
K-SG0-1204	63	12	4	0	0.01	0.6
K-SG0-1218	193	12	18	0	0.06	2.4
K-SG0-1221	214	12	21	0	0.09	2.7
K-SG0-1224	240	12	24	0	0.09	2.94
K-SG0-1227	261	12	27	0	0.09	3.3
K-SG0-1230	284	12	30	0	0.12	3.69
K-SG0-1233	305	12	33	0	0.12	3.9

glazed screens 3 of 5 continued

Code	Price	H	W	D	Volume (ft³)	Weight (lb.)
K-SG0-1236	329	12	36	0	0.15	4.41
K-SG0-1239	353	12	39	0	0.15	4.8
K-SG0-1242	372	12	42	0	0.18	5.16
K-SG0-1245	398	12	45	0	0.18	5.4
K-SG0-1248	421	12	48	0	0.21	5.88
K-SG0-1251	443	12	51	0	0.21	6.3
K-SG0-1254	466	12	54	0	0.24	6.63
K-SG0-1257	489	12	57	0	0.24	6.9
K-SG0-1260	511	12	60	0	0.27	7.35
K-SG0-1263	534	12	63	0	0.27	7.8
K-SG0-1266	559	12	66	0	0.3	8.4
K-SG0-1269	579	12	69	0	0.3	9
K-SG0-1272	603	12	72	0	0.33	9.6
K-SG0-1604	71	16	4	0	0.02	0.8
K-SG0-1618	233	16	18	0	0.08	3.2
K-SG0-1621	261	16	21	0	0.12	3.6
K-SG0-1624	287	16	24	0	0.12	3.92
K-SG0-1627	317	16	27	0	0.12	4.4
K-SG0-1630	345	16	30	0	0.16	4.92
K-SG0-1633	370	16	33	0	0.16	5.2
K-SG0-1636	398	16	36	0	0.2	5.88
K-SG0-1639	426	16	39	0	0.2	6.4
K-SG0-1642	453	16	42	0	0.24	6.88
K-SG0-1645	478	16	45	0	0.24	7.2
K-SG0-1648	509	16	48	0	0.28	7.84
K-SG0-1651	534	16	51	0	0.28	8.4
K-SG0-1654	563	16	54	0	0.32	8.84
K-SG0-1657	589	16	57	0	0.32	9.2
K-SG0-1660	618	16	60	0	0.36	9.8
K-SG0-1663	644	16	63	0	0.36	10.4
K-SG0-1666	671	16	66	0	0.4	11.2

glazed screens 4 of 5 continued

Code	Price	H	W	D	Volume (ft³)	Weight (lb.)
K-SG0-1669	701	16	69	0	0.4	12
K-SG0-1672	727	16	72	0	0.44	12.8
K-SG0-2004	80	20	4	0	0.03	0.9
K-SG0-2018	234	20	18	0	0.1	4
K-SG0-2021	270	20	21	0	0.15	4.5
K-SG0-2024	299	20	24	0	0.15	4.9
K-SG0-2027	333	20	27	0	0.15	5.5
K-SG0-2030	364	20	30	0	0.2	6.15
K-SG0-2033	398	20	33	0	0.2	6.5
K-SG0-2036	428	20	36	0	0.25	7.35
K-SG0-2039	459	20	39	0	0.25	8
K-SG0-2042	496	20	42	0	0.3	8.6
K-SG0-2045	526	20	45	0	0.3	9
K-SG0-2048	561	20	48	0	0.35	9.8
K-SG0-2051	589	20	51	0	0.35	10.5
K-SG0-2054	622	20	54	0	0.4	11.05
K-SG0-2057	654	20	57	0	0.4	11.5
K-SG0-2060	688	20	60	0	0.45	12.25
K-SG0-2063	719	20	63	0	0.45	13
K-SG0-2066	750	20	66	0	0.5	14
K-SG0-2069	784	20	69	0	0.5	15
K-SG0-2072	817	20	72	0	0.55	16
K-SG0-2404	86	24	4	0	0.03	0.98
K-SG0-2418	258	24	18	0	0.12	4.8
K-SG0-2421	294	24	21	0	0.18	5.4
K-SG0-2424	330	24	24	0	0.18	5.88
K-SG0-2427	366	24	27	0	0.18	6.6
K-SG0-2430	405	24	30	0	0.24	7.38
K-SG0-2433	443	24	33	0	0.24	7.8
K-SG0-2436	477	24	36	0	0.3	8.82
K-SG0-2439	513	24	39	0	0.3	9.6



glazed screens 5 of 5 continued

Code	Price	H	W	D	Volume (ft³)	Weight (lb.)
K-SG0-2442	552	24	42	0	0.36	10.32
K-SG0-2445	586	24	45	0	0.36	10.8
K-SG0-2448	628	24	48	0	0.42	11.76
K-SG0-2451	665	24	51	0	0.42	12.6
K-SG0-2454	697	24	54	0	0.48	13.26
K-SG0-2457	738	24	57	0	0.48	13.8
K-SG0-2460	777	24	60	0	0.54	14.7
K-SG0-2463	812	24	63	0	0.54	15.6
K-SG0-2466	849	24	66	0	0.6	16.8
K-SG0-2469	886	24	69	0	0.6	18
K-SG0-2472	923	24	72	0	0.66	19.2
K-SG0-3204	101	32	4	0	0.04	1.3
K-SG0-3218	298	32	18	0	0.16	6.4
K-SG0-3221	347	32	21	0	0.24	7.2
K-SG0-3224	389	32	24	0	0.24	7.84
K-SG0-3227	439	32	27	0	0.24	8.8
K-SG0-3230	487	32	30	0	0.32	9.84
K-SG0-3233	531	32	33	0	0.32	10.4
K-SG0-3236	578	32	36	0	0.4	11.76
K-SG0-3239	625	32	39	0	0.4	12.8
K-SG0-3242	669	32	42	0	0.48	13.76
K-SG0-3245	718	32	45	0	0.48	14.4
K-SG0-3248	760	32	48	0	0.56	15.68
K-SG0-3251	811	32	51	0	0.56	16.8
K-SG0-3254	858	32	54	0	0.64	17.68
K-SG0-3257	902	32	57	0	0.64	18.4
K-SG0-3260	951	32	60	0	0.72	19.6
K-SG0-3263	997	32	63	0	0.72	20.8
K-SG0-3266	1042	32	66	0	0.8	22.4
K-SG0-3269	1091	32	69	0	0.8	24
K-SG0-3272	1140	32	72	0	0.88	25.6

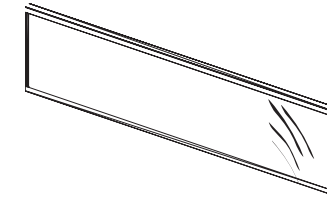

Ordering Options:

There are no ordering options for this item.

Details:

1. Specify screen width to match surface width.
2. Surfaces 78 inches and wider require 2 screens and filler.

Code	Price	H	W	D	Volume (ft³)	Weight (lb.)
K-SW0-0818	89	8	18	0	0.04	2.4
K-SW0-0821	94	8	21	0	0.06	2.8
K-SW0-0824	102	8	24	0	0.06	3.2
K-SW0-0827	107	8	27	0	0.06	3.6
K-SW0-0830	113	8	30	0	0.08	4
K-SW0-0833	119	8	33	0	0.08	4.6
K-SW0-0836	126	8	36	0	0.1	5
K-SW0-0839	131	8	39	0	0.1	5.4
K-SW0-0842	139	8	42	0	0.12	5.8
K-SW0-0845	141	8	45	0	0.12	6.2
K-SW0-0848	146	8	48	0	0.14	6.6
K-SW0-0851	154	8	51	0	0.14	7
K-SW0-0854	158	8	54	0	0.16	7.4
K-SW0-0857	165	8	57	0	0.16	7.8
K-SW0-0860	172	8	60	0	0.18	8.2
K-SW0-0863	177	8	63	0	0.18	8.6
K-SW0-0866	187	8	66	0	0.2	9
K-SW0-0869	191	8	69	0	0.2	9.4

continued on next page

whiteboard screens 2 of 4 continued

Code	Price	H	W	D	Volume (ft³)	Weight (lb.)
K-SW0-0872	194	8	72	0	0.22	9.8
K-SW0-1218	101	12	18	0	0.06	3.6
K-SW0-1221	107	12	21	0	0.09	4.2
K-SW0-1224	114	12	24	0	0.09	4.8
K-SW0-1227	124	12	27	0	0.09	5.4
K-SW0-1230	131	12	30	0	0.12	6
K-SW0-1233	140	12	33	0	0.12	6.9
K-SW0-1236	144	12	36	0	0.15	7.5
K-SW0-1239	154	12	39	0	0.15	8.1
K-SW0-1242	162	12	42	0	0.18	8.7
K-SW0-1245	171	12	45	0	0.18	9.3
K-SW0-1248	179	12	48	0	0.21	9.9
K-SW0-1251	190	12	51	0	0.21	10.5
K-SW0-1254	194	12	54	0	0.24	11.1
K-SW0-1257	205	12	57	0	0.24	11.7
K-SW0-1260	212	12	60	0	0.27	12.3
K-SW0-1263	219	12	63	0	0.27	12.9
K-SW0-1266	231	12	66	0	0.3	13.5
K-SW0-1269	240	12	69	0	0.3	14.1
K-SW0-1272	247	12	72	0	0.33	14.7
K-SW0-1618	109	16	18	0	0.08	4.8
K-SW0-1621	119	16	21	0	0.12	5.6
K-SW0-1624	131	16	24	0	0.12	6.4
K-SW0-1627	140	16	27	0	0.12	7.2
K-SW0-1630	152	16	30	0	0.16	8
K-SW0-1633	159	16	33	0	0.16	9.2
K-SW0-1636	171	16	36	0	0.2	10
K-SW0-1639	179	16	39	0	0.2	10.8
K-SW0-1642	191	16	42	0	0.24	11.6
K-SW0-1645	200	16	45	0	0.24	12.4
K-SW0-1648	212	16	48	0	0.28	13.2
K-SW0-1651	223	16	51	0	0.28	14

whiteboard screens3 of 4 continued

Code	Price	H	W	D	Volume (ft³)	Weight (lb.)
K-SW0-1654	232	16	54	0	0.32	14.8
K-SW0-1657	243	16	57	0	0.32	15.6
K-SW0-1660	258	16	60	0	0.36	16.4
K-SW0-1663	267	16	63	0	0.36	17.2
K-SW0-1666	275	16	66	0	0.4	18
K-SW0-1669	289	16	69	0	0.4	18.8
K-SW0-1672	300	16	72	0	0.44	19.6
K-SW0-2018	119	20	18	0	0.1	6
K-SW0-2021	136	20	21	0	0.15	7
K-SW0-2024	142	20	24	0	0.15	8
K-SW0-2027	154	20	27	0	0.15	9
K-SW0-2030	166	20	30	0	0.2	10
K-SW0-2033	184	20	33	0	0.2	11.5
K-SW0-2036	194	20	36	0	0.25	12.5
K-SW0-2039	207	20	39	0	0.25	13.5
K-SW0-2042	218	20	42	0	0.3	14.5
K-SW0-2045	232	20	45	0	0.3	15.5
K-SW0-2048	243	20	48	0	0.35	16.5
K-SW0-2051	261	20	51	0	0.35	17.5
K-SW0-2054	269	20	54	0	0.4	18.5
K-SW0-2057	283	20	57	0	0.4	19.5
K-SW0-2060	299	20	60	0	0.45	20.5
K-SW0-2063	307	20	63	0	0.45	21.5
K-SW0-2066	325	20	66	0	0.5	22.5
K-SW0-2069	340	20	69	0	0.5	23.5
K-SW0-2072	351	20	72	0	0.55	24.5
K-SW0-2418	131	24	18	0	0.12	7.2
K-SW0-2421	142	24	21	0	0.18	8.4
K-SW0-2424	158	24	24	0	0.18	9.6
K-SW0-2427	172	24	27	0	0.18	10.8
K-SW0-2430	190	24	30	0	0.24	12
K-SW0-2433	205	24	33	0	0.24	13.8

whiteboard screens 4 of 4 continued

Code	Price	H	W	D	Volume (ft³)	Weight (lb.)
K-SW0-2436	217	24	36	0	0.3	15
K-SW0-2439	232	24	39	0	0.3	16.2
K-SW0-2442	252	24	42	0	0.36	17.4
K-SW0-2445	265	24	45	0	0.36	18.6
K-SW0-2448	275	24	48	0	0.42	19.8
K-SW0-2451	294	24	51	0	0.42	21
K-SW0-2454	306	24	54	0	0.48	22.2
K-SW0-2457	325	24	57	0	0.48	23.4
K-SW0-2460	341	24	60	0	0.54	24.6
K-SW0-2463	357	24	63	0	0.54	25.8
K-SW0-2466	371	24	66	0	0.6	27
K-SW0-2469	385	24	69	0	0.6	28.2
K-SW0-2472	405	24	72	0	0.66	29.4
K-SW0-3218	152	32	18	0	0.16	9.6
K-SW0-3221	166	32	21	0	0.24	11.2
K-SW0-3224	188	32	24	0	0.24	12.8
K-SW0-3227	209	32	27	0	0.24	14.4
K-SW0-3230	225	32	30	0	0.32	16
K-SW0-3233	247	32	33	0	0.32	18.4
K-SW0-3236	267	32	36	0	0.4	20
K-SW0-3239	287	32	39	0	0.4	21.6
K-SW0-3242	305	32	42	0	0.48	23.2
K-SW0-3245	328	32	45	0	0.48	24.8
K-SW0-3248	346	32	48	0	0.56	26.4
K-SW0-3251	366	32	51	0	0.56	28
K-SW0-3254	383	32	54	0	0.64	29.6
K-SW0-3257	406	32	57	0	0.64	31.2
K-SW0-3260	424	32	60	0	0.72	32.8
K-SW0-3263	446	32	63	0	0.72	34.4
K-SW0-3266	463	32	66	0	0.8	36
K-SW0-3269	485	32	69	0	0.8	37.6
K-SW0-3272	505	32	72	0	0.88	39.2

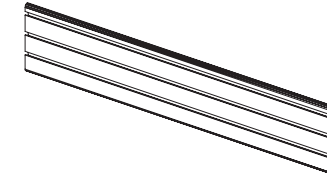

Ordering Options:

Use the following checklist to customize the finishes on your order:

- Metal color

Details:

- Specify screen width to match surface width.
- Surfaces 78 inches and wider require 2 screens and filler.

Code	Price	H	W	D	Volume (ft³)	Weight (lb.)
K-SA0-0818	100	8	18	0	0.05	1.3
K-SA0-0821	109	8	21	0	0.06	1.7
K-SA0-0824	117	8	24	0	0.07	1.96
K-SA0-0827	128	8	27	0	0.08	2.3
K-SA0-0830	139	8	30	0	0.09	2.45
K-SA0-0833	152	8	33	0	0.1	2.7
K-SA0-0836	158	8	36	0	0.1	2.94
K-SA0-0839	170	8	39	0	0.11	3.3
K-SA0-0842	179	8	42	0	0.12	3.43
K-SA0-0845	191	8	45	0	0.13	3.6
K-SA0-0848	202	8	48	0	0.14	3.92
K-SA0-0851	212	8	51	0	0.15	4.2
K-SA0-0854	219	8	54	0	0.16	4.41
K-SA0-0857	231	8	57	0	0.17	4.7
K-SA0-0860	243	8	60	0	0.18	4.9
K-SA0-0863	252	8	63	0	0.19	5.1
K-SA0-0866	264	8	66	0	2	5.4
K-SA0-0869	275	8	69	0	2.1	5.7
K-SA0-0872	284	8	72	0	2.2	6



Metro Collab  
August 2024  
**Counter Tops**

counter tops

<u>glass</u>	192
<u>laminate 1.5 inch</u>	193
<u>boat laminate 1 inch</u>	194
<u>straight laminate 1 inch</u>	195

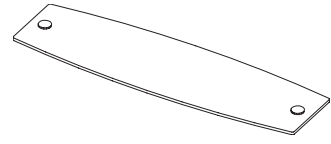

Glass, 3/8 inch

**Ordering Options:**

**Details:**

1. Tempered glass counter tops.
2. Counter tops 54 inches and wider are supported with 4 small posts.
3. Counter tops 48 inches and smaller supported by 2 small posts.

Code	Price	H	W	D	Volume (ft <sup>3</sup> )	Weight (lb)
K-WTG-1221	586	0.37	21	12	0.2	15
K-WTG-1224	708	0.37	24	12	0.2	18
K-WTG-1230	770	0.37	30	12	0.3	21
K-WTG-1236	829	0.37	36	12	0.3	24
K-WTG-1242	886	0.37	42	12	0.4	30
K-WTG-1248	947	0.37	48	12	0.4	30
K-WTG-1254	1100	0.37	54	12	0.5	33
K-WTG-1260	1158	0.37	60	12	0.5	36
K-WTG-1266	1219	0.37	66	12	0.6	39
K-WTG-1272	1279	0.37	72	12	0.6	42

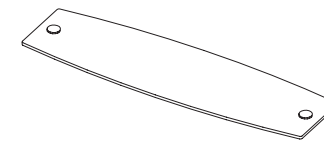

Laminate 1.5 inch

**Ordering Options:**

Use the following checklist to customize the finishes on your order:

- laminate color
- trim profile, 1.5 inches
- metal color

**Details:**

1. Laminate counter tops.
2. Counter tops 54 inches and wider are supported with 4 small posts.
3. Counter tops 48 inches and smaller supported by 2 small posts.

Code	Price	H	W	D	Volume (ft <sup>3</sup> )	Weight (lb)
K-WTL-1221	293	1.5	21	12	0.2	12
K-WTL-1224	299	1.5	24	12	0.2	14
K-WTL-1230	318	1.5	30	12	0.3	17
K-WTL-1236	335	1.5	36	12	0.3	20
K-WTL-1242	353	1.5	42	12	0.4	23
K-WTL-1248	370	1.5	48	12	0.4	26
K-WTL-1254	386	1.5	54	12	0.5	29
K-WTL-1260	405	1.5	60	12	0.5	33
K-WTL-1266	423	1.5	66	12	0.6	36
K-WTL-1272	440	1.5	72	12	0.6	39

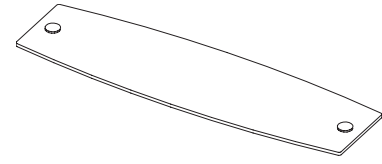

Boat, 1 inch

**Ordering Options:**

Use the following checklist to customize the finishes on your order:

- laminate color
- trim profile 1 inch
- metal color

**Details:**

1. Laminate counter tops.
2. Counter tops 54 inches and wider are supported with 4 small posts.
3. Counter tops 48 inches and smaller supported by 2 small posts.

Code	Price	H	W	D	Volume (ft <sup>3</sup> )	Weight (lb)
KL-WTL-1221	280	1	21	12	0.2	8
KL-WTL-1224	286	1	24	12	0.2	9
KL-WTL-1230	298	1	30	12	0.3	11
KL-WTL-1236	316	1	36	12	0.3	13
KL-WTL-1242	328	1	42	12	0.4	15
KL-WTL-1248	340	1	48	12	0.4	17
KL-WTL-1254	354	1	54	12	0.5	19
KL-WTL-1260	368	1	60	12	0.5	22
KL-WTL-1266	383	1	66	12	0.6	24
KL-WTL-1272	398	1.5	72	12	0.6	26

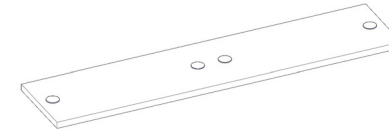

Straight 1 inch

**Ordering Options:**

Use the following checklist to customize the finishes on your order:

- laminate color
- trim profile, 1 inch
- metal color

**Details:**

1. Laminate counter tops.
2. Counter tops 54 inches and wider are supported with 4 small posts.
3. Counter tops 48 inches and smaller supported by 2 small posts.

Code	Price	H	W	D	Volume (ft <sup>3</sup> )	Weight (lb)
KL-WTLS-1221	281	1.5	21	12	0	3.6
KL-WTLS-1224	286	1.5	24	12	0	4.1
KL-WTLS-1230	298	1.5	30	12	0	4.5
KL-WTLS-1236	316	1.5	36	12	0	4.9
KL-WTLS-1242	328	1.5	42	12	0	5.3
KL-WTLS-1245	336	1.5	45	12	0	5.5
KL-WTLS-1248	342	1.5	48	12	0	5.7
KL-WTLS-1254	354	1.5	54	12	0	6.1
KL-WTLS-1260	369	1.5	60	12	0	6.5
KL-WTLS-1266	383	1.5	66	12	0	6.9
KL-WTLS-1272	400	1.5	72	12	0	7.3



Metro Collab  
August 2024  
**Wire  
Management**

wire management

<u>vertical wire manager</u>	198
<u>horizontal wire manager</u>	199
<u>wire clip</u>	200



**Ordering Options:**

There are no ordering options for these items

Code	Price	H	W	D	Volume (ft <sup>3</sup> )	Weight (lb)
V-EE00	318	28	4	4	0.25	1

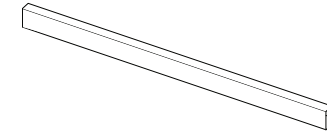

**Ordering Options:**

There are no ordering options for these items

Code	Price	H	W	D	Volume (ft <sup>3</sup> )	Weight (lb)
V-EWHB-12	8	0	12	0	0.25	0.15
V-EWHB-24	16	0	24	0	0.25	0.35
V-EWHB-36	23	0	36	0	0.25	0.55



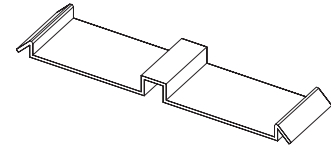

**Ordering Options:**

There are no ordering options for these items

Code	Price	H	W	D	Volume (ft <sup>3</sup> )	Weight (lb)
V-EE00	318	28	4	4	0.25	1



Metro Collab  
August 2024  
**Accessories**

accessories

<u>keyboard tray</u>	204
<u>work organizer</u>	205
<u>monitor arm</u>	206
<u>task light</u>	207

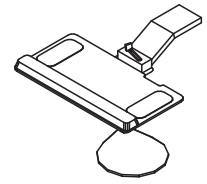

Articulating Keyboard Tray w/Mouse Tray

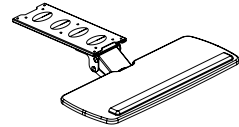

Articulating Keyboard Tray

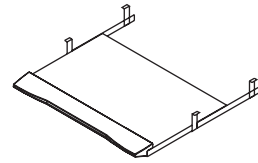

Retractable Laminate Keyboard Tray

**What's Included:**

Keyboard Tray, installation hardware.

**How to Specify:**

Specify laminate color for retractable keyboard. The vinyl trim color will default to match the laminate color unless otherwise specified. See the laminate finish card for details.

For articulating keyboard with mouse, right or left hand must be specified.

The articulating keyboards are available only in black.

**Notes:**

Keyboard trays provide adjustable ergonomic support for individuals in multi-task environments

**Options:**

Finish: laminate colors (retractable keyboard only)

Hand: **R** right **L** left (for adjustable keyboard with mouse only)

Code	Price	H	W	D	Volume (ft <sup>3</sup> )	Weight (lb)
Articulating Keyboard Tray w/Mouse Tray						
V-KAS0-2011-L	629	0	20	11	0.83	3
V-KAS0-2011-R	629	0	20	11	0.83	3
Articulating Keyboard Tray						
V-KASX-2510	403	0	25	10	0	15
Retractable Laminate Keyboard Tray						
V-KRS0-2516	264	0	25	16	1.34	12

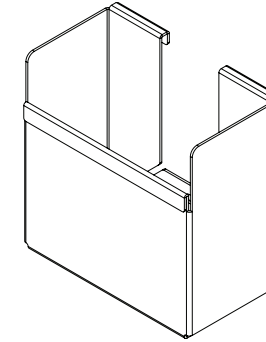

pencil holder

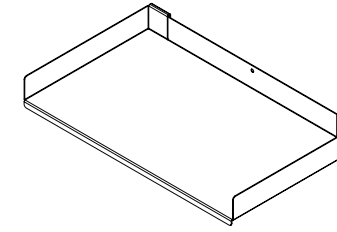

paper tray - legal

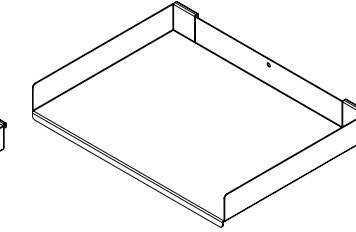

paper tray - letter

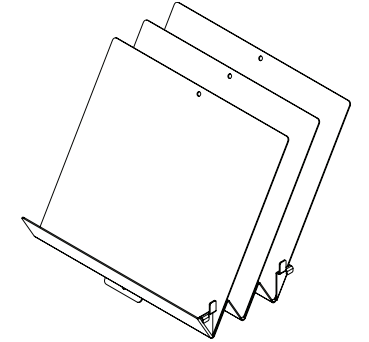

document sorter

**Ordering Options:**

Use the following checklist to customize the finishes on your order:

- metal color

**Details:**

Work organizers facilitate paper management and storage and easily hang on to accessory screens.

Code	Price	H	W	D	Weight (lb.)	Volume (ft <sup>3</sup> )
pencil holder						
F-AAH	82	0	0	0	0.1	0.7
paper tray - legal						
F-AAP-13	102	0	15	10	3.2	0.1
paper tray - letter						
F-AAP-9	90	0	12	10	3.2	0.1
document sorter						
F-AAS	181	0	0	0	2.5	0.1

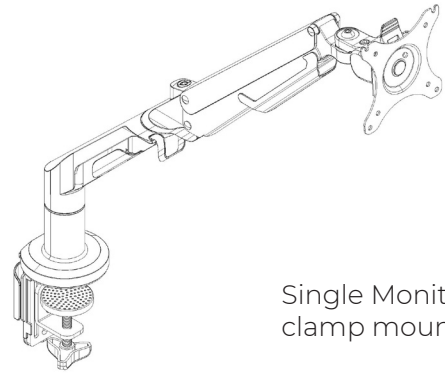

Single Monitor Arm - clamp mount

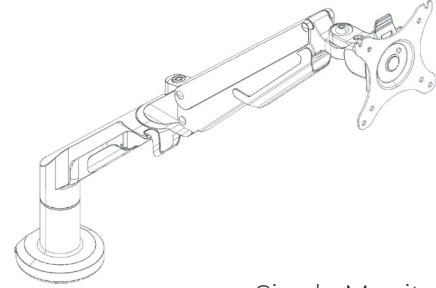

Single Monitor Arm - grommet mount

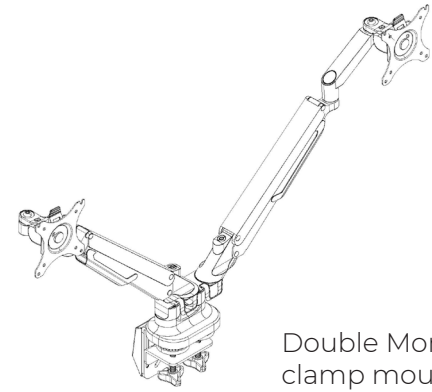

Double Monitor Arm - clamp mount

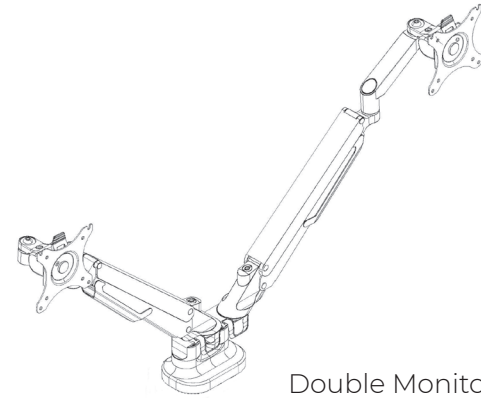

Double Monitor Arm - grommet mount

**What's Included:**

One monitor arm and installation hardware for both clamp and grommet mount

**How to Specify:**

- Specify type

**Dimensions:**

Vesa: 75x75 and 100x100

**Notes:**

Available in silver only

Single Monitor Arm

- Screen Size - 17"-36"
- Load Capacity - 6.6-26.4lbs/3-12kg
- Tilt Range - -90 degrees - -15 degrees

Dual Monitor Arm

- Screen Size - 17"-32"
- Load Capacity - 4.4-19.8lbs/2-9kg
- Tilt Range - -90 degrees - -15 degrees

Code	Price
Monitor Arm - Single Mount	
V-AFMA-01	374
Monitor Arm - Double Mount	
V-AFMA-02	624

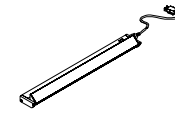

**Ordering Options:**

Use the following checklist to customize the finishes on your order:

- task light is finished in silver only

**Details:**

1. The task light is mounted with magnets underneath an overhead cabinet or shelf to provide focused lighting within the workstation
2. 160° swiveling lamps allows the user to position the light where it is needed
3. the task light is equipped with a fluorescent T5 tube and electronic ballast to reduce energy consumption

Code	Price	H	W	D	Volume (ft <sup>3</sup> )	Weight (lb)
V-ELU-24	302	0	24.53	0	0	9.5
V-ELU-36	340	0	36.39	0	0	13.7
V-ELU-48	427	0	48.15	0	0	17.9