



# Metro Collab Pricebook July 2023

# Contents

overview	9
application guidelines Step 1	10
application guidelines Step 2	11
application guidelines Step 3	12
application guidelines Step 4	13
application guidelines Step 5	14
application guidelines Map	15
application guidelines Grain direction	16
caution	17
straight desk	19
straight desk   executive	20
straight desk   professional	22
straight partial modesty   executive	24
straight partial modesty   professional	26
straight full recessed modesty   executive	28
straight full recessed modesty   professional	30
arc full recessed modesty   executive	32
arc full recessed modesty   professional	33
tables	35
D-table   executive	36
D-table   professional	37
K-table   executive	38

K-table   professional	39
J-table   executive	40
J-table   professional	41
P-table   executive	42
P-table   professional	43
F-table   executive	44
F-table   professional	45
U-table   executive	46
U-table   professional	47
C-table   executive	48
C-table   professional	49
corners	51
straight front corner surface   full modesty   executive	52
straight front corner surface   full modesty   professional	53
straight front corner surface   partial modesty   executive	54
straight front corner surface   partial modesty   professional	55
curved front corner surface   full modesty   executive	56
curved front corner surface   full modesty   professional	57
curved front corner surface   partial modesty   executive	58
curved front corner surface   partial modesty   professional	59
unitized desks	61
curved front unitized desk   full modesty   executive	62
curved front unitized desk   full modesty   professional	63
curved front unitized desk   partial modesty   executive	64
curved front unitized desk   partial modesty   professional	65

**bridges 67**

straight bridge   full modesty   executive	68
straight bridge   full modesty   professional	69
straight bridge   partial modesty   executive	70
straight bridge   partial modesty   professional	71
notched bridge   full modesty   executive	72
notched bridge   full modesty   professional	73
notched bridge   partial modesty   executive	74
notched bridge   partial modesty   professional	75
bowed bridge   full modesty   executive	76
bowed bridge   full modesty   professional	77
bowed bridge   partial modesty   executive	78
bowed bridge   partial modesty   professional	79

**returns 81**

straight return   full modesty   executive	82
straight return   full modesty   professional	84
straight return   partial modesty   executive	86
straight return   partial modesty   professional	88
notched return   full modesty   executive	90
notched return   full modesty   professional	92
notched return   partial modesty   executive	94
notched return   partial modesty   professional	96
bowed return   full modesty   executive	98
bowed return   full modesty   professional	100

bowed return   partial modesty   executive	102
bowed return   partial modesty   professional	104
intermediate support & cantilever	107

**filing and storage 109**

pedestals	110
underdesk storage cabinet	111
underdesk combo pedestal BBF & FF	112
underdesk 2-drawer lateral file	113
freestanding storage cabinet   executive	114
freestanding storage cabinet   professional	115
freestanding combo pedestal BBF & FF   executive	116
freestanding combo pedestal BBF & FF   professional	117
freestanding 2-drawer lateral file   executive	118
freestanding 2-drawer lateral file   professional	119
freestanding 3-drawer lateral file   executive	120
freestanding 3-drawer lateral file   professional	121
freestanding 4-drawer lateral file   executive	122
freestanding 4-drawer lateral file   professional	123
freestanding storage tower   executive	124
freestanding storage tower   professional	125
freestanding combo storage tower BBF   executive	126
freestanding combo storage tower BBF   professional	127
freestanding wardrobe storage tower   executive	128
freestanding wardrobe storage tower   professional	129

freestanding storage tower glazed door   executive	130
freestanding storage tower glazed door   professional	131
freestanding combo storage tower FF   executive	132
freestanding combo storage tower FF   professional	133
freestanding storage tower double door   executive	134
freestanding storage tower double door   professional	135
freestanding combo lateral storage tower double door   executive	136
freestanding combo lateral storage tower double door   professional	137
freestanding combo storage tower double door   executive	138
freestanding combo storage tower double door   professional	139
freestanding storage tower glazed double door   executive	140
freestanding storage tower glazed double door   professional	141
freestanding combo lateral storage tower glazed double door   executive	142
freestanding combo lateral storage tower glazed double door   professional	143
freestanding combo storage tower glazed double door   executive	144
freestanding combo storage tower glazed double door   professional	145
radius corner bookcase short   executive	146
radius corner bookcase short   professional	147
<b>overhead storage</b>	<b>149</b>
open hutch   executive	150
open hutch   professional	151
hinged door overhead storage   executive	152
hinged door overhead storage   professional	153

hinged door overhead storage glazed doors   executive	154
hinged door overhead storage glazed doors   professional	155
<b>posts</b>	<b>157</b>
large vertical aluminum post	158
small vertical aluminum post	159
<b>electrics</b>	<b>161</b>
power box	162
data box	163
electrical starter harness	164
electrical splitter harness	165
electrical harness	166
<b>screens</b>	<b>169</b>
lamine screens	170
fabric screens	175
glazed screens	180
whiteboard screens	185
accessory screen	189
<b>counter tops</b>	<b>191</b>
glass	192
lamine 1.5 inch	193
boat lamine 1 inch	194
straight lamine 1 inch	195

wire management 197

vertical wire manager 198

horizontal wire manager 199

wire clip 200

accessories 203

keyboard tray 204

work organizer 205

monitor arm 206

task light 207

OVERVIEW

Tayco introduces Metropolis Collaborate, a full line of casegoods with a post and screen component that refreshes open spaces, private, and semi-private work areas for today's office environment. Collaborate is divided into two distinct product groups for specifying: Executive and Professional. Executive offers surfaces and tops that are 1.5" thick, Professional offers 1" thick. Listed below are features and benefits of collaborate along with a typical layout.

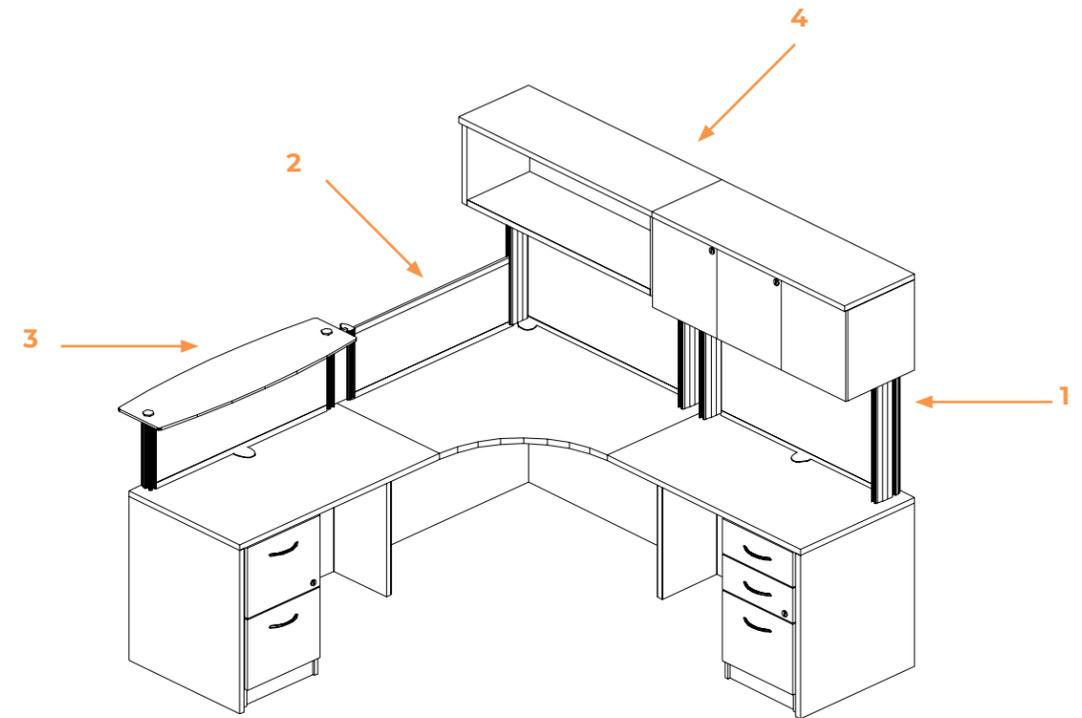

1

- a. Aluminum posts are available in 8, 12, 16, 24, 32 inches high.
- b. Large posts are required to support overhead storage.
- c. Hutches 54 inches and wider require 4 posts in a single span.
- d. Transaction countertops 54 inches and wider require 4 small aluminum posts.
- e. Posts are available in silver, black, and ginger.

2

- a. Screens are available in tackable fabric, laminate, whiteboard, glazed or with accessory slots.
- b. Heights are available in 4, 8, 12, 16, 20, 24, 32 inches high.

3

- a. Countertops are available in tempered glass and laminate finishes.
- b. They are supported by small aluminum posts.

4

- a. Overhead storage is available for assorted desk layouts, optional features include: open, hinged doors, glazed and open laminate.

# application guidelines Step 1

## STEP

## EXPLAINED

## NEXT

# 1

First select the appropriate base components to fit the space planning needs of your customer. Below is a typical corner workstation that consists of the basic items commonly used in today's office environment.

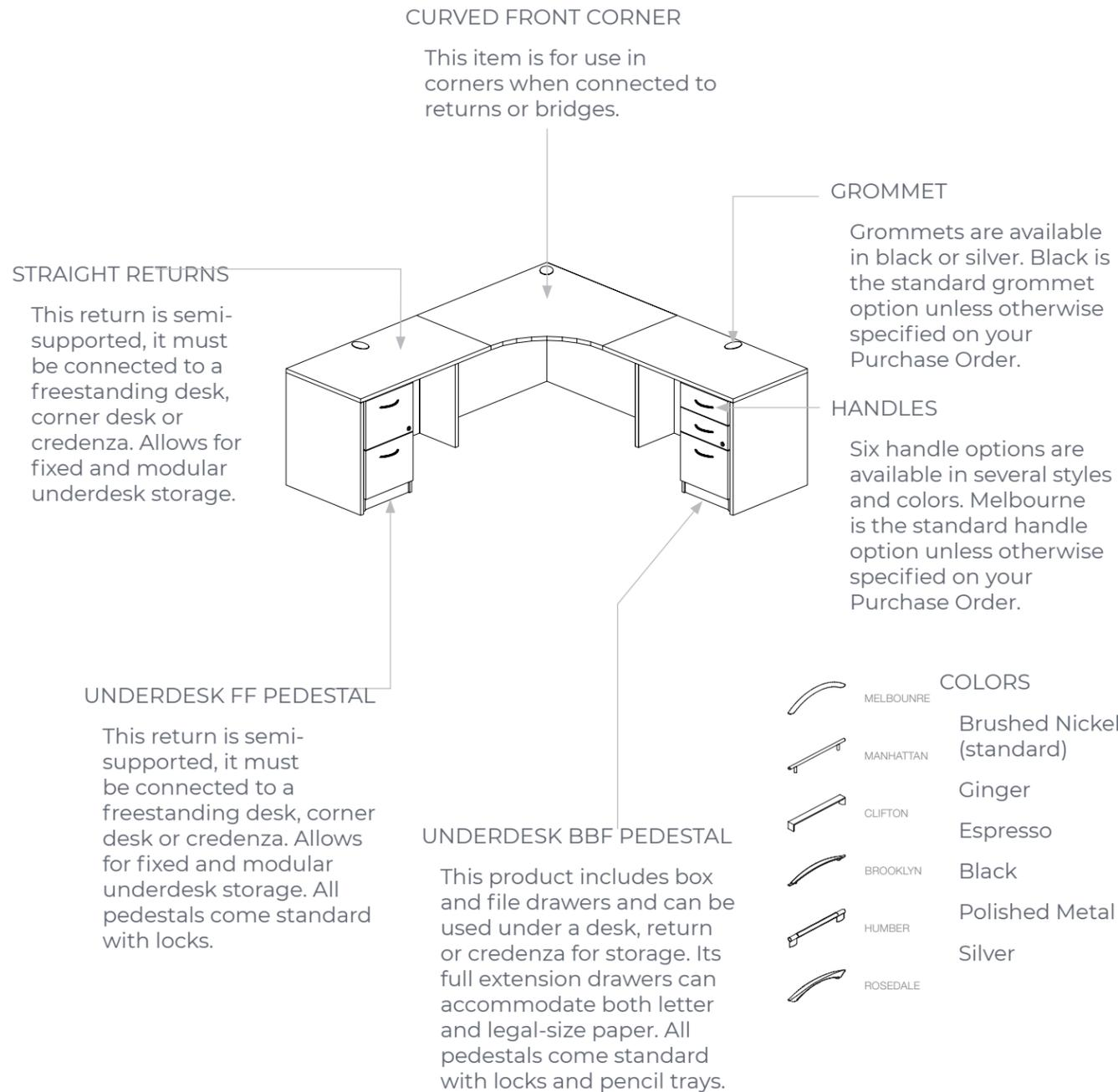
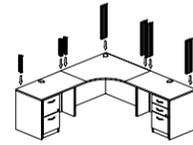

# application guidelines Step 2

## STEP

## EXPLAINED

## NEXT

# 2

Select the appropriate post heights to fit the specification needs by your customer. There are only two post structures to work with. Small posts support countertops and all screen heights. Large posts support overheads in conjunction with large screens.

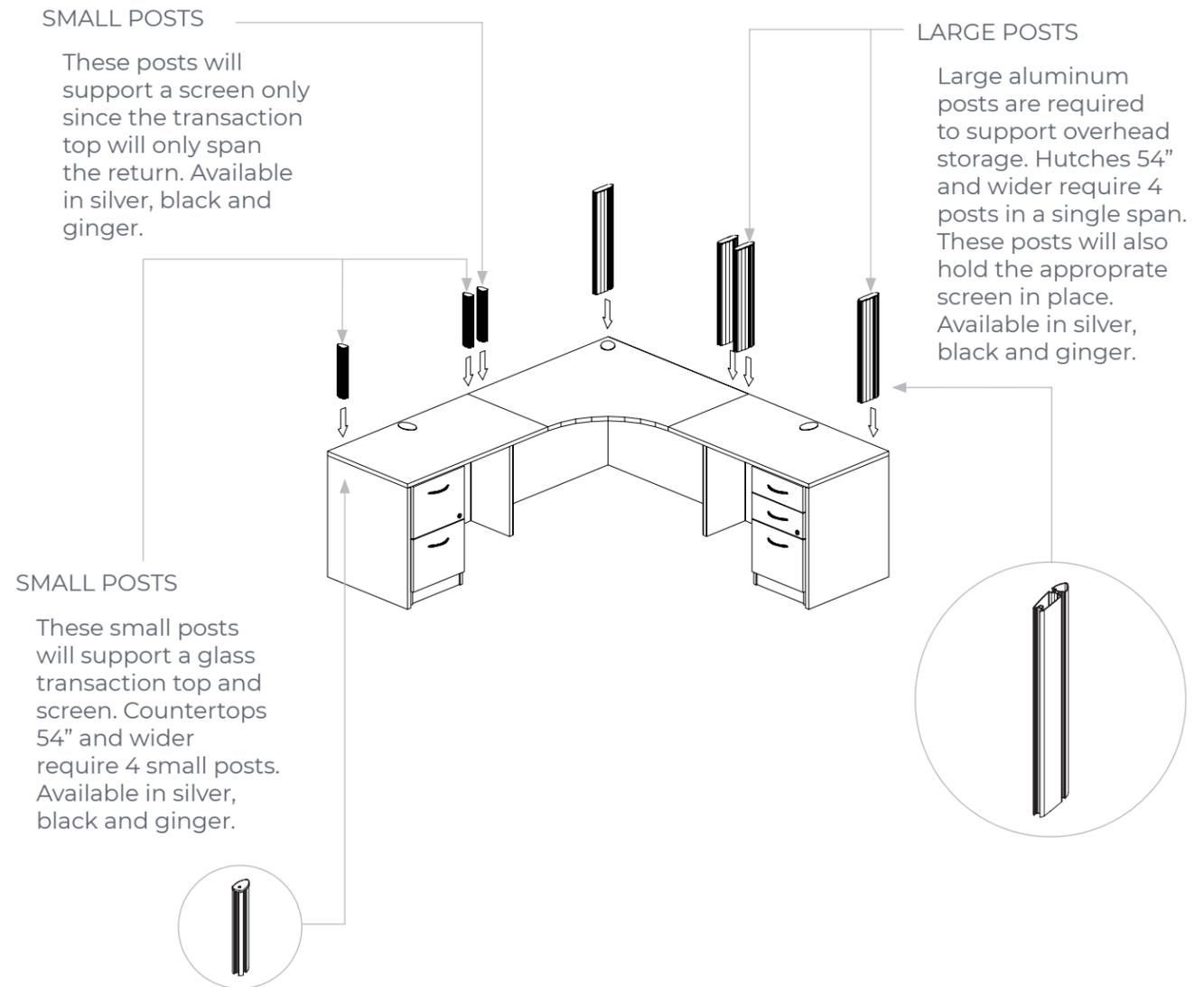
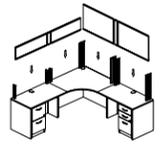

## application guidelines Step 3

### STEP

# 3

### EXPLAINED

Choose the appropriate screen heights based on post heights. Metropolis Collaborate offers several screen types: laminate, fabric, glazed, whiteboard, and accessory.

### NEXT

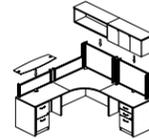

#### SCREENS

Screens selected in conjunction with corresponding post height and surface width.

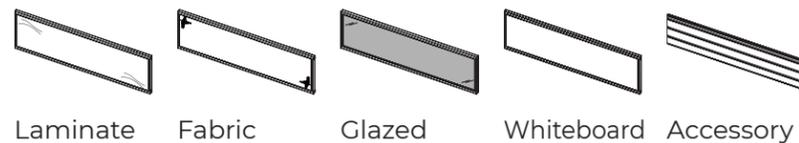
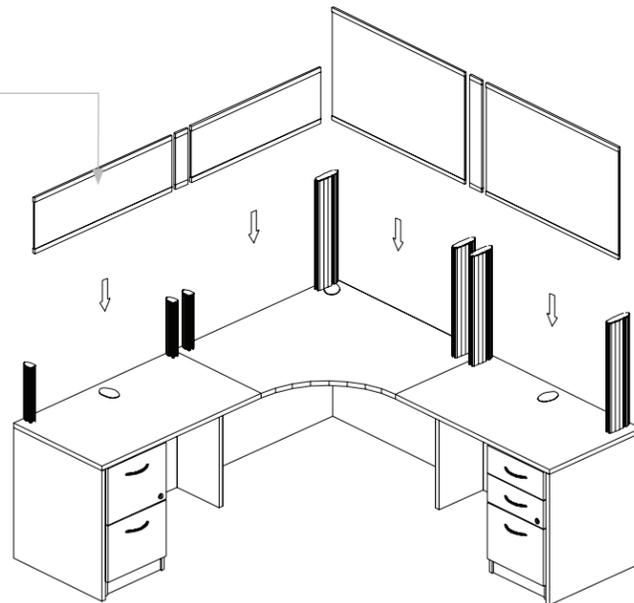

## application guidelines Step 4

### STEP

# 4

### EXPLAINED

Overhead storage and hutches can now be added to any 24" large vertical posts. In this case an Open and Hinged Door Hutch are being used for storage. A transaction top is placed on the smaller posts.

### COMPLETE

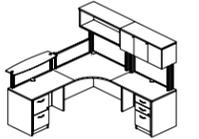

#### OPEN HUTCH

Provides overhead storage within the workstation. Overheads 54 inches and wider require 4 large vertical posts for support.

#### HINGED DOOR HUTCH

Provides overhead storage within the workstation. Overheads 54 inches and wider require 4 large vertical posts for support.

#### TRANSACTION TOP

Transaction tops are available in tempered glass, 1 & 1.5 inches thick laminate surfaces. Transaction tops 54 inches and wider require 4 small vertical posts for support.

#### HINGED DOOR HUTCH GLAZED

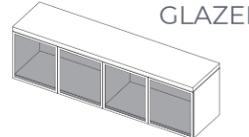

#### OPEN LAMINATE SHELF

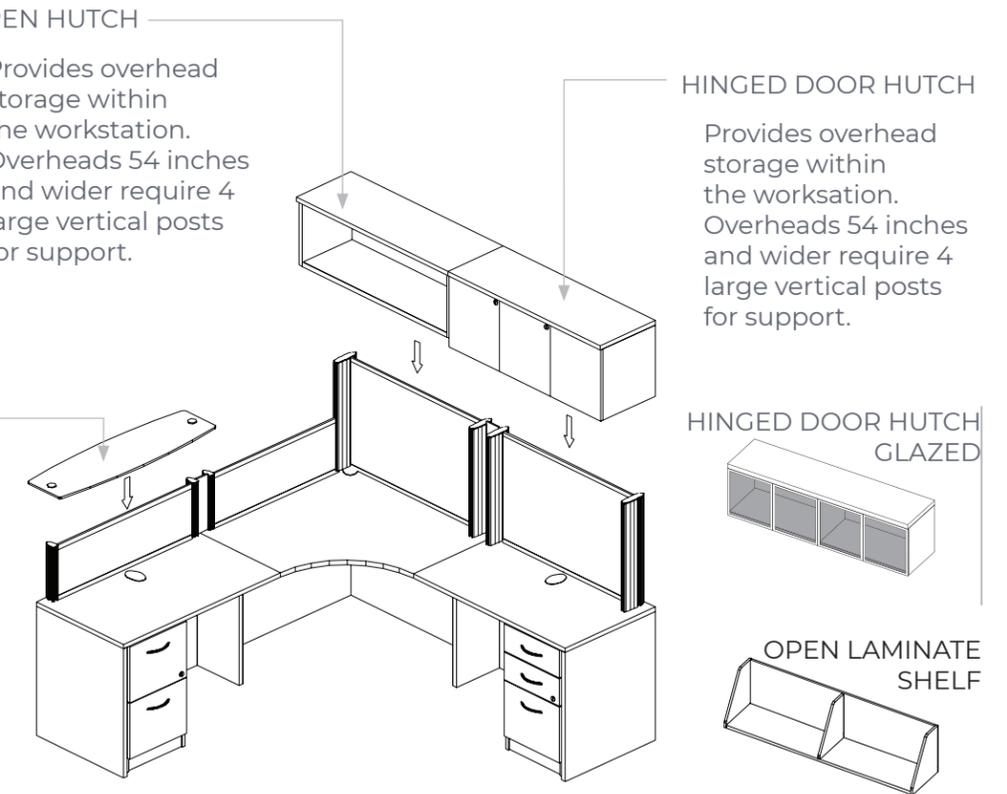
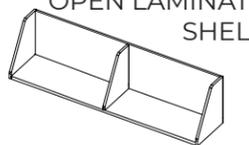

STEP

5

EXPLAINED

The workstation is now complete. Providing detailed floorplans with each order will help avoid errors when quoting Metropolis Collaborate. Tayco can assist with space planning needs by generating proper layouts and pricing.

FLOORPLAN

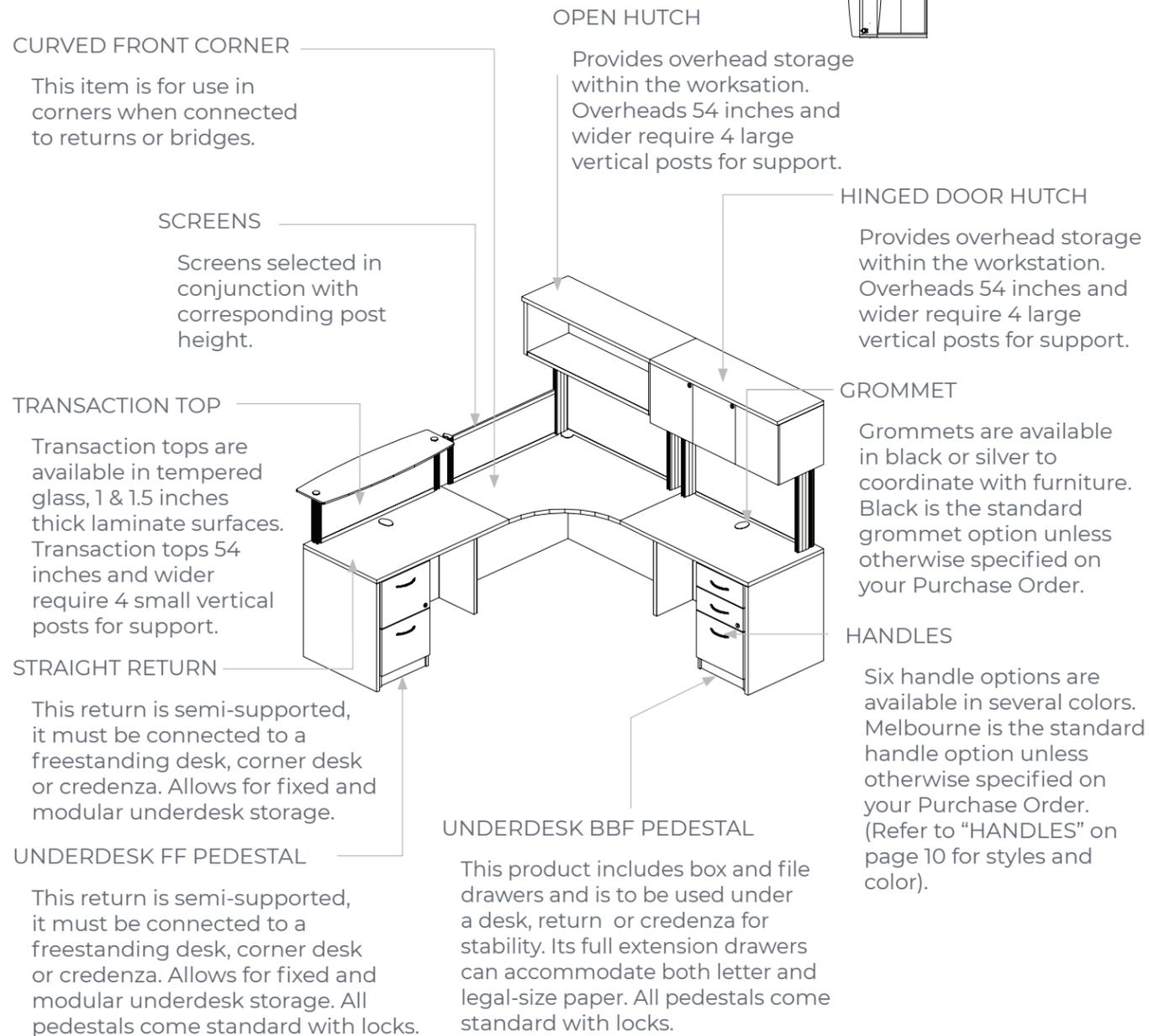
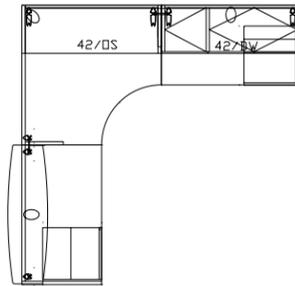

BRIEF

This map contains all the components referred to in this section for easy reference.

MAP

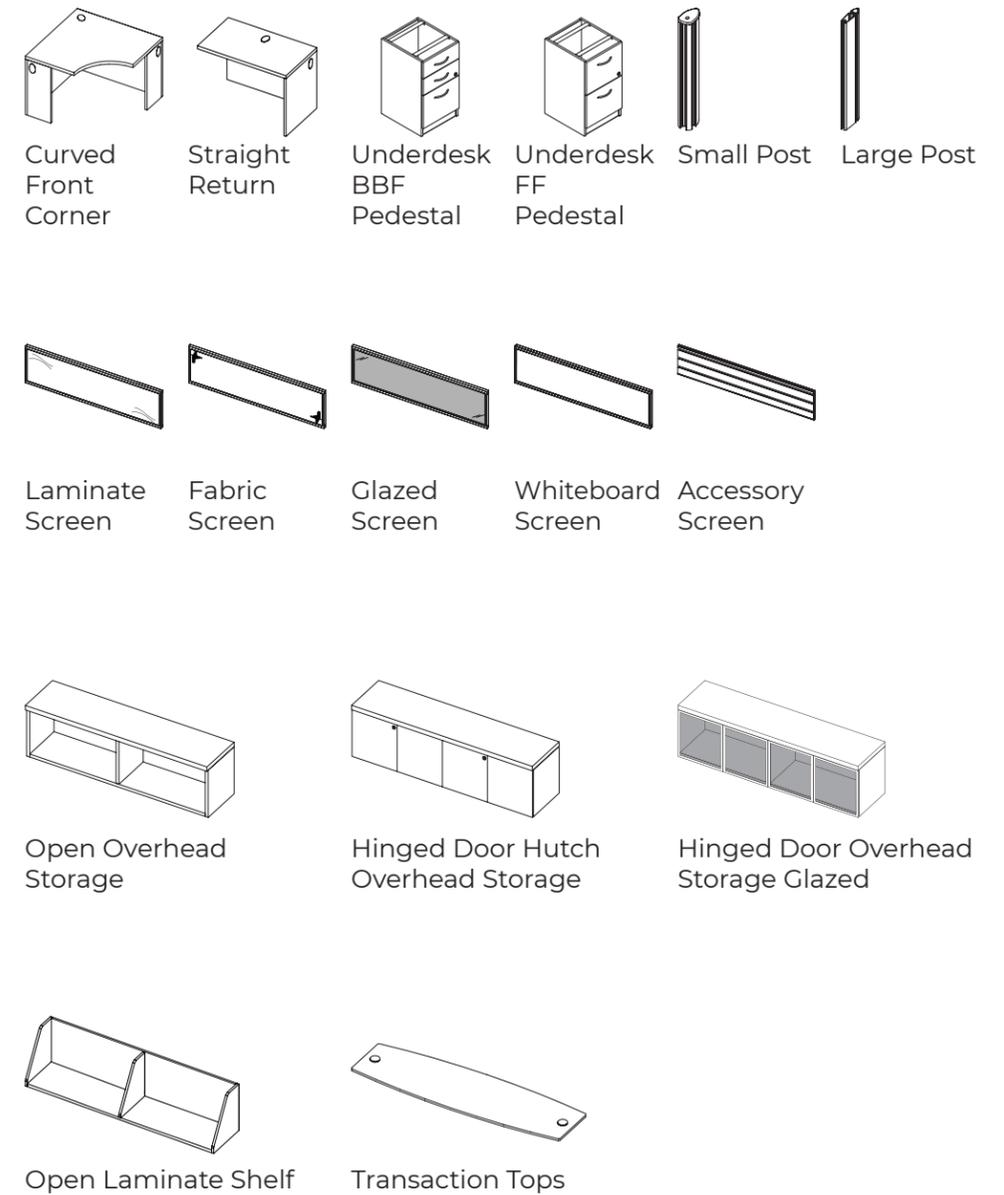

## application guidelines Grain direction

### HORIZONTAL SURFACES

When ordering a directional laminate, the grain will run the direction of the width of the worksurface (excluding bridge surfaces), hutch or storage top. Grain on bridge modesty run vertically so the grain will run the same direction on the entire suite.

### VERTICAL SURFACES

Directional laminates run vertically on vertical surfaces such as cabinet doors, pedestal drawer fronts and gables, as well as all cabinet, lateral file and pedestal kick-plates. The grain runs horizontally across the width of modesty panels.

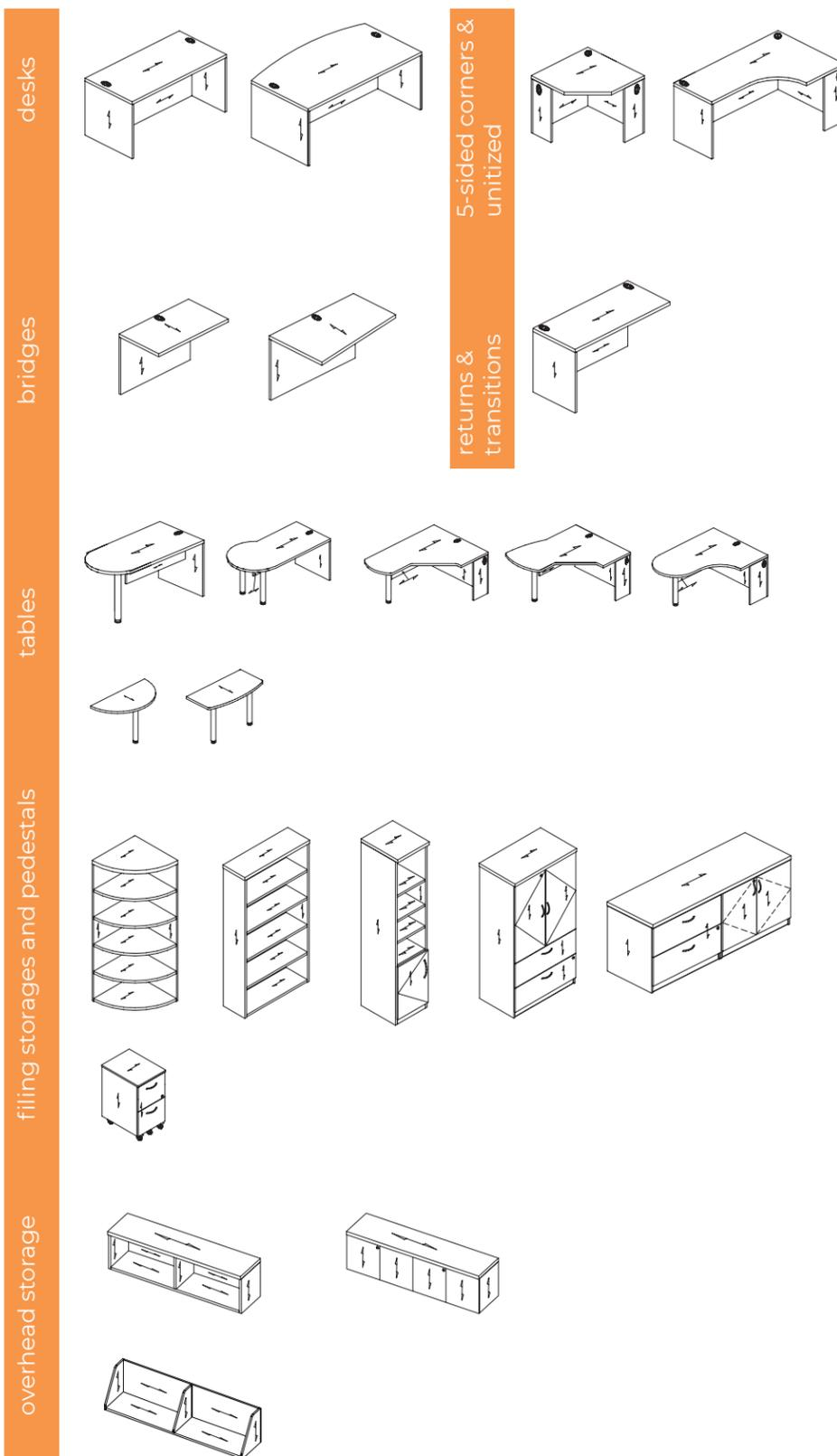

## Caution

### Load Bottom Drawer First

- Operate one drawer at a time
- Units may tip if loaded incorrectly
- Units should be attached to a wall or other furniture to reduce tipping hazard
- Always load the heaviest files in the bottom drawer

### Heavy Load

- Some products must be anchored to wall to ensure stability & safety.
- It is the owner and installers responsibility to ensure that the wall type and construction is of sufficient strength to carry the loads of any wall mounted products and their contents.
- Failure of the wall and anchors to support all imposed loads may result in property damage and/or personal injury.
- Tayco can provide size and empty weight of its products only. As wall blocking is considered a building construction process, Tayco cannot provide recommendations in this respect and cannot be responsible for damage or injury that may occur as a result of improper installation and/or blocking.

### Instability Hazard

Mobile items on casters such as flip top, personal and movable tables of any type and storage items of any type may present an instability hazard if not secured correctly while in use or in storage. Flip top tables or training tables of any type, are inherently more unstable when folded. Tayco provides the following guidelines & warnings when using mobile products:

- Lock casters immediately after moving. Do not leave the casters unlocked when in use or in storage.
- Motion may increase the instability of any item with casters. If the wheels hit an obstruction the table's forward momentum often causes overturn, especially if the item is not equipped with wheel extensions. Exercise strong caution while moving these items.
- Use caution when abrupt level changes in the floor are present (such as a doorway or room threshold) as caster failure or tipping may result.
- Do not stand, sit or lean on mobile items for support. They are not intended for this use and personal injury or property damage may result.
- Mobile units that feature height adjustable elements must be lowered to the minimum compressed height when moving to prevent instability. It is also recommended the user remove all computer equipment or other accessories to prevent possible weight imbalance or damage to equipment.
- Failure to follow the guidelines above may result in property damage or personal injury.



Metro Collab  
July 2023  
**Desks**

straight desk

Executive

<u>straight desk</u>	20
<u>straight partial modesty</u>	24
<u>straight full recessed modesty</u>	28
<u>arc full recessed modesty</u>	32

Professional

<u>straight desk</u>	22
<u>straight partial modesty</u>	26
<u>straight full recessed modesty</u>	30
<u>arc full recessed modesty</u>	33

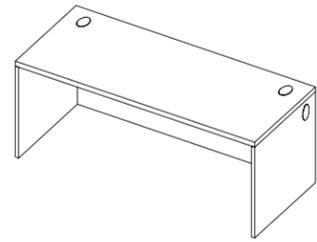

Straight Desk Full Modesty, 1.5" Thick Surface

This desk can be used alone or connected to a bridge or return to complete a full workstation. Allows for fixed and modular underdesk storage.

**Ordering Options:**

Use the following checklist to customize the finishes on your order:

- laminate
- trim color
- edge profile
- grommet color

Each laminate comes with matching vinyl trim color unless otherwise specified on your purchase order. Refer to the laminate finish card for our current offering.

**Details:**

Modesty is full height.

Grommets are available in black or silver. Black is the standard grommet option unless otherwise specified on your purchase order.

Surfaces up to and including 48" wide have one grommet located at the back center of the surface. Surfaces 54" wide and greater have two grommets at either side of the back of the surface.

All gables include grommets

Code	Price	H	W	D	Volume (ft <sup>3</sup> )	Weight (lb)
K-TS0G-6021	892	29.5	60	21	4.63	122.55
K-TS0G-6621	941	29.5	66	21	5.06	131.97
K-TS0G-7221	978	29.5	72	21	5.5	141.39
K-TS0G-7821	1021	29.5	78	21	5.93	150.81
K-TS0G-8421	1079	29.5	84	21	6.37	160.23
K-TS0G-3024	711	29.5	30	24	2.75	92.02
K-TS0G-3624	755	29.5	36	24	3.24	111.14
K-TS0G-4224	787	29.5	42	24	3.73	130.26
K-TS0G-4824	833	29.5	48	24	4.21	149.38
K-TS0G-5424	881	29.5	54	24	4.7	168.5
K-TS0G-6024	930	29.5	60	24	5.19	187.62
K-TS0G-6624	978	29.5	66	24	5.67	206.74
K-TS0G-7224	1014	29.5	72	24	6.16	225.86
K-TS0G-7824	1064	29.5	78	24	6.64	244.98
K-TS0G-8424	1121	29.5	84	24	7.13	264.1
K-TS0G-3030	748	29.5	30	30	3.34	99.05
K-TS0G-3630	807	29.5	36	30	3.94	110.58
K-TS0G-4230	854	29.5	42	30	4.53	122.11
K-TS0G-4830	910	29.5	48	30	5.12	133.64
K-TS0G-5430	978	29.5	54	30	5.71	145.17
K-TS0G-6030	1021	29.5	60	30	6.3	156.7
K-TS0G-6630	1064	29.5	66	30	6.89	168.23
K-TS0G-7230	1106	29.5	72	30	7.48	179.76
K-TS0G-8430	1233	29.5	84	30	8.66	202.82

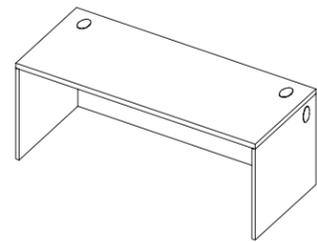

This desk can be used alone or connected to a bridge or return to complete a full workstation. Allows for fixed and modular underdesk storage.

**Ordering Options:**

Use the following checklist to customize the finishes on your order:

- laminate
- trim color
- grommet color

Each laminate comes with matching vinyl trim color unless otherwise specified on your purchase order. Refer to the laminate finish card for our current offering.

**Details:**

Modesty is full height.

Grommets are available in black or silver. Black is the standard grommet option unless otherwise specified on your purchase order.

Surfaces up to and including 48" wide have one grommet located at the back center of the surface. Surfaces 54" wide and greater have two grommets at either side of the back of the surface.

All gables include grommets

Code	Price	H	W	D	Volume (ft <sup>3</sup> )	Weight (lb)
KL-TS0G-6021	823	29	60	21	4.63	107.7
KL-TS0G-6621	870	29	66	21	5.06	117.12
KL-TS0G-7221	903	29	72	21	5.5	126.54
KL-TS0G-7821	948	29	78	21	5.93	135.96
KL-TS0G-8421	1001	29	84	21	6.37	145.38
KL-TS0G-3024	658	29	30	24	2.75	77.17
KL-TS0G-3624	703	29	36	24	3.24	96.29
KL-TS0G-4224	729	29	42	24	3.73	115.41
KL-TS0G-4824	771	29	48	24	4.21	134.53
KL-TS0G-5424	814	29	54	24	4.7	153.65
KL-TS0G-6024	859	29	60	24	5.19	172.77
KL-TS0G-6624	903	29	66	24	5.67	191.89
KL-TS0G-7224	941	29	72	24	6.16	211.01
KL-TS0G-7824	982	29	78	24	6.64	230.13
KL-TS0G-8424	1036	29	84	24	7.13	249.25
KL-TS0G-3030	694	29	30	30	3.34	84.2
KL-TS0G-3630	747	29	36	30	3.94	95.73
KL-TS0G-4230	791	29	42	30	4.53	107.26
KL-TS0G-4830	845	29	48	30	5.12	118.79
KL-TS0G-5430	902	29	54	30	5.71	130.32
KL-TS0G-6030	948	29	60	30	6.3	141.85
KL-TS0G-6630	982	29	66	30	6.89	153.38
KL-TS0G-7230	1024	29	72	30	7.48	164.91
KL-TS0G-7830	1085	29	78	30	8.07	176.44
KL-TS0G-8430	1142	29	84	30	8.66	187.97

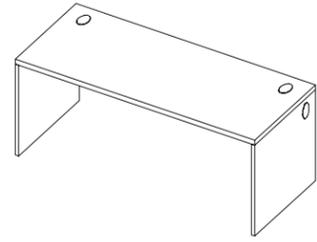

Straight Desk Partial Modesty, 1.5" Thick Surface

**Ordering Options:**

Use the following checklist to customize the finishes on your order:

- laminate
- trim color
- edge profile
- grommet color

Each laminate comes with matching vinyl trim color unless otherwise specified on your purchase order. Refer to the laminate finish card for our current offering.

**Details:**

Partial modesty height 12".

Grommets are available in black or silver. Black is the standard grommet option unless otherwise specified on your purchase order.

Surfaces up to and including 48" wide have one grommet located at the back center of the surface. Surfaces 54" wide and greater have two grommets at either side of the back of the surface.

All gables include grommets.

Code	Price	H	W	D	Volume (ft <sup>3</sup> )	Weight (lb)
K-TS0Z-6021	892	29.5	60	21	4.63	97.81
K-TS0Z-6621	941	29.5	66	21	5.06	104.54
K-TS0Z-7221	978	29.5	72	21	5.5	111.27
K-TS0Z-7821	1021	29.5	78	21	5.93	118
K-TS0Z-8421	1079	29.5	84	21	6.37	124.73
K-TS0Z-3024	711	29.5	30	24	2.75	71.33
K-TS0Z-3624	755	29.5	36	24	3.24	78.75
K-TS0Z-4224	787	29.5	42	24	3.73	86.17
K-TS0Z-4824	833	29.5	48	24	4.21	93.59
K-TS0Z-5424	881	29.5	54	24	4.7	101.01
K-TS0Z-6024	930	29.5	60	24	5.19	108.43
K-TS0Z-6624	978	29.5	66	24	5.67	115.85
K-TS0Z-7224	1014	29.5	72	24	6.16	123.27
K-TS0Z-7824	1064	29.5	78	24	6.64	130.69
K-TS0Z-8424	1121	29.5	84	24	7.13	138.11
K-TS0Z-3030	748	29.5	30	30	3.34	75.35
K-TS0Z-3630	807	29.5	36	30	3.94	83.98
K-TS0Z-4230	854	29.5	42	30	4.53	92.6
K-TS0Z-4830	910	29.5	48	30	5.12	101.23
K-TS0Z-5430	978	29.5	54	30	5.71	109.85
K-TS0Z-6030	1021	29.5	60	30	6.3	118.48
K-TS0Z-6630	1064	29.5	66	30	6.89	127.1
K-TS0Z-7230	1106	29.5	72	30	7.48	135.73
K-TS0Z-7830	1175	29.5	78	30	8.07	144.35
K-TS0Z-8430	1233	29.5	84	30	8.66	152.98

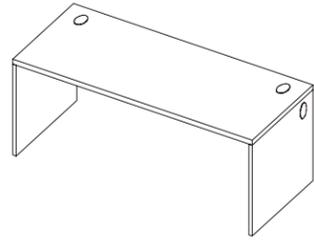

**Ordering Options:**

Use the following checklist to customize the finishes on your order:

- laminate
- trim color
- grommet color

Each laminate comes with matching vinyl trim color unless otherwise specified on your purchase order. Refer to the laminate finish card for our current offering.

**Details:**

Partial modesty height 12".

Grommets are available in black or silver. Black is the standard grommet option unless otherwise specified on your purchase order.

Surfaces up to and including 48" wide have one grommet located at the back center of the surface. Surfaces 54" wide and greater have two grommets at either side of the back of the surface.

All gables include grommets.

Code	Price	H	W	D	Volume (ft <sup>3</sup> )	Weight (lb)
KL-TS0Z-3030	694	29	30	30	3.34	63.48
KL-TS0Z-3624	703	29	36	24	3.24	67.5
KL-TS0Z-3630	747	29	36	30	3.94	69.97
KL-TS0Z-3630-UW	748	29	36	30	3.94	69.97
KL-TS0Z-4224	729	29	42	24	3.73	73.05
KL-TS0Z-4224-UW	729	29	42	24	3.73	73.05
KL-TS0Z-4230	791	29	42	30	4.53	76.46
KL-TS0Z-4230-UW	791	29	42	30	4.53	76.46
KL-TS0Z-4821	735	29	48	21	0	140
KL-TS0Z-4824	771	29	48	24	4.21	78.6
KL-TS0Z-4824-UW	772	29	48	24	4.21	78.6

Code	Price	H	W	D	Volume (ft <sup>3</sup> )	Weight (lb)
KL-TS0Z-4830	845	29	48	30	5.12	82.95
KL-TS0Z-5124	814	29	51	24	4.7	84.15
KL-TS0Z-5324	814	29	53	24	0	174.45
KL-TS0Z-5421	803	29	54	24	0	157.5
KL-TS0Z-5424	814	29	54	24	4.7	84.15
KL-TS0Z-5424-UW	814	29	54	24	0	157.5
KL-TS0Z-5430	902	29	54	30	5.71	89.44
KL-TS0Z-5430-UW	902	29	54	30	5.71	89.44
KL-TS0Z-6021	823	29	60	21	4.63	81.41
KL-TS0Z-6021-UW	825	29	60	21	4.63	81.41
KL-TS0Z-6024	859	29	60	24	5.19	89.7
KL-TS0Z-6024-UW	860	29	60	24	5.19	89.7
KL-TS0Z-6030	948	29	60	30	6.3	95.93
KL-TS0Z-6030-UW	948	29	60	30	6.3	95.93
KL-TS0Z-6618	870	29	66	18	0	25
KL-TS0Z-6621	870	29	66	21	5.06	86.6
KL-TS0Z-6624	903	29	66	24	5.67	95.25
KL-TS0Z-6624-UW	903	29	66	24	5.67	95.25
KL-TS0Z-6630	982	29	66	30	6.89	102.42
KL-TS0Z-6630-UW	982	29	66	30	6.89	102.42
KL-TS0Z-6636	1071	29	66	36	0	168
KL-TS0Z-7221	903	29	72	21	5.5	91.79
KL-TS0Z-7224	941	29	72	24	6.16	100.8
KL-TS0Z-7224-UW	942	29	72	24	6.16	100.8
KL-TS0Z-7230	1024	29	72	30	7.48	108.91
KL-TS0Z-7821	948	29	78	21	5.93	96.98
KL-TS0Z-7824	982	29	78	24	6.64	106.35
KL-TS0Z-7830	1085	29	78	30	8.07	115.4
KL-TS0Z-8421	1001	29	84	21	6.37	102.17
KL-TS0Z-8424	1036	29	84	24	7.13	111.9
KL-TS0Z-8430	1142	29	84	30	8.66	121.89

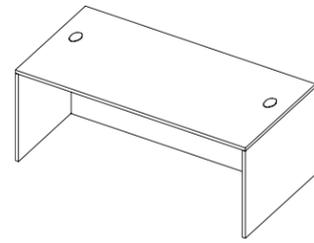

This desk can be used alone or connected to a bridge or return to complete a full workstation. Full modesty recessed in 8 inches for guests. Allows for fixed and modular underdesk storage.

**Ordering Options:**

Use the following checklist to customize the finishes on your order:

- laminate
- trim color
- edge profile
- grommet color

Each laminate comes with matching vinyl trim color unless otherwise specified on your purchase order. Refer to the laminate finish card for our current offering.

**Details:**

Full modesty recessed in 8 inches.

Grommets are available in black or silver. Black is the standard grommet option unless otherwise specified on your purchase order

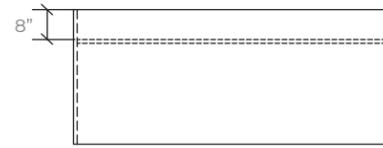

Code	Price	H	W	D	Volume (ft <sup>3</sup> )	Weight (lb)
K-TSRG-6030	1041	29.5	60	30	6.3	156.7
K-TSRG-6630	1079	29.5	66	30	6.89	168.23
K-TSRG-7230	1129	29.5	72	30	7.48	179.76
K-TSRG-7830	1194	29.5	78	30	8.07	191.29
K-TSRG-8430	1251	29.5	84	30	8.66	202.82
K-TSRG-6036	1206	29.5	60	36	7.41	178.2
K-TSRG-6636	1251	29.5	66	36	8.1	190.8
K-TSRG-7236	1299	29.5	72	36	8.8	203.4
K-TSRG-7836	1356	29.5	78	36	9.49	216
K-TSRG-8436	1405	29.5	84	36	10.19	228.6

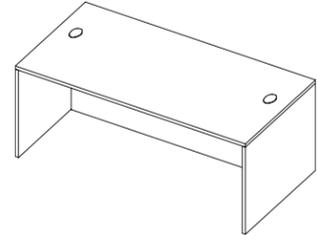

**Ordering Options:**

Use the following checklist to customize the finishes on your order:

- laminate
- trim color
- grommet color

Each laminate comes with matching vinyl trim color unless otherwise specified on your purchase order. Refer to the laminate finish card for our current offering.

**Details:**

Full modesty recessed in 8 inches.

Grommets are available in black or silver. Black is the standard grommet option unless otherwise specified on your purchase order

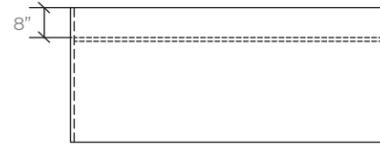

Code	Price	H	W	D	Volume (ft <sup>3</sup> )	Weight (lb)
KL-TSRG-6030	964	29	60	30	6.3	137.93
KL-TSRG-6630	1001	29	66	30	6.89	149.46
KL-TSRG-7230	1045	29	72	30	7.48	160.99
KL-TSRG-7830	1103	29	78	30	8.07	172.52
KL-TSRG-8430	1158	29	84	30	8.66	184.05
KL-TSRG-6036	1117	29	60	36	7.41	150.3
KL-TSRG-6636	1158	29	66	36	8.1	160.2
KL-TSRG-7236	1202	29	72	36	8.8	170.1
KL-TSRG-7836	1255	29	78	36	9.49	180
KL-TSRG-8436	1301	29	84	36	10.19	189.9

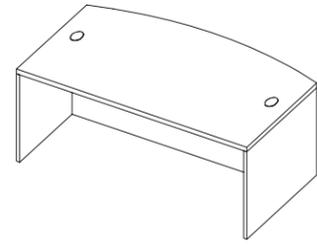

This desk can be used alone or connected to a bridge or return to complete a full workstation. Full modesty recessed in 8 inches for guests. Allows for fixed and modular underdesk storage.

**Ordering Options:**

Use the following checklist to customize the finishes on your order:

- laminate
- trim color
- edge profile
- grommet color

Each laminate comes with matching vinyl trim color unless otherwise specified on your purchase order. Refer to the laminate finish card for our current offering.

**Details:**

Full modesty recessed in 8 inches.

Grommets are available in black or silver. Black is the standard grommet option unless otherwise specified on your purchase order

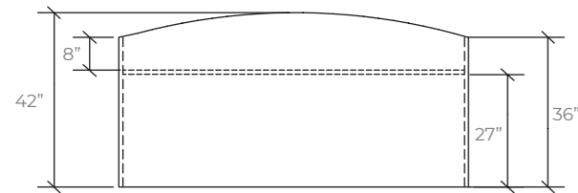

Code	Price	H	W	D	Volume (ft <sup>3</sup> )	Weight (lb)
K-TARG-7236	1507	29.5	72	36	8.8	216.17
K-TARG-7836	1576	29.5	78	36	9.49	230.43
K-TARG-8436	1646	29.5	84	36	10.19	244.69

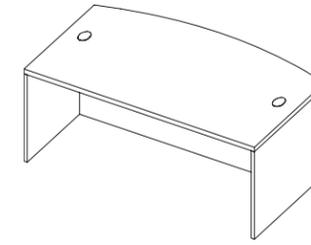

**Ordering Options:**

Use the following checklist to customize the finishes on your order:

- laminate
- trim color
- grommet color

Each laminate comes with matching vinyl trim color unless otherwise specified on your purchase order. Refer to the laminate finish card for our current offering.

**Details:**

Full modesty recessed in 8 inches.

Grommets are available in black or silver. Black is the standard grommet option unless otherwise specified on your purchase order

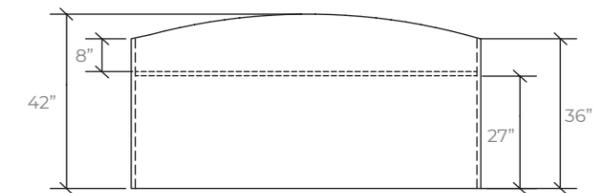

Code	Price	H	W	D	Volume (ft <sup>3</sup> )	Weight (lb)
KL-TARG-7236	1401	29	72	36	8.8	178.09
KL-TARG-7836	1471	29	78	36	9.49	188.84
KL-TARG-8436	1543	29	84	36	10.19	199.59

Metro Collab  
July 2023  
**Tables**

Executive

D-table	36
K-table	38
J-table	40
P-table	42
F-table	44
U-table	46
C-table	48

Professional

D-table	37
K-table	39
J-table	41
P-table	43
F-table	45
U-table	47
C-table	49

This table is semi-supported and must be used with two freestanding desks or credenzas.

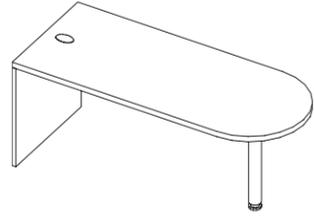

D-Table, 1.5" Thick Surface

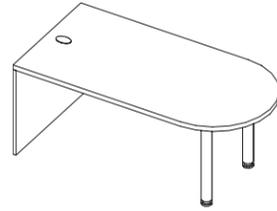

36" depth come with 2 posts

**Ordering Options:**

Use the following checklist to customize the finishes on your order:

- laminate
- trim color
- edge profile
- grommet color
- metal color (posts)

Each laminate comes with matching vinyl trim color unless otherwise specified on your purchase order. Refer to the laminate finish card for our current offering.

**Details:**

Grommets are available in black or silver. Black is the standard grommet option unless otherwise specified on your purchase order.

36 inch surface depth requires 2 posts.

Code	Price	H	W	D	Volume (ft <sup>3</sup> )	Weight (lb)
K-TD0G-6030	1244	29.5	60	30	5.04	108.29
K-TD0G-6630	1284	29.5	66	30	5.51	117.27
K-TD0G-7230	1328	29.5	72	30	5.98	126.25
K-TD0G-7830	1368	29.5	78	30	6.45	135.23
K-TD0G-8430	1408	29.5	84	30	6.93	144.21
K-TD0G-6036	1335	29.5	60	36	5.93	131.34
K-TD0G-6636	1388	29.5	66	36	6.48	141.76
K-TD0G-7236	1417	29.5	72	36	7.04	152.18
K-TD0G-7836	1455	29.5	78	36	7.59	162.6
K-TD0G-8436	1497	29.5	84	36	8.15	173.02

This table is semi-supported and must be used with two freestanding desks or credenzas.

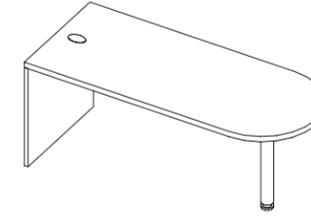

D-Table, 1.5" Thick Surface

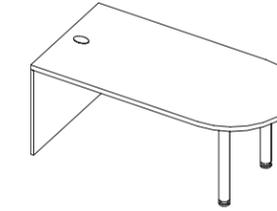

36" depth come with 2 posts

**Ordering Options:**

Use the following checklist to customize the finishes on your order:

- laminate
- trim color
- grommet color
- metal color (posts)

Each laminate comes with matching vinyl trim color unless otherwise specified on your purchase order. Refer to the laminate finish card for our current offering.

**Details:**

Grommets are available in black or silver. Black is the standard grommet option unless otherwise specified on your purchase order.

36 inch surface depth requires 2 posts.

Code	Price	H	W	D	Volume (ft <sup>3</sup> )	Weight (lb)
KL-TD0G-6030	1020	29	60	30	5.04	86.48
KL-TD0G-6630	1064	29	66	30	5.51	92.95
KL-TD0G-7230	1102	29	72	30	5.98	99.42
KL-TD0G-7830	1142	29	78	30	6.45	105.9
KL-TD0G-8430	1186	29	84	30	6.93	112.38
KL-TD0G-6036	1113	29	60	36	5.93	107.18
KL-TD0G-6636	1162	29	66	36	6.48	115.76
KL-TD0G-7236	1194	29	72	36	7.04	124.34
KL-TD0G-7836	1234	29	78	36	7.59	132.92
KL-TD0G-8436	1277	29	84	36	8.15	141.5

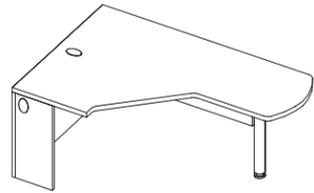

This table should be connected to a bridge or return to complete a full workstation (right hand shown).

K-Table, 1.5" Thick Surface

**Ordering Options:**

Use the following checklist to customize the finishes on your order:

- laminate
- trim color
- edge profile
- grommet color
- metal color (posts)

Each laminate comes with matching vinyl trim color unless otherwise specified on your purchase order. Refer to the laminate finish card for our current offering.

**Details:**

Grommets are available in black or silver. Black is the standard grommet option unless otherwise specified on your purchase order.

Code	Price	H	W	D	Volume (ft <sup>3</sup> )	Weight (lb)
<b>Left Hand</b>						
K-TKSG-604824-L	1643	29.5	60	24	5.19	149.13
K-TKSG-664824-L	1755	29.5	66	24	5.67	156.85
K-TKSG-724824-L	1844	29.5	72	24	6.16	164.57
K-TKSG-784824-L	1934	29.5	78	24	6.64	172.29
K-TKSG-844824-L	2025	29.5	84	24	7.13	180.01
<b>Right Hand</b>						
K-TKSG-604824-R	1643	29.5	60	24	5.19	149.13
K-TKSG-664824-R	1755	29.5	66	24	5.67	156.85
K-TKSG-724824-R	1844	29.5	72	24	6.16	164.57
K-TKSG-784824-R	1934	29.5	78	24	6.64	172.29
K-TKSG-844824-R	2025	29.5	84	24	7.13	180.01

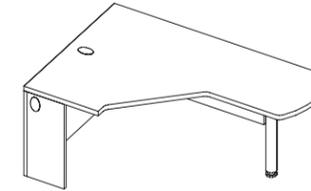

This table should be connected to a bridge or return to complete a full workstation (right hand shown).

**Ordering Options:**

Use the following checklist to customize the finishes on your order:

- laminate
- trim color
- grommet color
- metal color (posts)

Each laminate comes with matching vinyl trim color unless otherwise specified on your purchase order. Refer to the laminate finish card for our current offering.

**Details:**

Grommets are available in black or silver. Black is the standard grommet option unless otherwise specified on your purchase order.

Code	Price	H	W	D	Volume (ft <sup>3</sup> )	Weight (lb)
<b>Left Hand</b>						
KL-TKSG-604824L	1538	29	60	24	5.19	120.33
KL-TKSG-664824L	1647	29	66	24	5.67	125.88
KL-TKSG-724824L	1739	29	72	24	6.16	131.43
KL-TKSG-784824L	1827	29	78	24	6.64	136.98
KL-TKSG-844824L	1916	29	84	24	7.13	142.53
<b>Right Hand</b>						
KL-TKSG-604824R	1538	29	60	24	5.19	120.33
KL-TKSG-664824R	1647	29	66	24	5.67	125.88
KL-TKSG-724824R	1739	29	72	24	6.16	131.43
KL-TKSG-784824R	1827	29	78	24	6.64	136.98
KL-TKSG-844824R	1916	29	84	24	7.13	142.53

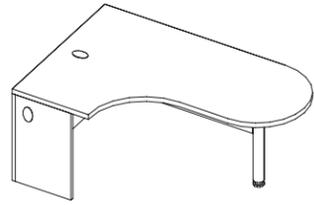

This table should be connected to a bridge or return to complete a full workstation (right hand shown).

J-Table, 1.5" Thick Surface

**Ordering Options:**

Use the following checklist to customize the finishes on your order:

- laminate
- trim color
- edge profile
- grommet color
- metal color (posts)

Each laminate comes with matching vinyl trim color unless otherwise specified on your purchase order. Refer to the laminate finish card for our current offering.

**Details:**

Grommets are available in black or silver. Black is the standard grommet option unless otherwise specified on your purchase order.

Item includes worksurface, 1 post leg, and mounting hardware.

All gables include grommets.

Code	Price	H	W	D	Volume (ft <sup>3</sup> )	Weight (lb)
<b>Left Hand</b>						
K-TJ0G-604824-L	1640	29.5	60	24	6.22	149.48
K-TJ0G-664824-L	1749	29.5	66	24	6.81	158.56
K-TJ0G-724824-L	1838	29.5	72	24	7.39	167.64
K-TJ0G-784824-L	1934	29.5	78	24	7.97	176.72
K-TJ0G-844824-L	2025	29.5	84	24	8.56	185.8
<b>Right Hand</b>						
K-TJ0G-604824-R	1640	29.5	60	24	6.22	149.48
K-TJ0G-664824-R	1749	29.5	66	24	6.81	158.56
K-TJ0G-724824-R	1838	29.5	72	24	7.39	167.64
K-TJ0G-784824-R	1934	29.5	78	24	7.97	176.72
K-TJ0G-844824-R	2025	29.5	84	24	8.56	185.8

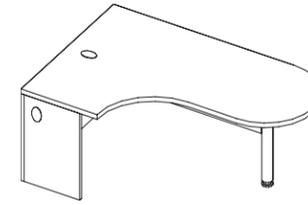

This table should be connected to a bridge or return to complete a full workstation (right hand shown).

**Ordering Options:**

Use the following checklist to customize the finishes on your order:

- laminate
- trim color
- grommet color
- metal color (posts)

Each laminate comes with matching vinyl trim color unless otherwise specified on your purchase order. Refer to the laminate finish card for our current offering.

**Details:**

Grommets are available in black or silver. Black is the standard grommet option unless otherwise specified on your purchase order.

Item includes worksurface, 1 post leg, and mounting hardware.

All gables include grommets.

Code	Price	H	W	D	Volume (ft <sup>3</sup> )	Weight (lb)
<b>Left Hand</b>						
KL-TJ0G-604824L	1529	29	60	24	6.22	120.67
KL-TJ0G-664824L	1641	29	66	24	6.81	127.15
KL-TJ0G-724824L	1729	29	72	24	7.39	133.63
KL-TJ0G-784824L	1827	29	78	24	7.97	140.11
KL-TJ0G-844824L	1916	29	84	24	8.56	146.59
<b>Right Hand</b>						
KL-TJ0G-604824R	1529	29	60	24	6.22	120.67
KL-TJ0G-664824R	1641	29	66	24	6.81	127.15
KL-TJ0G-724824R	1729	29	72	24	7.39	133.63
KL-TJ0G-784824R	1827	29	78	24	7.97	140.11
KL-TJ0G-844824R	1916	29	84	24	8.56	146.59

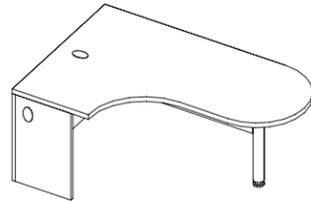

This table should be connected to a bridge or return to complete a full workstation (right hand shown).

J-Table, 1.5" Thick Surface

**Ordering Options:**

Use the following checklist to customize the finishes on your order:

- laminate
- trim color
- edge profile
- grommet color
- metal color (posts)

Each laminate comes with matching vinyl trim color unless otherwise specified on your purchase order. Refer to the laminate finish card for our current offering.

**Details:**

Grommets are available in black or silver. Black is the standard grommet option unless otherwise specified on your purchase order.

Item includes worksurface, 1 post leg, and mounting hardware.

All gables include grommets.

Code	Price	H	W	D	Volume (ft <sup>3</sup> )	Weight (lb)
<b>Left Hand</b>						
K-TP0G-6030-L	1507	29.5	60	30	7.56	119.92
K-TP0G-6630-L	1576	29.5	66	30	8.26	128.78
K-TP0G-7230-L	1629	29.5	72	30	8.97	137.64
K-TP0G-7830-L	1694	29.5	78	30	9.68	146.5
K-TP0G-8430-L	1755	29.5	84	30	10.39	155.36
<b>Right Hand</b>						
K-TP0G-6030-R	1507	29.5	60	30	7.56	119.92
K-TP0G-6630-R	1576	29.5	66	30	8.26	128.78
K-TP0G-7230-R	1629	29.5	72	30	8.97	137.64
K-TP0G-7830-R	1694	29.5	78	30	9.68	146.5
K-TP0G-8430-R	1755	29.5	84	30	10.39	155.36

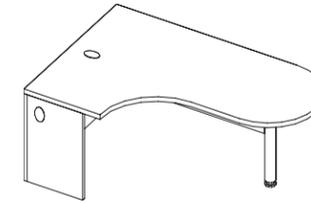

This table should be connected to a bridge or return to complete a full workstation (right hand shown).

**Ordering Options:**

Use the following checklist to customize the finishes on your order:

- laminate
- trim color
- grommet color
- metal color (posts)

Each laminate comes with matching vinyl trim color unless otherwise specified on your purchase order. Refer to the laminate finish card for our current offering.

**Details:**

Grommets are available in black or silver. Black is the standard grommet option unless otherwise specified on your purchase order.

Item includes worksurface, 1 post leg, and mounting hardware.

All gables include grommets.

Code	Price	H	W	D	Volume (ft <sup>3</sup> )	Weight (lb)
<b>Left Hand</b>						
KL-TP0G-6030-L	1401	29	60	30	7.56	96.51
KL-TP0G-6630-L	1471	29	66	30	8.26	103.34
KL-TP0G-7230-L	1522	29	72	30	8.97	110.17
KL-TP0G-7830-L	1588	29	78	30	9.68	117
KL-TP0G-8430-L	1647	29	84	30	10.39	123.83
<b>Right Hand</b>						
KL-TP0G-6030-R	1401	29	60	30	7.56	96.51
KL-TP0G-6630-R	1471	29	66	30	8.26	103.34
KL-TP0G-7230-R	1522	29	72	30	8.97	110.17
KL-TP0G-7830-R	1588	29	78	30	9.68	117
KL-TP0G-8430-R	1647	29	84	30	10.39	123.83

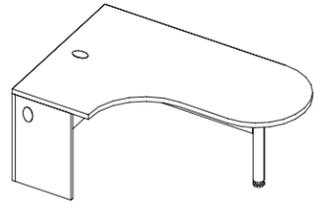

This table should be connected to a bridge or return to complete a full workstation (right hand shown).

F-Table, 1.5" Thick Surface

**Ordering Options:**

Use the following checklist to customize the finishes on your order:

- laminate
- trim color
- edge profile
- grommet color
- metal color (posts)

Each laminate comes with matching vinyl trim color unless otherwise specified on your purchase order. Refer to the laminate finish card for our current offering.

**Details:**

Grommets are available in black or silver. Black is the standard grommet option unless otherwise specified on your purchase order.

Item includes worksurface, 1 post leg, and mounting hardware.

All gables include grommets.

Code	Price	H	W	D	Volume (ft <sup>3</sup> )	Weight (lb)
<b>Left Hand</b>						
K-TFSG-604824-L	1928	29.5	60	24	7.26	152.9
K-TFSG-664824-L	1969	29.5	66	24	7.94	161.05
K-TFSG-724824-L	2010	29.5	72	24	8.62	169.2
K-TFSG-784824-L	2048	29.5	78	24	9.3	177.35
K-TFSG-844824-L	2090	29.5	84	24	9.98	185.5
<b>Right Hand</b>						
K-TFSG-604824-R	1928	29.5	60	24	7.26	152.9
K-TFSG-664824-R	1969	29.5	66	24	7.94	161.05
K-TFSG-724824-R	2010	29.5	72	24	8.62	169.2
K-TFSG-784824-R	2048	29.5	78	24	9.3	177.35
K-TFSG-844824-R	2090	29.5	84	24	9.98	185.5

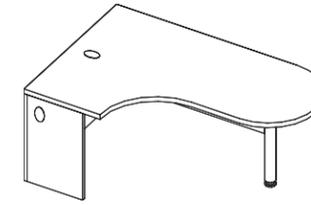

This table should be connected to a bridge or return to complete a full workstation (right hand shown).

**Ordering Options:**

Use the following checklist to customize the finishes on your order:

- laminate
- trim color
- grommet color
- metal color (posts)

Each laminate comes with matching vinyl trim color unless otherwise specified on your purchase order. Refer to the laminate finish card for our current offering.

**Details:**

Grommets are available in black or silver. Black is the standard grommet option unless otherwise specified on your purchase order.

Item includes worksurface, 1 post leg, and mounting hardware.

All gables include grommets.

Code	Price	H	W	D	Volume (ft <sup>3</sup> )	Weight (lb)
<b>Left Hand</b>						
KL-TFSG-604824L	1867	29	60	24	7.26	123.35
KL-TFSG-664824L	1898	29	66	24	7.94	129.35
KL-TFSG-724824L	1932	29	72	24	8.62	135.35
KL-TFSG-784824L	1965	29	78	24	9.3	141.35
KL-TFSG-844824L	1998	29	84	24	9.98	147.35
<b>Right Hand</b>						
KL-TFSG-604824R	1867	29	60	24	7.26	123.35
KL-TFSG-664824R	1898	29	66	24	7.94	129.35
KL-TFSG-724824R	1932	29	72	24	8.62	135.35
KL-TFSG-784824R	1965	29	78	24	9.3	141.35
KL-TFSG-844824R	1998	29	84	24	9.98	147.35

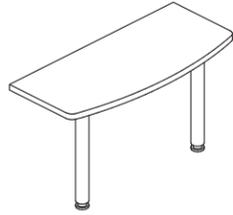

This table is semi-supported and must be used against freestanding furniture. It is typically used as an additional surface in conjunction with two workstation returns.

U-Table, 1.5" Thick Surface

**Ordering Options:**

Use the following checklist to customize the finishes on your order:

- laminate
- trim color
- edge profile
- grommet color
- metal color (posts)

Each laminate comes with matching vinyl trim color unless otherwise specified on your purchase order. Refer to the laminate finish card for our current offering.

**Details:**

Item includes worksurface, 2 post legs, and mounting hardware.

Code	Price	H	W	D	Volume (ft <sup>3</sup> )	Weight (lb)
T-WEU0-4224	921	29.5	42	24	2.98	51.19
T-WEU0-4824	952	29.5	48	24	3.37	56.54
T-WEU0-6024	1123	29.5	60	24	4.15	61.88



This table is semi-supported and must be used against freestanding furniture. It is typically used as an additional surface in conjunction with two workstation returns.

**Ordering Options:**

Use the following checklist to customize the finishes on your order:

- laminate
- trim color
- grommet color
- metal color (posts)

Each laminate comes with matching vinyl trim color unless otherwise specified on your purchase order. Refer to the laminate finish card for our current offering.

**Details:**

Code	Price	H	W	D	Volume (ft <sup>3</sup> )	Weight (lb)
TL-WEU0-4224	795	29	42	24	2.98	38.79
TL-WEU0-4824	826	29	48	24	3.37	42.36
TL-WEU0-6024	997	29	60	24	4.15	45.92



This table is semi-supported and must be used against freestanding furniture. It is typically used as an additional surface in conjunction with two workstation returns.

D-Table, 1.5" Thick Surface

**Ordering Options:**

Use the following checklist to customize the finishes on your order:

- laminate
- trim color
- edge profile
- grommet color
- metal color (posts)

Each laminate comes with matching vinyl trim color unless otherwise specified on your purchase order. Refer to the laminate finish card for our current offering.

**Details:**

Item includes worksurface, one post leg, and mounting hardware.

Code	Price	H	W	D	Volume (ft <sup>3</sup> )	Weight (lb)
T-TC00-4221	663	29.5	42	21	2	34
T-TC00-4824	763	29.5	48	24	2.53	42.1
T-TC00-6030	859	29.5	60	30	3.78	50



This table is semi-supported and must be used against freestanding furniture. It is typically used as an additional surface in conjunction with two workstation returns.

**Ordering Options:**

Use the following checklist to customize the finishes on your order:

- laminate
- trim color
- grommet color
- metal color (posts)

Each laminate comes with matching vinyl trim color unless otherwise specified on your purchase order. Refer to the laminate finish card for our current offering.

**Details:**

Item includes worksurface, one post leg, and mounting hardware.

Code	Price	H	W	D	Volume (ft <sup>3</sup> )	Weight (lb)
TL-TC00-4221	617	29	42	21	2	25
TL-TC00-4824	714	29	48	24	2.53	30.56
TL-TC00-6030	813	29	60	30	3.78	36.12



Metro Collab  
July 2023  
**Corners**

corners

Executive

<u>straight front corner surface</u>	
<u>full modesty</u>	52
<u>partial modesty</u>	54
<u>curved front corner surface</u>	
<u>full modesty</u>	56
<u>partial modesty</u>	58

Professional

<u>straight front corner surface</u>	
<u>full modesty</u>	53
<u>partial modesty</u>	55
<u>curved front corner surface</u>	
<u>full modesty</u>	57
<u>partial modesty</u>	59

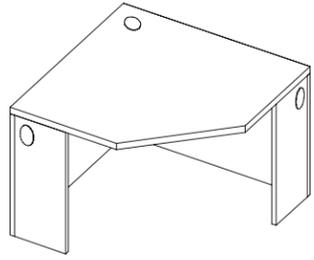

This item is for use in corners when connected to returns or bridges.

Straight Front Corner Surface  
Full Modesty, 1.5" Thick Surface

**Ordering Options:**

Use the following checklist to customize the finishes on your order:

- laminate
- trim color
- edge profile
- grommet color

Each laminate comes with matching vinyl trim color unless otherwise specified on your purchase order. Refer to the laminate finish card for our current offering.

**Details:**

Grommets are available in black or silver. Black is the standard grommet option unless otherwise specified on your purchase order.

All gables include grommets.

Code	Price	H	W	D	Volume (ft <sup>3</sup> )	Weight (lb)
K-W5S0-3618	1021	29.5	36	18	2.55	112.69
K-W5S0-3621	1021	29.5	36	21	2.89	114.3
K-W5S0-3624	1021	29.5	36	24	3.24	116.21
K-W5S0-4221	1202	29.5	42	21	3.33	137.24
K-W5S0-4224	1202	29.5	42	24	3.73	139.52
K-W5S0-4830	1403	29.5	48	30	5.12	177.72

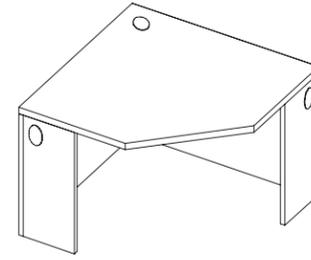

This item is for use in corners when connected to returns or bridges.

Straight Front Corner Surface  
Full Modesty, 1" Thick Surface

**Ordering Options:**

Use the following checklist to customize the finishes on your order:

- laminate
- trim color
- grommet color

Each laminate comes with matching vinyl trim color unless otherwise specified on your purchase order. Refer to the laminate finish card for our current offering.

**Details:**

Grommets are available in black or silver. Black is the standard grommet option unless otherwise specified on your purchase order.

All gables include grommets.

Code	Price	H	W	D	Volume (ft <sup>3</sup> )	Weight (lb)
KL-W5S0-3618	948	29	36	18	2.55	97.93
KL-W5S0-3621	948	29	36	21	2.89	99.2
KL-W5S0-3624	948	29	36	24	3.24	100.27
KL-W5S0-4221	1114	29	42	21	3.33	117.14
KL-W5S0-4224	1114	29	42	24	3.73	118.66
KL-W5S0-4830	1298	29	48	30	5.12	149.83

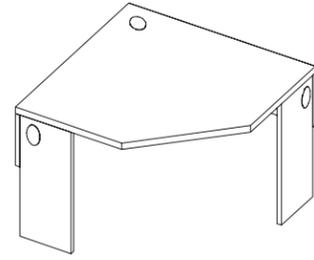

This item is for use in corners when connected to returns or bridges. Partial modesty allows access to electrical outlets when installed against walls.

Straight Front Corner Surface Partial Modesty & Post, 1.5" Thick Surface

**Ordering Options:**

Use the following checklist to customize the finishes on your order:

- laminate
- trim color
- edge profile
- grommet color

Each laminate comes with matching vinyl trim color unless otherwise specified on your purchase order. Refer to the laminate finish card for our current offering.

**Details:**

Partial modesty height 12 inches.  
 Grommets are available in black or silver. Black is the standard grommet option unless otherwise specified on your purchase order.  
 All gables include grommets.  
 Metal post leg included.

Code	Price	H	W	D	Volume (ft <sup>3</sup> )	Weight (lb)
K-W5S0-3618-P	1021	29.5	36	18	2.55	83.12
K-W5S0-3621-P	1021	29.5	36	21	2.89	84.74
K-W5S0-3624-P	1021	29.5	36	24	3.24	86.65
K-W5S0-4221-P	1202	29.5	42	21	3.33	102.88
K-W5S0-4224-P	1202	29.5	42	24	3.73	105.16
K-W5S0-4830-P	1403	29.5	48	30	5.12	138.56

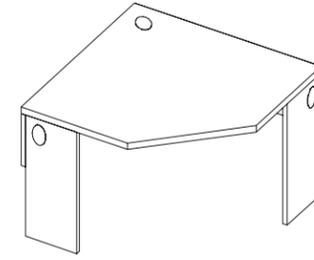

This item is for use in corners when connected to returns or bridges. Partial modesty allows access to electrical outlets when installed against walls.

Straight Front Corner Surface Partial Modesty & Post, 1." Thick Surface

**Ordering Options:**

Use the following checklist to customize the finishes on your order:

- laminate
- trim color
- grommet color

Each laminate comes with matching vinyl trim color unless otherwise specified on your purchase order. Refer to the laminate finish card for our current offering.

**Details:**

Partial modesty height 12 inches.  
 Grommets are available in black or silver. Black is the standard grommet option unless otherwise specified on your purchase order.  
 All gables include grommets.  
 Metal post leg included.

Code	Price	H	W	D	Volume (ft <sup>3</sup> )	Weight (lb)
KL-W5S0-3618-P	948	29	36	18	2.55	68.37
KL-W5S0-3621-P	948	29	36	21	2.89	69.94
KL-W5S0-3624-P	948	29	36	24	3.24	70.71
KL-W5S0-4221-P	1114	29	42	21	3.33	82.78
KL-W5S0-4224-P	1114	29	42	24	3.73	84.3
KL-W5S0-4830-P	1298	29	48	30	5.12	110.67

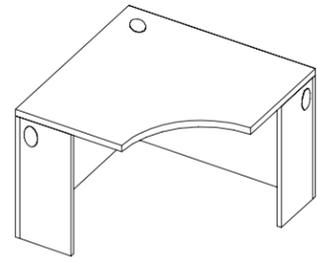

This item is for use in corners when connected to returns or bridges.

Curved Front Corner Surface  
Full Modesty, 1.5" Thick Surface

**Ordering Options:**

Use the following checklist to customize the finishes on your order:

- laminate
- trim color
- edge profile
- grommet color

Each laminate comes with matching vinyl trim color unless otherwise specified on your purchase order. Refer to the laminate finish card for our current offering.

**Details:**

Grommets are available in black or silver. Black is the standard grommet option unless otherwise specified on your purchase order.

All gables include grommets

Code	Price	H	W	D	Volume (ft <sup>3</sup> )	Weight (lb)
K-W5C0-3618	1021	29.5	36	18	2.55	108.9
K-W5C0-3621	1021	29.5	36	21	2.89	112.21
K-W5C0-3624	1021	29.5	36	24	3.24	114.6
K-W5C0-4221	1202	29.5	42	21	3.33	132.52
K-W5C0-4224	1202	29.5	42	24	3.73	136.12
K-W5C0-4830	1403	29.5	48	30	5.12	174.1

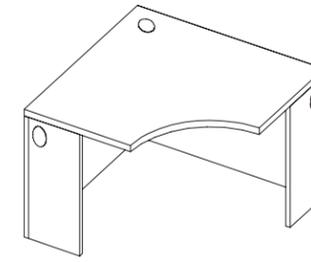

This item is for use in corners when connected to returns or bridges.

Curved Front Corner Surface Full Modesty, 1" Thick Surface

**Ordering Options:**

Use the following checklist to customize the finishes on your order:

- laminate
- trim color
- grommet color

Each laminate comes with matching vinyl trim color unless otherwise specified on your purchase order. Refer to the laminate finish card for our current offering.

**Details:**

Grommets are available in black or silver. Black is the standard grommet option unless otherwise specified on your purchase order.

All gables include grommets

Code	Price	H	W	D	Volume (ft <sup>3</sup> )	Weight (lb)
KL-W5C0-3618	948	29	36	18	2.55	94.5
KL-W5C0-3621	948	29	36	21	2.89	97.54
KL-W5C0-3624	948	29	36	24	3.24	98.3
KL-W5C0-4221	1114	29	42	21	3.33	113.86
KL-W5C0-4224	1114	29	42	24	3.73	116.26
KL-W5C0-4830	1298	29	48	30	5.12	147.42

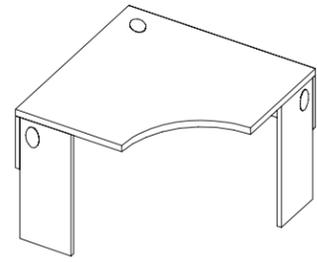

This item is for use in corners when connected to returns or bridges. Partial modesty give access to electrical outlets when installed against walls.

Curved Front Corner Surface  
Partial Modesty & Post,  
1.5" Thick Surface

**Ordering Options:**

Use the following checklist to customize the finishes on your order:

- laminate
- trim color
- edge profile
- grommet color

Each laminate comes with matching vinyl trim color unless otherwise specified on your purchase order. Refer to the laminate finish card for our current offering.

**Details:**

Partial modesty height 12 inches.  
Grommets are available in black or silver. Black is the standard grommet option unless otherwise specified on your purchase order.  
All gables include grommets.  
Metal post included.

Code	Price	H	W	D	Volume (ft <sup>3</sup> )	Weight (lb)
K-W5C0-3618-P	1021	29.5	36	18	2.55	79.33
K-W5C0-3621-P	1021	29.5	36	21	2.89	82.62
K-W5C0-3624-P	1021	29.5	36	24	3.24	85.1
K-W5C0-4221-P	1202	29.5	42	21	3.33	94.27
K-W5C0-4224-P	1202	29.5	42	24	3.73	97.87
K-W5C0-4830-P	1403	29.5	48	30	5.12	127.3

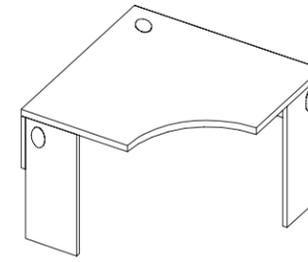

This item is for use in corners when connected to returns or bridges. Partial modesty give access to electrical outlets when installed against walls.

**Ordering Options:**

Use the following checklist to customize the finishes on your order:

- laminate
- trim color
- grommet color

Each laminate comes with matching vinyl trim color unless otherwise specified on your purchase order. Refer to the laminate finish card for our current offering.

**Details:**

Partial modesty height 12 inches.  
Grommets are available in black or silver. Black is the standard grommet option unless otherwise specified on your purchase order.  
All gables include grommets.  
Metal post included.

Code	Price	H	W	D	Volume (ft <sup>3</sup> )	Weight (lb)
KL-W5C0-3618-P	948	29	36	18	2.55	65
KL-W5C0-3621-P	948	29	36	21	2.89	67.98
KL-W5C0-3624-P	948	29	36	24	3.24	68.74
KL-W5C0-4221-P	1114	29	42	21	3.33	75.61
KL-W5C0-4224-P	1114	29	42	24	3.73	78.01
KL-W5C0-4830-P	1298	29	48	30	5.12	100.62

Code	Price	W	D	Description
KL-WTLC-3636	631	36	36	0 29CORNER C/T,F/36X36,1" T8
KL-WTLC-4242	655	42	42	0 CORNER C/T,F/42X42,1" T10
KL-WTLC-4848	691	48	48	0 CORNER C/T,F/48X48,1" T12



Metro Collab  
July 2023  
**Unitized  
Desks**

unitized desks

Executive

curved front unitized desk

full modesty 62

partial modesty 64

Professional

curved front unitized desk

full modesty 63

partial modesty 65

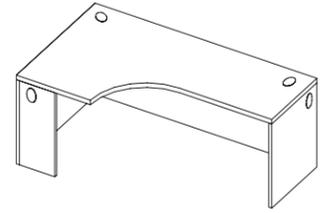

This item is for use in corners when connected to returns or bridges (right hand shown).

Curved Front Unitized Desk Full Modesty, 1.5" Thick Surface

**Ordering Options:**

Use the following checklist to customize the finishes on your order:

- laminate
- trim color
- edge profile
- grommet color

Each laminate comes with matching vinyl trim color unless otherwise specified on your purchase order. Refer to the laminate finish card for our current offering.

**Details:**

Grommets are available in black or silver. Black is the standard grommet option unless otherwise specified on your purchase order.

All gables include grommets.

Code	Price	H	W	D	Volume (ft <sup>3</sup> )	Weight (lb)
K-UC4G-6639-L	1574	29.5	66	39	10.45	146.65
K-UC4G-7239-L	1676	29.5	72	39	11.35	181.17
K-UC4G-6639-R	1574	29.5	66	39	10.45	146.65
K-UC4G-7239-R	1676	29.5	72	39	11.35	181.17
K-UC4G-6642-L	1640	29.5	66	42	11.18	184.39
K-UC4G-7242-L	1965	29.5	72	42	12.14	194.16
K-UC4G-6642-R	1640	29.5	66	42	11.18	184.39
K-UC4G-7242-R	1965	29.5	72	42	12.14	194.16

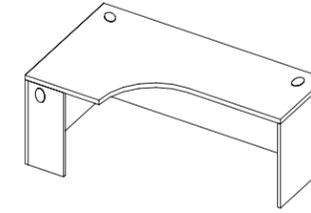

This item is for use in corners when connected to returns or bridges (right hand shown).

**Ordering Options:**

Use the following checklist to customize the finishes on your order:

- laminate
- trim color
- grommet color

Each laminate comes with matching vinyl trim color unless otherwise specified on your purchase order. Refer to the laminate finish card for our current offering.

**Details:**

Grommets are available in black or silver. Black is the standard grommet option unless otherwise specified on your purchase order.

All gables include grommets.

Code	Price	H	W	D	Volume (ft <sup>3</sup> )	Weight (lb)
KL-UC4G-6639-L	1459	29	66	39	10.45	120.6
KL-UC4G-7239-L	1552	29	72	39	11.35	153.9
KL-UC4G-6639-R	1459	29	66	39	10.45	120.6
KL-UC4G-7239-R	1552	29	72	39	11.35	153.9
KL-UC4G-6642-L	1519	29	66	42	11.18	161.1
KL-UC4G-7242-L	1822	29	72	42	12.14	170.55
KL-UC4G-6642-R	1519	29	66	42	11.18	161.1
KL-UC4G-7242-R	1822	29	72	42	12.14	170.55

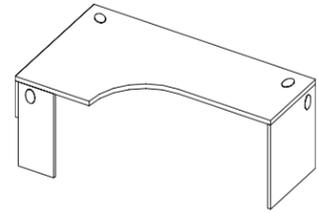

This item is for use in corners when connected to returns or bridges. Partial modesty gives access to electrical outlets when placed against walls (right hand shown).

Curved Front Unitized Desk  
Partial Modesty, 1.5" Thick Surface

**Ordering Options:**

Use the following checklist to customize the finishes on your order:

- laminate
- trim color
- edge profile
- grommet color

Each laminate comes with matching vinyl trim color unless otherwise specified on your purchase order. Refer to the laminate finish card for our current offering.

**Details:**

Partial modesty height 12 inches.  
Grommets are available in black or silver. Black is the standard grommet option unless otherwise specified on your purchase order.  
All gables include grommets

Code	Price	H	W	D	Volume (ft <sup>3</sup> )	Weight (lb)
K-UC4Z-6639-L	1574	29.5	66	39	10.45	146.65
K-UC4Z-7239-L	1676	29.5	72	39	11.35	181.17
K-UC4Z-6639-R	1574	29.5	66	39	10.45	146.65
K-UC4Z-7239-R	1676	29.5	72	39	11.35	181.17
K-UC4Z-6642-L	1640	29.5	66	42	11.18	184.39
K-UC4Z-7242-L	1965	29.5	72	42	12.14	194.16
K-UC4Z-6642-R	1640	29.5	66	42	11.18	184.39
K-UC4Z-7242-R	1965	29.5	72	42	12.14	194.16

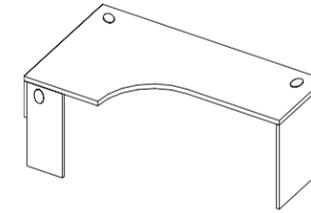

This item is for use in corners when connected to returns or bridges. Partial modesty gives access to electrical outlets when placed against walls (right hand shown).

Curved Front Unitized Desk  
Partial Modesty, 1" Thick Surface

**Ordering Options:**

Use the following checklist to customize the finishes on your order:

- laminate
- trim color
- grommet color

Each laminate comes with matching vinyl trim color unless otherwise specified on your purchase order. Refer to the laminate finish card for our current offering.

**Details:**

Partial modesty height 12 inches.  
Grommets are available in black or silver. Black is the standard grommet option unless otherwise specified on your purchase order.  
All gables include grommets

Code	Price	H	W	D	Volume (ft <sup>3</sup> )	Weight (lb)
KL-UC4Z-6639-L	1459	29	66	39	10.45	99.79
KL-UC4Z-7239-L	1552	29	72	39	11.35	108.77
KL-UC4Z-6639-R	1459	29	66	39	10.45	99.79
KL-UC4Z-7239-R	1552	29	72	39	11.35	108.77
KL-UC4Z-6642-L	1519	29	66	42	11.18	114.66
KL-UC4Z-7242-L	1822	29	72	42	12.14	126.11
KL-UC4Z-6642-R	1519	29	66	42	11.18	114.66
KL-UC4Z-7242-R	1822	29	72	42	12.14	126.11



Metro Collab  
July 2023  
**Bridges**

bridges

Executive

straight bridge

full modesty 68

partial modesty 70

notched bridge

full modesty 72

partial modesty 74

bowed bridge

full modesty 76

partial modesty 78

Professional

straight bridge

full modesty 69

partial modesty 71

notched bridge

full modesty 73

partial modesty 75

bowed bridge

full modesty 77

partial modesty 79

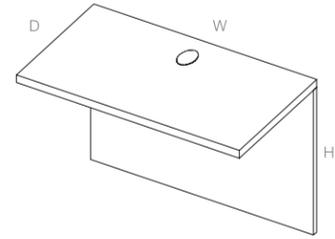

This bridge must be connected to two freestanding desks or credenza. Corners and unitized desks with matching depths can also be connected on either side to complete a workstation.

Straight Bridge Full Modesty, 1.5" Thick Surface

**Ordering Options:**

Use the following checklist to customize the finishes on your order:

- laminate
- trim color
- edge profile
- grommet color

Each laminate comes with matching vinyl trim color unless otherwise specified on your purchase order. Refer to the laminate finish card for our current offering.

**Details:**

Grommets are available in black or silver. Black is the standard grommet option unless otherwise specified on your purchase order.

Code	Price	H	W	D	Volume (ft <sup>3</sup> )	Weight (lb)
K-BS0G-3021	474	29.5	30	21	1.48	46.17
K-BS0G-3621	510	29.5	36	21	1.74	55.5
K-BS0G-4221	569	29.5	42	21	2	64.83
K-BS0G-4821	605	29.5	48	21	2.26	74.16
K-BS0G-3024	495	29.5	30	24	1.65	49.5
K-BS0G-3624	532	29.5	36	24	1.94	60
K-BS0G-4224	590	29.5	42	24	2.24	70.5
K-BS0G-4824	663	29.5	48	24	2.53	81
K-BS0G-3030	532	29.5	30	30	2.01	56.75
K-BS0G-3630	583	29.5	36	30	2.36	68.28
K-BS0G-4230	644	29.5	42	30	2.72	79.81
K-BS0G-4830	726	29.5	48	30	3.07	91.34

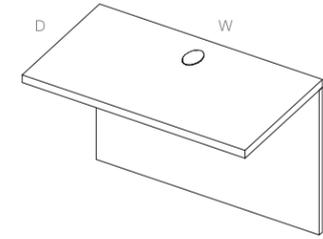

This bridge must be connected to two freestanding desks or credenza. Corners and unitized desks with matching depths can also be connected on either side to complete a workstation.

Straight Bridge Full Modesty, 1" Thick Surface

**Ordering Options:**

Use the following checklist to customize the finishes on your order:

- laminate
- trim color
- grommet color

Each laminate comes with matching vinyl trim color unless otherwise specified on your purchase order. Refer to the laminate finish card for our current offering.

**Details:**

Grommets are available in black or silver. Black is the standard grommet option unless otherwise specified on your purchase order.

Code	Price	H	W	D	Volume (ft <sup>3</sup> )	Weight (lb)
KL-BS0G-1824	447	29	18	24	0	35
KL-BS0G-2421	428	29	24	21	0	40.35
KL-BS0G-2424	447	29	24	24	0	40.35
KL-BS0G-3021	447	29	30	21	1.48	38
KL-BS0G-3024	468	29	30	24	1.65	40.35
KL-BS0G-3030	501	29	30	30	2.01	45.03
KL-BS0G-3621	482	29	36	21	1.74	45.78
KL-BS0G-3624	501	29	36	24	1.94	48.6
KL-BS0G-3630	547	29	36	30	2.36	54.22
KL-BS0G-4221	536	29	42	21	2	53.56
KL-BS0G-4224	553	29	42	24	2.24	56.85
KL-BS0G-4230	605	29	42	30	2.72	63.41
KL-BS0G-4821	573	29	48	21	2.26	61.34
KL-BS0G-4824	627	29	48	24	2.53	65.1
KL-BS0G-4830	684	29	48	30	3.07	72.6
KL-BS0G-5421	685	29	54	21	0	54
KL-BS0G-5424	685	29	54	24	0	0
KL-BS0G-6024	685	29	60	24	0	0

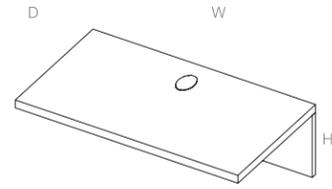

This bridge must be connected to two freestanding desks or credenza. Corners and unitized desks with matching depths can also be connected on either side. Partial modesty gives access to electrical outlets when installed against walls.

Straight Bridge Partial Modesty, 1.5" Thick Surface

**Ordering Options:**

Use the following checklist to customize the finishes on your order:

- laminate
- trim color
- edge profile
- grommet color

Each laminate comes with matching vinyl trim color unless otherwise specified on your purchase order. Refer to the laminate finish card for our current offering.

**Details:**

Partial modesty height 12 inches.

Grommets are available in black or silver. Black is the standard grommet option unless otherwise specified on your purchase order.

Code	Price	H	W	D	Volume (ft <sup>3</sup> )	Weight (lb)
K-BS0Z-3021	474	29.5	30	21	1.48	33.67
K-BS0Z-3621	510	29.5	36	21	1.74	43
K-BS0Z-4221	569	29.5	42	21	2	52.33
K-BS0Z-4821	605	29.5	48	21	2.26	61.66
K-BS0Z-3024	495	29.5	30	24	1.65	33.3
K-BS0Z-3624	532	29.5	36	24	1.94	43.8
K-BS0Z-4224	590	29.5	42	24	2.24	54.3
K-BS0Z-4824	663	29.5	48	24	2.53	64.8
K-BS0Z-3030	532	29.5	30	30	2.01	44.1
K-BS0Z-3630	583	29.5	36	30	2.36	55.63
K-BS0Z-4230	644	29.5	42	30	2.72	67.16
K-BS0Z-4830	726	29.5	48	30	3.07	78.69

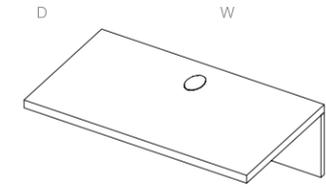

This bridge must be connected to two freestanding desks or credenza. Corners and unitized desks with matching depths can also be connected on either side. Partial modesty gives access to electrical outlets when installed against walls.

Straight Bridge Partial Modesty, 1" Thick Surface

**Ordering Options:**

Use the following checklist to customize the finishes on your order:

- laminate
- trim color
- grommet color

Each laminate comes with matching vinyl trim color unless otherwise specified on your purchase order. Refer to the laminate finish card for our current offering.

**Details:**

Grommets are available in black or silver. Black is the standard grommet option unless otherwise specified on your purchase order.

Code	Price	H	W	D	Volume (ft <sup>3</sup> )	Weight (lb)
KL-BS0Z-1818	392	29	18	18	0	40
KL-BS0Z-1824	414	29	18	24	0	52.5
KL-BS0Z-2421	428	29	24	21	0	27.75
KL-BS0Z-2424	447	29	24	24	0	27.75
KL-BS0Z-2924	468	29	29	24	0	27.75
KL-BS0Z-3021	447	29	30	21	1.48	25.4
KL-BS0Z-3024	468	29	30	24	1.65	27.75
KL-BS0Z-3030	501	29	30	30	2.01	32.43
KL-BS0Z-3621	482	29	36	21	1.74	33.18
KL-BS0Z-3624	501	29	36	24	1.94	36
KL-BS0Z-3630	547	29	36	30	2.36	41.62
KL-BS0Z-4221	536	29	42	21	2	40.96

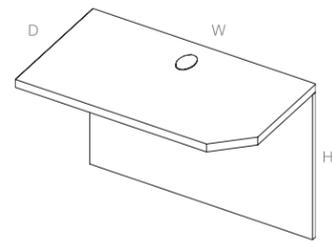

This bridge must be connected to two freestanding desks or credenza. Corners and unitized desks with matching depths can also be connected on either side to complete a workstation. Works with Straight Front Corners

(left hand shown).

Notched Bridge Full Modesty, 1.5" Thick Surface

**Ordering Options:**

Use the following checklist to customize the finishes on your order:

- laminate
- trim color
- edge profile
- grommet color

Each laminate comes with matching vinyl trim color unless otherwise specified on your purchase order. Refer to the laminate finish card for our current offering.

**Details:**

Grommets are available in black or silver. Black is the standard grommet option unless otherwise specified on your purchase order.

Code	Price	H	W	D	Volume (ft <sup>3</sup> )	Weight (lb)
K-BN0G-3624-L	583	29.5	36	24	1.94	59.1
K-BN0G-4224-L	644	29.5	42	24	2.24	68.87
K-BN0G-4824-L	726	29.5	48	24	2.53	78.64
K-BN0G-3624-R	583	29.5	36	24	1.94	59.1
K-BN0G-4224-R	644	29.5	42	24	2.24	68.87
K-BN0G-4824-R	726	29.5	48	24	2.53	78.64
K-BN0G-3630-L	602	29.5	36	30	2.36	67.58
K-BN0G-4230-L	663	29.5	42	30	2.72	79.11
K-BN0G-4830-L	745	29.5	48	30	3.07	90.64
K-BN0G-3630-R	602	29.5	36	30	2.36	67.58
K-BN0G-4230-R	663	29.5	42	30	2.72	79.11
K-BN0G-4830-R	745	29.5	48	30	3.07	90.64

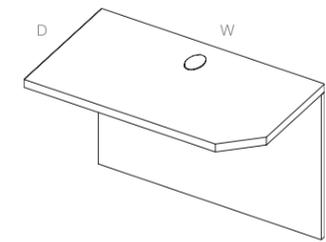

This bridge must be connected to two freestanding desks or credenza. Corners and unitized desks with matching depths can also be connected on either side to complete a workstation. Works with Straight Front Corners

(left hand shown).

Notched Bridge Full Modesty, 1.5" Thick Surface

**Ordering Options:**

Use the following checklist to customize the finishes on your order:

- laminate
- trim color
- grommet color

Each laminate comes with matching vinyl trim color unless otherwise specified on your purchase order. Refer to the laminate finish card for our current offering.

**Details:**

Grommets are available in black or silver. Black is the standard grommet option unless otherwise specified on your purchase order.

Code	Price	H	W	D	Volume (ft <sup>3</sup> )	Weight (lb)
KL-BN0G-3624-L	547	29	36	24	1.94	48.13
KL-BN0G-3624-R	547	29	36	24	1.94	48.13
KL-BN0G-3630-L	569	29	36	30	2.36	58.25
KL-BN0G-3630-R	569	29	36	30	2.36	58.25
KL-BN0G-4224-L	605	29	42	24	2.24	56.38
KL-BN0G-4224-R	605	29	42	24	2.24	56.38
KL-BN0G-4230-L	627	29	42	30	2.72	66.48
KL-BN0G-4230-R	627	29	42	30	2.72	66.48
KL-BN0G-4824-L	684	29	48	24	2.53	64.63
KL-BN0G-4824-R	684	29	48	24	2.53	64.63
KL-BN0G-4830-L	702	29	48	30	3.07	74.71
KL-BN0G-4830-R	702	29	48	30	3.07	74.71

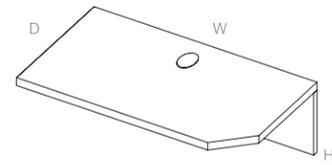

This bridge must be connected to two freestanding desks or credenza. Corners and unitized desks with matching depths can also be connected on either side. Partial modesty gives access to electrical outlets when installed against walls.

Notched Bridge Partial Modesty, 1.5" Thick Surface

**Ordering Options:**

Use the following checklist to customize the finishes on your order:

- laminate
- trim color
- edge profile
- grommet color

Each laminate comes with matching vinyl trim color unless otherwise specified on your purchase order. Refer to the laminate finish card for our current offering.

**Details:**

Partial modesty height 12 inches.

Grommets are available in black or silver. Black is the standard grommet option unless otherwise specified on your purchase order.

Code	Price	H	W	D	Volume (ft <sup>3</sup> )	Weight (lb)
K-BN0Z-3624-L	583	29.5	36	24	1.94	44.29
K-BN0Z-4224-L	644	29.5	42	24	2.24	54.06
K-BN0Z-4824-L	726	29.5	48	24	2.53	63.83
K-BN0Z-3624-R	583	29.5	36	24	1.94	44.29
K-BN0Z-4224-R	644	29.5	42	24	2.24	54.06
K-BN0Z-4824-R	726	29.5	48	24	2.53	63.83
K-BN0Z-3630-L	602	29.5	36	30	2.36	52.65
K-BN0Z-4230-L	663	29.5	42	30	2.72	64.18
K-BN0Z-4830-L	745	29.5	48	30	3.07	75.71
K-BN0Z-3630-R	602	29.5	36	30	2.36	52.65
K-BN0Z-4230-R	663	29.5	42	30	2.72	64.18
K-BN0Z-4830-R	745	29.5	48	30	3.07	75.71

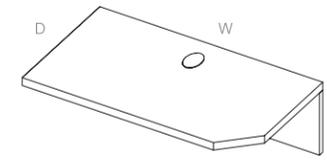

This bridge must be connected to two freestanding desks or credenza. Corners and unitized desks with matching depths can also be connected on either side. Partial modesty gives access to electrical outlets when installed against walls.

Notched Bridge Partial Modesty, 1" Thick Surface

**Ordering Options:**

Use the following checklist to customize the finishes on your order:

- laminate
- trim color
- grommet color

Each laminate comes with matching vinyl trim color unless otherwise specified on your purchase order. Refer to the laminate finish card for our current offering.

**Details:**

Partial modesty height 12 inches.

Grommets are available in black or silver. Black is the standard grommet option unless otherwise specified on your purchase order.

Code	Price	H	W	D	Volume (ft <sup>3</sup> )	Weight (lb)
KL-BN0Z-3624-L	547	29	36	24	1.94	32.85
KL-BN0Z-3624-R	547	29	36	24	1.94	32.85
KL-BN0Z-3630-L	569	29	36	30	2.36	38.9
KL-BN0Z-3630-R	569	29	36	30	2.36	38.9
KL-BN0Z-4224-L	605	29	42	24	2.24	41.1
KL-BN0Z-4224-R	605	29	42	24	2.24	41.1
KL-BN0Z-4230-L	627	29	42	30	2.72	47.13
KL-BN0Z-4230-R	627	29	42	30	2.72	47.13
KL-BN0Z-4824-L	684	29	48	24	2.53	49.35
KL-BN0Z-4824-R	684	29	48	24	2.53	49.35
KL-BN0Z-4830-L	702	29	48	30	3.07	55.36
KL-BN0Z-4830-R	702	29	48	30	3.07	55.36
No Grommet						
KL-BS00-4830	651	29	48	30	3.07	55.36

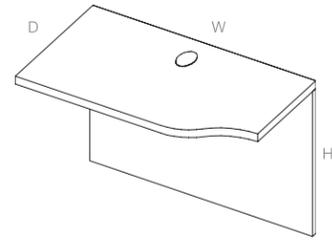

This bridge must be connected to two freestanding desks or credenza. Corners and unitized desks with matching depths can also be connected on either side. Partial modesty gives access to electrical outlets when installed against walls. Works with Curved Front Corners (left hand shown).

Bowed Bridge Full Modesty, 1.5" Thick Surface

**Ordering Options:**

Use the following checklist to customize the finishes on your order:

- laminate
- trim color
- edge profile
- grommet color

Each laminate comes with matching vinyl trim color unless otherwise specified on your purchase order. Refer to the laminate finish card for our current offering.

**Details:**

Grommets are available in black or silver. Black is the standard grommet option unless otherwise specified on your purchase order.

Code	Price	H	W	D	Volume (ft <sup>3</sup> )	Weight (lb)
K-BB0G-3624-L	583	29.5	36	24	1.94	58.03
K-BB0G-4224-L	644	29.5	42	24	2.24	68.16
K-BB0G-4824-L	726	29.5	48	24	2.53	78.29
K-BB0G-3624-R	583	29.5	36	24	1.94	58.03
K-BB0G-4224-R	644	29.5	42	24	2.24	68.16
K-BB0G-4824-R	726	29.5	48	24	2.53	78.29
K-BB0G-3630-L	602	29.5	36	30	2.36	66.47
K-BB0G-4230-L	663	29.5	42	30	2.72	78
K-BB0G-4830-L	745	29.5	48	30	3.07	89.53
K-BB0G-3630-R	602	29.5	36	30	2.36	66.47
K-BB0G-4230-R	663	29.5	42	30	2.72	78
K-BB0G-4830-R	745	29.5	48	30	3.07	89.53

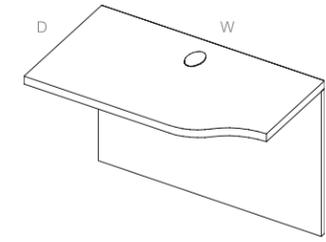

This bridge must be connected to two freestanding desks or credenza. Corners and unitized desks with matching depths can also be connected on either side. Partial modesty gives access to electrical outlets when installed against walls. Works with Curved Front Corners (left hand shown).

Bowed Bridge Full Modesty, 1" Thick Surface

**Ordering Options:**

Use the following checklist to customize the finishes on your order:

- laminate
- trim color
- grommet color

Each laminate comes with matching vinyl trim color unless otherwise specified on your purchase order. Refer to the laminate finish card for our current offering.

**Details:**

Grommets are available in black or silver. Black is the standard grommet option unless otherwise specified on your purchase order.

Code	Price	H	W	D	Volume (ft <sup>3</sup> )	Weight (lb)
KL-BB0G-2430-L	571	29	24	30	0	48
KL-BB0G-2430-R	571	29	24	30	0	48
KL-BB0G-3624-L	547	29	36	24	1.94	47.39
KL-BB0G-3624-R	547	29	36	24	1.94	47.39
KL-BB0G-3630-L	569	29	36	30	2.36	53
KL-BB0G-3630-R	569	29	36	30	2.36	53
KL-BB0G-4224-L	605	29	42	24	2.24	55.64
KL-BB0G-4224-R	605	29	42	24	2.24	55.64
KL-BB0G-4230-L	627	29	42	30	2.72	62.2
KL-BB0G-4230-R	627	29	42	30	2.72	62.2
KL-BB0G-4824-L	684	29	48	24	2.53	63.89
KL-BB0G-4824-R	684	29	48	24	2.53	63.89
KL-BB0G-4830-L	702	29	48	30	3.07	71.4
KL-BB0G-4830-R	702	29	48	30	3.07	71.4

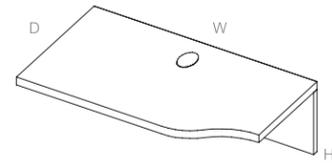

Bowed Bridge Partial Modesty, 1.5" Thick Surface

This bridge must be connected to two freestanding desks or credenza. Corners and unitized desks with matching depths can also be connected on either side. Partial modesty gives access to electrical outlets when installed against walls.

**Ordering Options:**

Use the following checklist to customize the finishes on your order:

- laminate
- trim color
- edge profile
- grommet color

Each laminate comes with matching vinyl trim color unless otherwise specified on your purchase order. Refer to the laminate finish card for our current offering.

**Details:**

Partial modesty height 12 inches.

Grommets are available in black or silver. Black is the standard grommet option unless otherwise specified on your purchase order.

Code	Price	H	W	D	Volume (ft <sup>3</sup> )	Weight (lb)
K-BB0Z-3624-L	583	29.5	36	24	1.94	42.75
K-BB0Z-4224-L	644	29.5	42	24	2.24	52.88
K-BB0Z-4824-L	726	29.5	48	24	2.53	63.01
K-BB0Z-3624-R	583	29.5	36	24	1.94	42.75
K-BB0Z-4224-R	644	29.5	42	24	2.24	52.88
K-BB0Z-4824-R	726	29.5	48	24	2.53	63.01
K-BB0Z-3630-L	602	29.5	36	30	2.36	51.13
K-BB0Z-4230-L	663	29.5	42	30	2.72	62.66
K-BB0Z-4830-L	745	29.5	48	30	3.07	74.19
K-BB0Z-3630-R	602	29.5	36	30	2.36	51.13
K-BB0Z-4230-R	663	29.5	42	30	2.72	62.66
K-BB0Z-4830-R	745	29.5	48	30	3.07	74.19

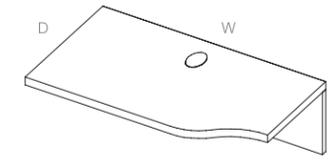

Bowed Bridge Partial Modesty, 1" Thick Surface

This bridge must be connected to two freestanding desks or credenza. Corners and unitized desks with matching depths can also be connected on either side. Partial modesty gives access to electrical outlets when installed against walls.

**Ordering Options:**

Use the following checklist to customize the finishes on your order:

- laminate
- trim color
- grommet color

Each laminate comes with matching vinyl trim color unless otherwise specified on your purchase order. Refer to the laminate finish card for our current offering.

**Details:**

Partial modesty height 12 inches.

Grommets are available in black or silver. Black is the standard grommet option unless otherwise specified on your purchase order.

Code	Price	H	W	D	Volume (ft <sup>3</sup> )	Weight (lb)
KL-BB0Z-3624-L	547	29	36	24	1.94	30.29
KL-BB0Z-3624-R	547	29	36	24	1.94	30.29
KL-BB0Z-3630-L	569	29	36	30	2.36	38.16
KL-BB0Z-3630-R	569	29	36	30	2.36	38.16
KL-BB0Z-4224-L	605	29	42	24	2.24	38.54
KL-BB0Z-4224-R	605	29	42	24	2.24	38.54
KL-BB0Z-4230-L	627	29	42	30	2.72	47.36
KL-BB0Z-4230-R	627	29	42	30	2.72	47.36
KL-BB0Z-4824-L	684	29	48	24	2.53	46.79
KL-BB0Z-4824-R	684	29	48	24	2.53	46.79
KL-BB0Z-4830-L	702	29	48	30	3.07	56.56
KL-BB0Z-4830-R	702	29	48	30	3.07	56.56



Metro Collab  
July 2023  
**Returns**

returns

Executive

straight return	
full modesty	82
partial modesty	86
notched return	
full modesty	90
partial modesty	94
bowed return	
full modesty	98
partial modesty	102

Professional

straight return	
full modesty	84
partial modesty	88
notched return	
full modesty	92
partial modesty	96
bowed return	
full modesty	100
partial modesty	104

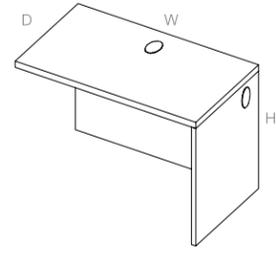

This return is semi-supported, it must be connected to a freestanding desk, corner desk or credenza. Allows for fixed and modular underdesk storage (right hand shown).

Straight Return Full Modesty, 1.5" Thick Surface

**Ordering Options:**

Use the following checklist to customize the finishes on your order:

- laminate
- trim color
- edge profile
- grommet color

Each laminate comes with matching vinyl trim color unless otherwise specified on your purchase order. Refer to the laminate finish card for our current offering.

**Details:**

Grommets are available in black or silver. Black is the standard grommet option unless otherwise specified on your purchase order.

Surfaces up to and including 48" wide have one grommet located at the back center of the surface. Surfaces 54" wide and greater have two grommets at either side of the back of the surface.

All gables include grommets.

Code	Price	H	W	D	Volume (ft <sup>3</sup> )	Weight (lb)
K-WS1G-2421-L	694	29.5	24	21	1.62	51.3
K-WS1G-2421-R	694	29.5	24	21	1.62	51.3
K-WS1G-2424-L	703	29.5	24	24	1.81	56.65
K-WS1G-2424-R	703	29.5	24	24	1.81	56.65
K-WS1G-2430-L	765	29.5	24	30	2.2	66.42
K-WS1G-2430-R	765	29.5	24	30	2.2	66.42
K-WS1G-3021-L	703	29.5	30	21	1.97	60.74
K-WS1G-3021-R	703	29.5	30	21	1.97	60.74
K-WS1G-3024-L	713	29.5	30	24	2.2	65.92
K-WS1G-3024-R	713	29.5	30	24	2.2	65.92
K-WS1G-3030-L	784	29.5	30	30	2.68	77.42
K-WS1G-3030-R	784	29.5	30	30	2.68	77.42

Code	Price	H	W	D	Volume (ft <sup>3</sup> )	Weight (lb)
K-WS1G-3621-L	713	29.5	36	21	2.31	70.18
K-WS1G-3621-R	713	29.5	36	21	2.31	70.18
K-WS1G-3624-L	726	29.5	36	24	2.59	75.19
K-WS1G-3624-R	726	29.5	36	24	2.59	75.19
K-WS1G-3630-L	813	29.5	36	30	3.15	88.42
K-WS1G-3630-R	813	29.5	36	30	3.15	88.42
K-WS1G-4221-L	726	29.5	42	21	2.66	79.62
K-WS1G-4221-R	726	29.5	42	21	2.66	79.62
K-WS1G-4224-L	745	29.5	42	24	2.98	84.46
K-WS1G-4224-R	745	29.5	42	24	2.98	84.46
K-WS1G-4230-L	846	29.5	42	30	3.62	99.42
K-WS1G-4230-R	846	29.5	42	30	3.62	99.42
K-WS1G-4821-L	765	29.5	48	21	3.01	89.06
K-WS1G-4821-R	765	29.5	48	21	3.01	89.06
K-WS1G-4824-L	784	29.5	48	24	3.37	93.73
K-WS1G-4824-R	784	29.5	48	24	3.37	93.73
K-WS1G-4830-L	873	29.5	48	30	4.09	110.42
K-WS1G-4830-R	873	29.5	48	30	4.09	110.42
K-WS1G-5421-L	803	29.5	54	21	3.36	98.5
K-WS1G-5421-R	803	29.5	54	21	3.36	98.5
K-WS1G-5424-L	823	29.5	54	24	3.76	103
K-WS1G-5424-R	823	29.5	54	24	3.76	103
K-WS1G-5430-L	903	29.5	54	30	4.56	121.42
K-WS1G-5430-R	903	29.5	54	30	4.56	121.42
K-WS1G-6021-L	846	29.5	60	21	3.7	107.94
K-WS1G-6021-R	846	29.5	60	21	3.7	107.94
K-WS1G-6024-L	866	29.5	60	24	4.15	112.27
K-WS1G-6024-R	866	29.5	60	24	4.15	112.27
K-WS1G-6030-L	954	29.5	60	30	5.04	132.42
K-WS1G-6030-R	954	29.5	60	30	5.04	132.42

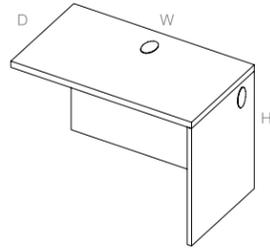

This return is semi-supported, it must be connected to a freestanding desk, corner desk or credenza. Allows for fixed and modular underdesk storage (right hand shown).

Straight Return Full Modesty, 1" Thick Surface

**Ordering Options:**

Use the following checklist to customize the finishes on your order:

- laminate
- trim color
- grommet color

Each laminate comes with matching vinyl trim color unless otherwise specified on your purchase order. Refer to the laminate finish card for our current offering.

**Details:**

Grommets are available in black or silver. Black is the standard grommet option unless otherwise specified on your purchase order.

Surfaces up to and including 48" wide have one grommet located at the back center of the surface. Surfaces 54" wide and greater have two grommets at either side of the back of the surface.

All gables include grommets.

Code	Price	H	W	D	Volume (ft <sup>3</sup> )	Weight (lb)
KL-WS1G-3621-L	590	29	36	21	2.31	59.8
KL-WS1G-3621-R	590	29	36	21	2.31	59.8
KL-WS1G-3624-L	597	29	36	24	2.59	64.35
KL-WS1G-3624-R	597	29	36	24	2.59	64.35
KL-WS1G-3630-L	689	29	36	30	3.15	74.76
KL-WS1G-3630-R	689	29	36	30	3.15	74.76
KL-WS1G-4221-L	597	29	42	21	2.66	67.2
KL-WS1G-4221-R	597	29	42	21	2.66	67.2
KL-WS1G-4224-L	618	29	42	24	2.98	72.15
KL-WS1G-4224-R	618	29	42	24	2.98	72.15
KL-WS1G-4230-L	716	29	42	30	3.62	83.79
KL-WS1G-4230-R	716	29	42	30	3.62	83.79

Code	Price	H	W	D	Volume (ft <sup>3</sup> )	Weight (lb)
KL-WS1G-4821-L	638	29	48	21	3.01	74.6
KL-WS1G-4821-R	638	29	48	21	3.01	74.6
KL-WS1G-4824-L	657	29	48	24	3.37	79.95
KL-WS1G-4824-R	657	29	48	24	3.37	79.95
KL-WS1G-4830-L	748	29	48	30	4.09	92.82
KL-WS1G-4830-R	748	29	48	30	4.09	92.82
KL-WS1G-5421-L	678	29	54	21	3.36	82
KL-WS1G-5421-R	678	29	54	21	3.36	82
KL-WS1G-5424-L	699	29	54	24	3.76	87.75
KL-WS1G-5424-R	699	29	54	24	3.76	87.75
KL-WS1G-5430-L	781	29	54	30	4.56	101.85
KL-WS1G-5430-R	781	29	54	30	4.56	101.85
KL-WS1G-6021-L	716	29	60	21	3.7	89.4
KL-WS1G-6021-R	716	29	60	21	3.7	89.4
KL-WS1G-6024-L	739	29	60	24	4.15	95.55
KL-WS1G-6024-R	739	29	60	24	4.15	95.55
KL-WS1G-6030-L	831	29	60	30	5.04	110.88
KL-WS1G-6030-R	831	29	60	30	5.04	110.88
KL-WS1Z-1824-L	579	29	18	24	0	30
K-WS1G-5421-R	803	29.5	54	21	3.36	98.5
K-WS1G-5424-L	823	29.5	54	24	3.76	103
K-WS1G-5424-R	823	29.5	54	24	3.76	103
K-WS1G-5430-L	903	29.5	54	30	4.56	121.42
K-WS1G-5430-R	903	29.5	54	30	4.56	121.42
K-WS1G-6021-L	846	29.5	60	21	3.7	107.94
K-WS1G-6021-R	846	29.5	60	21	3.7	107.94
K-WS1G-6024-L	866	29.5	60	24	4.15	112.27
K-WS1G-6024-R	866	29.5	60	24	4.15	112.27
K-WS1G-6030-L	954	29.5	60	30	5.04	132.42
K-WS1G-6030-R	954	29.5	60	30	5.04	132.42

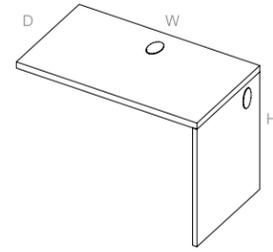

This return is semi-supported, it must be connected to a freestanding desk, corner desk or credenza. Allows for fixed and modular underdesk storage. Partial modesty gives access to electrical outlets when installed against walls (right hand shown).

Straight Return Partial Modesty, 1.5" Thick Surface

**Ordering Options:**

Use the following checklist to customize the finishes on your order:

- laminate
- trim color
- edge profile
- grommet color

Each laminate comes with matching vinyl trim color unless otherwise specified on your purchase order. Refer to the laminate finish card for our current offering.

**Details:**

Grommets are available in black or silver. Black is the standard grommet option unless otherwise specified on your purchase order.

Surfaces up to and including 48" wide have one grommet located at the back center of the surface. Surfaces 54" wide and greater have two grommets at either side of the back of the surface.

All gables include grommets.

Code	Price	H	W	D	Volume (ft <sup>3</sup> )	Weight (lb)
K-WS1Z-2421-L	694	29.5	24	21	1.62	41.4
K-WS1Z-2421-R	694	29.5	24	21	1.62	41.4
K-WS1Z-2424-L	703	29.5	24	24	1.81	46.35
K-WS1Z-2424-R	703	29.5	24	24	1.81	46.35
K-WS1Z-2430-L	765	29.5	24	30	2.2	58.5
K-WS1Z-2430-R	765	29.5	24	30	2.2	58.5
K-WS1Z-3021-L	703	29.5	30	21	1.97	48.66
K-WS1Z-3021-R	703	29.5	30	21	1.97	48.66
K-WS1Z-3024-L	713	29.5	30	24	2.2	55.62
K-WS1Z-3024-R	713	29.5	30	24	2.2	55.62
K-WS1Z-3030-L	784	29.5	30	30	2.68	69.5
K-WS1Z-3030-R	784	29.5	30	30	2.68	69.5

Code	Price	H	W	D	Volume (ft <sup>3</sup> )	Weight (lb)
K-WS1Z-3621-L	713	29.5	36	21	2.31	58.1
K-WS1Z-3621-R	713	29.5	36	21	2.31	58.1
K-WS1Z-3624-L	726	29.5	36	24	2.59	64.89
K-WS1Z-3624-R	726	29.5	36	24	2.59	64.89
K-WS1Z-3630-L	813	29.5	36	30	3.15	80.5
K-WS1Z-3630-R	813	29.5	36	30	3.15	80.5
K-WS1Z-4221-L	726	29.5	42	21	2.66	67.54
K-WS1Z-4221-R	726	29.5	42	21	2.66	67.54
K-WS1Z-4224-L	745	29.5	42	24	2.98	74.16
K-WS1Z-4224-R	745	29.5	42	24	2.98	74.16
K-WS1Z-4230-L	846	29.5	42	30	3.62	91.5
K-WS1Z-4230-R	846	29.5	42	30	3.62	91.5
K-WS1Z-4821-L	765	29.5	48	21	3.01	76.98
K-WS1Z-4821-R	765	29.5	48	21	3.01	76.98
K-WS1Z-4824-L	784	29.5	48	24	3.37	83.43
K-WS1Z-4824-R	784	29.5	48	24	3.37	83.43
K-WS1Z-4830-L	873	29.5	48	30	4.09	102.5
K-WS1Z-4830-R	873	29.5	48	30	4.09	102.5
K-WS1Z-5421-L	803	29.5	54	21	3.36	86.42
K-WS1Z-5421-R	803	29.5	54	21	3.36	86.42
K-WS1Z-5424-L	823	29.5	54	24	3.76	92.7
K-WS1Z-5424-R	823	29.5	54	24	3.76	92.7
K-WS1Z-5430-L	903	29.5	54	30	4.56	113.5
K-WS1Z-5430-R	903	29.5	54	30	4.56	113.5
K-WS1Z-6021-L	846	29.5	60	21	3.7	95.86
K-WS1Z-6021-R	846	29.5	60	21	3.7	95.86
K-WS1Z-6024-L	866	29.5	60	24	4.15	101.97
K-WS1Z-6024-R	866	29.5	60	24	4.15	101.97
K-WS1Z-6030-L	954	29.5	60	30	5.04	124.5
K-WS1Z-6030-R	954	29.5	60	30	5.04	124.5

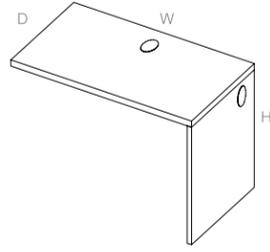

This return is semi-supported, it must be connected to a freestanding desk, corner desk or credenza. Allows for fixed and modular underdesk storage. Partial modesty gives access to electrical outlets when installed against walls

(right hand shown).

Straight Return Partial Modesty, 1" Thick Surface

**Ordering Options:**

Use the following checklist to customize the finishes on your order:

- laminate
- trim color
- grommet color

Each laminate comes with matching vinyl trim color unless otherwise specified on your purchase order. Refer to the laminate finish card for our current offering.

**Details:**

Grommets are available in black or silver. Black is the standard grommet option unless otherwise specified on your purchase order.

Surfaces up to and including 48" wide have one grommet located at the back center of the surface. Surfaces 54" wide and greater have two grommets at either side of the back of the surface.

All gables include grommets.

Code	Price	H	W	D	Volume (ft <sup>3</sup> )	Weight (lb)
KL-WS1Z-1824-R	579	29	18	24	0	35.5
KL-WS1Z-2424-R-UW	579	29	24	24	0	36.9
KL-WS1Z-3024-R-UW	590	29	30	24	2.2	44.7
KL-WS1Z-3624-R-UW	601	29	36	24	2.59	52.5
KL-WS1Z-3636-L	785	29	36	36	0	75
KL-WS1Z-4024-R	618	29	40	24	0	60
KL-WS1Z-4221-L-UW	601	29	42	21	2.66	57.3
KL-WS1Z-4221-R-UW	601	29	42	21	2.66	57.3
KL-WS1Z-4224-L-UW	618	29	42	24	2.98	60.3
KL-WS1Z-4224-R-UW	618	29	42	24	2.98	60.3

Code	Price	H	W	D	Volume (ft <sup>3</sup> )	Weight (lb)
KL-WS1Z-4230-L-UW	717	29	42	30	3.62	76.44
KL-WS1Z-4230-R-UW	717	29	42	30	3.62	76.44
KL-WS1Z-4818-L	638	29	48	18	0	58
KL-WS1Z-4818-R	638	29	48	18	0	58
KL-WS1Z-4821-L-UW	638	29	48	21	3.01	64.7
KL-WS1Z-4821-R-UW	638	29	48	21	3.01	64.7
KL-WS1Z-4824-L-UW	658	29	48	24	3.37	68.1
KL-WS1Z-4824-R-UW	658	29	48	24	3.37	68.1
KL-WS1Z-4830-L-UW	749	29	48	30	4.09	85.47
KL-WS1Z-4830-R-UW	749	29	48	30	4.09	85.47
KL-WS1Z-5424-L-UW	699	29	54	24	3.76	75.9
KL-WS1Z-5424-R-UW	699	29	54	24	3.76	75.9
KL-WS1Z-5430-L-UW	781	29	54	30	4.56	94.5
KL-WS1Z-5430-R-UW	781	29	54	30	4.56	94.5
KL-WS1Z-6024-L-UW	740	29	60	24	4.15	83.7
KL-WS1Z-6024-R-UW	740	29	60	24	4.15	83.7
KL-WS1Z-6030-L-UW	832	29	60	30	5.04	103.53
KL-WS1Z-6030-R-UW	832	29	60	30	0	103.53
KL-WS1Z-6621-L	829	29	66	21	0	80
KL-WS1Z-6621-R	829	29	66	21	0	80
KL-WS1Z-6624-L	829	29	66	24	0	83.7
KL-WS1Z-6624-L-UW	829	29	66	24	0	83.7
KL-WS1Z-6624-R	829	29	66	24	0	83.7
KL-WS1Z-6624-R-UW	829	29	66	24	0	83.7
KL-WS1Z-6630-L	1000	29	66	30	0	83.7
KL-WS1Z-6630-R	1000	29	66	30	0	83.7

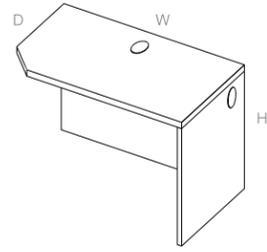

This return is semi-supported, it must be connected to a freestanding desk, corner desk or credenza. Allows for fixed and modular underdesk storage. Works with Straight Front Corners (right hand shown).

Notched Return Full Modesty, 1.5" Thick Surface

**Ordering Options:**

Use the following checklist to customize the finishes on your order:

- laminate
- trim color
- edge profile
- grommet color

Each laminate comes with matching vinyl trim color unless otherwise specified on your purchase order. Refer to the laminate finish card for our current offering.

**Details:**

Grommets are available in black or silver. Black is the standard grommet option unless otherwise specified on your purchase order.

Surfaces up to and including 48" wide have one grommet located at the back center of the surface. Surfaces 54" wide and greater have two grommets at either side of the back of the surface.

All gables include grommets.

Code	Price	H	W	D	Volume (ft <sup>3</sup> )	Weight (lb)
K-WN0G-2424-L	713	29.5	24	24	1.81	55.75
K-WN0G-2424-R	713	29.5	24	24	1.81	55.75
K-WN0G-2430-L	855	29.5	24	30	2.2	65.52
K-WN0G-2430-R	855	29.5	24	30	2.2	65.52
K-WN0G-3024-L	752	29.5	30	24	2.2	65.22
K-WN0G-3024-R	752	29.5	30	24	2.2	65.22
K-WN0G-3030-L	883	29.5	30	30	2.68	76.75
K-WN0G-3030-R	883	29.5	30	30	2.68	76.75
K-WN0G-3624-L	795	29.5	36	24	2.59	74.69
K-WN0G-3624-R	795	29.5	36	24	2.59	74.69
K-WN0G-3630-L	944	29.5	36	30	3.15	87.98
K-WN0G-3630-R	944	29.5	36	30	3.15	87.98
K-WN0G-4224-L	833	29.5	42	24	2.98	84.16
K-WN0G-4224-R	833	29.5	42	24	2.98	84.16
K-WN0G-4230-L	982	29.5	42	30	3.62	99.21
K-WN0G-4230-R	982	29.5	42	30	3.62	99.21
K-WN0G-4824-L	873	29.5	48	24	3.37	93.63
K-WN0G-4824-R	873	29.5	48	24	3.37	93.63
K-WN0G-4830-L	1045	29.5	48	30	4.09	110.44
K-WN0G-4830-R	1045	29.5	48	30	4.09	110.44
K-WN0G-5424-L	903	29.5	54	24	3.76	103.1
K-WN0G-5424-R	903	29.5	54	24	3.76	103.1
K-WN0G-5430-L	1081	29.5	54	30	4.56	121.67
K-WN0G-5430-R	1081	29.5	54	30	4.56	121.67
K-WN0G-6024-L	926	29.5	60	24	4.15	112.57
K-WN0G-6024-R	926	29.5	60	24	4.15	112.57
K-WN0G-6030-L	1114	29.5	60	30	5.04	132.9
K-WN0G-6030-R	1114	29.5	60	30	5.04	132.9

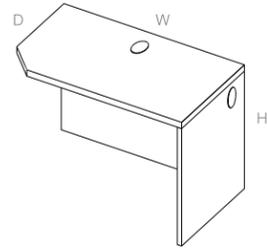

This return is semi-supported, it must be connected to a freestanding desk, corner desk or credenza. Allows for fixed and modular underdesk storage. Works with Straight Front Corners (right hand shown).

Notched Return Full Modesty, 1" Thick Surface

**Ordering Options:**

Use the following checklist to customize the finishes on your order:

- laminate
- trim color
- grommet color

Each laminate comes with matching vinyl trim color unless otherwise specified on your purchase order. Refer to the laminate finish card for our current offering.

**Details:**

Grommets are available in black or silver. Black is the standard grommet option unless otherwise specified on your purchase order.

Surfaces up to and including 48" wide have one grommet located at the back center of the surface. Surfaces 54" wide and greater have two grommets at either side of the back of the surface.

All gables include grommets.

Code	Price	H	W	D	Volume (ft <sup>3</sup> )	Weight (lb)
KL-WN0G-2424-L	674	29	24	24	1.81	48.28
KL-WN0G-2424-R	674	29	24	24	1.81	48.28
KL-WN0G-2430-L	807	29	24	30	2.2	56.08
KL-WN0G-2430-R	807	29	24	30	2.2	56.08
KL-WN0G-3024-L	711	29	30	24	2.2	56.08
KL-WN0G-3024-R	711	29	30	24	2.2	56.08
KL-WN0G-3030-L	833	29	30	30	2.68	63.88
KL-WN0G-3030-R	833	29	30	30	2.68	63.88
KL-WN0G-3624-L	748	29	36	24	2.59	63.88
KL-WN0G-3624-R	748	29	36	24	2.59	63.88
KL-WN0G-3630-L	892	29	36	30	3.15	71.68
KL-WN0G-3630-R	892	29	36	30	3.15	71.68
KL-WN0G-4224-L	787	29	42	24	2.98	71.68
KL-WN0G-4224-R	787	29	42	24	2.98	71.68
KL-WN0G-4230-L	930	29	42	30	3.62	79.48
KL-WN0G-4230-R	930	29	42	30	3.62	79.48
KL-WN0G-4824-L	823	29	48	24	3.37	79.48
KL-WN0G-4824-R	823	29	48	24	3.37	79.48
KL-WN0G-4830-L	983	29	48	30	4.09	87.28
KL-WN0G-4830-R	983	29	48	30	4.09	87.28
KL-WN0G-5424-L	854	29	54	24	3.76	87.28
KL-WN0G-5424-R	854	29	54	24	3.76	87.28
KL-WN0G-5430-L	1021	29	54	30	4.56	95.08
KL-WN0G-5430-R	1021	29	54	30	4.56	95.08
KL-WN0G-6024-L	872	29	60	24	4.15	95.08
KL-WN0G-6024-R	872	29	60	24	4.15	95.08
KL-WN0G-6030-L	1052	29	60	30	5.04	102.88
KL-WN0G-6030-R	1052	29	60	30	5.04	102.88

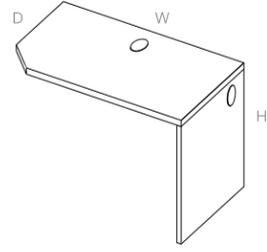

This return is semi-supported, it must be connected to a freestanding desk, corner desk or credenza. Allows for fixed and modular underdesk storage. Partial modesty gives access to electrical outlets when installed against walls

Works with Straight Front Corners (right hand shown).

Notched Return Partial Modesty, 1.5" Thick Surface

**Ordering Options:**

Use the following checklist to customize the finishes on your order:

- laminate
- trim color
- edge profile
- grommet color

Each laminate comes with matching vinyl trim color unless otherwise specified on your purchase order. Refer to the laminate finish card for our current offering.

**Details:**

Grommets are available in black or silver. Black is the standard grommet option unless otherwise specified on your purchase order.

Surfaces up to and including 48" wide have one grommet located at the back center of the surface. Surfaces 54" wide and greater have two grommets at either side of the back of the surface.

All gables include grommets.

Code	Price	H	W	D	Volume (ft <sup>3</sup> )	Weight (lb)
K-WN0Z-2424-L	713	29.5	24	24	1.81	45.45
K-WN0Z-2424-R	713	29.5	24	24	1.81	45.45
K-WN0Z-2430-L	855	29.5	24	30	2.2	55.35
K-WN0Z-2430-R	855	29.5	24	30	2.2	55.35
K-WN0Z-3024-L	752	29.5	30	24	2.2	54.92
K-WN0Z-3024-R	752	29.5	30	24	2.2	54.92
K-WN0Z-3030-L	883	29.5	30	30	2.68	66.58
K-WN0Z-3030-R	883	29.5	30	30	2.68	66.58
K-WN0Z-3624-L	795	29.5	36	24	2.59	64.39
K-WN0Z-3624-R	795	29.5	36	24	2.59	64.39
K-WN0Z-3630-L	944	29.5	36	30	3.15	77.81
K-WN0Z-3630-R	944	29.5	36	30	3.15	77.81
K-WN0Z-4224-L	833	29.5	42	24	2.98	73.86
K-WN0Z-4224-R	833	29.5	42	24	2.98	73.86
K-WN0Z-4230-L	982	29.5	42	30	3.62	89.04
K-WN0Z-4230-R	982	29.5	42	30	3.62	89.04
K-WN0Z-4824-L	873	29.5	48	24	3.37	83.33
K-WN0Z-4824-R	873	29.5	48	24	3.37	83.33
K-WN0Z-4830-L	1045	29.5	48	30	4.09	100.27
K-WN0Z-4830-R	1045	29.5	48	30	4.09	100.27
K-WN0Z-5424-L	903	29.5	54	24	3.76	92.8
K-WN0Z-5424-R	903	29.5	54	24	3.76	92.8
K-WN0Z-5430-L	1081	29.5	54	30	4.56	111.5
K-WN0Z-5430-R	1081	29.5	54	30	4.56	111.5
K-WN0Z-6024-L	926	29.5	60	24	4.15	102.27
K-WN0Z-6024-R	926	29.5	60	24	4.15	102.27
K-WN0Z-6030-L	1114	29.5	60	30	5.04	122.73
K-WN0Z-6030-R	1114	29.5	60	30	5.04	122.73

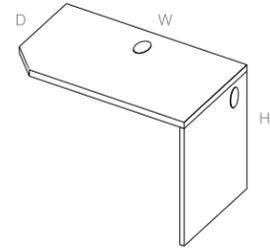

This return is semi-supported, it must be connected to a freestanding desk, corner desk or credenza. Allows for fixed and modular underdesk storage. Partial modesty gives access to electrical outlets when installed against walls

Works with Straight Front Corners (right hand shown).

Notched Return Partial Modesty, 1" Thick Surface

**Ordering Options:**

Use the following checklist to customize the finishes on your order:

- laminate
- trim color
- grommet color

Each laminate comes with matching vinyl trim color unless otherwise specified on your purchase order. Refer to the laminate finish card for our current offering.

**Details:**

Grommets are available in black or silver. Black is the standard grommet option unless otherwise specified on your purchase order.

Surfaces up to and including 48" wide have one grommet located at the back center of the surface. Surfaces 54" wide and greater have two grommets at either side of the back of the surface.

All gables include grommets.

Code	Price	H	W	D	Volume (ft <sup>3</sup> )	Weight (lb)
KL-WN0Z-2424-L	674	29	24	24	1.81	38.25
KL-WN0Z-2424-R	674	29	24	24	1.81	38.25
KL-WN0Z-2430-L	807	29	24	30	2.2	51.81
KL-WN0Z-2430-R	807	29	24	30	2.2	51.81
KL-WN0Z-3024-L	711	29	30	24	2.2	46.05
KL-WN0Z-3024-R	711	29	30	24	2.2	46.05
KL-WN0Z-3030-L	833	29	30	30	2.68	59.61
KL-WN0Z-3030-R	833	29	30	30	2.68	59.61
KL-WN0Z-3624-L	748	29	36	24	2.59	53.85
KL-WN0Z-3624-R	748	29	36	24	2.59	53.85
KL-WN0Z-3630-L	892	29	36	30	3.15	67.41
KL-WN0Z-3630-R	892	29	36	30	3.15	67.41
KL-WN0Z-4224-L	787	29	42	24	2.98	61.65
KL-WN0Z-4224-R	787	29	42	24	2.98	61.65
KL-WN0Z-4230-L	930	29	42	30	3.62	75.21
KL-WN0Z-4230-R	930	29	42	30	3.62	75.21
KL-WN0Z-4824-L	823	29	48	24	3.37	69.45
KL-WN0Z-4824-R	823	29	48	24	3.37	69.45
KL-WN0Z-4830-L	983	29	48	30	4.09	56.53
KL-WN0Z-4830-R	983	29	48	30	4.09	56.53
KL-WN0Z-5424-L	854	29	54	24	3.76	77.25
KL-WN0Z-5424-R	854	29	54	24	3.76	77.25
KL-WN0Z-5430-L	1021	29	54	30	4.56	65.26
KL-WN0Z-5430-R	1021	29	54	30	4.56	65.26
KL-WN0Z-6024-L	872	29	60	24	4.15	85.05
KL-WN0Z-6024-R	872	29	60	24	4.15	85.05
KL-WN0Z-6030-L	1052	29	60	30	5.04	73.99
KL-WN0Z-6030-R	1052	29	60	30	5.04	73.99

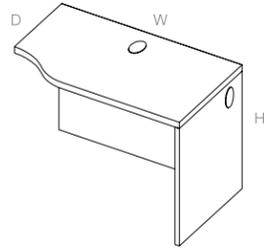

This return is semi-supported, it must be connected to a freestanding desk, corner desk or credenza. Allows for fixed and modular underdesk storage. Works with Curved Front Corners (right hand shown).

Bowed Return Full Modesty, 1.5" Thick Surface

**Ordering Options:**

Use the following checklist to customize the finishes on your order:

- laminate
- trim color
- edge profile
- grommet color

Each laminate comes with matching vinyl trim color unless otherwise specified on your purchase order. Refer to the laminate finish card for our current offering.

**Details:**

Grommets are available in black or silver. Black is the standard grommet option unless otherwise specified on your purchase order.

Surfaces up to and including 48" wide have one grommet located at the back center of the surface. Surfaces 54" wide and greater have two grommets at either side of the back of the surface.

All gables include grommets.

Code	Price	H	W	D	Volume (ft <sup>3</sup> )	Weight (lb)
K-WB0G-2424-L	713	29.5	24	24	1.81	54.43
K-WB0G-2424-R	713	29.5	24	24	1.81	54.43
K-WB0G-2430-L	855	29.5	24	30	2.2	64.35
K-WB0G-2430-R	855	29.5	24	30	2.2	64.35
K-WB0G-3024-L	752	29.5	30	24	2.2	64.11
K-WB0G-3024-R	752	29.5	30	24	2.2	64.11
K-WB0G-3030-L	883	29.5	30	30	2.68	71.14
K-WB0G-3030-R	883	29.5	30	30	2.68	71.14
K-WB0G-3624-L	795	29.5	36	24	2.59	73.79
K-WB0G-3624-R	795	29.5	36	24	2.59	73.79
K-WB0G-3630-L	944	29.5	36	30	3.15	77.93
K-WB0G-3630-R	944	29.5	36	30	3.15	77.93
K-WB0G-4224-L	833	29.5	42	24	2.98	83.47
K-WB0G-4224-R	833	29.5	42	24	2.98	83.47
K-WB0G-4230-L	982	29.5	42	30	3.62	84.72
K-WB0G-4230-R	982	29.5	42	30	3.62	84.72
K-WB0G-4824-L	873	29.5	48	24	3.37	93.15
K-WB0G-4824-R	873	29.5	48	24	3.37	93.15
K-WB0G-4830-L	1045	29.5	48	30	4.09	91.51
K-WB0G-4830-R	1045	29.5	48	30	4.09	91.51
K-WB0G-5424-L	903	29.5	54	24	3.76	102.83
K-WB0G-5424-R	903	29.5	54	24	3.76	102.83
K-WB0G-5430-L	1081	29.5	54	30	4.56	98.3
K-WB0G-5430-R	1081	29.5	54	30	4.56	98.3
K-WB0G-6024-L	926	29.5	60	24	4.15	112.51
K-WB0G-6024-R	926	29.5	60	24	4.15	112.51
K-WB0G-6030-L	1114	29.5	60	30	5.04	105.09
K-WB0G-6030-R	1114	29.5	60	30	5.04	105.09

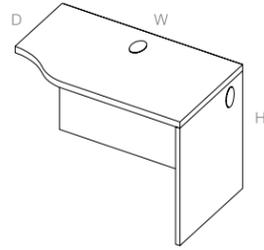

This return is semi-supported, it must be connected to a freestanding desk, corner desk or credenza. Allows for fixed and modular underdesk storage. Works with Curved Front Corners (right hand shown).

Bowed Return Full Modesty, 1" Thick Surface

**Ordering Options:**

Use the following checklist to customize the finishes on your order:

- laminate
- trim color
- grommet color

Each laminate comes with matching vinyl trim color unless otherwise specified on your purchase order. Refer to the laminate finish card for our current offering.

**Details:**

Grommets are available in black or silver. Black is the standard grommet option unless otherwise specified on your purchase order.

Surfaces up to and including 48" wide have one grommet located at the back center of the surface. Surfaces 54" wide and greater have two grommets at either side of the back of the surface.

All gables include grommets.

Code	Price	H	W	D	Volume (ft <sup>3</sup> )	Weight (lb)
KL-WB0G-2424-L	674	29	24	24	1.81	47.54
KL-WB0G-2424-R	674	29	24	24	1.81	47.54
KL-WB0G-2430-L	807	29	24	30	2.2	55.79
KL-WB0G-2430-R	807	29	24	30	2.2	55.79
KL-WB0G-3024-L	711	29	30	24	2.2	55.34
KL-WB0G-3024-R	711	29	30	24	2.2	55.34
KL-WB0G-3030-L	833	29	30	30	2.68	64.09
KL-WB0G-3030-R	833	29	30	30	2.68	64.09
KL-WB0G-3624-L	748	29	36	24	2.59	63.14
KL-WB0G-3624-R	748	29	36	24	2.59	63.14
KL-WB0G-3630-L	892	29	36	30	3.15	72.39
KL-WB0G-3630-R	892	29	36	30	3.15	72.39
KL-WB0G-4224-L	787	29	42	24	2.98	70.94
KL-WB0G-4224-R	787	29	42	24	2.98	70.94
KL-WB0G-4230-L	930	29	42	30	3.62	80.69
KL-WB0G-4230-R	930	29	42	30	3.62	80.69
KL-WB0G-4824-L	823	29	48	24	3.37	78.74
KL-WB0G-4824-R	823	29	48	24	3.37	78.74
KL-WB0G-4830-L	983	29	48	30	4.09	88.99
KL-WB0G-4830-R	983	29	48	30	4.09	88.99
KL-WB0G-5424-L	854	29	54	24	3.76	86.54
KL-WB0G-5424-R	854	29	54	24	3.76	86.54
KL-WB0G-5430-L	1021	29	54	30	4.56	97.29
KL-WB0G-5430-R	1021	29	54	30	4.56	97.29
KL-WB0G-6024-L	872	29	60	24	4.15	94.34
KL-WB0G-6024-R	872	29	60	24	4.15	94.34
KL-WB0G-6030-L	1052	29	60	30	5.04	105.59
KL-WB0G-6030-R	1052	29	60	30	5.04	105.59

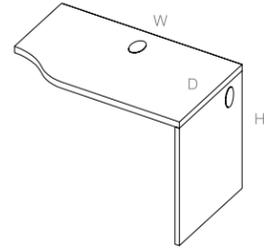

Bowed Return Partial Modesty, 1.5" Thick Surface

This return is semi-supported, it must be connected to a freestanding desk, corner desk or credenza. Allows for fixed and modular underdesk storage. Partial modesty gives access to electrical outlets when planned against walls

Works with Curved Front Corners (right hand shown).

**Ordering Options:**

Use the following checklist to customize the finishes on your order:

- laminate
- trim color
- edge profile
- grommet color

Each laminate comes with matching vinyl trim color unless otherwise specified on your purchase order. Refer to the laminate finish card for our current offering.

**Details:**

Grommets are available in black or silver. Black is the standard grommet option unless otherwise specified on your purchase order.

Surfaces up to and including 48" wide have one grommet located at the back center of the surface. Surfaces 54" wide and greater have two grommets at either side of the back of the surface.

All gables include grommets.

Code	Price	H	W	D	Volume (ft <sup>3</sup> )	Weight (lb)
K-WB0Z-2424-L	713	29.5	24	24	1.81	44.1
K-WB0Z-2424-R	713	29.5	24	24	1.81	44.1
K-WB0Z-2430-L	855	29.5	24	30	2.2	54.45
K-WB0Z-2430-R	855	29.5	24	30	2.2	54.45
K-WB0Z-3024-L	752	29.5	30	24	2.2	53.78
K-WB0Z-3024-R	752	29.5	30	24	2.2	53.78
K-WB0Z-3030-L	883	29.5	30	30	2.68	61.24
K-WB0Z-3030-R	883	29.5	30	30	2.68	61.24
K-WB0Z-3624-L	795	29.5	36	24	2.59	63.46
K-WB0Z-3624-R	795	29.5	36	24	2.59	63.46
K-WB0Z-3630-L	944	29.5	36	30	3.15	68.03
K-WB0Z-3630-R	944	29.5	36	30	3.15	68.03
K-WB0Z-4224-L	833	29.5	42	24	2.98	73.14
K-WB0Z-4224-R	833	29.5	42	24	2.98	73.14
K-WB0Z-4230-L	982	29.5	42	30	3.62	74.82
K-WB0Z-4230-R	982	29.5	42	30	3.62	74.82
K-WB0Z-4824-L	873	29.5	48	24	3.37	82.82
K-WB0Z-4824-R	873	29.5	48	24	3.37	82.82
K-WB0Z-4830-L	1045	29.5	48	30	4.09	81.61
K-WB0Z-4830-R	1045	29.5	48	30	4.09	81.61
K-WB0Z-5424-L	903	29.5	54	24	3.76	92.5
K-WB0Z-5424-R	903	29.5	54	24	3.76	92.5
K-WB0Z-5430-L	1081	29.5	54	30	4.56	88.4
K-WB0Z-5430-R	1081	29.5	54	30	4.56	88.4
K-WB0Z-6024-L	926	29.5	60	24	4.15	102.18
K-WB0Z-6024-R	926	29.5	60	24	4.15	102.18
K-WB0Z-6030-L	1114	29.5	60	30	5.04	95.19
K-WB0Z-6030-R	1114	29.5	60	30	5.04	95.19

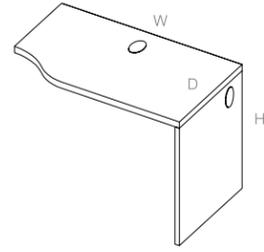

Bowed Return Partial Modesty,  
1.5" Thick Surface

This return is semi-supported, it must be connected to a freestanding desk, corner desk or credenza. Allows for fixed and modular underdesk storage. Partial modesty gives access to electrical outlets when planned against walls

Works with Curved Front Corners (right hand shown).

**Ordering Options:**

Use the following checklist to customize the finishes on your order:

- laminate
- trim color
- grommet color

Each laminate comes with matching vinyl trim color unless otherwise specified on your purchase order. Refer to the laminate finish card for our current offering.

**Details:**

Grommets are available in black or silver. Black is the standard grommet option unless otherwise specified on your purchase order.

Surfaces up to and including 48" wide have one grommet located at the back center of the surface. Surfaces 54" wide and greater have two grommets at either side of the back of the surface.

All gables include grommets.

Code	Price	H	W	D	Volume (ft <sup>3</sup> )	Weight (lb)
KL-WB0Z-2424-L	674	29	24	24	1.81	37.64
KL-WB0Z-2424-R	674	29	24	24	1.81	37.64
KL-WB0Z-2430-L	807	29	24	30	2.2	45.75
KL-WB0Z-2430-R	807	29	24	30	2.2	45.75
KL-WB0Z-3024-L	711	29	30	24	2.2	45.44
KL-WB0Z-3024-R	711	29	30	24	2.2	45.44
KL-WB0Z-3030-L	833	29	30	30	2.68	54.05
KL-WB0Z-3030-R	833	29	30	30	2.68	54.05
KL-WB0Z-3624-L	748	29	36	24	2.59	53.24
KL-WB0Z-3624-R	748	29	36	24	2.59	53.24
KL-WB0Z-3630-L	892	29	36	30	3.15	62.35
KL-WB0Z-3630-R	892	29	36	30	3.15	62.35
KL-WB0Z-4224-L	787	29	42	24	2.98	61.04
KL-WB0Z-4224-R	787	29	42	24	2.98	61.04
KL-WB0Z-4230-L	930	29	42	30	3.62	70.65
KL-WB0Z-4230-R	930	29	42	30	3.62	70.65
KL-WB0Z-4824-L	823	29	48	24	3.37	68.84
KL-WB0Z-4824-R	823	29	48	24	3.37	68.84
KL-WB0Z-4830-L	983	29	48	30	4.09	78.95
KL-WB0Z-4830-R	983	29	48	30	4.09	78.95
KL-WB0Z-5424-L	854	29	54	24	3.76	76.64
KL-WB0Z-5424-R	854	29	54	24	3.76	76.64
KL-WB0Z-5430-L	1021	29	54	30	4.56	87.25
KL-WB0Z-5430-R	1021	29	54	30	4.56	87.25
KL-WB0Z-6024-L	872	29	60	24	4.15	84.44
KL-WB0Z-6024-R	872	29	60	24	4.15	84.44
KL-WB0Z-6030-L	1052	29	60	30	5.04	95.55
KL-WB0Z-6030-R	1052	29	60	30	5.04	95.55



Cantilever



Intermediate Gable

# Metro Collab July 2023 Supports

Code	Price	H	W	D	Volume (ft <sup>3</sup> )	Weight (lb)
cantilever						
K-CCAB-16	99	0	16	0	3	0.1
K-CCAB-22	107	0	22	0	3	0.1
intermediate						
T-CGU0-12	190	28	12	1	1.48	8.75
T-CGU0-18	202	28	18	1	2.04	13.12

Metro Collab  
July 2023  
**Filing &  
Storage**

Executive & Professional

pedestals	110
underdesk storage cabinet	111
underdesk combo pedestal BBF & FF	112
underdesk storage cabinet	113

Executive

freestanding storage cabinet	114
freestanding combo pedestal BBF & FF	116
freestanding 2-drawer lateral file	118
freestanding 3-drawer lateral file	120
freestanding 4-drawer lateral file	122
freestanding storage tower	124
freestanding combo storage tower BBF	126
freestanding wardrobe storage tower	128
freestanding storage tower glazed door	130
freestanding combo storage tower FF	132
freestanding storage tower double door	134
freestanding combo lateral storage tower double door	136
freestanding combo storage tower double door	138
freestanding storage tower glazed double door	140
freestanding combo lateral storage tower glazed double door	142
freestanding combo storage tower glazed double door	144
radius corner bookcase short	146

Professional

freestanding storage cabinet	115
freestanding combo pedestal BBF & FF	117
freestanding 2-drawer lateral file	119
freestanding 3-drawer lateral file	121
freestanding 4-drawer lateral file	123
freestanding storage tower	125
freestanding combo storage tower BBF	127
freestanding wardrobe storage tower	129
freestanding storage tower glazed door	131
freestanding combo storage tower FF	133
freestanding storage tower double door	135
freestanding combo lateral storage tower double door	137
freestanding combo storage tower double door	139
freestanding storage tower glazed double door	141
freestanding combo lateral storage tower glazed double door	143
freestanding combo storage tower glazed double door	145
radius corner bookcase short	147



- 1. T-FPBU-1618 Underdesk BBF Pedestal
- 2. T-FPFU-1618 Underdesk FF Pedestal
- 3. T-FPSU-1618 Suspended Underdesk BF Pedestal
- 4. T-FPBM-1621 Mobile BBF Pedestal
- 5. T-FPFM-1621 Mobile FF Pedestal
- 6. T-1020-1618 Mobile Top Load w/ Seat Cushion Pedestal
- 7. T-1030-1618 Mobile BF w/ Seat Cushion Pedestal

**Ordering Options:**

Use the following checklist to customize the finishes on your order:

- laminate
- trim color
- handle color
- handle style
- fabric color (seats)

Each laminate comes with matching vinyl trim color unless otherwise specified on your purchase order.

Refer to the laminate & fabric finish cards for our current offering.

Code	Price	H	W	D	Volume (ft <sup>3</sup> )	Weight (lb)
T-FPBU-1618	871	28	16	18	8.15	55
T-FPBM-1621	1144	28	16	21	9.26	74
T-FPFU-1618	871	28	16	18	8.15	55
T-FPFM-1621	1144	28	16	21	9.26	68
T-FPSU-1618	618	16	16	18	5.09	44
T-1030-1618	1396	23	16	18	6.88	55

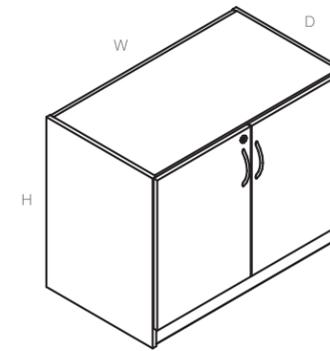

This underdesk storage cabinet provides private storage and shelving. This product is to be used under a desk, return or credenza.

**Ordering Options:**

Use the following checklist to customize the finishes on your order:

- laminate
- trim color
- handle color
- handle style

Each laminate comes with matching vinyl trim color unless otherwise specified on your purchase order.

Refer to the laminate & fabric finish cards for our current offering.

**Details:**

Includes locks, keys, and an adjustable shelf.

Code	Price	H	W	D	Volume (ft <sup>3</sup> )	Weight (lb)
T-FSU0-3020	1068	28	30	20	15.11	88
T-FSU0-3620	1157	28	36	20	17.78	102
T-FSU0-4220	1244	28	42	20	20.44	117
T-FSU0-3021	1068	28	30	21	15.74	92
T-FSU0-3621	1157	28	36	21	18.52	107
T-FSU0-4221	1244	28	42	21	21.3	122

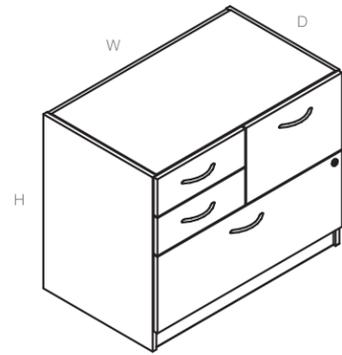

This product includes box and file drawers and is to be used under a desk, return or credenza for legal-sized paper.

**Ordering Options:**

Use the following checklist to customize the finishes on your order:

- laminate
- trim color
- handle color
- handle style

Each laminate comes with matching vinyl trim color unless otherwise specified on your purchase order.

Refer to the laminate & fabric finish cards for our current offering.

**Details:**

1. Includes locks and keys.
2. Comes equipped with drawer dividers, hanging file bars and levelers.
3. Hanging bars are installed along the depth only.
4. Includes a pencil tray.

Code	Price	H	W	D	Volume (ft <sup>3</sup> )	Weight (lb)
T-FPJU-3620-L	1684	28	36	20	17.78	121
T-FPJU-3621-L	1684	28	36	21	18.52	122
T-FPJU-3620-R	1684	28	36	20	17.78	121
T-FPJU-3621-R	1684	28	36	21	18.52	122

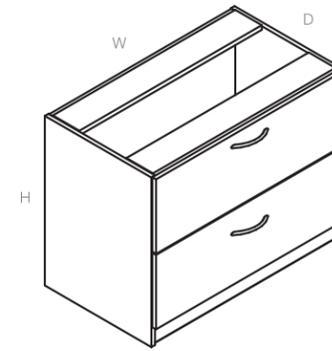

This lateral file provides large capacity filing and organized storage possibilities. It is to be used under a desk, return or credenza shell for stability. Its full extension drawers can accommodate both letter- and legal-sized paper.

Disclaimer: Please note that lateral file drawers are intended for filing letter and legal size paper front to back or side to side only. For details and weight restrictions please contact customer service.

**Ordering Options:**

Use the following checklist to customize the finishes on your order:

- laminate
- trim color
- handle color
- handle style

Each laminate comes with matching vinyl trim color unless otherwise specified on your purchase order.

Refer to the laminate & fabric finish cards for our current offering.

**Details:**

1. Includes locks and keys.
2. Comes equipped with drawer dividers, hanging file bars and levelers.
3. Hanging bars are installed along the depth only.

Code	Price	H	W	D	Volume (ft <sup>3</sup> )	Weight (lb)
T-FL2U-3020	1377	28	30	20	15.11	82.06
T-FL2U-3620	1427	28	36	20	17.78	86.64
T-FL2U-4220	1507	28	42	20	20.44	89.35
T-FL2U-3021	1377	28	30	21	15.74	84.6
T-FL2U-3621	1427	28	36	21	18.52	88.02
T-FL2U-4221	1507	28	42	21	21.3	91.44

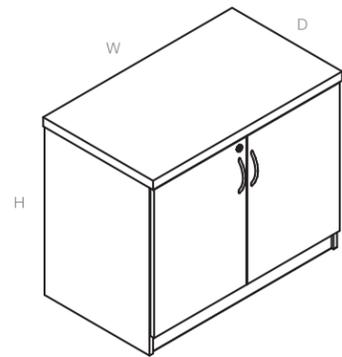

This freestanding storage cabinet provides private storage and shelving.

Freestanding Storage Cabinet, 1.5" Thick Top

**Ordering Options:**

Use the following checklist to customize the finishes on your order:

- laminate
- trim color
- edge profile
- handle color
- handle style

Each laminate comes with matching vinyl trim color unless otherwise specified on your purchase order.

Refer to the laminate & fabric finish cards for our current offering.

**Details:**

1. Includes locks and keys.
2. Comes equipped with drawer dividers, hanging file bars and levelers.
3. Hanging bars are installed along the depth only.

Code	Price	H	W	D	Volume (ft <sup>3</sup> )	Weight (lb)
T-FSF0-3021	1175	29.5	30	21	16.48	98
T-FSF0-3621	1260	29.5	36	21	19.39	111
T-FSF0-4221	1346	29.5	42	21	22.29	124

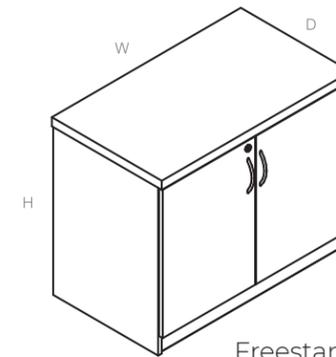

This freestanding storage cabinet provides private storage and shelving.

Freestanding Storage Cabinet, 1" Thick Top

**Ordering Options:**

Use the following checklist to customize the finishes on your order:

- laminate
- trim color
- handle color
- handle style

Each laminate comes with matching vinyl trim color unless otherwise specified on your purchase order.

Refer to the laminate & fabric finish cards for our current offering.

**Details:**

Includes locks, keys, and an adjustable shelf.

Code	Price	H	W	D	Volume (ft <sup>3</sup> )	Weight (lb)
TL-FSF0-3021	1123	29	30	21	16.23	88
TL-FSF0-3621	1210	29	36	21	19.1	97
TL-FSF0-4221	1296	29	42	21	21.96	106

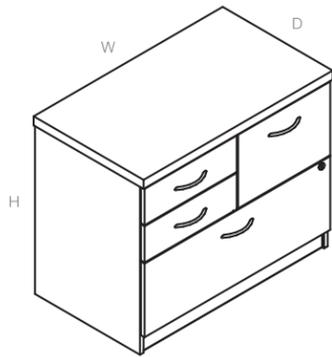

This product includes box and file drawers and is to be used as freestanding furniture. Its full extension drawers can accommodate both letter- and legal-sized paper.

Freestanding Combo Pedestal BBF & FF, 1.5" Thick Top

**Ordering Options:**

Use the following checklist to customize the finishes on your order:

- laminate
- trim color
- edge profile
- handle color
- handle style

Each laminate comes with matching vinyl trim color unless otherwise specified on your purchase order.

Refer to the laminate & fabric finish cards for our current offering.

**Details:**

1. Includes locks and keys.
2. Comes equipped with drawer dividers, hanging file bars and levelers.
3. Hanging bars are installed along the depth only.

Code	Price	H	W	D	Volume (ft <sup>3</sup> )	Weight (lb)
T-FPJF-3621-L	1763	29.5	36	21	19.39	130
T-FPJF-3621-R	1763	29.5	36	21	19.39	130

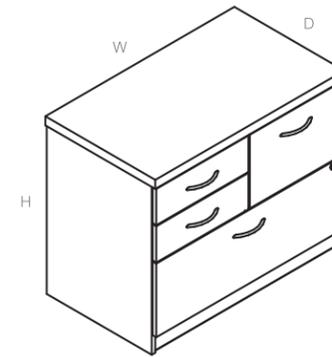

This product includes box and file drawers and is to be used as freestanding furniture. Its full extension drawers can accommodate both letter- and legal-sized paper.

Freestanding Combo Pedestal BBF & FF, 1" Thick Top

**Ordering Options:**

Use the following checklist to customize the finishes on your order:

- laminate
- trim color
- handle color
- handle style

Each laminate comes with matching vinyl trim color unless otherwise specified on your purchase order.

Refer to the laminate & fabric finish cards for our current offering.

**Details:**

1. Includes locks and keys.
2. Comes equipped with drawer dividers, hanging file bars and levelers.
3. Hanging bars are installed along the depth only.

Code	Price	H	W	D	Volume (ft <sup>3</sup> )	Weight (lb)
TL-FPJF-3621-L	1726	29	36	21	19.1	130
TL-FPJF-3621-R	1726	29	36	21	19.1	130

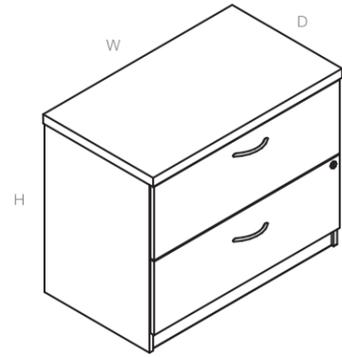

This lateral file with two drawers provides large capacity filing and organized storage. It is to be used as freestanding furniture. Its full extension drawers can accommodate both letter and legal-sized paper.

Disclaimer: Please note that lateral file drawers are intended for filing letter and legal size paper front to back or side to side only. For details and weight restrictions please contact customer service.

Freestanding 2-Drawer Lateral File, 1.5" Thick Top

**Ordering Options:**

Use the following checklist to customize the finishes on your order:

- laminate
- trim color
- edge profile
- handle color
- handle style

Each laminate comes with matching vinyl trim color unless otherwise specified on your purchase order.

Refer to the laminate & fabric finish cards for our current offering.

**Details:**

1. Includes locks and keys.
2. Comes equipped with drawer dividers, hanging file bars and levelers.
3. Hanging bars are installed along the depth only.

Code	Price	H	W	D	Volume (ft <sup>3</sup> )	Weight (lb)
T-FL2F-3021	1471	29.5	30	21	16.48	108.9
T-FL2F-3621	1519	29.5	36	21	19.39	117.27
T-FL2F-4221	1592	29.5	42	21	22.29	125.64



This lateral file with two drawers provides large capacity filing and organized storage. It is to be used as freestanding furniture. Its full extension drawers can accommodate both letter and legal-sized paper.

Disclaimer: Please note that lateral file drawers are intended for filing letter and legal size paper front to back or side to side only. For details and weight restrictions please contact customer service.

Freestanding 2-Drawer Lateral File, 1" Thick Top

**Ordering Options:**

Use the following checklist to customize the finishes on your order:

- laminate
- trim color
- handle color
- handle style

Each laminate comes with matching vinyl trim color unless otherwise specified on your purchase order.

Refer to the laminate & fabric finish cards for our current offering.

**Details:**

1. Includes locks and keys.
2. Comes equipped with drawer dividers, hanging file bars and levelers.
3. Hanging bars are installed along the depth only.

Code	Price	H	W	D	Volume (ft <sup>3</sup> )	Weight (lb)
TL-FL2F-3021	1425	29	30	21	16.23	92.7
TL-FL2F-3621	1472	29	36	21	19.1	107.1
TL-FL2F-4221	1550	29	42	21	21.96	121.5

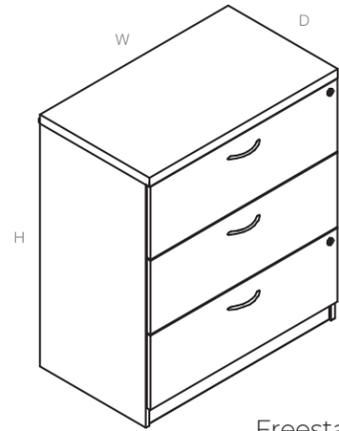

Freestanding 3-Drawer Lateral File, 1.5" Thick Top

This lateral file with two drawers provides large capacity filing and organized storage. It is to be used as freestanding furniture. Its full extension drawers can accommodate both letter and legal-sized paper.

Disclaimer: Please note that lateral file drawers are intended for filing letter and legal size paper front to back or side to side only. For details and weight restrictions please contact customer service.

**Ordering Options:**

Use the following checklist to customize the finishes on your order:

- laminate
- trim color
- edge profile
- handle color
- handle style

Each laminate comes with matching vinyl trim color unless otherwise specified on your purchase order.

Refer to the laminate & fabric finish cards for our current offering.

**Details:**

1. Includes locks and keys.
2. Comes equipped with drawer dividers, hanging file bars and levelers.
3. Hanging bars are installed along the depth only.

Code	Price	H	W	D	Volume (ft <sup>3</sup> )	Weight (lb)
T-FL3F-3021	1828	40.5	30	21	21.89	145
T-FL3F-3621	1907	40.5	36	21	25.75	154.96

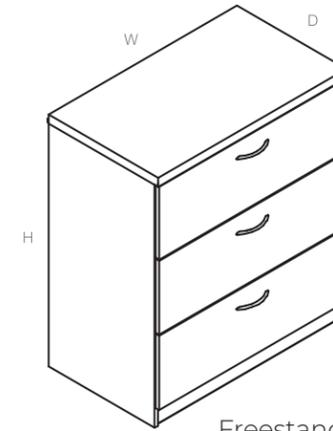

Freestanding 3-Drawer Lateral File, 1" Thick Top

This lateral file with two drawers provides large capacity filing and organized storage. It is to be used as freestanding furniture. Its full extension drawers can accommodate both letter and legal-sized paper.

Disclaimer: Please note that lateral file drawers are intended for filing letter and legal size paper front to back or side to side only. For details and weight restrictions please contact customer service.

**Ordering Options:**

Use the following checklist to customize the finishes on your order:

- laminate
- trim color
- handle color
- handle style

Each laminate comes with matching vinyl trim color unless otherwise specified on your purchase order.

Refer to the laminate & fabric finish cards for our current offering.

**Details:**

1. Includes locks and keys.
2. Comes equipped with drawer dividers, hanging file bars and levelers.
3. Hanging bars are installed along the depth only.

Code	Price	H	W	D	Volume (ft <sup>3</sup> )	Weight (lb)
TL-FL3F-3021	1606	40	30	21	21.64	136.5
TL-FL3F-3621	1684	40	36	21	25.46	144.25

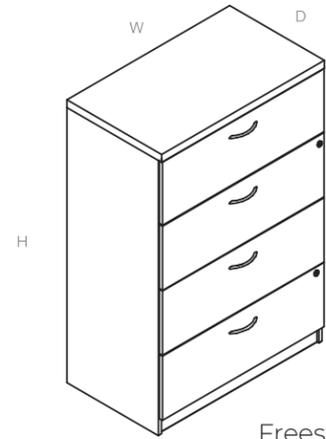

Freestanding 4-Drawer Lateral File, 1.5" Thick Top

This lateral file with two drawers provides large capacity filing and organized storage. It is to be used as freestanding furniture. Its full extension drawers can accommodate both letter and legal-sized paper.

Disclaimer: Please note that lateral file drawers are intended for filing letter and legal size paper front to back or side to side only. For details and weight restrictions please contact customer service.

**Ordering Options:**

Use the following checklist to customize the finishes on your order:

- laminate
- trim color
- edge profile
- handle color
- handle style

Each laminate comes with matching vinyl trim color unless otherwise specified on your purchase order.

Refer to the laminate & fabric finish cards for our current offering.

**Details:**

1. Includes locks and keys.
2. Comes equipped with drawer dividers, hanging file bars and levelers.
3. Hanging bars are installed along the depth only.

Code	Price	H	W	D	Volume (ft <sup>3</sup> )	Weight (lb)
T-FL4F-3021	2393	52.5	30	21	27.79	171.3
T-FL4F-3621	2471	52.5	36	21	32.7	183.24

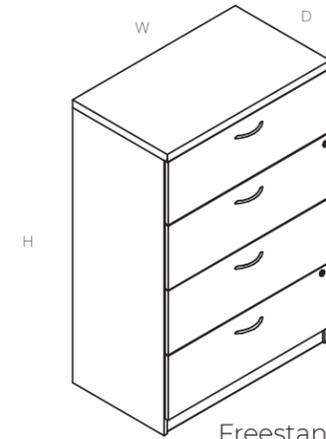

Freestanding 4-Drawer Lateral File, 1" Thick Top

This lateral file with two drawers provides large capacity filing and organized storage. It is to be used as freestanding furniture. Its full extension drawers can accommodate both letter and legal-sized paper.

Disclaimer: Please note that lateral file drawers are intended for filing letter and legal size paper front to back or side to side only. For details and weight restrictions please contact customer service.

**Ordering Options:**

Use the following checklist to customize the finishes on your order:

- laminate
- trim color
- handle color
- handle style

Each laminate comes with matching vinyl trim color unless otherwise specified on your purchase order.

Refer to the laminate & fabric finish cards for our current offering.

**Details:**

1. Includes locks and keys.
2. Comes equipped with drawer dividers, hanging file bars and levelers.
3. Hanging bars are installed along the depth only.

Code	Price	H	W	D	Volume (ft <sup>3</sup> )	Weight (lb)
TL-FL4F-3021	2168	52	30	21	27.55	153.1
TL-FL4F-3621	2247	52	36	21	32.41	162.98

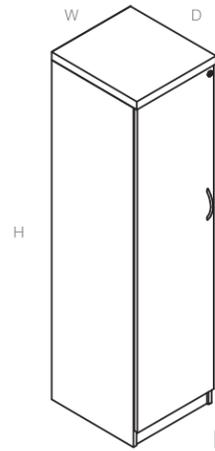

Freestanding Storage Tower, 1.5" Thick Top

This lockable storage tower functions the same way as a storage cabinet but with more vertical space. Shelves are adjustable for user to customize with levelers (left hand shown).

**Ordering Options:**

Use the following checklist to customize the finishes on your order:

- laminate
- trim color
- edge profile
- handle color
- handle style

Each laminate comes with matching vinyl trim color unless otherwise specified on your purchase order.

Refer to the laminate & fabric finish cards for our current offering.

**Details:**

1. Includes locks and keys.
2. Comes equipped with drawer dividers, hanging file bars and levelers.

Code	Price	H	W	D	Volume (ft <sup>3</sup> )	Weight (lb)
T-FSDS-1821-L	1304	68	18	21	22.92	133.65
T-FSDS-1821-R	1304	68	18	21	22.92	133.65

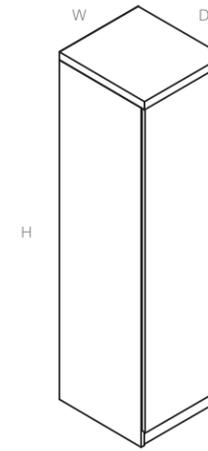

Freestanding Storage Tower, 1" Thick Top

This lockable storage tower functions the same way as a storage cabinet but with more vertical space. Shelves are adjustable for user to customize with levelers (left hand shown).

**Ordering Options:**

Use the following checklist to customize the finishes on your order:

- laminate
- trim color
- handle color
- handle style

Each laminate comes with matching vinyl trim color unless otherwise specified on your purchase order.

Refer to the laminate & fabric finish cards for our current offering.

**Details:**

1. Includes locks and keys.
2. Comes equipped with drawer dividers, hanging file bars and levelers.

Code	Price	H	W	D	Volume (ft <sup>3</sup> )	Weight (lb)
TL-FSDS-1821-L	1251	67	18	21	22.6	128.7
TL-FSDS-1821-R	1251	67	18	21	22.6	128.7

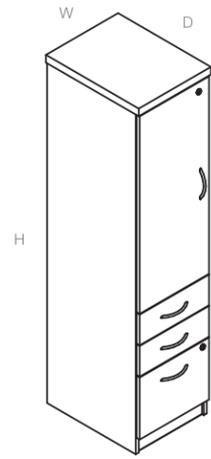

This storage tower combines the filing capabilities of a BBF with the flexibility of a cabinet. Drawers accept both letter and legal-sized paper (left hand shown).

Freestanding Combo Storage Tower BBF, 1.5" Thick Top

**Ordering Options:**

Use the following checklist to customize the finishes on your order:

- laminate
- trim color
- edge profile
- handle color
- handle style

Each laminate comes with matching vinyl trim color unless otherwise specified on your purchase order.

Refer to the laminate & fabric finish cards for our current offering.

**Details:**

1. Includes locks and keys.
2. Comes equipped with levelers and adjustable shelves.

Code	Price	H	W	D	Volume (ft <sup>3</sup> )	Weight (lb)
T-FCSB-1821-L	2048	68	18	21	22.92	168
T-FCSB-1821-R	2048	68	18	21	22.92	168

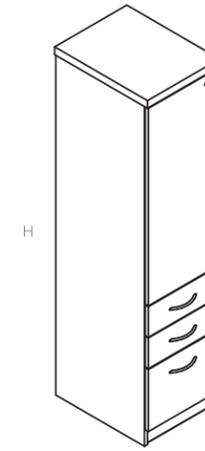

This storage tower combines the filing capabilities of a BBF with the flexibility of a cabinet. Drawers accept both letter and legal-sized paper (left hand shown).

Freestanding Combo Storage Tower BBF, 1" Thick Top

**Ordering Options:**

Use the following checklist to customize the finishes on your order:

- laminate
- trim color
- handle color
- handle style

Each laminate comes with matching vinyl trim color unless otherwise specified on your purchase order.

Refer to the laminate & fabric finish cards for our current offering.

**Details:**

1. Includes locks and keys.
2. Comes equipped with levelers and adjustable shelves.

Code	Price	H	W	D	Volume (ft <sup>3</sup> )	Weight (lb)
TL-FCSB-1821-L	1826	67	18	21	22.6	163
TL-FCSB-1821-R	1826	67	18	21	22.6	163

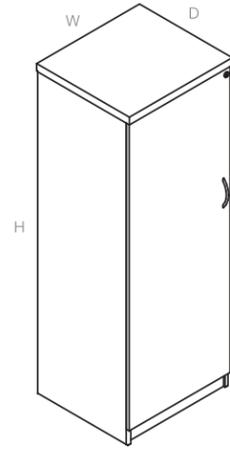

This unit provides a lockable storage area for apparel and other personal items. Includes a coat bar and adjustable shelves with levelers (left hand shown).

Freestanding Wardrobe Storage Tower, 1.5" Thick Top

**Ordering Options:**

Use the following checklist to customize the finishes on your order:

- laminate
- trim color
- edge profile
- handle color
- handle style

Each laminate comes with matching vinyl trim color unless otherwise specified on your purchase order.

Refer to the laminate & fabric finish cards for our current offering.

**Details:**

1. Includes locks and keys.
2. Comes equipped with levelers and adjustable shelves.

Code	Price	H	W	D	Volume (ft <sup>3</sup> )	Weight (lb)
T-FSDC-2421-L	1406	68	24	21	29.17	179.64
T-FSDC-2421-R	1406	68	24	21	29.17	179.64

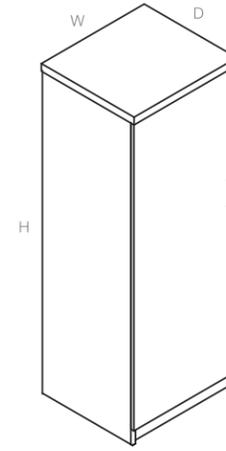

This unit provides a lockable storage area for apparel and other personal items. Includes a coat bar and adjustable shelves with levelers (left hand shown).

Freestanding Wardrobe Storage Tower, 1" Thick Top

**Ordering Options:**

Use the following checklist to customize the finishes on your order:

- laminate
- trim color
- handle color
- handle style

Each laminate comes with matching vinyl trim color unless otherwise specified on your purchase order.

Refer to the laminate & fabric finish cards for our current offering.

**Details:**

1. Includes locks and keys.
2. Comes equipped with levelers and adjustable shelves.

Code	Price	H	W	D	Volume (ft <sup>3</sup> )	Weight (lb)
TL-FSDC-2421-L	1353	67	24	21	28.76	169.95
TL-FSDC-2421-R	1353	67	24	21	28.76	169.95

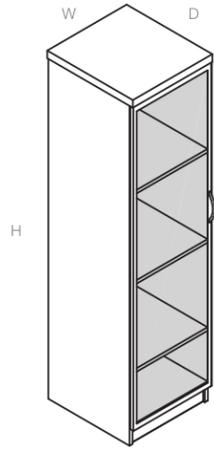

This storage tower functions the same way as a storage cabinet but with more vertical space and a glazed door. Shelves are adjustable for user to customize with levelers (left hand shown).

Freestanding Storage Tower Glazed Door, 1.5" Thick Top

**Ordering Options:**

Use the following checklist to customize the finishes on your order:

- laminate
- trim color
- edge profile
- handle color
- handle style

Each laminate comes with matching vinyl trim color unless otherwise specified on your purchase order.

Refer to the laminate & fabric finish cards for our current offering.

**Details:**

1. Includes locks and keys.
2. Comes equipped with levelers and adjustable shelves.

Code	Price	H	W	D	Volume (ft <sup>3</sup> )	Weight (lb)
T-FSDS-1821-L-G	2758	68	18	21	22.92	119.81

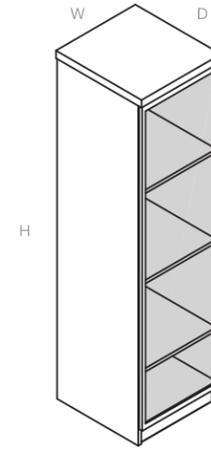

This storage tower functions the same way as a storage cabinet but with more vertical space and a glazed door. Shelves are adjustable for user to customize with levelers (left hand shown).

Freestanding Storage Tower Glazed Door, 1" Thick Top

**Ordering Options:**

Use the following checklist to customize the finishes on your order:

- laminate
- trim color
- handle color
- handle style

Each laminate comes with matching vinyl trim color unless otherwise specified on your purchase order.

Refer to the laminate & fabric finish cards for our current offering.

**Details:**

1. Includes locks and keys.
2. Comes equipped with levelers and adjustable shelves.

Code	Price	H	W	D	Volume (ft <sup>3</sup> )	Weight (lb)
TL-FSDS-1821-LG	2705	67	18	21	22.6	113.85
TL-FSDS-1821-RG	2407	67	18	21	22.6	113.85

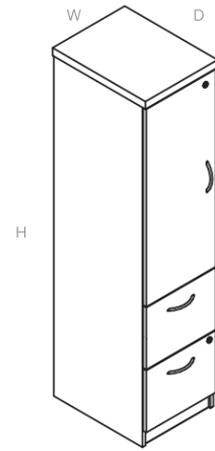

This storage tower combines the filing capabilities of a FF with the flexibility of a cabinet. Drawers accept both letter and legal-sized paper (left hand shown).

Freestanding Combo Storage Tower FF, 1.5" Thick Top

**Ordering Options:**

Use the following checklist to customize the finishes on your order:

- laminate
- trim color
- edge profile
- handle color
- handle style

Each laminate comes with matching vinyl trim color unless otherwise specified on your purchase order.

Refer to the laminate & fabric finish cards for our current offering.

**Details:**

1. Includes locks and keys.
2. Comes equipped with levelers and adjustable shelves.

Code	Price	H	W	D	Volume (ft <sup>3</sup> )	Weight (lb)
T-FCSF-1821-L	2048	68	18	21	22.92	162
T-FCSF-1821-R	2048	68	18	21	22.92	162

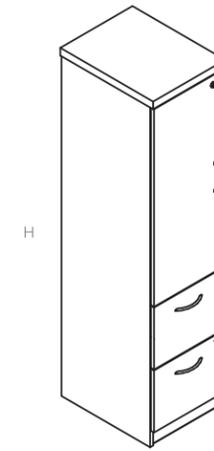

This storage tower combines the filing capabilities of a FF with the flexibility of a cabinet. Drawers accept both letter and legal-sized paper (left hand shown).

Freestanding Combo Storage Tower FF, 1" Thick Top

**Ordering Options:**

Use the following checklist to customize the finishes on your order:

- laminate
- trim color
- handle color
- handle style

Each laminate comes with matching vinyl trim color unless otherwise specified on your purchase order.

Refer to the laminate & fabric finish cards for our current offering.

**Details:**

1. Includes locks and keys.
2. Comes equipped with levelers and adjustable shelves.

Code	Price	H	W	D	Volume (ft <sup>3</sup> )	Weight (lb)
TL-FCSF-1821-L	1826	67	18	21	22.6	129
TL-FCSF-1821-R	1826	67	18	21	22.6	129

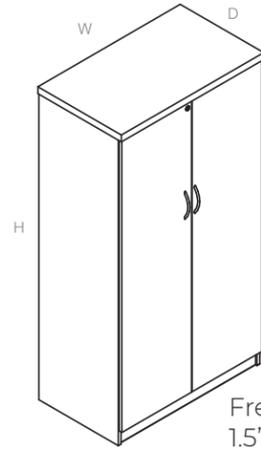

This lockable storage tower with double doors functions the same way as a storage cabinet but with more vertical space. Shelves are adjustable for user to customize with levelers.

Freestanding Storage Tower Double Door, 1.5" Thick Top

**Ordering Options:**

Use the following checklist to customize the finishes on your order:

- laminate
- trim color
- edge profile
- handle color
- handle style

Each laminate comes with matching vinyl trim color unless otherwise specified on your purchase order.

Refer to the laminate & fabric finish cards for our current offering.

**Details:**

1. Includes locks and keys.
2. Comes equipped with levelers and adjustable shelves.

Code	Price	H	W	D	Volume (ft <sup>3</sup> )	Weight (lb)
T-FSDS-3621	2048	68	36	21	41.67	204.96

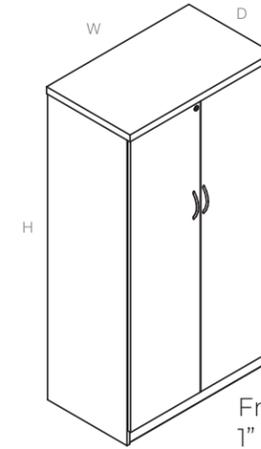

This lockable storage tower with double doors functions the same way as a storage cabinet but with more vertical space. Shelves are adjustable for user to customize with levelers.

Freestanding Storage Tower Double Door, 1" Thick Top

**Ordering Options:**

Use the following checklist to customize the finishes on your order:

- laminate
- trim color
- handle color
- handle style

Each laminate comes with matching vinyl trim color unless otherwise specified on your purchase order.

Refer to the laminate & fabric finish cards for our current offering.

**Details:**

1. Includes locks and keys.
2. Comes equipped with levelers and adjustable shelves.

Code	Price	H	W	D	Volume (ft <sup>3</sup> )	Weight (lb)
TL-FSDS-3621	1906	67	36	21	41.09	195.39

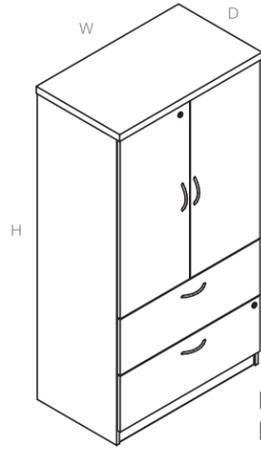

This storage tower combines the filing capabilities of a lateral storage unit with the flexibility of a cabinet. Drawers accept both letter and legal-sized paper.

Freestanding Combo Lateral Storage Tower Double Door, 1.5" Thick Top

**Ordering Options:**

Use the following checklist to customize the finishes on your order:

- laminate
- trim color
- edge profile
- handle color
- handle style

Each laminate comes with matching vinyl trim color unless otherwise specified on your purchase order.

Refer to the laminate & fabric finish cards for our current offering.

**Details:**

1. Includes locks and keys.
2. Comes equipped with levelers and adjustable shelves.

Code	Price	H	W	D	Volume (ft <sup>3</sup> )	Weight (lb)
T-FCSL-3621	2431	68	36	21	41.67	260.82

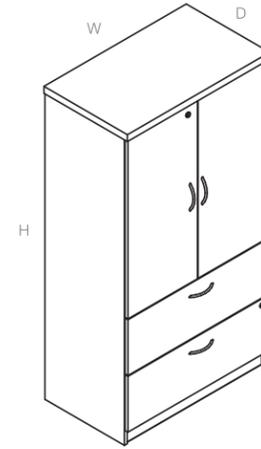

This storage tower combines the filing capabilities of a lateral storage unit with the flexibility of a cabinet. Drawers accept both letter and legal-sized paper.

Freestanding Combo Lateral Storage Tower Double Door, 1" Thick Top

**Ordering Options:**

Use the following checklist to customize the finishes on your order:

- laminate
- trim color
- handle color
- handle style

Each laminate comes with matching vinyl trim color unless otherwise specified on your purchase order.

Refer to the laminate & fabric finish cards for our current offering.

**Details:**

1. Includes locks and keys.
2. Comes equipped with levelers and adjustable shelves.

Code	Price	H	W	D	Volume (ft <sup>3</sup> )	Weight (lb)
TL-FCSL-3621	2209	67	36	21	41.09	251.25

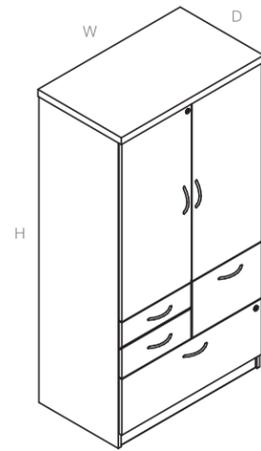

This storage tower combines the filing capabilities of lateral and underdesk storage with the flexibility of a cabinet. Drawers accept both letter and legal-sized paper.

Freestanding Combo Storage Tower Double Door, 1.5" Thick Top

**Ordering Options:**

Use the following checklist to customize the finishes on your order:

- laminate
- trim color
- edge profile
- handle color
- handle style

Each laminate comes with matching vinyl trim color unless otherwise specified on your purchase order.

Refer to the laminate & fabric finish cards for our current offering.

**Details:**

1. Includes locks and keys.
2. Comes equipped with levelers and adjustable shelves.

Code	Price	H	W	D	Volume (ft <sup>3</sup> )	Weight (lb)
T-FCSJ-3621	2690	68	36	21	41.67	266.82

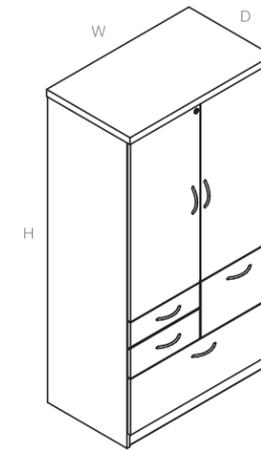

This storage tower combines the filing capabilities of lateral and underdesk storage with the flexibility of a cabinet. Drawers accept both letter and legal-sized paper.

Freestanding Combo Storage Tower Double Door, 1" Thick Top

**Ordering Options:**

Use the following checklist to customize the finishes on your order:

- laminate
- trim color
- handle color
- handle style

Each laminate comes with matching vinyl trim color unless otherwise specified on your purchase order.

Refer to the laminate & fabric finish cards for our current offering.

**Details:**

1. Includes locks and keys.
2. Comes equipped with levelers and adjustable shelves.

Code	Price	H	W	D	Volume (ft <sup>3</sup> )	Weight (lb)
TL-FCSJ-3621	2467	67	36	21	41.09	257.35

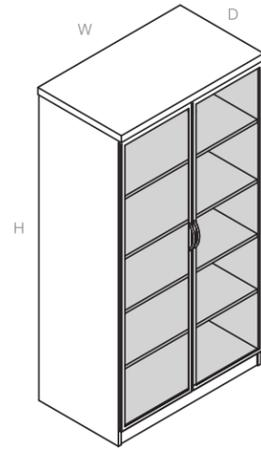

This lockable storage tower with glazed double doors functions the same way as a storage cabinet but with more vertical space. Shelves are adjustable for user to customize with levelers.

Freestanding Storage Tower Glazed Double Door, 1.5" Thick Top

**Ordering Options:**

Use the following checklist to customize the finishes on your order:

- laminate
- trim color
- edge profile
- handle color
- handle style

Each laminate comes with matching vinyl trim color unless otherwise specified on your purchase order.

Refer to the laminate & fabric finish cards for our current offering.

**Details:**

1. Includes locks and keys.
2. Comes equipped with levelers and adjustable shelves.

Code	Price	H	W	D	Volume (ft <sup>3</sup> )	Weight (lb)
T-FSDS-3621-G	3484	68	36	21	41.67	210.6

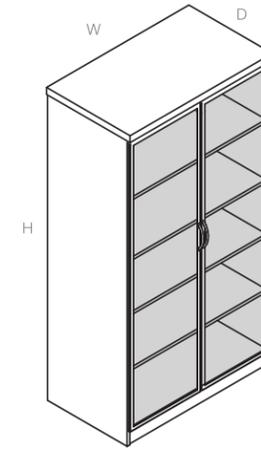

This lockable storage tower with glazed double doors functions the same way as a storage cabinet but with more vertical space. Shelves are adjustable for user to customize with levelers.

Freestanding Storage Tower Glazed Double Door, 1" Thick Top

**Ordering Options:**

Use the following checklist to customize the finishes on your order:

- laminate
- trim color
- handle color
- handle style

Each laminate comes with matching vinyl trim color unless otherwise specified on your purchase order.

Refer to the laminate & fabric finish cards for our current offering.

**Details:**

1. Includes locks and keys.
2. Comes equipped with levelers and adjustable shelves.

Code	Price	H	W	D	Volume (ft <sup>3</sup> )	Weight (lb)
TL-FSDS-3621-G	3343	67	36	21	41.09	210.6

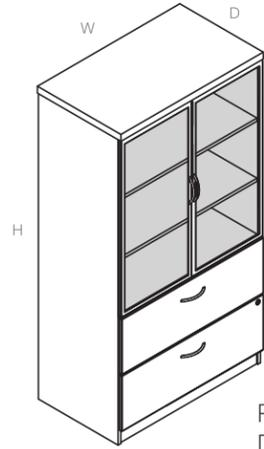

This storage tower combines the filing capabilities of a lateral storage unit with the flexibility of a cabinet. Drawers accept both letter and legal-sized paper.

Freestanding Combo Lateral Storage Tower Glazed Double Door, 1.5" Thick Top

**Ordering Options:**

Use the following checklist to customize the finishes on your order:

- laminate
- trim color
- edge profile
- handle color
- handle style

Each laminate comes with matching vinyl trim color unless otherwise specified on your purchase order.

Refer to the laminate & fabric finish cards for our current offering.

**Details:**

1. Includes locks and keys.
2. Comes equipped with levelers and adjustable shelves.

Code	Price	H	W	D	Volume (ft <sup>3</sup> )	Weight (lb)
T-FCSL-3621-G	3916	68	36	21	41.67	222.62

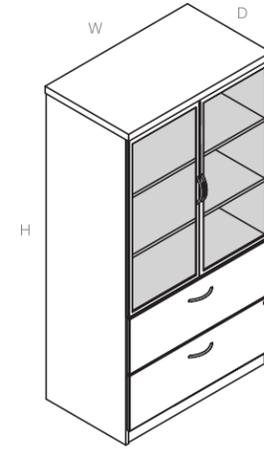

This storage tower combines the filing capabilities of a lateral storage unit with the flexibility of a cabinet. Drawers accept both letter and legal-sized paper.

Freestanding Combo Lateral Storage Tower Glazed Double Door, 1" Thick Top

**Ordering Options:**

Use the following checklist to customize the finishes on your order:

- laminate
- trim color
- handle color
- handle style

Each laminate comes with matching vinyl trim color unless otherwise specified on your purchase order.

Refer to the laminate & fabric finish cards for our current offering.

**Details:**

1. Includes locks and keys.
2. Comes equipped with levelers and adjustable shelves.

Code	Price	H	W	D	Volume (ft <sup>3</sup> )	Weight (lb)
TL-FCSL-3621-G	3706	67	36	21	41.09	213.05

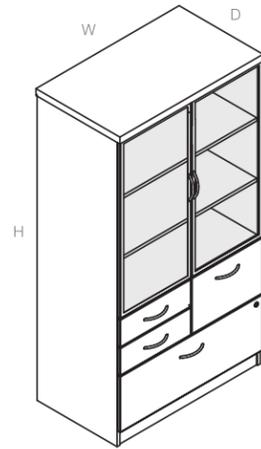

This storage tower combines the filing capabilities of lateral and underdesk storage with the flexibility of a cabinet. Drawers accept both letter and legal-sized paper.

Freestanding Combo Storage Tower Glazed Double Door, 1.5" Thick Top

**Ordering Options:**

Use the following checklist to customize the finishes on your order:

- laminate
- trim color
- edge profile
- handle color
- handle style

Each laminate comes with matching vinyl trim color unless otherwise specified on your purchase order.

Refer to the laminate & fabric finish cards for our current offering.

**Details:**

1. Includes locks and keys.
2. Comes equipped with levelers and adjustable shelves.

Code	Price	H	W	D	Volume (ft <sup>3</sup> )	Weight (lb)
T-FCSJ-3621-G	4178	68	36	21	41.67	229.87

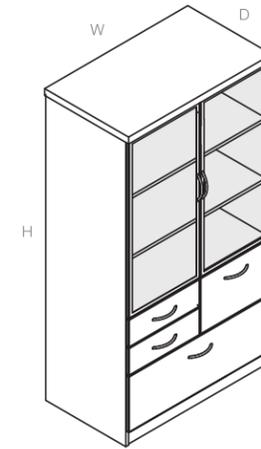

This storage tower combines the filing capabilities of lateral and underdesk storage with the flexibility of a cabinet. Drawers accept both letter and legal-sized paper.

Freestanding Combo Storage Tower Glazed Double Door, 1" Thick Top

**Ordering Options:**

Use the following checklist to customize the finishes on your order:

- laminate
- trim color
- handle color
- handle style

Each laminate comes with matching vinyl trim color unless otherwise specified on your purchase order.

Refer to the laminate & fabric finish cards for our current offering.

**Details:**

1. Includes locks and keys.
2. Comes equipped with levelers and adjustable shelves.

Code	Price	H	W	D	Volume (ft <sup>3</sup> )	Weight (lb)
TL-FCSJ-3621-G	3956	67	36	21	41.09	219.87

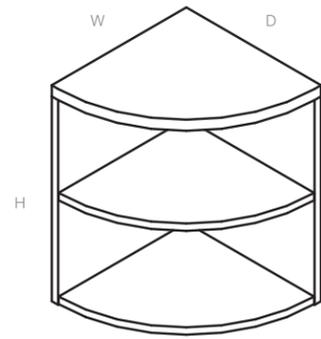

This bookcase provides open storage space within the workstation. Sits nicely against credenzas and other freestanding furniture.

Radius Corner Bookcase Short, 1.5" Thick Top

**Ordering Options:**

Use the following checklist to customize the finishes on your order:

- laminate
- trim color
- edge profile

Each laminate comes with matching vinyl trim color unless otherwise specified on your purchase order.

Refer to the laminate & fabric finish cards for our current offering.

**Details:**

1. Comes equipped with levelers and adjustable shelf.
2. Aligns with desk height.

Code	Price	H	W	D	Volume (ft <sup>3</sup> )	Weight (lb)
K-SBRC-292121	684	29.5	21	21	12.12	71
K-SBRC-292424	795	29.5	24	24	13.57	95.5

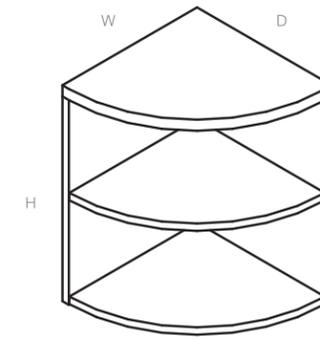

This bookcase provides open storage space within the workstation. Sits nicely against credenzas and other freestanding furniture.

Radius Corner Bookcase Short, 1" Thick Top

**Ordering Options:**

Use the following checklist to customize the finishes on your order:

- laminate
- trim color

Each laminate comes with matching vinyl trim color unless otherwise specified on your purchase order.

Refer to the laminate & fabric finish cards for our current offering.

**Details:**

1. Comes equipped with levelers and adjustable shelf.
2. Aligns with desk height.

Code	Price	H	W	D	Volume (ft <sup>3</sup> )	Weight (lb)
KL-SBRC-292121	594	29	21	21	11.94	50
KL-SBRC-292424	704	29	24	24	14.97	58



Metro Collab  
July 2023  
**Overhead  
Storage**

overhead storage

Executive

<u>open hutch</u>	150
<u>hinged door overhead storage</u>	152
<u>hinged door overhead storage glazed doors</u>	154

Professional

<u>open hutch</u>	151
<u>hinged door overhead storage</u>	153
<u>hinged door overhead storage glazed doors</u>	155

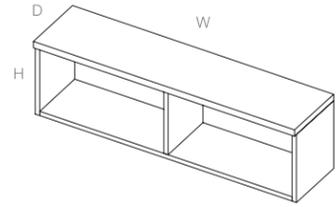

This open hutch provides open overhead storage within the workstation.

Open Hutch, 1.5" Thick Top

**Ordering Options:**

Use the following checklist to customize the finishes on your order:

- laminate
- trim color
- edge profile

Each laminate comes with matching vinyl trim color unless otherwise specified on your purchase order. Refer to the laminate finish card for our current offering.

**Details:**

1. Overheads 54 inches and wider require 4 large vertical posts for support.
2. Overheads 48 inches and smaller require 2 large vertical posts for support.
3. The 54, 60, 66, and 72 inch open hutches come with a divider.

Code	Price	H	W	D	Volume (ft <sup>3</sup> )	Weight (lb)
K-SHO-1524	493	17	24	15	8	32
K-SHO-1530	531	17	30	15	9	36
K-SHO-1536	567	17	36	15	10	40
K-SHO-1542	630	17	42	15	11	44
K-SHO-1548	667	17	48	15	12	48
K-SHO-1554	703	17	54	15	13	52
K-SHO-1560	765	17	60	15	14	55
K-SHO-1566	800	17	66	15	16	59
K-SHO-1572	836	17	72	15	17	63

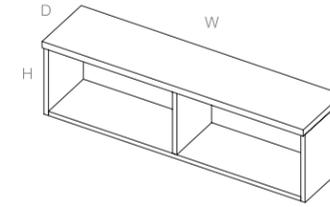

This open hutch provides open overhead storage within the workstation.

Open Hutch, 1" Thick Top

**Ordering Options:**

Use the following checklist to customize the finishes on your order:

- laminate
- trim color

Each laminate comes with matching vinyl trim color unless otherwise specified on your purchase order. Refer to the laminate finish card for our current offering.

**Details:**

1. Overheads 54 inches and wider require 4 large vertical posts for support.
2. Overheads 48 inches and smaller require 2 large vertical posts for support.

Code	Price	H	W	D	Volume (ft <sup>3</sup> )	Weight (lb)
KL-SHO-1524	469	17	24	15	8	31
KL-SHO-1530	499	17	30	15	9	35
KL-SHO-1536	531	17	36	15	10	39
KL-SHO-1542	590	17	42	15	11	43
KL-SHO-1548	618	17	48	15	12	47
KL-SHO-1554	651	17	54	15	13	51
KL-SHO-1560	704	17	60	15	14	54
KL-SHO-1566	738	17	66	15	16	58
KL-SHO-1572	767	17	72	15	17	62

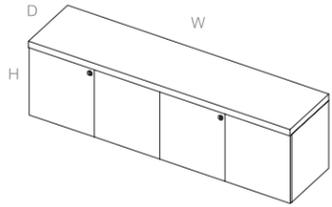

This hinged door hutch provides overhead storage within the workstation.

Hinged Door Overhead Storage, 1.5" Thick Top

**Ordering Options:**

Use the following checklist to customize the finishes on your order:

- laminate
- trim color
- edge profile

Each laminate comes with matching vinyl trim color unless otherwise specified on your purchase order. Refer to the laminate finish card for our current offering.

**Details:**

1. Overheads 54 inches and wider require 4 large vertical posts for support.
2. Overheads 48 inches and smaller require 2 large vertical posts for support.
3. The 54, 60, 66, and 72 inch open hutches come with a divider.

Code	Price	H	W	D	Volume (ft <sup>3</sup> )	Weight (lb)
K-SHH-1524-L	649	17	24	15	8	41
K-SHH-1530-L	715	17	30	15	9	47
K-SHH-1536-L	750	17	36	15	10	53
K-SHH-1542-L	910	17	42	15	11	59
K-SHH-1548-L	964	17	48	15	12	65
K-SHH-1554-L	1018	17	54	15	13	71
K-SHH-1560-L	1113	17	60	15	14	77
K-SHH-1566-L	1170	17	66	15	16	82
K-SHH-1572-L	1220	17	72	15	17	88

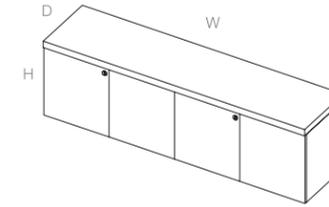

This hinged door hutch provides overhead storage within the workstation.

Hinged Door Overhead Storage, 1" Thick Top

**Ordering Options:**

Use the following checklist to customize the finishes on your order:

- laminate
- trim color

Each laminate comes with matching vinyl trim color unless otherwise specified on your purchase order. Refer to the laminate finish card for our current offering.

**Details:**

1. Overheads 54 inches and wider require 4 large vertical posts for support.
2. Overheads 48 inches and smaller require 2 large vertical posts for support.

Code	Price	H	W	D	Volume (ft <sup>3</sup> )	Weight (lb)
KL-SHH-1524-L	624	17	24	15	8	40
KL-SHH-1530-L	684	17	30	15	9	46
KL-SHH-1536-L	713	17	36	15	10	52
KL-SHH-1542-L	869	17	42	15	11	58
KL-SHH-1548-L	911	17	48	15	12	64
KL-SHH-1554-L	963	17	54	15	13	70
KL-SHH-1560-L	1051	17	60	15	14	76
KL-SHH-1566-L	1101	17	66	15	16	82
KL-SHH-1572-L	1144	17	72	15	17	88

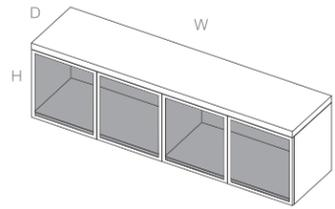

This hinged door hutch provides overhead storage within the workstation.

Hinged Door Overhead Storage Glazed Doors, 1.5" Thick Top

**Ordering Options:**

Use the following checklist to customize the finishes on your order:

- laminate
- trim color
- edge profile

Each laminate comes with matching vinyl trim color unless otherwise specified on your purchase order. Refer to the laminate finish card for our current offering.

**Details:**

1. Overheads 54 inches and wider require 4 large vertical posts for support.
2. Overheads 48 inches and smaller require 2 large vertical posts for support.
3. The 54, 60, 66, and 72 inch open hutches come with a divider.

Code	Price	H	W	D	Volume (ft <sup>3</sup> )	Weight (lb)
K-SHH-1524-G	946	17	24	15	8	41
K-SHH-1530-G	1013	17	30	15	9	47
K-SHH-1536-G	1078	17	36	15	10	53
K-SHH-1542-G	1299	17	42	15	11	59
K-SHH-1548-G	1363	17	48	15	12	65
K-SHH-1554-G	1429	17	54	15	13	71
K-SHH-1560-G	1659	17	60	15	14	77
K-SHH-1566-G	1723	17	66	15	16	83
K-SHH-1572-G	1786	17	72	15	17	89

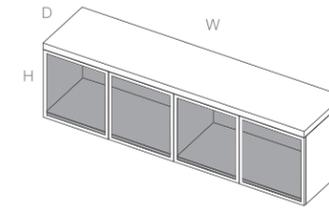

This hinged door hutch provides overhead storage within the workstation.

Hinged Door Overhead Storage Glazed Doors, 1" Thick Top

**Ordering Options:**

Use the following checklist to customize the finishes on your order:

- laminate
- trim color

Each laminate comes with matching vinyl trim color unless otherwise specified on your purchase order. Refer to the laminate finish card for our current offering.

**Details:**

1. Overheads 54 inches and wider require 4 large vertical posts for support.
2. Overheads 48 inches and smaller require 2 large vertical posts for support.

Code	Price	H	W	D	Volume (ft <sup>3</sup> )	Weight (lb)
KL-SHH-1524-G	919	17	24	15	8	40
KL-SHH-1530-G	988	17	30	15	9	46
KL-SHH-1536-G	1059	17	36	15	10	52
KL-SHH-1542-G	1263	17	42	15	11	58
KL-SHH-1548-G	1333	17	48	15	12	64
KL-SHH-1554-G	1404	17	54	15	13	70
KL-SHH-1560-G	1609	17	60	15	14	76
KL-SHH-1566-G	1680	17	66	15	16	82
KL-SHH-1572-G	1750	17	72	15	17	88



Metro Collab  
July 2023  
**Posts**

<u>large vertical aluminum post</u>	<u>158</u>
<u>small vertical aluminum post</u>	<u>159</u>



This large post supports overhead storage and screens.

Large Vertical Aluminum Post

**Ordering Options:**

Use the following checklist to customize the finishes on your order:

- metal color

**Details:**

1. Large vertical aluminum posts support overheads and hutches.
2. Surfaces 54 inches and wider require 4 posts in a span.

Code	Price	H	W	D	Volume (ft <sup>3</sup> )	Weight (lb)
K-PO-24	146	24	0	5	0.1	1.41



This small post supports countertops and screens.

Small Vertical Aluminum Post

**Ordering Options:**

Use the following checklist to customize the finishes on your order:

- metal color

**Details:**

1. Large vertical aluminum posts support overheads and hutches.
2. Surfaces 54 inches and wider require 4 posts in a span.

Code	Price	H	W	D	Volume (ft <sup>3</sup> )	Weight (lb)
K-PS-08	67	8	0	2.5	0.08	0.24
K-PS-12	73	12	0	2.5	0.03	0.36
K-PS-16	75	16	0	2.5	0.04	0.48
K-PS-24	89	24	0	2.5	0.05	0.75
K-PS-32	105	32	0	2.5	0.07	0.95



Metro Collab  
July 2023  
**Electrics**

electrics

<u>power box</u>	162
<u>data box</u>	163
<u>electrical starter harness</u>	164
<u>electrical splitter harness</u>	165
<u>electrical harness</u>	166

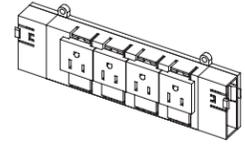

**Ordering Options:**

There are no ordering options for these items

Code	Price	H	W	D	Volume (ft <sup>3</sup> )	Weight (lb)
K-EM84-M	198	3	80	2	0.02	0.6

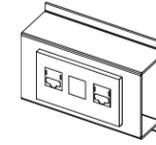

**Ordering Options:**

There are no ordering options for these items

Code	Price	H	W	D	Volume (ft <sup>3</sup> )	Weight (lb)
K-ECK1-M	168	3	4	1	0.02	0.6



**Ordering Options:**

There are no ordering options for these items

Code	Price	H	W	D	Volume (ft <sup>3</sup> )	Weight (lb)
K-ES84-072	330	0	72	0	2.96	2.48
K-ES84-168	563	0	168	0	5.12	4.59

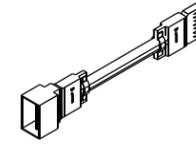

**Ordering Options:**

There are no ordering options for these items

Code	Price	H	W	D	Volume (ft <sup>3</sup> )	Weight (lb)
K-EX84-12	125	0	12	0	0.05	0.9



**Ordering Options:**

There are no ordering options for these items

Code	Price	H	W	D	Volume (ft <sup>3</sup> )	Weight (lb)
K-EH-22	193	0	22	0	0.6	0.7
K-EH-25	198	0	25	0	0.7	0.7
K-EH-28	204	0	28	0	0.8	0.7
K-EH-31	208	0	31	0	0.8	0.8
K-EH-34	218	0	34	0	0.9	0.8
K-EH-37	227	0	37	0	1	1
K-EH-40	230	0	40	0	1.1	1
K-EH-43	240	0	43	0	1.2	1.2
K-EH-46	249	0	46	0	1.3	1.5
K-EH-49	255	0	49	0	1.5	1.5
K-EH-52	263	0	52	0	1.5	1.6
K-EH-55	266	0	55	0	1.6	1.6
K-EH-58	276	0	58	0	1.7	1.8
K-EH-61	282	0	61	0	1.8	1.8
K-EH-64	288	0	64	0	1.9	1.9
K-EH-67	293	0	67	0	1.9	1.9
K-EH-70	306	0	70	0	2	1.95
K-EH-73	310	0	73	0	1.95	1.95
K-EH-76	316	0	76	0	2.04	2.12
K-EH-79	327	0	79	0	2.12	2.12
K-EH-82	330	0	82	0	2.12	2.37
K-EH-85	339	0	85	0	2.37	2.37
K-EH-88	349	0	88	0	2.37	2.37
K-EH-91	354	0	91	0	2.37	2.37

continued on next page

electrical harness continued [2 of 2]

Code	Price	H	W	D	Volume (ft <sup>3</sup> )	Weight (lb)
K-EH-94	361	0	94	0	2.53	2.53
K-EH-97	367	0	97	0	2.53	2.53
K-EH-100	377	0	100	0	2.7	2.7
K-EH-103	384	0	103	0	2.7	2.7
K-EH-106	391	0	106	0	2.86	2.86
K-EH-109	397	0	109	0	2.86	2.86
K-EH-112	404	0	112	0	3.03	3.03
K-EH-115	413	0	115	0	3.03	3.03
K-EH-118	419	0	118	0	3.19	3.36
K-EH-121	425	0	121	0	3.36	3.36
K-EH-124	432	0	124	0	3.36	3.46
K-EH-127	442	0	127	0	3.52	3.46
K-EH-130	446	0	130	0	3.52	3.56
K-EH-133	451	0	133	0	3.39	3.56
K-EH-136	461	0	136	0	3.68	3.76
K-EH-139	469	0	139	0	3.85	3.76
K-EH-142	474	0	142	0	3.85	3.86
K-EH-145	626	0	145	0	3.85	3.86
K-EH-148	631	0	148	0	3.85	3.86
K-EH-151	641	0	151	0	4.18	4.06
K-EH-154	646	0	154	0	4.26	4.06
K-EH-157	651	0	157	0	4.35	4.16
K-EH-160	658	0	160	0	4.43	4.16
K-EH-163	668	0	163	0	4.51	4.26
K-EH-166	674	0	166	0	4.59	4.26
K-EH-169	678	0	169	0	4.68	4.46
K-EH-172	689	0	172	0	4.76	4.46
K-EH-175	694	0	175	0	4.84	4.46
K-EH-178	699	0	178	0	4.92	4.66
K-EH-181	705	0	181	0	5.01	4.66



Metro Collab  
July 2023  
**Screens**

screens

<u>laminare screens</u>	170
<u>fabric screens</u>	175
<u>glazed screens</u>	180
<u>whiteboard screens</u>	185
<u>accessory screen</u>	189

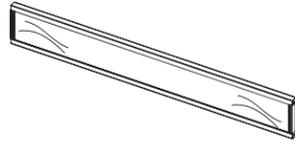

**Ordering Options:**

Use the following checklist to customize the finishes on your order:

- laminate color

**Details:**

1. Specify screen width to match surface width.
2. Surfaces 78 inches and wider require 2 screens and filler.

Code	Price	H	W	D	Volume (ft³)	Weight (lb.)
K-SL0-0418	45	4	18	0	0.02	1.2
K-SL0-0421	46	4	21	0	0.03	1.4
K-SL0-0424	48	4	24	0	0.03	1.6
K-SL0-0427	52	4	27	0	0.03	1.8
K-SL0-0430	55	4	30	0	0.04	2
K-SL0-0433	56	4	33	0	0.04	2.3
K-SL0-0436	57	4	36	0	0.05	2.5
K-SL0-0439	61	4	39	0	0.05	2.7
K-SL0-0442	63	4	42	0	0.06	2.9
K-SL0-0445	65	4	45	0	0.06	3.1
K-SL0-0448	67	4	48	0	0.07	3.3
K-SL0-0451	72	4	51	0	0.07	3.5
K-SL0-0454	73	4	54	0	0.08	3.7
K-SL0-0457	76	4	57	0	0.08	3.9

continued on next page

laminate screens 2 of 5 continued

Code	Price	H	W	D	Volume (ft³)	Weight (lb.)
K-SL0-0460	77	4	60	0	0.09	4.1
K-SL0-0463	81	4	63	0	0.09	4.3
K-SL0-0466	85	4	66	0	0.1	4.5
K-SL0-0469	85	4	69	0	0.1	4.7
K-SL0-0472	86	4	72	0	0.11	4.9
K-SL0-0804	35	8	4	0	0.01	1
K-SL0-0818	52	8	18	0	0.04	2.4
K-SL0-0821	56	8	21	0	0.06	2.8
K-SL0-0824	59	8	24	0	0.06	3.2
K-SL0-0827	63	8	27	0	0.06	3.6
K-SL0-0830	65	8	30	0	0.08	4
K-SL0-0833	68	8	33	0	0.08	4.6
K-SL0-0836	73	8	36	0	0.1	5
K-SL0-0839	76	8	39	0	0.1	5.4
K-SL0-0842	79	8	42	0	0.12	5.8
K-SL0-0845	83	8	45	0	0.12	6.2
K-SL0-0848	86	8	48	0	0.14	6.6
K-SL0-0851	89	8	51	0	0.14	7
K-SL0-0854	94	8	54	0	0.16	7.4
K-SL0-0857	99	8	57	0	0.16	7.8
K-SL0-0860	103	8	60	0	0.18	8.2
K-SL0-0863	106	8	63	0	0.18	8.6
K-SL0-0866	108	8	66	0	0.2	9
K-SL0-0869	113	8	69	0	0.2	9.4
K-SL0-0872	117	8	72	0	0.2	9.8
K-SL0-1204	39	12	4	0	0.01	1.1
K-SL0-1218	59	12	18	0	0.06	3.6
K-SL0-1221	64	12	21	0	0.09	4.2
K-SL0-1224	65	12	24	0	0.09	4.8
K-SL0-1227	73	12	27	0	0.09	5.4
K-SL0-1230	76	12	30	0	0.12	6

laminate screens 3 of 5 continued

Code	Price	H	W	D	Volume (ft³)	Weight (lb.)
K-SL0-1233	81	12	33	0	0.12	6.9
K-SL0-1236	86	12	36	0	0.15	7.5
K-SL0-1239	89	12	39	0	0.15	8.1
K-SL0-1242	95	12	42	0	0.18	8.7
K-SL0-1245	101	12	45	0	0.18	9.3
K-SL0-1248	106	12	48	0	0.21	9.9
K-SL0-1251	109	12	51	0	0.21	10.5
K-SL0-1254	116	12	54	0	0.24	11.1
K-SL0-1257	120	12	57	0	0.24	11.7
K-SL0-1260	124	12	60	0	0.27	12.3
K-SL0-1263	130	12	63	0	0.27	12.9
K-SL0-1266	135	12	66	0	0.3	13.5
K-SL0-1269	142	12	69	0	0.3	14.1
K-SL0-1272	145	12	72	0	0.33	14.7
K-SL0-1604	40	16	4	0	0.02	1.2
K-SL0-1618	65	16	18	0	0.08	4.8
K-SL0-1621	73	16	21	0	0.12	5.6
K-SL0-1624	76	16	24	0	0.12	6.4
K-SL0-1627	83	16	27	0	0.12	7.2
K-SL0-1630	88	16	30	0	0.16	8
K-SL0-1633	95	16	33	0	0.16	9.2
K-SL0-1636	101	16	36	0	0.2	10
K-SL0-1639	107	16	39	0	0.2	10.8
K-SL0-1642	113	16	42	0	0.24	11.6
K-SL0-1645	119	16	45	0	0.24	12.4
K-SL0-1648	124	16	48	0	0.28	13.2
K-SL0-1651	131	16	51	0	0.28	14
K-SL0-1654	140	16	54	0	0.32	14.8
K-SL0-1657	144	16	57	0	0.32	15.6
K-SL0-1660	149	16	60	0	0.36	16.4
K-SL0-1663	156	16	63	0	0.36	17.2

laminate screens 4 of 5 continued

Code	Price	H	W	D	Volume (ft³)	Weight (lb.)
K-SL0-1666	161	16	66	0	0.4	18
K-SL0-1669	168	16	69	0	0.4	18.8
K-SL0-1672	176	16	72	0	0.44	19.6
K-SL0-2004	44	20	4	0	0.03	1.4
K-SL0-2018	73	20	18	0	0.1	6
K-SL0-2021	81	20	21	0	0.15	7
K-SL0-2024	85	20	24	0	0.15	8
K-SL0-2027	94	20	27	0	0.15	9
K-SL0-2030	103	20	30	0	0.2	10
K-SL0-2033	108	20	33	0	0.2	11.5
K-SL0-2036	116	20	36	0	0.25	12.5
K-SL0-2039	122	20	39	0	0.25	13.5
K-SL0-2042	130	20	42	0	0.3	14.5
K-SL0-2045	140	20	45	0	0.3	15.5
K-SL0-2048	145	20	48	0	0.35	16.5
K-SL0-2051	152	20	51	0	0.35	17.5
K-SL0-2054	158	20	54	0	0.4	18.5
K-SL0-2057	166	20	57	0	0.4	19.5
K-SL0-2060	174	20	60	0	0.45	20.5
K-SL0-2063	182	20	63	0	0.45	21.5
K-SL0-2066	191	20	66	0	0.5	22.5
K-SL0-2069	198	20	69	0	0.5	23.5
K-SL0-2072	204	20	72	0	0.55	24.5
K-SL0-2404	45	24	4	0	0.03	1.6
K-SL0-2418	81	24	18	0	0.12	7.2
K-SL0-2421	89	24	21	0	0.18	8.4
K-SL0-2424	95	24	24	0	0.18	9.6
K-SL0-2427	106	24	27	0	0.18	10.8
K-SL0-2430	113	24	30	0	0.24	12
K-SL0-2433	121	24	33	0	0.24	13.8
K-SL0-2436	130	24	36	0	0.3	15

laminate screens 5 of 5 continued

Code	Price	H	W	D	Volume (ft <sup>3</sup> )	Weight (lb.)
K-SL0-2439	141	24	39	0	0.3	16.2
K-SL0-2442	146	24	42	0	0.36	17.4
K-SL0-2445	156	24	45	0	0.36	18.6
K-SL0-2448	164	24	48	0	0.42	19.8
K-SL0-2451	171	24	51	0	0.42	21
K-SL0-2454	182	24	54	0	0.48	22.2
K-SL0-2457	193	24	57	0	0.48	23.4
K-SL0-2460	200	24	60	0	0.54	24.6
K-SL0-2463	206	24	63	0	0.54	25.8
K-SL0-2466	217	24	66	0	0.6	27
K-SL0-2469	226	24	69	0	0.6	28.2
K-SL0-2472	232	24	72	0	0.66	29.4
K-SL0-3204	48	32	4	0	0.04	2.3
K-SL0-3218	96	32	18	0	0.16	9.6
K-SL0-3221	108	32	21	0	0.24	11.2
K-SL0-3224	117	32	24	0	0.24	12.8
K-SL0-3227	129	32	27	0	0.24	14.4
K-SL0-3230	141	32	30	0	0.32	16
K-SL0-3233	149	32	33	0	0.32	18.4
K-SL0-3236	160	32	36	0	0.4	20
K-SL0-3239	171	32	39	0	0.4	21.6
K-SL0-3242	182	32	42	0	0.48	23.2
K-SL0-3245	196	32	45	0	0.48	24.8
K-SL0-3248	204	32	48	0	0.56	26.4
K-SL0-3251	217	32	51	0	0.56	28
K-SL0-3254	227	32	54	0	0.64	29.6
K-SL0-3257	238	32	57	0	0.64	31.2
K-SL0-3260	249	32	60	0	0.72	32.8
K-SL0-3263	261	32	63	0	0.72	34.4
K-SL0-3266	270	32	66	0	0.8	36
K-SL0-3269	281	32	69	0	0.8	37.6
K-SL0-3272	290	32	72	0	0.88	39.2

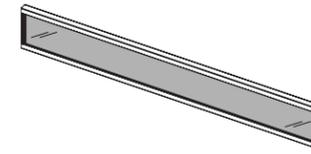

**Ordering Options:**

Use the following checklist to customize the finishes on your order:

- glazing

**Details:**

1. Specify screen width to match surface width.
2. Surfaces 78 inches and wider require 2 screens and filler.

Code	Price	H	W	D	Volume (ft <sup>3</sup> )	Weight (lb.)
K-SF0-0418	119	4	18	0	0.02	1.3
K-SF0-0421	120	4	21	0	0.03	1.4
K-SF0-0424	120	4	24	0	0.03	1.5
K-SF0-0427	121	4	27	0	0.03	1.6
K-SF0-0430	122	4	30	0	0.04	1.7
K-SF0-0433	124	4	33	0	0.04	1.8
K-SF0-0436	125	4	36	0	0.05	1.8
K-SF0-0439	129	4	39	0	0.05	1.9
K-SF0-0442	145	4	42	0	0.06	2
K-SF0-0445	146	4	45	0	0.06	2.1
K-SF0-0448	149	4	48	0	0.07	2.2
K-SF0-0451	149	4	51	0	0.07	2.3
K-SF0-0454	152	4	54	0	0.08	2.3
K-SF0-0457	154	4	57	0	0.08	2.4
K-SF0-0460	156	4	60	0	0.09	2.5

continued on next page

**fabric screens 2 of 5 continued**

Code	Price	H	W	D	Volume (ft³)	Weight (lb.)
K-SF0-0463	157	4	63	0	0.09	2.6
K-SF0-0466	158	4	66	0	0.1	2.7
K-SF0-0469	160	4	69	0	0.1	2.8
K-SF0-0472	161	4	72	0	0.11	2.8
K-SF0-0804	109	8	4	0	0.01	0.7
K-SF0-0818	133	8	18	0	0.04	2.7
K-SF0-0821	135	8	21	0	0.06	2.9
K-SF0-0824	135	8	24	0	0.06	3
K-SF0-0827	141	8	27	0	0.06	3.2
K-SF0-0830	142	8	30	0	0.08	3.3
K-SF0-0833	143	8	33	0	0.08	3.5
K-SF0-0836	144	8	36	0	0.1	3.7
K-SF0-0839	145	8	39	0	0.1	3.9
K-SF0-0842	176	8	42	0	0.12	4
K-SF0-0845	178	8	45	0	0.12	4.2
K-SF0-0848	180	8	48	0	0.14	4.3
K-SF0-0851	180	8	51	0	0.14	4.5
K-SF0-0854	182	8	54	0	0.16	4.7
K-SF0-0857	186	8	57	0	0.16	4.9
K-SF0-0860	190	8	60	0	0.18	5
K-SF0-0863	191	8	63	0	0.18	5.2
K-SF0-0866	193	8	66	0	0.2	5.3
K-SF0-0869	196	8	69	0	0.2	5.5
K-SF0-0872	197	8	72	0	0.22	5.7
K-SF0-1204	110	12	4	0	0.01	1
K-SF0-1218	146	12	18	0	0.06	4
K-SF0-1221	149	12	21	0	0.09	4.3
K-SF0-1224	149	12	24	0	0.09	4.5
K-SF0-1227	154	12	27	0	0.09	4.8
K-SF0-1230	156	12	30	0	0.12	5
K-SF0-1233	157	12	33	0	0.12	5.3

**fabric screens 3 of 5 continued**

Code	Price	H	W	D	Volume (ft³)	Weight (lb.)
K-SF0-1236	158	12	36	0	0.15	5.5
K-SF0-1239	161	12	39	0	0.15	5.8
K-SF0-1242	205	12	42	0	0.18	6
K-SF0-1245	206	12	45	0	0.18	6.3
K-SF0-1248	208	12	48	0	0.21	6.5
K-SF0-1251	208	12	51	0	0.21	6.8
K-SF0-1254	215	12	54	0	0.24	7
K-SF0-1257	218	12	57	0	0.24	7.3
K-SF0-1260	220	12	60	0	0.27	7.5
K-SF0-1263	221	12	63	0	0.27	7.8
K-SF0-1266	226	12	66	0	0.3	8
K-SF0-1269	227	12	69	0	0.3	8.3
K-SF0-1272	229	12	72	0	0.33	8.5
K-SF0-1604	110	16	4	0	0.02	1.3
K-SF0-1618	161	16	18	0	0.08	5.3
K-SF0-1621	165	16	21	0	0.12	5.7
K-SF0-1624	165	16	24	0	0.12	6
K-SF0-1627	168	16	27	0	0.12	6.4
K-SF0-1630	169	16	30	0	0.16	6.7
K-SF0-1633	174	16	33	0	0.16	7.1
K-SF0-1636	176	16	36	0	0.2	7.3
K-SF0-1639	179	16	39	0	0.2	7.7
K-SF0-1642	234	16	42	0	0.24	8
K-SF0-1645	238	16	45	0	0.24	8.4
K-SF0-1648	244	16	48	0	0.28	8.7
K-SF0-1651	245	16	51	0	0.28	9.1
K-SF0-1654	246	16	54	0	0.32	9.3
K-SF0-1657	250	16	57	0	0.32	9.7
K-SF0-1660	255	16	60	0	0.36	10
K-SF0-1663	256	16	63	0	0.36	10.4
K-SF0-1666	259	16	66	0	0.4	10.7

**fabric screens 4 of 5 continued**

Code	Price	H	W	D	Volume (ft³)	Weight (lb.)
K-SF0-1669	263	16	69	0	0.4	11.1
K-SF0-1672	265	16	72	0	0.44	11.3
K-SF0-2004	113	20	4	0	0.03	1.4
K-SF0-2018	178	20	18	0	0.1	6.7
K-SF0-2021	180	20	21	0	0.15	7.2
K-SF0-2024	180	20	24	0	0.15	7.5
K-SF0-2027	183	20	27	0	0.15	8
K-SF0-2030	190	20	30	0	0.2	8.3
K-SF0-2033	193	20	33	0	0.2	8.8
K-SF0-2036	196	20	36	0	0.25	9.2
K-SF0-2039	197	20	39	0	0.25	9.7
K-SF0-2042	268	20	42	0	0.3	10
K-SF0-2045	271	20	45	0	0.3	10.5
K-SF0-2048	276	20	48	0	0.35	10.8
K-SF0-2051	278	20	51	0	0.35	11.3
K-SF0-2054	279	20	54	0	0.4	11.7
K-SF0-2057	282	20	57	0	0.4	12.2
K-SF0-2060	286	20	60	0	0.45	12.5
K-SF0-2063	289	20	63	0	0.45	13
K-SF0-2066	293	20	66	0	0.5	13.3
K-SF0-2069	299	20	69	0	0.5	13.8
K-SF0-2072	301	20	72	0	0.55	14.2
K-SF0-2404	113	24	4	0	0.03	2
K-SF0-2418	195	24	18	0	0.12	8
K-SF0-2421	197	24	21	0	0.18	8.6
K-SF0-2424	197	24	24	0	0.18	9
K-SF0-2427	201	24	27	0	0.18	9.6
K-SF0-2430	204	24	30	0	0.24	10
K-SF0-2433	206	24	33	0	0.24	10.6
K-SF0-2436	208	24	36	0	0.3	11
K-SF0-2439	215	24	39	0	0.3	11.6

**fabric screens 5 of 5 continued**

Code	Price	H	W	D	Volume (ft³)	Weight (lb.)
K-SF0-2442	301	24	42	0	0.36	12
K-SF0-2445	305	24	45	0	0.36	12.6
K-SF0-2448	307	24	48	0	0.42	13
K-SF0-2451	310	24	51	0	0.42	13.6
K-SF0-2454	314	24	54	0	0.48	14
K-SF0-2457	317	24	57	0	0.48	14.6
K-SF0-2460	321	24	60	0	0.54	15
K-SF0-2463	325	24	63	0	0.54	15.6
K-SF0-2466	328	24	66	0	0.6	16
K-SF0-2469	330	24	69	0	0.6	26.6
K-SF0-2472	337	24	72	0	0.66	17
K-SF0-3204	117	32	4	0	0.04	2.7
K-SF0-3218	224	32	18	0	0.16	10.7
K-SF0-3221	228	32	21	0	0.24	11.5
K-SF0-3224	229	32	24	0	0.24	12
K-SF0-3227	232	32	27	0	0.24	12.8
K-SF0-3230	238	32	30	0	0.32	13.3
K-SF0-3233	244	32	33	0	0.32	14.1
K-SF0-3236	246	32	36	0	0.4	14.7
K-SF0-3239	250	32	39	0	0.4	15.5
K-SF0-3242	363	32	42	0	0.48	16
K-SF0-3245	365	32	45	0	0.48	16.8
K-SF0-3248	373	32	48	0	0.56	17.3
K-SF0-3251	375	32	51	0	0.56	18.1
K-SF0-3254	378	32	54	0	0.64	18.7
K-SF0-3257	384	32	57	0	0.64	19.5
K-SF0-3260	389	32	60	0	0.72	20
K-SF0-3263	392	32	63	0	0.72	20.8
K-SF0-3266	397	32	66	0	0.8	21.3
K-SF0-3269	399	32	69	0	0.8	22.1
K-SF0-3272	404	32	72	0	0.88	22.7

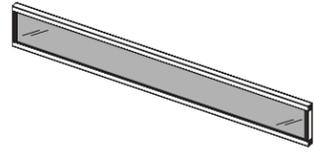

**Ordering Options:**

Use the following checklist to customize the finishes on your order:

- glazing color

**Details:**

1. Specify screen width to match surface width.
2. Surfaces 78 inches and wider require 2 screens and filler.

Code	Price	H	W	D	Volume (ft³)	Weight (lb.)
K-SG0-0418	144	4	18	0	0.02	0.8
K-SG0-0421	156	4	21	0	0.03	0.9
K-SG0-0424	166	4	24	0	0.03	0.98
K-SG0-0427	180	4	27	0	0.03	1.1
K-SG0-0430	195	4	30	0	0.04	1.23
K-SG0-0433	204	4	33	0	0.04	1.3
K-SG0-0436	218	4	36	0	0.05	1.47
K-SG0-0439	229	4	39	0	0.05	1.6
K-SG0-0442	244	4	42	0	0.06	1.72
K-SG0-0445	256	4	45	0	0.06	1.8
K-SG0-0448	266	4	48	0	0.07	1.96
K-SG0-0451	279	4	51	0	0.07	2.1
K-SG0-0454	290	4	54	0	0.08	2.21
K-SG0-0457	306	4	57	0	0.08	2.3
K-SG0-0460	317	4	60	0	0.09	2.45

continued on next page

glazed screens 2 of 5 continued

Code	Price	H	W	D	Volume (ft³)	Weight (lb.)
K-SG0-0463	330	4	63	0	0.09	2.6
K-SG0-0466	342	4	66	0	0.1	2.8
K-SG0-0469	358	4	69	0	0.1	3
K-SG0-0472	366	4	72	0	0.11	3.2
K-SG0-0804	53	8	4	0	0.01	0.4
K-SG0-0818	161	8	18	0	0.04	1.6
K-SG0-0821	179	8	21	0	0.06	1.8
K-SG0-0824	197	8	24	0	0.06	1.96
K-SG0-0827	209	8	27	0	0.06	2.2
K-SG0-0830	229	8	30	0	0.08	2.46
K-SG0-0833	246	8	33	0	0.08	2.6
K-SG0-0836	264	8	36	0	0.1	2.94
K-SG0-0839	279	8	39	0	0.1	3.2
K-SG0-0842	299	8	42	0	0.12	3.44
K-SG0-0845	314	8	45	0	0.12	3.6
K-SG0-0848	330	8	48	0	0.14	3.92
K-SG0-0851	347	8	51	0	0.14	4.2
K-SG0-0854	365	8	54	0	0.16	4.42
K-SG0-0857	384	8	57	0	0.16	4.6
K-SG0-0860	399	8	60	0	0.18	4.9
K-SG0-0863	418	8	63	0	0.18	5.2
K-SG0-0866	432	8	66	0	0.2	5.6
K-SG0-0869	450	8	69	0	0.2	6
K-SG0-0872	469	8	72	0	0.22	6.4
K-SG0-1204	59	12	4	0	0.01	0.6
K-SG0-1218	182	12	18	0	0.06	2.4
K-SG0-1221	202	12	21	0	0.09	2.7
K-SG0-1224	226	12	24	0	0.09	2.94
K-SG0-1227	246	12	27	0	0.09	3.3
K-SG0-1230	268	12	30	0	0.12	3.69
K-SG0-1233	288	12	33	0	0.12	3.9

glazed screens 3 of 5 continued

Code	Price	H	W	D	Volume (ft³)	Weight (lb.)
K-SG0-1236	310	12	36	0	0.15	4.41
K-SG0-1239	333	12	39	0	0.15	4.8
K-SG0-1242	351	12	42	0	0.18	5.16
K-SG0-1245	375	12	45	0	0.18	5.4
K-SG0-1248	397	12	48	0	0.21	5.88
K-SG0-1251	418	12	51	0	0.21	6.3
K-SG0-1254	440	12	54	0	0.24	6.63
K-SG0-1257	461	12	57	0	0.24	6.9
K-SG0-1260	482	12	60	0	0.27	7.35
K-SG0-1263	504	12	63	0	0.27	7.8
K-SG0-1266	527	12	66	0	0.3	8.4
K-SG0-1269	546	12	69	0	0.3	9
K-SG0-1272	569	12	72	0	0.33	9.6
K-SG0-1604	67	16	4	0	0.02	0.8
K-SG0-1618	220	16	18	0	0.08	3.2
K-SG0-1621	246	16	21	0	0.12	3.6
K-SG0-1624	271	16	24	0	0.12	3.92
K-SG0-1627	299	16	27	0	0.12	4.4
K-SG0-1630	325	16	30	0	0.16	4.92
K-SG0-1633	349	16	33	0	0.16	5.2
K-SG0-1636	375	16	36	0	0.2	5.88
K-SG0-1639	402	16	39	0	0.2	6.4
K-SG0-1642	427	16	42	0	0.24	6.88
K-SG0-1645	451	16	45	0	0.24	7.2
K-SG0-1648	480	16	48	0	0.28	7.84
K-SG0-1651	504	16	51	0	0.28	8.4
K-SG0-1654	531	16	54	0	0.32	8.84
K-SG0-1657	556	16	57	0	0.32	9.2
K-SG0-1660	583	16	60	0	0.36	9.8
K-SG0-1663	608	16	63	0	0.36	10.4
K-SG0-1666	633	16	66	0	0.4	11.2

glazed screens 4 of 5 continued

Code	Price	H	W	D	Volume (ft³)	Weight (lb.)
K-SG0-1669	661	16	69	0	0.4	12
K-SG0-1672	686	16	72	0	0.44	12.8
K-SG0-2004	75	20	4	0	0.03	0.9
K-SG0-2018	221	20	18	0	0.1	4
K-SG0-2021	255	20	21	0	0.15	4.5
K-SG0-2024	282	20	24	0	0.15	4.9
K-SG0-2027	314	20	27	0	0.15	5.5
K-SG0-2030	343	20	30	0	0.2	6.15
K-SG0-2033	375	20	33	0	0.2	6.5
K-SG0-2036	404	20	36	0	0.25	7.35
K-SG0-2039	433	20	39	0	0.25	8
K-SG0-2042	468	20	42	0	0.3	8.6
K-SG0-2045	496	20	45	0	0.3	9
K-SG0-2048	529	20	48	0	0.35	9.8
K-SG0-2051	556	20	51	0	0.35	10.5
K-SG0-2054	587	20	54	0	0.4	11.05
K-SG0-2057	617	20	57	0	0.4	11.5
K-SG0-2060	649	20	60	0	0.45	12.25
K-SG0-2063	678	20	63	0	0.45	13
K-SG0-2066	708	20	66	0	0.5	14
K-SG0-2069	740	20	69	0	0.5	15
K-SG0-2072	771	20	72	0	0.55	16
K-SG0-2404	81	24	4	0	0.03	0.98
K-SG0-2418	243	24	18	0	0.12	4.8
K-SG0-2421	277	24	21	0	0.18	5.4
K-SG0-2424	311	24	24	0	0.18	5.88
K-SG0-2427	345	24	27	0	0.18	6.6
K-SG0-2430	382	24	30	0	0.24	7.38
K-SG0-2433	418	24	33	0	0.24	7.8
K-SG0-2436	450	24	36	0	0.3	8.82
K-SG0-2439	484	24	39	0	0.3	9.6

glazed screens 5 of 5 continued

Code	Price	H	W	D	Volume (ft³)	Weight (lb.)
K-SG0-2442	521	24	42	0	0.36	10.32
K-SG0-2445	553	24	45	0	0.36	10.8
K-SG0-2448	592	24	48	0	0.42	11.76
K-SG0-2451	627	24	51	0	0.42	12.6
K-SG0-2454	658	24	54	0	0.48	13.26
K-SG0-2457	696	24	57	0	0.48	13.8
K-SG0-2460	733	24	60	0	0.54	14.7
K-SG0-2463	766	24	63	0	0.54	15.6
K-SG0-2466	801	24	66	0	0.6	16.8
K-SG0-2469	836	24	69	0	0.6	18
K-SG0-2472	871	24	72	0	0.66	19.2
K-SG0-3204	95	32	4	0	0.04	1.3
K-SG0-3218	281	32	18	0	0.16	6.4
K-SG0-3221	327	32	21	0	0.24	7.2
K-SG0-3224	367	32	24	0	0.24	7.84
K-SG0-3227	414	32	27	0	0.24	8.8
K-SG0-3230	459	32	30	0	0.32	9.84
K-SG0-3233	501	32	33	0	0.32	10.4
K-SG0-3236	545	32	36	0	0.4	11.76
K-SG0-3239	590	32	39	0	0.4	12.8
K-SG0-3242	631	32	42	0	0.48	13.76
K-SG0-3245	677	32	45	0	0.48	14.4
K-SG0-3248	717	32	48	0	0.56	15.68
K-SG0-3251	765	32	51	0	0.56	16.8
K-SG0-3254	809	32	54	0	0.64	17.68
K-SG0-3257	851	32	57	0	0.64	18.4
K-SG0-3260	897	32	60	0	0.72	19.6
K-SG0-3263	941	32	63	0	0.72	20.8
K-SG0-3266	983	32	66	0	0.8	22.4
K-SG0-3269	1029	32	69	0	0.8	24
K-SG0-3272	1075	32	72	0	0.88	25.6

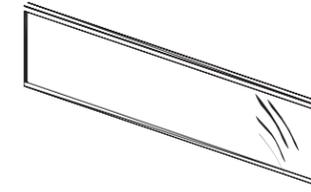

Ordering Options:

There are no ordering options for this item.

Details:

1. Specify screen width to match surface width.
2. Surfaces 78 inches and wider require 2 screens and filler.

Code	Price	H	W	D	Volume (ft³)	Weight (lb.)
K-SW0-0818	84	8	18	0	0.04	2.4
K-SW0-0821	89	8	21	0	0.06	2.8
K-SW0-0824	96	8	24	0	0.06	3.2
K-SW0-0827	101	8	27	0	0.06	3.6
K-SW0-0830	107	8	30	0	0.08	4
K-SW0-0833	112	8	33	0	0.08	4.6
K-SW0-0836	119	8	36	0	0.1	5
K-SW0-0839	124	8	39	0	0.1	5.4
K-SW0-0842	131	8	42	0	0.12	5.8
K-SW0-0845	133	8	45	0	0.12	6.2
K-SW0-0848	138	8	48	0	0.14	6.6
K-SW0-0851	145	8	51	0	0.14	7
K-SW0-0854	149	8	54	0	0.16	7.4
K-SW0-0857	156	8	57	0	0.16	7.8
K-SW0-0860	162	8	60	0	0.18	8.2
K-SW0-0863	167	8	63	0	0.18	8.6
K-SW0-0866	176	8	66	0	0.2	9
K-SW0-0869	180	8	69	0	0.2	9.4

continued on next page

whiteboard screens 2 of 4 continued

Code	Price	H	W	D	Volume (ft³)	Weight (lb.)
K-SW0-0872	183	8	72	0	0.22	9.8
K-SW0-1218	95	12	18	0	0.06	3.6
K-SW0-1221	101	12	21	0	0.09	4.2
K-SW0-1224	108	12	24	0	0.09	4.8
K-SW0-1227	117	12	27	0	0.09	5.4
K-SW0-1230	124	12	30	0	0.12	6
K-SW0-1233	132	12	33	0	0.12	6.9
K-SW0-1236	136	12	36	0	0.15	7.5
K-SW0-1239	145	12	39	0	0.15	8.1
K-SW0-1242	153	12	42	0	0.18	8.7
K-SW0-1245	161	12	45	0	0.18	9.3
K-SW0-1248	169	12	48	0	0.21	9.9
K-SW0-1251	179	12	51	0	0.21	10.5
K-SW0-1254	183	12	54	0	0.24	11.1
K-SW0-1257	193	12	57	0	0.24	11.7
K-SW0-1260	200	12	60	0	0.27	12.3
K-SW0-1263	207	12	63	0	0.27	12.9
K-SW0-1266	218	12	66	0	0.3	13.5
K-SW0-1269	226	12	69	0	0.3	14.1
K-SW0-1272	233	12	72	0	0.33	14.7
K-SW0-1618	103	16	18	0	0.08	4.8
K-SW0-1621	112	16	21	0	0.12	5.6
K-SW0-1624	124	16	24	0	0.12	6.4
K-SW0-1627	132	16	27	0	0.12	7.2
K-SW0-1630	143	16	30	0	0.16	8
K-SW0-1633	150	16	33	0	0.16	9.2
K-SW0-1636	161	16	36	0	0.2	10
K-SW0-1639	169	16	39	0	0.2	10.8
K-SW0-1642	180	16	42	0	0.24	11.6
K-SW0-1645	189	16	45	0	0.24	12.4
K-SW0-1648	200	16	48	0	0.28	13.2
K-SW0-1651	210	16	51	0	0.28	14

whiteboard screens3 of 4 continued

Code	Price	H	W	D	Volume (ft³)	Weight (lb.)
K-SW0-1654	219	16	54	0	0.32	14.8
K-SW0-1657	229	16	57	0	0.32	15.6
K-SW0-1660	243	16	60	0	0.36	16.4
K-SW0-1663	252	16	63	0	0.36	17.2
K-SW0-1666	259	16	66	0	0.4	18
K-SW0-1669	273	16	69	0	0.4	18.8
K-SW0-1672	283	16	72	0	0.44	19.6
K-SW0-2018	112	20	18	0	0.1	6
K-SW0-2021	128	20	21	0	0.15	7
K-SW0-2024	134	20	24	0	0.15	8
K-SW0-2027	145	20	27	0	0.15	9
K-SW0-2030	157	20	30	0	0.2	10
K-SW0-2033	174	20	33	0	0.2	11.5
K-SW0-2036	183	20	36	0	0.25	12.5
K-SW0-2039	195	20	39	0	0.25	13.5
K-SW0-2042	206	20	42	0	0.3	14.5
K-SW0-2045	219	20	45	0	0.3	15.5
K-SW0-2048	229	20	48	0	0.35	16.5
K-SW0-2051	246	20	51	0	0.35	17.5
K-SW0-2054	254	20	54	0	0.4	18.5
K-SW0-2057	267	20	57	0	0.4	19.5
K-SW0-2060	282	20	60	0	0.45	20.5
K-SW0-2063	290	20	63	0	0.45	21.5
K-SW0-2066	307	20	66	0	0.5	22.5
K-SW0-2069	321	20	69	0	0.5	23.5
K-SW0-2072	331	20	72	0	0.55	24.5
K-SW0-2418	124	24	18	0	0.12	7.2
K-SW0-2421	134	24	21	0	0.18	8.4
K-SW0-2424	149	24	24	0	0.18	9.6
K-SW0-2427	162	24	27	0	0.18	10.8
K-SW0-2430	179	24	30	0	0.24	12
K-SW0-2433	193	24	33	0	0.24	13.8

whiteboard screens 4 of 4 continued

Code	Price	H	W	D	Volume (ft³)	Weight (lb.)
K-SW0-2436	205	24	36	0	0.3	15
K-SW0-2439	219	24	39	0	0.3	16.2
K-SW0-2442	238	24	42	0	0.36	17.4
K-SW0-2445	250	24	45	0	0.36	18.6
K-SW0-2448	259	24	48	0	0.42	19.8
K-SW0-2451	277	24	51	0	0.42	21
K-SW0-2454	289	24	54	0	0.48	22.2
K-SW0-2457	307	24	57	0	0.48	23.4
K-SW0-2460	322	24	60	0	0.54	24.6
K-SW0-2463	337	24	63	0	0.54	25.8
K-SW0-2466	350	24	66	0	0.6	27
K-SW0-2469	363	24	69	0	0.6	28.2
K-SW0-2472	382	24	72	0	0.66	29.4
K-SW0-3218	143	32	18	0	0.16	9.6
K-SW0-3221	157	32	21	0	0.24	11.2
K-SW0-3224	177	32	24	0	0.24	12.8
K-SW0-3227	197	32	27	0	0.24	14.4
K-SW0-3230	212	32	30	0	0.32	16
K-SW0-3233	233	32	33	0	0.32	18.4
K-SW0-3236	252	32	36	0	0.4	20
K-SW0-3239	271	32	39	0	0.4	21.6
K-SW0-3242	288	32	42	0	0.48	23.2
K-SW0-3245	309	32	45	0	0.48	24.8
K-SW0-3248	326	32	48	0	0.56	26.4
K-SW0-3251	345	32	51	0	0.56	28
K-SW0-3254	361	32	54	0	0.64	29.6
K-SW0-3257	383	32	57	0	0.64	31.2
K-SW0-3260	400	32	60	0	0.72	32.8
K-SW0-3263	421	32	63	0	0.72	34.4
K-SW0-3266	437	32	66	0	0.8	36
K-SW0-3269	458	32	69	0	0.8	37.6
K-SW0-3272	476	32	72	0	0.88	39.2

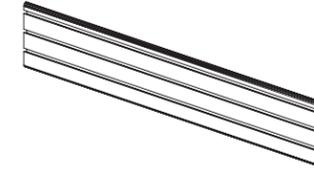

Ordering Options:

Use the following checklist to customize the finishes on your order:

- Metal color

Details:

1. Specify screen width to match surface width.
2. Surfaces 78 inches and wider require 2 screens and filler.

Code	Price	H	W	D	Volume (ft³)	Weight (lb.)
K-SA0-0818	94	8	18	0	0.05	1.3
K-SA0-0821	103	8	21	0	0.06	1.7
K-SA0-0824	110	8	24	0	0.07	1.96
K-SA0-0827	121	8	27	0	0.08	2.3
K-SA0-0830	131	8	30	0	0.09	2.45
K-SA0-0833	143	8	33	0	0.1	2.7
K-SA0-0836	149	8	36	0	0.1	2.94
K-SA0-0839	160	8	39	0	0.11	3.3
K-SA0-0842	169	8	42	0	0.12	3.43
K-SA0-0845	180	8	45	0	0.13	3.6
K-SA0-0848	191	8	48	0	0.14	3.92
K-SA0-0851	200	8	51	0	0.15	4.2
K-SA0-0854	207	8	54	0	0.16	4.41
K-SA0-0857	218	8	57	0	0.17	4.7
K-SA0-0860	229	8	60	0	0.18	4.9
K-SA0-0863	238	8	63	0	0.19	5.1
K-SA0-0866	249	8	66	0	2	5.4
K-SA0-0869	259	8	69	0	2.1	5.7
K-SA0-0872	268	8	72	0	2.2	6



Metro Collab  
July 2023  
**Counter Tops**

counter tops

<u>glass</u>	192
<u>laminate 1.5 inch</u>	193
<u>boat laminate 1 inch</u>	194
<u>straight laminate 1 inch</u>	195

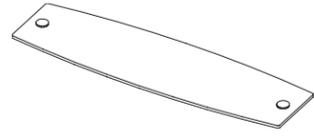

Glass, 3/8 inch

**Ordering Options:**

**Details:**

1. Tempered glass counter tops.
2. Counter tops 54 inches and wider are supported with 4 small posts.
3. Counter tops 48 inches and smaller supported by 2 small posts.

Code	Price	H	W	D	Volume (ft <sup>3</sup> )	Weight (lb)
K-WTG-1221	553	0.37	21	12	0.2	15
K-WTG-1224	668	0.37	24	12	0.2	18
K-WTG-1230	726	0.37	30	12	0.3	21
K-WTG-1236	782	0.37	36	12	0.3	24
K-WTG-1242	836	0.37	42	12	0.4	30
K-WTG-1248	893	0.37	48	12	0.4	30
K-WTG-1254	1038	0.37	54	12	0.5	33
K-WTG-1260	1092	0.37	60	12	0.5	36
K-WTG-1266	1150	0.37	66	12	0.6	39
K-WTG-1272	1207	0.37	72	12	0.6	42

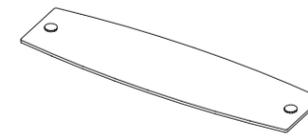

Laminate 1.5 inch

**Ordering Options:**

Use the following checklist to customize the finishes on your order:

- laminate color
- trim profile, 1.5 inches
- metal color

**Details:**

1. Laminate counter tops.
2. Counter tops 54 inches and wider are supported with 4 small posts.
3. Counter tops 48 inches and smaller supported by 2 small posts.

Code	Price	H	W	D	Volume (ft <sup>3</sup> )	Weight (lb)
K-WTL-1221	276	1.5	21	12	0.2	12
K-WTL-1224	282	1.5	24	12	0.2	14
K-WTL-1230	300	1.5	30	12	0.3	17
K-WTL-1236	316	1.5	36	12	0.3	20
K-WTL-1242	333	1.5	42	12	0.4	23
K-WTL-1248	349	1.5	48	12	0.4	26
K-WTL-1254	364	1.5	54	12	0.5	29
K-WTL-1260	382	1.5	60	12	0.5	33
K-WTL-1266	399	1.5	66	12	0.6	36
K-WTL-1272	415	1.5	72	12	0.6	39

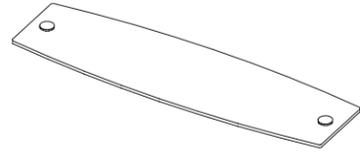

Boat, 1 inch

**Ordering Options:**

Use the following checklist to customize the finishes on your order:

- laminate color
- trim profile 1 inch
- metal color

**Details:**

1. Laminate counter tops.
2. Counter tops 54 inches and wider are supported with 4 small posts.
3. Counter tops 48 inches and smaller supported by 2 small posts.

Code	Price	H	W	D	Volume (ft <sup>3</sup> )	Weight (lb)
KL-WTL-1221	264	1	21	12	0.2	8
KL-WTL-1224	270	1	24	12	0.2	9
KL-WTL-1230	281	1	30	12	0.3	11
KL-WTL-1236	298	1	36	12	0.3	13
KL-WTL-1242	309	1	42	12	0.4	15
KL-WTL-1248	321	1	48	12	0.4	17
KL-WTL-1254	334	1	54	12	0.5	19
KL-WTL-1260	347	1	60	12	0.5	22
KL-WTL-1266	361	1	66	12	0.6	24
KL-WTL-1272	375	1.5	72	12	0.6	26

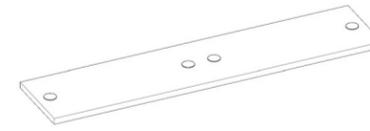

Straight 1 inch

**Ordering Options:**

Use the following checklist to customize the finishes on your order:

- laminate color
- trim profile, 1 inch
- metal color

**Details:**

1. Laminate counter tops.
2. Counter tops 54 inches and wider are supported with 4 small posts.
3. Counter tops 48 inches and smaller supported by 2 small posts.

Code	Price	H	W	D	Volume (ft <sup>3</sup> )	Weight (lb)
KL-WTLS-1221	265	1.5	21	12	0	3.6
KL-WTLS-1224	270	1.5	24	12	0	4.1
KL-WTLS-1230	281	1.5	30	12	0	4.5
KL-WTLS-1236	298	1.5	36	12	0	4.9
KL-WTLS-1242	309	1.5	42	12	0	5.3
KL-WTLS-1245	317	1.5	45	12	0	5.5
KL-WTLS-1248	323	1.5	48	12	0	5.7
KL-WTLS-1254	334	1.5	54	12	0	6.1
KL-WTLS-1260	348	1.5	60	12	0	6.5
KL-WTLS-1266	361	1.5	66	12	0	6.9
KL-WTLS-1272	377	1.5	72	12	0	7.3



Metro Collab  
July 2023  
**Wire  
Management**

wire management

<u>vertical wire manager</u>	198
<u>horizontal wire manager</u>	199
<u>wire clip</u>	200



**Ordering Options:**

There are no ordering options for these items

Code	Price	H	W	D	Volume (ft <sup>3</sup> )	Weight (lb)
V-EE00	300	28	4	4	0.25	1

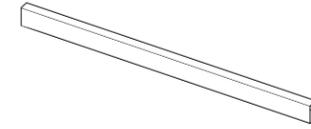

**Ordering Options:**

There are no ordering options for these items

Code	Price	H	W	D	Volume (ft <sup>3</sup> )	Weight (lb)
V-EWHB-12	8	0	12	0	0.25	0.15
V-EWHB-24	15	0	24	0	0.25	0.35
V-EWHB-36	22	0	36	0	0.25	0.55

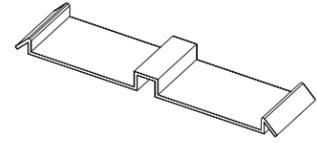

**Ordering Options:**

There are no ordering options for these items

Code	Price	H	W	D	Volume (ft <sup>3</sup> )	Weight (lb)
V-EE00	300	28	4	4	0.25	1



Metro Collab  
July 2023  
**Accessories**

accessories

<u>keyboard tray</u>	204
<u>work organizer</u>	205
<u>monitor arm</u>	206
<u>task light</u>	207

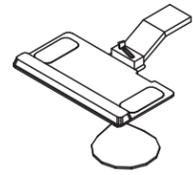

Articulating Keyboard Tray w/Mouse Tray

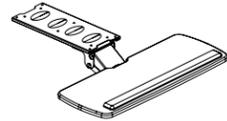

Articulating Keyboard Tray

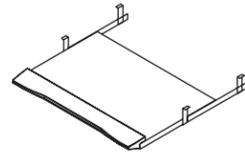

Retractable Laminate Keyboard Tray

**What's Included:**

Keyboard Tray, installation hardware.

**How to Specify:**

Specify laminate color for retractable keyboard. The vinyl trim color will default to match the laminate color unless otherwise specified. See the laminate finish card for details.

For articulating keyboard with mouse, right or left hand must be specified.

The articulating keyboards are available only in black.

**Notes:**

Keyboard trays provide adjustable ergonomic support for individuals in multi-task environments

**Options:**

Finish: laminate colors (retractable keyboard only)

Hand: **R** right **L** left (for adjustable keyboard with mouse only)

Code	Price	H	W	D	Volume (ft <sup>3</sup> )	Weight (lb)
Articulating Keyboard Tray w/Mouse Tray						
V-KAS0-2011-L	593	0	20	11	0	3
V-KAS0-2011-R	593	0	20	11	0	3
Articulating Keyboard Tray						
V-KASX-2510	380	0	25	10	0	15
Retractable Laminate Keyboard Tray						
V-KRS0-2516	249	0	25	16	0	12

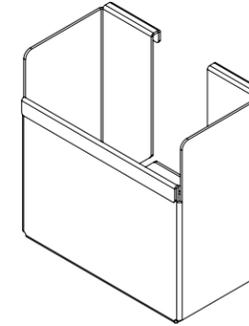

pencil holder

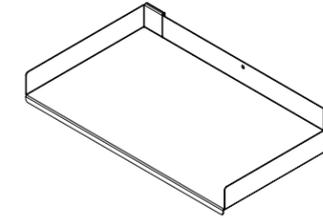

paper tray - legal

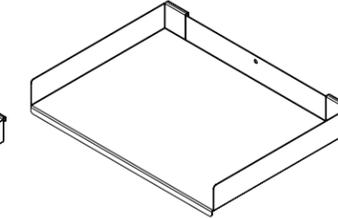

paper tray - letter

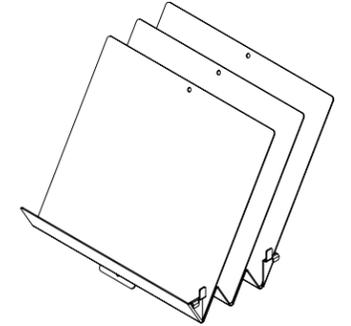

document sorter

**Ordering Options:**

Use the following checklist to customize the finishes on your order:

- metal color

**Details:**

Work organizers facilitate paper management and storage and easily hang on to accessory screens.

Code	Price	H	W	D	Weight (lb.)	Volume (ft <sup>3</sup> )
pencil holder						
F-AAH	77	0	0	0	0.1	0.7
paper tray - legal						
F-AAP-13	96	0	15	10	3.2	0.1
paper tray - letter						
F-AAP-9	85	0	12	10	3.2	0.1
document sorter						
F-AAS	171	0	0	0	2.5	0.1

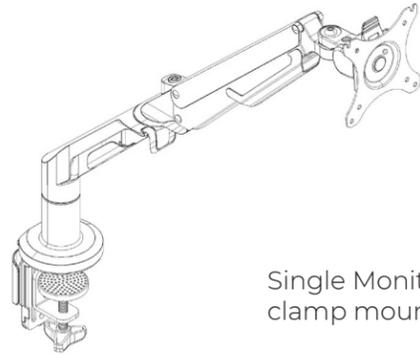

Single Monitor Arm - clamp mount

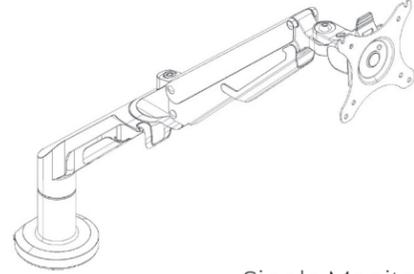

Single Monitor Arm - grommet mount

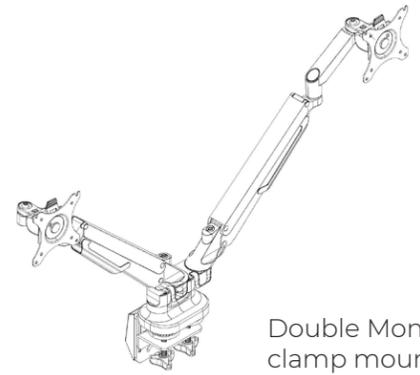

Double Monitor Arm - clamp mount

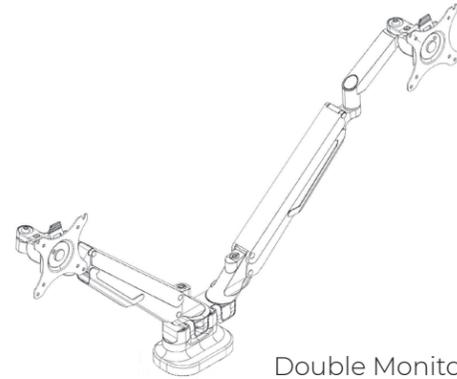

Double Monitor Arm - grommet mount

**What's Included:**

One monitor arm and installation hardware for both clamp and grommet mount

**How to Specify:**

- Specify type

**Dimensions:**

Vesa: 75x75 and 100x100

**Notes:**

Available in silver and black

Single Monitor Arm

- Screen Size - 17"-36"
- Load Capacity - 6.6-26.4lbs/3-12kg
- Tilt Range - -90 degrees - -15 degrees

Dual Monitor Arm

- Screen Size - 17"-32"
- Load Capacity - 4.4-19.8lbs/2-9kg
- Tilt Range - -90 degrees - -15 degrees

Code	Price
Monitor Arm - Single Mount	
V-AFMA-01	353
Monitor Arm - Double Mount	
V-AFMA-02	589



**Ordering Options:**

Use the following checklist to customize the finishes on your order:

- task light is finished in silver only

**Details:**

1. The task light is facilitated with magnets made of high quality materials to provide easy handling for users within the workstation
2. 160° swiveling lamps allows the user to position the light where it is needed
3. the task light is equipped with a fluorescent T5 tube and electronic ballast to reduce energy consumption

Code	Price	H	W	D	Volume (ft <sup>3</sup> )	Weight (lb)
V-ELU-24	285	0	24.53	0	0	9.5
V-ELU-36	321	0	36.39	0	0	13.7
V-ELU-48	403	0	48.15	0	0	17.9