

tayco[®]



Union Quick Ship Pricebook January 2026

Contents

Caution	5
Overview	6
Statement of Line	9
Step-by-step order placement	17
Finishes	18
Trims - Metal	18
Laminates - Solid	18
Laminates - Woodgrain	19
Desks	20
straight	22
full modesty	22
partial modesty	24
full recessed modesty	26
arc	27
full recessed modesty	27
Tables	28
D-table	30
J-table	31
P-table	32
F-table	33
U-table	34
C-table	35
Corners	36
straight front corner	38
full modesty /w gable	38
partial modesty no gable	39
partial modesty /w gable	40
curved front corner	41
full modesty /w gable	41
full modesty no gable	42
partial modesty /w gable	43

Unitized Desks	44
curved front	46
w/full modesties /w gables	46
w/full modesties / no gables	47
w/partial modesties /w gables	48
Bridges	50
straight bridge	52
/w full modesty	52
/w partial modesty	53
Returns	54
straight return	56
full modesty	56
partial modesty	58
Credenzas	60
top	62
double lateral file	63
double storage cabinet	64
Supports	66
intermediate support	68
cantilever	69
Filing & Storage	70
pedestals	72
underdesk combo pedestal BBF & FF	73
underdesk storage cabinet	74
underdesk 2-drawer lateral file	75
freestanding 2-drawer lateral file	76
freestanding 3-drawer lateral file	77
freestanding storage cabinet	78
freestanding storage tower- single door	79
storage cabinet w/coat bar and shelves	80
freestanding combo lateral storage double door	81
bookcase	82

Conference Tabletops	84
<u>straight tabletop</u>	86
<u>straight tabletop w/power and data</u>	88
<u>boat-shaped tabletop</u>	90
<u>boat-shaped tabletop w/power and data</u>	92
<u>racetrack tabletop</u>	94
<u>racetrack tabletop w/power and data</u>	96
Overhead Storage	98
<u>hinged door hutch</u>	100
<u>wall mounted hinged door hutch</u>	101
Bases	102
<u>gable & modesty base</u>	104
<u>for straight tabletop</u>	104
<u>for racetrack top</u>	106
<u>elliptical base</u>	108
<u>for straight tabletop</u>	108
<u>for racetrack top</u>	110
Accessories	112
<u>keyboard tray</u>	114
<u>PET tackboard for hutch</u>	115
<u>pencil drawer</u>	116
<u>task light</u>	117
<u>monitor arm</u>	118
<u>ellora grommet add-ons</u>	119

Load Bottom Drawer First

- Operate one drawer at a time
- Units may tip if loaded incorrectly
- Units should be attached to a wall or other furniture to reduce tipping hazard
- Always load the heaviest files in the bottom drawer

Heavy Load

- Some products must be anchored to wall to ensure stability & safety.
- It is the owner and installers responsibility to ensure that the wall type and construction is of sufficient strength to carry the loads of any wall mounted products and their contents.
- Failure of the wall and anchors to support all imposed loads may result in property damage and/or personal injury.
- Tayco can provide size and empty weight of its products only. As wall blocking is considered a building construction process, Tayco cannot provide recommendations in this respect and cannot be responsible for damage or injury that may occur as a result of improper installation and/or blocking.

Instability Hazard

Mobile items on casters such as flip top, personal and movable tables of any type and storage items of any type may present an instability hazard if not secured correctly while in use or in storage. Flip top tables or training tables of any type, are inherently more unstable when folded. Tayco provides the following guidelines & warnings when using mobile products:

- Lock casters immediately after moving. Do not leave the casters unlocked when in use or in storage.
- Motion may increase the instability of any item with casters. If the wheels hit an obstruction the table's forward momentum often causes overturn, especially if the item is not equipped with wheel extensions. Exercise strong caution while moving these items.
- Use caution when abrupt level changes in the floor are present (such as a doorway or room threshold) as caster failure or tipping may result.
- Do not stand, sit or lean on mobile items for support. They are not intended for this use and personal injury or property damage may result.
- Mobile units that feature height adjustable elements must be lowered to the minimum compressed height when moving to prevent instability. It is also recommended the user remove all computer equipment or other accessories to prevent possible weight imbalance or damage to equipment.
- Failure to follow the guidelines above may result in property damage or personal injury.

Overview

Tayco introduces Union Quick Ship, a full line of case goods and conference furniture.

Union is divided into three distinct product groups for ease of specifying: Executive, Professional and Conference. The prefix of the product code indicates the product group.

QML 1" – Union Quick Ship Professional
QMB 1.5" – Union Quick Ship Conference

Tayco's Quick Ship Program offers a selection of furniture systems and ergonomic accessories with a 10-day lead time. This program includes flexible panel systems designed for various work environments, casegoods suitable for private offices and meeting spaces, and ergonomic accessories such as monitor arms and power solutions.

The Union Quick Ship line provides casegoods for workspaces, featuring desks and storage. This program offers a modern design with durable construction. Each piece is made with 1" thick thermally fused melamine worksurfaces, desk-height storage cabinet tops and 3/4" thick tops.

desks, returns, bridges and credenzas

Desks are available with a choice of recessed or flush modesties. Union desks, end gables and modesties are made with 45 lb./cubic foot density industrial-grade composite wood core, finished on both sides. Many pieces are available with partial or full modesties. Partial modesties (10"H) should be ordered only for pieces located next to a wall. Otherwise, full modesties should be used.

pedestals

All pedestal drawers are outfitted with full extension slides. Drawers can be easily removed by releasing the small catches on either side of the slide. Pedestals come standard with locks. One lock will lock all drawers. File drawers will accommodate legal or letter-size documents.

freestanding storage and combo cabinets

Various combination filing and storage units provide a place to hang a coat, store personal items and documents to suit any individual's needs.

bookcases

Bookcases have height-adjustable shelves with the exception of any desk-height shelves. They are fixed to add structural stability to the bookcase.

intermediate gable supports

Some configurations require the use of an intermediate gable support. This support must be ordered separately. The situations requiring an intermediate gable support are:

- For use under surfaces 60" wide or greater where there is no filing or storage to support the worksurface (see picture 1). The intermediate support is necessary if a hutch is placed over a bridge or return surface (see picture 2).

surfaces 60" wide or greater

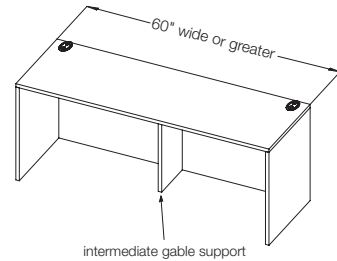

picture 1

under surfaces with a hutch

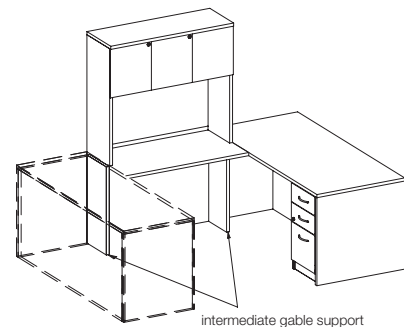

picture 2

- Under return surfaces where the return meets the primary desk or Peninsula table.
- The 12" wide intermediary gable is for 21" and 24"-deep surfaces and the 18"-wide intermediate gable is used with 30"- and 36"-deep worksurfaces. (see Picture 3)

universal gable support

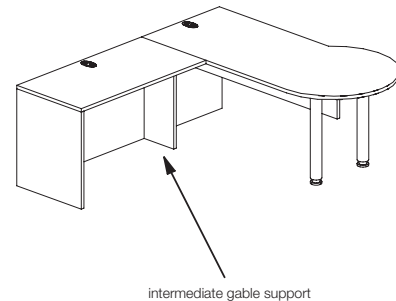

picture 3

hutches and cabinets

Hutches and cabinet doors come in classic laminate. Hutches with laminate doors always come standard with locking doors.

accessories

Computer accessories include flat-screen monitor arms, and articulating keyboard trays.

Heavy-duty flat-screen monitor arms adjust to the user while storing wires within the arm. The monitor mounting plate meets VESA standards to accommodate most monitors. Monitor arms can be grommet- or clamp-mounted to the worksurface. Articulating keyboard trays complete the workstation.

Hutch-mounted tackboards can be finished in any Tayco standard PET to match the office decor.

Standard LED task lights are available in two sizes.

handle details

Six handle options are available in choice of colors.

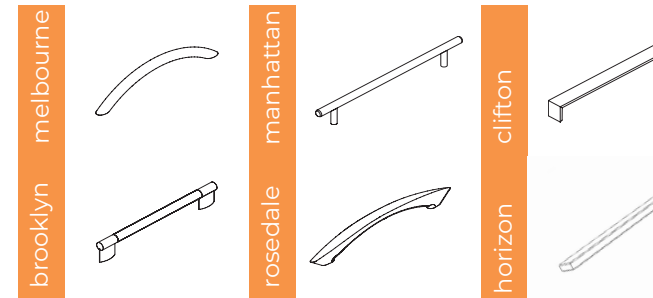

default vinyl color selections

Each laminate comes with matching vinyl trim color unless otherwise specified on your purchase order. Refer to the laminate finishes [on page 19](#) for details.

filing options

Pedestal file drawers can accommodate letter- or legal-size documents. Letter-size papers can be filed either front to back or side to side. Lateral drawers can accommodate front to back or side to side filing of legal- or letter-size documents.

Disclaimer: Please note that lateral file drawers are intended for filing letter and legal size paper front to back or side to side only. For details and weight restrictions please contact customer service.

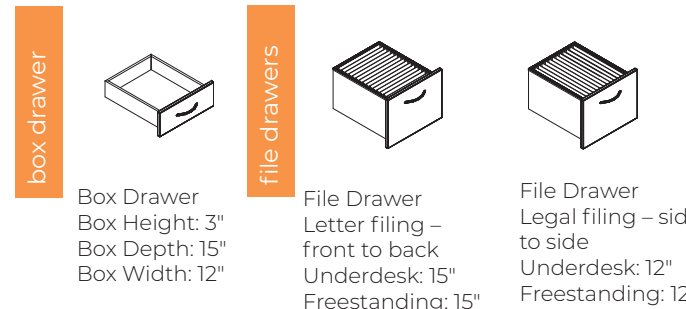

lateral file drawer

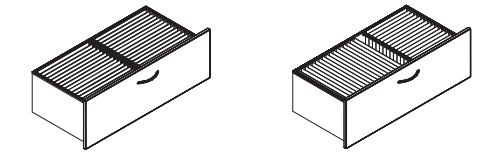

Lateral File Drawer (36W & 42W)
Legal filing – front to back
Underdesk: 15"
Freestanding: 15"

Lateral File Drawer (36W & 42W)
Legal filing – side to side
Letter filing – front to back
Underdesk: 15"
Freestanding: 15"

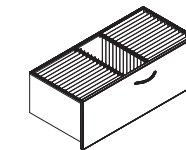

Lateral File Drawer (30W, 36W & 42W)
Letter filing – front to back
Underdesk: 15"
Freestanding: 15"

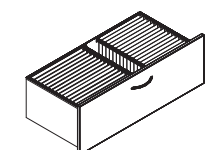

Lateral File Drawer (36W & 42W)
Letter & legal filing – front to back
Underdesk: 15"
Freestanding: 15"

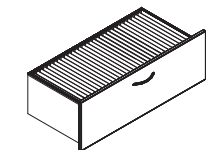

Lateral File Drawer (30W, 36W & 42W)
Legal filing – side to side
Underdesk: 30W-25½", 36W-31½", 42W-37½"
Freestanding: 30W-25½", 36W-31½", 42W-37½"

How to Order and Read your Code:

QM or QML **TSOG** **60** **21**
product line item width depth

grain direction

Horizontal Surfaces

When ordering a directional laminate, the grain will run the direction of the width of the worksurface (excluding bridge surfaces), hutch or storage top. Grain on bridge modesty runs vertically so the grain will run the same direction on the entire suite.

Vertical Surfaces

Directional laminates run vertically on vertical surfaces such as cabinet doors, pedestal drawer fronts and gables, as well as all cabinet, lateral file and pedestal kick-plates. The grain runs horizontally across the width of modesty panels.

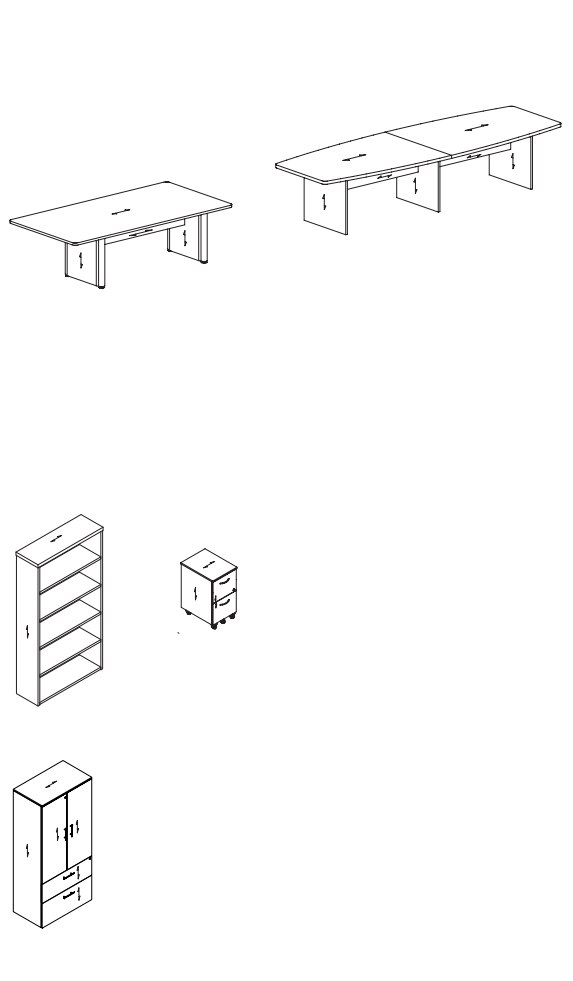
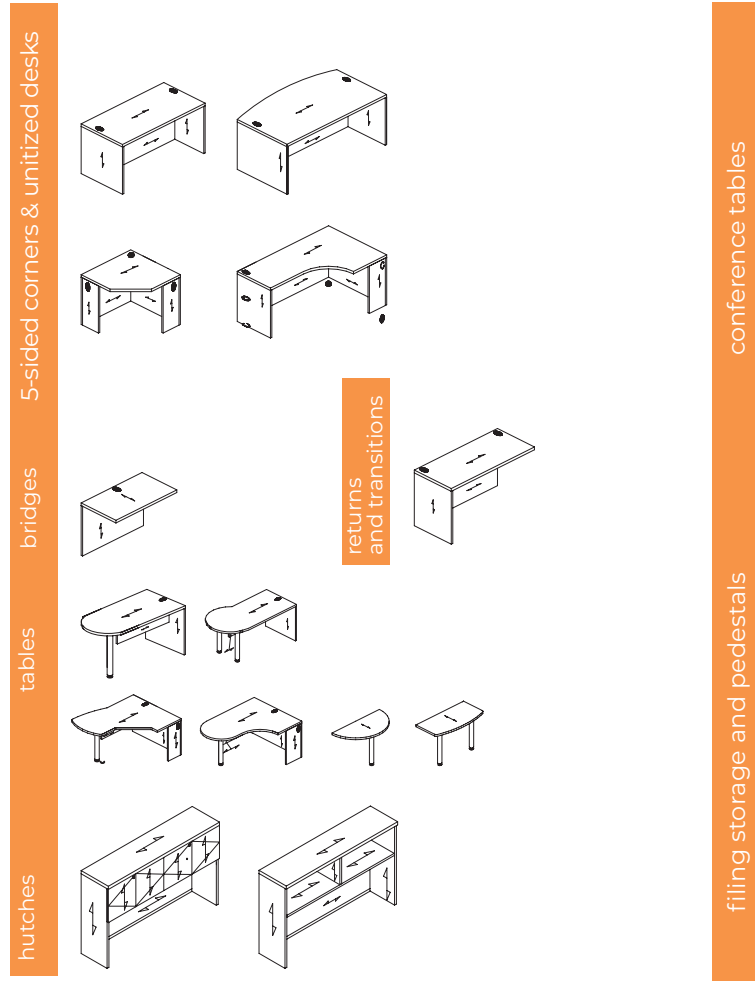

Note: Boardroom tables with tops comprised of 2 or more pieces will not have a consistent grain pattern.

grommets

Oval shaped grommets are available in black or silver and square shaped grommets are available in black, silver or white to coordinate with furniture.

Components Available With or Without Grommets

- ◆ Arc desks without pedestals
- ◆ Straight desks with recessed modesties

Components Without Grommets

- ◆ "U" and "C" Tables

Grommet Placement

Surfaces up to and including 48" wide have one grommet located at back center of the surface. Surfaces 54" wide and wider have two grommets at either side of the back of the surface.

Components Including Grommets

- ◆ Peninsula tables
- ◆ Arc desks with pedestals
- ◆ Straight desks with recessed modesties and pedestals
- ◆ Straight desks with flush modesties
- ◆ Returns
- ◆ Bridges
- ◆ 5-sided corner worksurfaces
- ◆ Unitized desks
- ◆ Reception units

Statement of Line

Desks

1" Thick Desks

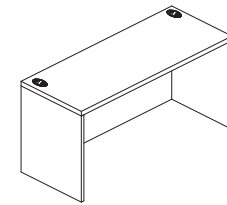

QML-TS0G
Straight w/ Full Modesty
W: 30" - 96"
D: 21" - 30"
H: 29.5"

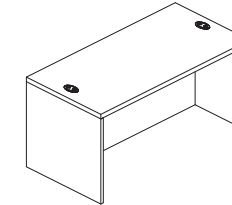

QML-TSRG
Straight w/ Full Recessed Modesty
W: 60" - 96"
D: 30" - 36"
H: 29"

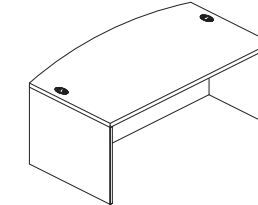

QML-TARG
Arc w/ Full Recessed Modesty
W: 72" - 96"
D: 36"
H: 29"

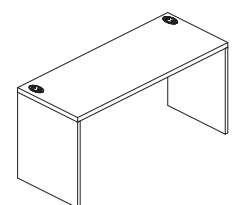

QML-TS0Z
Straight w/ Partial Modesty
W: 30" - 96"
D: 21" - 30"
H: 29.5"

Tables

1" Thick

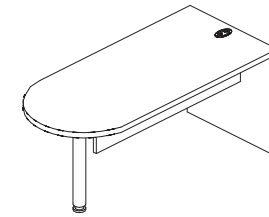

QML-TD0G
D-Table
W: 60" - 84"
D: 30"-36"
H: 29"

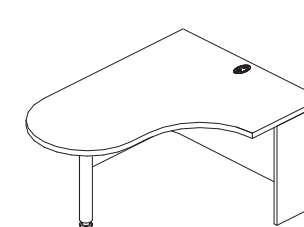

QML-TJ0G-L / QML-TJ0G-R
J-Table (Left Hand shown)
W: 60" - 84"
D: 24"
H: 29"

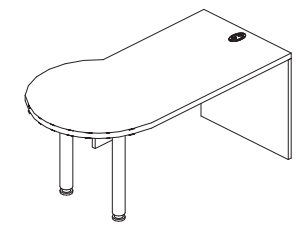

QML-TP0G-L / QML-TP0G-R
P-Table (Left Hand shown)
W: 60" - 84"
D: 30"
H: 29"

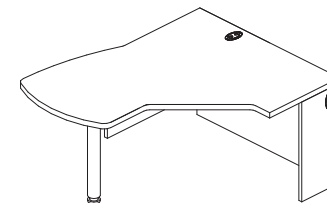

QML-TFSG-L / QML-TFSG-R
F-Table (Left Hand shown)
W: 60" - 84"
D: 24"
H: 29"

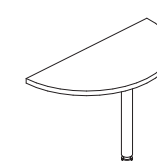

QML-TC00
C-Table
W: 42" - 60"
D: 21"-30"
H: 29"

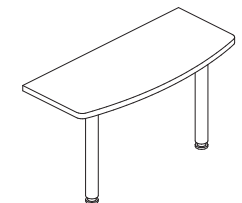

QML-WEU0
U-Table
W: 42" - 60"
D: 24"
H: 29"

Corners

1" Thick

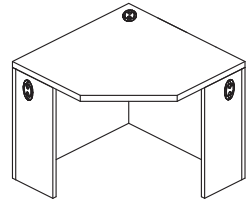

QML-W5S0
Straight Front
Full Modesty w/
Intermediate Gable
W: 36" - 42"
D: 21" - 24"
H: 29"

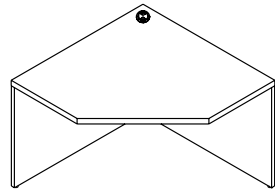

QML-W5S0-N
Straight Front
Full Modesty/ No Intermediate
Gable
W: 36" - 42"
D: 21" - 24"
H: 29"

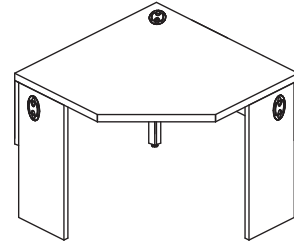

QML-W5S0-P
Straight Front
Partial Modesty w/ Intermediate
Gable
W: 36" - 42"
D: 21" - 24"
H: 29"

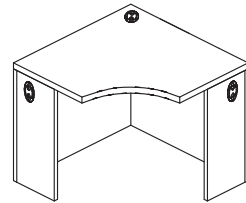

QML-W5C0
Curve Front
Full Modesty w/
Intermediate Gable
W: 36" - 42"
D: 21" - 24"
H: 29"

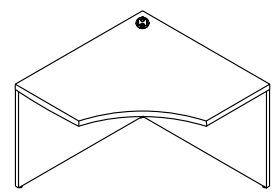

QML-W5C0-N
Curve Front
Full Modesty/ No Intermediate
Gable
W: 36" - 42"
D: 21" - 24"
H: 29"

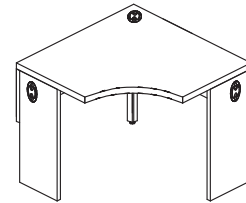

QML-W5C0-P
Curve Front
Partial Modesty w/ Intermediate
Gable
W: 36" - 42"
D: 21" - 24"
H: 29"

Unitized Desks

1" Thick

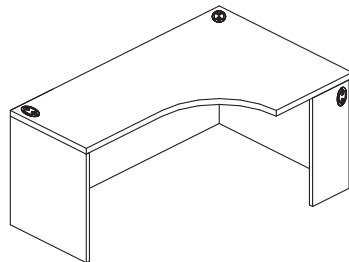

QML-UC4G-L / QML-UC4G-R
Unitized Desk (Left Hand
shown)
Full Modesty w/
Intermediate Gable
W: 66" - 72"
D: 39" - 42"
H: 29"

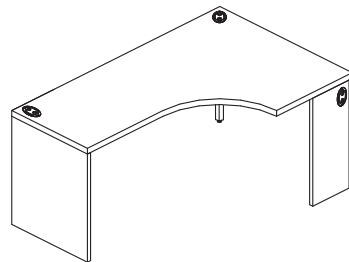

QML-UC4Z-L / QML-UC4G-R
Unitized Desk (Left Hand shown)
Partial Modesty w/ Intermediate
Gable
W: 66" - 72"
D: 39" - 42"
H: 29"

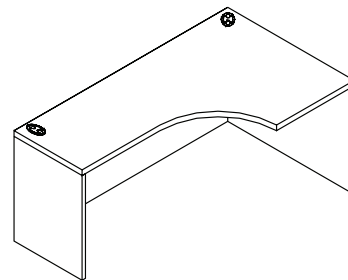

QML-UC4G-L-N / QML-UC4G-R-N
Unitized Desk - (Left Hand
shown)
Full Modesty/ No Intermediate
Gable
W: 66" - 72"
D: 39" - 42"
H: 29"

Bridges

1" Thick

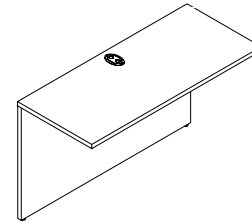

QML-BS0G
Straight w/ Full Modesty
W: 30" - 48"
D: 21" - 24"
H: 29"

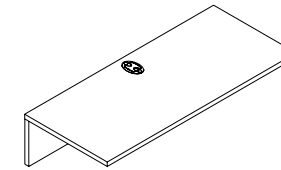

QML-BS0Z
Straight w/ Partial Modesty
W: 30" - 48"
D: 21" - 24"
H: 29"

Returns

1" Thick

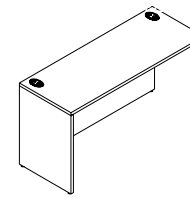

QML-WS1G-L / QML-
WS1G-R
Straight w/ Full Modesty
(Left Hand shown)
W: 24" - 60"
D: 21" - 30"
H: 29"

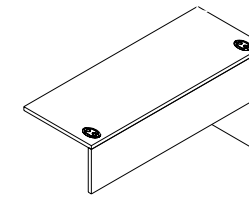

QML-WS1Z-L / QML-WS1Z-R
Straight w/ Partial Modesty
Left Hand shown)
W: 24" - 60"
D: 21" - 30"
H: 29"

Credenza Top

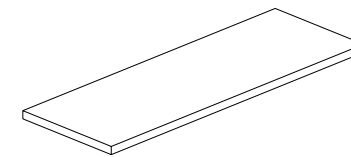

QML-WSS0
1" Thick Credenza Top
W: 60" - 84"
D: 21"

Credenzas
1" Thick

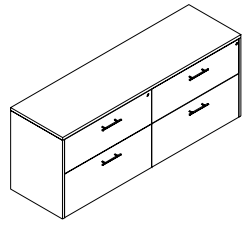

QML-CRLL
Credenza w/ Double Lateral
Files
W: 72"
D: 21" - 24"
H: 29"

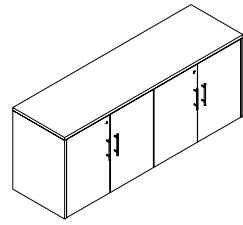

QML-CRSS
Credenza w/ Double Storage Files
W: 72"
D: 21" - 24"
H: 29"

Supports

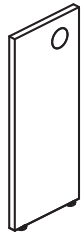

QM-CGU0
Intermediate Gable Support
W: 12" - 18"
D: 1"
H: 28"

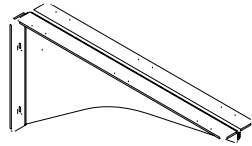

QM-CCAB
Center Cantilever Support
W: 16" - 22"

Pedestals

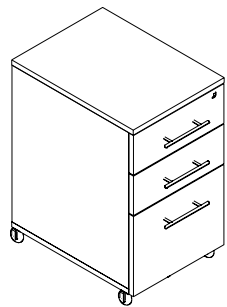

QM-FPBM
Mobile Box/Box/File
W: 16"
D: 21"
H: 28"

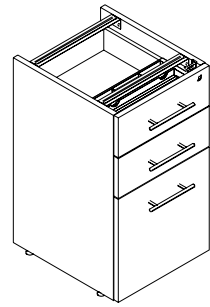

QM-FPBU
Underdesk Box/Box/File
W: 16"
D: 18" - 24"
H: 28"

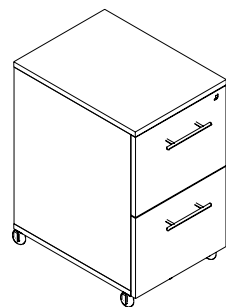

QM-FPFM
Mobile File/File
W: 16"
D: 21"
H: 28"

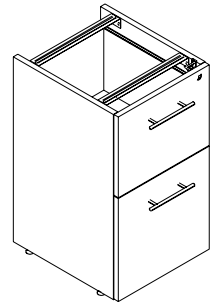

QM-FPFU
Underdesk File/File
W: 16"
D: 18" - 24"
H: 28"

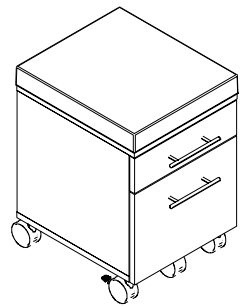

QM-1030
Pedestal w/ Seat Cushion |
Executive & Professional
W: 16"
D: 18"
H: 23"

Filing & Storage

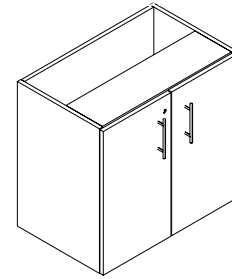

QM-FSU0
Underdesk Storage Cabinet
W: 30" - 42"
D: 19" - 21"
H: 28"

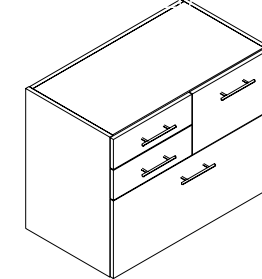

QM-FPJU-L / M-FPJU-R
Underdesk Combo Pedestal
w/Box/Box/File and File/File
LH/ RH (LH shown)
W: 36"
D: 20" - 21"
H: 28"

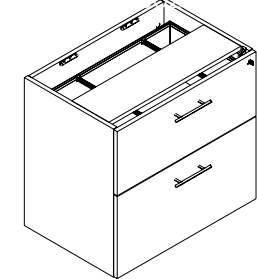

QM-FL2U
Underdesk 2-Drawer Lateral
File
W: 30" - 42"
D: 20" - 21"
H: 28"

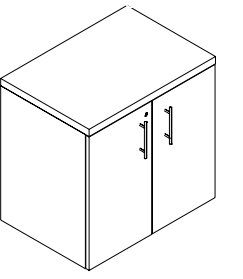

QM-FSF0
1" Freestanding Storage
Cabinet
W: 30" - 42"
D: 21"
H: 29"

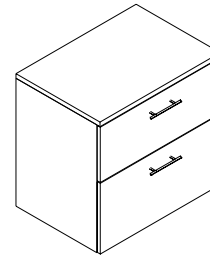

QML-FL2F
Freestanding 2-Drawer Lateral File
W: 30" - 42"
D: 21"
H: 29"

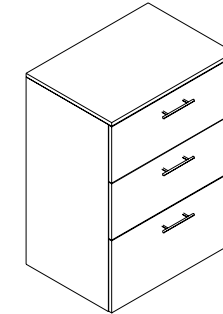

QML-FL3F
Freestanding 3-Drawer Lateral File
W: 30" - 36"
D: 21"
H: 40"

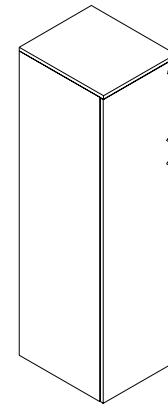

QML-FSDS
Freestanding Storage
Tower (Left Hand shown)
W: 36"
D: 21"
H: 67"

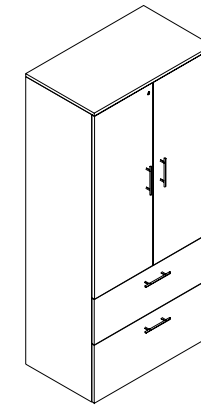

QML-FCSL
Combo Cabinet w/Storage
and Lateral File
W: 36"
D: 21"
H: 67"

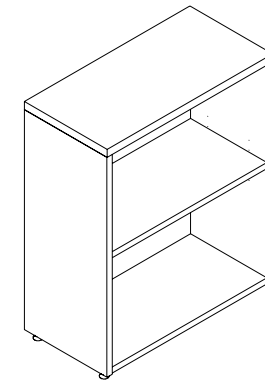

QML-SB0X
Bookcase
W: 24" - 42"
D: 12"/15"/21"
H: 29"/67"/77"

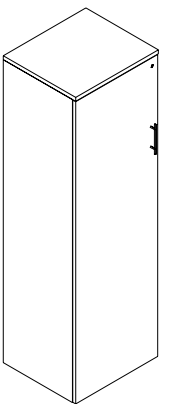

QML-FSDC-L / QML-FSDC-R
Storage Cabinet with Coat Bar
and Shelves
(Left Hand shown)
W: 24"
D: 21"
H: 67"

Overhead Storage

1" Thick

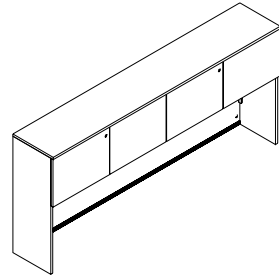

QML-SHHO
Hinged Door Hutch
W: 30" - 84"
D: 15"
H: 38"

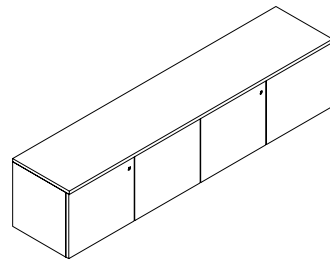

QML-SHHW-L
Wall Mounted Hinged Door
Hutch
W: 30" - 72"
D: 15"
H: 16.5"

Tabletops

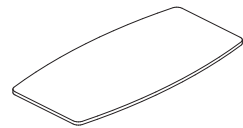

QMB-MBBX
Boat Shaped Tabletop
W: 72" - 240"
D: 36" - 60"

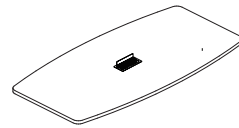

QMB-MBBP
Boat Shaped Tabletop w/
Power & Data
W: 72" - 240"
D: 36" - 60"

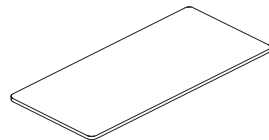

QMB-MSSX
Straight Tabletop
W: 72" - 240"
D: 36" - 60"

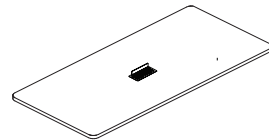

QMB-MSSP
Straight Tabletop w/
Power & Data
W: 72" - 240"
D: 36" - 60"

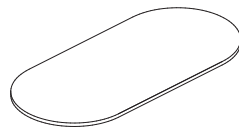

QMB-MRRX
Racetrack Tabletop
W: 72" - 240"
D: 36" - 60"

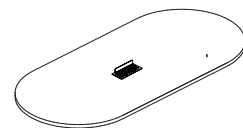

QMB-MRRP
Racetrack Tabletop w/
Power & Data
W: 72" - 240"
D: 36" - 60"

Bases

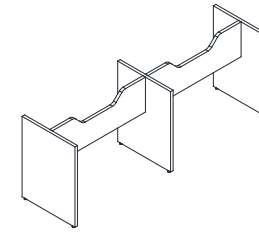

QMB-B4
Gable Base for Straight/Boat
Tabletop
W: 36" - 60"
D: 72" - 240"
H: 28"

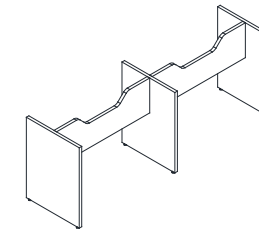

QMB-B4-R
Gable Base for Racetrack
Tabletop
W: 48" - 60"
D: 84" - 240"
H: 28"

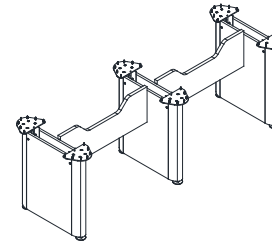

QMB-B5
Elliptical Base for Straight/
Boat Tabletop
W: 36" - 60"
D: 72" - 204"
H: 28"

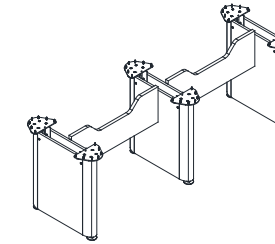

QMB-B5-R
Elliptical Base for Racetrack
Tabletop
W: 48" - 60"
D: 84" - 240"
H: 28"

Accessories

Keyboard

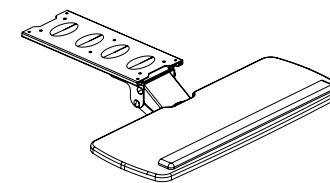

V-KASX
Articulating Keyboard
Tray
W: 25"
D: 10"

Tackboard for Hutch

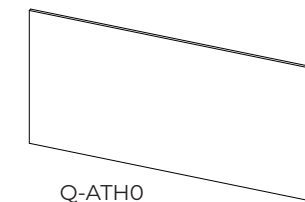

Q-ATHO
PET Tackboard
W: 27" - 81"
D: 0.5"
H: 21"

Pencil Drawer

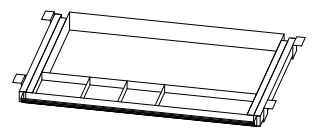

V-ADPP
Plastic Pencil Drawer
W: 21"
D: 16"
H: 2.8"

Tasklight

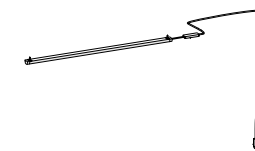

V-ELU
Task Light
W: 36" - 66"
72" - 84"

Accessories (Cont.)

Monitor Arm

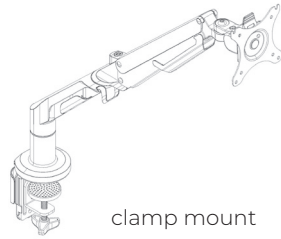

clamp mount

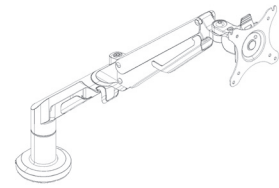

grommet mount

V-AFMA-01
Single Mount

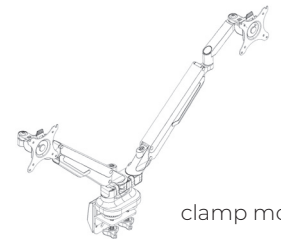

clamp mount



grommet mount

V-AFMA-02
Double Mount

Electrics



QM-RJ45



QM-HDMI

Step-by-step order placement

1. purchase order number
2. quantity
3. product codes and descriptions
4. finishes
5. options
6. provide a drawing or Tayco quotation number
7. shipping address, on-site contact name and phone number
8. shipping instructions
9. confirm access to elevators, loading dock, etc.
10. requested ship date/installation date
11. submit a completed Tayco installation checklist if Tayco is installing the furniture
12. discount, net price and freight charges
13. keep Tayco order numbers on file for reference when placing additional orders

Finishes

Trims - Metal

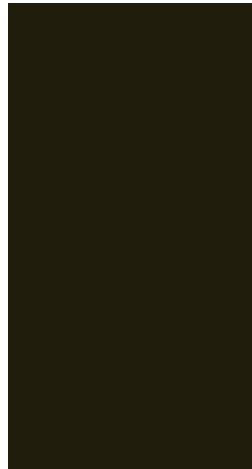

Black
P114

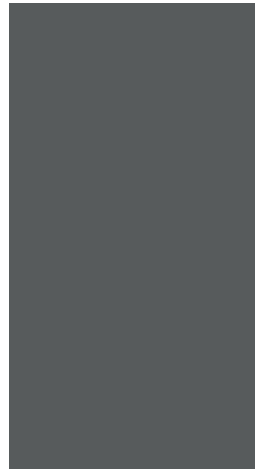

Charcoal
P139

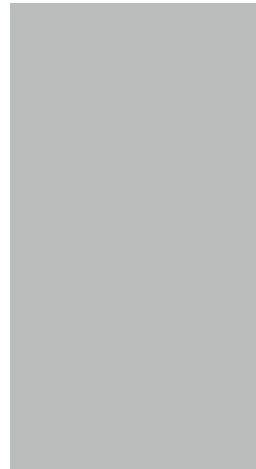

Silver
P112

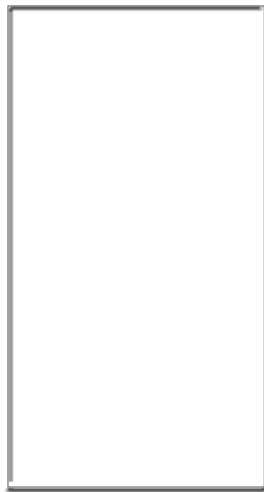

White
P121

Laminates - Solids

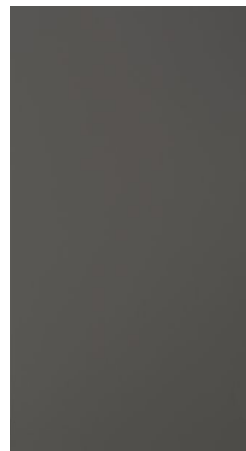

Moonlight*
L164/V164

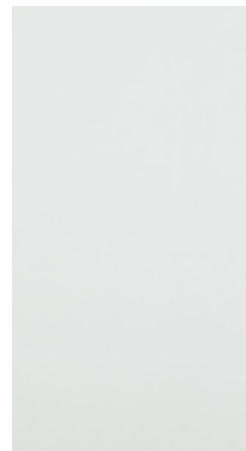

White
L121/V121

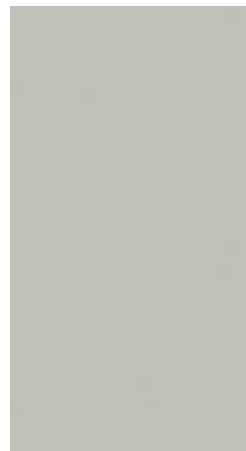

Summer Drops*
L154/V154

* not available in Conference

Laminates - Woodgrain



Copa_Cabana
L133/V133



Fogo Harbour
L165/V143



Megantic
L163/V163



Sable_Island
L161/V161



Tofino
L162/V162



Tuxedo
L132/V132



Union Quickship Pricebook
January 2026

Desks

straight

<u>straight</u>	22
<u>full modesty</u>	22
<u>partial modesty</u>	24
<u>full recessed modesty</u>	26
<u>arc</u>	27
<u>full recessed modesty</u>	27

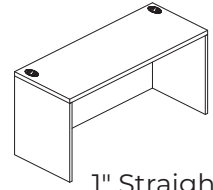

1" Straight Desk/Full Modesty

How to Specify:

Each laminate comes with matching vinyl trim color unless otherwise specified on your purchase order. Refer to the laminate finishes [on page 19](#) for details.

Notes:

Options:

laminate color

grommet color

Code	Price	H	W	D	Volume (ft ³)	Weight (lb)
QML-TS0G-3024	794	29	30	24	12.08	77.17
QML-TS0G-3030	838	29	30	30	15.1	84.2
QML-TS0G-3624	849	29	36	24	14.5	96.29
QML-TS0G-3630	903	29	36	30	18.13	95.73
QML-TS0G-4224	881	29	42	24	16.92	115.41
QML-TS0G-4230	955	29	42	30	21.15	107.26
QML-TS0G-4824	931	29	48	24	19.33	134.53
QML-TS0G-4830	1020	29	48	30	24.17	118.79
QML-TS0G-5424	983	29	54	24	21.75	153.65
QML-TS0G-5430	1089	29	54	30	27.19	130.32
QML-TS0G-6021	993	29	60	21	21.15	107.7
QML-TS0G-6024	1038	29	60	24	24.17	172.77
QML-TS0G-6030	1145	29	60	30	30.21	141.85
QML-TS0G-6621	1050	29	66	21	23.26	117.12
QML-TS0G-6624	1090	29	66	24	26.58	191.89
QML-TS0G-6630	1186	29	66	30	33.23	153.38
QML-TS0G-7221	1090	29	72	21	25.38	126.54
QML-TS0G-7224	1136	29	72	24	29	211.01
QML-TS0G-7230	1236	29	72	30	36.25	164.91
QML-TS0G-7821	1145	29	78	21	27.49	135.96
QML-TS0G-7824	1186	29	78	24	31.42	230.13
QML-TS0G-7830	1310	29	78	30	39.27	176.44
QML-TS0G-8421	1209	29	84	21	29.6	145.38
QML-TS0G-8424	1250	29	84	24	33.83	249.25
QML-TS0G-8430	1379	29	84	30	42.29	187.97
QML-TS0G-9021	1312	29	90	21	31.72	154.8
QML-TS0G-9024	1574	29	90	24	36.25	268.37
QML-TS0G-9030	1623	29	90	30	45.31	199.5
QML-TS0G-9621	1312	29	96	21	33.83	164.22
QML-TS0G-9624	1646	29	96	24	38.67	287.49
QML-TS0G-9630	1710	29	96	30	48.33	211.03

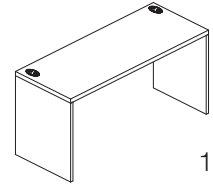

1" Straight Desk w/Partial Modesty

How to Specify:

Each laminate comes with matching vinyl trim color unless otherwise specified on your purchase order. Refer to the laminate finishes [on page 19](#) for details.

Notes:

Partial modesties are 10"H.

Options:

laminate color

grommet color

Code	Price	H	W	D	Volume (ft ³)	Weight (lb)
QML-TS0Z-3024	794	29	30	24	12.08	61.95
QML-TS0Z-3030	838	29	30	30	15.1	63.48
QML-TS0Z-3624	849	29	36	24	14.5	67.5
QML-TS0Z-3630	903	29	36	30	18.13	69.97
QML-TS0Z-4224	881	29	42	24	16.92	73.05
QML-TS0Z-4230	955	29	42	30	21.15	76.46
QML-TS0Z-4824	931	29	48	24	19.33	78.6
QML-TS0Z-4830	1020	29	48	30	24.17	82.95
QML-TS0Z-5424	983	29	54	24	21.75	84.15
QML-TS0Z-5430	1089	29	54	30	27.19	89.44
QML-TS0Z-6021	993	29	60	21	21.15	81.41
QML-TS0Z-6024	1038	29	60	24	24.17	89.7
QML-TS0Z-6030	1145	29	60	30	30.21	95.93
QML-TS0Z-6621	1050	29	66	21	23.26	86.6
QML-TS0Z-6624	1090	29	66	24	26.58	95.25
QML-TS0Z-6630	1186	29	66	30	33.23	102.42
QML-TS0Z-7221	1090	29	72	21	25.38	91.79
QML-TS0Z-7224	1136	29	72	24	29	100.8
QML-TS0Z-7230	1236	29	72	30	36.25	108.91
QML-TS0Z-7821	1145	29	78	21	27.49	96.98
QML-TS0Z-7824	1186	29	78	24	31.42	106.35
QML-TS0Z-7830	1310	29	78	30	39.27	115.4
QML-TS0Z-8421	1209	29	84	21	29.6	102.17
QML-TS0Z-8424	1250	29	84	24	33.83	111.9
QML-TS0Z-8430	1379	29	84	30	42.29	121.89
QML-TS0Z-9021	1312	29	90	21	31.72	107.36
QML-TS0Z-9024	1574	29	90	24	36.25	117.45
QML-TS0Z-9030	1597	29	90	30	45.31	128.38
QML-TS0Z-9621	1408	29	96	21	33.83	112.55
QML-TS0Z-9624	1646	29	96	24	38.67	123
QML-TS0Z-9630	1710	29	96	30	48.33	134.87

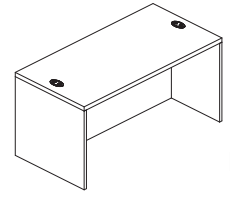

1" Straight Desk w/Recessed Full Modesty and Grommets

How to Specify:

Each laminate comes with matching vinyl trim color unless otherwise specified on your purchase order. Refer to the laminate finishes [on page 19](#) for details.

Options:

laminate color

grommet color

Notes:

Recessed modesty:

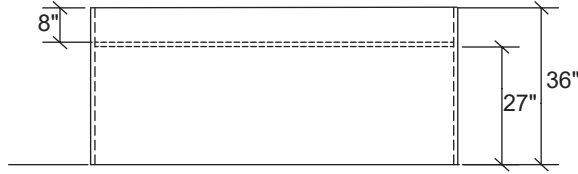

Code	Price	H	W	D	Volume (ft ³)	Weight (lb)
QML-TSRG-6030	1164	29	60	30	30.21	137.93
QML-TSRG-6036	1348	29	60	36	36.25	150.3
QML-TSRG-6630	1209	29	66	30	33.23	149.46
QML-TSRG-6636	1397	29	66	36	39.88	160.2
QML-TSRG-7230	1262	29	72	30	36.25	160.99
QML-TSRG-7236	1451	29	72	36	43.5	170.1
QML-TSRG-7830	1332	29	78	30	39.27	172.52
QML-TSRG-7836	1515	29	78	36	47.13	180
QML-TSRG-8430	1397	29	84	30	42.29	184.05
QML-TSRG-8436	1571	29	84	36	50.75	189.9
QML-TSRG-9030	1648	29	90	30	45.31	195.58
QML-TSRG-9036	1733	29	90	36	54.38	199.8
QML-TSRG-9630	1782	29	96	30	48.33	207.11
QML-TSRG-9636	1880	29	96	36	58	209.7

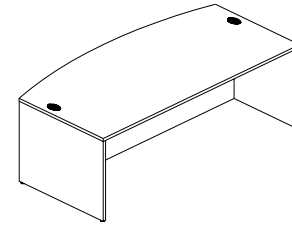

1" Arc Desk w/Recessed Full Modesty and Grommets

How to Specify:

Each laminate comes with matching vinyl trim color unless otherwise specified on your purchase order. Refer to the laminate finishes [on page 19](#) for details.

Options:

laminate color

grommet color

Notes:

Recessed modesty:

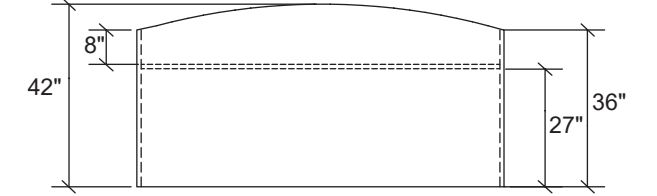

Code	Price	H	W	D	Volume (ft ³)	Weight (lb)
QML-TARG-7236	1692	29	72	36	43.5	178.09
QML-TARG-7836	1776	29	78	36	47.13	188.84
QML-TARG-8436	1864	29	84	36	50.75	199.59
QML-TARG-9036	1941	29	90	36	54.38	210.34
QML-TARG-9636	2024	29	96	36	58	221.09



Union Quick Ship Pricebook
January 2026

Tables

D-table	30
J-table	31
P-table	32
F-table	33
U-table	34
C-table	35

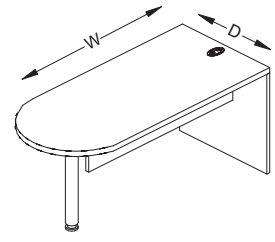

1" D-Table w/Full Gable

How to Specify:

Each laminate comes with matching vinyl trim color unless otherwise specified on your purchase order. Refer to the laminate finishes [on page 19](#) for details.

Notes:

36"D D-tables include two post supports.

Options:

- laminate color

- grommet color

- metal color (for post support)

Code	Price	H	W	D	Volume (ft ³)	Weight (lb)
QML-TD0G-6030	1232	29	60	30	30.21	86.48
QML-TD0G-6036	1344	29	60	36	36.25	107.18
QML-TD0G-6630	1285	29	66	30	33.23	92.95
QML-TD0G-6636	1403	29	66	36	39.88	115.76
QML-TD0G-7230	1331	29	72	30	36.25	99.42
QML-TD0G-7236	1442	29	72	36	43.5	124.34
QML-TD0G-7830	1379	29	78	30	39.27	105.9
QML-TD0G-7836	1490	29	78	36	47.13	132.92
QML-TD0G-8430	1432	29	84	30	42.29	112.38
QML-TD0G-8436	1542	29	84	36	50.75	141.5

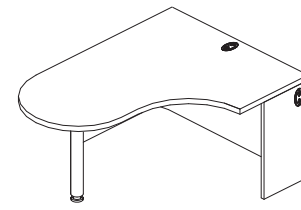

1" J-Table, LH Shown

How to Specify:

Each laminate comes with matching vinyl trim color unless otherwise specified on your purchase order. Refer to the laminate finishes [on page 19](#) for details.

Notes:

Options:

- laminate color

- grommet color

- metal color (for post support)

Code	Price	H	W	D	Volume (ft ³)	Weight (lb)
Left Hand						
QML-TJ0G-604824L	1846	29	60	24	24.17	120.67
QML-TJ0G-664824L	1981	29	66	24	26.58	127.15
QML-TJ0G-724824L	2087	29	72	24	29	133.63
QML-TJ0G-784824L	2206	29	78	24	31.42	140.11
QML-TJ0G-844824L	2313	29	84	24	33.83	146.59
Right Hand						
QML-TJ0G-604824R	1846	29	60	24	24.17	120.67
QML-TJ0G-664824R	1981	29	66	24	26.58	127.15
QML-TJ0G-724824R	2087	29	72	24	29	133.63
QML-TJ0G-784824R	2206	29	78	24	31.42	140.11
QML-TJ0G-844824R	2313	29	84	24	33.83	146.59

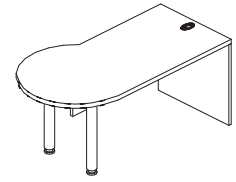

1" P-Table, LH Shown

How to Specify:

Each laminate comes with matching vinyl trim color unless otherwise specified on your purchase order. Refer to the laminate finishes [on page 19](#) for details.

Notes:

Options:

- laminate color

- grommet color

- metal color (for post support)

Code	Price	H	W	D	Volume (ft ³)	Weight (lb)
Left Hand						
QML-TP0G-6030-L	1692	29	60	30	30.21	96.51
QML-TP0G-6630-L	1776	29	66	30	33.23	103.34
QML-TP0G-7230-L	1838	29	72	30	36.25	110.17
QML-TP0G-7830-L	1917	29	78	30	39.27	117
QML-TP0G-8430-L	1989	29	84	30	42.29	123.83
Right Hand						
QML-TP0G-6030-R	1692	29	60	30	30.21	96.51
QML-TP0G-6630-R	1776	29	66	30	33.23	103.34
QML-TP0G-7230-R	1838	29	72	30	36.25	110.17
QML-TP0G-7830-R	1917	29	78	30	39.27	117
QML-TP0G-8430-R	1989	29	84	30	42.29	123.83

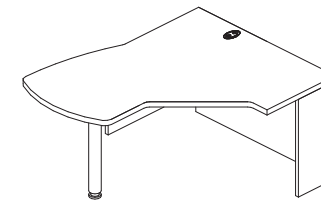

1" F-Table, LH Shown

How to Specify:

Each laminate comes with matching vinyl trim color unless otherwise specified on your purchase order. Refer to the laminate finishes [on page 19](#) for details.

Notes:

Options:

- laminate color

- grommet color

- metal color (for post support)

Code	Price	H	W	D	Volume (ft ³)	Weight (lb)
Left Hand						
QML-TFSG-604824L	2254	29	60	24	24.17	123.35
QML-TFSG-664824L	2292	29	66	24	26.58	129.35
QML-TFSG-724824L	2333	29	72	24	29	135.35
QML-TFSG-784824L	2373	29	78	24	31.42	141.35
QML-TFSG-844824L	2412	29	84	24	33.83	147.35
Right Hand						
QML-TFSG-604824R	2254	29	60	24	24.17	123.35
QML-TFSG-664824R	2292	29	66	24	26.58	129.35
QML-TFSG-724824R	2333	29	72	24	29	135.35
QML-TFSG-784824R	2373	29	78	24	31.42	141.35
QML-TFSG-844824R	2412	29	84	24	33.83	147.35

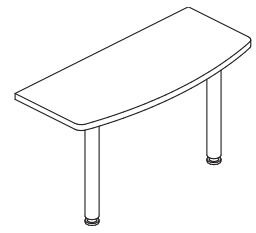

1" U-Table

How to Specify:

Each laminate comes with matching vinyl trim color unless otherwise specified on your purchase order. Refer to the laminate finishes [on page 19](#) for details.

Notes:

Options:

- laminate color
- metal color (for post support)

Code	Price	H	W	D	Volume (ft ³)	Weight (lb)
QML-WEU0-4224	960	29	42	24	16.92	38.79
QML-WEU0-4824	997	29	48	24	19.33	42.36
QML-WEU0-6024	1204	29	60	24	24.17	45.92

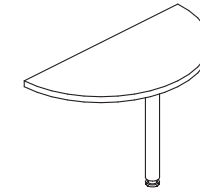

1" C-Table

How to Specify:

Each laminate comes with matching vinyl trim color unless otherwise specified on your purchase order. Refer to the laminate finishes [on page 19](#) for details.

Notes:

Options:

- laminate color
- metal color (for post support)

Code	Price	H	W	D	Volume (ft ³)	Weight (lb)
QML-TC00-4221	744	29	42	21	14.8	25
QML-TC00-4824	862	29	48	24	19.33	30.56
QML-TC00-6030	982	29	60	30	30.21	36.12



Union Quick Ship Pricebook
January 2026
Corners

corners

<u>straight front corner</u>	38
<u> full modesty /w gable</u>	38
<u> partial modesty no gable</u>	39
<u> partial modesty /w gable</u>	40
<u>curved front corner</u>	41
<u> full modesty /w gable</u>	41
<u> full modesty no gable</u>	42
<u> partial modesty /w gable</u>	43

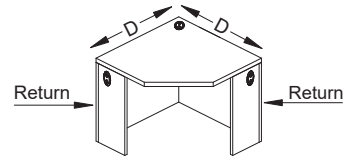

1" Straight Front Corner Worksurface
w/Full Modesties

How to Specify:

Each laminate comes with matching vinyl trim color unless otherwise specified on your purchase order. Refer to the laminate finishes [on page 19](#) for details..

Notes:

Options:

- laminate color
- grommet color

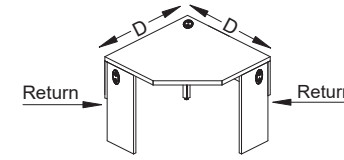

1" Straight Front Corner Worksurface
w/Partial Modesties , no Gables

How to Specify:

Each laminate comes with matching vinyl trim color unless otherwise specified on your purchase order. Refer to the laminate finishes [on page 19](#) for details.

Notes:

Partial modesties are 10"H.

Options:

- laminate color
- grommet color
- metal color (for post support)

Code	Price	H	D	Return	Volume (ft ³)	Weight (lb)
QML-W5S0-3621	1145	29	36	21	12.69	99.2
QML-W5S0-3624	1145	29	36	24	14.5	100.27
QML-W5S0-4221	1345	29	42	21	14.8	117.14
QML-W5S0-4224	1345	29	42	24	16.92	118.66

Code	Price	H	D	Return	Volume (ft ³)	Weight (lb)
QML-W5S0-3621-N	815	29	36	21	12.69	99.2
QML-W5S0-3624-N	815	29	36	24	14.5	100.27
QML-W5S0-4221-N	1018	29	42	21	14.8	117.14
QML-W5S0-4224-N	1018	29	42	24	16.92	118.66

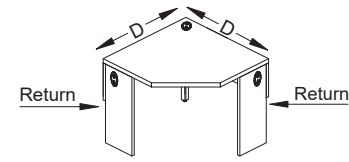

1" Straight Front Corner Worksurface
w/Partial Modesties and Gables

How to Specify:

Each laminate comes with matching vinyl trim color unless otherwise specified on your purchase order. Refer to the laminate finishes [on page 19](#) for details.

Notes:

Partial modesties are 10"H.

Options:

- laminate color

- grommet color

- metal color (for post support)

Code	Price	H	D	Return	Volume (ft ³)	Weight (lb)
QML-W5S0-3621-P	1145	29	36	21	12.69	69.94
QML-W5S0-3624-P	1145	29	36	24	14.5	70.71
QML-W5S0-4221-P	1345	29	42	21	14.8	82.78
QML-W5S0-4224-P	1345	29	42	24	16.92	84.3

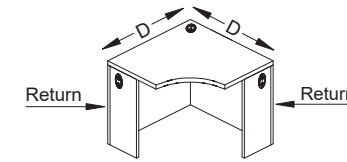

1" Curved Front Corner Worksurface
w/Full Modesties

How to Specify:

Each laminate comes with matching vinyl trim color unless otherwise specified on your purchase order. Refer to the laminate finishes [on page 19](#) for details.

Notes:

Options:

- laminate color

- grommet color

Code	Price	H	D	Return	Volume (ft ³)	Weight (lb)
QML-W5C0-3621	1145	29	36	21	12.69	97.54
QML-W5C0-3624	1145	29	36	24	14.5	98.3
QML-W5C0-4221	1345	29	42	21	14.8	113.86
QML-W5C0-4224	1345	29	42	24	16.92	116.26

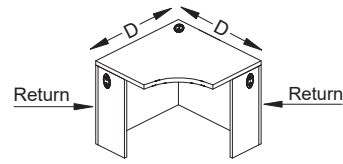

1" Curved Front Corner Worksurface w/Full Modesties, no gables

How to Specify:

Each laminate comes with matching vinyl trim color unless otherwise specified on your purchase order. Refer to the laminate finishes [on page 19](#) for details.

Notes:

Options:

- laminate color

- grommet color

Code	Price	H	D	Return	Volume (ft ³)	Weight (lb)
QML-W5C0-3621-N	815	29	36	21	12.69	97.54
QML-W5C0-3624-N	815	29	36	24	14.5	98.3
QML-W5C0-4221-N	1018	29	42	21	14.8	113.66
QML-W5C0-4224-N	1018	29	42	24	16.92	116.26

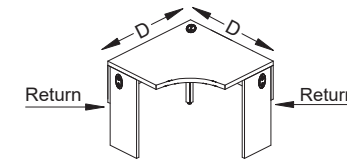

1" Curved Front Corner Worksurface w/ Partial Modesties and gables

How to Specify:

Each laminate comes with matching vinyl trim color unless otherwise specified on your purchase order. Refer to the laminate finishes [on page 19](#) for details.

Notes:

Partial modesties are 10"H.

Options:

- laminate color

- grommet color

- metal color (for post support)

Code	Price	H	D	Return	Volume (ft ³)	Weight (lb)
QML-W5C0-3621-P	1145	29	36	21	12.69	67.98
QML-W5C0-3624-P	1145	29	36	24	14.5	68.74
QML-W5C0-4221-P	1345	29	42	21	14.8	75.61
QML-W5C0-4224-P	1345	29	42	24	16.92	78.01



Union Quick Ship Pricebook
January 2026

Unitized Desks

unitized desks

<u>curved front</u>	46
<u>w/full modesties /w gables</u>	46
<u>w/full modesties / no gables</u>	47
<u>w/partial modesties /w gables</u>	48

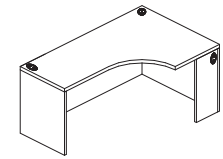

1" Curved Front Unitized Desk
w/Full Modesties, Full Gables,
LH Shown

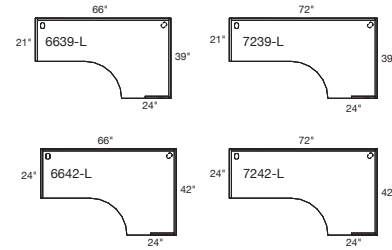

How to Specify:

Each laminate comes with matching vinyl trim color unless otherwise specified on your purchase order. Refer to the laminate finishes [on page 19](#) for details.

Notes:

Options:

- laminate color
- grommet color

Code	Price	H	W	D	Volume (ft ³)	Weight (lb)
Left Hand						
QML-UC4G-6639-L	1763	29	66	39	43.2	120.6
QML-UC4G-6642-L	1833	29	66	42	46.52	161.1
QML-UC4G-7239-L	1874	29	72	39	47.13	153.9
QML-UC4G-7242-L	2200	29	72	42	50.75	170.55
Right Hand						
QML-UC4G-6639-R	1763	29	66	39	43.2	120.6
QML-UC4G-6642-R	1833	29	66	42	46.52	161.1
QML-UC4G-7239-R	1874	29	72	39	47.13	153.9
QML-UC4G-7242-R	2200	29	72	42	50.75	170.55

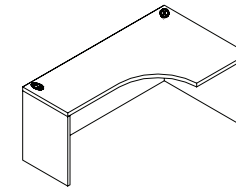

1" Curved Front Unitized Desk
w/Full Modesties, No Gables
LH Shown

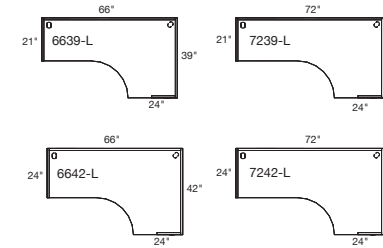

How to Specify:

Each laminate comes with matching vinyl trim color unless otherwise specified on your purchase order. Refer to the laminate finishes [on page 19](#) for details.

Notes:

Options:

- laminate color
- grommet color

Code	Price	H	W	D	Volume (ft ³)	Weight (lb)
Left Hand						
QML-UC4G-6639-L-N	1597	29	66	39	43.2	120.6
QML-UC4G-6642-L-N	1666	29	66	42	46.52	161.1
QML-UC4G-7239-L-N	1711	29	72	39	47.13	153.9
QML-UC4G-7242-L-N	2031	29	72	42	50.75	170.55
Right Hand						
QML-UC4G-6639-R-N	1597	29	66	39	43.2	120.6
QML-UC4G-6642-R-N	1666	29	66	42	46.52	161.1
QML-UC4G-7239-R-N	1711	29	72	39	47.13	153.9
QML-UC4G-7242-R-N	2031	29	72	42	50.75	170.55

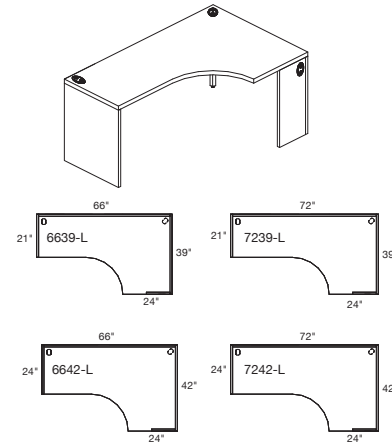

1" Curved Front Unitized Desk
w/Partial Modesties,
/ no Gables
LH Shown

How to Specify:

Each laminate comes with matching vinyl trim color unless otherwise specified on your purchase order. Refer to the laminate finishes [on page 19](#) for details.

Notes:

Options:

laminate color

grommet color

Code	Price	H	W	D	Volume (ft ³)	Weight (lb)
Left Hand						
QML-UC4Z-6639-L	1763	29	66	39	43.2	99.79
QML-UC4Z-6642-L	1833	29	66	42	46.52	114.66
QML-UC4Z-7239-L	1874	29	72	39	47.13	108.77
QML-UC4Z-7242-L	2200	29	72	42	50.75	126.11
Right Hand						
QML-UC4Z-6639-R	1763	29	66	39	43.2	99.79
QML-UC4Z-6642-R	1833	29	66	42	46.52	114.66
QML-UC4Z-7239-R	1874	29	72	39	47.13	108.77
QML-UC4Z-7242-R	2200	29	72	42	50.75	126.11



Union Quick Ship Pricebook
January 2026
Bridges

bridges

<u>straight bridge</u>	52
<u>/w full modesty</u>	52
<u>/w partial modesty</u>	53

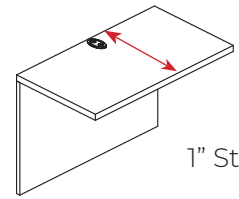

1" Straight Bridge w/Full Modesty

How to Specify:

Each laminate comes with matching vinyl trim color unless otherwise specified on your purchase order. Refer to the laminate finishes [on page 19](#) for details.

Notes:

Options:

- laminate color

- grommet color

Code	Price	H	W	D	Volume (ft ³)	Weight (lb)
QML-BS0G-3021	540	29	30	21	10.57	38
QML-BS0G-3024	565	29	30	24	12.08	40.35
QML-BS0G-3621	582	29	36	21	12.69	45.78
QML-BS0G-3624	605	29	36	24	14.5	48.6
QML-BS0G-4221	647	29	42	21	14.8	53.56
QML-BS0G-4224	667	29	42	24	16.92	56.85
QML-BS0G-4821	691	29	48	21	16.92	61.34
QML-BS0G-4824	758	29	48	24	19.33	65.1

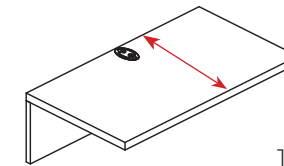

1" Straight Bridge w/Partial Modesty

How to Specify:

Each laminate comes with matching vinyl trim color unless otherwise specified on your purchase order. Refer to the laminate finishes [on page 19](#) for details.

Notes:

Partial modesties are 10"H.

Options:

- laminate color

- grommet color

Code	Price	H	W	D	Volume (ft ³)	Weight (lb)
QML-BS0Z-3021	540	29	30	21	10.57	25.4
QML-BS0Z-3024	565	29	30	24	12.08	27.75
QML-BS0Z-3621	582	29	36	21	12.69	33.18
QML-BS0Z-3624	605	29	36	24	14.5	36
QML-BS0Z-4221	647	29	42	21	14.8	40.96
QML-BS0Z-4224	667	29	42	24	16.92	44.25
QML-BS0Z-4821	691	29	48	21	16.92	48.74
QML-BS0Z-4824	758	29	48	24	19.33	52.5



Union Quick Ship Pricebook
January 2026
Returns

returns

<u>straight return</u>	56
<u>full modesty</u>	56
<u>partial modesty</u>	58

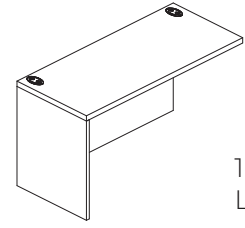

1" Straight Return w/Full Modesty, LH Shown

How to Specify:

Each laminate comes with matching vinyl trim color unless otherwise specified on your purchase order. Refer to the laminate finishes [on page 19](#) for details.

Notes:

1 grommet for width 48" or less
2 grommets for width 54" and wider

Options:

laminate color

grommet color

Code	Price	H	W	D	Volume (ft ³)	Weight (lb)
QML-WS1G-2421-L	687	29	24	21	8.46	45
QML-WS1G-2424-L	699	29	24	24	9.67	48.75
QML-WS1G-2430-L	770	29	24	30	12.08	56.7
QML-WS1G-3021-L	699	29	30	21	10.57	52.4
QML-WS1G-3024-L	712	29	30	24	12.08	56.55
QML-WS1G-3030-L	792	29	30	30	15.1	65.73
QML-WS1G-3621-L	712	29	36	21	12.69	59.8
QML-WS1G-3624-L	720	29	36	24	14.5	64.35
QML-WS1G-3630-L	832	29	36	30	18.13	74.76
QML-WS1G-4221-L	720	29	42	21	14.8	67.2
QML-WS1G-4224-L	746	29	42	24	16.92	72.15
QML-WS1G-4230-L	864	29	42	30	21.15	83.79
QML-WS1G-4821-L	770	29	48	21	16.92	74.6
QML-WS1G-4824-L	792	29	48	24	19.33	79.95
QML-WS1G-4830-L	904	29	48	30	24.17	92.82
QML-WS1G-5421-L	819	29	54	21	19.03	82
QML-WS1G-5424-L	844	29	54	24	21.75	87.75
QML-WS1G-5430-L	943	29	54	30	27.19	101.85
QML-WS1G-6021-L	864	29	60	21	21.15	89.4
QML-WS1G-6024-L	892	29	60	24	24.17	95.55
QML-WS1G-6030-L	1004	29	60	30	30.21	110.88
QML-WS1G-2421-R	687	29	24	21	8.46	45
QML-WS1G-2424-R	699	29	24	24	9.67	48.75
QML-WS1G-2430-R	770	29	24	30	12.08	56.7
QML-WS1G-3021-R	699	29	30	21	10.57	52.4
QML-WS1G-3024-R	712	29	30	24	12.08	56.55
QML-WS1G-3030-R	792	29	30	30	15.1	65.73
QML-WS1G-3621-R	712	29	36	21	12.69	59.8
QML-WS1G-3624-R	720	29	36	24	14.5	64.35
QML-WS1G-3630-R	832	29	36	30	18.13	74.76
QML-WS1G-4221-R	720	29	42	21	14.8	67.2
QML-WS1G-4224-R	746	29	42	24	16.92	72.15
QML-WS1G-4230-R	864	29	42	30	21.15	83.79
QML-WS1G-4821-R	770	29	48	21	16.92	74.6
QML-WS1G-4824-R	792	29	48	24	19.33	79.95
QML-WS1G-4830-R	904	29	48	30	24.17	92.82
QML-WS1G-5421-R	819	29	54	21	19.03	82
QML-WS1G-5424-R	844	29	54	24	21.75	87.75
QML-WS1G-5430-R	943	29	54	30	27.19	101.85
QML-WS1G-6021-R	864	29	60	21	21.15	89.4
QML-WS1G-6024-R	892	29	60	24	24.17	95.55
QML-WS1G-6030-R	1004	29	60	30	30.21	110.88

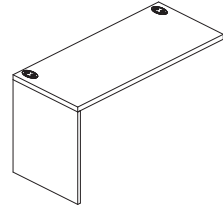

1" Straight Return w/Partial Modesty, LH Shown

How to Specify:

Each laminate comes with matching vinyl trim color unless otherwise specified on your purchase order. Refer to the laminate finishes [on page 19](#) for details.

Notes:

Partial modesties are 10"H
 1 grommet for width 48" or less
 2 grommets for width 54" and wider

Options:

laminate color

grommet color

Code	Price	H	W	D	Volume (ft ³)	Weight (lb)
QML-WS1Z-2421-L	687	29	24	21	8.46	35.1
QML-WS1Z-2424-L	699	29	24	24	9.67	36.9
QML-WS1Z-2430-L	770	29	24	30	12.08	49.35
QML-WS1Z-3021-L	699	29	30	21	10.57	42.5
QML-WS1Z-3024-L	712	29	30	24	12.08	44.7
QML-WS1Z-3030-L	792	29	30	30	15.1	58.38
QML-WS1Z-3621-L	712	29	36	21	12.69	49.9
QML-WS1Z-3630-L	832	29	36	30	18.13	67.41
QML-WS1Z-4221-L	720	29	42	21	14.8	57.3
QML-WS1Z-4224-L	746	29	42	24	16.92	60.3
QML-WS1Z-4230-L	864	29	42	30	21.15	76.44
QML-WS1Z-4230-R	864	29	42	30	21.15	76.44
QML-WS1Z-4821-L	770	29	48	21	16.92	64.7
QML-WS1Z-4824-L	792	29	48	24	19.33	68.1
QML-WS1Z-4830-L	904	29	48	30	24.17	85.47
QML-WS1Z-5421-L	819	29	54	21	19.03	72.1
QML-WS1Z-5424-L	844	29	54	24	21.75	75.9
QML-WS1Z-5430-L	943	29	54	30	27.19	94.5
QML-WS1Z-6021-L	864	29	60	21	21.15	79.5
QML-WS1Z-6024-L	892	29	60	24	24.17	83.7
QML-WS1Z-6030-L	1004	29	60	30	30.21	103.53
QML-WS1Z-2421-R	687	29	24	21	8.46	35.1
QML-WS1Z-2424-R	699	29	24	24	9.67	36.9
QML-WS1Z-2430-R	770	29	24	30	12.08	49.35
QML-WS1Z-3021-R	699	29	30	21	10.57	42.5
QML-WS1Z-3024-R	712	29	30	24	12.08	44.7
QML-WS1Z-3030-R	792	29	30	30	15.1	58.38
QML-WS1Z-3621-R	712	29	36	21	12.69	49.9
QML-WS1Z-3624-R	720	29	36	24	14.5	52.5
QML-WS1Z-3630-R	832	29	36	30	18.13	67.41
QML-WS1Z-4221-R	720	29	42	21	14.8	57.3
QML-WS1Z-4224-R	746	29	42	24	16.92	60.3
QML-WS1Z-4230-R	864	29	42	30	21.15	76.44
QML-WS1Z-4821-R	770	29	48	21	16.92	64.7
QML-WS1Z-4824-R	792	29	48	24	19.33	68.1
QML-WS1Z-4830-R	904	29	48	30	24.17	85.47
QML-WS1Z-5421-R	819	29	54	21	19.03	72.1
QML-WS1Z-5424-R	844	29	54	24	21.75	75.9
QML-WS1Z-5430-R	943	29	54	30	27.19	94.5
QML-WS1Z-6021-R	864	29	60	21	21.15	79.5
QML-WS1Z-6024-R	892	29	60	24	24.17	83.7
QML-WS1Z-6030-R	1004	29	60	30	30.21	103.53



Union Quick Ship Pricebook
January 2026
Credenzas

credenzas

<u>top</u>	62
<u>double lateral file</u>	63
<u>double storage cabinet</u>	64

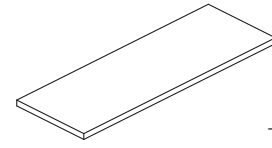

1" Credenza Top

How to Specify:

Each laminate comes with matching vinyl trim color unless otherwise specified on your purchase order. Refer to the laminate finishes [on page 19](#) for details.

Notes:

Options:

laminate color

handle color

handle style

Code	Price	H	W	D	Volume (ft ³)	Weight (lb)
QML-WSS0-6021	435	1	60	21	0.73	32.81
QML-WSS0-6621	477	1	66	21	0.8	36.09
QML-WSS0-7221	500	1	72	21	0.88	39.37
QML-WSS0-7821	541	1	78	21	0.95	42.65
QML-WSS0-8421	583	1	84	21	1.02	45.93

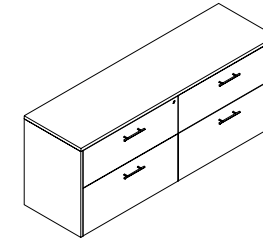

1" Credenza w/Double Lateral Files

How to Specify:

Each laminate comes with matching vinyl trim color unless otherwise specified on your purchase order. Refer to the laminate finishes [on page 19](#) for details.

Notes:

Options:

laminate color

edge profile

handle color

handle style

Code	Price	H	W	D	Volume (ft ³)	Weight (lb)
QML-CRLL-7221	2850	29	72	21	25.38	205.87
QML-CRLL-7224	3019	29	72	24	29	220

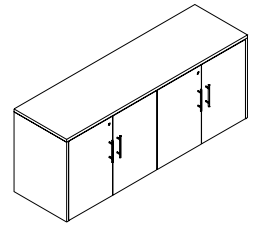

1" Credenza w/Double Storage Cabinets

How to Specify:

Each laminate comes with matching vinyl trim color unless otherwise specified on your purchase order. Refer to the laminate finishes [on page 19](#) for details.

Notes:

Cabinets and laterals include locks and keys.

Options:

laminate color

handle color

handle style

Code	Price	H	W	D	Volume (ft ³)	Weight (lb)
QML-CRSS-7221	2223	29	72	21	25.38	225.45
QML-CRSS-7224	2376	29	72	24	29	236.26



Union Quick Ship Pricebook
January 2026
Supports

supports

<u>intermediate support</u>	<u>68</u>
<u>cantilever</u>	<u>69</u>

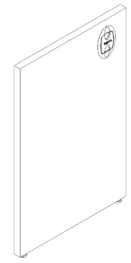

Intermediate Gable Support

How to Specify:

Each laminate comes with matching vinyl trim color unless otherwise specified on your purchase order. Refer to the laminate finishes [on page 19](#) for details.

Notes:

Options:

- laminate color
- grommet color

Code	Price	H	W	D	Volume (ft ³)	Weight (lb)
QM-CGU0-12	229	28	12	1	0.19	8.75
QM-CGU0-18	244	28	18	1	0.29	13.12

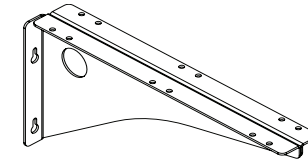

Center Cantilever Support

How to Specify:

Cantilevers are used to join 2 desks w/full modesty. Intermediate gable is required instead of cantilever when hutch sits on top of a desk.

Notes:

Options:

- cantilever available in black only

Code	Price	H	W	D	Volume (ft ³)	Weight (lb)
QM-CCAB-16	120	0	#N/A	#N/A	#N/A	#N/A
QM-CCAB-22	129	0	#N/A	#N/A	#N/A	#N/A



Union Quick Ship Pricebook
January 2026
Filing & Storage

filing and storage

<u>pedestals</u>	72
<u>underdesk combo pedestal BBF & FF</u>	73
<u>underdesk storage cabinet</u>	74
<u>underdesk 2-drawer lateral file</u>	75
<u>freestanding 2-drawer lateral file</u>	76
<u>freestanding 3-drawer lateral file</u>	77
<u>freestanding storage cabinet</u>	78
<u>freestanding storage tower- single door</u>	79
<u>storage cabinet w/coat bar and shelves</u>	80
<u>freestanding combo lateral storage double door</u>	81
<u>bookcase</u>	82

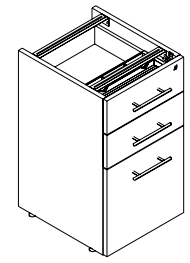

Underdesk Box/Box/File Pedestal

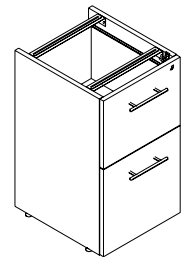

Underdesk File/File Pedestal



Mobile File/File Pedestal

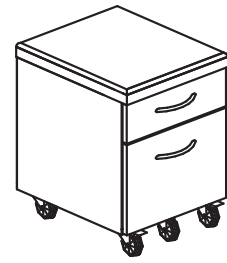

Mobile Box/File Pedestal w/Upholstered Seat Cushion

How to Specify:

Each laminate comes with matching vinyl trim color unless otherwise specified on your purchase order. Refer to the laminate finishes [on page 19](#) for details.

Notes:

Pedestals include lock and keys.

Options:

laminate color

handle color

handle style

back full back

Code	Price	H	W	D	Volume (ft ³)	Weight (lb)
Underdesk Box/Box/File Pedestal						
QM-FPBU-1618	1052	28	16	18	4.67	55
QM-FPBU-1624	1124	28	16	24	6.22	55
Underdesk File/File Pedestal						
QM-FPFU-1624	1124	28	16	24	6.22	55
Mobile File/File Pedestal						
QM-FPFM-1621	1382	28	16	21	5.44	68
Mobile Box/File Pedestal w/Upholstered Seat Cushion						
QM-1030-1618	1686	21	16	18	3.5	55

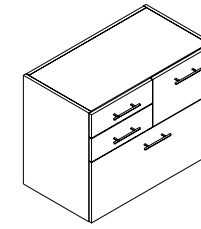

Underdesk Combo Pedestal w/Box/Box/File and File/File, LH Shown

How to Specify:

Each laminate comes with matching vinyl trim color unless otherwise specified on your purchase order. Refer to the laminate finishes [on page 19](#) for details.

Notes:

Cabinets and lateral files include lock and keys.

Options:

laminate color

handle color

handle style

Code	Price	H	W	D	Volume (ft ³)	Weight (lb)
QM-FPJU-3620-L	2033	28	36	20	11.67	121
QM-FPJU-3621-L	2033	28	36	21	12.25	122
QM-FPJU-3620-R	2033	28	36	20	11.67	121
QM-FPJU-3621-R	2033	28	36	21	12.25	122

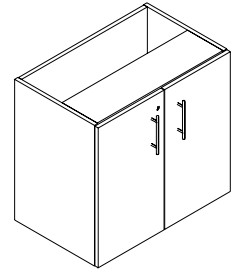

Underdesk Storage Cabinet

How to Specify:

Each laminate comes with matching vinyl trim color unless otherwise specified on your purchase order. Refer to the laminate finishes [on page 19](#) for details.

Notes:

Cabinets and lateral files include lock and keys.

Options:

laminate color

handle color

handle style

Code	Price	H	W	D	Volume (ft ³)	Weight (lb)
QM-FSU0-3020	1289	28	30	19	9.72	88
QM-FSU0-3021	1289	28	30	21	10.21	92
QM-FSU0-3620	1396	28	36	19	11.67	102
QM-FSU0-3621	1396	28	36	21	12.25	107
QM-FSU0-4220	1502	28	42	19	13.61	117
QM-FSU0-4221	1502	28	42	21	14.29	122

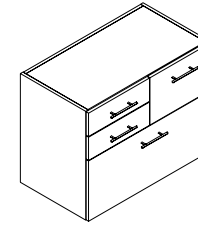

Underdesk 2-Drawer Lateral File

How to Specify:

Each laminate comes with matching vinyl trim color unless otherwise specified on your purchase order. Refer to the laminate finishes [on page 19](#) for details.

Notes:

Cabinets and lateral files include lock and keys.

Options:

laminate color

handle color

handle style

Code	Price	H	W	D	Volume (ft ³)	Weight (lb)
QM-FL2U-3020	1663	28	30	20	9.72	82.06
QM-FL2U-3021	1663	28	30	21	10.21	84.6
QM-FL2U-3620	1723	28	36	20	11.67	86.64
QM-FL2U-3621	1723	28	36	21	12.25	88.02
QM-FL2U-4220	1819	28	42	20	13.61	89.35
QM-FL2U-4221	1819	28	42	21	14.29	91.44

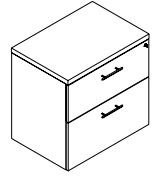

1" Freestanding 2-Drawer Lateral File

How to Specify:

Each laminate comes with matching vinyl trim color unless otherwise specified on your purchase order. Refer to the laminate finishes [on page 19](#) for details.

Notes:

Cabinets and lateral files include lock and keys.

Options:

- laminate color

- handle color

- handle style

Code	Price	H	W	D	Volume (ft ³)	Weight (lb)
QML-FL2F-3021	1721	29	30	21	10.57	92.7
QML-FL2F-3621	1777	29	36	21	12.69	107.1
QML-FL2F-4221	1872	29	42	21	14.8	121.5

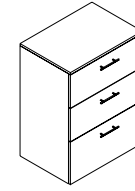

3/4" Freestanding 3-Drawer Lateral File

How to Specify:

Each laminate comes with matching vinyl trim color unless otherwise specified on your purchase order. Refer to the laminate finishes [on page 19](#) for details.

Notes:

Cabinets and lateral files include lock and keys.

Options:

- laminate color

- handle color

- handle style

Code	Price	H	W	D	Volume (ft ³)	Weight (lb)
QML-FL3F-3021	2207.25	28	16	24	6.22	55
QML-FL3F-3621	2302.08	40.5	36	21	17.7	155.0

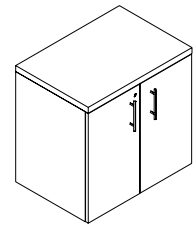

1" Freestanding Storage Cabinet

How to Specify:

Each laminate comes with matching vinyl trim color unless otherwise specified on your purchase order. Refer to the laminate finishes [on page 19](#) for details.

Notes:

Cabinets and lateral files include lock and keys.

Options:

laminate color

handle color

handle style

Code	Price	H	W	D	Volume (ft ³)	Weight (lb)
QML-FSF0-3021	1356	29	30	21	10.57	88
QML-FSF0-3621	1462	29	36	21	12.69	97
QML-FSF0-4221	1565	29	42	21	14.8	106

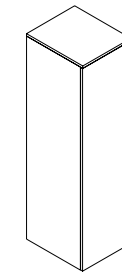

3/4" Storage Cabinet w/ Shelves

How to Specify:

Each laminate comes with matching vinyl trim color unless otherwise specified on your purchase order. Refer to the laminate finishes [on page 19](#) for details.

Notes:

Cabinets and lateral files include lock and keys.

Options:

laminate color

handle color

handle style

Code	Price	H	W	D	Volume (ft ³)	Weight (lb)
QML-FSDS-1821-L	1511	67	18	21	14.66	128.7
QML-FSDS-1821-R	1511	67	18	21	14.66	128.7

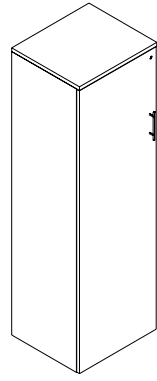

3/4" Storage Cabinet w/Coat Bar and Shelves, Left Hand shown

How to Specify:

Each laminate comes with matching vinyl trim color unless otherwise specified on your purchase order. Refer to the laminate finishes [on page 19](#) for details.

Notes:

Cabinets and lateral files include lock and keys.

Options:

laminate color

handle color

handle style

Code	Price	H	W	D	Volume (ft ³)	Weight (lb)
QML-FSDC-2421-L	1634	67	24	21	19.54	169.95
QML-FSDC-2421-R	1634	67	24	21	19.54	169.95

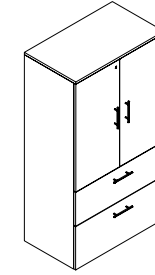

3/4" Combo Cabinet w/Storage and Lateral File

How to Specify:

Each laminate comes with matching vinyl trim color unless otherwise specified on your purchase order. Refer to the laminate finishes [on page 19](#) for details.

Notes:

Cabinets and lateral files include lock and keys.

Options:

laminate color

handle color

handle style

Code	Price	H	W	D	Volume (ft ³)	Weight (lb)
QML-FCSL-3621	2667	67	36	21	29.31	251.25

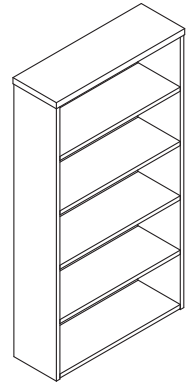

12" or 15" Deep bookcase
3/4" or 1" top

How to Specify:

Each laminate comes with matching vinyl trim color unless otherwise specified on your purchase order. Refer to the laminate finishes [on page 19](#) for details.

Notes:

- Book cases have adjustable shelves and one fixed shelf at desk height.
- All bookcases come with a solid laminate back in matching color.
- Number of shelves includes shelf on bottom of bookcase.
- Bookcases at desk height (29"H) come with 1" top.
- Bookcases taller than desk height come with 3/4" top.

Options:

laminate color

Code	Price	H	W	D	Volume (ft ³)	Weight (lb)	# of Shelves
12" Deep, 1" Top							
QML-SB0X-292412	704	29	24	12	4.83	48.03	2
QML-SB0X-293012	779	29	30	12	6.04	56.24	2
QML-SB0X-293612	850	29	36	12	7.25	64.45	2
QML-SB0X-294212	925	29	42	12	8.46	72.66	2
15" Deep, 1" Top							
QML-SB0X-292415	790	29	24	15	6.04	57.43	2
QML-SB0X-293015	877	29	30	15	7.55	66.99	2
QML-SB0X-293615	959	29	36	15	9.06	76.54	2
QML-SB0X-294215	1043	29	42	15	10.57	86.1	2
12" Deep, 3/4" Top							
QML-SB0X-672412	1236	67	24	12	11.17	104.8	5
QML-SB0X-673012	1370	67	30	12	13.96	122.31	5
QML-SB0X-673612	1504	67	36	12	16.75	139.81	5
QML-SB0X-674212	1637	67	42	12	19.54	157.32	5
QML-SB0X-772412	1403	77	24	12	12.83	120.9	6
QML-SB0X-773012	1550	77	30	12	16.04	141.17	6
QML-SB0X-773612	1698	77	36	12	19.25	161.44	6
QML-SB0X-774212	1849	77	42	12	22.46	181.7	6
15" Deep, 3/4" Top							
QML-SB0X-672415	1391	67	24	15	13.96	124.81	5
QML-SB0X-673015	1543	67	30	15	17.45	145	5
QML-SB0X-673615	1694	67	36	15	20.94	165.19	5
QML-SB0X-674215	1844	67	42	15	24.43	185.39	5
QML-SB0X-772415	1576	77	24	15	16.04	144.04	6
QML-SB0X-773015	1744	77	30	15	20.05	167.45	6
QML-SB0X-774215	2083	77	42	15	28.07	214.25	6



Union Quick Ship Pricebook
January 2026
Conference Tabletops

conference tabletops

<u>straight tabletop</u>	86
<u>straight tabletop w/power and data</u>	88
<u>boat-shaped tabletop</u>	90
<u>boat-shaped tabletop w/power and data</u>	92
<u>racetrack tabletop</u>	94
<u>racetrack tabletop w/power and data</u>	96

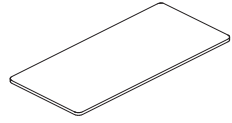

1.5" Straight Tabletop

How to Specify:

Each laminate comes with matching vinyl trim color unless otherwise specified on your purchase order. Refer to the laminate finishes [on page 19](#) for details.

Options:

laminate color

Notes:

Tabletops 72"-96"W are configured in one-piece top.

Tabletops 108"-192"W are configured in two-piece tops.

Tabletops 204"-240"W are configured in three-piece tops.

Boardroom tables with tops comprised of 2 or more pieces will not have a consistent grain pattern.

Code	Price	H	W	D	Volume (ft ³)	Weight (lb)
QMB-MSSX-7236	901	1.5	72	36	2.25	89.91
QMB-MSSX-7242	1128	1.5	72	42	2.63	104.92
QMB-MSSX-8436	1036	1.5	84	36	2.63	104.92
QMB-MSSX-8442	1225	1.5	84	42	3.06	122.43
QMB-MSSX-8448	1306	1.5	84	48	3.5	139.93
QMB-MSSX-9636	1130	1.5	96	36	3	119.93
QMB-MSSX-9642	1325	1.5	96	42	3.5	139.93
QMB-MSSX-9648	1370	1.5	96	48	4	159.94
QMB-MSSX-10848	1642	1.5	108	48	4.5	179.76
QMB-MSSX-10854	1941	1.5	108	54	5.06	202.27
QMB-MSSX-10860	1974	1.5	108	60	5.63	224.78
QMB-MSSX-12048	1794	1.5	120	48	5	199.77
QMB-MSSX-12054	2120	1.5	120	54	5.63	224.78
QMB-MSSX-12060	2153	1.5	120	60	6.25	249.79
QMB-MSSX-13248	1943	1.5	132	48	5.5	219.78
QMB-MSSX-13254	2301	1.5	132	54	6.19	247.29

Code	Price	H	W	D	Volume (ft ³)	Weight (lb)
QMB-MSSX-13260	2335	1.5	132	60	6.88	274.8
QMB-MSSX-14448	2095	1.5	144	48	6	239.78
QMB-MSSX-14454	2483	1.5	144	54	6.75	269.8
QMB-MSSX-14460	2517	1.5	144	60	7.5	299.81
QMB-MSSX-15648	2250	1.5	156	48	6.5	259.69
QMB-MSSX-15654	2667	1.5	156	54	7.31	292.3
QMB-MSSX-15660	2699	1.5	156	60	8.13	324.82
QMB-MSSX-16848	2633	1.5	168	48	7	279.8
QMB-MSSX-16854	2845	1.5	168	54	7.88	314.81
QMB-MSSX-16860	2879	1.5	168	60	8.75	349.83
QMB-MSSX-18048	2672	1.5	180	48	7.5	299.81
QMB-MSSX-18054	3027	1.5	180	54	8.44	337.32
QMB-MSSX-18060	3063	1.5	180	60	9.38	374.84
QMB-MSSX-19248	2701	1.5	192	48	8	319.82
QMB-MSSX-19254	3211	1.5	192	54	9	359.83
QMB-MSSX-19260	3242	1.5	192	60	10	399.85
QMB-MSSX-20448	2996	1.5	204	48	8.5	339.63
QMB-MSSX-20454	3549	1.5	204	54	9.56	382.15
QMB-MSSX-20460	3598	1.5	204	60	10.63	424.67
QMB-MSSX-21648	3146	1.5	216	48	9	359.64
QMB-MSSX-21654	3729	1.5	216	54	10.13	404.66
QMB-MSSX-21660	3780	1.5	216	60	11.25	449.68
QMB-MSSX-22848	3298	1.5	228	48	9.5	379.65
QMB-MSSX-22854	3912	1.5	228	54	10.69	427.17
QMB-MSSX-22860	3960	1.5	228	60	11.88	474.69
QMB-MSSX-24048	3687	1.5	240	48	10	399.66
QMB-MSSX-24054	4092	1.5	240	54	11.25	449.68
QMB-MSSX-24060	4143	1.5	240	60	12.5	499.7

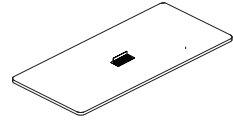

1.5" Straight Tabletop w/Power and Data

How to Specify:

Each laminate comes with matching vinyl trim color unless otherwise specified on your purchase order. Refer to the laminate finishes [on page 19](#) for details.

Notes:

Tabletops 72"-96"W are configured in one-piece top.
 Tabletops 108"-192"W are configured in two-piece tops.
 Tabletops 204"-240"W are configured in three-piece tops.
 Single-piece tabletops are equipped with one power and data grommet, two-piece tabletops are equipped with two power and data grommets, and three-piece tabletops are equipped with three power and data grommets.
 Two power and dual USB-A receptacles with 3 open slots to accommodate RJ11, RJ45, HDMI, VGA or Stereo. Items for 3 open slots must be specified and purchased separately.
 Boardroom tables with tops comprised of 2 or more pieces will not have a consistent grain pattern.

Options:

laminate color

grommet color (for tabletops with power and data)

Code	Price	H	W	D	Volume (ft ³)	Weight (lb)
QMB-MSSP-7236	2144	1.5	72	36	2.25	87.99
QMB-MSSP-7242	2372	1.5	72	42	2.63	102.99
QMB-MSSP-8436	2280	1.5	84	36	2.63	102.99
QMB-MSSP-8442	2470	1.5	84	42	3.06	120.5
QMB-MSSP-8448	2552	1.5	84	48	3.5	138.01
QMB-MSSP-9636	2376	1.5	96	36	3	118
QMB-MSSP-9642	2571	1.5	96	42	3.5	138.01
QMB-MSSP-9648	2615	1.5	96	48	4	158.01
QMB-MSSP-10848	4129	1.5	108	48	4.5	178.17
QMB-MSSP-10854	4430	1.5	108	54	5.06	200.68
QMB-MSSP-10860	4464	1.5	108	60	5.63	223.19
QMB-MSSP-12048	4279	1.5	120	48	5	198.18
QMB-MSSP-12054	4610	1.5	120	54	5.63	223.19
QMB-MSSP-12060	4640	1.5	120	60	6.25	248.2

Code	Price	H	W	D	Volume (ft ³)	Weight (lb)
QMB-MSSP-13248	4431	1.5	132	48	5.5	218.19
QMB-MSSP-13254	4789	1.5	132	54	6.19	245.7
QMB-MSSP-13260	4820	1.5	132	60	6.88	273.21
QMB-MSSP-14448	4583	1.5	144	48	6	238.19
QMB-MSSP-14454	4970	1.5	144	54	6.75	268.21
QMB-MSSP-14460	5005	1.5	144	60	7.5	298.22
QMB-MSSP-15648	4735	1.5	156	48	6.5	258.2
QMB-MSSP-15654	5152	1.5	156	54	7.31	290.72
QMB-MSSP-15660	5187	1.5	156	60	8.13	323.23
QMB-MSSP-16848	5124	1.5	168	48	7	278.21
QMB-MSSP-16854	5333	1.5	168	54	7.88	313.22
QMB-MSSP-16860	5367	1.5	168	60	8.75	348.24
QMB-MSSP-18048	5156	1.5	180	48	7.5	298.22
QMB-MSSP-18054	5513	1.5	180	54	8.44	335.73
QMB-MSSP-18060	5548	1.5	180	60	9.38	373.25
QMB-MSSP-19248	5191	1.5	192	48	8	318.23
QMB-MSSP-19254	5696	1.5	192	54	9	358.24
QMB-MSSP-19260	5728	1.5	192	60	10	398.26
QMB-MSSP-20448	6725	1.5	204	48	8.5	337.25
QMB-MSSP-20454	7281	1.5	204	54	9.56	379.77
QMB-MSSP-20460	7330	1.5	204	60	10.63	422.28
QMB-MSSP-21648	6878	1.5	216	48	9	357.26
QMB-MSSP-21654	7462	1.5	216	54	10.13	402.28
QMB-MSSP-21660	7509	1.5	216	60	11.25	447.29
QMB-MSSP-22848	7027	1.5	228	48	9.5	377.27
QMB-MSSP-22854	7642	1.5	228	54	10.69	424.79
QMB-MSSP-22860	7690	1.5	228	60	11.88	472.3
QMB-MSSP-24048	7419	1.5	240	48	10	397.27
QMB-MSSP-24054	7824	1.5	240	54	11.25	447.29
QMB-MSSP-24060	7872	1.5	240	60	12.5	497.31

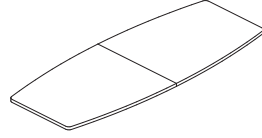
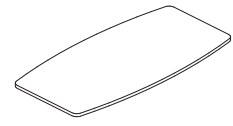

1.5" Boat-Shaped Tabletop

How to Specify:

Each laminate comes with matching vinyl trim color unless otherwise specified on your purchase order. Refer to the laminate finishes [on page 19](#) for details.

Notes:

Tabletops 72"-96"W are configured in one-piece top.

Tabletops 108"-192"W are configured in two-piece tops.

Tabletops 204"-240"W are configured in three-piece tops.

Boardroom tables with tops comprised of 2 or more pieces will not have a consistent grain pattern.

Options:

laminate color

Code	Price	H	W	D	Volume (ft ³)	Weight (lb)
QMB-MBBX-7236	901	1.5	72	36	2.25	80.81
QMB-MBBX-7242	1128	1.5	72	42	2.63	95.09
QMB-MBBX-8436	1036	1.5	84	36	2.63	93.4
QMB-MBBX-8442	1225	1.5	84	42	3.06	110.91
QMB-MBBX-8448	1306	1.5	84	48	3.5	128.42
QMB-MBBX-9636	1130	1.5	96	36	3	106.72
QMB-MBBX-9642	1325	1.5	96	42	3.5	126.73
QMB-MBBX-9648	1370	1.5	96	48	4	146.74
QMB-MBBX-10848	1642	1.5	108	48	4.5	164.78
QMB-MBBX-19260	3242	1.5	192	60	10	373.16

Code	Price	H	W	D	Volume (ft ³)	Weight (lb)
QMB-MBBX-20448	2996	1.5	204	48	8.5	344.36
QMB-MBBX-20454	3549	1.5	204	54	9.56	353.87
QMB-MBBX-20460	3598	1.5	204	60	10.63	396.39
QMB-MBBX-21648	3146	1.5	216	48	9	329.69
QMB-MBBX-21654	3729	1.5	216	54	10.13	374.71
QMB-MBBX-21660	3780	1.5	216	60	11.25	419.73
QMB-MBBX-22848	3298	1.5	228	48	9.5	348.03
QMB-MBBX-22854	3912	1.5	228	54	10.69	395.55
QMB-MBBX-22860	3960	1.5	228	60	11.88	443.07
QMB-MBBX-24048	3687	1.5	240	48	10	366.37
QMB-MBBX-24054	4092	1.5	240	54	11.25	416.39
QMB-MBBX-24060	4143	1.5	240	60	12.5	466.41

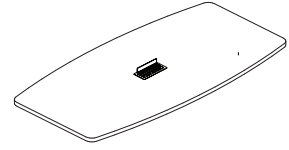

1.5" Boat-Shaped Tabletop w/Power and Data

How to Specify:

Each laminate comes with matching vinyl trim color unless otherwise specified on your purchase order. Refer to the laminate finishes [on page 19](#) for details.

Notes:

Tabletops 72"-96"W are configured in one-piece top.

Tabletops 108"-192"W are configured in two-piece tops.

Tabletops 204"-240"W are configured in three-piece tops.

Single-piece tabletops are equipped with one power and data grommet, two-piece tabletops are equipped with two power and data grommets, and three-piece tabletops are equipped with three power and data grommets.

Two power and dual USB-A receptacles with 3 open slots to accommodate RJ11, RJ45, HDMI, VGA or Stereo. Items for 3 open slots must be specified and purchased separately.

Boardroom tables with tops comprised of 2 or more pieces will not have a consistent grain pattern.

Options:

laminate color

grommet color (for tabletops with power and data)

Code	Price	H	W	D	Volume (ft ³)	Weight (lb)
QMB-MBBP-7236	2144	1.5	72	36	2.25	78.15
QMB-MBBP-7242	2372	1.5	72	42	2.63	93.16
QMB-MBBP-8436	2280	1.5	84	36	2.63	91.47
QMB-MBBP-8442	2470	1.5	84	42	3.06	108.98
QMB-MBBP-8448	2552	1.5	84	48	3.5	126.49
QMB-MBBP-9636	2376	1.5	96	36	3	104.8
QMB-MBBP-9642	2571	1.5	96	42	3.5	124.8
QMB-MBBP-9648	2615	1.5	96	48	4	144.81
QMB-MBBP-10848	4129	1.5	108	48	4.5	160.92
QMB-MBBP-10854	4430	1.5	108	54	5.06	183.44
QMB-MBBP-10860	4464	1.5	108	60	5.63	205.94
QMB-MBBP-12048	4279	1.5	120	48	5	179.26
QMB-MBBP-12054	4610	1.5	120	54	5.63	204.26
QMB-MBBP-12060	4640	1.5	120	60	6.25	229.28

Code	Price	H	W	D	Volume (ft ³)	Weight (lb)
QMB-MBBP-13248	4431	1.5	132	48	5.5	197.6
QMB-MBBP-13254	4789	1.5	132	54	6.19	225.1
QMB-MBBP-13260	4820	1.5	132	60	6.88	252.62
QMB-MBBP-14448	4583	1.5	144	48	6	215.92
QMB-MBBP-14454	4970	1.5	144	54	6.75	245.94
QMB-MBBP-14460	5005	1.5	144	60	7.5	275.94
QMB-MBBP-15648	4735	1.5	156	48	6.5	234.26
QMB-MBBP-15654	5152	1.5	156	54	7.31	266.78
QMB-MBBP-15660	5187	1.5	156	60	8.13	299.28
QMB-MBBP-16848	5124	1.5	168	48	7	252.6
QMB-MBBP-16854	5333	1.5	168	54	7.88	287.6
QMB-MBBP-16860	5367	1.5	168	60	8.75	322.62
QMB-MBBP-18048	5156	1.5	180	48	7.5	270.92
QMB-MBBP-18054	5513	1.5	180	54	8.44	308.44
QMB-MBBP-18060	5548	1.5	180	60	9.38	345.96
QMB-MBBP-19248	5191	1.5	192	48	8	289.26
QMB-MBBP-19254	5696	1.5	192	54	9	329.28
QMB-MBBP-19260	5728	1.5	192	60	10	369.3
QMB-MBBP-20448	6725	1.5	204	48	8.5	308.97
QMB-MBBP-20454	7281	1.5	204	54	9.56	351.49
QMB-MBBP-20460	7330	1.5	204	60	10.63	394.01
QMB-MBBP-21648	6878	1.5	216	48	9	327.31
QMB-MBBP-21654	7462	1.5	216	54	10.13	373.33
QMB-MBBP-21660	7509	1.5	216	60	11.25	417.35
QMB-MBBP-22848	7027	1.5	228	48	9.5	345.65
QMB-MBBP-22854	7642	1.5	228	54	10.69	393.17
QMB-MBBP-22860	7690	1.5	228	60	11.88	440.69
QMB-MBBP-24048	7419	1.5	240	48	10	363.99
QMB-MBBP-24054	7824	1.5	240	54	11.25	414.01
QMB-MBBP-24060	7872	1.5	240	60	12.5	464.03



1.5" Racetrack Tabletop

How to Specify:

Each laminate comes with matching vinyl trim color unless otherwise specified on your purchase order. Refer to the laminate finishes [on page 19](#) for details.

Notes:

Tabletops 72"-96"W are configured in one-piece top.

Tabletops 108"-192"W are configured in two-piece tops.

Tabletops 204"-240"W are configured in three-piece tops.

Boardroom tables with tops comprised of 2 or more pieces will not have a consistent grain pattern.

Options:

laminate color

Code	Price	H	W	D	Volume (ft ³)	Weight (lb)
QMB-MRRX-7236	901	1.5	72	36	2.25	80.37
QMB-MRRX-7242	1128	1.5	72	42	2.63	91.89
QMB-MRRX-8436	1036	1.5	84	36	2.63	95.38
QMB-MRRX-8442	1225	1.5	84	42	3.06	109.4
QMB-MRRX-8448	1306	1.5	84	48	3.5	122.88
QMB-MRRX-9636	1130	1.5	96	36	3	110.38
QMB-MRRX-9642	1325	1.5	96	42	3.5	126.9
QMB-MRRX-9648	1370	1.5	96	48	4	142.89
QMB-MRRX-10848	1642	1.5	108	48	4.5	162.62
QMB-MRRX-10854	1941	1.5	108	54	5.06	180.56
QMB-MRRX-10860	1974	1.5	108	60	5.63	197.96
QMB-MRRX-12048	1794	1.5	120	48	5	182.6
QMB-MRRX-12054	2120	1.5	120	54	5.63	203.06
QMB-MRRX-12060	2153	1.5	120	60	6.25	222.98

Code	Price	H	W	D	Volume (ft ³)	Weight (lb)
QMB-MRRX-13248	1943	1.5	132	48	5.5	202.62
QMB-MRRX-13254	2301	1.5	132	54	6.19	225.58
QMB-MRRX-13260	2335	1.5	132	60	6.88	247.98
QMB-MRRX-14448	2095	1.5	144	48	6	222.64
QMB-MRRX-14454	2483	1.5	144	54	6.75	248.08
QMB-MRRX-14460	2517	1.5	144	60	7.5	273
QMB-MRRX-15648	2250	1.5	156	48	6.5	242.64
QMB-MRRX-15654	2667	1.5	156	54	7.31	270.6
QMB-MRRX-15660	2699	1.5	156	60	8.13	298.02
QMB-MRRX-16848	2633	1.5	168	48	7	262.66
QMB-MRRX-16854	2845	1.5	168	54	7.88	293.1
QMB-MRRX-16860	2879	1.5	168	60	8.75	323.02
QMB-MRRX-18048	2672	1.5	180	48	7.5	282.66
QMB-MRRX-18054	3027	1.5	180	54	8.44	315.62
QMB-MRRX-18060	3063	1.5	180	60	9.38	348.04
QMB-MRRX-19248	2701	1.5	192	48	8	302.66
QMB-MRRX-19254	3211	1.5	192	54	9	338.12
QMB-MRRX-19260	3242	1.5	192	60	10	373.04
QMB-MRRX-20448	2996	1.5	204	48	8.5	322.58
QMB-MRRX-20454	3549	1.5	204	54	9.56	360.53
QMB-MRRX-20460	3598	1.5	204	60	10.63	397.95
QMB-MRRX-21648	3146	1.5	216	48	9	342.59
QMB-MRRX-21654	3729	1.5	216	54	10.13	383.04
QMB-MRRX-21660	3780	1.5	216	60	11.25	422.97
QMB-MRRX-22848	3298	1.5	228	48	9.5	362.59
QMB-MRRX-22854	3912	1.5	228	54	10.69	405.55
QMB-MRRX-22860	3960	1.5	228	60	11.88	447.97
QMB-MRRX-24048	3687	1.5	240	48	10	382.6
QMB-MRRX-24054	4092	1.5	240	54	11.25	428.06
QMB-MRRX-24060	4143	1.5	240	60	12.5	472.98

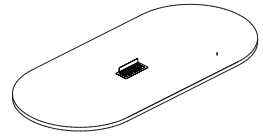

1.5" Racetrack Tabletop w/Power and Data

How to Specify:

Each laminate comes with matching vinyl trim color unless otherwise specified on your purchase order. Refer to the laminate finishes [on page 19](#) for details.

Notes:

Tabletops 72"-96"W are configured in one-piece top.

Tabletops 108"-192"W are configured in two-piece tops.

Tabletops 204"-240"W are configured in three-piece tops.

Single-piece tabletops are equipped with one power and data grommet, two-piece tabletops are equipped with two power and data grommets, and three-piece tabletops are equipped with three power and data grommets.

Two power and dual USB-A receptacles with 3 open slots to accommodate RJ11, RJ45, HDMI, VGA or Stereo. Items for 3 open slots must be specified and purchased separately.

Boardroom tables with tops comprised of 2 or more pieces will not have a consistent grain pattern.

Options:

laminate color

grommet color (for tabletops with power and data)

Code	Price	H	W	D	Volume (ft ³)	Weight (lb)
QMB-MRRP-7236	2144	1.5	72	36	2.25	78.44
QMB-MRRP-7242	2372	1.5	72	42	2.63	89.96
QMB-MRRP-8436	2280	1.5	84	36	2.63	93.45
QMB-MRRP-8442	2470	1.5	84	42	3.06	107.47
QMB-MRRP-8448	2552	1.5	84	48	3.5	120.95
QMB-MRRP-9636	2376	1.5	96	36	3	108.46
QMB-MRRP-9642	2571	1.5	96	42	3.5	124.98
QMB-MRRP-9648	2615	1.5	96	48	4	140.96
QMB-MRRP-10848	4129	1.5	108	48	4.5	158.76
QMB-MRRP-10854	4430	1.5	108	54	5.06	176.7
QMB-MRRP-10860	4464	1.5	108	60	5.63	194.12
QMB-MRRP-12048	4279	1.5	120	48	5	178.76
QMB-MRRP-12054	4610	1.5	120	54	5.63	199.22
QMB-MRRP-12060	4640	1.5	120	60	6.25	219.12

Code	Price	H	W	D	Volume (ft ³)	Weight (lb)
QMB-MRRP-13248	4431	1.5	132	48	5.5	198.78
QMB-MRRP-13254	4789	1.5	132	54	6.19	221.72
QMB-MRRP-13260	4820	1.5	132	60	6.88	244.14
QMB-MRRP-14448	4583	1.5	144	48	6	218.78
QMB-MRRP-14454	4970	1.5	144	54	6.75	244.24
QMB-MRRP-14460	5005	1.5	144	60	7.5	269.14
QMB-MRRP-15648	4735	1.5	156	48	6.5	238.78
QMB-MRRP-15654	5152	1.5	156	54	7.31	266.74
QMB-MRRP-15660	5187	1.5	156	60	8.13	294.16
QMB-MRRP-16848	5124	1.5	168	48	7	258.8
QMB-MRRP-16854	5333	1.5	168	54	7.88	289.24
QMB-MRRP-16860	5367	1.5	168	60	8.75	319.16
QMB-MRRP-18048	5156	1.5	180	48	7.5	278.8
QMB-MRRP-18054	5513	1.5	180	54	8.44	311.76
QMB-MRRP-18060	5548	1.5	180	60	9.38	344.18
QMB-MRRP-19248	5191	1.5	192	48	8	298.82
QMB-MRRP-19254	5696	1.5	192	54	9	334.24
QMB-MRRP-19260	5728	1.5	192	60	10	369.18
QMB-MRRP-20448	6725	1.5	204	48	8.5	320.19
QMB-MRRP-20454	7281	1.5	204	54	9.56	358.15
QMB-MRRP-20460	7330	1.5	204	60	10.63	395.57
QMB-MRRP-21648	6878	1.5	216	48	9	340.2
QMB-MRRP-21654	7462	1.5	216	54	10.13	380.66
QMB-MRRP-21660	7509	1.5	216	60	11.25	420.58
QMB-MRRP-22848	7027	1.5	228	48	9.5	360.21
QMB-MRRP-22854	7642	1.5	228	54	10.69	403.17
QMB-MRRP-22860	7690	1.5	228	60	11.88	445.59
QMB-MRRP-24048	7419	1.5	240	48	10	380.22
QMB-MRRP-24054	7824	1.5	240	54	11.25	425.68
QMB-MRRP-24060	7872	1.5	240	60	12.5	470.6



Union Quick Ship Pricebook
January 2026

Overhead Storage

overhead storage

<u>hinged door hutch</u>	<u>100</u>
<u>wall mounted hinged door hutch</u>	<u>101</u>

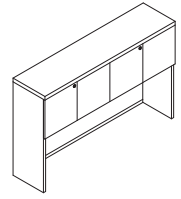

3/4" Hinged-Door Hutch

How to Specify:

Each laminate comes with matching vinyl trim color unless otherwise specified on your purchase order. Refer to the laminate finishes [on page 19](#) for details.

Notes:

Number of Openings and Doors per Hutch										
width(in)	30	36	42	48	54	60	66	72	78	84
openings	1	1	2	2	2	2	2	2	2	2
doors	2	2	3	3	3	4	4	4	4	4

Laminate doors include locks and keys.

Options:

laminate color

Code	Price	H	W	D	Volume (ft ³)	Weight (lb)
QM-SHH0-1530-L	1306	39	30	15	10.16	85.07
QM-SHH0-1536-L	1379	39	36	15	12.19	94.31
QM-SHH0-1542-L	1574	39	42	15	14.22	103.55
QM-SHH0-1548-L	1711	39	48	15	16.25	117.51
QM-SHH0-1554-L	1857	39	54	15	18.28	126.75
QM-SHH0-1560-L	1979	39	60	15	20.31	140.72
QM-SHH0-1566-L	2099	39	66	15	22.34	149.96
QM-SHH0-1572-L	2207	39	72	15	24.38	159.2
QM-SHH0-1578-L	2315	39	78	15	26.41	168.44
QM-SHH0-1584-L	2401	39	84	15	28.44	177.68

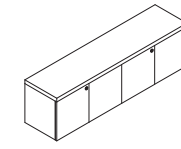

3/4" Wall-Mounted Hinged-Door Hutch

How to Specify:

Each laminate comes with matching vinyl trim color unless otherwise specified on your purchase order. Refer to the laminate finishes [on page 19](#) for details.

Notes:

Number of Openings and Doors per Hutch								
width(in)	30	36	42	48	54	60	66	72
openings	1	1	2	2	2	2	2	2
doors	2	2	3	3	3	4	4	4

Laminate doors include locks and keys.

Install wall-mounted overheads directly onto permanent studs. Please refer to installation instructions.

Options:

laminate color

Code	Price	H	W	D	Volume (ft ³)	Weight (lb)
QM-SHHW-1530-L	933	17	30	15	4.43	46.9
QM-SHHW-1536-L	990	17	36	15	5.31	52.99
QM-SHHW-1542-L	1105	17	42	15	6.2	59.08
QM-SHHW-1548-L	1164	17	48	15	7.08	65.17
QM-SHHW-1554-L	1219	17	54	15	7.97	71.26
QM-SHHW-1560-L	1332	17	60	15	8.85	77.35
QM-SHHW-1566-L	1389	17	66	15	9.74	83.44
QM-SHHW-1572-L	1446	17	72	15	10.63	89.53



Union Quick Ship Pricebook
January 2026

Bases

bases

<u>gable & modesty base</u>	104
<u>for straight tabletop</u>	104
<u>for racetrack top</u>	106
<u>elliptical base</u>	108
<u>for straight tabletop</u>	108
<u>for racetrack top</u>	110

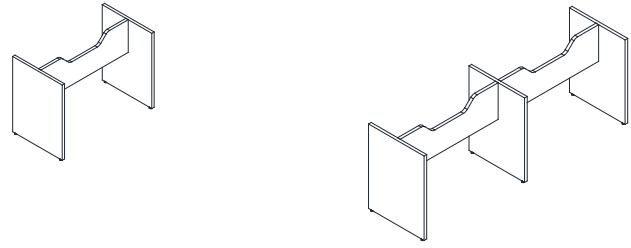

Notes:

Match table base size to table top size.

Options:

laminate color

for Straight/Boat Tabletops

Code	Price	H	W	D	Volume (ft ³)	Weight (lb)
QMB-B4-7236	611	28	36	21	12.25	41.45
QMB-B4-7242	611	28	42	24	16.33	52.15
QMB-B4-8436	611	28	36	21	12.25	44.55
QMB-B4-8442	627	28	42	24	16.33	55.89
QMB-B4-8448	685	28	48	84	65.33	51.53
QMB-B4-9636	627	28	36	96	56	43.54
QMB-B4-9642	662	28	42	96	65.33	47.38
QMB-B4-9648	741	28	48	30	23.33	63.75
QMB-B4-10848	1046	28	48	30	23.33	67.75
QMB-B4-10854	1150	28	54	108	94.5	88.49
QMB-B4-10860	1250	28	60	108	105	100
QMB-B4-12048	1089	28	48	120	93.33	71.99
QMB-B4-12054	1195	28	54	120	105	91.82
QMB-B4-12060	1296	28	60	120	116.67	103.34
QMB-B4-13248	1134	28	48	30	23.33	76.23
QMB-B4-13254	1238	28	54	132	115.5	95.16
QMB-B4-13260	1335	28	60	132	128.33	106.67
QMB-B4-14448	1185	28	48	30	23.33	80.47

Code	Price	H	W	D	Volume (ft ³)	Weight (lb)
QMB-B4-14454	1289	28	54	144	126	98.88
QMB-B4-14460	1389	28	60	144	140	110.4
QMB-B4-15648	1230	28	48	156	121.33	90.7
QMB-B4-15654	1331	28	54	156	136.5	102.22
QMB-B4-15660	1432	28	60	156	151.67	113.73
QMB-B4-16848	1272	28	48	168	130.67	94.04
QMB-B4-16854	1376	28	54	168	147	105.55
QMB-B4-16860	1475	28	60	168	163.33	117.07
QMB-B4-18048	1316	28	48	180	140	97.37
QMB-B4-18054	1421	28	60	180	175	108.98
QMB-B4-18060	1522	28	60	180	175	120.4
QMB-B4-19248	1360	28	48	192	149.33	100.71
QMB-B4-19254	1465	28	54	192	168	112.22
QMB-B4-19260	1565	28	60	192	186.67	123.74
QMB-B4-20448	1666	28	48	204	158.67	122.06
QMB-B4-20454	1806	28	54	204	178.5	137.42
QMB-B4-20460	1937	28	60	204	198.33	152.77
QMB-B4-21648	1715	28	48	216	168	125.79
QMB-B4-21654	1855	28	54	216	189	141.14
QMB-B4-21660	1984	28	60	216	210	156.5
QMB-B4-22848	1763	28	48	228	177.33	129.13
QMB-B4-22854	1899	28	54	228	199.5	144.48
QMB-B4-22860	2030	28	60	228	221.67	159.84
QMB-B4-24048	1805	28	48	228	177.33	132.46
QMB-B4-24054	1943	28	54	240	210	147.81
QMB-B4-24060	2075	28	60	240	233.33	163.17

for Racetrack Top						
Code	Price	H	W	D	Volume (ft ³)	Weight (lb)
QMB-B4-8448R	668	28	48	84	1.24	50.41
QMB-B4-9648R	717	28	48	96	74.67	53.95
QMB-B4-10848R	1031	28	48	108	84	75.86
QMB-B4-10854R	1121	28	54	108	94.5	86.26
QMB-B4-10860R	1207	28	60	108	105	96.67
QMB-B4-12048R	1074	28	48	120	93.33	79.19
QMB-B4-12054R	1163	28	54	120	105	89.6
QMB-B4-12060R	1250	28	60	120	116.67	100
QMB-B4-13248R	1121	28	48	132	102.67	82.53
QMB-B4-13254R	1208	28	54	132	115.5	92.93
QMB-B4-13260R	1296	28	60	132	128.33	103.34
QMB-B4-14448R	1168	28	48	144	112	86.26
QMB-B4-14454R	1257	28	54	144	126	96.66
QMB-B4-14460R	1341	28	60	144	140	106.67
QMB-B4-15648R	1210	28	48	156	121.33	89.59
QMB-B4-15654R	1301	28	54	156	136.5	99.99
QMB-B4-15660R	1389	28	60	156	151.67	110.4
QMB-B4-16848R	1257	28	48	168	130.67	92.92
QMB-B4-16854R	1345	28	54	168	147	103.33
QMB-B4-16860R	1432	28	60	168	163.33	113.73
QMB-B4-18048R	1301	28	48	180	140	96.26
QMB-B4-18054R	1391	28	54	180	157.5	106.66

Code	Price	H	W	D	Volume (ft ³)	Weight (lb)
QMB-B4-18060R	1475	28	60	180	175	117.07
QMB-B4-19248R	1344	28	48	192	149.33	99.59
QMB-B4-19254R	1433	28	54	192	168	110
QMB-B4-19260R	1522	28	60	192	186.67	120.4
QMB-B4-20448R	1649	28	48	204	158.67	120.97
QMB-B4-20454R	1776	28	54	204	178.5	135.19
QMB-B4-20460R	1890	28	60	204	198.33	149.44
QMB-B4-21648R	1698	28	48	216	168	124.68
QMB-B4-21654R	1822	28	54	216	189	138.92
QMB-B4-21660R	1940	28	60	216	210	152.77
QMB-B4-22848R	1742	28	48	228	177.33	128.01
QMB-B4-22854R	1869	28	54	228	199.5	142.26
QMB-B4-22860R	1984	28	60	228	221.67	156.5
QMB-B4-24048R	1789	28	48	240	186.67	131.35
QMB-B4-24054R	1914	28	54	240	210	145.59
QMB-B4-24060R	2030	28	60	240	233.33	159.83

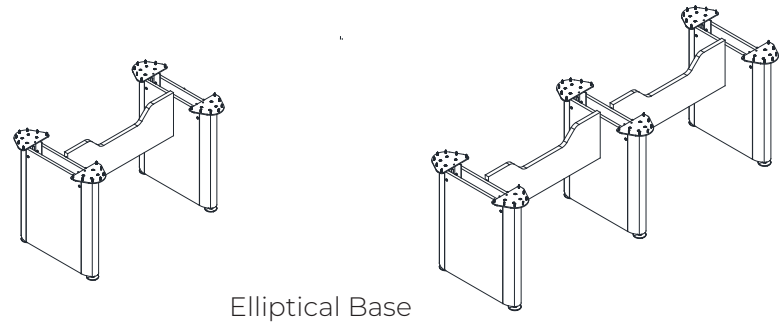

Elliptical Base

Notes:

Match table base size to table top size.

Options:

laminate color

metal color

for Straight/Boat Tabletops

Code	Price	H	W	D	Volume (ft ³)	Weight (lb)
QMB-B5-7236	1612	28	36	72	42	57.58
QMB-B5-7242	1669	28	42	72	49	63
QMB-B5-8436	1651	28	36	84	49	60.91
QMB-B5-8442	1710	28	42	84	57.17	66.33
QMB-B5-8448	1807	28	48	84	65.33	71.75
QMB-B5-9636	1696	28	36	96	56	64.45
QMB-B5-9642	1752	28	42	96	65.33	69.86
QMB-B5-9648	1850	28	48	96	74.67	75.3
QMB-B5-10848	2720	28	48	30	23.33	106.9
QMB-B5-10854	2823	28	54	108	94.5	123.15
QMB-B5-10860	2986	28	60	108	105	139.41
QMB-B5-12048	2762	28	48	120	93.33	110.23
QMB-B5-12054	2863	28	54	120	105	126.49

Code	Price	H	W	D	Volume (ft ³)	Weight (lb)
QMB-B5-12060	3027	28	60	120	116.67	142.75
QMB-B5-13248	2802	28	48	132	102.67	113.57
QMB-B5-13254	2904	28	54	132	115.5	129.82
QMB-B5-13260	3067	28	60	132	128.33	146.08
QMB-B5-14448	2850	28	48	144	112	117.29
QMB-B5-14454	2950	28	54	144	126	133.55
QMB-B5-14460	3113	28	60	144	140	149.81
QMB-B5-15648	2892	28	48	156	121.33	120.63
QMB-B5-15654	2992	28	54	156	136.5	136.88
QMB-B5-15660	3157	28	60	156	151.67	153.14
QMB-B5-16848	2927	28	48	168	130.67	123.96
QMB-B5-16854	3028	28	54	168	147	140.22
QMB-B5-16860	3190	28	60	168	163.33	156.48
QMB-B5-18048	2974	28	48	180	140	127.3
QMB-B5-18054	3072	28	54	180	157.5	143.55
QMB-B5-18060	3239	28	60	180	175	159.81
QMB-B5-19248	3013	28	48	192	149.33	130.63
QMB-B5-19254	3113	28	54	192	168	146.89
QMB-B5-19260	3281	28	60	192	186.67	163.15
QMB-B5-20448	4571	28	48	204	158.67	161.69
QMB-B5-20454	4709	28	54	204	178.5	183.37
QMB-B5-20460	4928	28	60	204	198.33	205.04

for Racetrack Tabletop						
Code	Price	H	W	D	Volume (ft ³)	Weight (lb)
QMB-B5-8448R	1794	28	48	84	65.33	70.64
QMB-B5-9648R	1838	28	48	96	74.67	74.17
QMB-B5-10848R	2708	28	48	108	84	105.79
QMB-B5-10854R	2794	28	54	108	94.5	120.93
QMB-B5-10860R	2942	28	60	108	105	136.08
QMB-B5-12048R	2751	28	48	120	93.33	109.12
QMB-B5-12054R	2836	28	54	120	105	124.27
QMB-B5-12060R	2986	28	60	120	116.67	139.41
QMB-B5-13248R	2791	28	48	132	102.67	112.45
QMB-B5-13254R	2877	28	54	132	115.5	127.6
QMB-B5-13260R	3027	28	60	132	128.33	142.75
QMB-B5-14448R	2730	28	48	144	112	116.18
QMB-B5-14454R	2830	28	54	144	126	130.93
QMB-B5-14460R	3067	28	60	144	140	146.08
QMB-B5-15648R	2878	28	48	156	121.33	119.52
QMB-B5-15654R	2963	28	54	156	136.5	134.66
QMB-B5-15660R	3113	28	60	156	151.67	149.81
QMB-B5-16848R	2919	28	48	168	130.67	122.85
QMB-B5-16854R	3004	28	54	168	147	138
QMB-B5-16860R	3157	28	60	168	163.33	153.14
QMB-B5-18048R	2960	28	48	180	140	126.19
QMB-B5-18054R	3043	28	54	180	157.5	141.33
QMB-B5-18060R	3190	28	60	180	175	156.48
QMB-B5-19248R	3001	28	48	192	149.33	129.52
QMB-B5-19254R	3086	28	54	192	168	144.67

Code	Price	H	W	D	Volume (ft ³)	Weight (lb)
QMB-B5-19260R	3239	28	60	192	186.67	159.81
QMB-B5-20448R	4554	28	48	204	158.67	160.58
QMB-B5-20454R	4665	28	54	204	178.5	181.14
QMB-B5-20460R	4865	28	60	204	198.33	201.71
QMB-B5-21648R	4466	28	48	216	168	164.31
QMB-B5-21654R	4603	28	54	216	189	184.48
QMB-B5-21660R	4931	28	60	216	210	205.04
QMB-B5-22848R	4684	28	48	228	177.33	167.64
QMB-B5-22854R	4793	28	54	228	199.5	188.2
QMB-B5-22860R	4991	28	60	228	221.67	208.77
QMB-B5-24048R	4743	28	48	240	186.67	170.97
QMB-B5-24054R	4858	28	54	240	210	191.54
QMB-B5-24060R	5054	28	60	240	233.33	212.1



Union Quick Ship Pricebook
January 2026

Accessories

accessories

<u>keyboard tray</u>	114
<u>PET tackboard for hutch</u>	115
<u>pencil drawer</u>	116
<u>task light</u>	117
<u>monitor arm</u>	118
<u>ellora grommet add-ons</u>	119

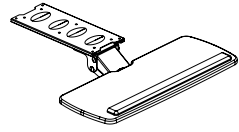

Articulating Keyboard Tray

What's Included:

Keyboard Tray, installation hardware.

How to Specify:

The articulating keyboards are available only in black.

Notes:

Keyboard trays provide adjustable ergonomic support for individuals in multi-task environments

Code	Price	H	W	D	Volume (ft ³)	Weight (lb)
Articulating Keyboard Tray						
V-KASX-2510	459	0	25	10	0	15

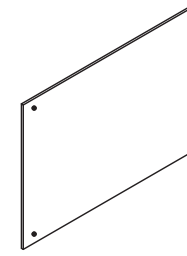

21"H Tackboard for Hutch

Options:

P.E.T. color (for tackboard)

Code	Price	H	W	D	Volume (ft ³)	Weight (lb)
21"H PET Tackboard for Hutch						
Q-ATH0-2127	342	21	27	0.5	0.16	2.7
Q-ATH0-2133	353	21	33	0.5	0.2	3.1
Q-ATH0-2139	457	21	39	0.5	0.24	3.5
Q-ATH0-2145	477	21	45	0.5	0.27	3.9
Q-ATH0-2151	677	21	51	0.5	0.31	4.3
Q-ATH0-2157	682	21	57	0.5	0.35	4.7
Q-ATH0-2163	689	21	63	0.5	0.38	5.1
Q-ATH0-2169	694	21	69	0.5	0.42	5.5
Q-ATH0-2175	812	21	75	0.5	0.46	5.9
Q-ATH0-2181	818	21	81	0.5	0.49	6.3

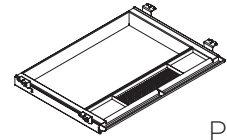

Plastic Pencil Drawer

Notes:

Plastic Pencil Drawers are available in black only.

Code	Price	H	W	D	Volume (ft ³)	Weight (lb)
V-ADPP	100	2.8	21	16	0.62	2

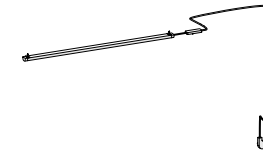

Task Light

Notes:

Task light comes in silver finish.

V-ELU-3666 fits under hutches between 36" and 66"W

V-ELU-7284 fits under hutches between 72"-84"W

Code	Price	H	W	D	Volume (ft ³)	Weight (lb)
V-ELU-3666	481	17	36.39	15	4.43	13.7
V-ELU-7284	891	17	48.15	15	-	17.9

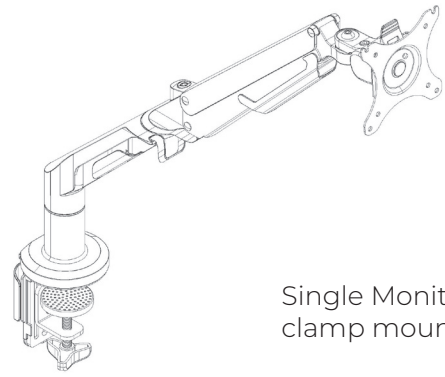

Single Monitor Arm - clamp mount

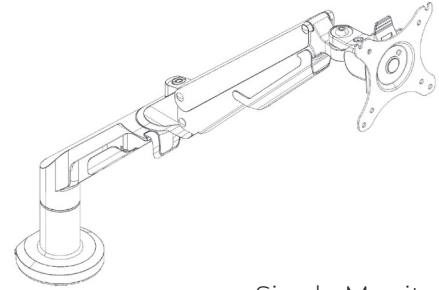

Single Monitor Arm - grommet mount

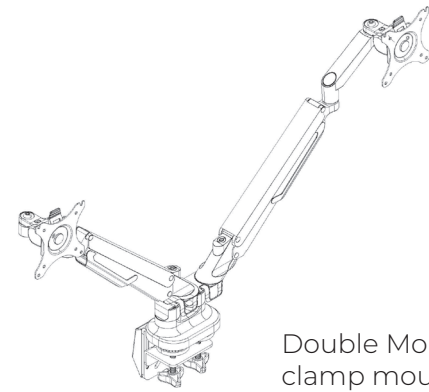

Double Monitor Arm - clamp mount

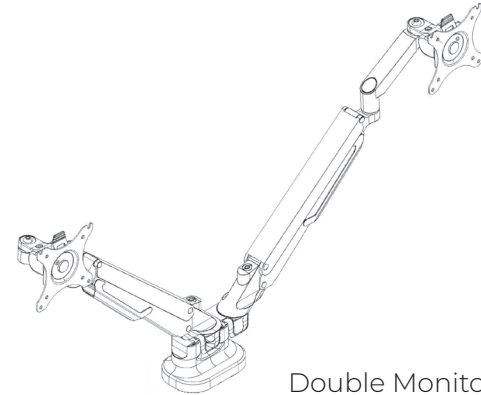

Double Monitor Arm - grommet mount

What's Included:

One monitor arm and installation hardware for both clamp and grommet mount

How to Specify:

- Specify type

Dimensions:

Vesa: 75x75 and 100x100

Notes:

Available in silver only

Single Monitor Arm

- Screen Size - 17"-36"
- Load Capacity - 6.6-26.4lbs/3-12kg
- Tilt Range - -90 degrees - -15 degrees

Dual Monitor Arm

- Screen Size - 17"-32"
- Load Capacity - 4.4-19.8lbs/2-9kg
- Tilt Range - -90 degrees - -15 degrees



QM-RJ45

RJ45 Cat6 Plug With Cord 72", Black



QM-HDMI

HDMI Coupler, 18" Cord, Female/Female Connection, Black

Code	Price
Monitor Arm - Single Mount	
V-AFMA-01	426
Monitor Arm - Double Mount	
V-AFMA-02	711

Code	Price
QM-RJ45	230
QM-HDMI	223