



Switch USA Pricebook January 2026

Contents

Statement of Line	vi
Space Division	vi
Worksurface & Supports	viii
Connections & Trims	x
Storage	xi
Electrics	xii
Accessories	xii
Segment Types	xiii
Caution	xiv
Application Guidelines	xv
Types of Surfaces	xv
Gallery Panel Planning	xvi
Application Guidelines	xvi
Connection Types - Panel Doors	xvii
Connection Types - Sliding Doors	xviii
Connection Types - Fillers	xix
Wire Play Planning	xxi
Panels	3
Standard Panel - Monolithic	4
Non Powered Capable	4
Powered Capable	8
Standard - Glazed	12
Non Powered	12
Powered	28
Elevated - Monolithic	44
Elevated - Glazed	48
Gallery - Woodgrain	64
Horizontal Grain	64
Vertical Grain	76
Gallery - Solid	88
Frameless Blade	100
Standard & Elevated Panel Mounted Glass	100
Standard & Elevated Panel Mounted Acrylic	102

Gallery Panel Mounted Glass	104
Gallery Panel Mounted Acrylic	106
Panel Mounted Add Ons	108
Whiteboard	108
Tackboard	109
Doors	110
Hinged	110
Sliding	112
Connections & Trims	117
2-Way Connection	118
3-Way T Connection	119
4-Way X Connection	120
Top Cap	121
Full Height End Trim	122
Partial Height End Trim	123
Full Height T Filler	124
Partial Height T Filler	125
90 Degree Filler-Full Height	126
90 Degree Filler- Partial Height	127
Straight Filler	128
Gallery Panel FillerConnections and Trims	129
Adjustable Wall Connector	130
Worksurfaces	133
Straight w grommet	134
Straight Worksurface w/o Grommet	136
Straight Worksurface w/ Wire Play	140
5-sided w Grommet	144
Straight Worksurface with Wire Play	146
Unitized w/ Grommet	148
Unitized w/ Wire Play	150
Transaction Top	152

Supports	155
Ladder Gable	156
Standard Panel	156
Gallery Panel	158
Freestanding Panel	160
Laminate Gable	161
Standard Panel	161
Gallery Panel	162
Freestanding	163
Worksurface Supports	164
Standard Panel	164
Gallery Panel	165
Tech Drop	166
Cantilever	167
Standard Panel	167
Gallery Panel	168
Standard Panel Mount Corner Bracket	170
Worksurface Supports	171
Storage	172
Fixed Credenza Support Bracket	173
90 Degree Storage Bracket	174
Horizontal Surface Support	175
Electrics	177
Power Module	178
Starter Harness	179
Connector Harness	180
Male to Female Extension Harness	182
New York Junction Box	183
Chicago Electrical Box	184
Power Pole	185
Communication Kit	186
Conversion Kit	187

Storage	189
Pedestals	190
Underdesk Pedestal	190
Mobile	191
Upholstered Seat Pad	192
Lateral File	193
Underdesk	193
Freestanding	194
Credenza	195
Open Lateral	195
Storage Tower	196
Wardrobe Tower	197
Combo Tower	198
w/ Front Access	198
w/ Side Access	200
Panel Mounted Overheads - Cabinet	202
Flipper	202
Hinged Door	203
Shared	204
Cubby	206
Metal Shelf	207
Accessories	209
Desktop Power Module	210
Tasklight	211
Monitor Arm	212
Keyboard Tray	213
Work Organizers	214
Accessory Rail	215
Pencil Tray	216

Statement of Line

Space Division

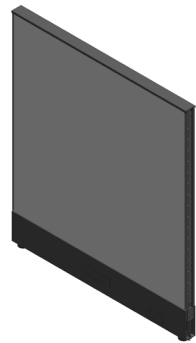

L-PPFO
Standard Fabric Panel
H: 34", 42", 50", 66", 82"
W: 24" - 72"
*66"H available up to 60"W
*82"H available up to 48"W



L-PPLO
Standard Laminate Panel
H: 34", 42", 50", 66", 82"
W: 24" - 48"
*82"H available up to 36"W



L-PPFCA/LPPFCG
L-PPFFA/L-PPFFG
Standard Segmented Fabric Panel
H: 34", 42", 50", 66", 82"
W: 24" - 60"
*82"H available up to 48"W



L-PPLCA/LPPLCG
L-PPLFA/L-PPLFG
Standard Segmented Laminate Panel
H: 34", 42", 50", 66", 82"
W: 24" - 60"
*82"H available up to 36"W



L-PYSE-S1/ L-PYSM-S1
Solid Single Gallery Panel
H: 34", 42", 50"
W: 26" - 74"

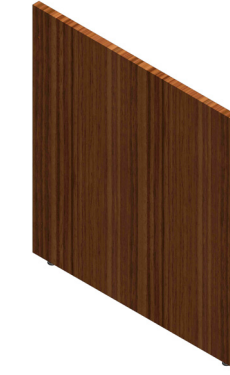

L-PYGE-S1/L-PYSM-S1
Woodgrain Single Gallery Panel
H: 34", 42", 50"
W: 26" - 56"



L-PD00
Hinge Door
H: 82"
W: 36", 42"



L-PDS
Sliding Door
H: 66"
W: 30", 36", 42"

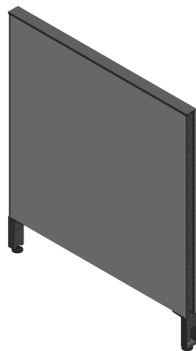

L-PEFO
Elevated Fabric Panel
H: 34", 42", 50", 66", 82"
W: 24" - 72"
*66"H available up to 60"W
*82"H available up to 48"W



L-PELO
Elevated Laminate Panel
H: 34", 42", 50", 66", 82"
W: 24" - 48"
*82"H available up to 36"W



L-PEFCA/LPEFCG
L-PEFFA/L-PEFFG
Elevated Glazed Fabric Panel
H: 34", 42", 50", 66", 82"
W: 24" - 60"
*82"H available up to 48"W



L-PELCA/LPELCG
L-PELFA/L-PELFG
Elevated Glazed Laminate Panel
H: 34", 42", 50", 66", 82"
W: 24" - 60"
*82"H available up to 36"W

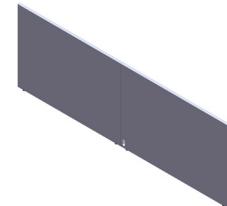

L-PYSE-D1/D2/ L-PYSM-D1/D2
Solid Double Gallery Panel
H: 34", 42", 50"
W: 42" - 146"



L-PYGE-01/02/ L-PYGM-D1/D2
Woodgrain Double Gallery Panel
H: 34", 42", 50"
W: 42" - 110"

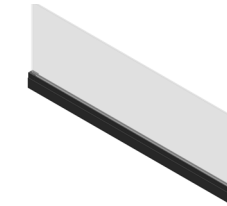

L-VG-P/ L-VA-P
Frameless Glass Standard Panel Mount
H: 8", 16", 20"
W: 24" - 72"

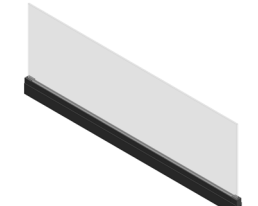

L-VG-Y/ L-VA-Y
Frameless Glass Gallery Panel Mount
H: 8", 16"
W: 24" - 60"

Worksurface & Supports

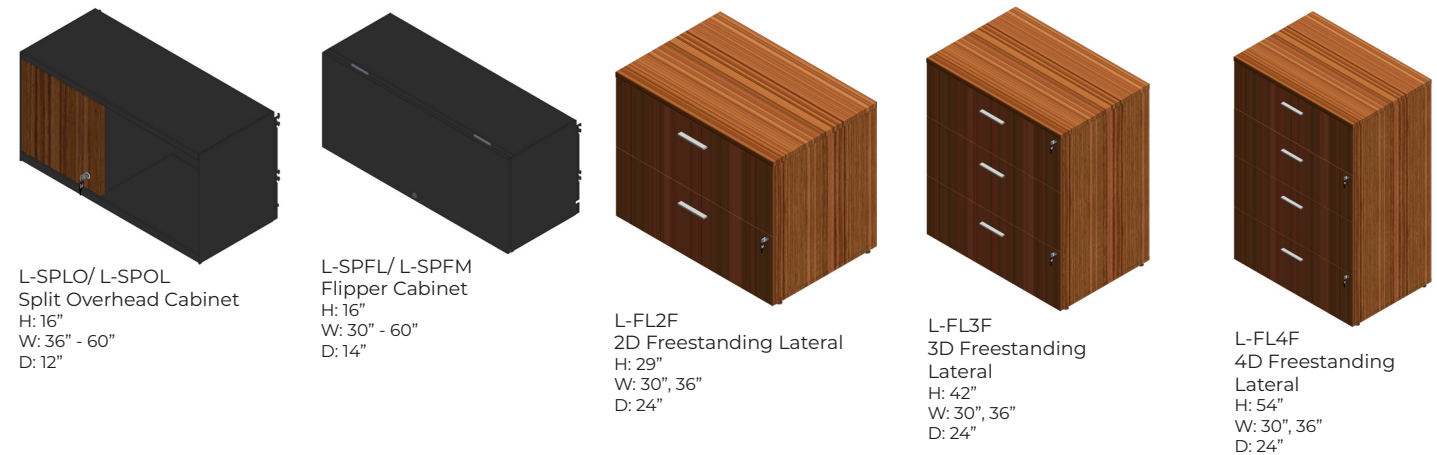
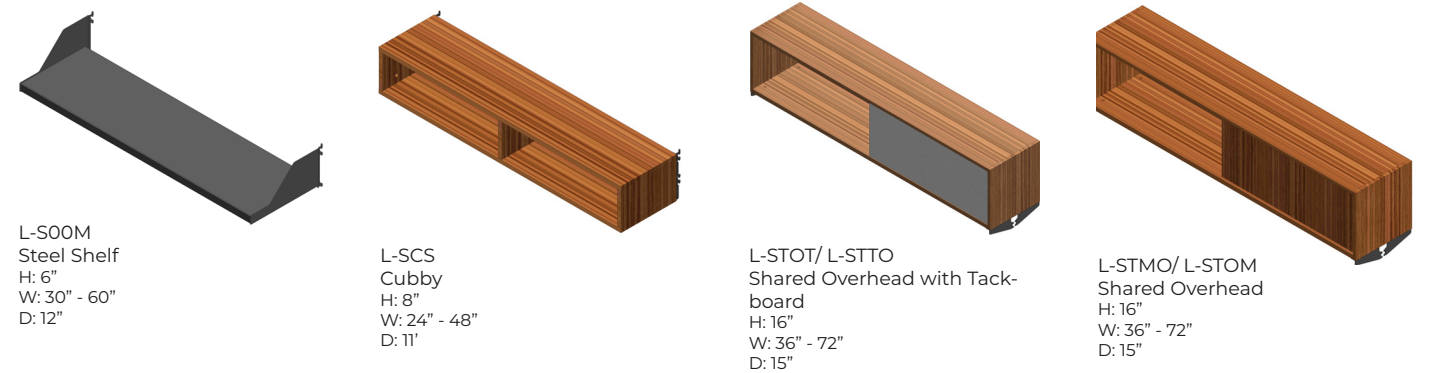
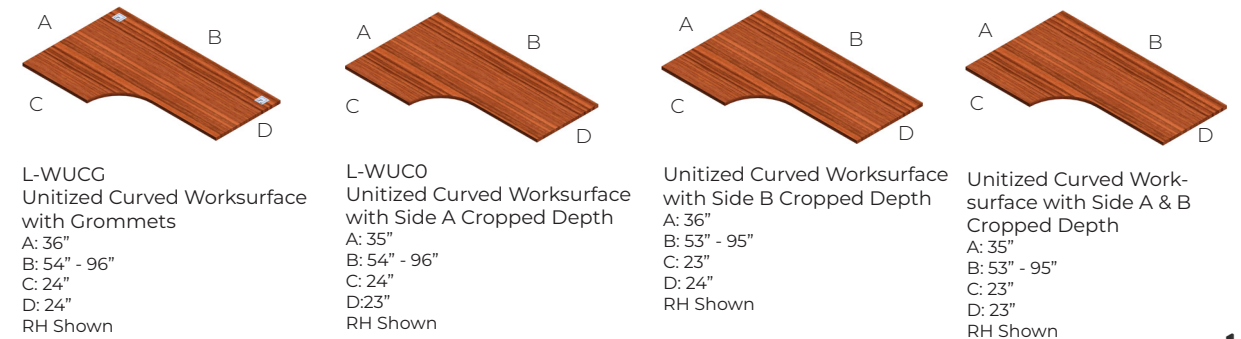
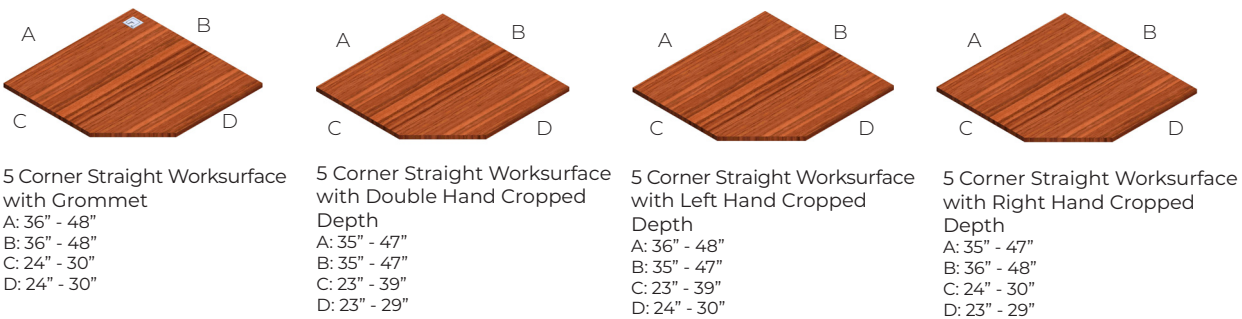
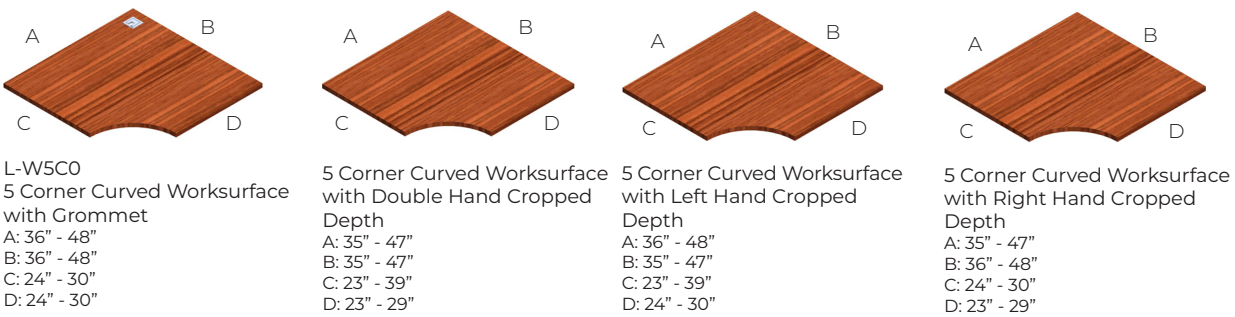

Connections & Trims

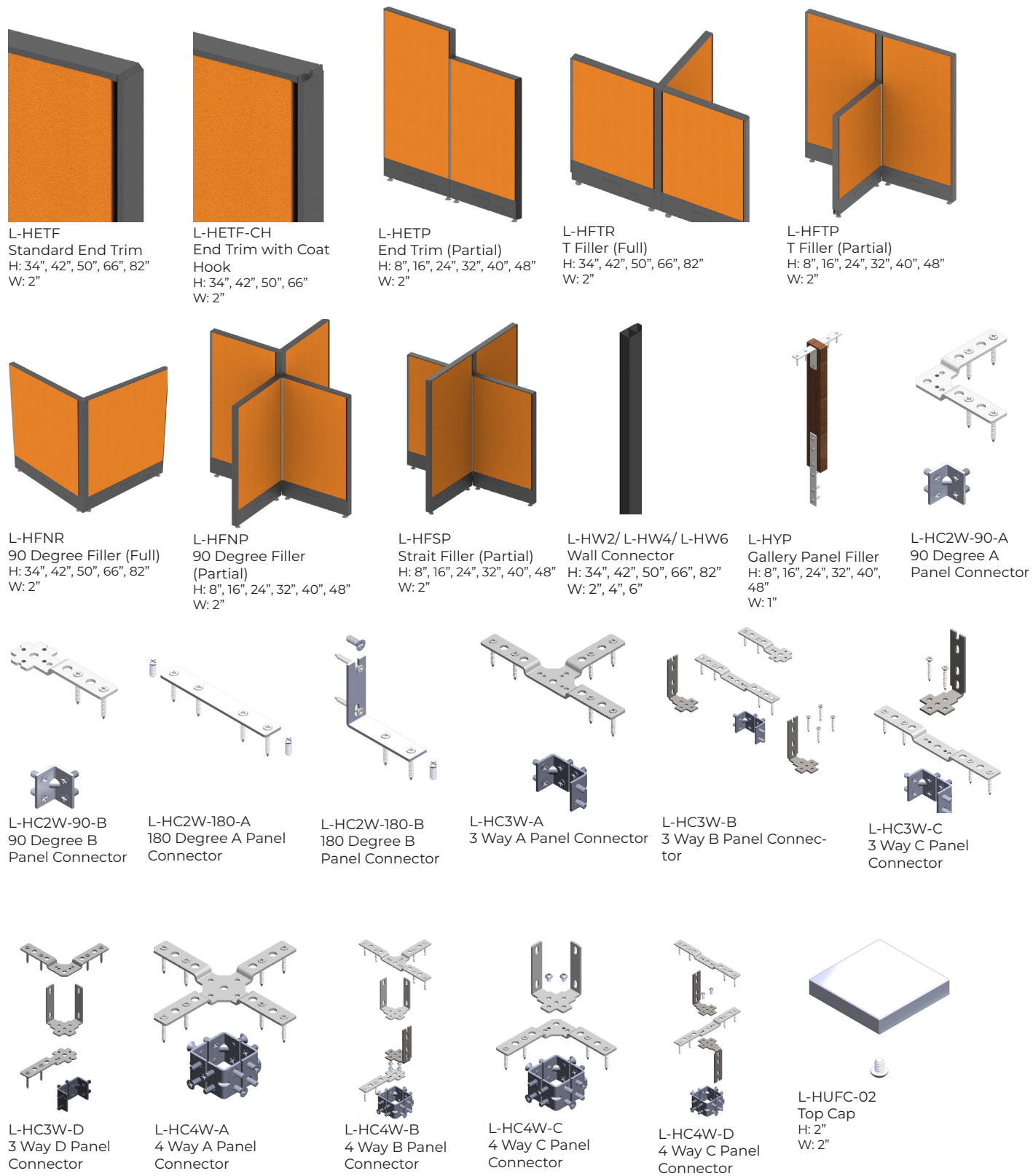

Storage

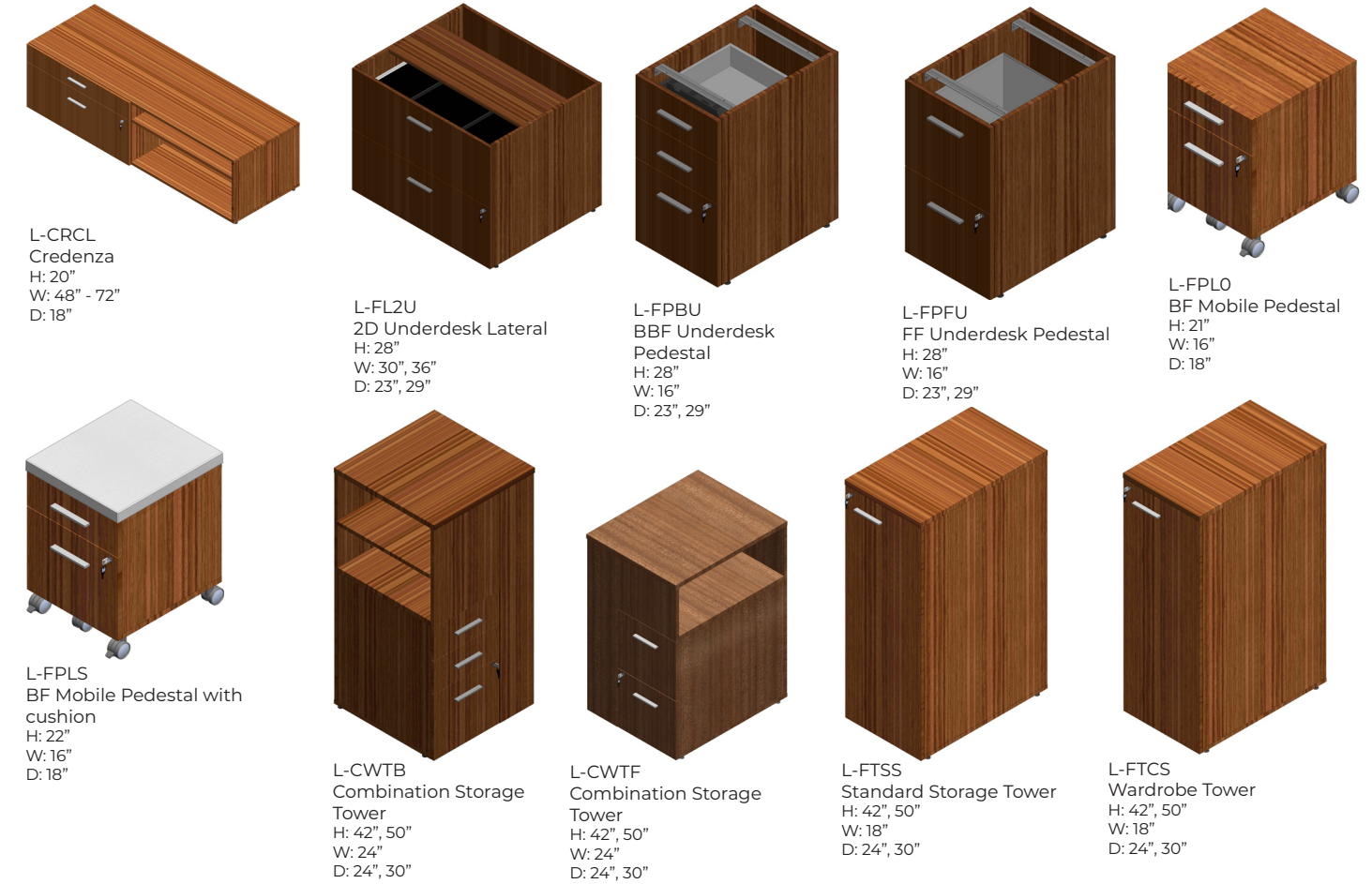

Electrics



Accessories

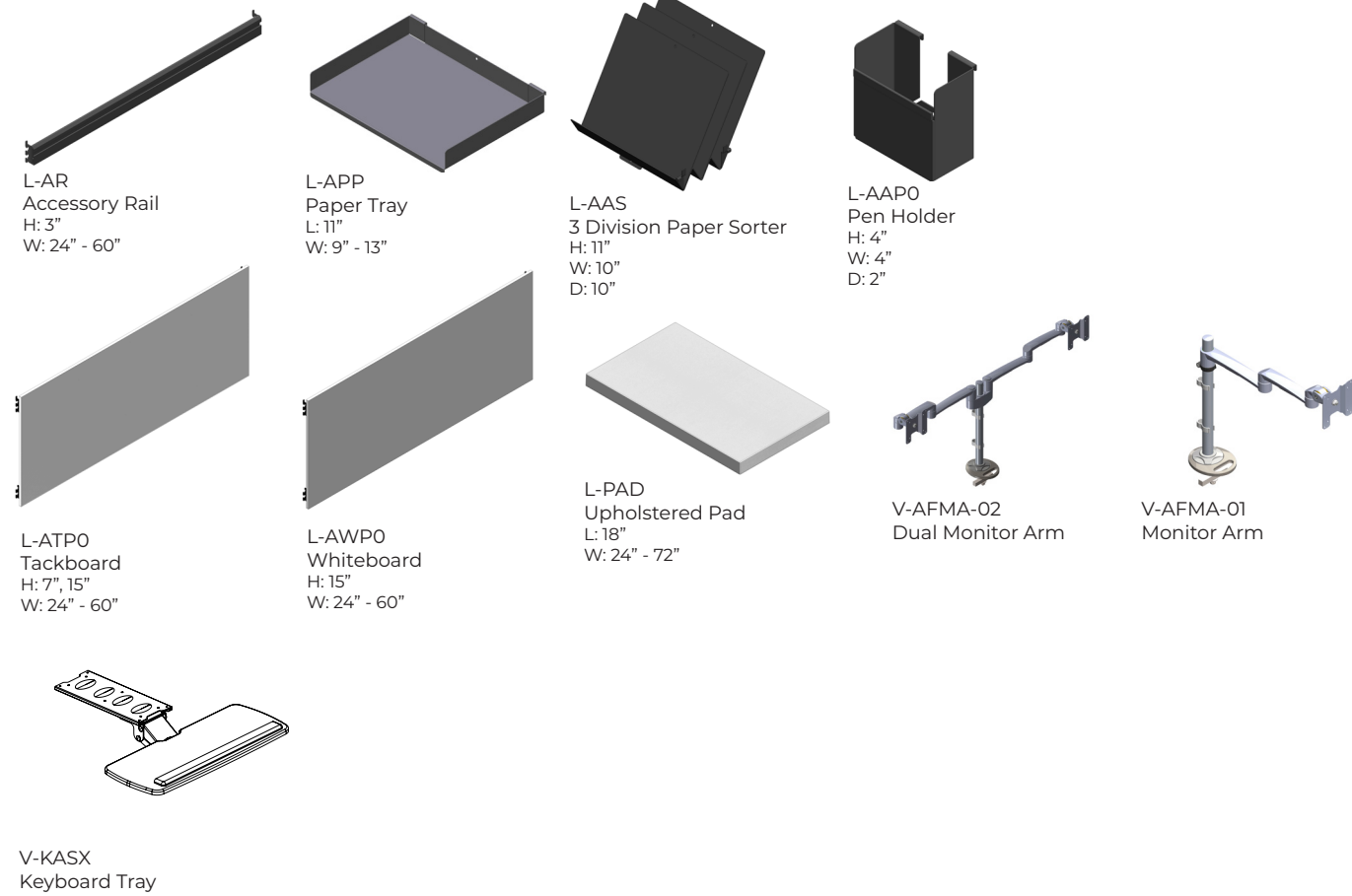

Segment Types

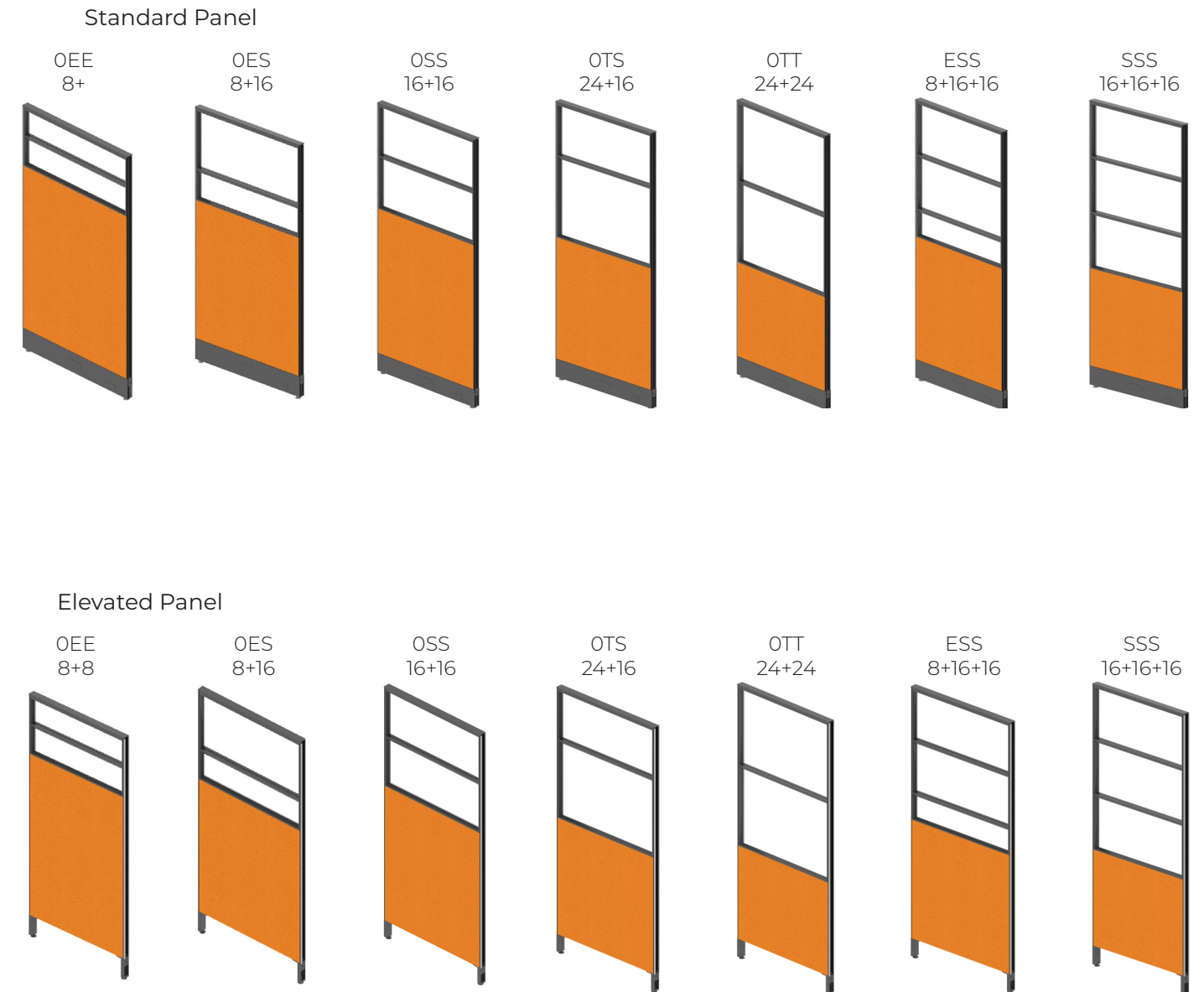

Caution

Load Bottom Drawer First

- Operate one drawer at a time
- Units may tip if loaded incorrectly
- Units should be attached to a wall or other furniture to reduce tipping hazard
- Always load the heaviest files in the bottom drawer

Heavy Load

- Some products must be anchored to wall to ensure stability & safety.
- It is the owner and installers responsibility to ensure that the wall type and construction is of sufficient strength to carry the loads of any wall mounted products and their contents.
- Failure of the wall and anchors to support all imposed loads may result in property damage and/or personal injury.
- Tayco can provide size and empty weight of its products only. As wall blocking is considered a building construction process, Tayco cannot provide recommendations in this respect and cannot be responsible for damage or injury that may occur as a result of improper installation and/or blocking.

Instability Hazard

Mobile items on casters such as flip top, personal and movable tables of any type and storage items of any type may present an instability hazard if not secured correctly while in use or in storage. Flip top tables or training tables of any type, are inherently more unstable when folded. Tayco provides the following guidelines & warnings when using mobile products:

- Lock casters immediately after moving. Do not leave the casters unlocked when in use or in storage.
- Motion may increase the instability of any item with casters. If the wheels hit an obstruction the table's forward momentum often causes overturn, especially if the item is not equipped with wheel extensions. Exercise strong caution while moving these items.
- Use caution when abrupt level changes in the floor are present (such as a doorway or room threshold) as caster failure or tipping may result.
- Do not stand, sit or lean on mobile items for support. They are not intended for this use and personal injury or property damage may result.
- Mobile units that feature height adjustable elements must be lowered to the minimum compressed height when moving to prevent instability. It is also recommended the user remove all computer equipment or other accessories to prevent possible weight imbalance or damage to equipment.
- Failure to follow the guidelines above may result in property damage or personal injury.

Application Guidelines

Types of Surfaces

no grommet

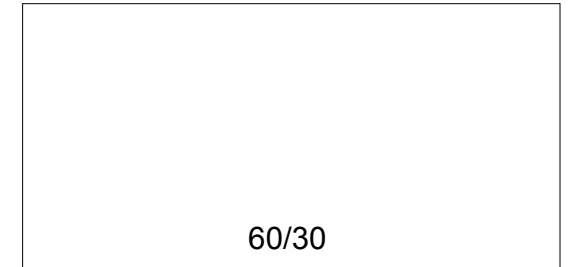
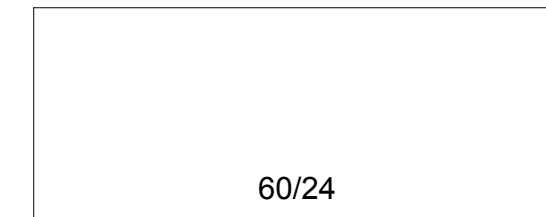

with grommet

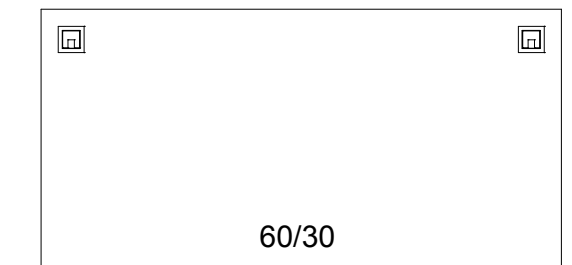
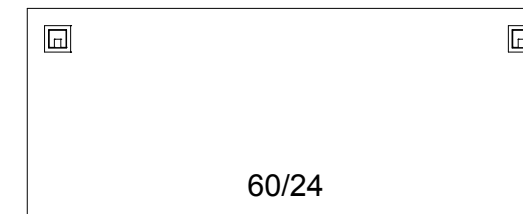

wireplay

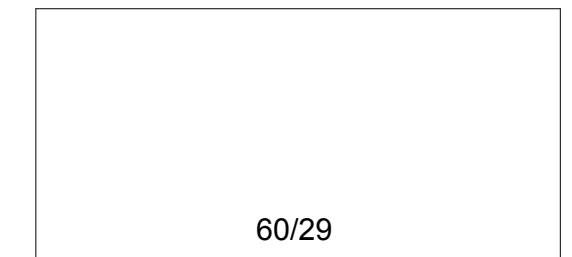
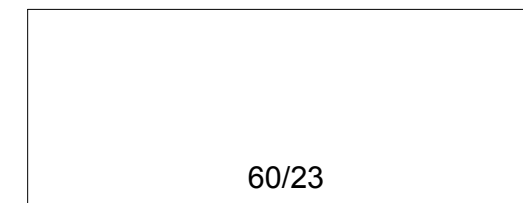

Gallery Panel Planning

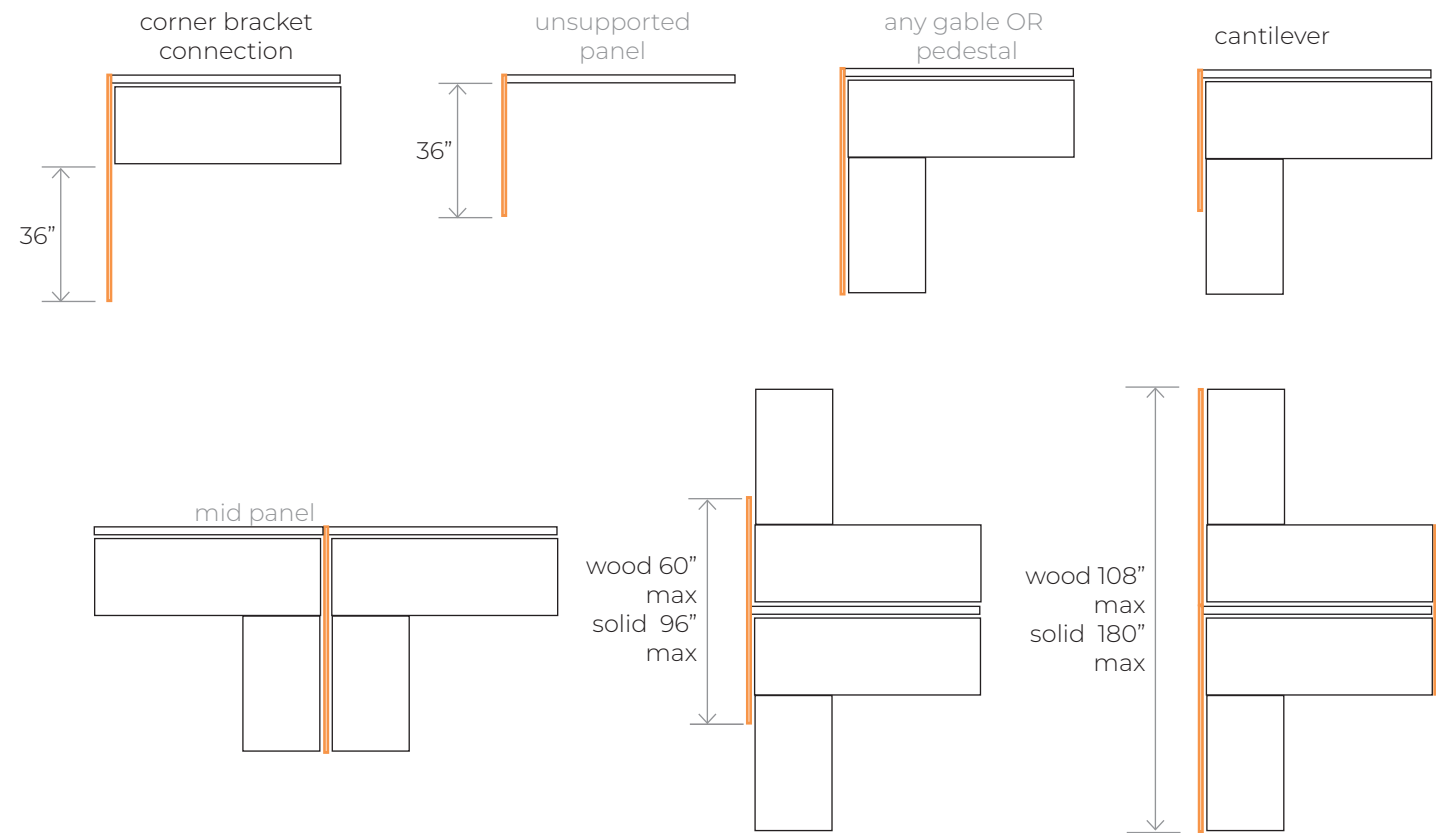

Connection Types - Panel Doors

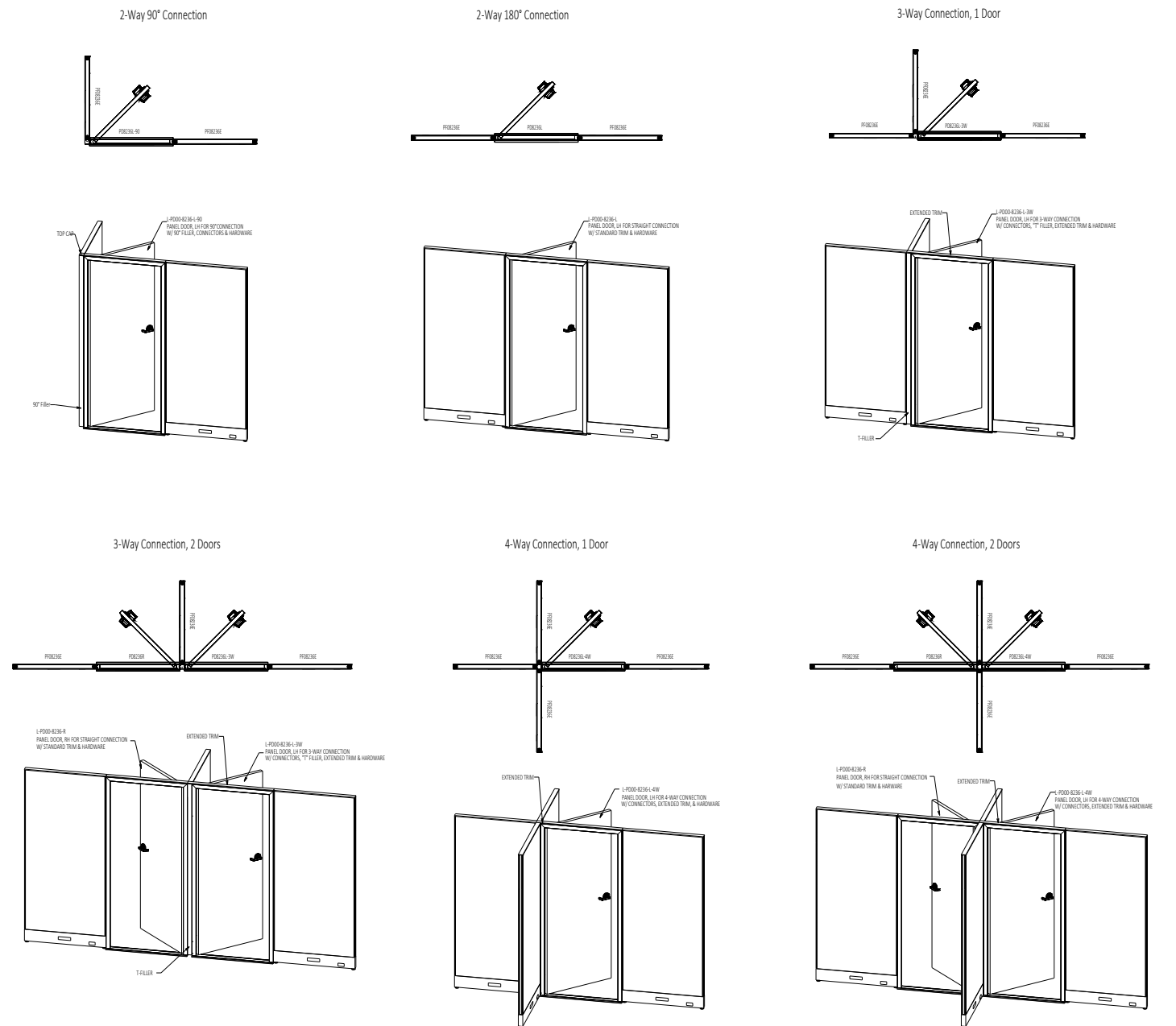

Connection Types - Sliding Doors

2-Way 90° Connection

2-Way 180° Connection

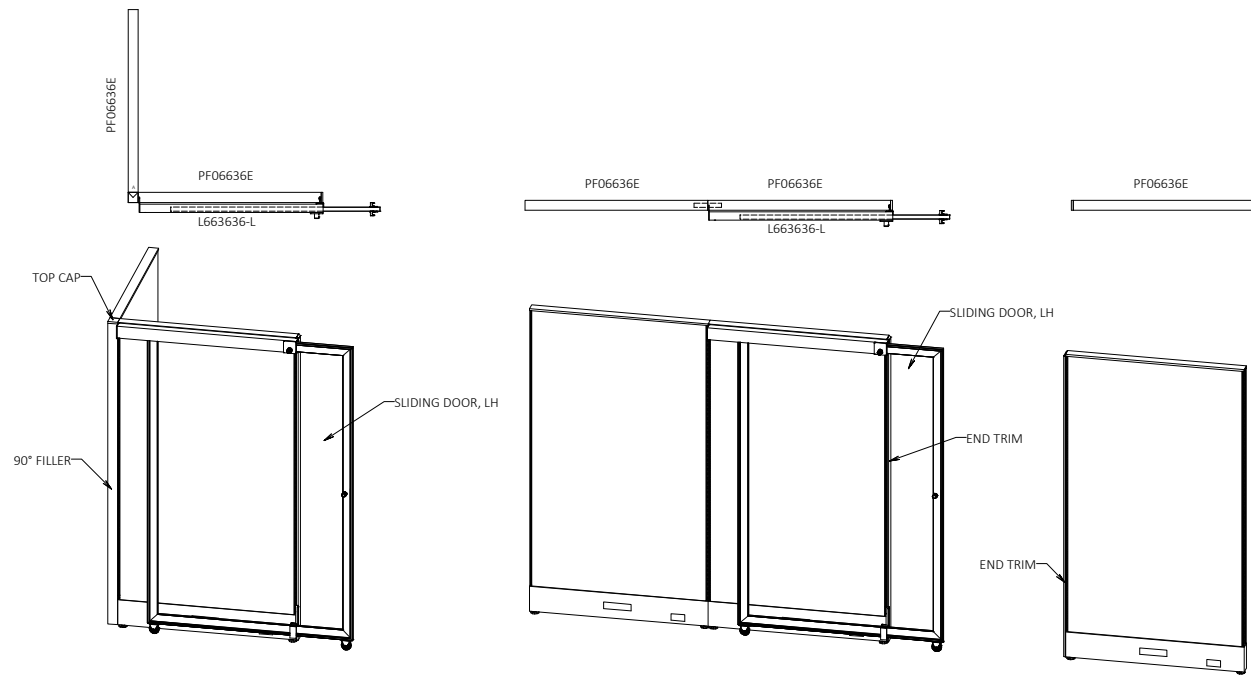

3-Way Connection, 1 Door

3-Way Connection, 2 Doors

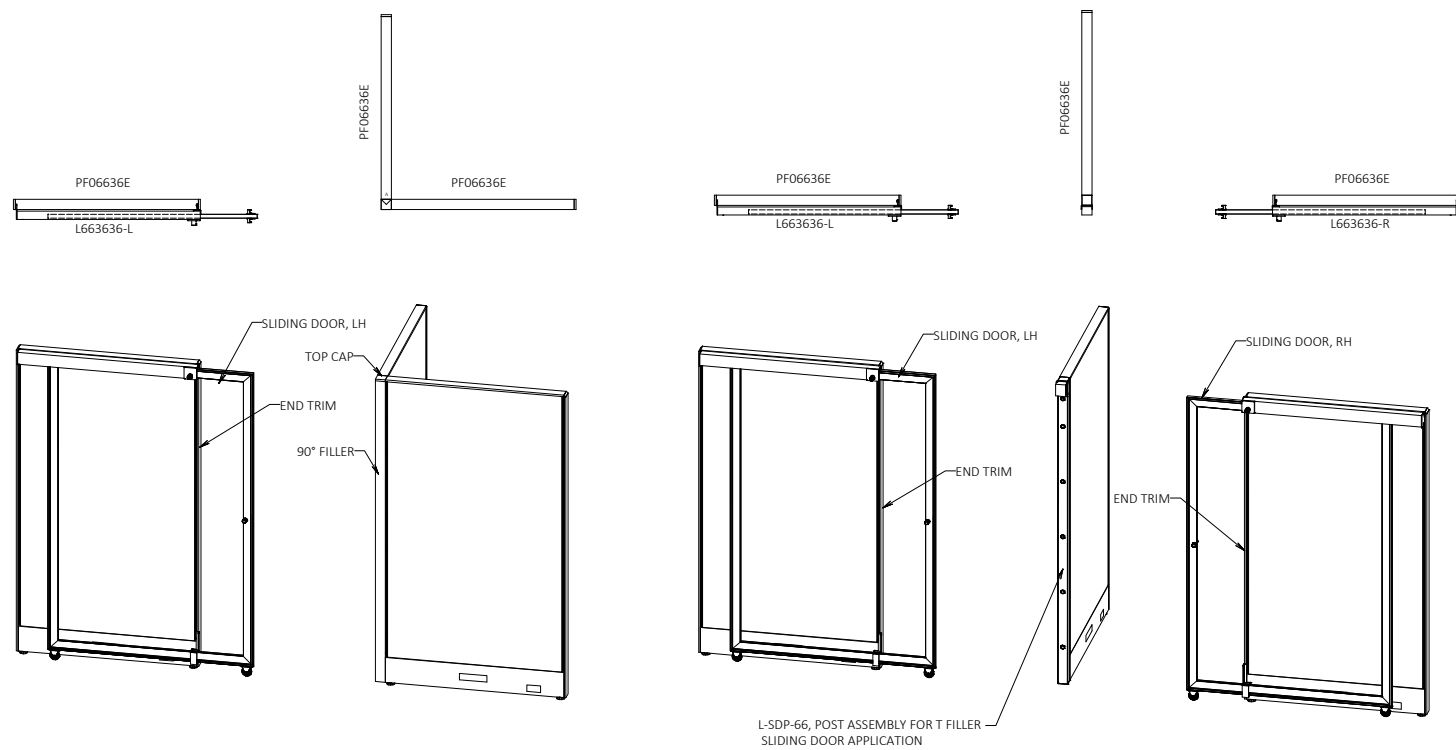

Connection Types - Fillers

2-Way 90° Connection

2-Way 180° Connection

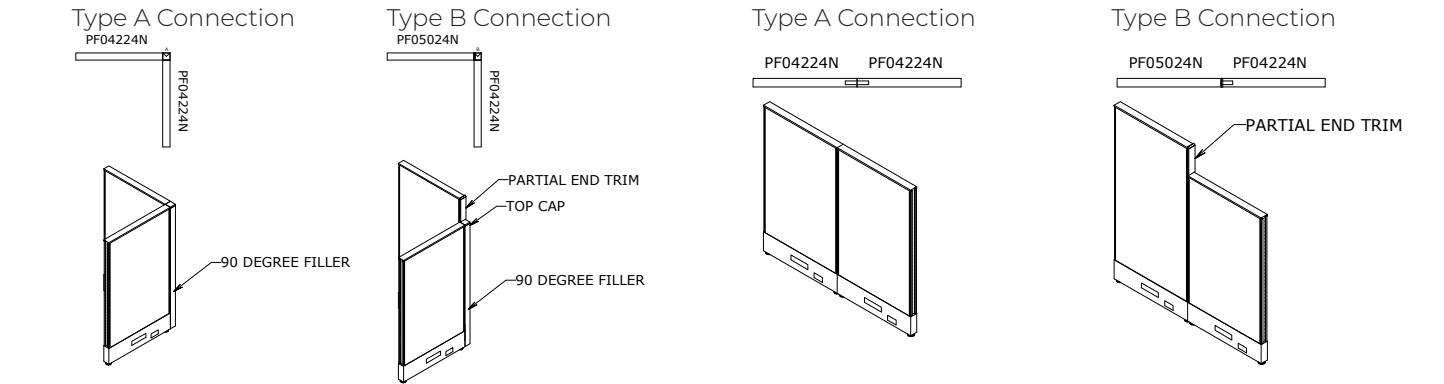

3-Way Connection

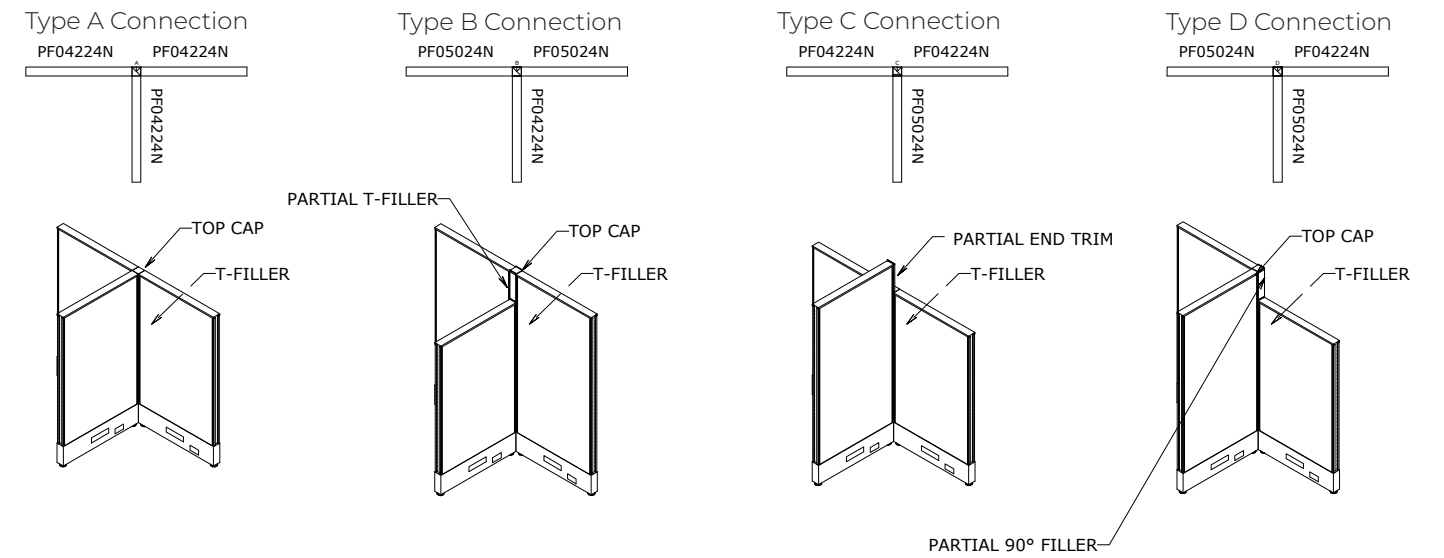

4-Way Connection

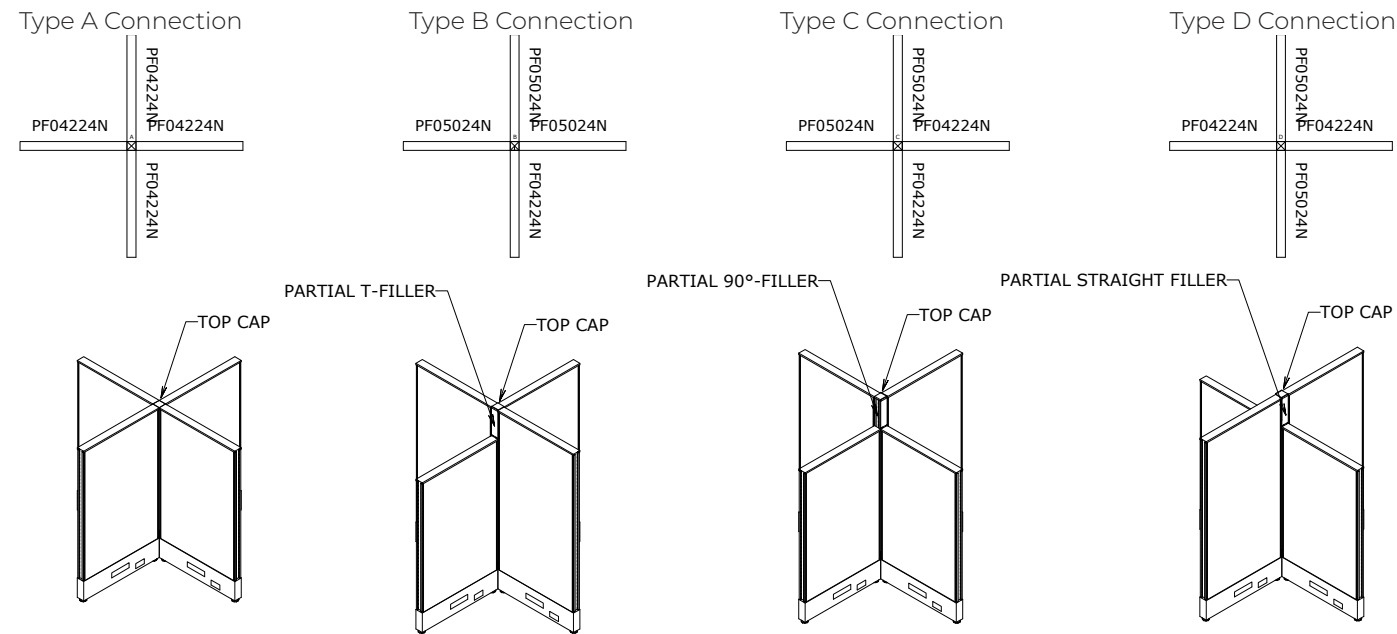

Wire Play Planning

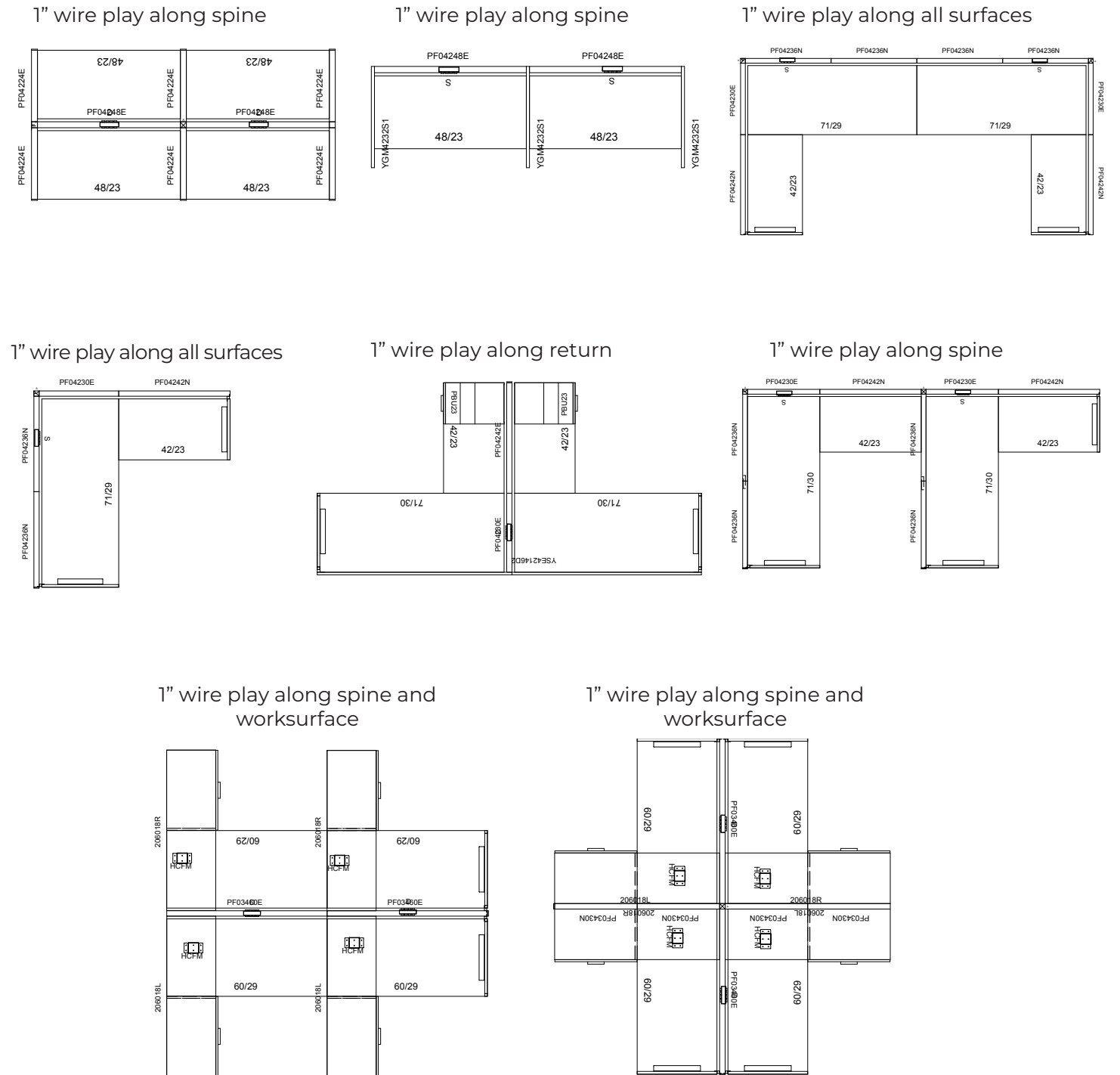



Switch USA Pricebook
January 2026
Panels

Panels

Standard Panel - Monolithic	4	Gallery - Woodgrain	64
Non Powered Capable	4	Horizontal Grain	64
Fabric	4	Single Span Middle	64
Laminate	6	Double Span Middle	66
Powered Capable	8	Single Span End /No Cutout	68
Fabric	8	Single Span End/w Cutout	70
Laminate	10	Double Span End /No Cutout	72
Standard - Glazed	12	Double Span End/w Cutout	74
Non Powered	12	Vertical Grain	76
Fabric/Clear Acrylic	12	Single Span Middle	76
Fabric/Frosted Acrylic	14	Double Span Middle	78
Fabric/Clear Glass	16	Single Span End /No Cutout	80
Fabric/Frosted Glass	18	Single Span End /w Cutout	82
Laminate/Clear Acrylic	20	Double Span End/No Cutout	84
Laminate/Frosted Acrylic	22	Double Span End /w Cutout	86
Laminate/Clear Glass	24	Gallery - Solid	88
Laminate/Frosted Glass	26	Single Span Middle	88
Powered	28	Double Span Middle	90
Fabric/Clear Acrylic	28	Single Span End /No Cutout	92
Fabric/Frosted Acrylic	30	Single Span End /w Cutout	94
Fabric/Clear Glass	32	Double Span End/No Cutout	96
Fabric/Frosted Glass	34	Double Span End /w Cutout	98
Laminate/Clear Acrylic	36	Frameless Blade	100
Laminate/Frosted Acrylic	38	Standard & Elevated	
Laminate/Clear Glass	40	Panel Mounted Glass	100
Laminate/Frosted Glass	42	Standard & Elevated	
Elevated - Monolithic	44	Panel Mounted Acrylic	102
Fabric	44	Gallery Panel Mounted Glass	104
Laminate	46	Gallery Panel Mounted Acrylic	106
Elevated - Glazed	48	Panel Mounted Add Ons	108
Fabric/Clear Acrylic	48	Whiteboard	108
Fabric/Frosted Acrylic	50	Tackboard	109
Fabric/Clear Glass	52	Doors	110
Fabric/Frosted Glass	54	Hinged	110
Laminate/Clear Acrylic	56	Sliding	112
Laminate/Frosted Acrylic	58	Clear Acrylic	113
Laminate/Clear Glass	60	Frosted Acrylic	114
Laminate/Frosted Glass	62	Fluted Acrylic	115

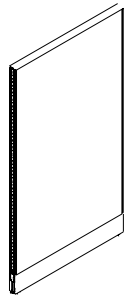

Standard Monolithic
Non-Powered Fabric Panel

What's Included:

One (1) 2" thick fabric panel with 1" incremented slotted channels,
Two (2) raceway covers,
One (1) top trim

How to Specify:

Refer to panel fabric cards for fabric selections
Choose White, Black, Silver, Charcoal for Panel Frame colour

Notes:

Non-power capable panel.
Can be used in run with power-capable panels and allows wires to pass through.
Panels are non tackable. For tackable option see Panel Add-On section.
Fabric Upcharge
Grade 2 - \$226 per panel,
Grade 3- \$278 per panel

Options:

Height*:	34", 42", 50", 66", 82"
Width:	24", 30", 36", 42", 48", 54", 60", 66", 72"
Fabric	
Metal Powder Coat Paint:	White, Black, Silver, Charcoal

*34" high - 50" high available up to 72" wide, 66" high available up to 60" wide, 82" high available up to 48" wide

Code	Price	H	W	D	Weight (lb.)	Volume (ft ³)
L-PPF0-3424-N	457	34	24	2	16.32	0.94
L-PPF0-3430-N	493	34	30	2	20.40	1.18
L-PPF0-3436-N	530	34	36	2	24.48	1.42
L-PPF0-3442-N	566	34	42	2	28.56	1.65
L-PPF0-3448-N	601	34	48	2	32.64	1.89
L-PPF0-3454-N	637	34	54	2	36.72	2.13
L-PPF0-3460-N	673	34	60	2	40.80	2.36
L-PPF0-3466-N	969	34	66	2		
L-PPF0-3472-N	1003	34	72	2		

Code	Price	H	W	D	Weight (lb.)	Volume (ft ³)
L-PPF0-4224-N	457	42	24	2	20.16	1.17
L-PPF0-4230-N	493	42	30	2	25.20	1.46
L-PPF0-4236-N	530	42	36	2	30.24	1.75
L-PPF0-4242-N	566	42	42	2	35.28	2.04
L-PPF0-4248-N	601	42	48	2	40.32	2.33
L-PPF0-4254-N	637	42	54	2	45.36	2.63
L-PPF0-4260-N	673	42	60	2	50.40	2.92
L-PPF0-4266-N	969	42	66	2		
L-PPF0-4272-N	1003	42	72	2		
L-PPF0-5024-N	493	50	24	2	24.00	1.39
L-PPF0-5030-N	547	50	30	2	30.00	1.74
L-PPF0-5036-N	601	50	36	2	36.00	2.08
L-PPF0-5042-N	655	50	42	2	42.00	2.43
L-PPF0-5048-N	710	50	48	2	48.00	2.78
L-PPF0-5054-N	764	50	54	2	54.00	3.13
L-PPF0-5060-N	814	50	60	2	60.00	3.47
L-PPF0-5066-N	1083	50	66	2		
L-PPF0-5072-N	1133	50	72	2		
L-PPF0-6624-N	566	66	24	2	31.68	1.83
L-PPF0-6630-N	629	66	30	2	39.60	2.29
L-PPF0-6636-N	683	66	36	2	47.52	2.75
L-PPF0-6642-N	737	66	42	2	55.44	3.21
L-PPF0-6648-N	790	66	48	2	63.36	3.67
L-PPF0-6654-N	862	66	54	2	71.28	4.13
L-PPF0-6660-N	933	66	60	2	79.20	4.58
L-PPF0-8224-N	1071	82	24	2		
L-PPF0-8230-N	1149	82	30	2		
L-PPF0-8236-N	1392	82	36	2		
L-PPF0-8242-N	1465	82	42	2		
L-PPF0-8248-N	1540	82	48	2		



Standard Monolithic
Non-Powered Laminate
Panel

What's Included:

One (1) 2" thick laminate panel with
1" incremented slotted channels,
Two (2) raceway covers,
One (1) top trim

How to Specify:

Refer to laminate cards for laminate
selections Choose White, Black, Silver, Charcoal
for Panel Frame colour

Notes:

Non-power capable panel.
Can be used in run with power-capable
panels and allows wires to pass through.
Panels are non tackable. For tackable
option see Panel Add-On section.

Options:

Height*	34", 42", 50", 66", 82"
Width:	24", 30", 36", 42", 48
Fabric	
Metal Powder Coat Paint:	White, Black, Silver, Charcoal

*82" high available up to 36" wide

Code	Price	H	W	D	Weight (lb.)	Volume (ft ³)
L-PPL0-3424-N	578	34	24	2	16.32	0.94
L-PPL0-3430-N	630	34	30	2	20.40	1.18
L-PPL0-3436-N	718	34	36	2	24.48	1.42
L-PPL0-3442-N	773	34	42	2	28.56	1.65
L-PPL0-3448-N	847	34	48	2	32.64	1.89
L-PPL0-4224-N	630	42	24	2	20.16	1.17
L-PPL0-4230-N	686	42	30	2	25.20	1.46
L-PPL0-4236-N	773	42	36	2	30.24	1.75
L-PPL0-4242-N	827	42	42	2	35.28	2.04
L-PPL0-4248-N	899	42	48	2	40.32	2.33
L-PPL0-5024-N	686	50	24	2	24.00	1.39
L-PPL0-5030-N	739	50	30	2	30.00	1.74
L-PPL0-5036-N	847	50	36	2	36.00	2.08
L-PPL0-5042-N	899	50	42	2	42.00	2.43
L-PPL0-5048-N	972	50	48	2	48.00	2.78
L-PPL0-6624-N	847	66	24	2	31.68	1.83
L-PPL0-6630-N	899	66	30	2	39.60	2.29
L-PPL0-6636-N	1062	66	36	2	47.52	2.75
L-PPL0-6642-N	1117	66	42	2	55.44	3.21
L-PPL0-6648-N	1187	66	48	2	63.36	3.67
L-PPL0-8224-N	1147	82	24	2		
L-PPL0-8230-N	1164	82	30	2		
L-PPL0-8236-N	1522	82	36	2		

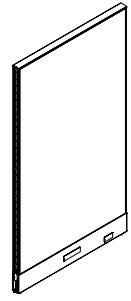

Standard Monolithic Powered Fabric Panel

What's Included:

One (1) 2" thick fabric panel with 1" incremented slotted channels, Two (2) raceway covers, One (1) top trim

How to Specify:

Refer to panel fabric cards for fabric selections
Choose White, Black, Silver, Charcoal for Panel Frame colour

Notes:

Power capable panel with bracket for power module.

Power module must be specified seperately.

Panels are non tackable. For tackable option see Panel Add-On section.

Fabric Upcharge
Grade 2 - \$226 per panel,
Grade 3- \$278 per panel

Options:

Height*: 34", 42", 50", 66", 82"

Width: 24", 30", 36", 42", 48", 54", 60", 66", 72"

Fabric

Metal Powder Coat Paint: White, Black, Silver, Charcoal

*34" high - 50" high available up to 72" wide, 66" high available up to 60" wide, 82" high available up to 48" wide

Code	Price	H	W	D	Weight (lb.)	Volume (ft ³)
L-PPF0-3424-E	510	34	24	2	16.32	0.94
L-PPF0-3430-E	547	34	30	2	20.40	1.18
L-PPF0-3436-E	582	34	36	2	24.48	1.42
L-PPF0-3442-E	621	34	42	2	28.56	1.65
L-PPF0-3448-E	655	34	48	2	32.64	1.89
L-PPF0-3454-E	692	34	54	2	36.72	2.13
L-PPF0-3460-E	725	34	60	2	40.80	2.36
L-PPF0-3466-E	1017	34	66	2		
L-PPF0-3472-E	1047	34	72	2		

Code	Price	H	W	D	Weight (lb.)	Volume (ft ³)
L-PPF0-4224-E	510	42	24	2	20.16	1.17
L-PPF0-4230-E	547	42	30	2	25.20	1.46
L-PPF0-4236-E	582	42	36	2	30.24	1.75
L-PPF0-4242-E	621	42	42	2	35.28	2.04
L-PPF0-4248-E	655	42	48	2	40.32	2.33
L-PPF0-4254-E	692	42	54	2	45.36	2.63
L-PPF0-4260-E	725	42	60	2	50.40	2.92
L-PPF0-4266-E	1017	42	66	2		
L-PPF0-4272-E	1047	42	72	2		
L-PPF0-5024-E	547	50	24	2	24.00	1.39
L-PPF0-5030-E	601	50	30	2	30.00	1.74
L-PPF0-5036-E	655	50	36	2	36.00	2.08
L-PPF0-5042-E	710	50	42	2	42.00	2.43
L-PPF0-5048-E	764	50	48	2	48.00	2.78
L-PPF0-5054-E	814	50	54	2	54.00	3.13
L-PPF0-5060-E	868	50	60	2	60.00	3.47
L-PPF0-5066-E	1131	50	66	2		
L-PPF0-5072-E	1178	50	72	2		
L-PPF0-6624-E	621	66	24	2	31.68	1.83
L-PPF0-6630-E	683	66	30	2	39.60	2.29
L-PPF0-6636-E	737	66	36	2	47.52	2.75
L-PPF0-6642-E	790	66	42	2	55.44	3.21
L-PPF0-6648-E	846	66	48	2	63.36	3.67
L-PPF0-6654-E	916	66	54	2	71.28	4.13
L-PPF0-6660-E	984	66	60	2	79.20	4.58
L-PPF0-8224-E	1119	82	24	2		
L-PPF0-8230-E	1197	82	30	2		
L-PPF0-8236-E	1438	82	36	2		
L-PPF0-8242-E	1513	82	42	2		
L-PPF0-8248-E	1588	82	48	2		



Standard Monolithic Powered Laminate Panel

What's Included:

One (1) 2" thick flaminite panel with 1" incremented slotted channels,
Two (2) raceway covers,
One (1) top trim

How to Specify:

Refer to laminate cards for laminate selections
Choose White, Black, Silver, Charcoal for Panel Frame colour

Options:

Height*: 34", 42", 50", 66", 82"

Width: 24", 30", 36", 42", 48",

Laminate

Metal Powder Coat Paint: White, Black, Silver, Charcoal

*82"H available up to 36"W

Notes:

Power capable panel with bracket for power module.

Power module must be specified seperately.

Panels are non tackable. For tackable option see Panel Add-On section.

Code	Price	H	W	D	Weight (lb.)	Volume (ft ³)
L-PPL0-3424-E	629	34	24	2	16.32	0.94
L-PPL0-3430-E	683	34	30	2	20.40	1.18
L-PPL0-3436-E	771	34	36	2	24.48	1.42
L-PPL0-3442-E	825	34	42	2	28.56	1.65
L-PPL0-3448-E	897	34	48	2	32.64	1.89
L-PPL0-4224-E	683	42	24	2	20.16	1.17
L-PPL0-4230-E	737	42	30	2	25.20	1.46
L-PPL0-4236-E	825	42	36	2	30.24	1.75
L-PPL0-4242-E	881	42	42	2	35.28	2.04
L-PPL0-4248-E	952	42	48	2	40.32	2.33
L-PPL0-5024-E	737	50	24	2	24.00	1.39
L-PPL0-5030-E	790	50	30	2	30.00	1.74
L-PPL0-5036-E	897	50	36	2	36.00	2.08
L-PPL0-5042-E	952	50	42	2	42.00	2.43
L-PPL0-5048-E	1024	50	48	2	48.00	2.78
L-PPL0-6624-E	897	66	24	2	31.68	1.83
L-PPL0-6630-E	952	66	30	2	39.60	2.29
L-PPL0-6636-E	1115	66	36	2	47.52	2.75
L-PPL0-6642-E	1168	66	42	2	55.44	3.21
L-PPL0-6648-E	1239	66	48	2	63.36	3.67
L-PPL0-8224-E	1163	82	24	2		
L-PPL0-8230-E	1178	82	30	2		
L-PPL0-8236-E	1570	82	36	2		

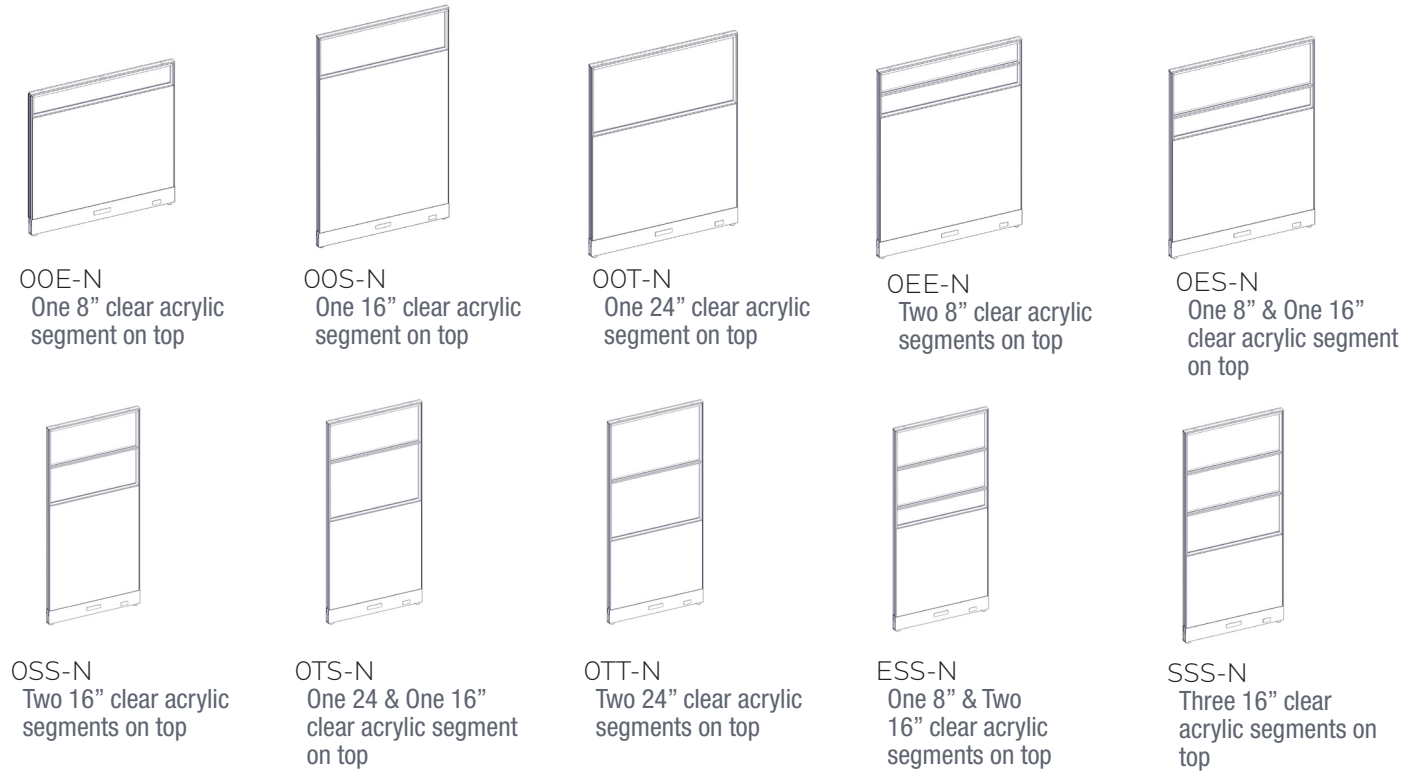

How to order and read your code

L - P P F C A - 42 24 - 00E - N

product line	standard	P=glazed E=Elevated	F=Fabric L=Laminate	C=Clear F=Frosted G=Glass	A=Acrylic height	width	O = No segment E = 8 inch segment S = 16 inch segment T = 24 inch segment	N=Non powered E=Powered
--------------	----------	------------------------	------------------------	---------------------------------	------------------	-------	--	----------------------------

What's Included:

One (1) 2" thick fabric panel with 1" incremented slotted channels, Two (2) raceway covers, One (1) top trim

How to Specify:

Refer to panel fabric cards for fabric selections
Choose White, Black, Silver, Charcoal for Panel Frame colour

Options:

Height*:	34", 42", 50", 66", 82"
Width:	24", 30", 36", 42", 48", 54", 60", 66", 72"
Fabric	
Metal Powder Coat Paint:	White, Black, Silver, Charcoal

*34" high - 50" high available up to 72" wide, 66" high available up to 60" wide, 82" high available up to 48" wide

Code	Price	H	W	D
One 8" clear acrylic segment on top				
L-PPFCA-4224-00E-N	888	42	24	2
L-PPFCA-4230-00E-N	980	42	30	2
L-PPFCA-4236-00E-N	1071	42	36	2
L-PPFCA-4242-00E-N	1163	42	42	2
L-PPFCA-4248-00E-N	1257	42	48	2
L-PPFCA-4254-00E-N	1345	42	54	2
L-PPFCA-4260-00E-N	1437	42	60	2
L-PPFCA-5024-00E-N	888	50	24	2
L-PPFCA-5030-00E-N	980	50	30	2
L-PPFCA-5036-00E-N	1071	50	36	2
L-PPFCA-5042-00E-N	1163	50	42	2
L-PPFCA-5048-00E-N	1257	50	48	2
L-PPFCA-5054-00E-N	1345	50	54	2
L-PPFCA-5060-00E-N	1437	50	60	2
One 16" clear acrylic segment on top				
L-PPFCA-5024-00S-N	888	50	24	2
L-PPFCA-5030-00S-N	980	50	30	2
L-PPFCA-5036-00S-N	1071	50	36	2
L-PPFCA-5042-00S-N	1163	50	42	2
L-PPFCA-5048-00S-N	1257	50	48	2
L-PPFCA-5054-00S-N	1345	50	54	2
L-PPFCA-5060-00S-N	1437	50	60	2
L-PPFCA-6624-00S-N	1033	66	24	2
L-PPFCA-6630-00S-N	1149	66	30	2
L-PPFCA-6636-00S-N	1263	66	36	2
L-PPFCA-6642-00S-N	1378	66	42	2
L-PPFCA-6648-00S-N	1494	66	48	2
L-PPFCA-6654-00S-N	1609	66	54	2
L-PPFCA-6660-00S-N	1723	66	60	2
L-PPFCA-8224-00S-N	1679	82	24	2
L-PPFCA-8230-00S-N	1948	82	30	2
L-PPFCA-8236-00S-N	2048	82	36	2
L-PPFCA-8242-00S-N	2099	82	42	2
L-PPFCA-8248-00S-N	2194	82	48	2
One 24" clear acrylic segment on top				
L-PPFCA-6624-00T-N	1033	66	24	2
L-PPFCA-6630-00T-N	1149	66	30	2
L-PPFCA-6636-00T-N	1263	66	36	2
L-PPFCA-6642-00T-N	1378	66	42	2
L-PPFCA-6648-00T-N	1494	66	48	2
L-PPFCA-6654-00T-N	1609	66	54	2
L-PPFCA-6660-00T-N	1723	66	60	2
Two 8" clear acrylic segments on top				
L-PPFCA-6624-0EE-N	1660	66	24	2
L-PPFCA-6630-0EE-N	1878	66	30	2
L-PPFCA-6636-0EE-N	1958	66	36	2
L-PPFCA-6642-0EE-N	2024	66	42	2
L-PPFCA-6648-0EE-N	2108	66	48	2
L-PPFCA-6654-0EE-N	2244	66	54	2
L-PPFCA-6660-0EE-N	2305	66	60	2
One 8" & One 16" clear acrylic segment on top				
L-PPFCA-6624-0ES-N	1620	66	24	2
L-PPFCA-6630-0ES-N	1831	66	30	2
L-PPFCA-6636-0ES-N	1925	66	36	2
L-PPFCA-6642-0ES-N	2019	66	42	2
L-PPFCA-6648-0ES-N	2116	66	48	2
L-PPFCA-6654-0ES-N	2218	66	54	2
L-PPFCA-6660-0ES-N	2267	66	60	2
Two 16" clear acrylic segments on top				
L-PPFCA-8224-0SS-N	1725	82	24	2
L-PPFCA-8230-0SS-N	2005	82	30	2
L-PPFCA-8236-0SS-N	2149	82	36	2
L-PPFCA-8242-0SS-N	2214	82	42	2
L-PPFCA-8248-0SS-N	2302	82	48	2
One 24" & One 16" clear acrylic segment on top				
L-PPFCA-8224-0TS-N	1716	82	24	2
L-PPFCA-8230-0TS-N	1971	82	30	2
L-PPFCA-8236-0TS-N	2048	82	36	2
L-PPFCA-8242-0TS-N	2111	82	42	2
L-PPFCA-8248-0TS-N	2326	82	48	2
Two 24" clear acrylic segments on top				
L-PPFCA-8224-0TT-N	1712	82	24	2
L-PPFCA-8230-0TT-N	1940	82	30	2
L-PPFCA-8236-0TT-N	2044	82	36	2
L-PPFCA-8242-0TT-N	2177	82	42	2
L-PPFCA-8248-0TT-N	2266	82	48	2
One 8" & Two 16" clear acrylic segments on top				
L-PPFCA-8224-ESS-N	1789	82	24	2
L-PPFCA-8230-ESS-N	2120	82	30	2
L-PPFCA-8236-ESS-N	2214	82	36	2
L-PPFCA-8242-ESS-N	2217	82	42	2
L-PPFCA-8248-ESS-N	2429	82	48	2
Three 16" clear acrylic segments on top				
L-PPFCA-8224-SSS-N	1817	82	24	2
L-PPFCA-8230-SSS-N	2056	82	30	2
L-PPFCA-8236-SSS-N	2246	82	36	2
L-PPFCA-8242-SSS-N	2322	82	42	2
L-PPFCA-8248-SSS-N	2423	82	48	2

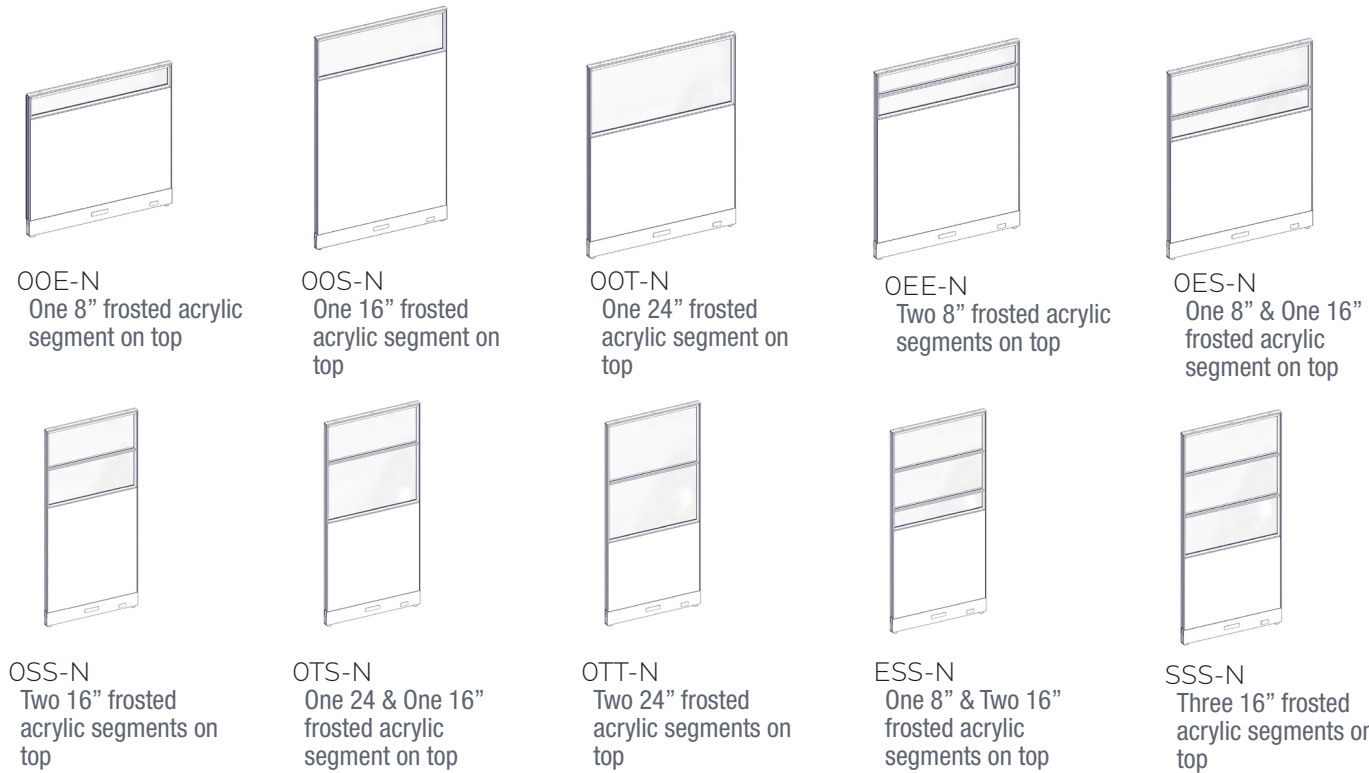

How to order and read your code

L - P P F F A - 42 24 - 00E - N

product standard line P=glazed E=Elevated F=Fabric L=Laminate C=Clear F=Frosted A=Acrylic height G=Glass width 0=No segment E=8 inch segment S=16 inch segment T=24 inch segment N=Non powered E=Powered

What's Included:

One (1) 2" thick fabric panel with 1" incremented slotted channels, Two (2) raceway covers, One (1) top trim

How to Specify:

Refer to panel fabric cards for fabric selections
Choose White, Black, Silver, Charcoal for Panel Frame colour

Options:

Height*:	34", 42", 50", 66", 82"
Width:	24", 30", 36", 42", 48", 54", 60", 66", 72"
Fabric	
Metal Powder Coat Paint:	White, Black, Silver, Charcoal

*34" high - 50" high available up to 72" wide, 66" high available up to 60" wide, 82" high available up to 48" wide

Code	Price	H	W	D
One 8" frosted acrylic segment on top				
L-PPFFA-4224-00E-N	1005	42	24	2
L-PPFFA-4230-00E-N	1095	42	30	2
L-PPFFA-4236-00E-N	1188	42	36	2
L-PPFFA-4242-00E-N	1280	42	42	2
L-PPFFA-4248-00E-N	1372	42	48	2
L-PPFFA-4254-00E-N	1462	42	54	2
L-PPFFA-4260-00E-N	1552	42	60	2
L-PPFFA-5024-00E-N	1005	50	24	2
L-PPFFA-5030-00E-N	1095	50	30	2
L-PPFFA-5036-00E-N	1188	50	36	2
L-PPFFA-5042-00E-N	1280	50	42	2
L-PPFFA-5048-00E-N	1372	50	48	2
L-PPFFA-5054-00E-N	1462	50	54	2
L-PPFFA-5060-00E-N	1552	50	60	2
One 16" frosted acrylic segment on top				
L-PPFFA-5024-00S-N	1005	50	24	2
L-PPFFA-5030-00S-N	1095	50	30	2
L-PPFFA-5036-00S-N	1188	50	36	2
L-PPFFA-5042-00S-N	1280	50	42	2
L-PPFFA-5048-00S-N	1372	50	48	2
L-PPFFA-5054-00S-N	1462	50	54	2
L-PPFFA-5060-00S-N	1552	50	60	2
L-PPFFA-6624-00S-N	1149	50	24	2
L-PPFFA-6630-00S-N	1265	50	30	2
L-PPFFA-6636-00S-N	1379	50	36	2
L-PPFFA-6642-00S-N	1494	50	42	2
L-PPFFA-6648-00S-N	1612	50	48	2
L-PPFFA-6654-00S-N	1725	50	54	2
L-PPFFA-6660-00S-N	1841	50	60	2
L-PPFFA-8224-00S-N	1719	82	24	2
L-PPFFA-8230-00S-N	2000	82	30	2
L-PPFFA-8236-00S-N	2117	82	36	2
L-PPFFA-8242-00S-N	2177	82	42	2
L-PPFFA-8248-00S-N	2272	82	48	2
One 24" frosted acrylic segment on top				
L-PPFFA-6624-00T-N	1149	66	24	2
L-PPFFA-6630-00T-N	1265	66	30	2
L-PPFFA-6636-00T-N	1379	66	36	2
L-PPFFA-6642-00T-N	1478	66	42	2
L-PPFFA-6648-00T-N	1595	66	48	2
L-PPFFA-6654-00T-N	1725	66	54	2
L-PPFFA-6660-00T-N	1841	66	60	2
One 8" & Two 16" frosted acrylic segments on top				
L-PPFFA-6624-0EE-N	1728	66	24	2
L-PPFFA-6630-0EE-N	1972	66	30	2
L-PPFFA-6636-0EE-N	2080	66	36	2
L-PPFFA-6642-0EE-N	2144	66	42	2
L-PPFFA-6648-0EE-N	2248	66	48	2
L-PPFFA-6654-0EE-N	2344	66	54	2
L-PPFFA-6660-0EE-N	2401	66	60	2
One 8" & One 16" frosted acrylic segment on top				
L-PPFFA-6624-0ES-N	1678	66	24	2
L-PPFFA-6630-0ES-N	1912	66	30	2
L-PPFFA-6636-0ES-N	2021	66	36	2
L-PPFFA-6642-0ES-N	2137	66	42	2
L-PPFFA-6648-0ES-N	2232	66	48	2
L-PPFFA-6654-0ES-N	2347	66	54	2
L-PPFFA-6660-0ES-N	2419	66	60	2
Two 16" frosted acrylic segments on top				
L-PPFFA-8224-0SS-N	1615	82	24	2
L-PPFFA-8230-0SS-N	1849	82	30	2
L-PPFFA-8236-0SS-N	1939	82	36	2
L-PPFFA-8242-0SS-N	2010	82	42	2
L-PPFFA-8248-0SS-N	2085	82	48	2
One 24" & One 16" frosted acrylic segment on top				
L-PPFFA-8224-0TS-N	1833	82	24	2
L-PPFFA-8230-0TS-N	2127	82	30	2
L-PPFFA-8236-0TS-N	2204	82	36	2
L-PPFFA-8242-0TS-N	2309	82	42	2
L-PPFFA-8248-0TS-N	2559	82	48	2
Two 24" frosted acrylic segments on top				
L-PPFFA-8224-0TT-N	1829	82	24	2
L-PPFFA-8230-0TT-N	2099	82	30	2
L-PPFFA-8236-0TT-N	2232	82	36	2
L-PPFFA-8242-0TT-N	2412	82	42	2
L-PPFFA-8248-0TT-N	2500	82	48	2
One 8" & Two 16" frosted acrylic segments on top				
L-PPFFA-8224-ESS-N	1905	82	24	2
L-PPFFA-8230-ESS-N	2279	82	30	2
L-PPFFA-8236-ESS-N	2371	82	36	2
L-PPFFA-8242-ESS-N	2447	82	42	2
L-PPFFA-8248-ESS-N	2582	82	48	2
Three 16" frosted acrylic segments on top				
L-PPFFA-8224-SSS-N	1934	82	24	2
L-PPFFA-8230-SSS-N	2214	82	30	2
L-PPFFA-8236-SSS-N	2482	82	36	2
L-PPFFA-8242-SSS-N	2556	82	42	2
L-PPFFA-8248-SSS-N	2656	82	48	2

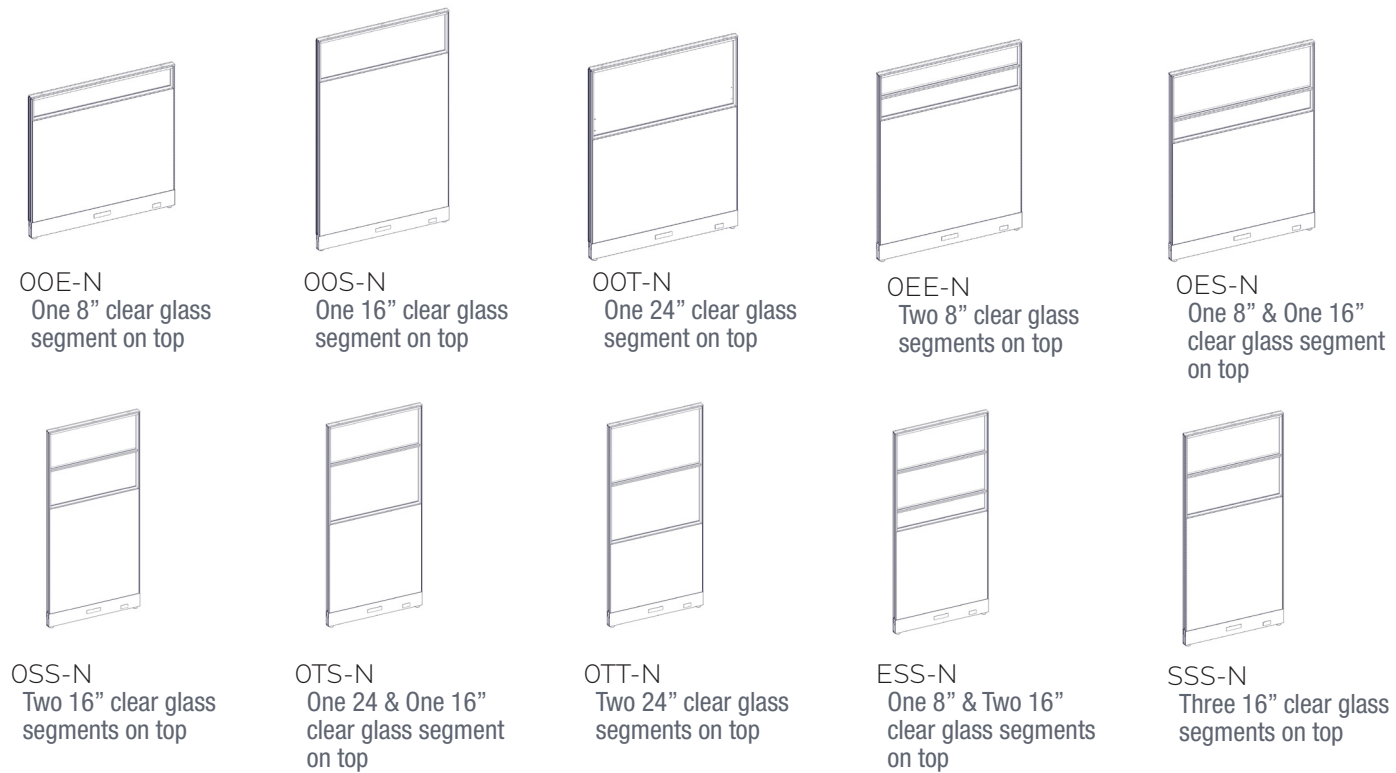

How to order and read your code

L - P P F C G - 42 24 - 00E - N

product standard line P=glazed E=Elevated F=Fabric L=Laminate C=Clear F=Frosted A=Acrylic G=Glass height width 0=No segment E=8 inch segment S=16 inch segment T=24 inch segment N=Non powered E=Powered

What's Included:

One (1) 2" thick fabric panel with 1" incremented slotted channels, Two (2) raceway covers, One (1) top trim

How to Specify:

Refer to panel fabric cards for fabric selections
Choose White, Black, Silver, Charcoal for Panel Frame colour

Notes:

Power capable panel with bracket for power module.
Power module must be specified seperately.
Panels are non tackable. For tackable option see Panel Add-On section.
Fabric Upcharge
Grade 2 - \$226 per panel,
Grade 3- \$278 per panel

Options:

Height*:	34", 42", 50", 66", 82"
Width:	24", 30", 36", 42", 48", 54", 60", 66", 72"
Fabric	
Metal Powder Coat Paint:	White, Black, Silver, Charcoal

*34" high - 50" high available up to 72" wide, 66" high available up to 60" wide, 82" high available up to 48" wide

Code	Price	H	W	D
One 8" clear glass segment on top				
L-PPFCG-4224-00E-N	1044	42	24	2
L-PPFCG-4230-00E-N	1136	42	30	2
L-PPFCG-4236-00E-N	1230	42	36	2
L-PPFCG-4242-00E-N	1319	42	42	2
L-PPFCG-4248-00E-N	1409	42	48	2
L-PPFCG-4254-00E-N	1501	42	54	2
L-PPFCG-4260-00E-N	1591	42	60	2
L-PPFCG-5024-00E-N	1044	50	24	2
L-PPFCG-5030-00E-N	1136	50	30	2
L-PPFCG-5036-00E-N	1230	50	36	2
L-PPFCG-5042-00E-N	1319	50	42	2
L-PPFCG-5048-00E-N	1409	50	48	2
L-PPFCG-5054-00E-N	1501	50	54	2
L-PPFCG-5060-00E-N	1591	50	60	2
One 16" clear glass segment on top				
L-PPFCG-5024-00S-N	1044	50	24	2
L-PPFCG-5030-00S-N	1136	50	30	2
L-PPFCG-5036-00S-N	1230	50	36	2
L-PPFCG-5042-00S-N	1319	50	42	2
L-PPFCG-5048-00S-N	1409	50	48	2
L-PPFCG-5054-00S-N	1501	50	54	2
L-PPFCG-5060-00S-N	1591	50	60	2
L-PPFCG-6624-00S-N	1200	66	24	2
L-PPFCG-6630-00S-N	1317	66	30	2
L-PPFCG-6636-00S-N	1432	66	36	2
L-PPFCG-6642-00S-N	1549	66	42	2
L-PPFCG-6648-00S-N	1664	66	48	2
L-PPFCG-6654-00S-N	1780	66	54	2
L-PPFCG-6660-00S-N	1893	66	60	2
L-PPFCG-8224-00S-N	1635	82	24	2
L-PPFCG-8230-00S-N	1930	82	30	2
L-PPFCG-8236-00S-N	2055	82	36	2
L-PPFCG-8242-00S-N	2123	82	42	2
L-PPFCG-8248-00S-N	2243	82	48	2
One 24" clear glass segment on top				
L-PPFCG-6624-00T-N	1200	66	24	2
L-PPFCG-6630-00T-N	1317	66	30	2
L-PPFCG-6636-00T-N	1432	66	36	2
L-PPFCG-6642-00T-N	1549	66	42	2
L-PPFCG-6648-00T-N	1664	66	48	2
L-PPFCG-6654-00T-N	1780	66	54	2
L-PPFCG-6660-00T-N	1893	66	60	2

Code	Price	H	W	D
Two 8" clear glass segments on top				
L-PPFCG-6624-0EE-N	1766	66	24	2
L-PPFCG-6630-0EE-N	2026	66	30	2
L-PPFCG-6636-0EE-N	2134	66	36	2
L-PPFCG-6642-0EE-N	2212	66	42	2
L-PPFCG-6648-0EE-N	2317	66	48	2
L-PPFCG-6654-0EE-N	2453	66	54	2
L-PPFCG-6660-0EE-N	2524	66	60	2
One 8" & One 16" clear glass segment on top				
L-PPFCG-6624-0ES-N	1721	66	24	2
L-PPFCG-6630-0ES-N	1950	66	30	2
L-PPFCG-6636-0ES-N	2060	66	36	2
L-PPFCG-6642-0ES-N	2161	66	42	2
L-PPFCG-6648-0ES-N	2292	66	48	2
L-PPFCG-6654-0ES-N	2436	66	54	2
L-PPFCG-6660-0ES-N	2516	66	60	2
Two 16" clear glass segments on top				
L-PPFCG-8224-0SS-N	1829	82	24	2
L-PPFCG-8230-0SS-N	2104	82	30	2
L-PPFCG-8236-0SS-N	2246	82	36	2
L-PPFCG-8242-0SS-N	2360	82	42	2
L-PPFCG-8248-0SS-N	2500	82	48	2
One 24" & One 16" clear glass segment on top				
L-PPFCG-8224-0TS-N	1816	82	24	2
L-PPFCG-8230-0TS-N	2072	82	30	2
L-PPFCG-8236-0TS-N	2208	82	36	2
L-PPFCG-8242-0TS-N	2336	82	42	2
L-PPFCG-8248-0TS-N	2494	82	48	2
Two 24" clear glass segments on top				
L-PPFCG-8224-0TT-N	1849	82	24	2
L-PPFCG-8230-0TT-N	2096	82	30	2
L-PPFCG-8236-0TT-N	2224	82	36	2
L-PPFCG-8242-0TT-N	2355	82	42	2
L-PPFCG-8248-0TT-N	2510	82	48	2
One 8" & Two 16" clear glass segments on top				
L-PPFCG-8224-ESS-N	1985	82	24	2
L-PPFCG-8230-ESS-N	2311	82	30	2
L-PPFCG-8236-ESS-N	2460	82	36	2
L-PPFCG-8242-ESS-N	2485	82	42	2
L-PPFCG-8248-ESS-N	2681	82	48	2
Three 16" clear glass segments on top				
L-PPFCG-8224-SSS-N	2027	82	24	2
L-PPFCG-8230-SSS-N	2267	82	30	2
L-PPFCG-8236-SSS-N	2423	82	36	2
L-PPFCG-8242-SSS-N	2570	82	42	2
L-PPFCG-8248-SSS-N	2744	82	48	2

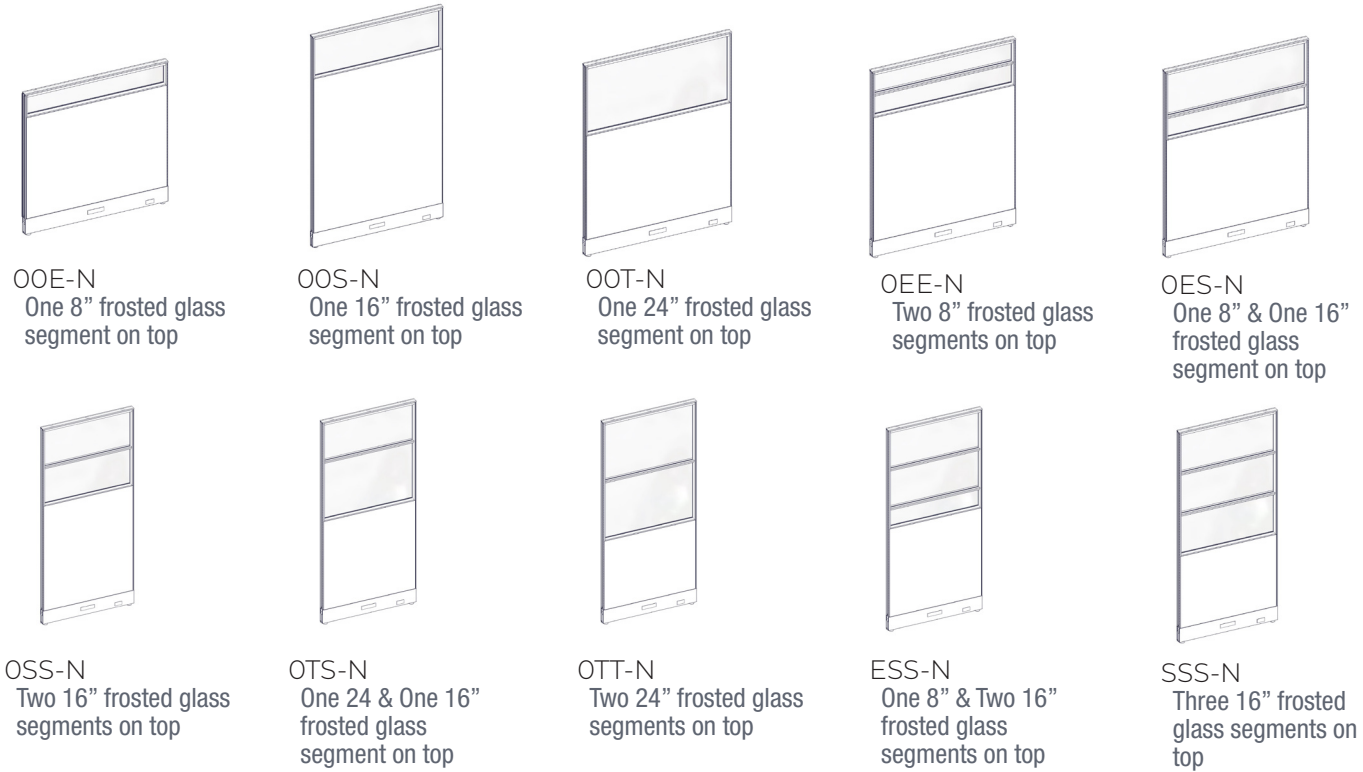

How to order and read your code

L - P P F F G - 42 24 - 00E - N

product line	standard	P=glazed E=Elevated	F=Fabric L=Laminate	C=Clear F=Frosted	A=Acrylic height G=Glass	width	O=No segment E=8 inch segment S=16 inch segment T=24 inch segment	N=Non powered E=Powered
--------------	----------	------------------------	------------------------	----------------------	-----------------------------	-------	--	----------------------------

What's Included:

One (1) 2" thick fabric panel with 1" incremented slotted channels, Two (2) raceway covers, One (1) top trim

How to Specify:

Refer to panel fabric cards for fabric selections
Choose White, Black, Silver, Charcoal for Panel Frame colour

Options:

Height*:	34", 42", 50", 66", 82"
Width:	24", 30", 36", 42", 48", 54", 60", 66", 72"
Fabric	
Metal Powder Coat Paint:	White, Black, Silver, Charcoal

*34" high - 50" high available up to 72" wide, 66" high available up to 60" wide, 82" high available up to 48" wide

Code	Price	H	W	D
One 8" frosted glass segment on top				
L-PPFFG-4224-00E-N	1145	42	24	2
L-PPFFG-4230-00E-N	1249	42	30	2
L-PPFFG-4236-00E-N	1344	42	36	2
L-PPFFG-4242-00E-N	1436	42	42	2
L-PPFFG-4248-00E-N	1526	42	48	2
L-PPFFG-4254-00E-N	1618	42	54	2
L-PPFFG-4260-00E-N	1707	42	60	2
L-PPFFG-5024-00E-N	1161	50	24	2
L-PPFFG-5030-00E-N	1249	50	30	2
L-PPFFG-5036-00E-N	1344	50	36	2
L-PPFFG-5042-00E-N	1436	50	42	2
L-PPFFG-5048-00E-N	1526	50	48	2
L-PPFFG-5054-00E-N	1618	50	54	2
L-PPFFG-5060-00E-N	1707	50	60	2
One 16" frosted glass segment on top				
L-PPFFG-5024-00S-N	1161	50	24	2
L-PPFFG-5030-00S-N	1249	50	30	2
L-PPFFG-5036-00S-N	1344	50	36	2
L-PPFFG-5042-00S-N	1436	50	42	2
L-PPFFG-5048-00S-N	1526	50	48	2
L-PPFFG-5054-00S-N	1618	50	54	2
L-PPFFG-5060-00S-N	1707	50	60	2
L-PPFFG-6624-00S-N	1317	66	24	2
L-PPFFG-6630-00S-N	1433	66	30	2
L-PPFFG-6636-00S-N	1548	66	36	2
L-PPFFG-6642-00S-N	1666	66	42	2
L-PPFFG-6648-00S-N	1780	66	48	2
L-PPFFG-6654-00S-N	1896	66	54	2
L-PPFFG-6660-00S-N	2010	66	60	2
L-PPFFG-8224-00S-N	1728	82	24	2
L-PPFFG-8230-00S-N	2035	82	30	2
L-PPFFG-8236-00S-N	2183	82	36	2
L-PPFFG-8242-00S-N	2272	82	42	2
L-PPFFG-8248-00S-N	2411	82	48	2
One 24" frosted glass segment on top				
L-PPFFG-6624-00T-N	1317	66	24	2
L-PPFFG-6630-00T-N	1433	66	30	2
L-PPFFG-6636-00T-N	1548	66	36	2
L-PPFFG-6642-00T-N	1666	66	42	2
L-PPFFG-6648-00T-N	1780	66	48	2
L-PPFFG-6654-00T-N	1896	66	54	2
L-PPFFG-6660-00T-N	2010	66	60	2
Two 8" clear glass segments on top				
L-PPFFG-6624-0EE-N	1958	66	24	2
L-PPFFG-6630-0EE-N	2217	66	30	2
L-PPFFG-6636-0EE-N	2325	66	36	2
L-PPFFG-6642-0EE-N	2401	66	42	2
L-PPFFG-6648-0EE-N	2506	66	48	2
L-PPFFG-6654-0EE-N	2642	66	54	2
L-PPFFG-6660-0EE-N	2735	66	60	2
One 8" & One 16" frosted glass segment on top				
L-PPFFG-6624-0ES-N	1913	66	24	2
L-PPFFG-6630-0ES-N	2149	66	30	2
L-PPFFG-6636-0ES-N	2284	66	36	2
L-PPFFG-6642-0ES-N	2403	66	42	2
L-PPFFG-6648-0ES-N	2556	66	48	2
L-PPFFG-6654-0ES-N	2724	66	54	2
L-PPFFG-6660-0ES-N	2836	66	60	2
Two 16" frosted glass segments on top				
L-PPFFG-8224-0SS-N	2021	82	24	2
L-PPFFG-8230-0SS-N	2314	82	30	2
L-PPFFG-8236-0SS-N	2502	82	36	2
L-PPFFG-8242-0SS-N	2656	82	42	2
L-PPFFG-8248-0SS-N	2838	82	48	2
One 24" & One 16" frosted glass segment on top				
L-PPFFG-8224-0TS-N	2038	82	24	2
L-PPFFG-8230-0TS-N	2334	82	30	2
L-PPFFG-8236-0TS-N	2527	82	36	2
L-PPFFG-8242-0TS-N	2705	82	42	2
L-PPFFG-8248-0TS-N	2915	82	48	2
Two 24" frosted glass segments on top				
L-PPFFG-8224-0TT-N	2103	82	24	2
L-PPFFG-8230-0TT-N	2412	82	30	2
L-PPFFG-8236-0TT-N	2604	82	36	2
L-PPFFG-8242-0TT-N	2799	82	42	2
L-PPFFG-8248-0TT-N	3019	82	48	2
One 8" & Two 16" frosted glass segments on top				
L-PPFFG-8224-ESS-N	2272	82	24	2
L-PPFFG-8230-ESS-N	2617	82	30	2
L-PPFFG-8236-ESS-N	2810	82	36	2
L-PPFFG-8242-ESS-N	2878	82	42	2
L-PPFFG-8248-ESS-N	3117	82	48	2
Three 16" frosted glass segments on top				
L-PPFFG-8224-SSS-N	2312	82	24	2
L-PPFFG-8230-SSS-N	2581	82	30	2
L-PPFFG-8236-SSS-N	2800	82	36	2
L-PPFFG-8242-SSS-N	3014	82	42	2
L-PPFFG-8248-SSS-N	3250	82	48	2

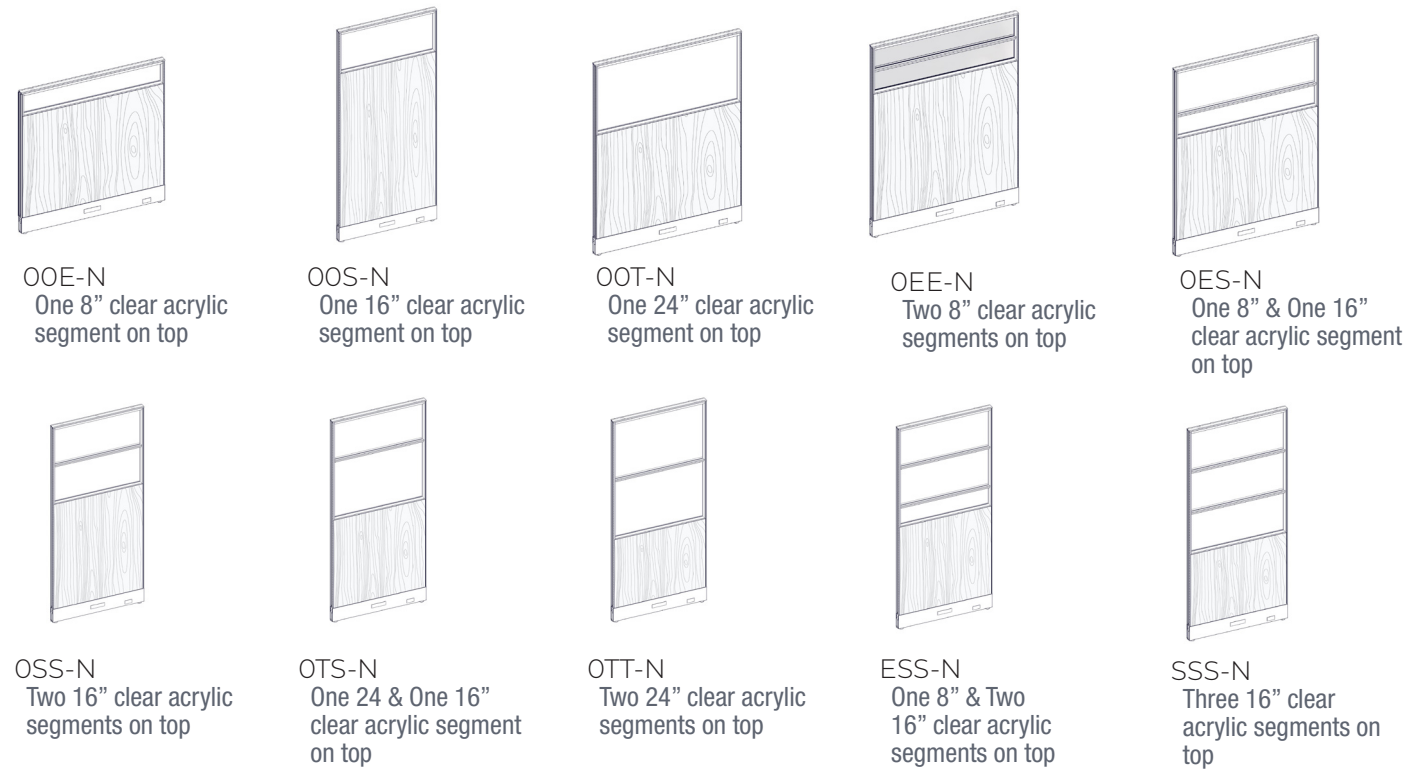

How to order and read your code

L - P P L C A - 42 24 - 00E - N

product line	standard	P=glazed E=Elevated	F=Fabric L=Laminate	C=Clear F=Frosted	A=Acrylic height G=Glass	width	0=No segment E=8 inch segment S=16 inch segment T=24 inch segment	N=Non powered E=Powered
--------------	----------	------------------------	------------------------	----------------------	-----------------------------	-------	--	----------------------------

What's Included:

One (1) 2" thick laminate panel with 1" incremented slotted channels,
Two (2) raceway covers,
One (1) top trim

How to Specify:

Refer to laminate cards for laminate selections
Choose White, Black, Silver, Charcoal for Panel Frame colour

Options:

Height*:	34", 42", 50", 66", 82"
Width:	24", 30", 36", 42", 48",
Laminate	
Metal Powder Coat Paint:	White, Black, Silver, Charcoal

*82"H available up to 36"W

Code	Price	H	W	D
One 8" clear acrylic segment on top				
L-PPLCA-4224-00E-N	1153	42	24	2
L-PPLCA-4230-00E-N	1187	42	30	2
L-PPLCA-4236-00E-N	1247	42	36	2
L-PPLCA-4242-00E-N	1398	42	42	2
L-PPLCA-4248-00E-N	1432	42	48	2
L-PPLCA-5024-00E-N	1197	50	24	2
L-PPLCA-5030-00E-N	1231	50	30	2
L-PPLCA-5036-00E-N	1293	50	36	2
L-PPLCA-5042-00E-N	1468	50	42	2
L-PPLCA-5048-00E-N	1501	50	48	2
One 16" clear acrylic segment on top				
L-PPLCA-5024-00S-N	1214	50	24	2
L-PPLCA-5030-00S-N	1259	50	30	2
L-PPLCA-5036-00S-N	1330	50	36	2
L-PPLCA-5042-00S-N	1487	50	42	2
L-PPLCA-5048-00S-N	1527	50	48	2
L-PPLCA-6624-00S-N	1330	66	24	2
L-PPLCA-6630-00S-N	1370	66	30	2
L-PPLCA-6636-00S-N	1458	66	36	2
L-PPLCA-6642-00S-N	1688	66	42	2
L-PPLCA-6648-00S-N	1732	66	48	2
L-PPLCA-8224-00S-N	1755	82	24	2
L-PPLCA-8230-00S-N	1772	82	30	2
L-PPLCA-8236-00S-N	2364	82	36	2
One 24" clear acrylic segment on top				
L-PPLCA-6624-00T-N	1317	66	24	2
L-PPLCA-6630-00T-N	1368	66	30	2
L-PPLCA-6636-00T-N	1456	66	36	2
L-PPLCA-6642-00T-N	1646	66	42	2
L-PPLCA-6648-00T-N	1699	66	48	2
Two 8" clear acrylic segments on top				
L-PPLCA-6624-0EE-N	1530	66	24	2
L-PPLCA-6630-0EE-N	1551	66	30	2
L-PPLCA-6636-0EE-N	1873	66	36	2
L-PPLCA-6642-0EE-N	1914	66	42	2
L-PPLCA-6648-0EE-N	1977	66	48	2
One 8" & One 16" clear acrylic segment on top				
L-PPLCA-6624-0ES-N	1538	66	24	2
L-PPLCA-6630-0ES-N	1602	66	30	2
L-PPLCA-6636-0ES-N	1950	66	36	2
L-PPLCA-6642-0ES-N	2017	66	42	2
L-PPLCA-6648-0ES-N	2081	66	48	2
Two 16" clear acrylic segments on top				
L-PPLCA-8224-0SS-N	1599	82	24	2
L-PPLCA-8230-0SS-N	1679	82	30	2
L-PPLCA-8236-0SS-N	2064	82	36	2
One 24" & One 16" clear acrylic segment on top				
L-PPLCA-8224-0TS-N	1636	82	24	2
L-PPLCA-8230-0TS-N	1742	82	30	2
L-PPLCA-8236-0TS-N	2074	82	36	2
Two 24" clear acrylic segments on top				
L-PPLCA-8224-0TT-N	1564	82	24	2
L-PPLCA-8230-0TT-N	1655	82	30	2
L-PPLCA-8236-0TT-N	1945	82	36	2
One 8" & Two 16" clear acrylic segments on top				
L-PPLCA-8224-ESS-N	1706	82	24	2
L-PPLCA-8230-ESS-N	1892	82	30	2
L-PPLCA-8236-ESS-N	2237	82	36	2
Three 16" clear acrylic segments on top				
L-PPLCA-8224-SSS-N	1672	82	24	2
L-PPLCA-8230-SSS-N	1771	82	30	2
L-PPLCA-8236-SSS-N	2146	82	36	2

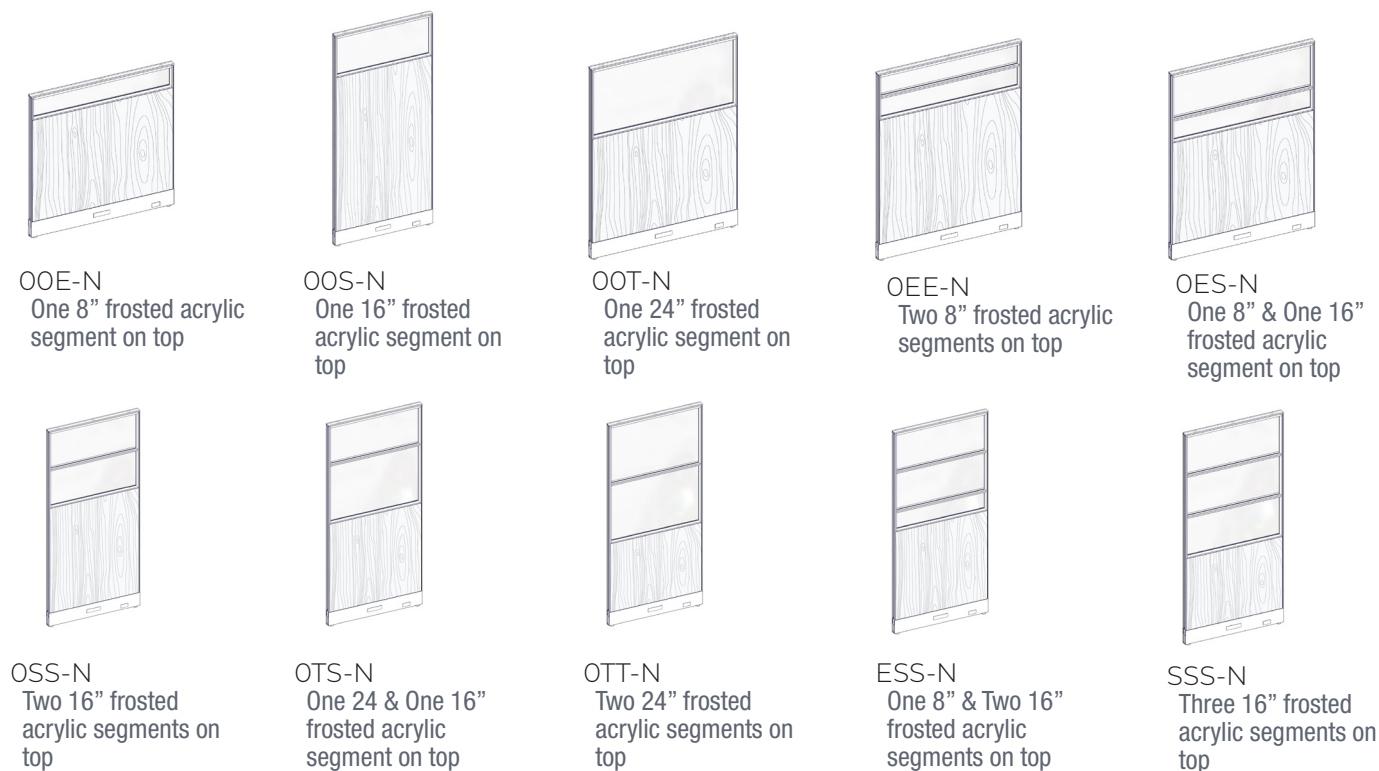

How to order and read your code

L - P P L F A - 42 24 - 00E - N

product standard P=glazed F=Fabric C=Clear A=Acrylic height width 0=No segment N=Non powered
 line E=Elevated L=Laminate F=Frosted G=Glass E=8 inch segment E=Powered
 S=16 inch segment
 T=24 inch segment

What's Included:

One (1) 2" thick laminate panel with 1" incremented slotted channels,
 Two (2) raceway covers,
 One (1) top trim

How to Specify:

Refer to laminate cards for laminate selections
 Choose White, Black, Silver, Charcoal for Panel Frame colour

Options:

Height*: 34", 42", 50", 66", 82"
 Width: 24", 30", 36", 42", 48",
 Laminate
 Metal Powder Coat Paint: White, Black, Silver, Charcoal

*82"H available up to 36"W

Code	Price	H	W	D
One 8" frosted acrylic segment on top				
L-PPLFA-4224-00E-N	1272	42	24	2
L-PPLFA-4230-00E-N	1303	42	30	2
L-PPLFA-4236-00E-N	1364	42	36	2
L-PPLFA-4242-00E-N	1515	42	42	2
L-PPLFA-4248-00E-N	1548	42	48	2
L-PPLFA-5024-00E-N	1315	50	24	2
L-PPLFA-5030-00E-N	1345	50	30	2
L-PPLFA-5036-00E-N	1409	50	36	2
L-PPLFA-5042-00E-N	1585	50	42	2
L-PPLFA-5048-00E-N	1618	50	48	2
One 16" frosted acrylic segment on top				
L-PPLFA-5024-00S-N	1331	50	24	2
L-PPLFA-5030-00S-N	1374	50	30	2
L-PPLFA-5036-00S-N	1445	50	36	2
L-PPLFA-5042-00S-N	1602	50	42	2
L-PPLFA-5048-00S-N	1644	50	48	2
L-PPLFA-6624-00S-N	1445	66	24	2
L-PPLFA-6630-00S-N	1487	66	30	2
L-PPLFA-6636-00S-N	1574	66	36	2
L-PPLFA-6642-00S-N	1804	66	42	2
L-PPLFA-6648-00S-N	1849	66	48	2
L-PPLFA-8224-00S-N	1794	82	24	2
L-PPLFA-8230-00S-N	1828	82	30	2
L-PPLFA-8236-00S-N	2431	82	36	2
One 24" frosted acrylic segment on top				
L-PPLFA-6624-00T-N	1433	66	24	2
L-PPLFA-6630-00T-N	1486	66	30	2
L-PPLFA-6636-00T-N	1560	66	36	2
L-PPLFA-6642-00T-N	1763	66	42	2
L-PPLFA-6648-00T-N	1816	66	48	2
Two 8" frosted acrylic segments on top				
L-PPLFA-6624-0EE-N	1601	66	24	2
L-PPLFA-6630-0EE-N	1644	66	30	2
L-PPLFA-6636-0EE-N	1996	66	36	2
L-PPLFA-6642-0EE-N	2033	66	42	2
L-PPLFA-6648-0EE-N	2117	66	48	2
One 8" & One 16" frosted acrylic segment on top				
L-PPLFA-6624-0ES-N	1598	66	24	2
L-PPLFA-6630-0ES-N	1682	66	30	2
L-PPLFA-6636-0ES-N	2044	66	36	2
L-PPLFA-6642-0ES-N	2132	66	42	2
L-PPLFA-6648-0ES-N	2199	66	48	2
Two 16" frosted acrylic segments on top				
L-PPLFA-8224-0SS-N	1488	82	24	2
L-PPLFA-8230-0SS-N	1522	82	30	2
L-PPLFA-8236-0SS-N	1854	82	36	2
One 24" & One 16" frosted acrylic segment on top				
L-PPLFA-8224-0TS-N	1754	82	24	2
L-PPLFA-8230-0TS-N	1899	82	30	2
L-PPLFA-8236-0TS-N	2231	82	36	2
Two 24" frosted acrylic segments on top				
L-PPLFA-8224-0TT-N	1682	82	24	2
L-PPLFA-8230-0TT-N	1814	82	30	2
L-PPLFA-8236-0TT-N	2132	82	36	2
One 8" & Two 16" frosted acrylic segments on top				
L-PPLFA-8224-ESS-N	1825	82	24	2
L-PPLFA-8230-ESS-N	2048	82	30	2
L-PPLFA-8236-ESS-N	2395	82	36	2
Three 16" frosted acrylic segments on top				
L-PPLFA-8224-SSS-N	1790	82	24	2
L-PPLFA-8230-SSS-N	1929	82	30	2
L-PPLFA-8236-SSS-N	2383	82	36	2

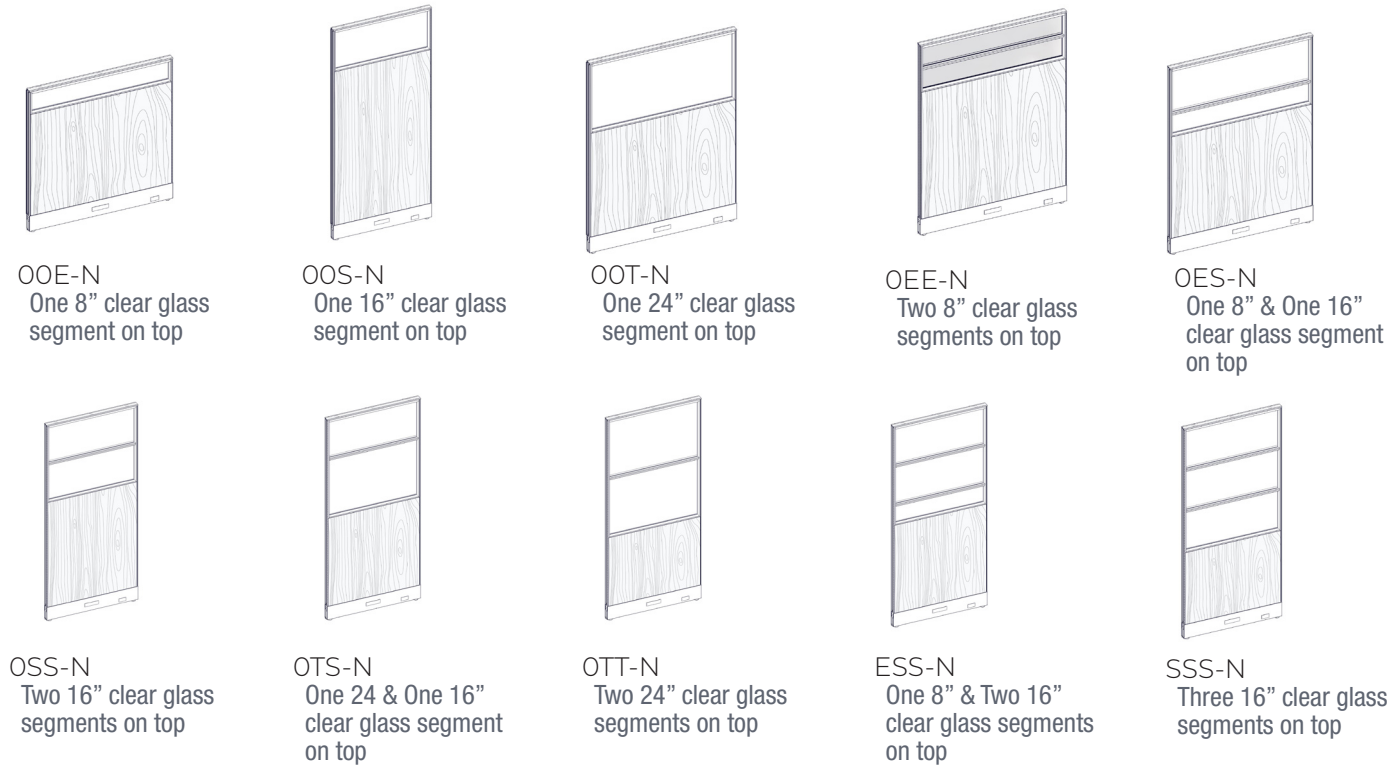

How to order and read your code

L	-	P	P	L	C	G	-	42	24	-	00E	-	N
product line	standard	P=glazed E=Elevated	F=Fabric L=Laminate	C=Clear F=Frosted	A=Acrylic G=Glass	height	width	0 = No segment E = 8 inch segment S = 16 inch segment T = 24 inch segment					N=Non powered E=Powered

What's Included:

One (1) 2" thick laminate panel with 1" incremented slotted channels,
Two (2) raceway covers,
One (1) top trim

How to Specify:

Refer to laminate cards for laminate selections
Choose White, Black, Silver, Charcoal for Panel Frame colour

Options:

Height*:	34", 42", 50", 66", 82"
Width:	24", 30", 36", 42", 48",
Laminate	
Metal Powder Coat Paint:	White, Black, Silver, Charcoal

*82"H available up to 36"W

Code	Price	H	W	D
One 8" clear glass segment on top				
L-PPLCG-4224-00E-N	1254	42	24	2
L-PPLCG-4230-00E-N	1300	42	30	2
L-PPLCG-4236-00E-N	1381	42	36	2
L-PPLCG-4242-00E-N	1551	42	42	2
L-PPLCG-4248-00E-N	1603	42	48	2
L-PPLCG-5024-00E-N	1292	50	24	2
L-PPLCG-5030-00E-N	1343	50	30	2
L-PPLCG-5036-00E-N	1431	50	36	2
L-PPLCG-5042-00E-N	1618	50	42	2
L-PPLCG-5048-00E-N	1673	50	48	2
One 16" clear glass segment on top				
L-PPLCG-5024-00S-N	1370	50	24	2
L-PPLCG-5030-00S-N	1444	50	30	2
L-PPLCG-5036-00S-N	1550	50	36	2
L-PPLCG-5042-00S-N	1737	50	42	2
L-PPLCG-5048-00S-N	1814	50	48	2
L-PPLCG-6624-00S-N	1482	66	24	2
L-PPLCG-6630-00S-N	1559	66	30	2
L-PPLCG-6636-00S-N	1676	66	36	2
L-PPLCG-6642-00S-N	1937	66	42	2
L-PPLCG-6648-00S-N	2013	66	48	2
L-PPLCG-8224-00S-N	1707	82	24	2
L-PPLCG-8230-00S-N	1757	82	30	2
L-PPLCG-8236-00S-N	2372	82	36	2
One 24" clear glass segment on top				
L-PPLCG-6624-00T-N	1529	66	24	2
L-PPLCG-6630-00T-N	1628	66	30	2
L-PPLCG-6636-00T-N	1757	66	36	2
L-PPLCG-6642-00T-N	1996	66	42	2
L-PPLCG-6648-00T-N	2098	66	48	2
Two 8" clear glass segments on top				
L-PPLCG-6624-0EE-N	1642	66	24	2
L-PPLCG-6630-0EE-N	1698	66	30	2
L-PPLCG-6636-0EE-N	2048	66	36	2
L-PPLCG-6642-0EE-N	2103	66	42	2
L-PPLCG-6648-0EE-N	2185	66	48	2
One 8" & One 16" clear glass segment on top				
L-PPLCG-6624-0ES-N	1642	66	24	2
L-PPLCG-6630-0ES-N	1720	66	30	2
L-PPLCG-6636-0ES-N	2087	66	36	2
L-PPLCG-6642-0ES-N	2158	66	42	2
L-PPLCG-6648-0ES-N	2258	66	48	2
Two 16" clear glass segments on top				
L-PPLCG-8224-0SS-N	1701	82	24	2
L-PPLCG-8230-0SS-N	1778	82	30	2
L-PPLCG-8236-0SS-N	2161	82	36	2
One 24" & One 16" clear glass segment on top				
L-PPLCG-8224-0TS-N	1736	82	24	2
L-PPLCG-8230-0TS-N	1842	82	30	2
L-PPLCG-8236-0TS-N	2232	82	36	2
Two 24" clear glass segments on top				
L-PPLCG-8224-0TT-N	1701	82	24	2
L-PPLCG-8230-0TT-N	1812	82	30	2
L-PPLCG-8236-0TT-N	2120	82	36	2
One 8" & Two 16" clear glass segments on top				
L-PPLCG-8224-0SS-N	1905	82	24	2
L-PPLCG-8230-0SS-N	2081	82	30	2
L-PPLCG-8236-0SS-N	2486	82	36	2
Three 16" clear glass segments on top				
L-PPLCG-8224-0SS-N	1879	82	24	2
L-PPLCG-8230-0SS-N	1982	82	30	2
L-PPLCG-8236-0SS-N	2318	82	36	2

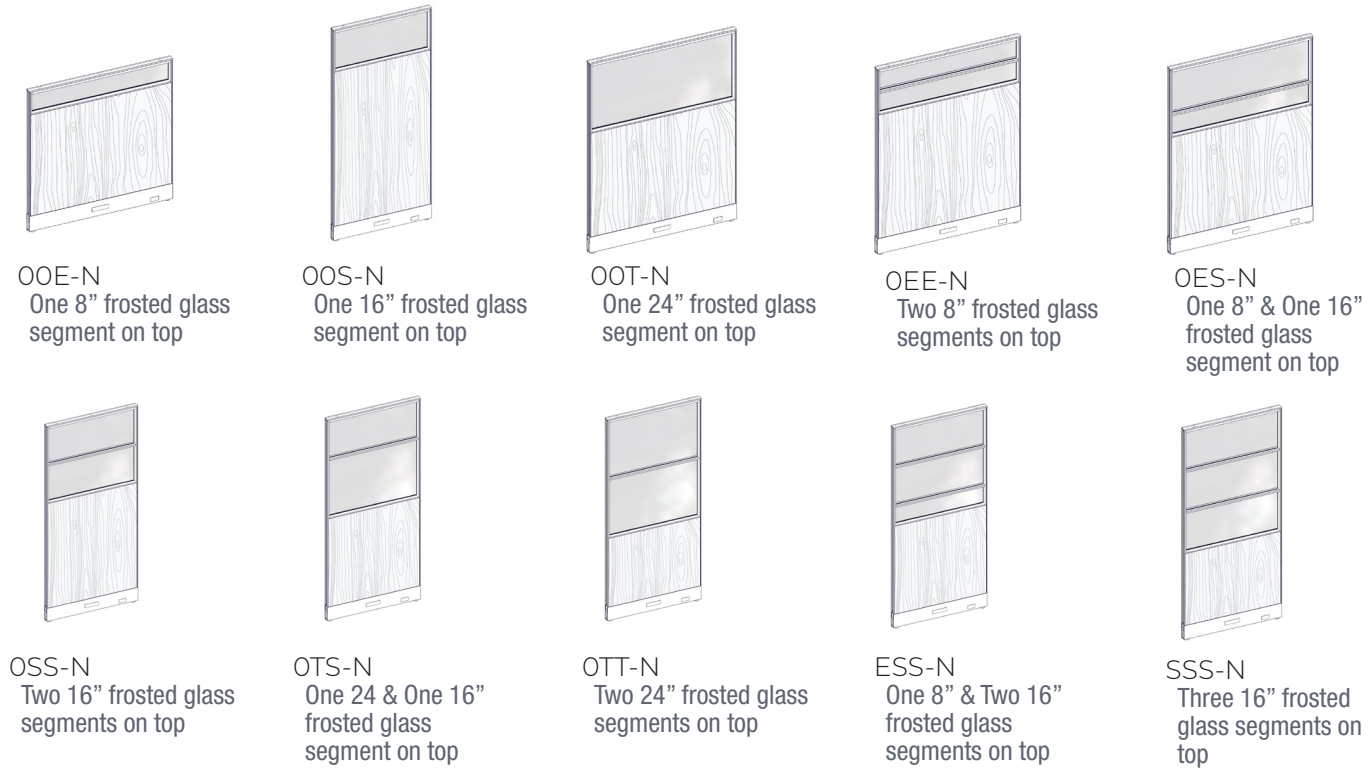

How to order and read your code

L - P P L F G - 42 24 - 00E - N

product standard P=glazed F=Fabric C=Clear A=Acrylic height width 0=No segment N=Non powered
 line E=Elevated L=Laminate F=Frosted G=Glass E=Powered
 S=16 inch segment
 T=24 inch segment

What's Included:

One (1) 2" thick laminate panel with 1" incremented slotted channels,
 Two (2) raceway covers,
 One (1) top trim

How to Specify:

Refer to laminate cards for laminate selections
 Choose White, Black, Silver, Charcoal for Panel Frame colour

Options:

Height*: 34", 42", 50", 66", 82"

Width: 24", 30", 36", 42", 48",

Laminate

Metal Powder Coat Paint: White, Black, Silver, Charcoal

*82"H available up to 36"W

Code	Price	H	W	D
One 8" frosted glass segment on top				
L-PPLFG-4224-00E-N	1368	42	24	2
L-PPLFG-4230-00E-N	1416	42	30	2
L-PPLFG-4236-00E-N	1498	42	36	2
L-PPLFG-4242-00E-N	1669	42	42	2
L-PPLFG-4248-00E-N	1720	42	48	2
L-PPLFG-5024-00E-N	1408	50	24	2
L-PPLFG-5030-00E-N	1460	50	30	2
L-PPLFG-5036-00E-N	1547	50	36	2
L-PPLFG-5042-00E-N	1733	50	42	2
L-PPLFG-5048-00E-N	1790	50	48	2
One 16" frosted glass segment on top				
L-PPLFG-5024-00S-N	1487	50	24	2
L-PPLFG-5030-00S-N	1560	50	30	2
L-PPLFG-5036-00S-N	1667	50	36	2
L-PPLFG-5042-00S-N	1854	50	42	2
L-PPLFG-5048-00S-N	1929	50	48	2
L-PPLFG-6624-00S-N	1599	66	24	2
L-PPLFG-6630-00S-N	1674	66	30	2
L-PPLFG-6636-00S-N	1793	66	36	2
L-PPLFG-6642-00S-N	2054	66	42	2
L-PPLFG-6648-00S-N	2129	66	48	2
L-PPLFG-8224-00S-N	1804	82	24	2
L-PPLFG-8230-00S-N	1863	82	30	2
L-PPLFG-8236-00S-N	2498	82	36	2
One 24" frosted glass segment on top				
L-PPLFG-6624-00T-N	1646	66	24	2
L-PPLFG-6630-00T-N	1745	66	30	2
L-PPLFG-6636-00T-N	1874	66	36	2
L-PPLFG-6642-00T-N	2111	66	42	2
L-PPLFG-6648-00T-N	2214	66	48	2
Two 8" frosted glass segments on top				
L-PPLFG-6624-0EE-N	1831	66	24	2
L-PPLFG-6630-0EE-N	1888	66	30	2
L-PPLFG-6636-0EE-N	2237	66	36	2
L-PPLFG-6642-0EE-N	2294	66	42	2
L-PPLFG-6648-0EE-N	2375	66	48	2
One 8" & One 16" frosted glass segment on top				
L-PPLFG-6624-0ES-N	1831	66	24	2
L-PPLFG-6630-0ES-N	1921	66	30	2
L-PPLFG-6636-0ES-N	2310	66	36	2
L-PPLFG-6642-0ES-N	2401	66	42	2
L-PPLFG-6648-0ES-N	2524	66	48	2
Two 16" frosted glass segments on top				
L-PPLFG-8224-0SS-N	1892	82	24	2
L-PPLFG-8230-0SS-N	1988	82	30	2
L-PPLFG-8236-0SS-N	2415	82	36	2
One 24" & One 16" frosted glass segment on top				
L-PPLFG-8224-0TS-N	1958	82	24	2
L-PPLFG-8230-0TS-N	2104	82	30	2
L-PPLFG-8236-0TS-N	2552	82	36	2
Two 24" frosted glass segments on top				
L-PPLFG-8224-0TT-N	1957	82	24	2
L-PPLFG-8230-0TT-N	2128	82	30	2
L-PPLFG-8236-0TT-N	2503	82	36	2
One 8" & Two 16" frosted glass segments on top				
L-PPLFG-8224-ESS-N	2192	82	24	2
L-PPLFG-8230-ESS-N	2387	82	30	2
L-PPLFG-8236-ESS-N	2836	82	36	2
Three 16" frosted glass segments on top				
L-PPLFG-8224-SSS-N	2166	82	24	2
L-PPLFG-8230-SSS-N	2298	82	30	2
L-PPLFG-8236-SSS-N	2699	82	36	2

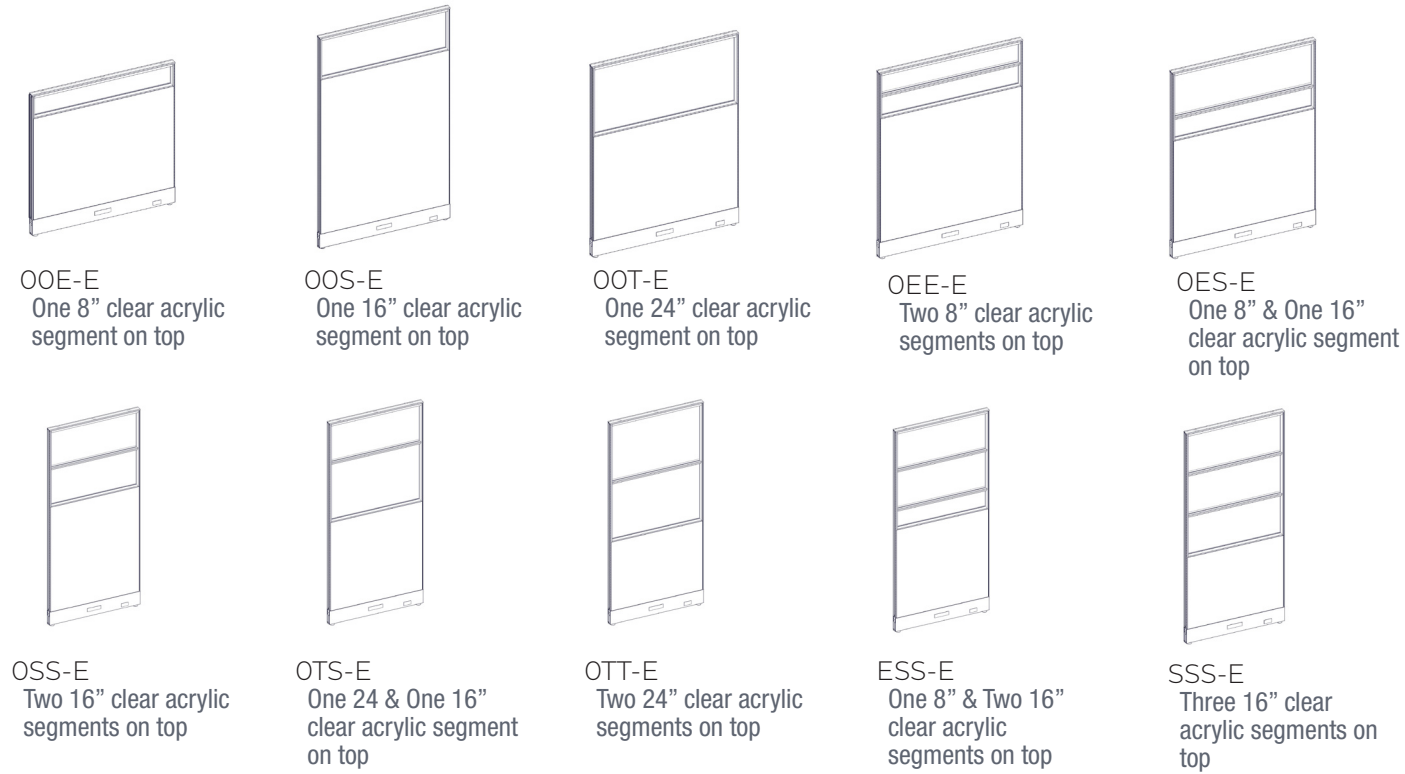

How to order and read your code

L - P P F C A - 42 24 - 00E - E

product standard P= glazed F=Fabric C=Clear A=Acrylic height width 0 = No segment N=Non powered
 line E = Elevated L=Laminate F=Frosted G=Glass E = 8 inch segment E=Powered
 S = 16 inch segment
 T = 24 inch segment

What's Included:

One (1) 2" thick laminate panel with 1" incremented slotted channels,
 Two (2) raceway covers,
 One (1) top trim

How to Specify:

Refer to laminate cards for laminate selections
 Choose White, Black, Silver, Charcoal for Panel Frame colour

Options:

Height*: 34", 42", 50", 66", 82"

Width: 24", 30", 36", 42", 48",

Laminate

Metal Powder Coat Paint: White, Black, Silver, Charcoal

*82"H available up to 36"W

Code	Price	H	W	D
One 8" clear acrylic segment on top				
L-PPFCA-4224-00E-E	942	42	24	2
L-PPFCA-4230-00E-E	1033	42	30	2
L-PPFCA-4236-00E-E	1124	42	36	2
L-PPFCA-4242-00E-E	1215	42	42	2
L-PPFCA-4248-00E-E	1307	42	48	2
L-PPFCA-4254-00E-E	1402	42	54	2
L-PPFCA-4260-00E-E	1492	42	60	2
L-PPFCA-5024-00E-E	942	50	24	2
L-PPFCA-5030-00E-E	1033	50	30	2
L-PPFCA-5036-00E-E	1124	50	36	2
L-PPFCA-5042-00E-E	1215	50	42	2
L-PPFCA-5048-00E-E	1307	50	48	2
L-PPFCA-5054-00E-E	1402	50	54	2
L-PPFCA-5060-00E-E	1492	50	60	2
One 16" clear acrylic segment on top				
L-PPFCA-5024-00S-E	942	50	24	2
L-PPFCA-5030-00S-E	1033	50	30	2
L-PPFCA-5036-00S-E	1124	50	36	2
L-PPFCA-5042-00S-E	1215	50	42	2
L-PPFCA-5048-00S-E	1307	50	48	2
L-PPFCA-5054-00S-E	1402	50	54	2
L-PPFCA-5060-00S-E	1492	50	60	2
L-PPFCA-6624-00S-E	1089	66	24	2
L-PPFCA-6630-00S-E	1203	66	30	2
L-PPFCA-6636-00S-E	1318	66	36	2
L-PPFCA-6642-00S-E	1433	66	42	2
L-PPFCA-6648-00S-E	1549	66	48	2
L-PPFCA-6654-00S-E	1664	66	54	2
L-PPFCA-6660-00S-E	1780	66	60	2
L-PPFCA-8224-00S-E	1694	82	24	2
L-PPFCA-8230-00S-E	1963	82	30	2
L-PPFCA-8236-00S-E	2064	82	36	2
L-PPFCA-8242-00S-E	2115	82	42	2
L-PPFCA-8248-00S-E	2208	82	48	2
One 24" clear acrylic segment on top				
L-PPFCA-6624-00T-E	1089	66	24	2
L-PPFCA-6630-00T-E	1203	66	30	2
L-PPFCA-6636-00T-E	1318	66	36	2
L-PPFCA-6642-00T-E	1433	66	42	2
L-PPFCA-6648-00T-E	1549	66	48	2
L-PPFCA-6654-00T-E	1664	66	54	2
L-PPFCA-6660-00T-E	1780	66	60	2

Code	Price	H	W	D
Two 8" clear acrylic segments on top				
L-PPFCA-6624-0EE-E	1674	66	24	2
L-PPFCA-6630-0EE-E	1893	66	30	2
L-PPFCA-6636-0EE-E	1973	66	36	2
L-PPFCA-6642-0EE-E	2038	66	42	2
L-PPFCA-6648-0EE-E	2126	66	48	2
L-PPFCA-6654-0EE-E	2260	66	54	2
L-PPFCA-6660-0EE-E	2320	66	60	2
One 8" & One 16" clear acrylic segment on top				
L-PPFCA-6624-0ES-E	1636	66	24	2
L-PPFCA-6630-0ES-E	1846	66	30	2
L-PPFCA-6636-0ES-E	1940	66	36	2
L-PPFCA-6642-0ES-E	2033	66	42	2
L-PPFCA-6648-0ES-E	2130	66	48	2
L-PPFCA-6654-0ES-E	2232	66	54	2
L-PPFCA-6660-0ES-E	2281	66	60	2
Two 16" clear acrylic segments on top				
L-PPFCA-8224-0SS-E	1742	82	24	2
L-PPFCA-8230-0SS-E	2024	82	30	2
L-PPFCA-8236-0SS-E	2166	82	36	2
L-PPFCA-8242-0SS-E	2228	82	42	2
L-PPFCA-8248-0SS-E	2317	82	48	2
One 24" & One 16" clear acrylic segment on top				
L-PPFCA-8224-0TS-E	1731	82	24	2
L-PPFCA-8230-0TS-E	1985	82	30	2
L-PPFCA-8236-0TS-E	2064	82	36	2
L-PPFCA-8242-0TS-E	2127	82	42	2
L-PPFCA-8248-0TS-E	2340	82	48	2
Two 24" clear acrylic segments on top				
L-PPFCA-8224-0TT-E	1727	82	24	2
L-PPFCA-8230-0TT-E	1957	82	30	2
L-PPFCA-8236-0TT-E	2059	82	36	2
L-PPFCA-8242-0TT-E	2194	82	42	2
L-PPFCA-8248-0TT-E	2280	82	48	2
One 8" & Two 16" clear acrylic segments on top				
L-PPFCA-8224-ESS-E	1803	82	24	2
L-PPFCA-8230-ESS-E	2140	82	30	2
L-PPFCA-8236-ESS-E	2228	82	36	2
L-PPFCA-8242-ESS-E	2231	82	42	2
L-PPFCA-8248-ESS-E	2444	82	48	2
Three 16" clear acrylic segments on top				
L-PPFCA-8224-SSS-E	1833	82	24	2
L-PPFCA-8230-SSS-E	2073	82	30	2
L-PPFCA-8236-SSS-E	2262	82	36	2
L-PPFCA-8242-SSS-E	2337	82	42	2
L-PPFCA-8248-SSS-E	2436	82	48	2

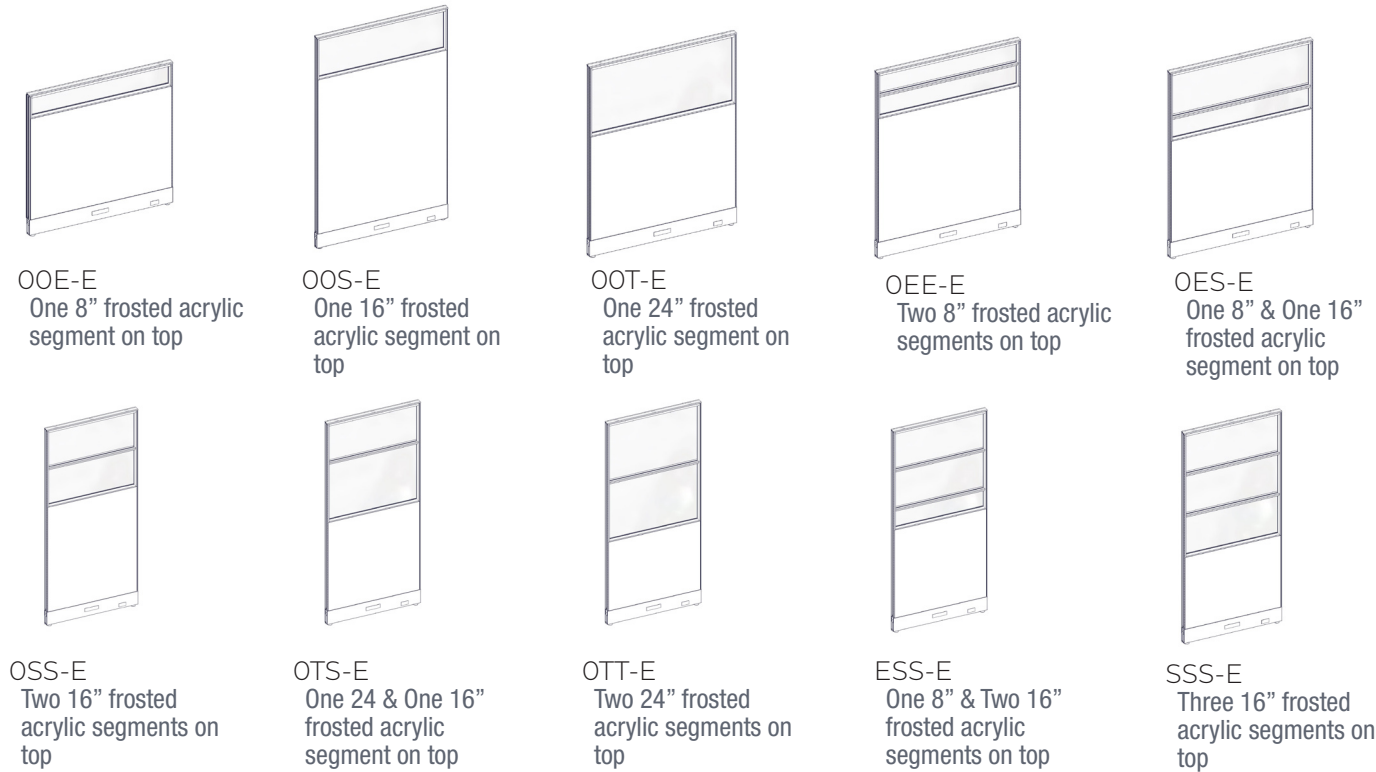

How to order and read your code

L - P P F F A - 42 24 - 00E - E

product standard P=glazed F=Fabric C=Clear A=Acrylic height width 0=No segment N=Non powered
 line E=Elevated L=Laminate F=Frosted G=Glass E=8 inch segment E=Powered
 S=16 inch segment
 T=24 inch segment

What's Included:

One (1) 2" thick laminate panel with 1" incremented slotted channels,
 Two (2) raceway covers,
 One (1) top trim

How to Specify:

Refer to laminate cards for laminate selections
 Choose White, Black, Silver, Charcoal for Panel Frame colour

Options:

Height*:	34", 42", 50", 66", 82"
Width:	24", 30", 36", 42", 48",
Laminate	
Metal Powder Coat Paint:	White, Black, Silver, Charcoal

*82"H available up to 36"W

Code	Price	H	W	D
One 8" frosted acrylic segment on top				
L-PPFFA-4224-00E-E	1058	42	24	2
L-PPFFA-4230-00E-E	1149	42	30	2
L-PPFFA-4236-00E-E	1240	42	36	2
L-PPFFA-4242-00E-E	1332	42	42	2
L-PPFFA-4248-00E-E	1422	42	48	2
L-PPFFA-4254-00E-E	1518	42	54	2
L-PPFFA-4260-00E-E	1607	42	60	2
One 16" frosted acrylic segment on top				
L-PPFFA-5024-00E-E	1058	50	24	2
L-PPFFA-5030-00E-E	1149	50	30	2
L-PPFFA-5036-00E-E	1240	50	36	2
L-PPFFA-5042-00E-E	1332	50	42	2
L-PPFFA-5048-00E-E	1422	50	48	2
L-PPFFA-5054-00E-E	1518	50	54	2
L-PPFFA-5060-00E-E	1607	50	60	2
One 8" & One 16" frosted acrylic segment on top				
L-PPFFA-6624-0EE-E	1744	66	24	2
L-PPFFA-6630-0EE-E	1986	66	30	2
L-PPFFA-6636-0EE-E	2096	66	36	2
L-PPFFA-6642-0EE-E	2158	66	42	2
L-PPFFA-6648-0EE-E	2266	66	48	2
L-PPFFA-6654-0EE-E	2359	66	54	2
L-PPFFA-6660-0EE-E	2417	66	60	2
One 8" & One 16" frosted acrylic segment on top				
L-PPFFA-6624-0ES-E	1693	66	24	2
L-PPFFA-6630-0ES-E	1926	66	30	2
L-PPFFA-6636-0ES-E	2034	66	36	2
L-PPFFA-6642-0ES-E	2152	66	42	2
L-PPFFA-6648-0ES-E	2248	66	48	2
L-PPFFA-6654-0ES-E	2363	66	54	2
L-PPFFA-6660-0ES-E	2435	66	60	2
Two 16" frosted acrylic segments on top				
L-PPFFA-8224-0SS-E	1630	82	24	2
L-PPFFA-8230-0SS-E	1864	82	30	2
L-PPFFA-8236-0SS-E	1955	82	36	2
L-PPFFA-8242-0SS-E	2026	82	42	2
L-PPFFA-8248-0SS-E	2102	82	48	2
One 24" & One 16" frosted acrylic segment on top				
L-PPFFA-8224-0TS-E	1849	82	24	2
L-PPFFA-8230-0TS-E	2143	82	30	2
L-PPFFA-8236-0TS-E	2220	82	36	2
L-PPFFA-8242-0TS-E	2323	82	42	2
L-PPFFA-8248-0TS-E	2578	82	48	2
Two 24" frosted acrylic segments on top				
L-PPFFA-8224-0TT-E	1844	82	24	2
L-PPFFA-8230-0TT-E	2115	82	30	2
L-PPFFA-8236-0TT-E	2248	82	36	2
L-PPFFA-8242-0TT-E	2429	82	42	2
L-PPFFA-8248-0TT-E	2514	82	48	2
One 8" & Two 16" frosted acrylic segments on top				
L-PPFFA-8224-0SS-E	1921	82	24	2
L-PPFFA-8230-0SS-E	2294	82	30	2
L-PPFFA-8236-0SS-E	2385	82	36	2
L-PPFFA-8242-0SS-E	2460	82	42	2
L-PPFFA-8248-0SS-E	2599	82	48	2
Three 16" frosted acrylic segments on top				
L-PPFFA-8224-0SS-E	1952	82	24	2
L-PPFFA-8230-0SS-E	2228	82	30	2
L-PPFFA-8236-0SS-E	2499	82	36	2
L-PPFFA-8242-0SS-E	2572	82	42	2
L-PPFFA-8248-0SS-E	2672	82	48	2
One 24" frosted acrylic segment on top				
L-PPFFA-6624-00T-E	1206	66	24	2
L-PPFFA-6630-00T-E	1319	66	30	2
L-PPFFA-6636-00T-E	1434	66	36	2
L-PPFFA-6642-00T-E	1494	66	42	2
L-PPFFA-6648-00T-E	1612	66	48	2
L-PPFFA-6654-00T-E	1780	66	54	2
L-PPFFA-6660-00T-E	1896	66	60	2

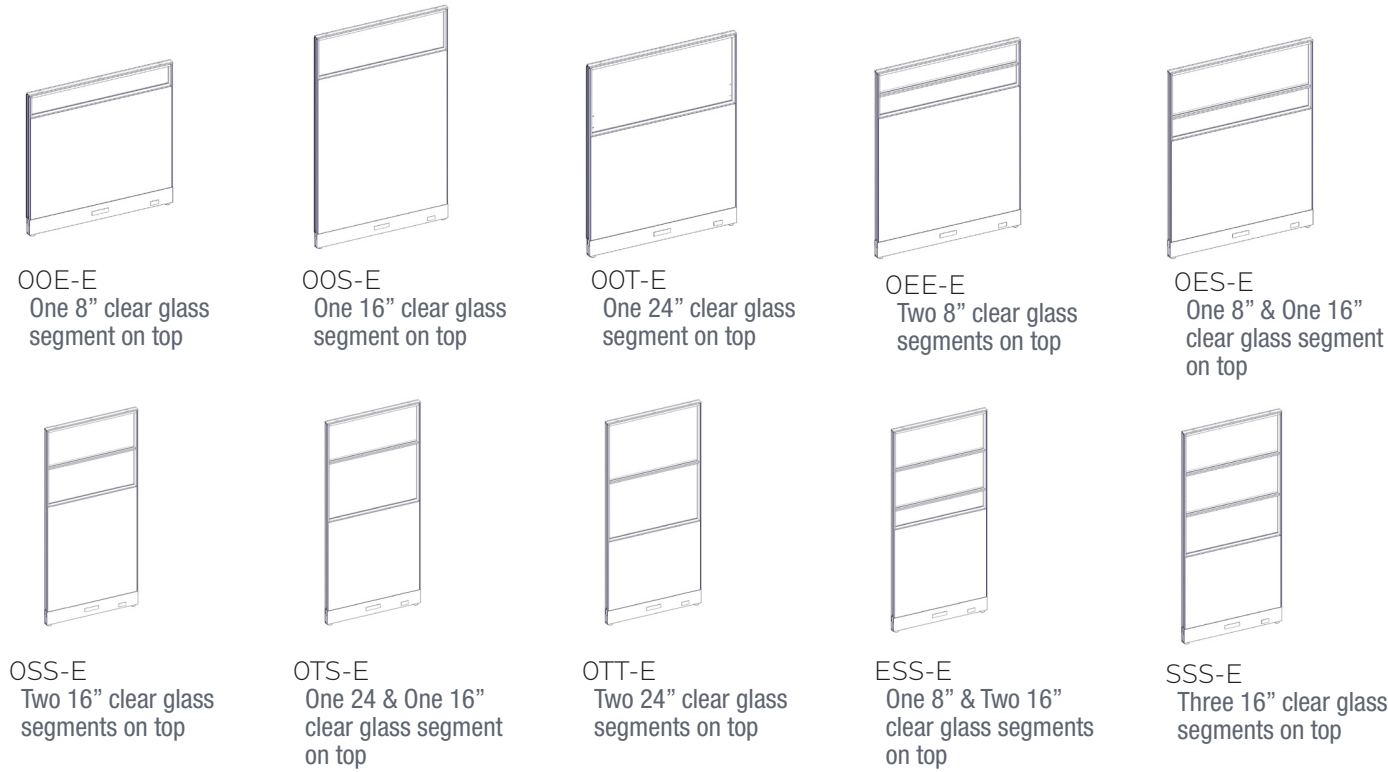

How to order and read your code

L - P P F C G - 42 24 - 00E - E

product standard P= glazed F=Fabric C=Clear A=Acrylic height width 0= No segment N=Non powered
 line line E = Elevated L=Laminate F=Frosted G=Glass E = 8 inch segment E=Powered
 S = 16 inch segment
 T = 24 inch segment

What's Included:

One (1) 2" thick laminate panel with 1" incremented slotted channels,
 Two (2) raceway covers,
 One (1) top trim

How to Specify:

Refer to laminate cards for laminate selections
 Choose White, Black, Silver, Charcoal for Panel Frame colour

Options:

Height*: 34", 42", 50", 66", 82"

Width: 24", 30", 36", 42", 48",

Laminate

Metal Powder Coat Paint: White, Black, Silver, Charcoal

*82"H available up to 36"W

Code	Price	H	W	D
One 8" clear glass segment on top				
L-PPFCG-4224-00E-E	1095	42	24	2
L-PPFCG-4230-00E-E	1187	42	30	2
L-PPFCG-4236-00E-E	1280	42	36	2
L-PPFCG-4242-00E-E	1370	42	42	2
L-PPFCG-4248-00E-E	1462	42	48	2
L-PPFCG-4254-00E-E	1555	42	54	2
L-PPFCG-4260-00E-E	1644	42	60	2
L-PPFCG-5024-00E-E	1095	50	24	2
L-PPFCG-5030-00E-E	1187	50	30	2
L-PPFCG-5036-00E-E	1280	50	36	2
L-PPFCG-5042-00E-E	1370	50	42	2
L-PPFCG-5048-00E-E	1462	50	48	2
L-PPFCG-5054-00E-E	1555	50	54	2
L-PPFCG-5060-00E-E	1644	50	60	2
One 16" clear glass segment on top				
L-PPFCG-5024-00S-E	1095	50	24	2
L-PPFCG-5030-00S-E	1187	50	30	2
L-PPFCG-5036-00S-E	1280	50	36	2
L-PPFCG-5042-00S-E	1370	50	42	2
L-PPFCG-5048-00S-E	1462	50	48	2
L-PPFCG-5054-00S-E	1555	50	54	2
L-PPFCG-5060-00S-E	1644	50	60	2
L-PPFCG-6624-00S-E	1254	66	24	2
L-PPFCG-6630-00S-E	1366	66	30	2
L-PPFCG-6636-00S-E	1482	66	36	2
L-PPFCG-6642-00S-E	1598	66	42	2
L-PPFCG-6648-00S-E	1716	66	48	2
L-PPFCG-6654-00S-E	1830	66	54	2
L-PPFCG-6660-00S-E	1947	66	60	2
L-PPFCG-8224-00S-E	1648	82	24	2
L-PPFCG-8230-00S-E	1947	82	30	2
L-PPFCG-8236-00S-E	2072	82	36	2
L-PPFCG-8242-00S-E	2141	82	42	2
L-PPFCG-8248-00S-E	2258	82	48	2
One 24" clear glass segment on top				
L-PPFCG-6624-00T-E	1254	66	24	2
L-PPFCG-6630-00T-E	1366	66	30	2
L-PPFCG-6636-00T-E	1482	66	36	2
L-PPFCG-6642-00T-E	1598	66	42	2
L-PPFCG-6648-00T-E	1716	66	48	2
L-PPFCG-6654-00T-E	1830	66	54	2
L-PPFCG-6660-00T-E	1947	66	60	2
Two 8" clear glass segments on top				
L-PPFCG-6624-0EE-E	1783	66	24	2
L-PPFCG-6630-0EE-E	2042	66	30	2
L-PPFCG-6636-0EE-E	2149	66	36	2
L-PPFCG-6642-0EE-E	2227	66	42	2
L-PPFCG-6648-0EE-E	2333	66	48	2
L-PPFCG-6654-0EE-E	2466	66	54	2
L-PPFCG-6660-0EE-E	2539	66	60	2
One 8" & One 16" clear glass segment on top				
L-PPFCG-6624-0ES-E	1737	66	24	2
L-PPFCG-6630-0ES-E	1964	66	30	2
L-PPFCG-6636-0ES-E	2076	66	36	2
L-PPFCG-6642-0ES-E	2177	66	42	2
L-PPFCG-6648-0ES-E	2309	66	48	2
L-PPFCG-6654-0ES-E	2453	66	54	2
L-PPFCG-6660-0ES-E	2532	66	60	2
Two 16" clear glass segments on top				
L-PPFCG-8224-0SS-E	1844	82	24	2
L-PPFCG-8230-0SS-E	2119	82	30	2
L-PPFCG-8236-0SS-E	2262	82	36	2
L-PPFCG-8242-0SS-E	2376	82	42	2
L-PPFCG-8248-0SS-E	2514	82	48	2
One 24" & One 16" clear glass segment on top				
L-PPFCG-8224-0TS-E	1831	82	24	2
L-PPFCG-8230-0TS-E	2085	82	30	2
L-PPFCG-8236-0TS-E	2224	82	36	2
L-PPFCG-8242-0TS-E	2351	82	42	2
L-PPFCG-8248-0TS-E	2507	82	48	2
Two 24" clear glass segments on top				
L-PPFCG-8224-0TT-E	1864	82	24	2
L-PPFCG-8230-0TT-E	2111	82	30	2
L-PPFCG-8236-0TT-E	2239	82	36	2
L-PPFCG-8242-0TT-E	2372	82	42	2
L-PPFCG-8248-0TT-E	2527	82	48	2
One 8" & Two 16" clear glass segments on top				
L-PPFCG-8224-0SS-E	2000	82	24	2
L-PPFCG-8230-0SS-E	2326	82	30	2
L-PPFCG-8236-0SS-E	2478	82	36	2
L-PPFCG-8242-0SS-E	2500	82	42	2
L-PPFCG-8248-0SS-E	2697	82	48	2
Three 16" clear glass segments on top				
L-PPFCG-8224-0SS-E	2043	82	24	2
L-PPFCG-8230-0SS-E	2281	82	30	2
L-PPFCG-8236-0SS-E	2436	82	36	2
L-PPFCG-8242-0SS-E	2583	82	42	2
L-PPFCG-8248-0SS-E	2760	82	48	2

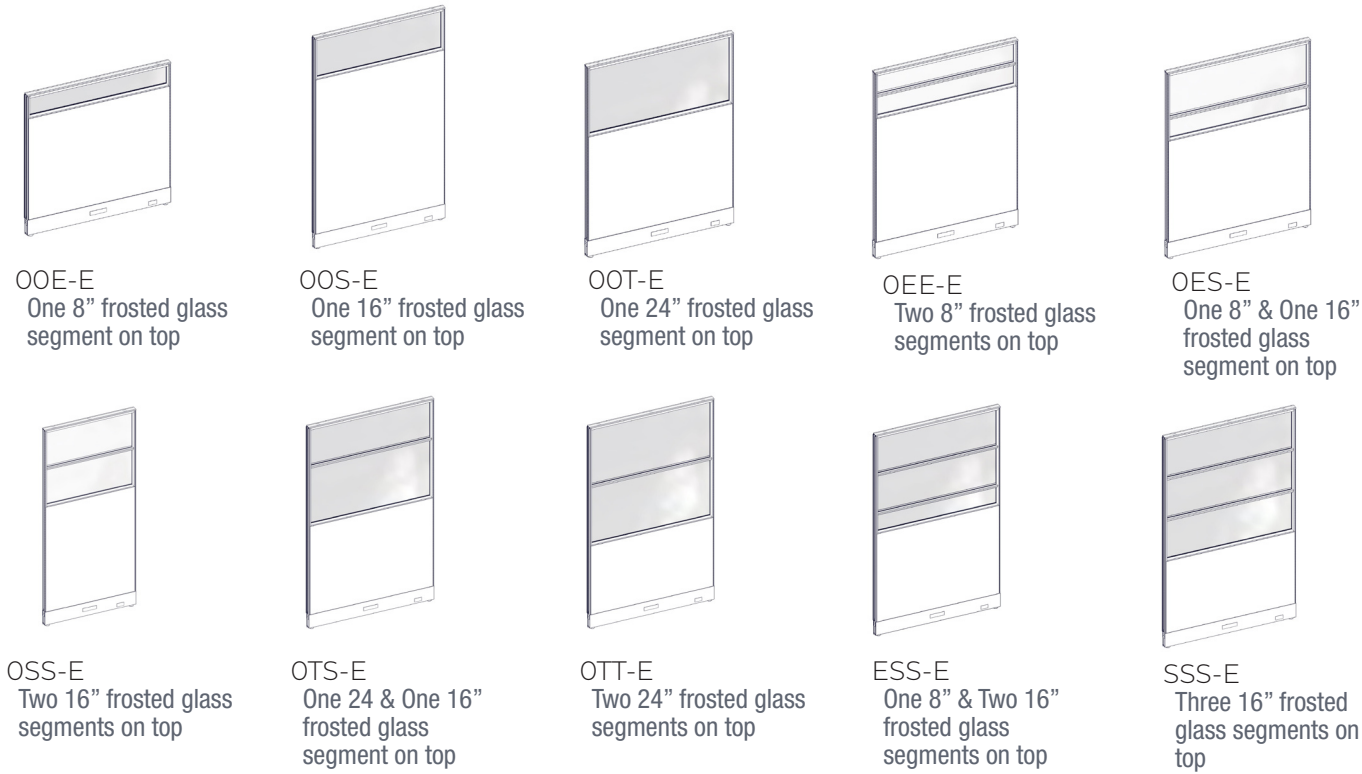

How to order and read your code

L - P P F F G - 42 24 - 00E - E

product standard P=glazed F=Fabric C=Clear A=Acrylic height width 0=No segment N=Non powered
line E=Elevated L=Laminate F=Frosted G=Glass E=8 inch segment E=Powered
S=16 inch segment
T=24 inch segment

What's Included:

One (1) 2" thick laminate panel with 1" incremented slotted channels,
Two (2) raceway covers,
One (1) top trim

How to Specify:

Refer to laminate cards for laminate selections
Choose White, Black, Silver, Charcoal for Panel Frame colour

Options:

Height*: 34", 42", 50", 66", 82"

Width: 24", 30", 36", 42", 48",

Laminate

Metal Powder Coat Paint: White, Black, Silver, Charcoal

*82"H available up to 36"W

Notes:

Power capable panel with bracket for power module.
Power module must be specified seperately.
Panels are non tackable. For tackable option see Panel Add-On section.
Fabric Upcharge
Grade 2 - \$226 per panel,
Grade 3- \$278 per panel

Code	Price	H	W	D
One 8" frosted glass segment on top				
L-PPFFG-4224-00E-E	1212	42	24	2
L-PPFFG-4230-00E-E	1303	42	30	2
L-PPFFG-4236-00E-E	1395	42	36	2
L-PPFFG-4242-00E-E	1487	42	42	2
L-PPFFG-4248-00E-E	1577	42	48	2
L-PPFFG-4254-00E-E	1672	42	54	2
L-PPFFG-4260-00E-E	1760	42	60	2
L-PPFFG-5024-00E-E	1212	50	24	2
L-PPFFG-5030-00E-E	1303	50	30	2
L-PPFFG-5036-00E-E	1395	50	36	2
L-PPFFG-5042-00E-E	1487	50	42	2
L-PPFFG-5048-00E-E	1577	50	48	2
L-PPFFG-5054-00E-E	1672	50	54	2
L-PPFFG-5060-00E-E	1760	50	60	2
One 16" frosted glass segment on top				
L-PPFFG-5024-00S-E	1212	50	24	2
L-PPFFG-5030-00S-E	1303	50	30	2
L-PPFFG-5036-00S-E	1395	50	36	2
L-PPFFG-5042-00S-E	1487	50	42	2
L-PPFFG-5048-00S-E	1577	50	48	2
L-PPFFG-5054-00S-E	1672	50	54	2
L-PPFFG-5060-00S-E	1760	50	60	2
L-PPFFG-6624-00S-E	1368	66	24	2
L-PPFFG-6630-00S-E	1482	66	30	2
L-PPFFG-6636-00S-E	1599	66	36	2
L-PPFFG-6642-00S-E	1715	66	42	2
L-PPFFG-6648-00S-E	1831	66	48	2
L-PPFFG-6654-00S-E	1947	66	54	2
L-PPFFG-6660-00S-E	2062	66	60	2
L-PPFFG-8224-00S-E	1744	82	24	2
L-PPFFG-8230-00S-E	2051	82	30	2
L-PPFFG-8236-00S-E	2197	82	36	2
L-PPFFG-8242-00S-E	2286	82	42	2
L-PPFFG-8248-00S-E	2427	82	48	2
One 24" frosted glass segment on top				
L-PPFFG-6624-00T-E	1368	66	24	2
L-PPFFG-6630-00T-E	1482	66	30	2
L-PPFFG-6636-00T-E	1599	66	36	2
L-PPFFG-6642-00T-E	1715	66	42	2
L-PPFFG-6648-00T-E	1831	66	48	2
L-PPFFG-6654-00T-E	1947	66	54	2
L-PPFFG-6660-00T-E	2062	66	60	2

Code	Price	H	W	D
Two 8" frosted glass segments on top				
L-PPFFG-6624-0EE-E	1973	66	24	2
L-PPFFG-6630-0EE-E	2231	66	30	2
L-PPFFG-6636-0EE-E	2339	66	36	2
L-PPFFG-6642-0EE-E	2417	66	42	2
L-PPFFG-6648-0EE-E	2521	66	48	2
L-PPFFG-6654-0EE-E	2657	66	54	2
L-PPFFG-6660-0EE-E	2749	66	60	2
One 8" & One 16" frosted glass segment on top				
L-PPFFG-6624-0ES-E	1927	66	24	2
L-PPFFG-6630-0ES-E	2166	66	30	2
L-PPFFG-6636-0ES-E	2300	66	36	2
L-PPFFG-6642-0ES-E	2423	66	42	2
L-PPFFG-6648-0ES-E	2572	66	48	2
L-PPFFG-6654-0ES-E	2738	66	54	2
L-PPFFG-6660-0ES-E	2851	66	60	2
Two 16" frosted glass segments on top				
L-PPFFG-8224-0SS-E	2034	82	24	2
L-PPFFG-8230-0SS-E	2332	82	30	2
L-PPFFG-8236-0SS-E	2516	82	36	2
L-PPFFG-8242-0SS-E	2672	82	42	2
L-PPFFG-8248-0SS-E	2854	82	48	2
One 24" & One 16" frosted glass segment on top				
L-PPFFG-8224-0TS-E	2054	82	24	2
L-PPFFG-8230-0TS-E	2350	82	30	2
L-PPFFG-8236-0TS-E	2542	82	36	2
L-PPFFG-8242-0TS-E	2723	82	42	2
L-PPFFG-8248-0TS-E	2930	82	48	2
Two 24" frosted glass segments on top				
L-PPFFG-8224-0TT-E	2118	82	24	2
L-PPFFG-8230-0TT-E	2429	82	30	2
L-PPFFG-8236-0TT-E	2620	82	36	2
L-PPFFG-8242-0TT-E	2813	82	42	2
L-PPFFG-8248-0TT-E	3035	82	48	2
One 8" & Two 16" frosted glass segments on top				
L-PPFFG-8224-0SS-E	2286	82	24	2
L-PPFFG-8230-0SS-E	2631	82	30	2
L-PPFFG-8236-0SS-E	2825	82	36	2
L-PPFFG-8242-0SS-E	2892	82	42	2
L-PPFFG-8248-0SS-E	3132	82	48	2
Three 16" frosted glass segments on top				
L-PPFFG-8224-0SS-E	2328	82	24	2
L-PPFFG-8230-0SS-E	2597	82	30	2
L-PPFFG-8236-0SS-E	2814	82	36	2
L-PPFFG-8242-0SS-E	3029	82	42	2
L-PPFFG-8248-0SS-E	3267	82	48	2

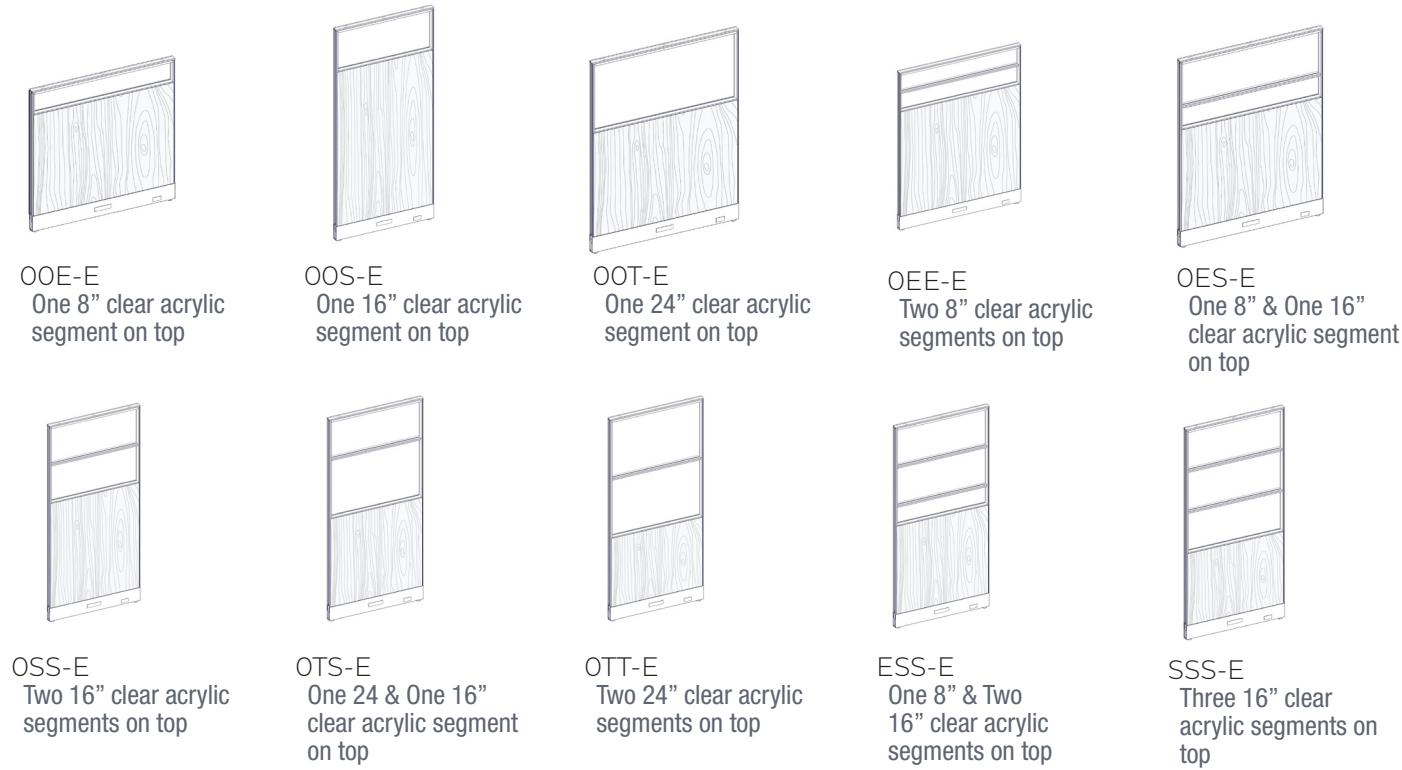

How to order and read your code

L - P P L C A - 42 24 - 00E - E

product standard P=glazed F=Fabric C=Clear A=Acrylic height width 0=No segment N=Non powered
 line line E=Elevated L=Laminate F=Frosted G=Glass E=8 inch segment E=Powered
 S=16 inch segment
 T=24 inch segment

What's Included:

One (1) 2" thick laminate panel with 1" incremented slotted channels,
 Two (2) raceway covers,
 One (1) top trim

How to Specify:

Refer to laminate cards for laminate selections
 Choose White, Black, Silver, Charcoal for Panel Frame colour

Options:

Height*: 34", 42", 50", 66", 82"
 Width: 24", 30", 36", 42", 48",
 Laminate
 Metal Powder Coat Paint: White, Black, Silver, Charcoal

*82"H available up to 36"W

Code	Price	H	W	D
One 8" clear acrylic segment on top				
L-PPLCA-4224-00E-E	1208	42	24	2
L-PPLCA-4230-00E-E	1239	42	30	2
L-PPLCA-4236-00E-E	1297	42	36	2
L-PPLCA-4242-00E-E	1448	42	42	2
L-PPLCA-4248-00E-E	1482	42	48	2
L-PPLCA-5024-00E-E	1247	50	24	2
L-PPLCA-5030-00E-E	1282	50	30	2
L-PPLCA-5036-00E-E	1345	50	36	2
L-PPLCA-5042-00E-E	1519	50	42	2
L-PPLCA-5048-00E-E	1555	50	48	2
One 16" clear acrylic segment on top				
L-PPLCA-5024-00S-E	1265	50	24	2
L-PPLCA-5030-00S-E	1307	50	30	2
L-PPLCA-5036-00S-E	1379	50	36	2
L-PPLCA-5042-00S-E	1535	50	42	2
L-PPLCA-5048-00S-E	1578	50	48	2
L-PPLCA-6624-00S-E	1379	66	24	2
L-PPLCA-6630-00S-E	1420	66	30	2
L-PPLCA-6636-00S-E	1511	66	36	2
L-PPLCA-6642-00S-E	1740	66	42	2
L-PPLCA-6648-00S-E	1787	66	48	2
L-PPLCA-8224-00S-E	1769	82	24	2
L-PPLCA-8230-00S-E	1791	82	30	2
L-PPLCA-8236-00S-E	2382	82	36	2
One 24" clear acrylic segment on top				
L-PPLCA-6624-00T-E	1366	66	24	2
L-PPLCA-6630-00T-E	1419	66	30	2
L-PPLCA-6636-00T-E	1507	66	36	2
L-PPLCA-6642-00T-E	1697	66	42	2
L-PPLCA-6648-00T-E	1751	66	48	2

Code	Price	H	W	D
Two 8" clear acrylic segments on top				
L-PPLCA-6624-0EE-E	1548	66	24	2
L-PPLCA-6630-0EE-E	1566	66	30	2
L-PPLCA-6636-0EE-E	1887	66	36	2
L-PPLCA-6642-0EE-E	1929	66	42	2
L-PPLCA-6648-0EE-E	1993	66	48	2
One 8" & One 16" clear acrylic segment on top				
L-PPLCA-6624-0ES-E	1555	66	24	2
L-PPLCA-6630-0ES-E	1618	66	30	2
L-PPLCA-6636-0ES-E	1964	66	36	2
L-PPLCA-6642-0ES-E	2030	66	42	2
L-PPLCA-6648-0ES-E	2098	66	48	2
Two 16" clear acrylic segments on top				
L-PPLCA-8224-0SS-E	1615	82	24	2
L-PPLCA-8230-0SS-E	1694	82	30	2
L-PPLCA-8236-0SS-E	2080	82	36	2
One 24" & One 16" clear acrylic segment on top				
L-PPLCA-8224-0TS-E	1649	82	24	2
L-PPLCA-8230-0TS-E	1756	82	30	2
L-PPLCA-8236-0TS-E	2090	82	36	2
Two 24" clear acrylic segments on top				
L-PPLCA-8224-0TT-E	1577	82	24	2
L-PPLCA-8230-0TT-E	1673	82	30	2
L-PPLCA-8236-0TT-E	1959	82	36	2
One 8" & Two 16" clear acrylic segments on top				
L-PPLCA-8224-ESS-E	1721	82	24	2
L-PPLCA-8230-ESS-E	1908	82	30	2
L-PPLCA-8236-ESS-E	2255	82	36	2
Three 16" clear acrylic segments on top				
L-PPLCA-8224-SSS-E	1687	82	24	2
L-PPLCA-8230-SSS-E	1790	82	30	2
L-PPLCA-8236-SSS-E	2161	82	36	2

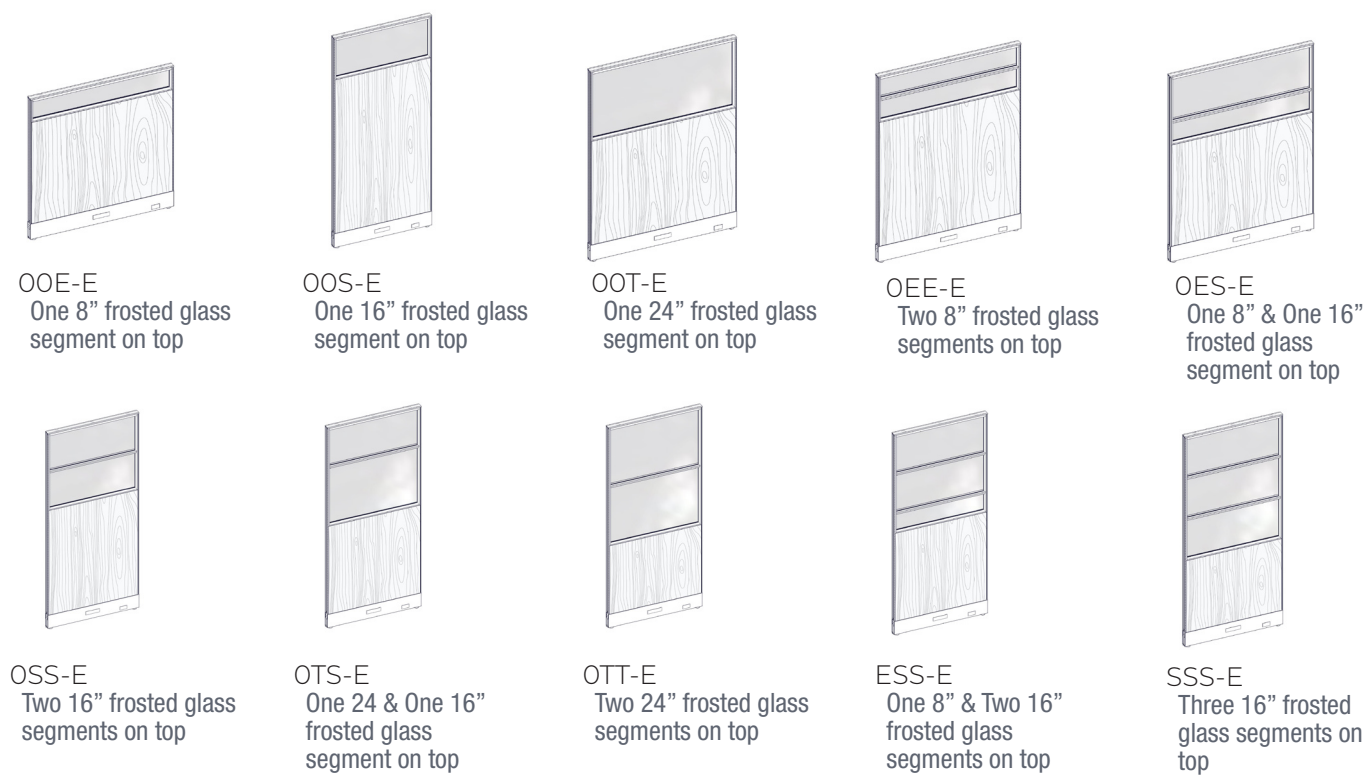

How to order and read your code

L - P P L F A - 42 24 - 00E - E

product standard P=glazed F=Fabric C=Clear A=Acrylic height width 0 = No segment N=Non powered
 line E = Elevated L=Laminate F=Frosted G=Glass E = 8 inch segment E=Powered
 S = 16 inch segment
 T = 24 inch segment

What's Included:

One (1) 2" thick laminate panel with 1" incremented slotted channels,
 Two (2) raceway covers,
 One (1) top trim

How to Specify:

Refer to laminate cards for laminate selections
 Choose White, Black, Silver, Charcoal for Panel Frame colour

Options:

Height*: 34", 42", 50", 66", 82"

Width: 24", 30", 36", 42", 48",

Laminate

Metal Powder Coat Paint: White, Black, Silver, Charcoal

*82"H available up to 36"W

Code	Price	H	W	D
One 8" frosted acrylic segment on top				
L-PPLFA-4224-00E-E	1321	42	24	2
L-PPLFA-4230-00E-E	1357	42	30	2
L-PPLFA-4236-00E-E	1415	42	36	2
L-PPLFA-4242-00E-E	1564	42	42	2
L-PPLFA-4248-00E-E	1599	42	48	2
L-PPLFA-5024-00E-E	1364	50	24	2
L-PPLFA-5030-00E-E	1398	50	30	2
L-PPLFA-5036-00E-E	1462	50	36	2
L-PPLFA-5042-00E-E	1636	50	42	2
L-PPLFA-5048-00E-E	1672	50	48	2
One 16" frosted acrylic segment on top				
L-PPLFA-5024-00S-E	1382	50	24	2
L-PPLFA-5030-00S-E	1422	50	30	2
L-PPLFA-5036-00S-E	1495	50	36	2
L-PPLFA-5042-00S-E	1650	50	42	2
L-PPLFA-5048-00S-E	1697	50	48	2
L-PPLFA-6624-00S-E	1495	66	24	2
L-PPLFA-6630-00S-E	1536	66	30	2
L-PPLFA-6636-00S-E	1627	66	36	2
L-PPLFA-6642-00S-E	1855	66	42	2
L-PPLFA-6648-00S-E	1902	66	48	2
L-PPLFA-8224-00S-E	1810	82	24	2
L-PPLFA-8230-00S-E	1843	82	30	2
L-PPLFA-8236-00S-E	2448	82	36	2
One 24" frosted acrylic segment on top				
L-PPLFA-6624-00T-E	1482	66	24	2
L-PPLFA-6630-00T-E	1535	66	30	2
L-PPLFA-6636-00T-E	1574	66	36	2
L-PPLFA-6642-00T-E	1814	66	42	2
L-PPLFA-6648-00T-E	1868	66	48	2

Code	Price	H	W	D
Two 8" frosted acrylic segments on top				
L-PPLFA-6624-0EE-E	1616	66	24	2
L-PPLFA-6630-0EE-E	1661	66	30	2
L-PPLFA-6636-0EE-E	2010	66	36	2
L-PPLFA-6642-0EE-E	2048	66	42	2
L-PPLFA-6648-0EE-E	2132	66	48	2
One 8" & One 16" frosted acrylic segment on top				
L-PPLFA-6624-0ES-E	1614	66	24	2
L-PPLFA-6630-0ES-E	1697	66	30	2
L-PPLFA-6636-0ES-E	2059	66	36	2
L-PPLFA-6642-0ES-E	2147	66	42	2
L-PPLFA-6648-0ES-E	2216	66	48	2
Two 16" frosted acrylic segments on top				
L-PPLFA-8224-0SS-E	1503	82	24	2
L-PPLFA-8230-0SS-E	1536	82	30	2
L-PPLFA-8236-0SS-E	1869	82	36	2
One 24" & One 16" frosted acrylic segment on top				
L-PPLFA-8224-0TS-E	1768	82	24	2
L-PPLFA-8230-0TS-E	1913	82	30	2
L-PPLFA-8236-0TS-E	2246	82	36	2
Two 24" frosted acrylic segments on top				
L-PPLFA-8224-0TT-E	1697	82	24	2
L-PPLFA-8230-0TT-E	1829	82	30	2
L-PPLFA-8236-0TT-E	2147	82	36	2
One 8" & Two 16" frosted acrylic segments on top				
L-PPLFA-8224-ESS-E	1841	82	24	2
L-PPLFA-8230-ESS-E	2064	82	30	2
L-PPLFA-8236-ESS-E	2410	82	36	2
Three 16" frosted acrylic segments on top				
L-PPLFA-8224-SSS-E	1804	82	24	2
L-PPLFA-8230-SSS-E	1946	82	30	2
L-PPLFA-8236-SSS-E	2398	82	36	2

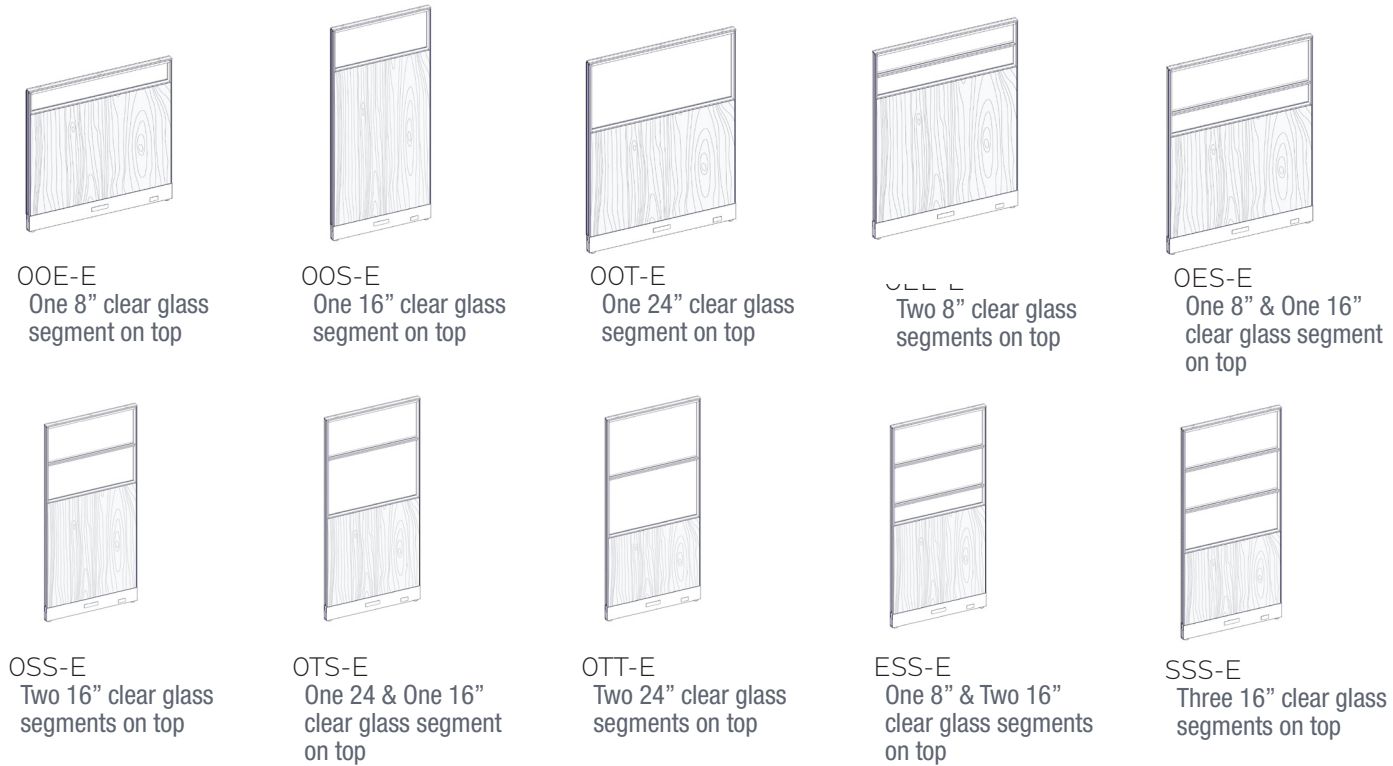

How to order and read your code

L - P P L C G - 42 24 - 00E - E

product standard P=glazed F=Fabric C=Clear A=Acrylic height width 0=No segment N=Non powered
 line line E=Elevated L=Laminate F=Frosted G=Glass E=8 inch segment E=Powered
 S=16 inch segment
 T=24 inch segment

What's Included:

One (1) 2" thick laminate panel with 1" incremented slotted channels,
 Two (2) raceway covers,
 One (1) top trim

How to Specify:

Refer to laminate cards for laminate selections
 Choose White, Black, Silver, Charcoal for Panel Frame colour

Options:

Height*: 34", 42", 50", 66", 82"
 Width: 24", 30", 36", 42", 48",
 Laminate
 Metal Powder Coat Paint: White, Black, Silver, Charcoal

*82"H available up to 36"W

Code	Price	H	W	D
One 8" clear glass segment on top				
L-PPLCG-4224-00E-E	1699	42	24	2
L-PPLCG-4230-00E-E	1353	42	30	2
L-PPLCG-4236-00E-E	1434	42	36	2
L-PPLCG-4242-00E-E	1602	42	42	2
L-PPLCG-4248-00E-E	1655	42	48	2
L-PPLCG-5024-00E-E	1344	50	24	2
L-PPLCG-5030-00E-E	1395	50	30	2
L-PPLCG-5036-00E-E	1479	50	36	2
L-PPLCG-5042-00E-E	1672	50	42	2
L-PPLCG-5048-00E-E	1725	50	48	2
One 16" clear glass segment on top				
L-PPLCG-5024-00S-E	1420	50	24	2
L-PPLCG-5030-00S-E	1495	50	30	2
L-PPLCG-5036-00S-E	1599	50	36	2
L-PPLCG-5042-00S-E	1791	50	42	2
L-PPLCG-5048-00S-E	1866	50	48	2
L-PPLCG-6624-00S-E	1533	66	24	2
L-PPLCG-6630-00S-E	1609	66	30	2
L-PPLCG-6636-00S-E	1730	66	36	2
L-PPLCG-6642-00S-E	1988	66	42	2
L-PPLCG-6648-00S-E	2068	66	48	2
L-PPLCG-8224-00S-E	1723	82	24	2
L-PPLCG-8230-00S-E	1771	82	30	2
L-PPLCG-8236-00S-E	2386	82	36	2
One 24" clear glass segment on top				
L-PPLCG-6624-00T-E	1581	66	24	2
L-PPLCG-6630-00T-E	1678	66	30	2
L-PPLCG-6636-00T-E	1810	66	36	2
L-PPLCG-6642-00T-E	2047	66	42	2
L-PPLCG-6648-00T-E	2147	66	48	2

Code	Price	H	W	D
Two 8" clear glass segments on top				
L-PPLCG-6624-0EE-E	1655	66	24	2
L-PPLCG-6630-0EE-E	1715	66	30	2
L-PPLCG-6636-0EE-E	2064	66	36	2
L-PPLCG-6642-0EE-E	2118	66	42	2
L-PPLCG-6648-0EE-E	2201	66	48	2
One 8" & One 16" clear glass segment on top				
L-PPLCG-6624-0ES-E	1655	66	24	2
L-PPLCG-6630-0ES-E	1736	66	30	2
L-PPLCG-6636-0ES-E	2103	66	36	2
L-PPLCG-6642-0ES-E	2173	66	42	2
L-PPLCG-6648-0ES-E	2273	66	48	2
Two 16" clear glass segments on top				
L-PPLCG-8224-0SS-E	1718	82	24	2
L-PPLCG-8230-0SS-E	1793	82	30	2
L-PPLCG-8236-0SS-E	2177	82	36	2
One 24" & One 16" clear glass segment on top				
L-PPLCG-8224-0TS-E	1751	82	24	2
L-PPLCG-8230-0TS-E	1856	82	30	2
L-PPLCG-8236-0TS-E	2248	82	36	2
Two 24" clear glass segments on top				
L-PPLCG-8224-0TT-E	1718	82	24	2
L-PPLCG-8230-0TT-E	1828	82	30	2
L-PPLCG-8236-0TT-E	2140	82	36	2
One 8" & Two 16" clear glass segments on top				
L-PPLCG-8224-ESS-E	1921	82	24	2
L-PPLCG-8230-ESS-E	2098	82	30	2
L-PPLCG-8236-ESS-E	2502	82	36	2
Three 16" clear glass segments on top				
L-PPLCG-8224-SSS-E	1896	82	24	2
L-PPLCG-8230-SSS-E	1997	82	30	2
L-PPLCG-8236-SSS-E	2334	82	36	2

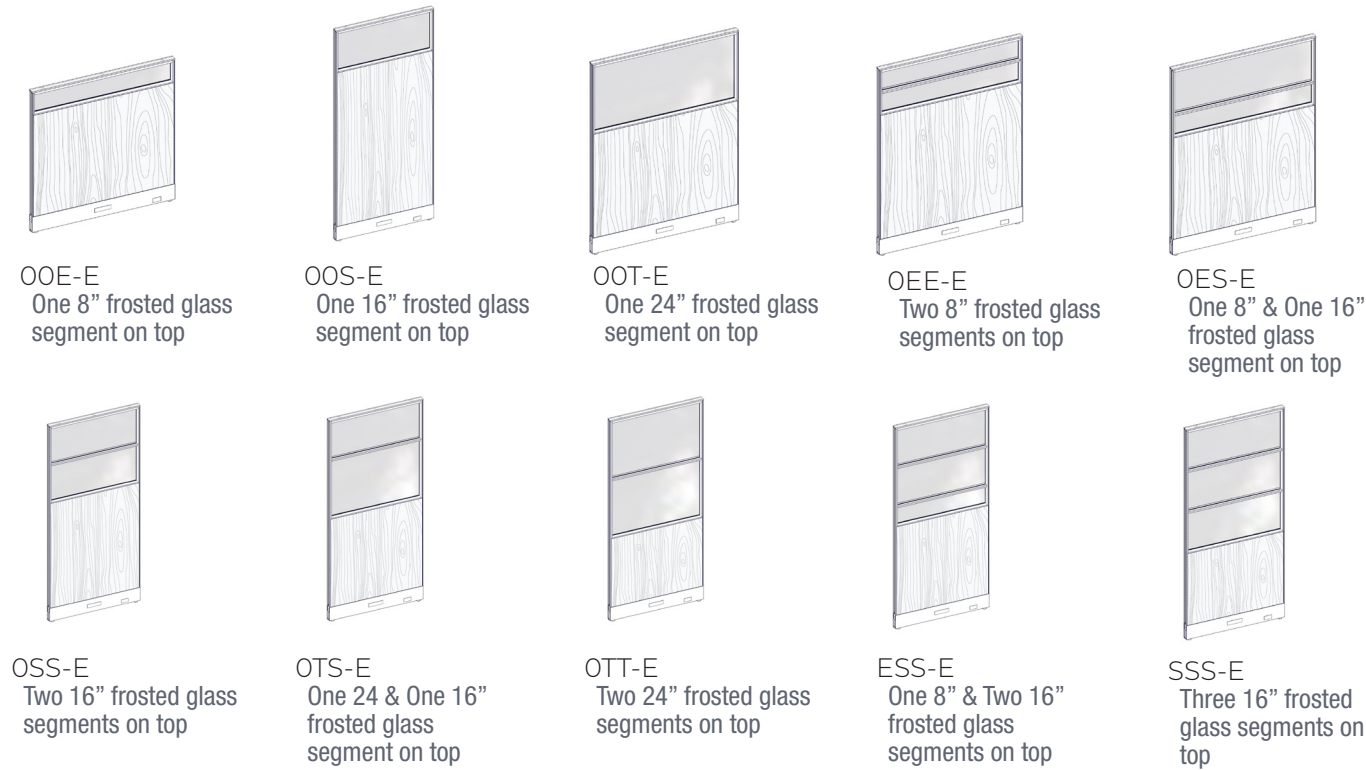

How to order and read your code

L - P P L F G - 42 24 - 00E - E

product standard P=glazed F=Fabric C=Clear A=Acrylic height width 0=No segment N=Non powered
 line line E=Elevated L=Laminate F=Frosted G=Glass E=8 inch segment E=Powered
 S=16 inch segment
 T=24 inch segment

What's Included:

One (1) 2" thick laminate panel with 1" incremented slotted channels,
 Two (2) raceway covers,
 One (1) top trim

How to Specify:

Refer to laminate cards for laminate selections
 Choose White, Black, Silver, Charcoal for Panel Frame colour

Options:

Height*:	34", 42", 50", 66", 82"
Width:	24", 30", 36", 42", 48",
Laminate	
Metal Powder Coat Paint:	White, Black, Silver, Charcoal

*82"H available up to 36"W

Code	Price	H	W	D
One 8" frosted glass segment on top				
L-PPLFG-4224-00E-E	1816	42	24	2
L-PPLFG-4230-00E-E	1470	42	30	2
L-PPLFG-4236-00E-E	1550	42	36	2
L-PPLFG-4242-00E-E	1719	42	42	2
L-PPLFG-4248-00E-E	1771	42	48	2
L-PPLFG-5024-00E-E	1461	50	24	2
L-PPLFG-5030-00E-E	1511	50	30	2
L-PPLFG-5036-00E-E	1596	50	36	2
L-PPLFG-5042-00E-E	1789	50	42	2
L-PPLFG-5048-00E-E	1842	50	48	2
One 16" frosted glass segment on top				
L-PPLFG-5024-00S-E	1536	50	24	2
L-PPLFG-5030-00S-E	1613	50	30	2
L-PPLFG-5036-00S-E	1716	50	36	2
L-PPLFG-5042-00S-E	1906	50	42	2
L-PPLFG-5048-00S-E	1983	50	48	2
L-PPLFG-6624-00S-E	1648	66	24	2
L-PPLFG-6630-00S-E	1725	66	30	2
L-PPLFG-6636-00S-E	1845	66	36	2
L-PPLFG-6642-00S-E	2104	66	42	2
L-PPLFG-6648-00S-E	2183	66	48	2
L-PPLFG-8224-00S-E	1819	82	24	2
L-PPLFG-8230-00S-E	1878	82	30	2
L-PPLFG-8236-00S-E	2511	82	36	2
One 24" frosted glass segment on top				
L-PPLFG-6624-00T-E	1698	66	24	2
L-PPLFG-6630-00T-E	1794	66	30	2
L-PPLFG-6636-00T-E	1926	66	36	2
L-PPLFG-6642-00T-E	2163	66	42	2
L-PPLFG-6648-00T-E	2266	66	48	2

Code	Price	H	W	D
Two 8" frosted glass segments on top				
L-PPLFG-6624-0EE-E	1846	66	24	2
L-PPLFG-6630-0EE-E	1905	66	30	2
L-PPLFG-6636-0EE-E	2255	66	36	2
L-PPLFG-6642-0EE-E	2310	66	42	2
L-PPLFG-6648-0EE-E	2388	66	48	2
One 8" & One 16" frosted glass segment on top				
L-PPLFG-6624-0ES-E	1846	66	24	2
L-PPLFG-6630-0ES-E	1934	66	30	2
L-PPLFG-6636-0ES-E	2325	66	36	2
L-PPLFG-6642-0ES-E	2417	66	42	2
L-PPLFG-6648-0ES-E	2539	66	48	2
Two 16" frosted glass segments on top				
L-PPLFG-8224-0SS-E	1908	82	24	2
L-PPLFG-8230-0SS-E	2002	82	30	2
L-PPLFG-8236-0SS-E	2431	82	36	2
One 24" & One 16" frosted glass segment on top				
L-PPLFG-8224-0TS-E	1973	82	24	2
L-PPLFG-8230-0TS-E	2119	82	30	2
L-PPLFG-8236-0TS-E	2567	82	36	2
Two 24" frosted glass segments on top				
L-PPLFG-8224-0TT-E	1972	82	24	2
L-PPLFG-8230-0TT-E	2144	82	30	2
L-PPLFG-8236-0TT-E	2517	82	36	2
One 8" & Two 16" frosted glass segments on top				
L-PPLFG-8224-ESS-E	2207	82	24	2
L-PPLFG-8230-ESS-E	2402	82	30	2
L-PPLFG-8236-ESS-E	2851	82	36	2
Three 16" frosted glass segments on top				
L-PPLFG-8224-SSS-E	2180	82	24	2
L-PPLFG-8230-SSS-E	2313	82	30	2
L-PPLFG-8236-SSS-E	2714	82	36	2

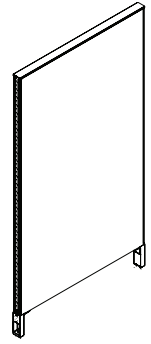

Elevated Non-Powered Fabric Panel

What's Included:

One (1) 2" thick fabric panel with 1" incremented slotted channels, One (1) top trim

How to Specify:

Refer to panel fabric cards for fabric selections

Choose White, Black, Silver, Charcoal for Panel Frame colour

Notes:

Non-power capable panel.

Can be used in run with power-capable panels and allows wires to pass through.

Panels are non tackable. For tackable option see Panel Add-On section.

Fabric Upcharge
Grade 2 - \$226 per panel,
Grade 3- \$278 per panel

Options:

Height*: 34", 42", 50", 66", 82"

Width: 24", 30", 36", 42", 48", 54", 60", 66", 72"

Fabric

Metal Powder Coat Paint: White, Black, Silver, Charcoal

*34" high - 50" high available up to 72" wide, 66" high available up to 60" wide, 82" high available up to 48" wide

Code	Price	H	W	D	Weight (lb.)	Volume (ft ³)
L-PEF0-3424	457	34	24	2	14.84	0.94
L-PEF0-3430	493	34	30	2	18.55	1.18
L-PEF0-3436	530	34	36	2	22.26	1.42
L-PEF0-3442	566	34	42	2	25.96	1.65
L-PEF0-3448	601	34	48	2	29.67	1.89
L-PEF0-3454	637	34	54	2	33.38	2.13
L-PEF0-3460	673	34	60	2	37.09	2.36
L-PEF0-4224	457	42	24	2	18.33	1.17
L-PEF0-4230	493	42	30	2	22.91	1.46
L-PEF0-4236	530	42	36	2	27.49	1.75
L-PEF0-4242	566	42	42	2	32.07	2.04
L-PEF0-4248	601	42	48	2	36.66	2.33
L-PEF0-4254	637	42	54	2	41.24	2.63
L-PEF0-4260	673	42	60	2	45.82	2.92
L-PEF0-5024	493	50	24	2	21.82	1.39
L-PEF0-5030	547	50	30	2	27.27	1.74
L-PEF0-5036	601	50	36	2	32.73	2.08
L-PEF0-5042	655	50	42	2	38.18	2.43
L-PEF0-5048	710	50	48	2	43.64	2.78
L-PEF0-5054	764	50	54	2	49.09	3.13
L-PEF0-5060	814	50	60	2	54.55	3.47
L-PEF0-6624	566	66	24	2	28.80	1.83
L-PEF0-6630	629	66	30	2	36.00	2.29
L-PEF0-6636	683	66	36	2	43.20	2.75
L-PEF0-6642	737	66	42	2	50.40	3.21
L-PEF0-6648	790	66	48	2	57.60	3.67
L-PEF0-6654	862	66	54	2	64.80	4.13
L-PEF0-6660	933	66	60	2	72.00	4.58
L-PEF0-8224	1071	82	24	2		
L-PEF0-8230	1149	82	30	2		
L-PEF0-8236	1392	82	36	2		
L-PEF0-8242	1465	82	42	2		
L-PEF0-8248	1540	82	48	2		

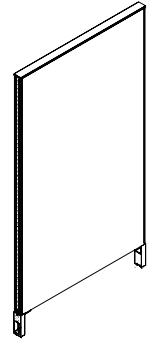

Elevated Monolithic
Non-powered
Laminate Panel

What's Included:

One (1) 2" thick laminate panel with
1" incremented slotted channels,
One (1) top trim

How to Specify:

Refer to laminate cards for laminate selections
Choose White, Black, Silver, Charcoal for Panel
Frame colour

Notes:

Non-power capable panel.
Can be used in run with power-capable
panels and allows wires to pass through.
Panels are non tackable. For tackable
option see Panel Add-On section.

Options:

Height*: 34", 42", 50", 66", 82"

Width: 24", 30", 36", 42", 48",

Laminate

Metal Powder Coat Paint: White, Black, Silver, Charcoal

*82"H available up to 36"W

Code	Price	H	W	D	Weight (lb.)	Volume (ft ³)
L-PELO-3424	578	34	24	2	14.84	0.94
L-PELO-3430	630	34	30	2	18.55	1.18
L-PELO-3436	718	34	36	2	22.26	1.42
L-PELO-3442	773	34	42	2	25.96	1.65
L-PELO-3448	847	34	48	2	29.67	1.89
L-PELO-4224	630	42	24	2	18.33	1.17
L-PELO-4230	686	42	30	2	22.91	1.46
L-PELO-4236	773	42	36	2	27.49	1.75
L-PELO-4242	827	42	42	2	32.07	2.04
L-PELO-4248	899	42	48	2	36.66	2.33
L-PELO-5024	686	50	24	2	21.82	1.39
L-PELO-5030	739	50	30	2	27.27	1.74
L-PELO-5036	847	50	36	2	32.73	2.08
L-PELO-5042	899	50	42	2	38.18	2.43
L-PELO-5048	972	50	48	2	43.64	2.78
L-PELO-6624	847	66	24	2	28.80	1.83
L-PELO-6630	899	66	30	2	36.00	2.29
L-PELO-6636	1062	66	36	2	43.20	2.75
L-PELO-6642	1117	66	42	2	50.40	3.21
L-PELO-6648	1187	66	48	2	57.60	3.67
L-PELO-8224	1139	82	24	2		
L-PELO-8230	1146	82	30	2		
L-PELO-8236	1522	82	36	2		

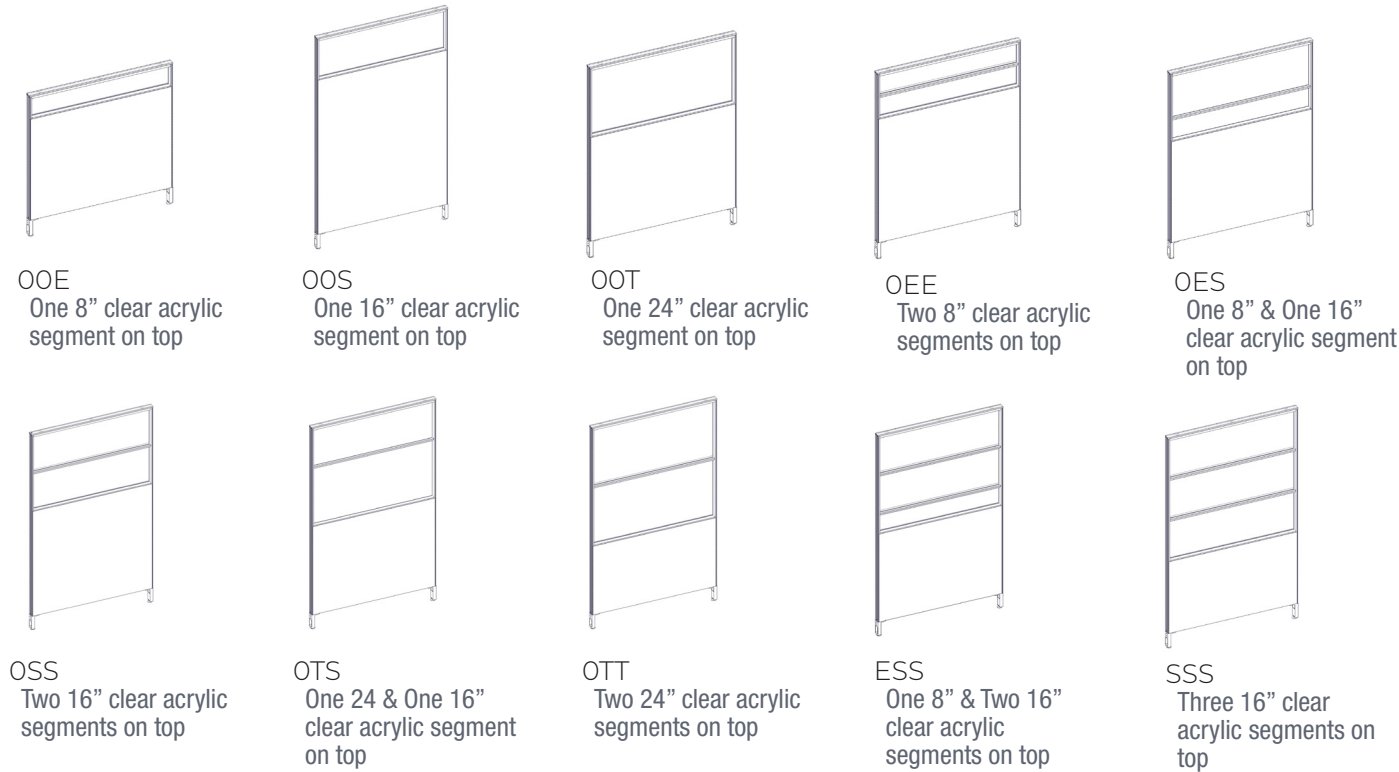

How to order and read your code

L - P E F C A - 42 24 - 0 0 E

product standard line P=glazed E=Elevated F=Fabric L=Laminate C=Clear F=Frosted A=Acrylic height G=Glass width 0 = No segment E = 8 inch segment S = 16 inch segment T = 24 inch segment

What's Included:

One (1) 2" thick fabric panel with glazed glass top and laminate bottom, also with 1" incremented slotted channels, One (1) top trim

How to Specify:

Refer to panel fabric cards for fabric selections
Choose White, Black, Silver, Charcoal for Panel Frame colour

Options:

Height*	34", 42", 50", 66", 82"
Width:	24", 30", 36", 42", 48", 54", 60", 66", 72"
Fabric	
Glass/Acrylic	
Metal Powder Coat Paint:	White, Black, Silver, Charcoal

*34" high - 50" high available up to 72" wide, 66" high available up to 60" wide, 82" high available up to 48" wide

Code	Price	H	W	D
One 8" clear acrylic segment on top				
L-PEFCA-4224-00E	888	42	24	2
L-PEFCA-4230-00E	980	42	30	2
L-PEFCA-4236-00E	1071	42	36	2
L-PEFCA-4242-00E	1163	42	42	2
L-PEFCA-4248-00E	1257	42	48	2
L-PEFCA-4254-00E	1345	42	54	2
L-PEFCA-4260-00E	1437	42	60	2
One 16" clear acrylic segment on top				
L-PEFCA-5024-00E	888	50	24	2
L-PEFCA-5030-00E	980	50	30	2
L-PEFCA-5036-00E	1071	50	36	2
L-PEFCA-5042-00E	1163	50	42	2
L-PEFCA-5048-00E	1257	50	48	2
L-PEFCA-5054-00E	1345	50	54	2
L-PEFCA-5060-00E	1437	50	60	2
One 24" clear acrylic segment on top				
L-PEFCA-6624-00T	1033	66	24	2
L-PEFCA-6630-00T	1149	66	30	2
L-PEFCA-6636-00T	1263	66	36	2
L-PEFCA-6642-00T	1378	66	42	2
L-PEFCA-6648-00T	1494	66	48	2
L-PEFCA-6654-00T	1609	66	54	2
L-PEFCA-6660-00T	1723	66	60	2
One 8" & Two 16" clear acrylic segments on top				
L-PEFCA-8224-00S	1780	82	24	2
L-PEFCA-8230-00S	2103	82	30	2
L-PEFCA-8236-00S	2183	82	36	2
L-PEFCA-8242-00S	2176	82	42	2
L-PEFCA-8248-00S	2376	82	48	2
Three 16" clear acrylic segments on top				
L-PEFCA-8224-SSS	1810	82	24	2
L-PEFCA-8230-SSS	2038	82	30	2
L-PEFCA-8236-SSS	2218	82	36	2
L-PEFCA-8242-SSS	2280	82	42	2
L-PEFCA-8248-SSS	2370	82	48	2

Code	Price	H	W	D
Two 8" clear acrylic segments on top				
L-PEFCA-6624-0EE	1649	66	24	2
L-PEFCA-6630-0EE	1860	66	30	2
L-PEFCA-6636-0EE	1927	66	36	2
L-PEFCA-6642-0EE	1983	66	42	2
L-PEFCA-6648-0EE	2057	66	48	2
L-PEFCA-6654-0EE	2180	66	54	2
L-PEFCA-6660-0EE	2230	66	60	2
One 8" & One 16" clear acrylic segment on top				
L-PEFCA-6624-0ES	1613	66	24	2
L-PEFCA-6630-0ES	1814	66	30	2
L-PEFCA-6636-0ES	1896	66	36	2
L-PEFCA-6642-0ES	1977	66	42	2
L-PEFCA-6648-0ES	2064	66	48	2
L-PEFCA-6654-0ES	2154	66	54	2
L-PEFCA-6660-0ES	2192	66	60	2
Two 16" clear acrylic segments on top				
L-PEFCA-8224-0SS	1718	82	24	2
L-PEFCA-8230-0SS	1988	82	30	2
L-PEFCA-8236-0SS	2119	82	36	2
L-PEFCA-8242-0SS	2172	82	42	2
L-PEFCA-8248-0SS	2248	82	48	2
One 24" & One 16" clear acrylic segment on top				
L-PEFCA-8224-0TS	1707	82	24	2
L-PEFCA-8230-0TS	1952	82	30	2
L-PEFCA-8236-0TS	2021	82	36	2
L-PEFCA-8242-0TS	2072	82	42	2
L-PEFCA-8248-0TS	2273	82	48	2
Two 24" clear acrylic segments on top				
L-PEFCA-8224-0TT	1705	82	24	2
L-PEFCA-8230-0TT	1922	82	30	2
L-PEFCA-8236-0TT	2017	82	36	2
L-PEFCA-8242-0TT	2137	82	42	2
L-PEFCA-8248-0TT	2212	82	48	2
One 8" & Two 16" clear acrylic segments on top				
L-PEFCA-8224-ESS	1780	82	24	2
L-PEFCA-8230-ESS	2103	82	30	2
L-PEFCA-8236-ESS	2183	82	36	2
L-PEFCA-8242-ESS	2176	82	42	2
L-PEFCA-8248-ESS	2376	82	48	2
Three 16" clear acrylic segments on top				
L-PEFCA-8224-SSS	1810	82	24	2
L-PEFCA-8230-SSS	2038	82	30	2
L-PEFCA-8236-SSS	2218	82	36	2
L-PEFCA-8242-SSS	2280	82	42	2
L-PEFCA-8248-SSS	2370	82	48	2

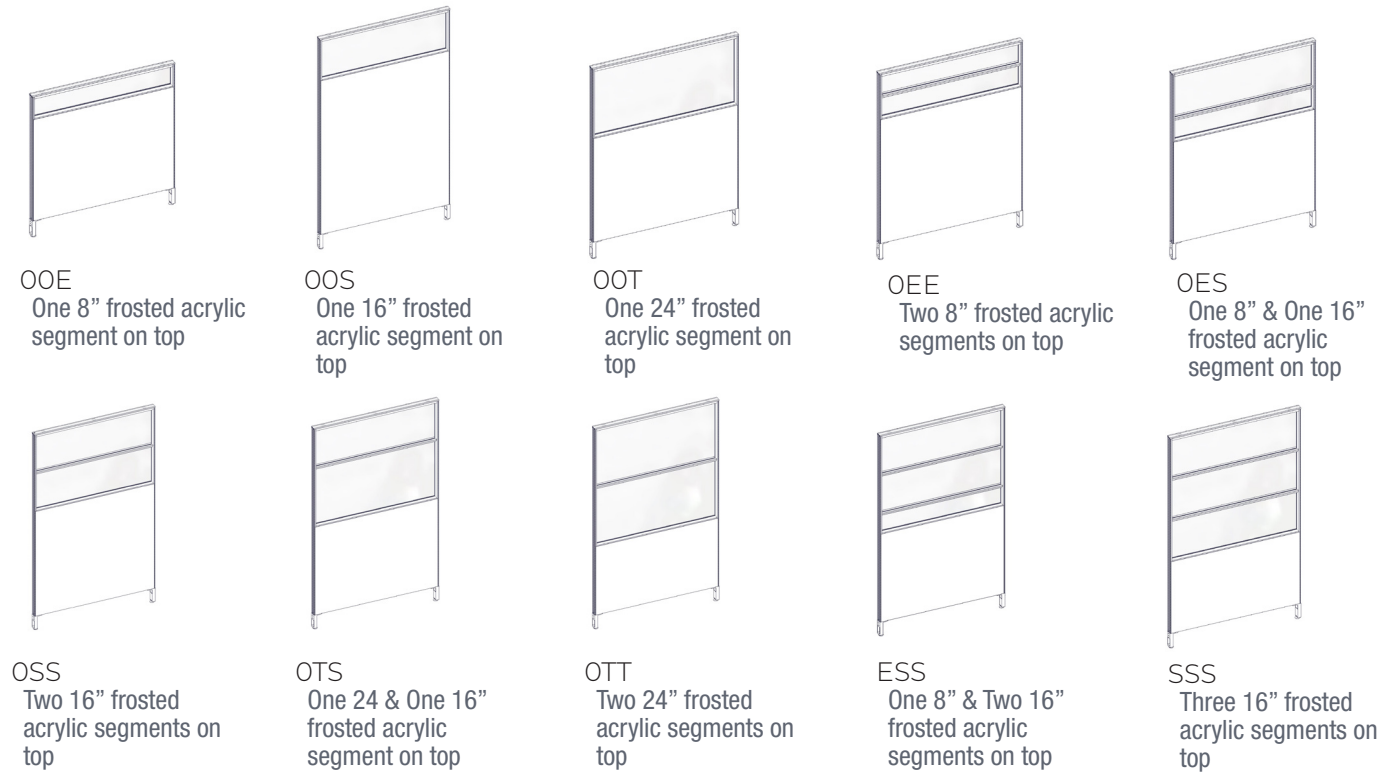

How to order and read your code

L - P E F F A - 42 24 - 0 0 E

product standard line P=glazed E=Elevated F=Fabric L=Laminate C=Clear F=Frosted A=Acrylic height G=Glass width 0 = No segment E = 8 inch segment S = 16 inch segment T = 24 inch segment

What's Included:

One (1) 2" thick fabric panel with glazed glass top and laminate bottom, also with 1" incremented slotted channels, One (1) top trim

How to Specify:

Refer to panel fabric cards for fabric selections
Choose White, Black, Silver, Charcoal for Panel Frame colour

Options:

Height*	34", 42", 50", 66", 82"
Width:	24", 30", 36", 42", 48", 54", 60", 66", 72"
Fabric	
Glass/Acrylic	
Metal Powder Coat Paint:	White, Black, Silver, Charcoal

*34" high - 50" high available up to 72" wide, 66" high available up to 60" wide, 82" high available up to 48" wide

Code	Price	H	W	D
One 8" frosted acrylic segment on top				
L-PEFFA-4224-00E	1005	42	24	2
L-PEFFA-4230-00E	1095	42	30	2
L-PEFFA-4236-00E	1188	42	36	2
L-PEFFA-4242-00E	1280	42	42	2
L-PEFFA-4248-00E	1372	42	48	2
L-PEFFA-4254-00E	1462	42	54	2
L-PEFFA-4260-00E	1552	42	60	2
L-PEFFA-5024-00E	1005	50	24	2
L-PEFFA-5030-00E	1095	50	30	2
L-PEFFA-5036-00E	1188	50	36	2
L-PEFFA-5042-00E	1280	50	42	2
L-PEFFA-5048-00E	1372	50	48	2
L-PEFFA-5054-00E	1462	50	54	2
L-PEFFA-5060-00E	1552	50	60	2
One 16" frosted acrylic segment on top				
L-PEFFA-5024-00S	1005	50	24	2
L-PEFFA-5030-00S	1095	50	30	2
L-PEFFA-5036-00S	1188	50	36	2
L-PEFFA-5042-00S	1280	50	42	2
L-PEFFA-5048-00S	1372	50	48	2
L-PEFFA-5054-00S	1462	50	54	2
L-PEFFA-5060-00S	1552	50	60	2
One 24" frosted acrylic segment on top				
L-PEFFA-6624-00S	1149	66	24	2
L-PEFFA-6630-00S	1265	66	30	2
L-PEFFA-6636-00S	1379	66	36	2
L-PEFFA-6642-00S	1494	66	42	2
L-PEFFA-6648-00S	1612	66	48	2
L-PEFFA-6654-00S	1725	66	54	2
L-PEFFA-6660-00S	1841	66	60	2
L-PEFFA-8224-00S	1713	82	24	2
L-PEFFA-8230-00S	1983	82	30	2
L-PEFFA-8236-00S	2085	82	36	2
L-PEFFA-8242-00S	2137	82	42	2
L-PEFFA-8248-00S	2219	82	48	2
One 8" & One 16" frosted acrylic segment on top				
L-PEFFA-6624-00E	1149	66	24	2
L-PEFFA-6630-00E	1265	66	30	2
L-PEFFA-6636-00E	1379	66	36	2
L-PEFFA-6642-00E	1494	66	42	2
L-PEFFA-6648-00E	1612	66	48	2
L-PEFFA-6654-00E	1725	66	54	2
L-PEFFA-6660-00E	1841	66	60	2
One 8" & Two 16" frosted acrylic segments on top				
L-PEFFA-6624-00T	1149	66	24	2
L-PEFFA-6630-00T	1265	66	30	2
L-PEFFA-6636-00T	1379	66	36	2
L-PEFFA-6642-00T	1494	66	42	2
L-PEFFA-6648-00T	1612	66	48	2
L-PEFFA-6654-00T	1725	66	54	2
L-PEFFA-6660-00T	1841	66	60	2

Code	Price	H	W	D
Two 8" frosted acrylic segments on top				
L-PEFFA-6624-0EE	1720	66	24	2
L-PEFFA-6630-0EE	1953	66	30	2
L-PEFFA-6636-0EE	2049	66	36	2
L-PEFFA-6642-0EE	2102	66	42	2
L-PEFFA-6648-0EE	2197	66	48	2
L-PEFFA-6654-0EE	2280	66	54	2
L-PEFFA-6660-0EE	2328	66	60	2
One 8" & One 16" frosted acrylic segment on top				
L-PEFFA-6624-0ES	1672	66	24	2
L-PEFFA-6630-0ES	1892	66	30	2
L-PEFFA-6636-0ES	1989	66	36	2
L-PEFFA-6642-0ES	2096	66	42	2
L-PEFFA-6648-0ES	2183	66	48	2
L-PEFFA-6654-0ES	2284	66	54	2
L-PEFFA-6660-0ES	2345	66	60	2
Two 16" frosted acrylic segments on top				
L-PEFFA-8224-0SS	1607	82	24	2
L-PEFFA-8230-0SS	1830	82	30	2
L-PEFFA-8236-0SS	1910	82	36	2
L-PEFFA-8242-0SS	1970	82	48	2
L-PEFFA-8248-0SS	2034	82	48	2
One 24" & One 16" frosted acrylic segment on top				
L-PEFFA-8224-0TS	1827	82	24	2
L-PEFFA-8230-0TS	2106	82	30	2
L-PEFFA-8236-0TS	2176	82	36	2
L-PEFFA-8242-0TS	2268	82	42	2
L-PEFFA-8248-0TS	2508	82	48	2
Two 24" frosted acrylic segments on top				
L-PEFFA-8224-0TT	1821	82	24	2
L-PEFFA-8230-0TT	2080	82	30	2
L-PEFFA-8236-0TT	2203	82	36	2
L-PEFFA-8242-0TT	2372	82	42	2
L-PEFFA-8248-0TT	2448	82	48	2
One 8" & Two 16" frosted acrylic segments on top				
L-PEFFA-8224-ESS	1899	82	24	2
L-PEFFA-8230-ESS	2260	82	30	2
L-PEFFA-8236-ESS	2339	82	36	2
L-PEFFA-8242-ESS	2402	82	42	2
L-PEFFA-8248-ESS	2530	82	48	2
Three 16" frosted acrylic segments on top				
L-PEFFA-8224-SSS	1927	82	24	2
L-PEFFA-8230-SSS	2195	82	30	2
L-PEFFA-8236-SSS	2454	82	36	2
L-PEFFA-8242-SSS	2514	82	36	2
L-PEFFA-8248-SSS	2604	82	48	2

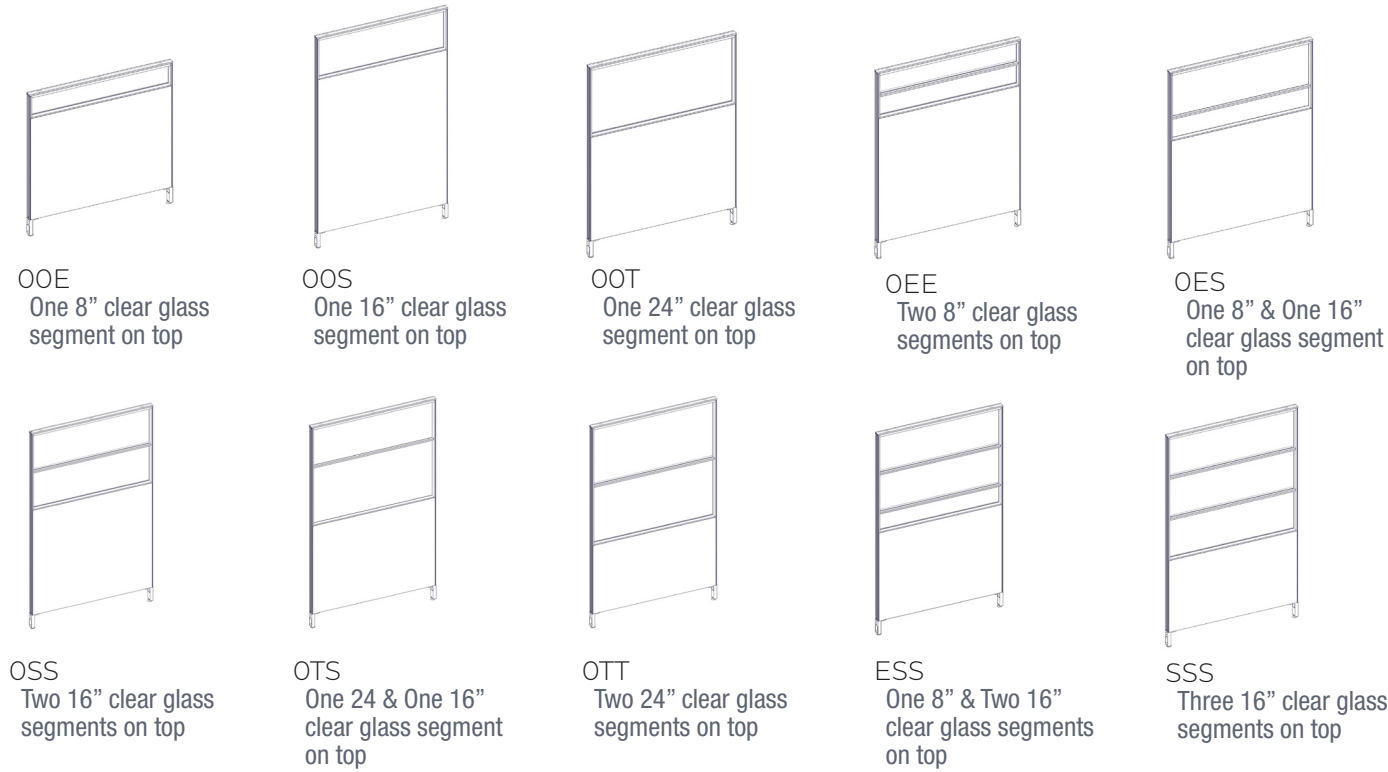

How to order and read your code

L - P E F C G - 42 24 - 0 0 E

product standard line P=glazed E=Elevated F=Fabric L=Laminate C=Clear F=Frosted A=Acrylic G=Glass height width 0=No segment E=8 inch segment S=16 inch segment T=24 inch segment

What's Included:

One (1) 2" thick fabric panel with glazed glass top and laminate bottom, also with 1" incremented slotted channels, One (1) top trim

How to Specify:

Refer to panel fabric cards for fabric selections
Choose White, Black, Silver, Charcoal for Panel Frame colour

Options:

Height*:	34", 42", 50", 66", 82"
Width:	24", 30", 36", 42", 48", 54", 60", 66", 72"
Fabric	
Glass/Acrylic	
Metal Powder Coat Paint:	White, Black, Silver, Charcoal

*34" high - 50" high available up to 72" wide, 66" high available up to 60" wide, 82" high available up to 48" wide

Code	Price	H	W	D
One 8" clear glass segment on top				
L-PEFCG-4224-00E	1044	42	24	2
L-PEFCG-4230-00E	1136	42	30	2
L-PEFCG-4236-00E	1230	42	36	2
L-PEFCG-4242-00E	1319	42	42	2
L-PEFCG-4248-00E	1409	42	48	2
L-PEFCG-4254-00E	1501	42	54	2
L-PEFCG-4260-00E	1591	42	60	2
L-PEFCG-5024-00E	1044	50	24	2
L-PEFCG-5030-00E	1136	50	30	2
L-PEFCG-5036-00E	1230	50	36	2
L-PEFCG-5042-00E	1319	50	42	2
L-PEFCG-5048-00E	1409	50	48	2
L-PEFCG-5054-00E	1501	50	54	2
L-PEFCG-5060-00E	1591	50	60	2
One 16" clear glass segment on top				
L-PEFCG-5024-00S	1044	50	24	2
L-PEFCG-5030-00S	1136	50	30	2
L-PEFCG-5036-00S	1230	50	36	2
L-PEFCG-5042-00S	1319	50	42	2
L-PEFCG-5048-00S	1409	50	48	2
L-PEFCG-5054-00S	1501	50	54	2
L-PEFCG-5060-00S	1591	50	60	2
L-PEFCG-6624-00S	1200	66	24	2
L-PEFCG-6630-00S	1317	66	30	2
L-PEFCG-6636-00S	1432	66	36	2
L-PEFCG-6642-00S	1549	66	42	2
L-PEFCG-6648-00S	1664	66	48	2
L-PEFCG-6654-00S	1780	66	54	2
L-PEFCG-6660-00S	1893	66	60	2
L-PEFCG-8224-00S	1626	82	24	2
L-PEFCG-8230-00S	1913	82	30	2
L-PEFCG-8236-00S	2026	82	36	2
L-PEFCG-8242-00S	2082	82	42	2
L-PEFCG-8248-00S	2191	82	48	2
One 24" clear glass segment on top				
L-PEFCG-6624-00T	1200	66	24	2
L-PEFCG-6630-00T	1317	66	30	2
L-PEFCG-6636-00T	1432	66	36	2
L-PEFCG-6642-00T	1549	66	42	2
L-PEFCG-6648-00T	1664	66	48	2
L-PEFCG-6654-00T	1780	66	54	2
L-PEFCG-6660-00T	1893	66	60	2

Code	Price	H	W	D
Two 8" clear glass segments on top				
L-PEFCG-6624-0EE	1758	66	24	2
L-PEFCG-6630-0EE	2005	66	30	2
L-PEFCG-6636-0EE	2104	66	36	2
L-PEFCG-6642-0EE	2171	66	42	2
L-PEFCG-6648-0EE	2266	66	48	2
L-PEFCG-6654-0EE	2387	66	54	2
L-PEFCG-6660-0EE	2450	66	60	2
One 8" & One 16" clear glass segment on top				
L-PEFCG-6624-0ES	1715	66	24	2
L-PEFCG-6630-0ES	1930	66	30	2
L-PEFCG-6636-0ES	2031	66	36	2
L-PEFCG-6642-0ES	2120	66	42	2
L-PEFCG-6648-0ES	2242	66	48	2
L-PEFCG-6654-0ES	2375	66	54	2
L-PEFCG-6660-0ES	2441	66	60	2
Two 16" clear glass segments on top				
L-PEFCG-8224-0SS	1820	82	24	2
L-PEFCG-8230-0SS	2085	82	30	2
L-PEFCG-8236-0SS	2218	82	36	2
L-PEFCG-8242-0SS	2320	82	42	2
L-PEFCG-8248-0SS	2448	82	48	2
One 24" & One 16" clear glass segment on top				
L-PEFCG-8224-0TS	1807	82	24	2
L-PEFCG-8230-0TS	2051	82	30	2
L-PEFCG-8236-0TS	2178	82	36	2
L-PEFCG-8242-0TS	2296	82	42	2
L-PEFCG-8248-0TS	2438	82	48	2
Two 24" clear glass segments on top				
L-PEFCG-8224-0TT	1842	82	24	2
L-PEFCG-8230-0TT	2076	82	30	2
L-PEFCG-8236-0TT	2194	82	36	2
L-PEFCG-8242-0TT	2313	82	42	2
L-PEFCG-8248-0TT	2457	82	48	2
One 8" & Two 16" clear glass segments on top				
L-PEFCG-8224-ESS	1978	82	24	2
L-PEFCG-8230-ESS	2292	82	30	2
L-PEFCG-8236-ESS	2430	82	36	2
L-PEFCG-8242-ESS	2444	82	42	2
L-PEFCG-8248-ESS	2628	82	48	2
Three 16" clear glass segments on top				
L-PEFCG-8224-SSS	2021	82	24	2
L-PEFCG-8230-SSS	2246	82	30	2
L-PEFCG-8236-SSS	2389	82	36	2
L-PEFCG-8242-SSS	2529	82	42	2
L-PEFCG-8248-SSS	2692	82	48	2

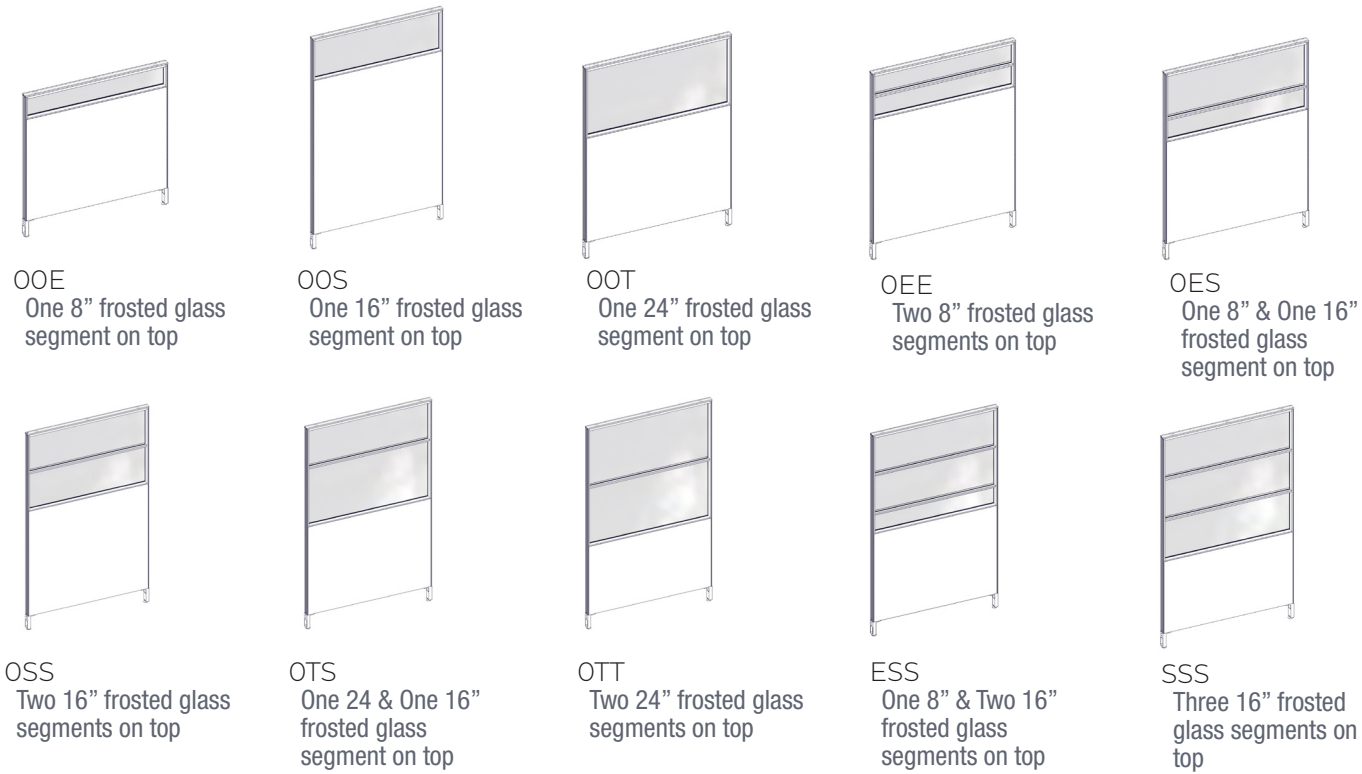

How to order and read your code

L - P E F F G - 42 24 - 00 E

product standard line P=glazed E=Elevated F=Fabric L=Laminate C=Clear F=Frosted A=Acrylic height G=Glass width O=No segment E=8 inch segment S=16 inch segment T=24 inch segment

What's Included:

One (1) 2" thick fabric panel with glazed glass top and laminate bottom, also with 1" incremented slotted channels, One (1) top trim

How to Specify:

Refer to panel fabric cards for fabric selections
Choose White, Black, Silver, Charcoal for Panel Frame colour

Options:

Height*	34", 42", 50", 66", 82"
Width:	24", 30", 36", 42", 48", 54", 60", 66", 72"
Fabric	
Glass/Acrylic	
Metal Powder Coat Paint:	White, Black, Silver, Charcoal

*34" high - 50" high available up to 72" wide, 66" high available up to 60" wide, 82" high available up to 48" wide

Code	Price	H	W	D
One 8" frosted glass segment on top				
L-PEFFG-4224-00E	1161	42	24	2
L-PEFFG-4230-00E	1249	42	30	2
L-PEFFG-4236-00E	1344	42	36	2
L-PEFFG-4242-00E	1436	42	42	2
L-PEFFG-4248-00E	1526	42	48	2
L-PEFFG-4254-00E	1618	42	54	2
L-PEFFG-4260-00E	1707	42	60	2
One 16" frosted glass segment on top				
L-PEFFG-5024-00E	1161	50	24	2
L-PEFFG-5030-00E	1249	50	30	2
L-PEFFG-5036-00E	1344	50	36	2
L-PEFFG-5042-00E	1436	50	42	2
L-PEFFG-5048-00E	1526	50	48	2
L-PEFFG-5054-00E	1618	50	54	2
L-PEFFG-5060-00E	1707	50	60	2
One 8" & One 16" frosted glass segment on top				
L-PEFFG-6624-00E	1950	66	24	2
L-PEFFG-6630-00E	2197	66	30	2
L-PEFFG-6636-00E	2294	66	36	2
L-PEFFG-6642-00E	2361	66	42	2
L-PEFFG-6648-00E	2455	66	48	2
L-PEFFG-6654-00E	2579	66	54	2
L-PEFFG-6660-00E	2660	66	60	2
One 8" & Two 16" frosted glass segments on top				
L-PEFFG-8224-00E	2011	82	24	2
L-PEFFG-8230-00E	2297	82	30	2
L-PEFFG-8236-00E	2472	82	36	2
L-PEFFG-8242-00E	2616	82	42	2
L-PEFFG-8248-00E	2785	82	48	2
One 24" & One 16" frosted glass segment on top				
L-PEFFG-8224-00S	2030	82	24	2
L-PEFFG-8230-00S	2314	82	30	2
L-PEFFG-8236-00S	2498	82	36	2
L-PEFFG-8242-00S	2666	82	42	2
L-PEFFG-8248-00S	2862	82	48	2
Two 16" frosted glass segments on top				
L-PEFFG-6624-00S	1317	66	24	2
L-PEFFG-6630-00S	1433	66	30	2
L-PEFFG-6636-00S	1548	66	36	2
L-PEFFG-6642-00S	1666	66	42	2
L-PEFFG-6648-00S	1780	66	48	2
L-PEFFG-6654-00S	1896	66	54	2
L-PEFFG-6660-00S	2010	66	60	2
Two 24" frosted glass segments on top				
L-PEFFG-8224-00S	1840	82	24	2
L-PEFFG-8230-00S	2134	82	30	2
L-PEFFG-8236-00S	2269	82	36	2
L-PEFFG-8242-00S	2346	82	42	2
L-PEFFG-8248-00S	2478	82	48	2
One 24" frosted glass segment on top				
L-PEFFG-6624-00T	1317	66	24	2
L-PEFFG-6630-00T	1433	66	30	2
L-PEFFG-6636-00T	1548	66	36	2
L-PEFFG-6642-00T	1666	66	42	2
L-PEFFG-6648-00T	1780	66	48	2
L-PEFFG-6654-00T	1896	66	54	2
L-PEFFG-6660-00T	2010	66	60	2
Two 24" & One 16" frosted glass segment on top				
L-PEFFG-8224-00T	2096	82	24	2
L-PEFFG-8230-00T	2395	82	30	2
L-PEFFG-8236-00T	2573	82	36	2
L-PEFFG-8242-00T	2759	82	42	2
L-PEFFG-8248-00T	2966	82	48	2
One 8" & Two 16" frosted glass segments on top				
L-PEFFG-8224-00T	2266	82	24	2
L-PEFFG-8230-00T	2599	82	30	2
L-PEFFG-8236-00T	2782	82	36	2
L-PEFFG-8242-00T	2837	82	42	2
L-PEFFG-8248-00T	3062	82	48	2
Three 16" frosted glass segments on top				
L-PEFFG-8224-00T	2308	82	24	2
L-PEFFG-8230-00T	2565	82	30	2
L-PEFFG-8236-00T	2771	82	36	2
L-PEFFG-8242-00T	2976	82	42	2
L-PEFFG-8248-00T	3199	82	48	2

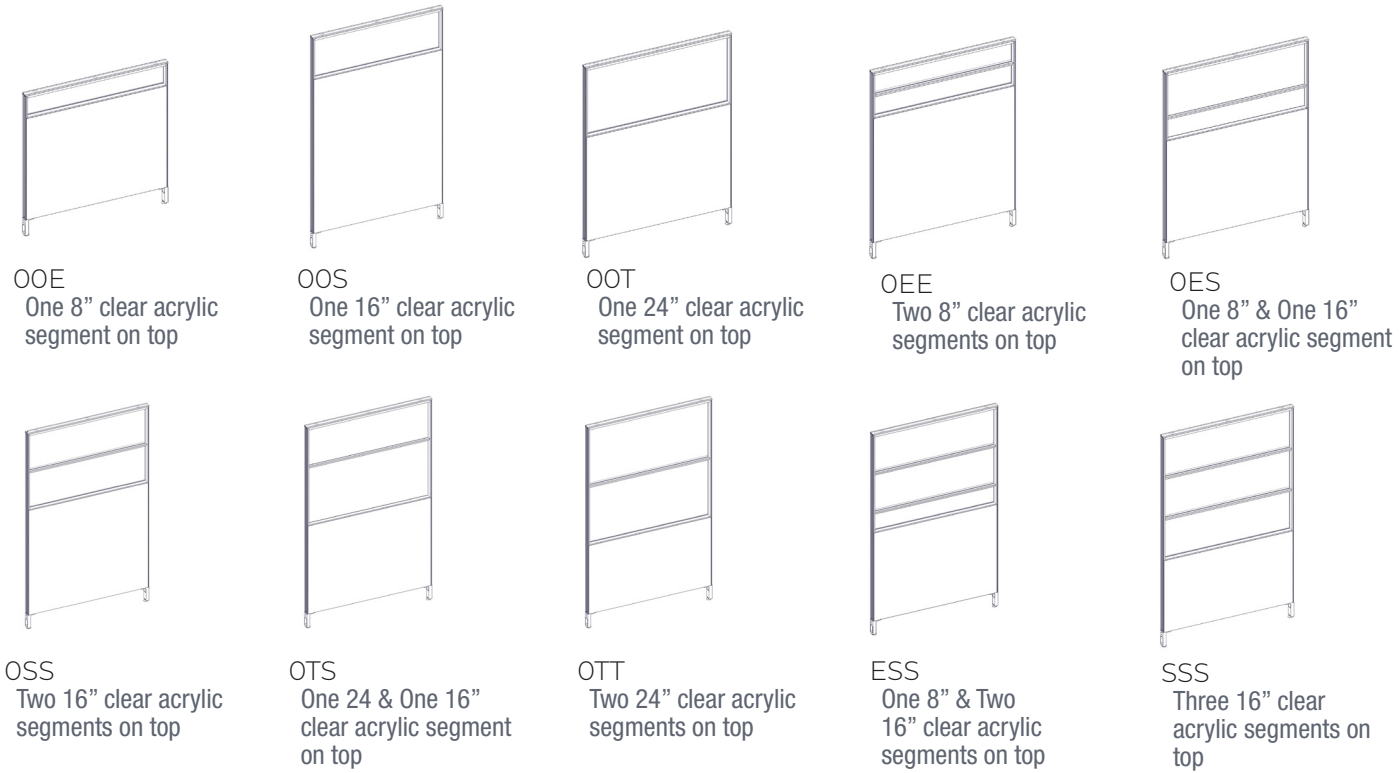

How to order and read your code

L - P E L C A - 42 24 - 0 0 E

product standard line P=glazed E=Elevated F=Fabric L=Laminate C=Clear F=Frosted A=Acrylic G=Glass height width 0 = No segment E = 8 inch segment S = 16 inch segment T = 24 inch segment

What's Included:

One (1) 2" thick panel with glazed glass top and laminate bottom, also 1" incremented slotted channels, One (1) top trim

How to Specify:

Refer to laminate cards for laminate selections
Choose glass or acrylic
Choose White, Black, Silver, Charcoal for Panel Frame colour

Options:

Height*	34", 42", 50", 66", 82"
Width:	24", 30", 36", 42", 48",
Laminate	
Glass/Acrylic	
Metal Powder Coat Paint:	White, Black, Silver, Charcoal

*82"H available up to 36"W

Notes:

Non-power capable panel.
Can be used in run with power-capable panels and allows wires to pass through.
Panels are non tackable. For tackable option see Panel Add-On section.

Code	Price	H	W	D
One 8" clear acrylic segment on top				
L-PELCA-4224-00E	1153	42	24	2
L-PELCA-4230-00E	1187	42	30	2
L-PELCA-4236-00E	1247	42	36	2
L-PELCA-4242-00E	1398	42	42	2
L-PELCA-4248-00E	1432	42	48	2
L-PELCA-5024-00E	1197	50	24	2
L-PELCA-5030-00E	1231	50	30	2
L-PELCA-5036-00E	1293	50	36	2
L-PELCA-5042-00E	1468	50	42	2
L-PELCA-5048-00E	1501	50	48	2
One 16" clear acrylic segment on top				
L-PELCA-5024-00S	1214	50	24	2
L-PELCA-5030-00S	1259	50	30	2
L-PELCA-5036-00S	1330	50	36	2
L-PELCA-5042-00S	1487	50	42	2
L-PELCA-5048-00S	1527	50	48	2
L-PELCA-6624-00S	1330	66	24	2
L-PELCA-6630-00S	1370	66	30	2
L-PELCA-6636-00S	1458	66	36	2
L-PELCA-6642-00S	1688	66	42	2
L-PELCA-6648-00S	1732	66	48	2
L-PELCA-8224-00S	1747	82	24	2
L-PELCA-8230-00S	1756	82	30	2
L-PELCA-8236-00S	2334	82	36	2
One 24" clear acrylic segment on top				
L-PELCA-6624-00T	1317	66	24	2
L-PELCA-6630-00T	1368	66	30	2
L-PELCA-6636-00T	1456	66	36	2
L-PELCA-6642-00T	1646	66	42	2
L-PELCA-6648-00T	1699	66	48	2
Two 8" clear acrylic segments on top				
L-PELCA-6624-0EE	1523	66	24	2
L-PELCA-6630-0EE	1533	66	30	2
L-PELCA-6636-0EE	1842	66	36	2
L-PELCA-6642-0EE	1874	66	42	2
L-PELCA-6648-0EE	1926	66	48	2
One 8" & One 16" clear acrylic segment on top				
L-PELCA-6624-0ES	1530	66	24	2
L-PELCA-6630-0ES	1585	66	30	2
L-PELCA-6636-0ES	1921	66	36	2
L-PELCA-6642-0ES	1974	66	42	2
L-PELCA-6648-0ES	2028	66	48	2
Two 16" clear acrylic segments on top				
L-PELCA-8224-0SS	1591	82	24	2
L-PELCA-8230-0SS	1663	82	30	2
L-PELCA-8236-0SS	2034	82	36	2
One 24" & One 16" clear acrylic segment on top				
L-PELCA-8224-0TS	1627	82	24	2
L-PELCA-8230-0TS	1721	82	30	2
L-PELCA-8236-0TS	2044	82	36	2
Two 24" clear acrylic segments on top				
L-PELCA-8224-0TT	1559	82	24	2
L-PELCA-8230-0TT	1638	82	30	2
L-PELCA-8236-0TT	1914	82	36	2
One 8" & Two 16" clear acrylic segments on top				
L-PELCA-8224-0SS	1698	82	24	2
L-PELCA-8230-0SS	1874	82	30	2
L-PELCA-8236-0SS	2208	82	36	2
Three 16" clear acrylic segments on top				
L-PELCA-8224-0SS	1664	82	24	2
L-PELCA-8230-0SS	1755	82	30	2
L-PELCA-8236-0SS	2117	82	36	2

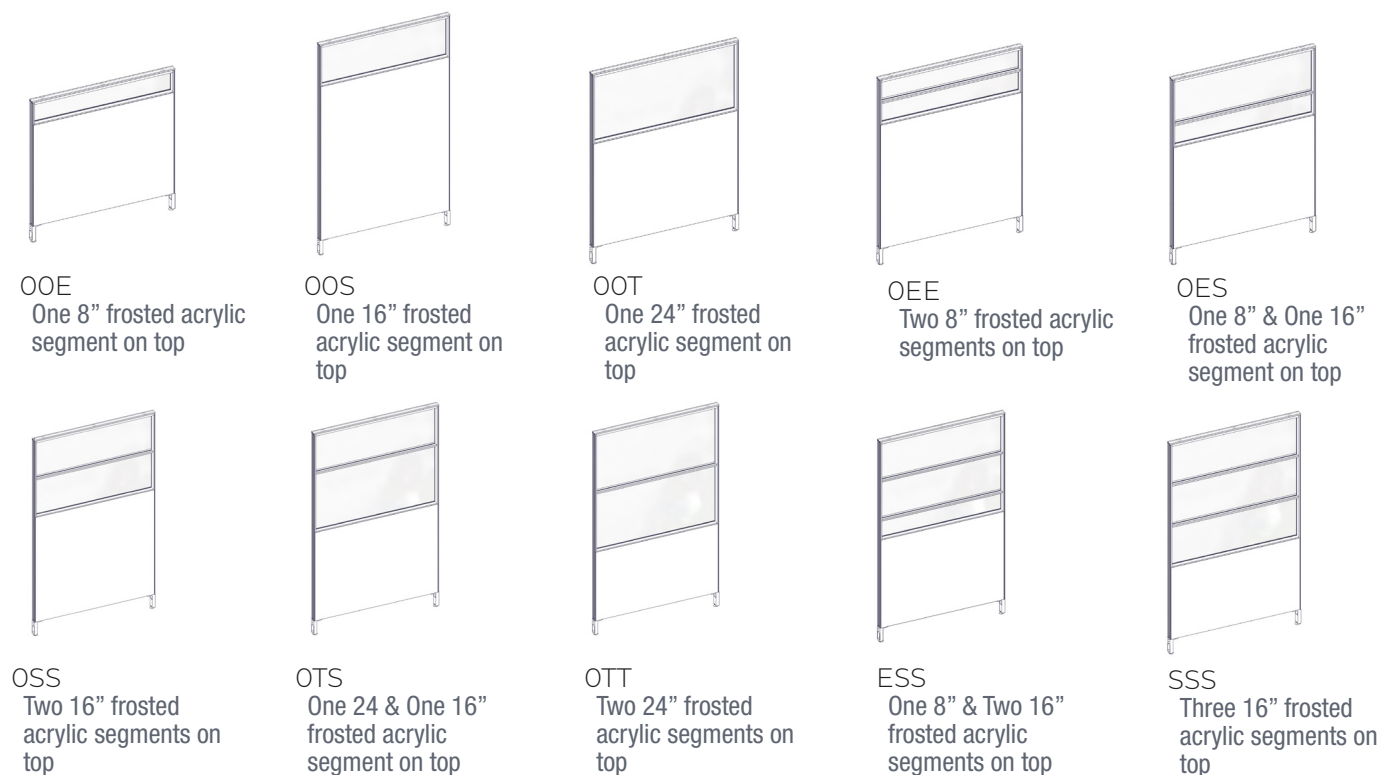

How to order and read your code

L - P E L F A - 4 2 2 4 - 0 0 E

product standard line P=glazed E=Elevated F=Fabric L=Laminate C=Clear F=Frosted A=Acrylic height G=Glass width 0 = No segment E = 8 inch segment S = 16 inch segment T = 24 inch segment

What's Included:

One (1) 2" thick panel with glazed glass top and laminate bottom, also 1" incremented slotted channels, One (1) top trim

How to Specify:

Refer to laminate cards for laminate selections
 Choose glass or acrylic
 Choose White, Black, Silver, Charcoal for Panel Frame colour

Options:

Height*	34", 42", 50", 66", 82"
Width:	24", 30", 36", 42", 48",
Laminate	
Glass/Acrylic	
Metal Powder Coat Paint:	White, Black, Silver, Charcoal

*82"H available up to 36"W

Code	Price	H	W	D
One 8" frosted acrylic segment on top				
L-PELFA-4224-00E	1272	24	42	2
L-PELFA-4230-00E	1303	30	42	2
L-PELFA-4236-00E	1364	36	42	2
L-PELFA-4242-00E	1515	42	42	2
L-PELFA-4248-00E	1548	48	42	2
L-PELFA-5024-00E	1315	24	50	2
L-PELFA-5030-00E	1345	30	50	2
L-PELFA-5036-00E	1409	36	50	2
L-PELFA-5042-00E	1585	42	50	2
L-PELFA-5048-00E	1618	48	50	2
One 16" frosted acrylic segment on top				
L-PELFA-5024-00S	1331	24	50	2
L-PELFA-5030-00S	1374	30	50	2
L-PELFA-5036-00S	1445	36	50	2
L-PELFA-5042-00S	1602	42	50	2
L-PELFA-5048-00S	1644	48	50	2
L-PELFA-6624-00S	1445	24	66	2
L-PELFA-6630-00S	1487	30	66	2
L-PELFA-6636-00S	1574	36	66	2
L-PELFA-6642-00S	1804	42	66	2
L-PELFA-6648-00S	1849	48	66	2
L-PELFA-8224-00S	1789	24	82	2
L-PELFA-8230-00S	1807	30	82	2
L-PELFA-8236-00S	2401	36	82	2
One 24" frosted acrylic segment on top				
L-PELFA-6624-00T	1433	24	66	2
L-PELFA-6630-00T	1486	30	66	2
L-PELFA-6636-00T	1572	36	66	2
L-PELFA-6642-00T	1763	42	66	2
L-PELFA-6648-00T	1816	48	66	2

Code	Price	H	W	D
Two 8" frosted acrylic segments on top				
L-PELFA-6624-0EE	1595	24	66	2
L-PELFA-6630-0EE	1626	30	66	2
L-PELFA-6636-0EE	1964	36	66	2
L-PELFA-6642-0EE	1993	42	66	2
L-PELFA-6648-0EE	2068	48	66	2
One 8" & One 16" frosted acrylic segment on top				
L-PELFA-6624-0ES	1590	24	66	2
L-PELFA-6630-0ES	1664	30	66	2
L-PELFA-6636-0ES	2017	36	66	2
L-PELFA-6642-0ES	2092	42	66	2
L-PELFA-6648-0ES	2146	48	66	2
Two 16" frosted acrylic segments on top				
L-PELFA-8224-0SS	1481	24	82	2
L-PELFA-8230-0SS	1503	30	82	2
L-PELFA-8236-0SS	1825	36	82	2
One 24" & One 16" frosted acrylic segment on top				
L-PELFA-8224-0TS	1745	24	82	2
L-PELFA-8230-0TS	1878	30	82	2
L-PELFA-8236-0TS	2202	36	82	2
Two 24" frosted acrylic segments on top				
L-PELFA-8224-0TT	1675	24	82	2
L-PELFA-8230-0TT	1794	30	82	2
L-PELFA-8236-0TT	2102	36	82	2
One 8" & Two 16" frosted acrylic segments on top				
L-PELFA-8224-ESS	1816	24	82	2
L-PELFA-8230-ESS	2030	30	82	2
L-PELFA-8236-ESS	2364	36	82	2
Three 16" frosted acrylic segments on top				
L-PELFA-8224-SSS	1782	24	82	2
L-PELFA-8230-SSS	1912	30	82	2
L-PELFA-8236-SSS	2352	36	82	2

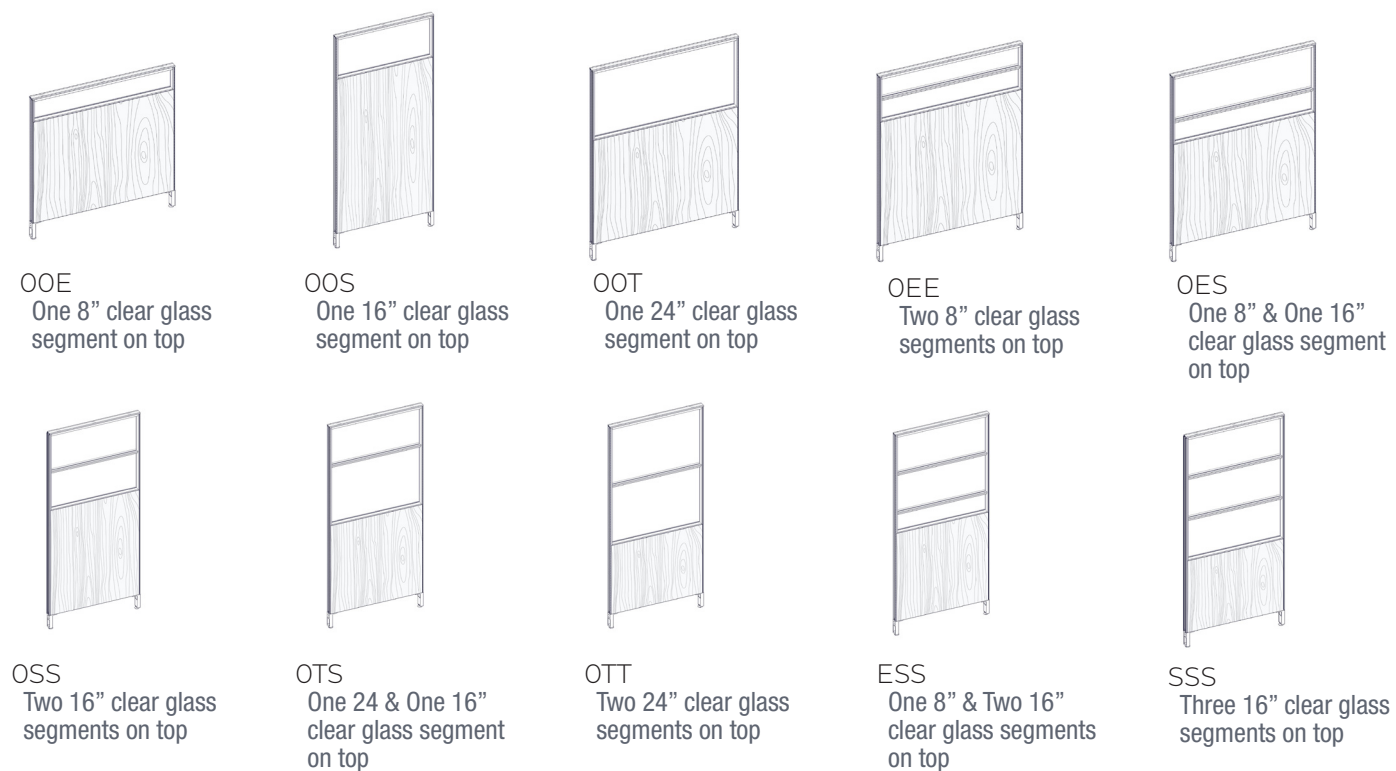

How to order and read your code

L - P E L C G - 42 24 - 00 E

product standard line P=glazed E=Elevated F=Fabric L=Laminate C=Clear F=Frosted A=Acrylic G=Glass height width 0 = No segment E = 8 inch segment S = 16 inch segment T = 24 inch segment

What's Included:

One (1) 2" thick panel with glazed glass top and laminate bottom, also 1" incremented slotted channels, One (1) top trim

How to Specify:

Refer to laminate cards for laminate selections
 Choose glass or acrylic
 Choose White, Black, Silver, Charcoal for Panel Frame color

Options:

Height*:	34", 42", 50", 66", 82"
Width:	24", 30", 36", 42", 48",
Laminate	
Glass/Acrylic	
Metal Powder Coat Paint:	White, Black, Silver, Charcoal

*82"H available up to 36"W

Code	Price	H	W	D
One 8" clear glass segment on top				
L-PELCG-4224-00E	1248	42	24	2
L-PELCG-4230-00E	1297	42	30	2
L-PELCG-4236-00E	1379	42	36	2
L-PELCG-4242-00E	1549	42	42	2
L-PELCG-4248-00E	1602	42	48	2
L-PELCG-5024-00E	1291	50	24	2
L-PELCG-5030-00E	1342	50	30	2
L-PELCG-5036-00E	1429	50	36	2
L-PELCG-5042-00E	1616	50	42	2
L-PELCG-5048-00E	1672	50	48	2
One 16" clear glass segment on top				
L-PELCG-5024-00S	1366	50	24	2
L-PELCG-5030-00S	1442	50	30	2
L-PELCG-5036-00S	1547	50	36	2
L-PELCG-5042-00S	1736	50	42	2
L-PELCG-5048-00S	1810	50	48	2
L-PELCG-6624-00S	1479	66	24	2
L-PELCG-6630-00S	1558	66	30	2
L-PELCG-6636-00S	1674	66	36	2
L-PELCG-6642-00S	1933	66	42	2
L-PELCG-6648-00S	2011	66	48	2
L-PELCG-8224-00S	1701	82	24	2
L-PELCG-8230-00S	1740	82	30	2
L-PELCG-8236-00S	2339	82	36	2
One 24" clear glass segment on top				
L-PELCG-6624-00T	1527	66	24	2
L-PELCG-6630-00T	1627	66	30	2
L-PELCG-6636-00T	1756	66	36	2
L-PELCG-6642-00T	1991	66	42	2
L-PELCG-6648-00T	2096	66	48	2
Two 8" clear glass segments on top				
L-PELCG-6624-0EE	1635	66	24	2
L-PELCG-6630-0EE	1679	66	30	2
L-PELCG-6636-0EE	2019	66	36	2
L-PELCG-6642-0EE	2062	66	42	2
L-PELCG-6648-0EE	2132	66	48	2
One 8" & One 16" clear glass segment on top				
L-PELCG-6624-0ES	1635	66	24	2
L-PELCG-6630-0ES	1701	66	30	2
L-PELCG-6636-0ES	2057	66	36	2
L-PELCG-6642-0ES	2118	66	42	2
L-PELCG-6648-0ES	2204	66	48	2
Two 16" clear glass segments on top				
L-PELCG-8224-0SS	1694	82	24	2
L-PELCG-8230-0SS	1758	82	30	2
L-PELCG-8236-0SS	2132	82	36	2
One 24" & One 16" clear glass segment on top				
L-PELCG-8224-0TS	1728	82	24	2
L-PELCG-8230-0TS	1821	82	30	2
L-PELCG-8236-0TS	2203	82	36	2
Two 24" clear glass segments on top				
L-PELCG-8224-0TT	1693	82	24	2
L-PELCG-8230-0TT	1793	82	30	2
L-PELCG-8236-0TT	2092	82	36	2
One 8" & Two 16" clear glass segments on top				
L-PELCG-8224-ESS	1900	82	24	2
L-PELCG-8230-ESS	2062	82	30	2
L-PELCG-8236-ESS	2456	82	36	2
Three 16" clear glass segments on top				
L-PELCG-8224-SSS	1873	82	24	2
L-PELCG-8230-SSS	1963	82	30	2
L-PELCG-8236-SSS	2288	82	36	2

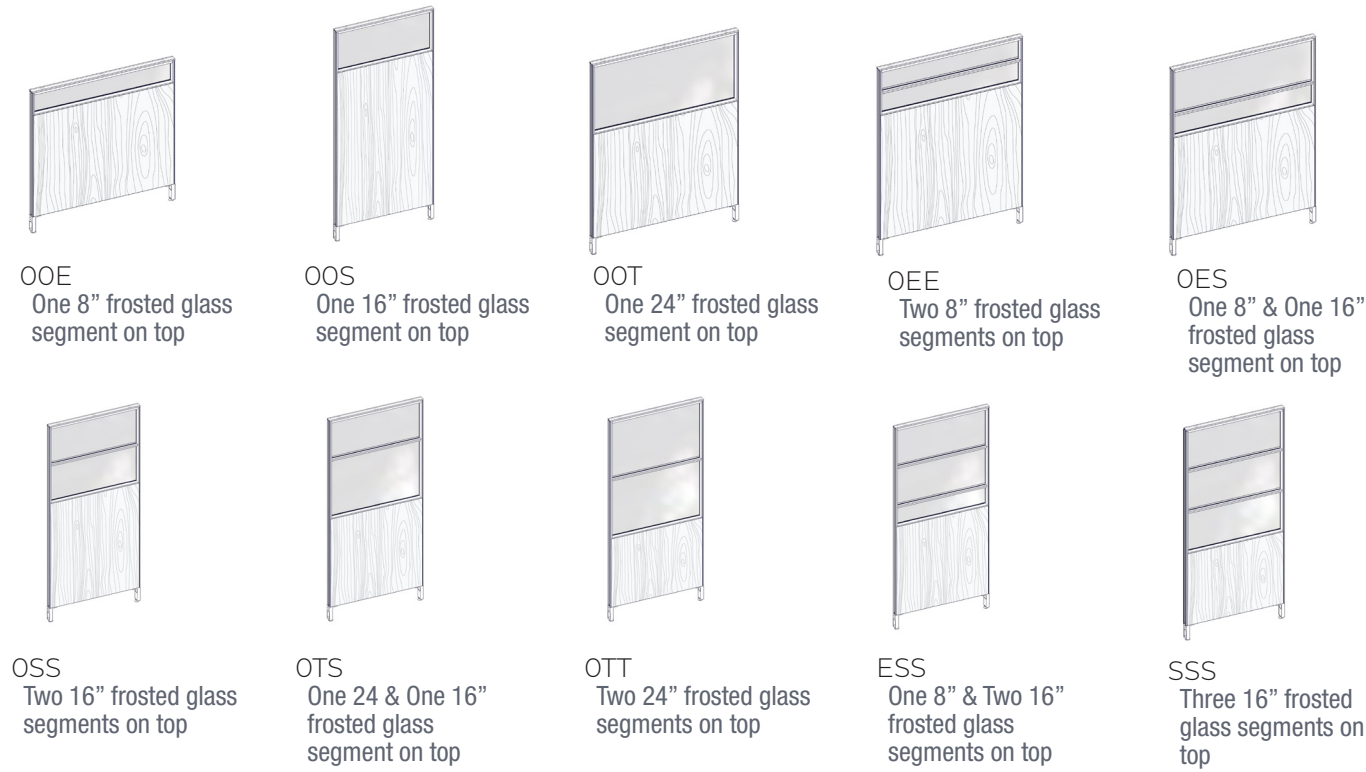

How to order and read your code

L - P E L F G - 42 24 - 00 E

product standard line P=glazed E=Elevated F=Fabric L=Laminate C=Clear F=Frosted A=Acrylic height G=Glass width 0 = No segment E = 8 inch segment S = 16 inch segment T = 24 inch segment

What's Included:

One (1) 2" thick panel with glazed glass top and laminate bottom, also 1" incremented slotted channels, One (1) top trim

How to Specify:

Refer to laminate cards for laminate selections
 Choose glass or acrylic
 Choose White, Black, Silver, Charcoal for Panel Frame colour

Options:

Height*:	34", 42", 50", 66", 82"
Width:	24", 30", 36", 42", 48",
Laminate	
Glass/Acrylic	
Metal Powder Coat Paint:	White, Black, Silver, Charcoal

*82"H available up to 36"W

Code	Price	H	W	D
One 8" frosted glass segment on top				
L-PELFG-4224-00E	1365	24	42	2
L-PELFG-4230-00E	1415	30	42	2
L-PELFG-4236-00E	1495	36	42	2
L-PELFG-4242-00E	1666	42	42	2
L-PELFG-4248-00E	1719	48	42	2
L-PELFG-5024-00E	1407	24	50	2
L-PELFG-5030-00E	1458	30	50	2
L-PELFG-5036-00E	1546	36	50	2
L-PELFG-5042-00E	1732	42	50	2
L-PELFG-5048-00E	1789	48	50	2
One 16" frosted glass segment on top				
L-PELFG-5024-00S	1482	24	50	2
L-PELFG-5030-00S	1559	30	50	2
L-PELFG-5036-00S	1663	36	50	2
L-PELFG-5042-00S	1853	42	50	2
L-PELFG-5048-00S	1926	48	50	2
L-PELFG-6624-00S	1596	24	66	2
L-PELFG-6630-00S	1673	30	66	2
L-PELFG-6636-00S	1791	36	66	2
L-PELFG-6642-00S	2049	42	66	2
L-PELFG-6648-00S	2128	48	66	2
L-PELFG-8224-00S	1913	24	82	2
L-PELFG-8230-00S	1960	30	82	2
L-PELFG-8236-00S	2582	36	82	2
One 24" frosted glass segment on top				
L-PELFG-6624-00T	1644	24	66	2
L-PELFG-6630-00T	1744	30	66	2
L-PELFG-6636-00T	1873	36	66	2
L-PELFG-6642-00T	2106	42	66	2
L-PELFG-6648-00T	2212	48	66	2

Code	Price	H	W	D
Two 8" frosted glass segments on top				
L-PELFG-6624-0EE	1825	24	66	2
L-PELFG-6630-0EE	1870	30	66	2
L-PELFG-6636-0EE	2208	36	66	2
L-PELFG-6642-0EE	2253	42	66	2
L-PELFG-6648-0EE	2323	48	66	2
One 8" & One 16" frosted glass segment on top				
L-PELFG-6624-0ES	1825	24	66	2
L-PELFG-6630-0ES	1902	30	66	2
L-PELFG-6636-0ES	2280	36	66	2
L-PELFG-6642-0ES	2361	42	66	2
L-PELFG-6648-0ES	2470	48	66	2
Two 16" frosted glass segments on top				
L-PELFG-8224-0SS	1884	24	82	2
L-PELFG-8230-0SS	1971	30	82	2
L-PELFG-8236-0SS	2386	36	82	2
One 24" & One 16" frosted glass segment on top				
L-PELFG-8224-0TS	1950	24	82	2
L-PELFG-8230-0TS	2085	30	82	2
L-PELFG-8236-0TS	2521	36	82	2
Two 24" frosted glass segments on top				
L-PELFG-8224-0TT	1948	24	82	2
L-PELFG-8230-0TT	2108	30	82	2
L-PELFG-8236-0TT	2474	36	82	2
One 8" & Two 16" frosted glass segments on top				
L-PELFG-8224-ESS	2184	24	82	2
L-PELFG-8230-ESS	2371	30	82	2
L-PELFG-8236-ESS	2806	36	82	2
Three 16" frosted glass segments on top				
L-PELFG-8224-SSS	2158	24	82	2
L-PELFG-8230-SSS	2280	30	82	2
L-PELFG-8236-SSS	2669	36	82	2

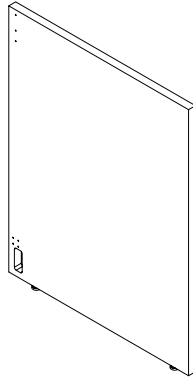

Single Span Middle
Horizontal Woodgrain
Gallery Panel

What's Included:

One (1) 1" thick laminate gallery panel, two (2) gallery panel top brackets

How to Specify:

Refer to laminate cards for laminate selections

Notes:

Gallery panels come with pre-drilled holes on each side and bottom notch for wire routing

Gallery panels must be used between two standard fabric or laminate panels

Gallery panels must be the same height or lower than the connecting standard fabric or laminate panel

Options:

Height: 34", 42", 50"

Width: 26", 32", 38", 44", 50", 56", 62", 68", 74"

Laminate color

Code	Price	H	W	D	Weight (lb.)	Volume (ft ³)
L-PYHM-3426-S1	324	34	26	2		
L-PYHM-3432-S1	358	34	32	2		
L-PYHM-3438-S1	390	34	38	2		
L-PYHM-3444-S1	423	34	44	2		
L-PYHM-3450-S1	456	34	50	2		
L-PYHM-3456-S1	486	34	50	2		
L-PYHM-3462-S1	523	34	62	2		
L-PYHM-3468-S1	554	34	68	2		
L-PYHM-3474-S1	585	34	74	2		
L-PYHM-4226-S1	358	42	26	2		
L-PYHM-4232-S1	399	42	32	2		
L-PYHM-4238-S1	438	42	38	2		
L-PYHM-4244-S1	480	42	44	2		
L-PYHM-4250-S1	521	42	50	2		
L-PYHM-4256-S1	556	42	50	2		
L-PYHM-4262-S1	598	42	62	2		
L-PYHM-4268-S1	639	42	68	2		
L-PYHM-4274-S1	682	42	74	2		
L-PYHM-5026-S1	396	50	26	2		
L-PYHM-5032-S1	439	50	32	2		
L-PYHM-5038-S1	485	50	38	2		
L-PYHM-5044-S1	536	50	44	2		
L-PYHM-5050-S1	581	50	50	2		
L-PYHM-5056-S1	630	50	50	2		
L-PYHM-5062-S1	678	50	62	2		
L-PYHM-5068-S1	720	50	68	2		
L-PYHM-5074-S1	771	50	74	2		

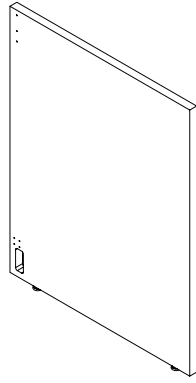

Double Span Middle
Horizontal Woodgrain
Gallery Panel

What's Included:

- X"-X": One (1) 1"thick laminate gallery panel, two (2) gallery panel top brackets
- X"-X": Two (2) 1"thick laminate gallery panel, four (4) gallery panel top brackets

How to Specify:

Refer to laminate cards for laminate selections

Notes:

- Gallery panels come with pre-drilled holes on each side and bottom notch for wire routing
- Gallery panels must be used between two standard fabric or laminate panels
- Gallery panels must be the same height or lower than the connecting standard fabric or laminate panel

Options:

Height:	34", 42", 50"
Width:	26", 32", 38", 44", 50", 56", 62", 68", 74"
Laminate color	

Code	Price	H	W	D	Weight (lb.)	Volume (ft ³)
1 Piece						
L-PYHM-3442-D1	411	34	42	2		
L-PYHM-3450-D1	456	34	50	2		
L-PYHM-3462-D1	523	34	62	2		
L-PYHM-3474-D1	585	34	74	2		
L-PYHM-3486-D1	654	34	86	2		
L-PYHM-4242-D1	465	42	42	2		
L-PYHM-4250-D1	521	42	50	2		
L-PYHM-4262-D1	598	42	62	2		
L-PYHM-4274-D1	682	42	74	2		
L-PYHM-4286-D1	761	42	86	2		
L-PYHM-5042-D1	521	50	42	2		
L-PYHM-5050-D1	581	50	50	2		
L-PYHM-5062-D1	678	50	62	2		
L-PYHM-5074-D1	771	50	74	2		
L-PYHM-5086-D1	865	50	86	2		
2 Pieces						
L-PYHM-3498-D2	838	34	98	2		
L-PYHM-4298-D2	964	42	98	2		
L-PYHM-5098-D2	1089	50	98	2		
L-PYHM-34110-D2	907	34	110	2		
L-PYHM-34122-D2	972	34	122	2		
L-PYHM-34134-D2	1036	34	134	2		
L-PYHM-34146-D2	1104	34	146	2		
L-PYHM-42110-D2	1044	42	110	2		
L-PYHM-42122-D2	1123	42	122	2		
L-PYHM-42134-D2	1206	42	134	2		
L-PYHM-42146-D2	1287	42	146	2		
L-PYHM-50110-D2	1183	50	110	2		
L-PYHM-50122-D2	1277	50	122	2		
L-PYHM-50134-D2	1374	50	134	2		
L-PYHM-50146-D2	1468	50	146	2		



Single Span End Horizontal Woodgrain Gallery Panel No Power Cutout

What's Included:

One (1) 1" thick laminate gallery panel, two (2) gallery panel top brackets

How to Specify:

Refer to laminate cards for laminate selections

Choose option for power cut out or no power cut out

Options:

Height: 34", 42", 50"

Width: 26", 32", 38", 44", 50", 56", 62", 68", 74"

Laminate color

Power cut out

Code	Price	H	W	D	Weight (lb.)	Volume (ft ³)
left hand						
L-PYHE-3426-S1L	279	34	26	2		
L-PYHE-3432-S1L	311	34	32	2		
L-PYHE-3438-S1L	343	34	38	2		
L-PYHE-3444-S1L	375	34	44	2		
L-PYHE-3450-S1L	409	34	50	2		
L-PYHE-3456-S1L	441	34	56	2		
L-PYHE-3462-S1L	476	34	62	2		
L-PYHE-3468-S1L	507	34	68	2		
L-PYHE-3474-S1L	541	34	74	2		
L-PYHE-4226-S1L	311	42	26	2		
L-PYHE-4232-S1L	351	42	32	2		
L-PYHE-4238-S1L	391	42	38	2		
L-PYHE-4244-S1L	431	42	44	2		
L-PYHE-4250-S1L	473	42	50	2		
L-PYHE-4256-S1L	510	42	56	2		

Code	Price	H	W	D	Weight (lb.)	Volume (ft ³)
L-PYHE-4262-S1L	552	42	62	2		
L-PYHE-4268-S1L	593	42	68	2		
L-PYHE-4274-S1L	634	42	74	2		
L-PYHE-5026-S1L	346	50	26	2		
L-PYHE-5032-S1L	396	50	32	2		
L-PYHE-5038-S1L	439	50	38	2		
L-PYHE-5044-S1L	486	50	44	2		
L-PYHE-5050-S1L	536	50	50	2		
L-PYHE-5056-S1L	582	50	56	2		
L-PYHE-5062-S1L	630	50	62	2		
L-PYHE-5068-S1L	678	50	68	2		
L-PYHE-5074-S1L	723	50	74	2		
right hand						
L-PYHE-3426-S1R	279	34	26	2		
L-PYHE-3432-S1R	311	34	32	2		
L-PYHE-3438-S1R	343	34	38	2		
L-PYHE-3444-S1R	375	34	44	2		
L-PYHE-3450-S1R	409	34	50	2		
L-PYHE-3456-S1R	441	34	56	2		
L-PYHE-3462-S1R	476	34	62	2		
L-PYHE-3468-S1R	507	34	68	2		
L-PYHE-3474-S1R	541	34	74	2		
L-PYHE-4226-S1R	311	42	26	2		
L-PYHE-4232-S1R	351	42	32	2		
L-PYHE-4238-S1R	391	42	38	2		
L-PYHE-4244-S1R	431	42	44	2		
L-PYHE-4250-S1R	473	42	50	2		
L-PYHE-4256-S1R	510	42	56	2		
L-PYHE-4262-S1R	552	42	62	2		
L-PYHE-4268-S1R	593	42	68	2		
L-PYHE-4274-S1R	634	42	74	2		
L-PYHE-5026-S1R	346	50	26	2		
L-PYHE-5032-S1R	396	50	32	2		
L-PYHE-5038-S1R	439	50	38	2		
L-PYHE-5044-S1R	486	50	44	2		
L-PYHE-5050-S1R	536	50	50	2		
L-PYHE-5056-S1R	582	50	56	2		
L-PYHE-5062-S1R	630	50	62	2		
L-PYHE-5068-S1R	678	50	68	2		
L-PYHE-5074-S1R	723	50	74	2		



Single Span End Horizontal Woodgrain Gallery Panel with Power Cutout

What's Included:

One (1) 1" thick laminate gallery panel, two (2) gallery panel top brackets

How to Specify:

Refer to laminate cards for laminate selections

Choose option for power cut out or no power cut out

Options:

Height: 34", 42", 50"

Width: 26", 32", 38", 44", 50", 56", 62", 68", 74"

Laminate color

No power cut out

Code	Price	H	W	D	Weight (lb.)	Volume (ft ³)
left hand						
L-PCHE-3426-S1L	279	34	26	1		
L-PCHE-3432-S1L	311	34	32	1		
L-PCHE-3438-S1L	343	34	38	1		
L-PCHE-3444-S1L	375	34	44	1		
L-PCHE-3450-S1L	409	34	50	1		
L-PCHE-3456-S1L	441	34	56	1		
L-PCHE-3462-S1L	476	34	62	1		
L-PCHE-3468-S1L	507	34	68	1		
L-PCHE-3474-S1L	541	34	74	1		
L-PCHE-4226-S1L	311	42	26	1		
L-PCHE-4232-S1L	351	42	32	1		
L-PCHE-4238-S1L	391	42	38	1		
L-PCHE-4244-S1L	431	42	44	1		
L-PCHE-4250-S1L	473	42	50	1		
L-PCHE-4256-S1L	510	42	56	1		

Code	Price	H	W	D	Weight (lb.)	Volume (ft ³)
L-PCHE-4262-S1L	552	42	62	1		
L-PCHE-4268-S1L	593	42	68	1		
L-PCHE-4274-S1L	634	42	74	1		
L-PCHE-5026-S1L	346	50	26	1		
L-PCHE-5032-S1L	396	50	32	1		
L-PCHE-5038-S1L	439	50	38	1		
L-PCHE-5044-S1L	486	50	44	1		
L-PCHE-5050-S1L	536	50	50	1		
L-PCHE-5056-S1L	582	50	56	1		
L-PCHE-5062-S1L	630	50	62	1		
L-PCHE-5068-S1L	678	50	68	1		
L-PCHE-5074-S1L	723	50	74	1		
right hand						
L-PCHE-3426-S1R	279	34	26	1		
L-PCHE-3432-S1R	311	34	32	1		
L-PCHE-3438-S1R	343	34	38	1		
L-PCHE-3444-S1R	375	34	44	1		
L-PCHE-3450-S1R	409	34	50	1		
L-PCHE-3456-S1R	441	34	56	1		
L-PCHE-3462-S1R	476	34	62	1		
L-PCHE-3468-S1R	507	34	68	1		
L-PCHE-3474-S1R	541	34	74	1		
L-PCHE-4226-S1R	311	42	26	1		
L-PCHE-4232-S1R	351	42	32	1		
L-PCHE-4238-S1R	391	42	38	1		
L-PCHE-4244-S1R	431	42	44	1		
L-PCHE-4250-S1R	473	42	50	1		
L-PCHE-4256-S1R	510	42	56	1		
L-PCHE-4262-S1R	552	42	62	1		
L-PCHE-4268-S1R	593	42	68	1		
L-PCHE-4274-S1R	634	42	74	1		
L-PCHE-5026-S1R	346	50	26	1		
L-PCHE-5032-S1R	396	50	32	1		
L-PCHE-5038-S1R	439	50	38	1		
L-PCHE-5044-S1R	486	50	44	1		
L-PCHE-5050-S1R	536	50	50	1		
L-PCHE-5056-S1R	582	50	56	1		
L-PCHE-5062-S1R	630	50	62	1		
L-PCHE-5068-S1R	678	50	68	1		
L-PCHE-5074-S1R	723	50	74	1		



Single piece
Double Span End
Horizontal Woodgrain
Gallery Panel
No Power Cutout



Two pieces
Double Span End
Horizontal Woodgrain
Gallery Panel
No Power Cutout

What's Included:

- X"-X": One (1) 1"thick laminate gallery panel, two (2) gallery panel top brackets
- X"-X": Two (2) 1"thick laminate gallery panel, four (4) gallery panel top brackets

How to Specify:

- Refer to laminate cards for laminate selections
- Choose option for power cut out or no power cut out

Options:

Height:

Width:

Laminate color

Power cut out

Notes:

- Gallery panels come with pre-drilled holes on each side and bottom notch for wire routing
- Gallery panels must be used between two standard fabric or laminate panels
- Gallery panels must be the same height or lower than the connecting standard fabric or laminate panel

Code	Price	H	W	D	Weight (lb.)	Volume (ft ³)
single piece						
L-PYHE-3442-D1	364	34	42	2		
L-PYHE-3450-D1	409	34	50	2		
L-PYHE-3462-D1	476	34	62	2		
L-PYHE-3474-D1	541	34	74	2		
L-PYHE-3486-D1	607	34	86	2		
L-PYHE-4242-D1	421	42	42	2		
L-PYHE-4250-D1	473	42	50	2		
L-PYHE-4262-D1	552	42	62	2		
L-PYHE-4274-D1	634	42	74	2		
L-PYHE-4286-D1	713	42	86	2		
L-PYHE-5042-D1	473	50	42	2		
L-PYHE-5050-D1	536	50	50	2		
L-PYHE-5062-D1	630	50	62	2		
L-PYHE-5074-D1	723	50	74	2		
L-PYHE-5086-D1	820	50	86	2		
2 pieces						
L-PYHE-3498-D2	838	34	98	2		
L-PYHE-4298-D2	964	42	98	2		
L-PYHE-5098-D2	1089	50	98	2		
L-PYHE-34110-D2	907	34	110	2		
L-PYHE-34122-D2	972	34	122	2		
L-PYHE-34134-D2	1036	34	134	2		
L-PYHE-34146-D2	1104	34	146	2		
L-PYHE-42110-D2	1044	42	110	2		
L-PYHE-42122-D2	1123	42	122	2		
L-PYHE-42134-D2	1206	42	134	2		
L-PYHE-42146-D2	1287	42	146	2		
L-PYHE-50110-D2	1183	50	110	2		
L-PYHE-50122-D2	1277	50	122	2		
L-PYHE-50134-D2	1374	50	134	2		
L-PYHE-50146-D2	1468	50	146	2		

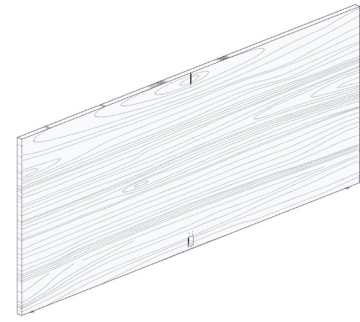

Single piece

Double Span End Horizontal Woodgrain Gallery Panel with Power Cutout



2 pieces

What's Included:

X"-X": One (1) 1"thick laminate gallery panel, two (2) gallery panel top brackets

X"-X": Two (2) 1"thick laminate gallery panel, four (4) gallery panel top brackets

How to Specify:

Refer to laminate cards for laminate selections

Choose option for power cut out or no power cut out

Notes:

Gallery panels come with pre-drilled holes on each side and bottom notch for wire routing

Gallery panels must be used between two standard fabric or laminate panels

Gallery panels must be the same height or lower than the connecting standard fabric or laminate panel

Options:

Height: 34", 42", 50"

Width: 26", 32", 38", 44", 50", 56", 62", 68", 74"

Laminate color

No power cut out

Code	Price	H	W	D	Weight (lb.)	Volume (ft ³)
single piece						
L-PCHE-3442-D1	364	34	42	1		
L-PCHE-3450-D1	409	34	50	1		
L-PCHE-3462-D1	476	34	62	1		
L-PCHE-3474-D1	541	34	74	1		
L-PCHE-3486-D1	607	34	86	1		
L-PCHE-4242-D1	421	42	42	1		
L-PCHE-4250-D1	473	42	50	1		
L-PCHE-4262-D1	552	42	62	1		
L-PCHE-4274-D1	634	42	74	1		
L-PCHE-4286-D1	713	42	86	1		
L-PCHE-5042-D1	473	50	42	1		
L-PCHE-5050-D1	536	50	50	1		
L-PCHE-5062-D1	630	50	62	1		
L-PCHE-5074-D1	723	50	74	1		
L-PCHE-5086-D1	820	50	86	1		
2 pieces						
L-PCHE-3498-D2	838	34	98	1		
L-PCHE-34110-D2	907	34	110	1		
L-PCHE-34122-D2	972	34	122	1		
L-PCHE-34134-D2	1036	34	134	1		
L-PCHE-34146-D2	1104	34	146	1		
L-PCHE-4298-D2	964	42	98	1		
L-PCHE-42110-D2	1044	42	110	1		
L-PCHE-42122-D2	1123	42	122	1		
L-PCHE-42134-D2	1206	42	134	1		
L-PCHE-42146-D2	1287	42	146	1		
L-PCHE-5098-D2	1089	50	98	1		
L-PCHE-50110-D2	1183	50	110	1		
L-PCHE-50122-D2	1277	50	122	1		
L-PCHE-50134-D2	1374	50	134	1		
L-PCHE-50146-D2	1468	50	146	1		

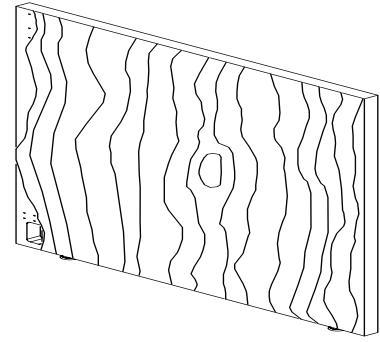

Single Span Middle
Vertical Woodgrain
Gallery Panel

What's Included:

One (1) 1" thick laminate gallery panel,
two (2) gallery panel top brackets

How to Specify:

Refer to laminate cards for laminate selections

Notes:

Gallery panels come with pre-drilled holes on each side and bottom notch for wire routing

Gallery panels must be used between two standard fabric or laminate panels

Gallery panels must be the same height or lower than the connecting standard fabric or laminate panel

Options:

Height: 34", 42", 50"

Width: 26", 32", 38", 44", 50", 56", 62", 68", 74"

Laminate color

Code	Price	H	W	D	Weight (lb.)	Volume (ft ³)
L-PYGM-3426-S1	324	34	26	1	17.68	0.51
L-PYGM-3432-S1	358	34	32	1	21.76	0.63
L-PYGM-3438-S1	390	34	38	1	25.84	0.75
L-PYGM-3444-S1	423	34	44	1	29.92	0.87
L-PYGM-3450-S1	456	34	50	1	34.00	0.98
L-PYGM-3456-S1	486	34	56	1	38.08	1.10
L-PYGM-4226-S1	358	42	26	1	21.84	0.63
L-PYGM-4232-S1	399	42	32	1	26.88	0.78
L-PYGM-4238-S1	438	42	38	1	31.92	0.92
L-PYGM-4244-S1	480	42	44	1	36.96	1.07
L-PYGM-4250-S1	521	42	50	1	42.00	1.22
L-PYGM-4256-S1	556	42	56	1	47.04	1.36
L-PYGM-5026-S1	396	50	26	1	26.00	0.75
L-PYGM-5032-S1	439	50	32	1	32.00	0.93
L-PYGM-5038-S1	485	50	38	1	38.00	1.10
L-PYGM-5044-S1	536	50	44	1	44.00	1.27
L-PYGM-5050-S1	581	50	50	1	50.00	1.45
L-PYGM-5056-S1	630	50	56	1	56.00	1.62

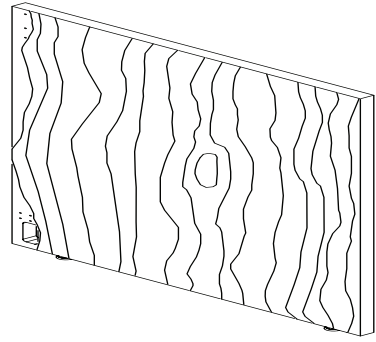

Double Span Middle
Vertical Woodgrain
Gallery Panel

What's Included:

X"-X": One (1) 1"thick laminate gallery panel, two (2) gallery panel top brackets

X"-X": Two (2) 1"thick laminate gallery panel, four (4) gallery panel top brackets

How to Specify:

Refer to laminate cards for laminate selections

Notes:

Gallery panels come with pre-drilled holes on each side and bottom notch for wire routing

Gallery panels must be used between two standard fabric or laminate panels

Gallery panels must be the same height or lower than the connecting standard fabric or laminate panel

Options:

Height: 34", 42", 50"

Width: 26", 32", 38", 44", 50", 56", 62", 68", 74"

Laminate color

Code	Price	H	W	D	Weight (lb.)	Volume (ft ³)
single piece						
L-PYGM-3442-D1	411	34	42	1	28.56	0.83
L-PYGM-3450-D1	456	34	50	1	34.00	0.98
L-PYGM-4242-D1	465	42	42	1	28.56	1.02
L-PYGM-4250-D1	521	42	50	1	42.00	1.22
L-PYGM-5042-D1	521	50	42	1	28.56	1.22
L-PYGM-5050-D1	581	50	50	1	50.00	1.45
2 pieces						
L-PYGM-3462-D2	641	34	62	1	42.16	1.22
L-PYGM-3474-D2	709	34	74	1	50.32	1.46
L-PYGM-3486-D2	773	34	86	1	58.48	1.69
L-PYGM-3498-D2	838	34	98	1	66.64	1.93
L-PYGM-4262-D2	720	42	62	1	52.08	1.51
L-PYGM-4274-D2	804	42	74	1	62.16	1.80
L-PYGM-4286-D2	883	42	86	1	72.24	2.09
L-PYGM-4298-D2	964	42	98	1	82.32	2.38
L-PYGM-5062-D2	806	50	62	1	62.00	1.79
L-PYGM-5074-D2	897	50	74	1	74.00	2.14
L-PYGM-5086-D2	993	50	86	1	86.00	2.49
L-PYGM-5098-D2	1089	50	98	1	98.00	2.84
L-PYGM-34110-D2	907	34	110	1	74.80	2.16
L-PYGM-42110-D2	1044	42	110	1	92.40	2.67
L-PYGM-50110-D2	1183	50	110	1	110.00	3.18

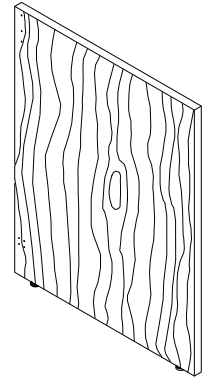

Single Span End
Vertical Woodgrain
Gallery Panel
No Power Cutout

What's Included:

One (1) 1"thick laminate gallery panel,
two (2) gallery panel top brackets

How to Specify:

Refer to laminate cards for laminate selections

Choose option for power cut out or no power cut out

Notes:

Gallery panels come with pre-drilled holes on each side and bottom notch for wire routing

Gallery panels must be used between two standard fabric or laminate panels

Gallery panels must be the same height or lower than the connecting standard fabric or laminate panel

Options:

Height: 34", 42", 50"

Width: 26", 32", 38", 44", 50", 56", 62", 68", 74"

Laminate color

Power cut out, No power cut out

Code	Price	H	W	D	Weight (lb.)	Volume (ft ³)
left hand						
L-PYGE-3426-S1L	279	34	26	1	17.68	0.51
L-PYGE-3432-S1L	311	34	32	1	21.76	0.63
L-PYGE-3438-S1L	343	34	38	1	25.84	0.75
L-PYGE-3444-S1L	375	34	44	1	29.92	0.87
L-PYGE-3450-S1L	409	34	50	1	34.00	0.98
L-PYGE-3456-S1L	441	34	56	1	38.08	1.10
L-PYGE-4226-S1L	311	42	26	1	21.84	0.63
L-PYGE-4232-S1L	351	42	32	1	26.88	0.78
L-PYGE-4238-S1L	391	42	38	1	31.92	0.92
L-PYGE-4244-S1L	431	42	44	1	36.96	1.07
L-PYGE-4250-S1L	473	42	50	1	42.00	1.22
L-PYGE-4256-S1L	510	42	56	1	47.04	1.36
L-PYGE-5026-S1L	346	50	26	1	26.00	0.75
L-PYGE-5032-S1L	396	50	32	1	32.00	0.93
L-PYGE-5038-S1L	439	50	38	1	38.00	1.10
L-PYGE-5044-S1L	486	50	44	1	44.00	1.27
L-PYGE-5050-S1L	536	50	50	1	50.00	1.45
L-PYGE-5056-S1L	582	50	56	1	56.00	1.62
right hand						
L-PYGE-3426-S1R	279	34	26	1	17.68	0.51
L-PYGE-3432-S1R	311	34	32	1	21.76	0.63
L-PYGE-3438-S1R	343	34	38	1	25.84	0.75
L-PYGE-3444-S1R	375	34	44	1	29.92	0.87
L-PYGE-3450-S1R	409	34	50	1	34.00	0.98
L-PYGE-3456-S1R	441	34	56	1	38.08	1.10
L-PYGE-4226-S1R	311	42	26	1	21.84	0.63
L-PYGE-4232-S1R	351	42	32	1	26.88	0.78
L-PYGE-4238-S1R	391	42	38	1	31.92	0.92
L-PYGE-4244-S1R	431	42	44	1	36.96	1.07
L-PYGE-4250-S1R	473	42	50	1	42.00	1.22
L-PYGE-4256-S1R	510	42	56	1	47.04	1.36
L-PYGE-5026-S1R	346	50	26	1	26.00	0.75
L-PYGE-5032-S1R	396	50	32	1	32.00	0.93
L-PYGE-5038-S1R	439	50	38	1	38.00	1.10
L-PYGE-5044-S1R	486	50	44	1	44.00	1.27
L-PYGE-5050-S1R	536	50	50	1	50.00	1.45
L-PYGE-5056-S1R	582	50	56	1	56.00	1.62

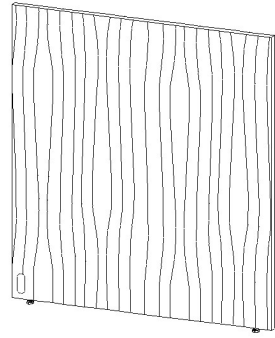

Single Span End
Vertical Woodgrain
Gallery Panel
with Power Cutout

What's Included:

One (1) 1"thick laminate gallery panel,
two (2) gallery panel top brackets

How to Specify:

Refer to laminate cards for laminate selections

Choose option for power cut out or no power cut out

Notes:

Gallery panels come with pre-drilled holes on each side and bottom notch for wire routing

Gallery panels must be used between two standard fabric or laminate panels

Gallery panels must be the same height or lower than the connecting standard fabric or laminate panel

Options:

Height: 34", 42", 50"

Width: 26", 32", 38", 44", 50", 56", 62", 68", 74"

Laminate color

Power cut out, No power cut out

Code	Price	H	W	D	Weight (lb.)	Volume (ft ³)
left hand						
L-PCGE-3426-S1L	279	34	26	1	17.68	0.51
L-PCGE-3432-S1L	311	34	32	1	21.76	0.63
L-PCGE-3438-S1L	343	34	38	1	25.84	0.75
L-PCGE-3444-S1L	375	34	44	1	29.92	0.87
L-PCGE-3450-S1L	409	34	50	1	34.00	0.98
L-PCGE-3456-S1L	441	34	56	1	38.08	1.10
L-PCGE-4226-S1L	311	42	26	1	21.84	0.63
L-PCGE-4232-S1L	351	42	32	1	26.88	0.78
L-PCGE-4238-S1L	391	42	38	1	31.92	0.92
L-PCGE-4244-S1L	431	42	44	1	36.96	1.07
L-PCGE-4250-S1L	473	42	50	1	42.00	1.22
L-PCGE-4256-S1L	510	42	56	1	47.04	1.36
L-PCGE-5026-S1L	346	50	26	1	26.00	0.75
L-PCGE-5032-S1L	396	50	32	1	32.00	0.93
L-PCGE-5038-S1L	439	50	38	1	38.00	1.10
L-PCGE-5044-S1L	486	50	44	1	44.00	1.27
L-PCGE-5050-S1L	536	50	50	1	50.00	1.45
L-PCGE-5056-S1L	582	50	56	1	56.00	1.62
right hand						
L-PCGE-3426-S1R	279	34	26	1	17.68	0.51
L-PCGE-3432-S1R	311	34	32	1	21.76	0.63
L-PCGE-3438-S1R	343	34	38	1	25.84	0.75
L-PCGE-3444-S1R	375	34	44	1	29.92	0.87
L-PCGE-3450-S1R	409	34	50	1	34.00	0.98
L-PCGE-3456-S1R	441	34	56	1	38.08	1.10
L-PCGE-4226-S1R	311	42	26	1	21.84	0.63
L-PCGE-4232-S1R	351	42	32	1	26.88	0.78
L-PCGE-4238-S1R	391	42	38	1	31.92	0.92
L-PCGE-4244-S1R	431	42	44	1	36.96	1.07
L-PCGE-4250-S1R	473	42	50	1	42.00	1.22
L-PCGE-4256-S1R	510	42	56	1	47.04	1.36
L-PCGE-5026-S1R	346	50	26	1	26.00	0.75
L-PCGE-5032-S1R	396	50	32	1	32.00	0.93
L-PCGE-5038-S1R	439	50	38	1	38.00	1.10
L-PCGE-5044-S1R	486	50	44	1	44.00	1.27
L-PCGE-5050-S1R	536	50	50	1	50.00	1.45
L-PCGE-5056-S1R	582	50	56	1	56.00	1.62

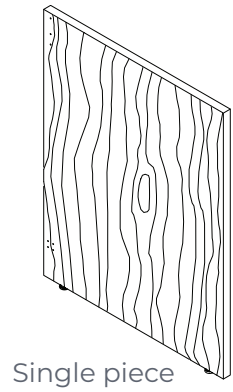

Double Span End
Vertical Woodgrain
Gallery Panel
No Power Cutout

Single piece

What's Included:

X"-X": One (1) 1"thick laminate gallery panel, two (2) gallery panel top brackets

X"-X": Two (2) 1"thick laminate gallery panel, four (4) gallery panel top brackets

How to Specify:

Refer to laminate cards for laminate selections

Choose option for power cut out or no power cut out

Notes:

Gallery panels come with pre-drilled holes on each side and bottom notch for wire routing

Gallery panels must be used between two standard fabric or laminate panels

Gallery panels must be the same height or lower than the connecting standard fabric or laminate panel

Options:

Height: 34", 42", 50"

Width: 26", 32", 38", 44", 50", 56", 62", 68", 74"

Laminate color

Power cut out, no power cut out

Code	Price	H	W	D	Weight (lb.)	Volume (ft ³)
single piece						
L-PYGE-3442-D1	364	34	42	1	28.56	0.83
L-PYGE-3450-D1	409	34	50	1	34.00	0.98
L-PYGE-4242-D1	421	42	42	1	28.56	1.02
L-PYGE-4250-D1	473	42	50	1	42.00	1.22
L-PYGE-5042-D1	473	50	42	1	28.56	1.22
L-PYGE-5050-D1	536	50	50	1	50.00	1.45
2 pieces						
L-PYGE-3462-D2	641	34	62	1	42.16	1.22
L-PYGE-3474-D2	709	34	74	1	50.32	1.46
L-PYGE-3486-D2	773	34	86	1	58.48	1.69
L-PYGE-3498-D2	838	34	98	1	66.64	1.93
L-PYGE-4262-D2	720	42	62	1	52.08	1.51
L-PYGE-4274-D2	804	42	74	1	62.16	1.80
L-PYGE-4286-D2	883	42	86	1	72.24	2.09
L-PYGE-4298-D2	964	42	98	1	82.32	2.38
L-PYGE-5062-D2	806	50	62	1	62.00	1.79
L-PYGE-5074-D2	897	50	74	1	74.00	2.14
L-PYGE-5086-D2	993	50	86	1	86.00	2.49
L-PYGE-5098-D2	1089	50	98	1	98.00	2.84
L-PYGE-34110-D2	907	34	110	1	74.80	2.16
L-PYGE-42110-D2	1044	42	110	1	92.40	2.67
L-PYGE-50110-D2	1183	50	110	1	110.00	3.18

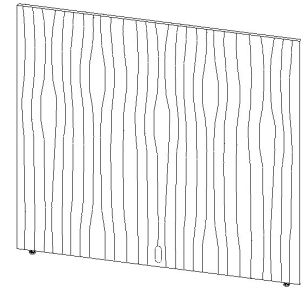

Single piece

Double Span End Vertical Woodgrain Gallery Panel with Power Cutout

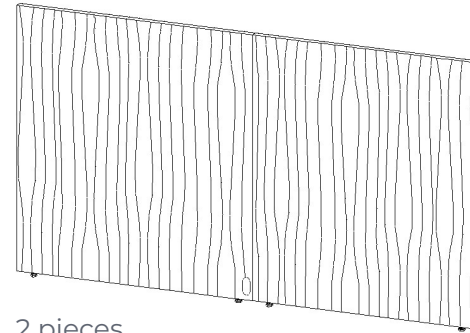

2 pieces

What's Included:

X"-X": One (1) 1"thick laminate gallery panel, two (2) gallery panel top brackets

X"-X": Two (2) 1"thick laminate gallery panel, four (4) gallery panel top brackets

How to Specify:

Refer to laminate cards for laminate selections

Choose option for power cut out or no power cut out

Notes:

Gallery panels come with pre-drilled holes on each side and bottom notch for wire routing

Gallery panels must be used between two standard fabric or laminate panels

Gallery panels must be the same height or lower than the connecting standard fabric or laminate panel

Options:

Height: 34", 42", 50"

Width: 26", 32", 38", 44", 50", 56", 62", 68", 74"

Laminate color

Power cut out, no power cut out

Code	Price	H	W	D	Weight (lb.)	Volume (ft ³)
single piece						
L-PCGE-3442-D1	364	34	42	1	28.56	0.83
L-PCGE-3450-D1	409	34	50	1	34.00	0.98
L-PCGE-4242-D1	421	42	42	1	28.56	1.02
L-PCGE-4250-D1	473	42	50	1	42.00	1.22
L-PCGE-5042-D1	473	50	42	1	28.56	1.22
L-PCGE-5050-D1	536	50	50	1	50.00	1.45
2 pieces						
L-PCGE-3462-D2	641	34	62	1	42.16	1.22
L-PCGE-3474-D2	709	34	74	1	50.32	1.46
L-PCGE-3486-D2	773	34	86	1	58.48	1.69
L-PCGE-3498-D2	838	34	98	1	66.64	1.93
L-PCGE-34110-D2	907	34	110	1	52.08	1.51
L-PCGE-4262-D2	720	42	62	1	62.16	1.80
L-PCGE-4274-D2	804	42	74	1	72.24	2.09
L-PCGE-4286-D2	883	42	86	1	82.32	2.38
L-PCGE-4298-D2	964	42	98	1	62.00	1.79
L-PCGE-42110-D2	1044	42	110	1	74.00	2.14
L-PCGE-5062-D2	806	50	62	1	86.00	2.49
L-PCGE-5074-D2	897	50	74	1	98.00	2.84
L-PCGE-5086-D2	993	50	86	1	74.80	2.16
L-PCGE-5098-D2	1089	50	98	1	92.40	2.67
L-PCGE-50110-D2	1183	50	110	1	110.00	3.18

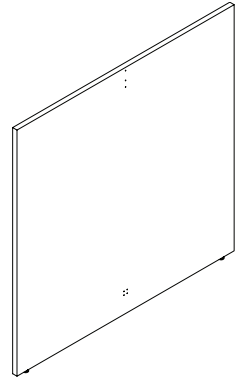

Single Span Middle
Solid Gallery Panel

What's Included:

One (1) 1"thick laminate gallery panel,
two (2) gallery panel top brackets

How to Specify:

Refer to laminate cards for laminate selections

Options:

Height: 34", 42", 50"

Width: 26", 32", 38", 44", 50", 56", 62", 68", 74"

Laminate color

Notes:

Gallery panels come with pre-drilled holes on each side and bottom notch for wire routing

Gallery panels must be used between two standard fabric or laminate panels

Gallery panels must be the same height or lower than the connecting standard fabric or laminate panel

Code	Price	H	W	D	Weight (lb.)	Volume (ft ³)
L-PYSM-3426-S1	324	34	26	1	17.68	0.51
L-PYSM-3432-S1	358	34	32	1	21.76	0.63
L-PYSM-3438-S1	390	34	38	1	25.84	0.75
L-PYSM-3444-S1	423	34	44	1	29.92	0.87
L-PYSM-3450-S1	456	34	50	1	34.00	0.98
L-PYSM-3456-S1	486	34	56	1	38.08	1.10
L-PYSM-3462-S1	523	34	62	1	42.16	1.22
L-PYSM-3468-S1	554	34	68	1	46.24	1.34
L-PYSM-3474-S1	585	34	74	1	50.32	1.46
L-PYSM-4226-S1	358	42	26	1	21.84	0.63
L-PYSM-4232-S1	399	42	32	1	26.88	0.78
L-PYSM-4238-S1	438	42	38	1	31.92	0.92
L-PYSM-4244-S1	480	42	44	1	36.96	1.07
L-PYSM-4250-S1	521	42	50	1	42.00	1.22
L-PYSM-4256-S1	556	42	56	1	47.04	1.36
L-PYSM-4262-S1	598	42	62	1	52.08	1.51
L-PYSM-4268-S1	639	42	68	1	57.12	1.65
L-PYSM-4274-S1	682	42	74	1	62.16	1.80
L-PYSM-5026-S1	396	50	26	1	26.00	0.75
L-PYSM-5032-S1	439	50	32	1	32.00	0.93
L-PYSM-5038-S1	485	50	38	1	38.00	1.10
L-PYSM-5044-S1	536	50	44	1	44.00	1.27
L-PYSM-5050-S1	581	50	50	1	50.00	1.45
L-PYSM-5056-S1	630	50	56	1	56.00	1.62
L-PYSM-5062-S1	678	50	62	1	62.00	1.79
L-PYSM-5068-S1	720	50	68	1	68.00	1.97
L-PYSM-5074-S1	771	50	74	1	74.00	2.14

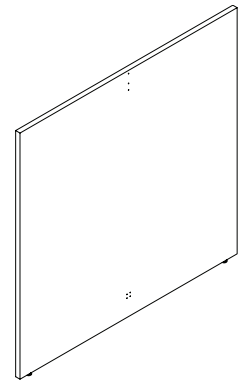

Single piece

Double Span Middle
Solid Gallery Panel

What's Included:

X"-X": One (1) 1"thick laminate gallery panel, two (2) gallery panel top brackets

X"-X": Two (2) 1"thick laminate gallery panel, four (4) gallery panel top brackets

How to Specify:

Refer to laminate cards for laminate selections

Notes:

Gallery panels come with pre-drilled holes on each side and bottom notch for wire routing

Gallery panels must be used between two standard fabric or laminate panels

Gallery panels must be the same height or lower than the connecting standard fabric or laminate panel

Options:

Height: 34", 42", 50"

Width: 26", 32", 38", 44", 50", 56", 62", 68", 74"

Laminate color

Power cut out, no power cut out

Code	Price	H	W	D	Weight (lb.)	Volume (ft ³)
single piece						
L-PYSM-3442-D1	411	34	42	1	28.56	0.83
L-PYSM-3450-D1	456	34	50	1	34.00	0.98
L-PYSM-3462-D1	523	34	62	1	42.16	1.22
L-PYSM-3474-D1	585	34	74	1	50.32	1.46
L-PYSM-3486-D1	654	34	86	1	58.48	1.69
L-PYSM-4242-D1	465	42	42	1	35.28	1.02
L-PYSM-4250-D1	521	42	50	1	42.00	1.22
L-PYSM-4262-D1	598	42	62	1	52.08	1.51
L-PYSM-4274-D1	682	42	74	1	62.16	1.80
L-PYSM-4286-D1	761	42	86	1	72.24	2.09
L-PYSM-5042-D1	521	50	42	1	42.00	1.22
L-PYSM-5050-D1	581	50	50	1	50.00	1.45
L-PYSM-5062-D1	678	50	62	1	62.00	1.79
L-PYSM-5074-D1	771	50	74	1	74.00	2.14
L-PYSM-5086-D1	865	50	86	1	86.00	2.49
2 pieces						
L-PYSM-3498-D2	838	34	98	1	66.64	1.93
L-PYSM-4298-D2	964	42	98	1	82.32	2.38
L-PYSM-5098-D2	1089	50	98	1	98.00	2.84
L-PYSM-34110-D2	907	34	110	1	74.80	2.16
L-PYSM-34122-D2	972	34	122	1	82.96	2.40
L-PYSM-34134-D2	1036	34	134	1	91.12	2.64
L-PYSM-34146-D2	1104	34	146	1	99.28	2.87
L-PYSM-42110-D2	1044	42	110	1	92.40	2.67
L-PYSM-42122-D2	1123	42	122	1	102.48	2.97
L-PYSM-42134-D2	1206	42	134	1	112.56	3.26
L-PYSM-42146-D2	1287	42	146	1	122.64	3.55
L-PYSM-50110-D2	1183	50	110	1	110.00	3.18
L-PYSM-50122-D2	1277	50	122	1	122.00	3.53
L-PYSM-50134-D2	1374	50	134	1	134.00	3.88
L-PYSM-50146-D2	1468	50	146	1	146.00	4.22

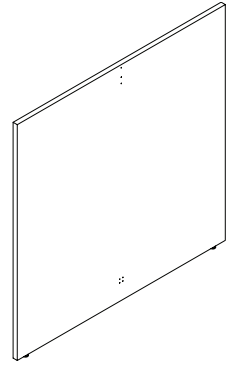

Single Span End Solid Gallery Panel

What's Included:

One (1) 1"thick laminate gallery panel, two (2) gallery panel top brackets

How to Specify:

Refer to laminate cards for laminate selections

Choose option for power cut out or no power cut out

Options:

Height: 34", 42", 50"

Width: 26", 32", 38", 44", 50", 56", 62", 68", 74"

Laminate color

Power cut out, No power cut out

Notes:

Gallery panels come with pre-drilled holes on each side and bottom notch for wire routing

Gallery panels must be used between two standard fabric or laminate panels

Gallery panels must be the same height or lower than the connecting standard fabric or laminate panel

Code	Price	H	W	D	Weight (lb.)	Volume (ft ³)
left hand						
L-PYSE-3426-S1L	279	34	26	1	17.68	0.51
L-PYSE-3432-S1L	311	34	32	1	21.76	0.63
L-PYSE-3438-S1L	343	34	38	1	25.84	0.75
L-PYSE-3444-S1L	375	34	44	1	29.92	0.87
L-PYSE-3450-S1L	409	34	50	1	34.00	0.98
L-PYSE-3456-S1L	441	34	56	1	38.08	1.10
L-PYSE-3462-S1L	476	34	62	1	42.16	1.22
L-PYSE-3468-S1L	507	34	68	1	46.24	1.34
L-PYSE-3474-S1L	541	34	74	1	50.32	1.46
L-PYSE-4226-S1L	311	42	26	1	21.84	0.63
L-PYSE-4232-S1L	351	42	32	1	26.88	0.78
L-PYSE-4238-S1L	391	42	38	1	31.92	0.92
L-PYSE-4244-S1L	431	42	44	1	36.96	1.07
L-PYSE-4250-S1L	473	42	50	1	42.00	1.22
L-PYSE-4256-S1L	510	42	56	1	47.04	1.36

Code	Price	H	W	D	Weight (lb.)	Volume (ft ³)
L-PYSE-4262-S1L	552	42	62	1	52.08	1.51
L-PYSE-4268-S1L	593	42	68	1	57.12	1.65
L-PYSE-4274-S1L	634	42	74	1	62.16	1.80
L-PYSE-5026-S1L	346	50	26	1	26.00	0.75
L-PYSE-5032-S1L	396	50	32	1	32.00	0.93
L-PYSE-5038-S1L	439	50	38	1	38.00	1.10
L-PYSE-5044-S1L	486	50	44	1	44.00	1.27
L-PYSE-5050-S1L	536	50	50	1	50.00	1.45
L-PYSE-5056-S1L	582	50	56	1	56.00	1.62
L-PYSE-5062-S1L	630	50	62	1	62.00	1.79
L-PYSE-5068-S1L	678	50	68	1	68.00	1.97
L-PYSE-5074-S1L	723	50	74	1	74.00	2.14
right hand						
L-PYSE-3426-S1R	279	34	26	1	17.68	0.51
L-PYSE-3432-S1R	311	34	32	1	21.76	0.63
L-PYSE-3438-S1R	343	34	38	1	25.84	0.75
L-PYSE-3444-S1R	375	34	44	1	29.92	0.87
L-PYSE-3450-S1R	409	34	50	1	34.00	0.98
L-PYSE-3456-S1R	441	34	56	1	38.08	1.10
L-PYSE-3462-S1R	476	34	62	1	42.16	1.22
L-PYSE-3468-S1R	507	34	68	1	46.24	1.34
L-PYSE-3474-S1R	541	34	74	1	50.32	1.46
L-PYSE-4226-S1R	311	42	26	1	21.84	0.63
L-PYSE-4232-S1R	351	42	32	1	26.88	0.78
L-PYSE-4238-S1R	391	42	38	1	31.92	0.92
L-PYSE-4244-S1R	431	42	44	1	36.96	1.07
L-PYSE-4250-S1R	473	42	50	1	42.00	1.22
L-PYSE-4256-S1R	510	42	56	1	47.04	1.36
L-PYSE-4262-S1R	552	42	62	1	52.08	1.51
L-PYSE-4268-S1R	593	42	68	1	57.12	1.65
L-PYSE-4274-S1R	634	42	74	1	62.16	1.80
L-PYSE-5026-S1R	346	50	26	1	26.00	0.75
L-PYSE-5032-S1R	396	50	32	1	32.00	0.93
L-PYSE-5038-S1R	439	50	38	1	38.00	1.10
L-PYSE-5044-S1R	486	50	44	1	44.00	1.27
L-PYSE-5050-S1R	536	50	50	1	50.00	1.45
L-PYSE-5056-S1R	582	50	56	1	56.00	1.62
L-PYSE-5062-S1R	630	50	62	1	62.00	1.79
L-PYSE-5068-S1R	678	50	68	1	68.00	1.97
L-PYSE-5074-S1R	723	50	74	1	74.00	2.14

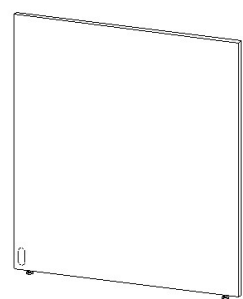

Single Span End Solid Gallery Panel with Power Cutout

What's Included:

One (1) 1"thick laminate gallery panel, two (2) gallery panel top brackets

How to Specify:

Refer to laminate cards for laminate selections

Choose option for power cut out or no power cut out

Options:

Height: 34", 42", 50"

Width: 26", 32", 38", 44", 50", 56", 62", 68", 74"

Laminate color

Power cut out, No power cut out

Notes:

Gallery panels come with pre-drilled holes on each side and bottom notch for wire routing

Gallery panels must be used between two standard fabric or laminate panels

Gallery panels must be the same height or lower than the connecting standard fabric or laminate panel

Code	Price	H	W	D	Weight (lb.)	Volume (ft ³)
left hand						
L-PCSE-3426-S1L	279	34	26	1	17.68	0.51
L-PCSE-3432-S1L	311	34	32	1	21.76	0.63
L-PCSE-3438-S1L	343	34	38	1	25.84	0.75
L-PCSE-3444-S1L	375	34	44	1	29.92	0.87
L-PCSE-3450-S1L	409	34	50	1	34.00	0.98
L-PCSE-3456-S1L	441	34	56	1	38.08	1.10
L-PCSE-3462-S1L	476	34	62	1	42.16	1.22
L-PCSE-3468-S1L	507	34	68	1	46.24	1.34
L-PCSE-3474-S1L	541	34	74	1	50.32	1.46
L-PCSE-4226-S1L	311	42	26	1	21.84	0.63
L-PCSE-4232-S1L	351	42	32	1	26.88	0.78
L-PCSE-4238-S1L	391	42	38	1	31.92	0.92
L-PCSE-4244-S1L	431	42	44	1	36.96	1.07
L-PCSE-4250-S1L	473	42	50	1	42.00	1.22
L-PCSE-4256-S1L	510	42	56	1	47.04	1.36

Code	Price	H	W	D	Weight (lb.)	Volume (ft ³)
L-PCSE-4262-S1L	552	42	62	1	52.08	1.51
L-PCSE-4268-S1L	593	42	68	1	57.12	1.65
L-PCSE-4274-S1L	634	42	74	1	62.16	1.80
L-PCSE-5026-S1L	346	50	26	1	26.00	0.75
L-PCSE-5032-S1L	396	50	32	1	32.00	0.93
L-PCSE-5038-S1L	439	50	38	1	38.00	1.10
L-PCSE-5044-S1L	486	50	44	1	44.00	1.27
L-PCSE-5050-S1L	536	50	50	1	50.00	1.45
L-PCSE-5056-S1L	582	50	56	1	56.00	1.62
L-PCSE-5062-S1L	630	50	62	1	62.00	1.79
L-PCSE-5068-S1L	678	50	68	1	68.00	1.97
L-PCSE-5074-S1L	723	50	74	1	74.00	2.14
right hand						
L-PCSE-3426-S1R	279	34	26	1	17.68	0.51
L-PCSE-3432-S1R	311	34	32	1	21.76	0.63
L-PCSE-3438-S1R	343	34	38	1	25.84	0.75
L-PCSE-3444-S1R	375	34	44	1	29.92	0.87
L-PCSE-3450-S1R	409	34	50	1	34.00	0.98
L-PCSE-3456-S1R	441	34	56	1	38.08	1.10
L-PCSE-3462-S1R	476	34	62	1	42.16	1.22
L-PCSE-3468-S1R	507	34	68	1	46.24	1.34
L-PCSE-3474-S1R	541	34	74	1	50.32	1.46
L-PCSE-4226-S1R	311	42	26	1	21.84	0.63
L-PCSE-4232-S1R	351	42	32	1	26.88	0.78
L-PCSE-4238-S1R	391	42	38	1	31.92	0.92
L-PCSE-4244-S1R	431	42	44	1	36.96	1.07
L-PCSE-4250-S1R	473	42	50	1	42.00	1.22
L-PCSE-4256-S1R	510	42	56	1	47.04	1.36
L-PCSE-4262-S1R	552	42	62	1	52.08	1.51
L-PCSE-4268-S1R	593	42	68	1	57.12	1.65
L-PCSE-4274-S1R	634	42	74	1	62.16	1.80
L-PCSE-5026-S1R	346	50	26	1	26.00	0.75
L-PCSE-5032-S1R	396	50	32	1	32.00	0.93
L-PCSE-5038-S1R	439	50	38	1	38.00	1.10
L-PCSE-5044-S1R	486	50	44	1	44.00	1.27
L-PCSE-5050-S1R	536	50	50	1	50.00	1.45
L-PCSE-5056-S1R	582	50	56	1	56.00	1.62
L-PCSE-5062-S1R	630	50	62	1	62.00	1.79
L-PCSE-5068-S1R	678	50	68	1	68.00	1.97
L-PCSE-5074-S1R	723	50	74	1	74.00	2.14

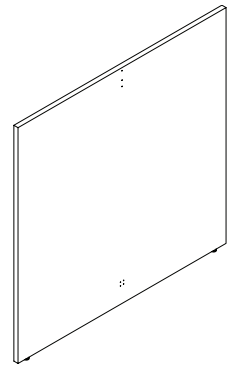

Single piece

Double Span End
Solid Gallery Panel
No Power Cutout

What's Included:

X"-X": One (1) 1"thick laminate gallery panel, two (2) gallery panel top brackets

X"-X": Two (2) 1"thick laminate gallery panel, four (4) gallery panel top brackets

How to Specify:

Refer to laminate cards for laminate selections

Choose option for power cut out or no power cut out

Notes:

Gallery panels come with pre-drilled holes on each side and bottom notch for wire routing

Gallery panels must be used between two standard fabric or laminate panels

Gallery panels must be the same height or lower than the connecting standard fabric or laminate panel

Options:

Height: 34", 42", 50"

Width: 26", 32", 38", 44", 50", 56", 62", 68", 74"

Laminate color

Power cut out, no power cut out

Code	Price	H	W	D	Weight (lb.)	Volume (ft ³)
single piece						
L-PYSE-3442-D1	364	34	42	1	28.56	0.83
L-PYSE-3450-D1	409	34	50	1	34.00	0.98
L-PYSE-3462-D1	476	34	62	1	42.16	1.22
L-PYSE-3474-D1	541	34	74	1	50.32	1.46
L-PYSE-3486-D1	607	34	86	1	58.48	1.69
L-PYSE-4242-D1	421	42	42	1	35.28	1.02
L-PYSE-4250-D1	473	42	50	1	42.00	1.22
L-PYSE-4262-D1	552	42	62	1	52.08	1.51
L-PYSE-4274-D1	634	42	74	1	62.16	1.80
L-PYSE-4286-D1	713	42	86	1	72.24	2.09
L-PYSE-5042-D1	473	50	42	1	42.00	1.22
L-PYSE-5050-D1	536	50	50	1	50.00	1.45
L-PYSE-5062-D1	630	50	62	1	62.00	1.79
L-PYSE-5074-D1	723	50	74	1	74.00	2.14
L-PYSE-5086-D1	820	50	86	1	86.00	2.49
2 pieces						
L-PYSE-3498-D2	838	34	98	1	66.64	1.93
L-PYSE-4298-D2	964	42	98	1	82.32	2.38
L-PYSE-5098-D2	1089	50	98	1	98.00	2.84
L-PYSE-34110-D2	907	34	110	1	74.80	2.16
L-PYSE-34122-D2	972	34	122	1	82.96	2.40
L-PYSE-34134-D2	1036	34	134	1	91.12	2.64
L-PYSE-34146-D2	1104	34	146	1	99.28	2.87
L-PYSE-42110-D2	1044	42	110	1	92.40	2.67
L-PYSE-42122-D2	1123	42	122	1	102.48	2.97
L-PYSE-42134-D2	1206	42	134	1	112.56	3.26
L-PYSE-42146-D2	1287	42	146	1	122.64	3.55
L-PYSE-50110-D2	1183	50	110	1	110.00	3.18
L-PYSE-50122-D2	1277	50	122	1	122.00	3.53
L-PYSE-50134-D2	1374	50	134	1	134.00	3.88
L-PYSE-50146-D2	1468	50	146	1	146.00	4.22

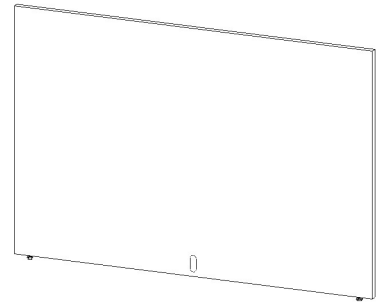

Single piece

Double Span End Solid Gallery Panel with Power Cutout

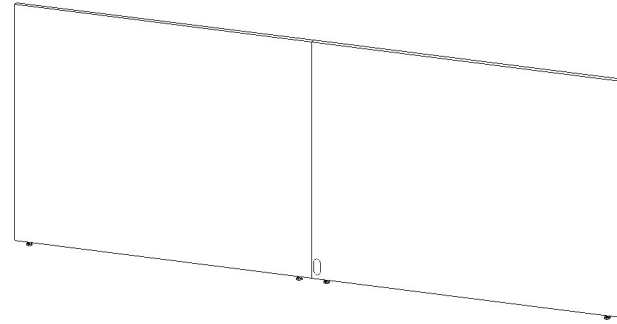

2 pieces

What's Included:

X"-X": One (1) 1"thick laminate gallery panel, two (2) gallery panel top brackets

X"-X": Two (2) 1"thick laminate gallery panel, four (4) gallery panel top brackets

How to Specify:

Refer to laminate cards for laminate selections

Choose option for power cut out or no power cut out

Notes:

Gallery panels come with pre-drilled holes on each side and bottom notch for wire routing

Gallery panels must be used between two standard fabric or laminate panels

Gallery panels must be the same height or lower than the connecting standard fabric or laminate panel

Options:

Height: 34", 42", 50"

Width: 26", 32", 38", 44", 50", 56", 62", 68", 74"

Laminate color

Power cut out, no power cut out

Code	Price	H	W	D	Weight (lb.)	Volume (ft ³)
single piece						
L-PCSE-3442-D1	364	34	42	1	28.60	0.80
L-PCSE-3450-D1	409	34	50	1	34.00	1.00
L-PCSE-3462-D1	476	34	62	1	42.20	1.20
L-PCSE-3474-D1	541	34	74	1	50.30	1.50
L-PCSE-3486-D1	607	34	86	1	58.50	1.70
L-PCSE-4242-D1	421	42	42	1	35.30	1.00
L-PCSE-4250-D1	473	42	50	1	42.00	1.20
L-PCSE-4262-D1	552	42	62	1	52.10	1.50
L-PCSE-4274-D1	634	42	74	1	62.20	1.80
L-PCSE-4286-D1	713	42	86	1	72.20	2.10
L-PCSE-5042-D1	473	50	42	1	42.00	1.20
L-PCSE-5050-D1	536	50	50	1	50.00	1.40
L-PCSE-5062-D1	630	50	62	1	62.00	1.80
L-PCSE-5074-D1	723	50	74	1	74.00	2.10
L-PCSE-5086-D1	820	50	86	1	86.00	2.50
2 pieces						
L-PCSE-3498-D2	838	34	98	1	66.60	1.90
L-PCSE-34110-D2	907	34	110	1	82.30	2.40
L-PCSE-34122-D2	972	34	122	1	98.00	2.80
L-PCSE-34134-D2	1036	34	134	1	74.80	2.20
L-PCSE-34146-D2	1104	34	146	1	83.00	2.40
L-PCSE-4298-D2	964	42	98	1	91.10	2.60
L-PCSE-42110-D2	1044	42	110	1	99.30	2.90
L-PCSE-42122-D2	1123	42	122	1	92.40	2.70
L-PCSE-42134-D2	1206	42	134	1	102.50	3.00
L-PCSE-42146-D2	1287	42	146	1	112.60	3.30
L-PCSE-5098-D2	1089	50	98	1	122.60	3.50
L-PCSE-50110-D2	1183	50	110	1	110.00	3.20
L-PCSE-50122-D2	1277	50	122	1	122.00	3.50
L-PCSE-50134-D2	1374	50	134	1	134.00	3.90
L-PCSE-50146-D2	1468	50	146	1	146.00	4.20

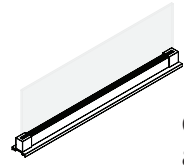

Glass Frameless Blade for Standard and Elevated Panels

Double span panel top mounted privacy screen can be placed across the width of two equal sized panels

What's Included:

One (1) tempered glass piece, One (1) channel extrusion, Two (2) end caps, One (1) top trim

How to Specify:

Refer to metal finish card for metal finish options

Notes:

One (1) glass piece can span the width of one or two panels up to 72"W

Glass is tempered

Options:

Height: 8", 16", 20"

Width: 24", 30", 36", 42", 48", 54", 60", 66", 72"

Clear, Frosted

Code	Price	H	W	D	Weight (lb.)	Volume (ft ³)
Glass screen - Clear						
L-VG-P-0824-C	538	8	24	0.75		
L-VG-P-0830-C	570	8	30	0.75		
L-VG-P-0836-C	623	8	36	0.75		
L-VG-P-0842-C	666	8	42	0.75		
L-VG-P-0848-C	673	8	48	0.75		
L-VG-P-0854-C	726	8	54	0.75		
L-VG-P-0860-C	737	8	60	0.75		
L-VG-P-0866-C	790	8	66	0.75		
L-VG-P-0872-C	798	8	72	0.75		
L-VG-P-1624-C	584	16	24	0.75		
L-VG-P-1630-C	621	16	30	0.75		
L-VG-P-1636-C	678	16	36	0.75		
L-VG-P-1642-C	725	16	42	0.75		
L-VG-P-1648-C	734	16	48	0.75		
L-VG-P-1654-C	790	16	54	0.75		
L-VG-P-1660-C	795	16	60	0.75		

Code	Price	H	W	D	Weight (lb.)	Volume (ft ³)
L-VG-P-1666-C	834	16	66	0.75		
L-VG-P-1672-C	867	16	72	0.75		
L-VG-P-2024-C	625	20	24	0.75		
L-VG-P-2030-C	669	20	30	0.75		
L-VG-P-2036-C	755	20	36	0.75		
L-VG-P-2042-C	804	20	42	0.75		
L-VG-P-2048-C	809	20	48	0.75		
L-VG-P-2054-C	867	20	54	0.75		
L-VG-P-2060-C	877	20	60	0.75		
L-VG-P-2066-C	923	20	66	0.75		
L-VG-P-2072-C	940	20	72	0.75		

Code	Price	H	W	D	Weight (lb.)	Volume (ft ³)
Glass screen - Frosted						
L-VG-P-0824-F	699	8	24	0.75		
L-VG-P-0830-F	739	8	30	0.75		
L-VG-P-0836-F	809	8	36	0.75		
L-VG-P-0842-F	867	8	42	0.75		
L-VG-P-0848-F	875	8	48	0.75		
L-VG-P-0854-F	944	8	54	0.75		
L-VG-P-0860-F	952	8	60	0.75		
L-VG-P-0866-F	1017	8	66	0.75		
L-VG-P-0872-F	1036	8	72	0.75		
L-VG-P-1624-F	761	16	24	0.75		
L-VG-P-1630-F	806	16	30	0.75		
L-VG-P-1636-F	881	16	36	0.75		
L-VG-P-1642-F	942	16	42	0.75		
L-VG-P-1648-F	952	16	48	0.75		
L-VG-P-1654-F	1028	16	54	0.75		
L-VG-P-1660-F	1033	16	60	0.75		
L-VG-P-1666-F	1105	16	66	0.75		
L-VG-P-1672-F	1127	16	72	0.75		
L-VG-P-2024-F	810	20	24	0.75		
L-VG-P-2030-F	871	20	30	0.75		
L-VG-P-2036-F	981	20	36	0.75		
L-VG-P-2042-F	1044	20	42	0.75		
L-VG-P-2048-F	1050	20	48	0.75		
L-VG-P-2054-F	1127	20	54	0.75		
L-VG-P-2060-F	1140	20	60	0.75		
L-VG-P-2066-F	1201	20	66	0.75		
L-VG-P-2072-F	1222	20	72	0.75		

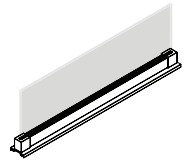

Acrylic Frameless Blade for Standard and Elevated Panels

What's Included:

One (1) acrylic piece, One (1) channel extrusion, Two (2) end caps, One (1) top trim

How to Specify:

Refer to metal finish card for metal finish options

Options:

Height: 8", 16"

Width: 24", 30", 36", 42", 48", 54", 60", 66", 72"

Clear, Frosted

Notes:

One (1) acrylic piece can span the width of one or two panels up to 72"W

Code	Price	H	W	D	Weight (lb.)	Volume (ft ³)
Acrylic screen - Frosted						
L-VA-P-0824-F	699	8	24	0.75		
L-VA-P-0830-F	739	8	30	0.75		
L-VA-P-0836-F	809	8	36	0.75		
L-VA-P-0842-F	867	8	42	0.75		
L-VA-P-0848-F	875	8	48	0.75		
L-VA-P-0854-F	944	8	54	0.75		
L-VA-P-0860-F	952	8	60	0.75		
L-VA-P-0866-F	1017	8	66	0.75		
L-VA-P-0872-F	1036	8	72	0.75		
L-VA-P-1624-F	761	16	24	0.75		
L-VA-P-1630-F	806	16	30	0.75		
L-VA-P-1636-F	881	16	36	0.75		
L-VA-P-1642-F	942	16	42	0.75		
L-VA-P-1648-F	952	16	48	0.75		
L-VA-P-1654-F	1028	16	54	0.75		
L-VA-P-1660-F	1033	16	60	0.75		
L-VA-P-1666-F	1105	16	66	0.75		
L-VA-P-1672-F	1127	16	72	0.75		

Code	Price	H	W	D	Weight (lb.)	Volume (ft ³)
Acrylic screen - Clear						
L-VA-P-0824-C	538	8	24	0.75		
L-VA-P-0830-C	570	8	30	0.75		
L-VA-P-0836-C	623	8	36	0.75		
L-VA-P-0842-C	666	8	42	0.75		
L-VA-P-0848-C	673	8	48	0.75		
L-VA-P-0854-C	726	8	54	0.75		
L-VA-P-0860-C	734	8	60	0.75		
L-VA-P-0866-C	790	16	66	0.75		
L-VA-P-0872-C	798	16	72	0.75		
L-VA-P-1624-C	584	16	24	0.75		
L-VA-P-1630-C	621	16	30	0.75		
L-VA-P-1636-C	678	16	36	0.75		
L-VA-P-1642-C	725	16	42	0.75		
L-VA-P-1648-C	734	16	48	0.75		
L-VA-P-1654-C	790	16	54	0.75		
L-VA-P-1660-C	795	16	60	0.75		
L-VA-P-1666-C	834	16	66	0.75		
L-VA-P-1672-C	867	16	72	0.75		

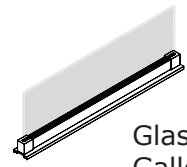

Glass Frameless Blade for Gallery Panels

What's Included:

One (1) tempered glass piece, One (1) accessory rail channel extrusion, Two (2) end caps

How to Specify:

Refer to metal finish card for metal finish options

Notes:

One (1) glass piece can span the width of one or two panels up to 72"W

Glass is tempered

Accessory rail channel extrusion can accommodate all Tayco accessories except for the paper sorter

Options:

Height: 8", 16"

Width: 24", 30", 36", 42", 48", 54", 60"

Clear, Frosted

Code	Price	H	W	D	Weight (lb.)	Volume (ft ³)
Glass screen - Frosted						
L-VG-Y-0824-F	794	8	24	0.75	5.00	0.08
L-VG-Y-0830-F	831	8	30	0.75	6.00	0.10
L-VG-Y-0836-F	900	8	36	0.75	7.00	0.13
L-VG-Y-0842-F	960	8	42	0.75	8.00	0.15
L-VG-Y-0848-F	966	8	48	0.75	10.00	0.17
L-VG-Y-0854-F	1033	8	54	0.75	11.00	0.19
L-VG-Y-0860-F	1040	8	60	0.75	12.00	0.21
L-VG-Y-1624-F	852	16	24	0.75	10.00	0.17
L-VG-Y-1630-F	897	16	30	0.75	12.00	0.21
L-VG-Y-1636-F	969	16	36	0.75	14.00	0.25
L-VG-Y-1642-F	1032	16	42	0.75	17.00	0.29
L-VG-Y-1648-F	1040	16	48	0.75	19.00	0.33
L-VG-Y-1654-F	1115	16	54	0.75	22.00	0.38
L-VG-Y-1660-F	1122	16	60	0.75	24.00	0.42

Code	Price	H	W	D	Weight (lb.)	Volume (ft ³)
Glass screen - Clear						
L-VG-Y-0824-C	687	8	30	0.75	6.00	0.10
L-VG-Y-0830-C	725	8	36	0.75	7.00	0.13
L-VG-Y-0836-C	794	8	42	0.75	8.00	0.15
L-VG-Y-0842-C	853	8	48	0.75	10.00	0.17
L-VG-Y-0848-C	860	8	54	0.75	11.00	0.19
L-VG-Y-0854-C	928	8	60	0.75	12.00	0.21
L-VG-Y-0860-C	933	16	24	0.75	10.00	0.17
L-VG-Y-1624-C	746	16	30	0.75	12.00	0.21
L-VG-Y-1630-C	790	16	36	0.75	14.00	0.25
L-VG-Y-1636-C	863	16	42	0.75	17.00	0.29
L-VG-Y-1642-C	927	16	48	0.75	19.00	0.33
L-VG-Y-1648-C	933	16	54	0.75	22.00	0.38
L-VG-Y-1654-C	1008	16	60	0.75	24.00	0.42
L-VG-Y-1660-C	1016	16	60	0.75	24.00	0.42

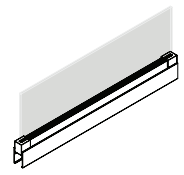

Acrylic Frameless Blade for Gallery Panels

What's Included:

One (1) acrylic piece, One (1) accessory rail channel extrusion, Two (2) end caps

How to Specify:

Refer to metal finish card for metal finish options

Notes:

One (1) acrylic piece can span the width of one or two panels up to 72"W

Accessory rail channel extrusion can accommodate all Tayco accessories except for the paper sorter

Options:

Height:	8", 16"
Width:	24", 30", 36", 42", 48", 54", 60"
Clear, Frosted	

Code	Price	H	W	D	Weight (lb.)	Volume (ft ³)
Acrylic screen - Frosted						
L-VA-Y-0824-F	794	8	24	0.75	4.00	0.08
L-VA-Y-0830-F	831	8	30	0.75	5.00	0.10
L-VA-Y-0836-F	900	8	36	0.75	5.00	0.13
L-VA-Y-0842-F	960	8	42	0.75	6.00	0.15
L-VA-Y-0848-F	966	8	48	0.75	7.00	0.17
L-VA-Y-0854-F	1033	8	54	0.75	8.00	0.19
L-VA-Y-0860-F	1040	8	60	0.75	9.00	0.21
L-VA-Y-1624-F	852	16	24	0.75	7.00	0.17
L-VA-Y-1630-F	897	16	30	0.75	9.00	0.21
L-VA-Y-1636-F	969	16	36	0.75	11.00	0.25
L-VA-Y-1642-F	1032	16	42	0.75	13.00	0.29
L-VA-Y-1648-F	1040	16	48	0.75	14.00	0.33
L-VA-Y-1654-F	1115	16	54	0.75	16.00	0.38
L-VA-Y-1660-F	1122	16	60	0.75	18.00	0.42

Code	Price	H	W	D	Weight (lb.)	Volume (ft ³)
Acrylic screen - Clear						
L-VA-Y-0824-C	687	8	24	0.75	4.00	0.08
L-VA-Y-0830-C	725	8	30	0.75	5.00	0.10
L-VA-Y-0836-C	794	8	36	0.75	5.00	0.13
L-VA-Y-0842-C	853	8	42	0.75	6.00	0.15
L-VA-Y-0848-C	860	8	48	0.75	7.00	0.17
L-VA-Y-0854-C	928	8	54	0.75	8.00	0.19
L-VA-Y-0860-C	933	8	60	0.75	9.00	0.21
L-VA-Y-1624-C	746	16	24	0.75	7.00	0.17
L-VA-Y-1630-C	790	16	30	0.75	9.00	0.21
L-VA-Y-1636-C	863	16	36	0.75	11.00	0.25
L-VA-Y-1642-C	927	16	42	0.75	13.00	0.29
L-VA-Y-1648-C	933	16	48	0.75	14.00	0.33
L-VA-Y-1654-C	1008	16	54	0.75	16.00	0.38
L-VA-Y-1660-C	1016	16	60	0.75	18.00	0.42

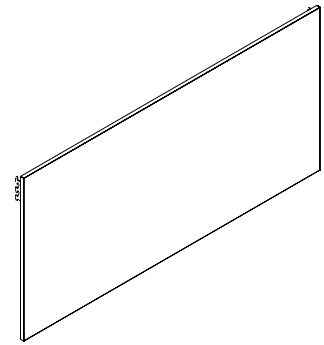

Panel Mounted Whiteboard

What's Included:

One (1) whiteboard, Two (2) slotted channel brackets

How to Specify:

Specify width of whiteboard to match the width of the panel
Choose White, Black, Silver, Charcoal for bracket color

Options:

Height: 15"

Width: 24", 30", 36", 42", 48", 54", 60"

Notes:

Panel Mounted Whiteboard is compatible with fabric and laminate panels only

Code	Price	H	W	D	Weight (lb.)	Volume (ft ³)
L-AWPO-1524	296	15	24	0.75	3.74	
L-AWPO-1530	331	15	30	0.75	4.86	
L-AWPO-1536	368	15	36	0.75	6.22	
L-AWPO-1542	402	15	42	0.75	7.48	
L-AWPO-1548	439	15	48	0.75	8.72	
L-AWPO-1554	477	15	54	0.75	9.96	
L-AWPO-1560	510	15	60	0.75	11.22	

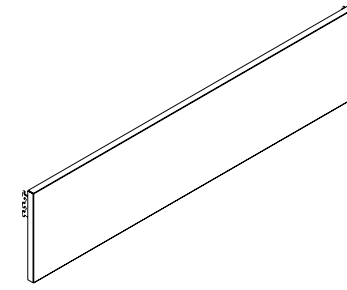

Panel Mounted Tackboard

What's Included:

One (1) tackboard, Two (2) slotted channel brackets

How to Specify:

Specify width of tackboard to match the width of the panel
Refer to panel fabric cards for fabric selections
Choose White, Black, Silver, Charcoal for bracket color

Options:

Height: 7", 15"

Width: 24", 30", 36", 42", 48", 54", 60"

Notes:

Panel Mounted Tackboard is compatible with fabric and laminate panels only

Code	Price	H	W	D	Weight (lb.)	Volume (ft ³)
L-ATPO-0724	187	7	24	0.75	1.87	
L-ATPO-0730	197	7	30	0.75	2.43	
L-ATPO-0736	208	7	36	0.75	3.11	
L-ATPO-0742	218	7	42	0.75	3.74	
L-ATPO-0748	225	7	48	0.75	4.36	
L-ATPO-0754	232	7	54	0.75	4.98	
L-ATPO-0760	240	7	60	0.75	5.61	
L-ATPO-1524	232	15	24	0.75	4.00	
L-ATPO-1530	253	15	30	0.75	4.86	
L-ATPO-1536	269	15	36	0.75	6.22	
L-ATPO-1542	286	15	42	0.75	7.48	
L-ATPO-1548	307	15	48	0.75	8.72	
L-ATPO-1554	324	15	54	0.75	9.96	
L-ATPO-1560	340	15	60	0.75	11.22	

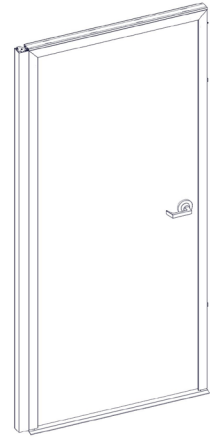

Hinged Door

What's Included:

Hinged Door laminate available in white and black

How to Specify:

Options:

Height: 82"

Width: 36", 42",

Left handed, Right handed

Straight connection, 90 degree connection, 3-way connection and 4-way connection

Notes:

Code	Price	H	W	D	Weight (lb.)	Volume (ft ³)
Straight connection						
L-PD00-8236-L	3670	82	36			
L-PD00-8236-R	3670	82	36			
L-PD00-8242-L	3740	82	42			
L-PD00-8242-R	3740	82	42			
3-way connection						
L-PD00-8236-L-3W	4382	82	36			
L-PD00-8236-R-3W	4382	82	36			
L-PD00-8242-L-3W	4452	82	42			
L-PD00-8242-R-3W	4452	82	42			
4-way connection						
L-PD00-8236-L-4W	4092	82	36			
L-PD00-8236-R-4W	4092	82	36			
L-PD00-8242-L-4W	4162	82	42			
L-PD00-8242-R-4W	4162	82	42			
90 degree connection						
L-PD00-8236-L-90	4171	82	36			
L-PD00-8236-R-90	4171	82	36			
L-PD00-8242-L-90	4241	82	42			
L-PD00-8242-R-90	4241	82	42			

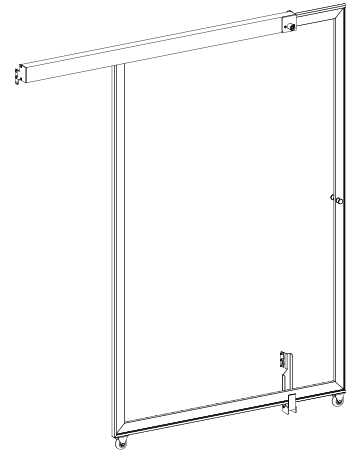

Sliding Door - Acrylic

What's Included:

Sliding door acrylic available in white and black

How to Specify:

Notes:

Options:

Height:	66"
Bracket Width:	30", 36", 42", 48", 54", 60"
Door Width:	30", 36", 42"
Left handed, Right handed	
Clear, Frosted, Fluted	

Code	Price	H	W	D	Weight (lb.)	Volume (ft ³)
Clear Acrylic - left hand						
L-PDSC-663030-L	2463	66	30			
L-PDSC-663036-L	2479	66	36			
L-PDSC-663042-L	2486	66	42			
L-PDSC-663048-L	2494	66	48			
L-PDSC-663054-L	2500	66	54			
L-PDSC-663060-L	2506	66	60			
L-PDSC-663636-L	2474	66	36			
L-PDSC-663642-L	2487	66	42			
L-PDSC-663648-L	2495	66	48			
L-PDSC-663654-L	2502	66	54			
L-PDSC-663660-L	2507	66	60			
L-PDSC-664242-L	2481	66	42			
L-PDSC-664248-L	2496	66	48			
L-PDSC-664254-L	2502	66	54			
L-PDSC-664260-L	2508	66	60			
Clear Acrylic - right hand						
L-PDSC-663030-R	2463	66	30			
L-PDSC-663036-R	2479	66	36			
L-PDSC-663042-R	2486	66	42			
L-PDSC-663048-R	2494	66	48			
L-PDSC-663054-R	2500	66	54			
L-PDSC-663060-R	2506	66	60			
L-PDSC-663636-R	2474	66	36			
L-PDSC-663642-R	2487	66	42			
L-PDSC-663648-R	2495	66	48			
L-PDSC-663654-R	2502	66	54			
L-PDSC-663660-R	2507	66	60			
L-PDSC-664242-R	2481	66	42			
L-PDSC-664248-R	2496	66	48			
L-PDSC-664254-R	2502	66	54			
L-PDSC-664260-R	2508	66	60			

Code	Price	H	W	D	Weight (lb.)	Volume (ft ³)
Frosted Acrylic - left hand						
L-PDSF-663030-L	2713	66	30			
L-PDSF-663036-L	2727	66	36			
L-PDSF-663042-L	2735	66	42			
L-PDSF-663048-L	2740	66	48			
L-PDSF-663054-L	2748	66	54			
L-PDSF-663060-L	2756	66	60			
L-PDSF-663636-L	2723	66	36			
L-PDSF-663642-L	2736	66	42			
L-PDSF-663648-L	2742	66	48			
L-PDSF-663654-L	2749	66	54			
L-PDSF-663660-L	2758	66	60			
L-PDSF-664242-L	2732	66	42			
L-PDSF-664248-L	2744	66	48			
L-PDSF-664254-L	2750	66	54			
L-PDSF-664260-L	2759	66	60			
Frosted Acrylic - right hand						
L-PDSF-663030-R	2713	66	30			
L-PDSF-663036-R	2727	66	36			
L-PDSF-663042-R	2735	66	42			
L-PDSF-663048-R	2740	66	48			
L-PDSF-663054-R	2748	66	54			
L-PDSF-663060-R	2756	66	60			
L-PDSF-663636-R	2723	66	36			
L-PDSF-663642-R	2736	66	42			
L-PDSF-663648-R	2742	66	48			
L-PDSF-663654-R	2749	66	54			
L-PDSF-663660-R	2758	66	60			
L-PDSF-664242-R	2732	66	42			
L-PDSF-664248-R	2744	66	48			
L-PDSF-664254-R	2750	66	54			
L-PDSF-664260-R	2759	66	60			

Code	Price	H	W	D	Weight (lb.)	Volume (ft ³)
Fluted acrylic - left hand						
L-PDSL-663030-L	2463	66	30			
L-PDSL-663036-L	2479	66	36			
L-PDSL-663042-L	2486	66	42			
L-PDSL-663048-L	2494	66	48			
L-PDSL-663054-L	2500	66	54			
L-PDSL-663060-L	2506	66	60			
L-PDSL-663636-L	2474	66	36			
L-PDSL-663642-L	2487	66	42			
L-PDSL-663648-L	2495	66	48			
L-PDSL-663654-L	2502	66	54			
L-PDSL-663660-L	2507	66	60			
L-PDSL-664242-L	2481	66	42			
L-PDSL-664248-L	2496	66	48			
L-PDSL-664254-L	2502	66	54			
L-PDSL-664260-L	2508	66	60			
Fluted acrylic - right hand						
L-PDSL-663030-R	2463	66	30			
L-PDSL-663036-R	2479	66	36			
L-PDSL-663042-R	2486	66	42			
L-PDSL-663048-R	2494	66	48			
L-PDSL-663054-R	2500	66	54			
L-PDSL-663060-R	2506	66	60			
L-PDSL-663636-R	2474	66	36			
L-PDSL-663642-R	2487	66	42			
L-PDSL-663648-R	2495	66	48			
L-PDSL-663654-R	2502	66	54			
L-PDSL-663660-R	2507	66	60			
L-PDSL-664242-R	2481	66	42			
L-PDSL-664248-R	2496	66	48			
L-PDSL-664254-R	2502	66	54			
L-PDSL-664260-R	2508	66	60			



Switch USA Pricebook
January 2026

Connections & Trims

Connections & Trims

2-Way Connection	118
3-Way T Connection	119
4-Way X Connection	120
Top Cap	121
Full Height End Trim	122
Partial Height End Trim	123
Full Height T Filler	124
Partial Height T Filler	125
90 Degree Filler-Full Height	126
90 Degree Filler- Partial Height	127
Straight Filler	128
Gallery Panel Filler	129
Adjustable Wall Connector	130

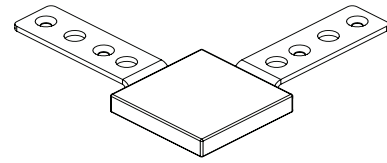

2-Way 90 degree Connection

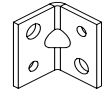

What's Included:

One (1) type A or type B straight or 90 degree connection bracket, accompanying screws

How to Specify:

Refer to page X for connection type application guide

Code	Price	H	W	D	Weight (lb.)	Volume (ft ³)
2-Way Straight Connection						
L-HC2W-180-A	24	1	2	3	0.02	0.00
L-HC2W-180-B	21	1	2	3	0.02	0.00
2-Way 90 degree Connection						
L-HC2W-90-A	56	1	2	3	0.02	0.00
L-HC2W-90-B	56	1	2	3	0.02	0.00

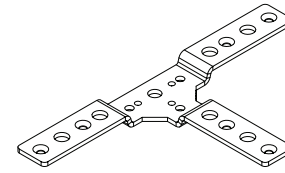

L-HC3W-A

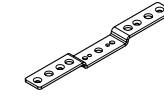

L-HC3W-B

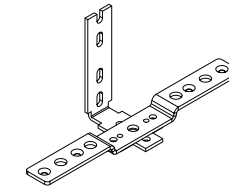

L-HC3W-C

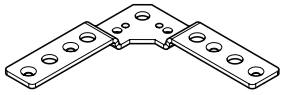

L-HC3W-D

What's Included:

One (1) type A or type B straight or 90 degree connection bracket, accompanying screws

How to Specify:

Refer to page X for connection type application guide

Notes:

Code	Price	H	W	D	Weight (lb.)	Volume (ft ³)
3 Way T Connectors						
L-HC3W-A	97	1	2	3	0.02	0.00
L-HC3W-B	126	1	2	3	0.02	0.00
L-HC3W-C	93	1	2	3	0.02	0.00
L-HC3W-D	119	1	2	3	0.02	0.00

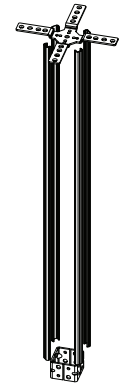

L-HC4W-A

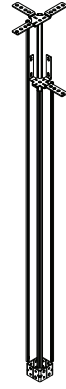

L-HC4W-B

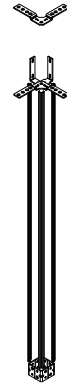

L-HC4W-C

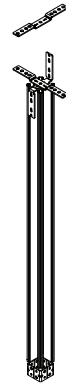

L-HC4W-D

What's Included:

One (1) type A, B, C or D 4-Way X connection bracket, accompanying screws

How to Specify:

Refer to page X for connection type application guide

Notes:

Code	Price	H	W	D	Weight (lb.)	Volume (ft ³)
4 way connectors						
L-HC4W-A	156	1	2	3	0.02	0.00
L-HC4W-B	197	1	2	3	0.02	0.00
L-HC4W-C	177	1	2	3	0.02	0.00
L-HC4W-D	183	1	2	3	0.02	0.00

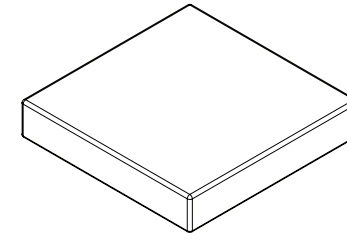

What's Included:

One (1) Top Cap

How to Specify:

Choose White, Black, Silver, Charcoal for Top Cap

Options:

Width: 2"

Depth: 2"

Notes:

Code	Price	H	W	D	Weight (lb.)	Volume (ft ³)
L-HUFC-02	10	1	2	2	0.02	0.00

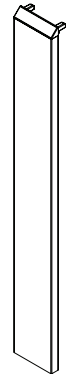

Standard

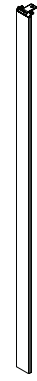

with coat hook

What's Included:

One (1) Full Height End Trim

How to Specify:

Choose White, Black, Silver, Charcoal for Full Height End Trim Colour

Options:

Height: 34", 42", 50", 66", 82"

Width: 2"

Standard, Coat Hook

Notes:

Code	Price	H	W	D	Weight (lb.)	Volume (ft ³)
standard						
L-HETF-34	62	34	2	1	0.68	0.04
L-HETF-42	73	42	2	1	0.84	0.05
L-HETF-50	85	50	2	1	1.00	0.06
L-HETF-66	102	66	2	1	1.32	0.08
L-HETF-82	204	82	2	2	1.32	0.19
with coat hook						
L-HETF-34-CH	81	34	2	1	0.68	0.04
L-HETF-42-CH	94	42	2	1	0.84	0.05
L-HETF-50-CH	111	50	2	1	1.00	0.06
L-HETF-66-CH	135	66	2	1	1.32	0.08

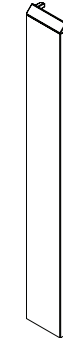

What's Included:

One (1) Partial Height End Trim

How to Specify:

Choose White, Black, Silver, Charcoal for Partial Height End Trim Colour

Options:

Height: 8", 16", 24", 32", 40", 48"

Width: 2"

Notes:

Code	Price	H	W	D	Weight (lb.)	Volume (ft ³)
L-HETP-08	50	8	2	1	0.16	0.01
L-HETP-16	56	16	2	1	0.32	0.02
L-HETP-24	73	24	2	1	0.48	0.03
L-HETP-32	87	32	2	1	0.64	0.04
L-HETP-40	154	40	2	1	0.72	0.05
L-HETP-48	168	48	2	1	0.84	0.06



Full Height T Filler

What's Included:

One (1) Full Height T Filler

How to Specify:

Choose White, Black, Silver, Charcoal for Full Height T Filler

Options:

Height: 34", 42", 50", 66", 82"
 Width: 2"

Notes:

Code	Price	H	W	D	Weight (lb.)	Volume (ft ³)
L-HFTR-34	223	34	2	1	0.68	0.04
L-HFTR-42	223	42	2	1	0.84	0.05
L-HFTR-50	231	50	2	1	1.00	0.06
L-HFTR-66	231	66	2	1	1.32	0.08
L-HFTR-82	385	82	2	1	1.64	0.09

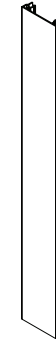

Partial Height T Filler

What's Included:

One (1) Partial Height T Filler

How to Specify:

Choose White, Black, Silver, Charcoal for Partial Height T Filler

Options:

Height: 8", 16", 24", 32", 40", 48"
 Width: 2"

Notes:

Code	Price	H	W	D	Weight (lb.)	Volume (ft ³)
L-HFTP-08	170	8	2	1	0.16	0.01
L-HFTP-16	170	16	2	1	0.32	0.02
L-HFTP-24	179	24	2	1	0.48	0.03
L-HFTP-32	179	32	2	1	0.64	0.04
L-HFTP-40	246	40	2	1	0.72	0.05



Full Height 90 Degree Filler

What's Included:

One (1) Full Height 90 Degree Filler

How to Specify:

Choose White, Black, Silver, Charcoal for Full Height 90 Degree Filler

Options:

Height: 34", 42", 50", 66", 82"
 Width: 2"

Notes:

Code	Price	H	W	D	Weight (lb.)	Volume (ft ³)
L-HFNR-34	182	34	2	1	0.68	0.04
L-HFNR-42	194	42	2	1	0.72	0.05
L-HFNR-50	206	50	2	1	1.00	0.06
L-HFNR-66	221	66	2	1	1.32	0.08
L-HFNR-82	385	82	2	1	1.64	0.09



Partial Height 90 Degree Filler

What's Included:

One (1) Partial Height 90 Degree Filler

How to Specify:

Choose White, Black, Silver, Charcoal for Partial Height 90 Degree Filler

Options:

Height: 8", 16", 24", 32", 40", 48"
 Width: 2"

Notes:

Code	Price	H	W	D	Weight (lb.)	Volume (ft ³)
L-HFNP-08	75	8	2	1	0.16	0.01
L-HFNP-16	131	16	2	1	0.32	0.02
L-HFNP-24	143	24	2	1	0.48	0.03
L-HFNP-32	195	32	2	1	0.64	0.04
L-HFNP-40	246	40	2	1	0.72	0.05
L-HFNP-48	267	48	2	1	0.84	0.05

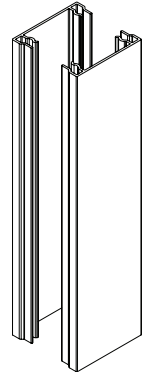

What's Included:

Partial Height Straight Filler

How to Specify:

Choose White, Black, Silver, Charcoal for Partial Height Straight Filler

Options:

Height: 8", 16", 24", 32", 40", 48"

Width: 2"

Notes:

Code	Price	H	W	D	Weight (lb.)	Volume (ft ³)
L-HFSP-08	56	8	2	1	0.16	0.01
L-HFSP-16	95	16	2	1	0.32	0.02
L-HFSP-24	104	24	2	1	0.48	0.03
L-HFSP-32	107	32	2	1	0.64	0.04
L-HFSP-40	246	40	2	1	0.80	0.05
L-HFSP-48	267	48	2	1	0.96	0.06

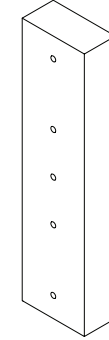

Partial Height Gallery Panel Filler

What's Included:

One (1)Partial Height Gallery Panel Filler

How to Specify:

Gallery Panel Filler matches laminate finish chosen on Gallery Panel

Options:

Height: 8", 16", 24", 32", 40", 48"

Width: 2"

Thickness: 1"

Notes:

Code	Price	H	W	D	Weight (lb.)	Volume (ft ³)
L-HYP-08	87	8	1	1	0.08	0.00
L-HYP-16	93	16	1	1	0.16	0.01
L-HYP-24	117	24	1	1	0.24	0.01
L-HYP-32	143	32	1	1	0.32	0.02
L-HYP-40	246	40	1	1	0.44	0.03
L-HYP-48	267	48	1	1	0.56	0.04



mount 2



mount 4



mount 6

Code	Price	H	W	D	Weight (lb.)	Volume (ft ³)
mount 2						
L-HW2-34	161	34	2	2	1.36	0.08
L-HW2-42	187	42	2	2	1.68	0.10
L-HW2-50	219	50	2	2	2.00	0.12
L-HW2-66	270	66	2	2	2.64	0.15
L-HW2-82	329	82	2	2	3.20	0.18
mount 4						
L-HW4-34	181	34	2	4	2.72	0.16
L-HW4-42	210	42	2	4	3.36	0.19
L-HW4-50	237	50	2	4	4.00	0.23
L-HW4-66	294	66	2	4	5.28	0.31
L-HW4-82	359	82	2	4	6.56	0.40
mount 6						
L-HW6-34	206	34	2	6	4.08	0.24
L-HW6-42	231	42	2	6	5.04	0.29
L-HW6-50	259	50	2	6	6.00	0.35
L-HW6-66	313	66	2	6	7.92	0.46
L-HW6-82	385	82	2	6	9.84	0.57



Switch USA Pricebook
January 2026

Worksurfaces

Worksurfaces

<u>Straight w grommet</u>	134
<u>Straight Worksurface w/o Grommet</u>	136
<u>Straight Worksurface w/ Wire Play</u>	140
<u>5-sided w Grommet</u>	144
<u>Straight Worksurface with Wire Play</u>	146
<u>Unitized w/ Grommet</u>	148
<u>Unitized w/ Wire Play</u>	150
<u>Transaction Top</u>	152

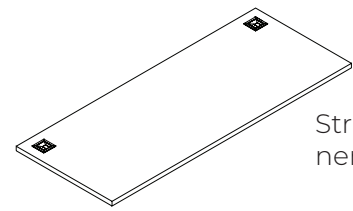

Straight Worksurface with Grommet5-Sided Corner

What's Included:

- One (1) worksurface
- 24"-48" - One (1) grommet cover for centre grommet
- 54"-96" - Two (2) grommet covers for grommet on each end

Notes:

- 24"-48" - One (1) grommet hole in the centre of the worksurface
- 54"-96" - Two (2) grommet holes on each end of the worksurface

How to Specify:

Refer to laminate card for laminate options

Options:

Width:	24", 30", 36", 42", 48", 54", 60", 66", 72", 78", 84", 90", 96"
Depth:	20", 24", 30"
Thickness:	1"

Code	Price	H	W	D	Weight (lb.)	Volume (ft ³)
L-WS0G-2420	296	24	20	1	9.60	0.28
L-WS0G-3020	340	30	20	1	12.00	0.35
L-WS0G-3620	351	36	20	1	14.40	0.42
L-WS0G-4220	397	42	20	1	16.80	0.49
L-WS0G-4820	423	48	20	1	19.20	0.56
L-WS0G-5420	536	54	20	1	21.60	0.62
L-WS0G-6020	557	60	20	1	24.00	0.69
L-WS0G-6620	623	66	20	1	26.40	0.76
L-WS0G-7220	653	72	20	1	28.80	0.83
L-WS0G-7820	709	78	20	1	31.20	0.90
L-WS0G-8420	755	84	20	1	33.60	0.97
L-WS0G-9020	868	90	20	1	36.00	1.04
L-WS0G-9620	907	96	20	1	38.40	1.11
L-WS0G-2424	296	24	24	1	11.52	0.33

Code	Price	H	W	D	Weight (lb.)	Volume (ft ³)
L-WS0G-3024	340	30	24	1	14.40	0.42
L-WS0G-3624	351	36	24	1	17.28	0.50
L-WS0G-4224	397	42	24	1	20.16	0.58
L-WS0G-4824	423	48	24	1	23.04	0.67
L-WS0G-5424	536	54	24	1	25.92	0.75
L-WS0G-6024	557	60	24	1	28.80	0.83
L-WS0G-6624	623	66	24	1	31.68	0.92
L-WS0G-7224	653	72	24	1	34.56	1.00
L-WS0G-7824	709	78	24	1	37.44	1.08
L-WS0G-8424	755	84	24	1	40.32	1.17
L-WS0G-9024	868	90	24	1	43.20	1.25
L-WS0G-9624	907	96	24	1	46.08	1.33
L-WS0G-2430	340	24	30	1	14.40	0.42
L-WS0G-3030	397	30	30	1	18.00	0.52
L-WS0G-3630	425	36	30	1	21.60	0.62
L-WS0G-4230	463	42	30	1	25.20	0.73
L-WS0G-4830	500	48	30	1	28.80	0.83
L-WS0G-5430	557	54	30	1	32.40	0.94
L-WS0G-6030	591	60	30	1	36.00	1.04
L-WS0G-6630	673	66	30	1	39.60	1.15
L-WS0G-7230	692	72	30	1	43.20	1.25
L-WS0G-7830	753	78	30	1	46.80	1.35
L-WS0G-8430	811	84	30	1	50.40	1.46
L-WS0G-9030	962	90	30	1	54.00	1.56
L-WS0G-9630	997	96	30	1	57.60	1.67

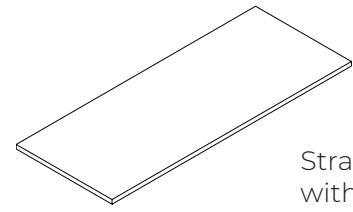

Straight Worksurface without Full Depth without Grommet

What's Included:

One (1) worksurface

How to Specify:

Refer to laminate card for laminate options

Notes:

Worksurface is full depth to sit flush against panel with no grommet

Options:

Width:	24", 30", 36", 42", 48", 54", 60", 66", 72", 78", 84", 90", 96"
Depth:	20", 24", 30"
Thickness:	1"

Code	Price	Height	Depth	Thickness	Weight (lb.)	Volume (ft ³)
Straight Worksurface without Full Depth without Grommet						
L-WS00-2320	253	23	20	1	9.20	0.27
L-WS00-2420	253	24	20	1	9.60	0.28
L-WS00-2920	307	29	20	1	11.60	0.34
L-WS00-3020	307	30	20	1	12.00	0.35
L-WS00-3520	325	35	20	1	14.00	0.41
L-WS00-3620	325	36	20	1	14.40	0.42
L-WS00-4120	359	41	20	1	16.40	0.47
L-WS00-4220	359	42	20	1	16.80	0.49
L-WS00-4720	397	47	20	1	18.80	0.54
L-WS00-4820	397	48	20	1	19.20	0.56
L-WS00-5320	484	53	20	1	21.20	0.61

Code	Price	Height	Depth	Thickness	Weight (lb.)	Volume (ft ³)
L-WS00-5420	484	54	20	1	21.60	0.62
L-WS00-5920	484	59	20	1	23.60	0.68
L-WS00-6020	484	60	20	1	24.00	0.69
L-WS00-6520	547	65	20	1	26.00	0.75
L-WS00-6620	547	66	20	1	26.40	0.76
L-WS00-7120	593	71	20	1	28.40	0.82
L-WS00-7220	593	72	20	1	28.80	0.83
L-WS00-7620	629	76	20	1	30.40	0.88
L-WS00-7720	629	77	20	1	30.80	0.89
L-WS00-7820	629	78	20	1	31.20	0.90
L-WS00-8220	683	82	20	1	32.80	0.95
L-WS00-8320	683	83	20	1	33.20	0.96
L-WS00-8420	683	84	20	1	33.60	0.97
L-WS00-8820	717	88	20	1	35.20	1.02
L-WS00-8920	717	89	20	1	35.60	1.03
L-WS00-9020	717	90	20	1	36.00	1.04
L-WS00-9420	790	94	20	1	37.60	1.09
L-WS00-9520	790	95	20	1	38.00	1.10
L-WS00-9620	790	96	20	1	38.40	1.11
L-WS00-2324	253	23	24	1	11.04	0.32
L-WS00-2424	253	24	24	1	11.52	0.33
L-WS00-2924	307	29	24	1	13.92	0.40
L-WS00-3024	307	30	24	1	14.40	0.42
L-WS00-3524	325	35	24	1	16.80	0.49
L-WS00-3624	325	36	24	1	17.28	0.50
L-WS00-4124	359	41	24	1	19.68	0.57

[2 of 4] continued on next page

Worksurface continued [3 of 4]

Code	Price	Height	Depth	Thickness	Weight (lb.)	Volume (ft ³)
L-WS00-4224	359	42	24	1	20.16	0.58
L-WS00-4724	397	47	24	1	22.56	0.65
L-WS00-4824	397	48	24	1	23.04	0.67
L-WS00-5324	484	53	24	1	25.44	0.74
L-WS00-5424	484	54	24	1	25.92	0.75
L-WS00-5924	484	59	24	1	28.32	0.82
L-WS00-6024	484	60	24	1	28.80	0.83
L-WS00-6524	547	65	24	1	31.20	0.90
L-WS00-6624	547	66	24	1	31.68	0.92
L-WS00-7124	593	71	24	1	34.08	0.99
L-WS00-7224	593	72	24	1	34.56	1.00
L-WS00-7624	629	76	24	1	36.48	1.06
L-WS00-7724	629	77	24	1	36.96	1.07
L-WS00-7824	629	78	24	1	37.44	1.08
L-WS00-8224	683	82	24	1	39.36	1.14
L-WS00-8324	683	83	24	1	39.84	1.15
L-WS00-8424	683	84	24	1	40.32	1.17
L-WS00-8824	717	88	24	1	42.24	1.22
L-WS00-8924	717	89	24	1	42.72	1.24
L-WS00-9024	717	90	24	1	43.20	1.25
L-WS00-9424	790	94	24	1	45.12	1.31
L-WS00-9524	790	95	24	1	45.60	1.32
L-WS00-9624	790	96	24	1	46.08	1.33
L-WS00-2330	307	23	30	1	13.80	0.40
L-WS00-2430	307	24	30	1	14.40	0.42
L-WS00-2930	359	29	30	1	17.40	0.50

Worksurface continued [4 of 4]

Code	Price	Height	Depth	Thickness	Weight (lb.)	Volume (ft ³)
L-WS00-3030	359	30	30	1	18.00	0.52
L-WS00-3530	401	35	30	1	21.00	0.61
L-WS00-3630	401	36	30	1	21.60	0.62
L-WS00-4130	437	41	30	1	24.60	0.71
L-WS00-4230	437	42	30	1	25.20	0.73
L-WS00-4730	473	47	30	1	28.20	0.82
L-WS00-4830	473	48	30	1	28.80	0.83
L-WS00-5330	536	53	30	1	31.80	0.92
L-WS00-5430	536	54	30	1	32.40	0.94
L-WS00-5930	565	59	30	1	35.40	1.02
L-WS00-6030	565	60	30	1	36.00	1.04
L-WS00-6530	650	65	30	1	39.00	1.13
L-WS00-6630	650	66	30	1	39.60	1.15
L-WS00-7130	665	71	30	1	42.60	1.23
L-WS00-7230	665	72	30	1	43.20	1.25
L-WS00-7630	726	76	30	1	45.60	1.32
L-WS00-7730	726	77	30	1	46.20	1.34
L-WS00-7830	726	78	30	1	46.80	1.35
L-WS00-8230	789	82	30	1	49.20	1.42
L-WS00-8330	789	83	30	1	49.80	1.44
L-WS00-8430	789	84	30	1	50.40	1.46
L-WS00-8830	900	88	30	1	52.80	1.53
L-WS00-8930	900	89	30	1	53.40	1.55
L-WS00-9030	900	90	30	1	54.00	1.56
L-WS00-9430	977	94	30	1	56.40	1.63
L-WS00-9530	977	95	30	1	57.00	1.65
L-WS00-9630	977	96	30	1	57.60	1.67

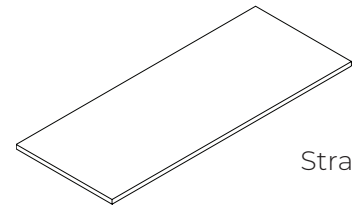

Straight Worksurface with 1" Wire Play

What's Included:

One (1) worksurface

How to Specify:

Refer to laminate card for laminate options

Notes:

Worksurface sits 1" from the panel to allow for wire routing. No grommet is included with this worksurface

Options:

Width: 23", 24", 29", 30", 35", 36", 41", 42", 47", 48", 53", 54", 59", 60", 65", 66", 71", 72", 77", 78", 83", 84", 89", 90", 95", 96"

Depth: 19", 20", 23", 24", 29", 30"

Thickness: 1"

Code	Price	Height	Depth	Thickness	Weight (lb.)	Volume (ft ³)
Straight Worksurface with 1" Wire Play						
L-WS00-2319	253	23	19	1	8.74	0.25
L-WS00-2419	253	24	19	1	9.12	0.26
L-WS00-2919	307	29	19	1	11.02	0.32
L-WS00-3019	307	30	19	1	11.40	0.33
L-WS00-3519	325	35	19	1	13.30	0.38
L-WS00-3619	325	36	19	1	13.68	0.40
L-WS00-4119	359	41	19	1	15.58	0.45
L-WS00-4219	359	42	19	1	15.96	0.46
L-WS00-4719	397	47	19	1	17.86	0.52
L-WS00-4819	397	48	19	1	18.24	0.53
L-WS00-5319	484	53	19	1	20.14	0.58
L-WS00-5419	484	54	19	1	20.52	0.59

Code	Price	Height	Depth	Thickness	Weight (lb.)	Volume (ft ³)
L-WS00-5919	484	59	19	1	22.42	0.65
L-WS00-6019	484	60	19	1	22.80	0.66
L-WS00-6519	547	65	19	1	24.70	0.71
L-WS00-6619	547	66	19	1	25.08	0.73
L-WS00-7119	593	71	19	1	26.98	0.78
L-WS00-7219	593	72	19	1	27.36	0.79
L-WS00-7619	629	76	19	1	28.88	0.84
L-WS00-7719	629	77	19	1	29.26	0.85
L-WS00-7819	629	78	19	1	29.64	0.86
L-WS00-8219	683	82	19	1	31.16	0.90
L-WS00-8319	683	83	19	1	31.54	0.91
L-WS00-8419	683	84	19	1	31.92	0.92
L-WS00-8819	717	88	19	1	33.44	0.97
L-WS00-8919	717	89	19	1	33.82	0.98
L-WS00-9019	717	90	19	1	34.20	0.99
L-WS00-9419	790	94	19	1	35.72	1.03
L-WS00-9519	790	95	19	1	36.10	1.04
L-WS00-9619	790	96	19	1	36.48	1.06
L-WS00-2323	253	23	23	1	10.58	0.31
L-WS00-2423	253	24	23	1	11.04	0.32
L-WS00-2923	307	29	23	1	13.34	0.39
L-WS00-3023	307	30	23	1	13.80	0.40
L-WS00-3523	325	35	23	1	16.10	0.47
L-WS00-3623	325	36	23	1	16.56	0.48
L-WS00-4123	359	41	23	1	18.86	0.55
L-WS00-4223	359	42	23	1	19.32	0.56
L-WS00-4723	397	47	23	1	21.62	0.63

[2 of 4] continued on next page

Worksurface continued [3 of 4]

Code	Price	Height	Depth	Thickness	Weight (lb.)	Volume (ft ³)
L-WS00-4823	397	48	23	1	22.08	0.64
L-WS00-5323	484	53	23	1	24.38	0.71
L-WS00-5423	484	54	23	1	24.84	0.72
L-WS00-5923	484	59	23	1	27.14	0.79
L-WS00-6023	484	60	23	1	27.60	0.80
L-WS00-6523	547	65	23	1	29.90	0.87
L-WS00-6623	547	66	23	1	30.36	0.88
L-WS00-7123	593	71	23	1	32.66	0.95
L-WS00-7223	593	72	23	1	33.12	0.96
L-WS00-7623	629	76	23	1	34.96	1.01
L-WS00-7723	629	77	23	1	35.42	1.02
L-WS00-7823	629	78	23	1	35.88	1.04
L-WS00-8223	683	82	23	1	37.72	1.09
L-WS00-8323	683	83	23	1	38.18	1.10
L-WS00-8423	683	84	23	1	38.64	1.12
L-WS00-8823	717	88	23	1	40.48	1.17
L-WS00-8923	717	89	23	1	40.94	1.18
L-WS00-9023	717	90	23	1	41.40	1.20
L-WS00-9423	790	94	23	1	43.24	1.25
L-WS00-9523	790	95	23	1	43.70	1.26
L-WS00-9623	790	96	23	1	44.16	1.28
L-WS00-2329	307	23	29	1	13.34	0.39
L-WS00-2429	307	24	29	1	13.92	0.40
L-WS00-2929	359	29	29	1	16.82	0.49
L-WS00-3029	359	30	29	1	17.40	0.50
L-WS00-3529	401	35	29	1	20.30	0.59
L-WS00-3629	401	36	29	1	20.88	0.60
L-WS00-4129	437	41	29	1	23.78	0.69

Worksurface continued [4 of 4]

Code	Price	Height	Depth	Thickness	Weight (lb.)	Volume (ft ³)
L-WS00-4229	437	42	29	1	24.36	0.70
L-WS00-4729	473	47	29	1	27.26	0.79
L-WS00-4829	473	48	29	1	27.84	0.81
L-WS00-5329	536	53	29	1	30.74	0.89
L-WS00-5429	536	54	29	1	31.32	0.91
L-WS00-5929	565	59	29	1	34.22	0.99
L-WS00-6029	565	60	29	1	34.80	1.01
L-WS00-6529	650	65	29	1	37.70	1.09
L-WS00-6629	650	66	29	1	38.28	1.11
L-WS00-7129	665	71	29	1	41.18	1.19
L-WS00-7229	665	72	29	1	41.76	1.21
L-WS00-7629	726	76	29	1	44.08	1.28
L-WS00-7729	726	77	29	1	44.66	1.29
L-WS00-7829	726	78	29	1	45.24	1.31
L-WS00-8229	789	82	29	1	47.56	1.38
L-WS00-8329	789	83	29	1	48.14	1.39
L-WS00-8429	789	84	29	1	48.72	1.41
L-WS00-8829	900	88	29	1	51.04	1.48
L-WS00-8929	900	89	29	1	51.62	1.49
L-WS00-9029	900	90	29	1	52.20	1.51
L-WS00-9429	977	94	29	1	54.52	1.58
L-WS00-9529	977	95	29	1	55.10	1.59
L-WS00-9629	977	96	29	1	55.68	1.61

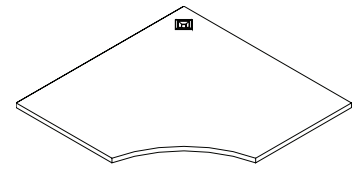

Curved 5-Sided Workspace with Grommet

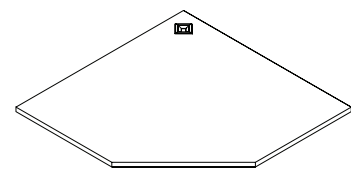

Straight 5-Sided Workspace with Grommet

What's Included:

One (1) workspace, One (1) grommet

How to Specify:

Refer to laminate card for laminate options

Notes:

Workspace sits 1" from the panel to allow for wire routing. No grommet is included with this workspace

Surface has a curved front

Options:

Side A*:	36", 42", 48"
Side B:	24", 30"
Thickness:	1"
Straight, Curved Front	
Grommet Type & Color: Square (Silver, Black, White), Oval (Silver, Black)	

*36" on side A only available in 24" on side B

Code	Price	Height	Depth	Thickness	Weight (lb.)	Volume (ft ³)
curved front with grommet						
L-W5CG-3624	520	36	24	1	30.00	0.50
L-W5CG-4224	628	42	24	1	33.00	0.58
L-W5CG-4824	753	48	24	1	36.00	0.67
L-W5CG-4230	628	42	30	1	35.00	0.73
L-W5CG-4830	753	48	30	1	38.00	0.83
straight front with grommet						
L-W5SG-3624	520	36	24	1	30.00	0.50
L-W5SG-4224	628	42	24	1	33.00	0.58
L-W5SG-4824	753	48	24	1	36.00	0.67
L-W5SG-4230	628	42	30	1	35.00	0.73
L-W5SG-4830	753	48	30	1	38.00	0.83

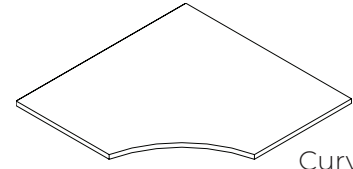

Curved 5-Sided Workspace with 1" Wire Play

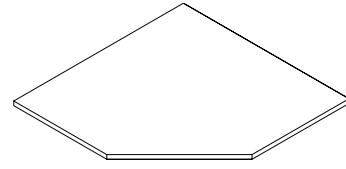

Straight 5-Sided Workspace with 1" Wire Play

What's Included:

One (1) workspace

How to Specify:

Refer to laminate card for laminate options

Options:

Side A & C*: 35", 36", 41", 42", 47", 48"

Side B & D: 23", 24", 29", 30"

Thickness: 1"

Straight, Curved Front

*35" & 36" on side A & C only available in 23" & 24" on side B & D

Notes:

Workspace sits 1" from the panel to allow for wire routing. No grommet is included with this workspace

Code	Price	Height	Depth	Thickness	Weight (lb.)	Volume (ft ³)
Left hand curved front						
L-W5C0-3624-L	520	36	24	1	30.00	0.50
L-W5C0-4224-L	628	42	24	1	33.00	0.58
L-W5C0-4824-L	753	48	24	1	36.00	0.67
L-W5C0-4230-L	628	42	30	1	35.00	0.73
L-W5C0-4830-L	753	48	30	1	38.00	0.83
Right hand curved front						
L-W5C0-3624-R	520	36	24	1	30.00	0.50
L-W5C0-4224-R	628	42	24	1	33.00	0.58
L-W5C0-4824-R	753	48	24	1	36.00	0.67
L-W5C0-4230-R	628	42	30	1	35.00	0.73
L-W5C0-4830-R	753	48	30	1	38.00	0.83
Double curved front						
L-W5C0-3523-D	520	35	23	1	30.00	0.47
L-W5C0-4123-D	628	41	23	1	33.00	0.55
L-W5C0-4723-D	753	47	23	1	36.00	0.63
L-W5C0-4129-D	628	41	29	1	35.00	0.69
L-W5C0-4729-D	753	47	29	1	38.00	0.79

Code	Price	Height	Depth	Thickness	Weight (lb.)	Volume (ft ³)
Left hand straight front						
L-W5S0-3624-L	520	36	24	1	30.00	0.50
L-W5S0-4224-L	628	42	24	1	33.00	0.58
L-W5S0-4824-L	753	48	24	1	36.00	0.67
L-W5S0-4230-L	628	42	30	1	35.00	0.73
L-W5S0-4830-L	753	48	30	1	38.00	0.83
Right hand straight front						
L-W5S0-3624-R	520	36	24	1	30.00	0.50
L-W5S0-4224-R	628	42	24	1	33.00	0.58
L-W5S0-4824-R	753	48	24	1	36.00	0.67
L-W5S0-4230-R	628	42	30	1	35.00	0.73
L-W5S0-4830-R	753	48	30	1	38.00	0.83
Double straight front						
L-W5S0-3523-D	520	35	23	1	30.00	0.47
L-W5S0-4123-D	628	41	23	1	33.00	0.55
L-W5S0-4723-D	753	47	23	1	36.00	0.63
L-W5S0-4129-D	628	41	29	1	35.00	0.69
L-W5S0-4729-D	753	47	29	1	38.00	0.79

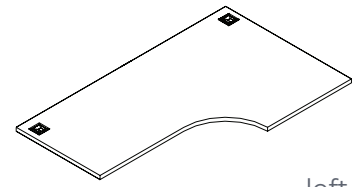

left hand shown with grommet

What's Included:

One (1) workspace, Two(2) grommets

How to Specify:

Refer to laminate card for laminate options

Notes:

Surface has a curved front

Options:

Side A:	36"
Side B:	24"
Side C:	54", 60", 66", 72", 78", 84", 90", 96"
Thickness:	1"
Left Hand, Right Hand	
Grommet Type & Color: Square (Silver, Black, White), Oval (Silver, Black)	

Code	Price	Height	Depth	Thickness	Weight (lb.)	Volume (ft ³)
Left hand with grommet						
L-WUCG-543624-L	749	54	36	1	24.88	1.12
L-WUCG-603624-L	790	60	36	1	26.88	1.25
L-WUCG-663624-L	876	66	36	1	28.88	1.38
L-WUCG-723624-L	931	72	36	1	30.88	1.50
L-WUCG-783624-L	1006	78	36	1	32.88	1.62
L-WUCG-843624-L	1074	84	36	1	34.88	1.75
L-WUCG-903624-L	1237	90	36	1	36.88	1.88
L-WUCG-963624-L	1295	96	36	1	38.88	2.00
Right hand with grommet						
L-WUCG-543624-R	749	54	36	1	24.88	1.12
L-WUCG-603624-R	790	60	36	1	26.88	1.25
L-WUCG-663624-R	876	66	36	1	28.88	1.38
L-WUCG-723624-R	931	72	36	1	30.88	1.50
L-WUCG-783624-R	1006	78	36	1	32.88	1.62
L-WUCG-843624-R	1074	84	36	1	34.88	1.75
L-WUCG-903624-R	1237	90	36	1	36.88	1.88
L-WUCG-963624-R	1295	96	36	1	38.88	2.00

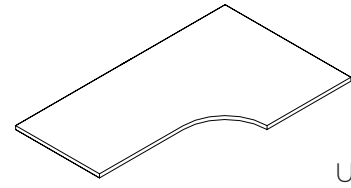

Unitized Workspace with 1" Wire Play

What's Included:

One (1) workspace

How to Specify:

Refer to laminate card for laminate options

Notes:

Workspace sits 1" from the panel to allow for wire routing. No grommet is included with this workspace

Surface has a curved front

Options:

Side A:	53", 54", 59", 60", 65", 66", 71", 72", 77", 78", 83", 84", 89", 90", 95", 96"
Side B:	23", 24"
Side C:	35", 36"
Side D:	23", 24"

Code	Price	Height	Depth	Thickness	Weight (lb)	Volume (ft ³)
Left hand						
L-WUC0-543524-L	749	54	35	1	24.88	1.09
L-WUC0-603524-L	790	60	35	1	26.88	1.22
L-WUC0-663524-L	876	66	35	1	28.88	1.34
L-WUC0-723524-L	931	72	35	1	30.88	1.46
L-WUC0-783524-L	1006	78	35	1	32.88	1.58
L-WUC0-843524-L	1074	84	35	1	34.88	1.70
L-WUC0-903524-L	1237	90	35	1	36.88	1.82
L-WUC0-963524-L	1295	96	35	1	38.88	1.94
L-WUC0-533624-L	749	53	36	1	24.88	1.10
L-WUC0-593624-L	790	59	36	1	26.88	1.23
L-WUC0-653624-L	876	65	36	1	28.88	1.35
L-WUC0-713624-L	931	71	36	1	30.88	1.48
L-WUC0-773624-L	1006	77	36	1	32.88	1.60
L-WUC0-833624-L	1074	83	36	1	34.88	1.73
L-WUC0-893624-L	1237	89	36	1	36.88	1.85

Code	Price	Height	Depth	Thickness	Weight (lb)	Volume (ft ³)
L-WUC0-953624-L	1295	95	36	1	38.88	1.98
L-WUC0-533523-L	749	53	35	1	24.88	1.07
L-WUC0-593523-L	790	59	35	1	26.88	1.20
L-WUC0-653523-L	876	65	35	1	28.88	1.32
L-WUC0-713523-L	931	71	35	1	30.88	1.44
L-WUC0-773523-L	1006	77	35	1	32.88	1.56
L-WUC0-833523-L	1074	83	35	1	34.88	1.68
L-WUC0-893523-L	1237	89	35	1	36.88	1.80
L-WUC0-953523-L	1295	95	35	1	38.88	1.92
Right hand						
L-WUC0-543524-R	749	54	35	1	24.88	1.09
L-WUC0-603524-R	790	60	35	1	26.88	1.22
L-WUC0-663524-R	876	66	35	1	28.88	1.34
L-WUC0-723524-R	931	72	35	1	30.88	1.46
L-WUC0-783524-R	1006	78	35	1	32.88	1.58
L-WUC0-843524-R	1074	84	35	1	34.88	1.70
L-WUC0-903524-R	1237	90	35	1	36.88	1.82
L-WUC0-963524-R	1295	96	35	1	38.88	1.94
L-WUC0-533624-R	749	53	36	1	24.88	1.10
L-WUC0-593624-R	790	59	36	1	26.88	1.23
L-WUC0-653624-R	876	65	36	1	28.88	1.35
L-WUC0-713624-R	931	71	36	1	30.88	1.48
L-WUC0-773624-R	1006	77	36	1	32.88	1.60
L-WUC0-833624-R	1074	83	36	1	34.88	1.73
L-WUC0-893624-R	1237	89	36	1	36.88	1.85
L-WUC0-953624-R	1295	95	36	1	38.88	1.98
L-WUC0-533523-R	749	53	35	1	24.88	1.07
L-WUC0-593523-R	790	59	35	1	26.88	1.20
L-WUC0-653523-R	876	65	35	1	28.88	1.32
L-WUC0-713523-R	931	71	35	1	30.88	1.44
L-WUC0-773523-R	1006	77	35	1	32.88	1.56
L-WUC0-833523-R	1074	83	35	1	34.88	1.68
L-WUC0-893523-R	1237	89	35	1	36.88	1.80
L-WUC0-953523-R	1295	95	35	1	38.88	1.92

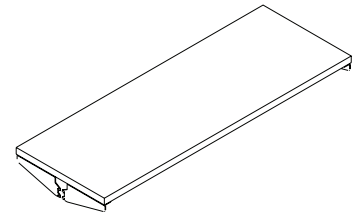

What's Included:

One (1) transaction top, Four (4) cantilever brackets

How to Specify:

Match the transaction top to the corresponding panel width

Refer to laminate card for laminate options

Choose White, Black, Silver, Charcoal for cantilever color

Notes:

Options:

Width: 24", 30", 36", 42", 48", 54", 60"

Depth: 15"

Thickness: 1"

Cantilever Paint Color: Silver, White, Black, Charcoal

Code	Price	H	W	D	Weight (lb.)	Volume (ft ³)
L-WTT-2415	308	24	15	1	5.76	0.21
L-WTT-3015	329	30	15	1	7.20	0.26
L-WTT-3615	343	36	15	1	8.64	0.31
L-WTT-4215	362	42	15	1	10.08	0.36
L-WTT-4815	375	48	15	1	11.52	0.42
L-WTT-5415	399	54	15	1	12.96	0.47
L-WTT-6015	411	60	15	1	14.40	0.52



Switch USA Pricebook
January 2026

Supports

Supports

Ladder Gable	156
Standard Panel	156
Gallery Panel	158
Freestanding Panel	160
Laminate Gable	161
Standard Panel	161
Gallery Panel	162
Freestanding	163
Wrap Gable	164
Standard Panel	164
Gallery Panel	165
Tech Drop	166
Cantilever	167
Standard Panel	167
Gallery Panel	168
Standard Panel Mount Corner Bracket	170
Flush Plates	171
Storage Support Bracket	172
Fixed Credenza Support Bracket	173
90 Degree Storage Bracket	174
Horizontal Surface Support	175

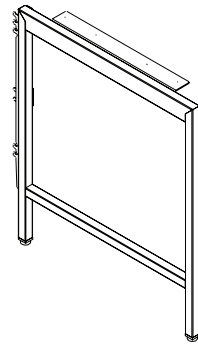

Standard Panel Ladder Gable

What's Included:

One (1) ladder gable, one (1) standard panel mount bracket, (1) surface to gable connector

How to Specify:

Choose White, Black, Silver, Charcoal for ladder gable colour

Notes:

Ladder Gable can be used with worksurface with grommet, worksurface without grommet, worksurface for 1" wire play

Mid gable is used at the surface joint

Options:

Heights*: 25", 28"

Depth: 20", 24", 30"

Ladder Gable Paint Colour:: Silver, White, Black, Charcoal

End gable: (Left hand, right hand) or mid gable

*25" high to be used to Tech Drop surface

Code	Price	H	W	D	Weight (lb.)	Volume (ft ³)
Left hand						
L-HOEG-P-2520-L	398	25	20	2	10.00	0.58
L-HOEG-P-2524-L	401	25	24	2	12.00	0.69
L-HOEG-P-2530-L	441	25	30	2	15.00	0.87
L-HOEG-P-2820-L	402	28	20	2	11.20	0.65
L-HOEG-P-2824-L	411	28	24	2	13.44	0.78
L-HOEG-P-2830-L	427	28	30	2	16.80	0.97
Right hand						
L-HOEG-P-2520-R	398	25	20	2	10.00	0.58
L-HOEG-P-2524-R	401	25	24	2	12.00	0.69
L-HOEG-P-2530-R	441	25	30	2	15.00	0.87
L-HOEG-P-2820-R	402	28	20	2	11.20	0.65
L-HOEG-P-2824-R	411	28	24	2	13.44	0.78
Mid						
L-HOMG-P-2520	398	25	20	2	10.00	0.58
L-HOMG-P-2524	401	25	24	2	12.00	0.69
L-HOMG-P-2530	441	25	30	2	15.00	0.87
L-HOMG-P-2820	402	28	20	2	11.20	0.65
L-HOMG-P-2824	411	28	24	2	13.44	0.78
L-HOMG-P-2830	427	28	30	2	16.80	0.97

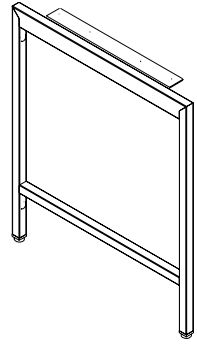

Gallery Panel Ladder Gable

What's Included:

One (1) ladder gable, one (1) gallery panel mount bracket, (1) surface to gable connector

How to Specify:

Choose White, Black, Silver, Charcoal for ladder gable colour

Notes:

Ladder Gable can be used with worksurface with grommet, worksurface without grommet, worksurface for 1" wire play

Mid gable is used at the surface joint

Options:

Heights*: 25", 28"

Depth: 20", 24", 30"

Ladder Gable Paint Colour:: Silver, White, Black, Charcoal

End gable: (Left hand, right hand) or mid gable

*25" high to be used to Tech Drop surface

Code	Price	H	W	D	Weight (lb.)	Volume (ft ³)
Left hand						
L-HOEG-Y-2520-L	398	25	20	2	10.00	0.58
L-HOEG-Y-2524-L	401	25	24	2	12.00	0.69
L-HOEG-Y-2530-L	441	25	30	2	15.00	0.87
L-HOEG-Y-2820-L	402	28	20	2	11.20	0.65
L-HOEG-Y-2824-L	411	28	24	2	13.44	0.78
L-HOEG-Y-2830-L	427	28	30	2	16.80	0.97
Right hand						
L-HOEG-Y-2520-R	398	25	20	2	10.00	0.58
L-HOEG-Y-2524-R	401	25	24	2	12.00	0.69
L-HOEG-Y-2530-R	441	25	30	2	15.00	0.87
L-HOEG-Y-2820-R	402	28	20	2	11.20	0.65
L-HOEG-Y-2824-R	411	28	24	2	13.44	0.78
L-HOEG-Y-2830-R	427	28	30	2	16.80	0.97
Mid						
L-HOMG-Y-2520	398	25	20	2	10.00	0.58
L-HOMG-Y-2524	401	25	24	2	12.00	0.69
L-HOMG-Y-2530	441	25	30	2	15.00	0.87
L-HOMG-Y-2820	402	28	20	2	11.20	0.65
L-HOMG-Y-2824	411	28	24	2	13.44	0.78
L-HOMG-Y-2830	427	28	30	2	16.80	0.97

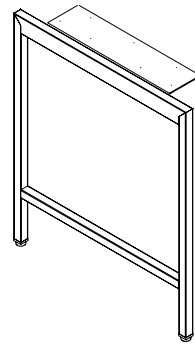

Freestanding

What's Included:

One (1) 90 degree bracket

How to Specify:

Available in black only

Notes:

90 degree bracket is used to connect a worksurface to a gallery panel

Options:

Heights*: 25", 28"

Depth: 20", 24", 30"

Ladder Gable Paint Colour:: Silver, White, Black, Charcoal

End gable: (Left hand, right hand)

*25" high to be used to Tech Drop surface

Code	Price	H	W	D	Weight (lb.)	Volume (ft ³)
Freestanding						
L-HOEG-S-2520	398	25	20	2	10.00	0.58
L-HOEG-S-2524	401	25	24	2	12.00	0.69
L-HOEG-S-2530	441	25	30	2	15.00	0.87
L-HOEG-S-2820	402	28	20	2	11.20	0.65
L-HOEG-S-2824	411	28	24	2	13.44	0.78
L-HOEG-S-2830	427	28	30	2	16.80	0.97

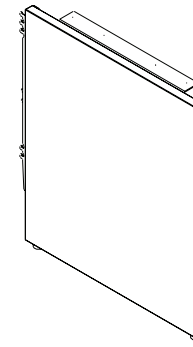

Standard Panel
Laminate Gable

What's Included:

One (1) ladder gable, one (1) standard panel mount bracket, (1) surface to gable connector

How to Specify:

Laminate Gable Paint Colour: Silver, White, Black, Charcoal

Laminate Gable Laminate Colour: Refer to laminate card for laminate options

End gable (Left hand, right hand)

Options:

Heights*: 25", 28"

Depth: 20", 24", 30"

*25" high to be used to Tech Drop surface

Notes:

Ladder Gable can be used with worksurface with grommet, worksurface without grommet, worksurface for 1" wire play

Code	Price	H	W	D	Weight (lb.)	Volume (ft ³)
Left hand						
L-HCEG-P-2520-L	259	25	20	2	10.00	0.58
L-HCEG-P-2524-L	281	25	24	2	12.00	0.69
L-HCEG-P-2530-L	307	25	30	2	15.00	0.87
L-HCEG-P-2812-L	240	28	12	2	10.00	0.39
L-HCEG-P-2820-L	271	28	20	2	11.20	0.65
L-HCEG-P-2824-L	294	28	24	2	13.44	0.78
L-HCEG-P-2830-L	322	28	30	2	16.80	0.97
Right hand						
L-HCEG-P-2520-R	259	25	20	2	10.00	0.58
L-HCEG-P-2524-R	281	25	24	2	12.00	0.69
L-HCEG-P-2530-R	307	25	30	2	15.00	0.87
L-HCEG-P-2812-R	240	28	12	2	10.00	0.39
L-HCEG-P-2820-R	271	28	20	2	11.20	0.65
L-HCEG-P-2824-R	294	28	24	2	13.44	0.78
L-HCEG-P-2830-R	322	28	30	2	16.80	0.97

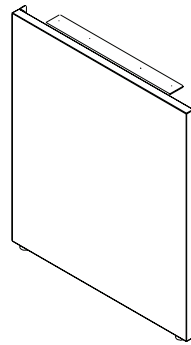

Gallery Panel
Laminate Gable

What's Included:

One (1) ladder gable, one (1) gallery panel mount bracket, (1) surface to gable connector

How to Specify:

Laminate Gable Paint Colour: Silver, White, Black, Charcoal

Laminate Gable Laminate Colour: Refer to laminate card for laminate options

End gable (Left hand, right hand)

Options:

Heights*: 25", 28"

Depth: 20", 24", 30"

*25" high to be used to Tech Drop surface

Notes:

Ladder Gable can be used with worksurface with grommet, worksurface without grommet, worksurface for 1" wire play

Code	Price	H	W	D	Weight (lb.)	Volume (ft ³)
Left hand						
L-HCEG-Y-2520-L	255	25	20	2	10.00	0.58
L-HCEG-Y-2524-L	270	25	24	2	12.00	0.69
L-HCEG-Y-2530-L	298	25	30	2	15.00	0.87
L-HCEG-Y-2812-L	231	28	12	2	11.20	0.39
L-HCEG-Y-2820-L	265	28	20	2	11.20	0.65
L-HCEG-Y-2824-L	283	28	24	2	13.44	0.78
L-HCEG-Y-2830-L	312	28	30	2	16.80	0.97
Right hand						
L-HCEG-Y-2520-R	255	25	20	2	10.00	0.58
L-HCEG-Y-2524-R	270	25	24	2	12.00	0.69
L-HCEG-Y-2530-R	298	25	30	2	15.00	0.87
L-HCEG-Y-2812-R	231	28	12	2	11.20	0.39
L-HCEG-Y-2820-R	265	28	20	2	11.20	0.65
L-HCEG-Y-2824-R	283	28	24	2	13.44	0.78
L-HCEG-Y-2830-R	312	28	30	2	16.80	0.97

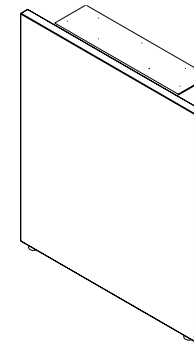

Freestanding Laminate Gable

What's Included:

One (1) ladder gable, (1) surface to gable connector

How to Specify:

Laminate Gable Paint Colour: Silver, White, Black, Charcoal

Laminate Gable Laminate Colour: Refer to laminate card for laminate options

Notes:

Laminate Gable can be used with worksurface with grommet, worksurface without grommet, worksurface for 1" wire play

Freestanding gable is used when one side of the surface is connected to a panel and the other is open

Options:

Heights*: 25", 28"

Depth: 20", 24", 30"

*25" is used with the 20" deep surface

Code	Price	H	W	D	Weight (lb.)	Volume (ft ³)
L-HCEG-S-2520	271	25	20	2	10.00	0.58
L-HCEG-S-2524	288	25	24	2	12.00	0.69
L-HCEG-S-2530	317	25	30	2	15.00	0.87
L-HCEG-S-2820	283	28	20	2	11.20	0.65
L-HCEG-S-2824	307	28	24	2	13.44	0.78
L-HCEG-S-2830	335	28	30	2	16.80	0.97

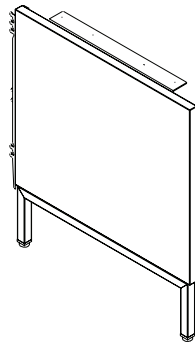

Standard Panel
Wrap Laminate Gable

What's Included:

One (1) wrap gable, one (1) standard panel mount bracket, (1) surface to gable connector

How to Specify:

Laminate Gable Paint Colour: Silver, White, Black, Charcoal

Laminate Gable Laminate Colour: Refer to laminate card for laminate options

End gable (Left hand, right hand)

Options:

Heights*: 25", 28"

Depth: 20", 24", 30"

*25" high to be used to Tech Drop surface

Notes:

Laminate Gable can be used with worksurface with grommet, worksurface without grommet, worksurface for 1" wire play

Freestanding gable is used when one side of the surface is connected to a panel and the other is open

Code	Price	H	W	D	Weight (lb.)	Volume (ft ³)
Left hand						
L-HWEG-P-2520-L	446	25	20	2	10.00	0.58
L-HWEG-P-2524-L	459	25	24	2	12.00	0.69
L-HWEG-P-2530-L	507	25	30	2	15.00	0.87
L-HWEG-P-2820-L	457	28	20	2	11.20	0.65
L-HWEG-P-2824-L	473	28	24	2	13.44	0.78
L-HWEG-P-2830-L	524	28	30	2	16.80	0.97
Right hand						
L-HWEG-P-2520-R	446	25	20	2	10.00	0.58
L-HWEG-P-2524-R	459	25	24	2	12.00	0.69
L-HWEG-P-2530-R	507	25	30	2	15.00	0.87
L-HWEG-P-2820-R	457	28	20	2	11.20	0.65
L-HWEG-P-2824-R	473	28	24	2	13.44	0.78
L-HWEG-P-2830-R	524	28	30	2	16.80	0.97

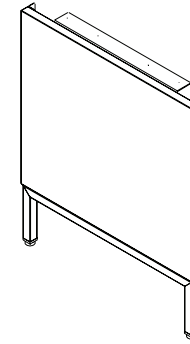

Gallery Panel
Wrap Laminate Gable

What's Included:

One (1) wrap gable, one (1) gallery panel mount bracket, (1) surface to gable connector

How to Specify:

Laminate Gable Paint Colour: Silver, White, Black, Charcoal

Laminate Gable Laminate Colour: Refer to laminate card for laminate options

End gable (Left hand, right hand)

Options:

Heights*: 25", 28"

Depth: 20", 24", 30"

*25" high to be used to Tech Drop surface

Notes:

Laminate Gable can be used with worksurface with grommet, worksurface without grommet, worksurface for 1" wire play

Freestanding gable is used when one side of the surface is connected to a panel and the other is open

Code	Price	H	W	D	Weight (lb.)	Volume (ft ³)
Left hand						
L-HWEG-Y-2520-L	449	25	20	2	10.00	0.58
L-HWEG-Y-2524-L	459	25	24	2	12.00	0.69
L-HWEG-Y-2530-L	507	25	30	2	15.00	0.87
L-HWEG-Y-2820-L	457	28	20	2	11.20	0.65
L-HWEG-Y-2824-L	473	28	24	2	13.44	0.78
L-HWEG-Y-2830-L	525	28	30	2	16.80	0.97
Right hand						
L-HWEG-Y-2520-R	449	25	20	2	10.00	0.58
L-HWEG-Y-2524-R	459	25	24	2	12.00	0.69
L-HWEG-Y-2530-R	507	25	30	2	15.00	0.87
L-HWEG-Y-2820-R	457	28	20	2	11.20	0.65
L-HWEG-Y-2824-R	473	28	24	2	13.44	0.78
L-HWEG-Y-2830-R	525	28	30	2	16.80	0.97

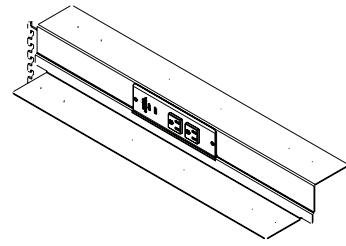

Standard Panel Tech Drop

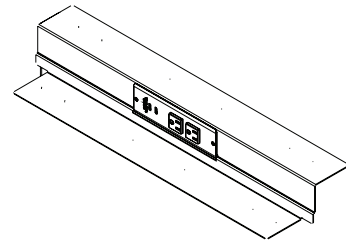

Gallery Panel Tech Drop

What's Included:

One (1) tech drop, one (1) power module with two (2) AC outlets and two (2) USB-A outlets, one (1) panel connector hardware

How to Specify:

Choose White, Black, Silver, Charcoal for Tech Drop

Left, right

Options:

Heights: 3"

Depth*: 19", 23"

*19" is used with the 20" deep surface

Notes:

Tech drop offers a 3" drop between main surface and return surface

Tech drop must be mounted to the panel

Code	Price	H	W	D	Weight (lb.)	Volume (ft ³)
Standard Panel Tech Drop - left hand						
L-HSSE-P-19-L	377	3	19.875	4	6.33	0.14
L-HSSE-P-23-L	386	3	23.875	4	7.67	0.17
Standard Panel Tech Drop - right hand						
L-HSSE-P-19-R	377	3	19.875	4	6.33	0.14
L-HSSE-P-23-R	386	3	23.875	4	7.67	0.17
Gallery Panel Tech Drop - left hand						
L-HSSE-Y-19-L	382	3	19.875	4	6.33	0.14
L-HSSE-Y-23-L	390	3	23.875	4	7.67	0.17
Gallery Panel Tech Drop - right hand						
L-HSSE-Y-19-R	382	3	19.875	4	6.33	0.14
L-HSSE-Y-23-R	390	3	23.875	4	7.67	0.17

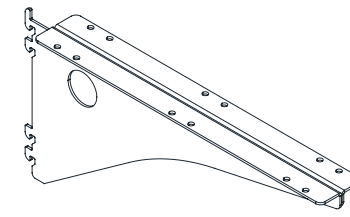

Standard Panel Mounted Cantilever Arm

What's Included:

One (1) standard panel mounted cantilever arm

How to Specify:

Left, right, mid

Options:

Depth: 16", 22"

Notes:

Cantilever available in black only

Code	Price	H	W	D	Weight (lb.)	Volume (ft ³)
intermediate						
L-CCAB-P-16	69	8	16	2	2.56	0.15
L-CCAB-P-22	76	8	22	2	3.52	0.21
left hand						
L-CCAB-P-16-L	69	8	16	1.5	1.92	0.11
L-CCAB-P-22-L	76	8	22	1.5	2.64	0.15
right hand						
L-CCAB-P-16-R	69	8	16	1.5	1.92	0.11
L-CCAB-P-22-R	76	8	22	1.5	2.64	0.15

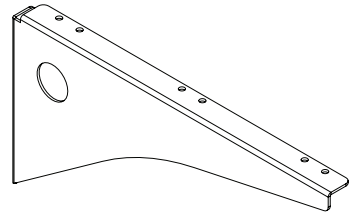

Gallery Panel Mounted Cantilever Arm

What's Included:

One (1) gallery panel mounted cantilever arm

How to Specify:

Left, right, mid

Options:

Depth: 16", 22"

Notes:

Cantilever available in black only

Code	Price	H	W	D	Weight (lb.)	Volume (ft ³)
intermediate						
L-CCAB-Y-16	69	8	16	2	2.56	0.15
L-CCAB-Y-22	76	8	22	2	3.52	0.21
left hand						
L-CCAB-Y-16-L	69	8	16	1.5	1.92	0.11
L-CCAB-Y-22-L	76	8	22	1.5	2.64	0.15
right hand						
L-CCAB-Y-16-R	69	8	16	1.5	1.92	0.11
L-CCAB-Y-22-R	76	8	22	1.5	2.64	0.15

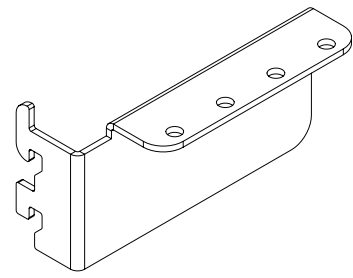

L-HCB
left hand shown

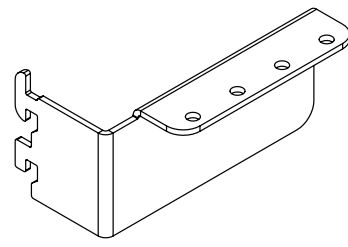

L-HCB1
left hand shown

What's Included:

One (1) standard panel mounted corner bracket

How to Specify:

Left, right
Full depth surface, surface with 1" wire play

Notes:

Worksurface with 1" wire play requires 1" offset bracket

Corner bracket available in black only

Options:

Code	Price	H	W	D	Weight (lb.)	Volume (ft ³)
L-HCB-P-L	9	3	4	2	0.05	0.01
L-HCB1-P-L	17	3	4	2	0.05	0.01
L-HCB-P-R	9	3	4	2	0.05	0.01
L-HCB1-P-R	17	3	4	2	0.05	0.01

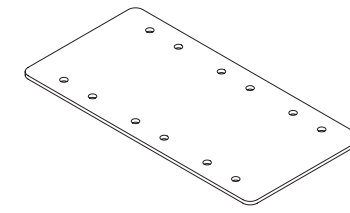

What's Included:

One (1) flush plate

How to Specify:

Flush Plate Paint Colour: Silver only

Notes:

Flush plate is used at surface joint to connect two surfaces together

Options:

Width: 5.5"
Depth: 3"

Code	Price	H	W	D	Weight (lb.)	Volume (ft ³)
L-PWW	48	3	5.5	0.125	1.00	0.00

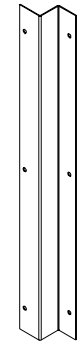

for standard panel



for gallery panel

What's Included:

panel to storage support bracket

How to Specify:

Available in white, black, charcoal, and silver

Notes:

Storage support bracket is used to connect off-modular storage to a surface

24" bracket is used to close 1" gap between storage and panel

30" bracket is used to close 7" gap between storage and panel

Options:

Width: 1", 7"

Code	Price	H	W	Weight (lb.)	Volume (ft ³)
for standard panel - left hand					
L-HPSP-24-L	55	28	1	8.57	0.39
L-HPSP-30-L	101	28	1	10.71	0.49
for standard panel -right hand					
L-HPSP-24-R	55	28	1	8.57	0.39
L-HPSP-30-R	101	28	1	10.71	0.49
for gallery panel					
L-HPGP-24	69	28	1	8.57	0.39
L-HPGP-30	143	2828	1	10.72	0.49

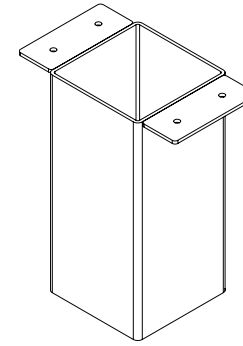

What's Included:

One (1) 90 degree bracket

How to Specify:

Flush Plate Paint Colour: Silver, White, Black, Charcoal

Options:

Height: 6"

Width: 4"

Depth: 4"

Notes:

Code	Price	H	W	D	Weight (lb.)	Volume (ft ³)
L-HCFM6	197	6.375	7	4	6.00	0.14

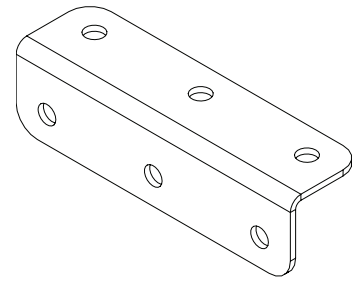

What's Included:

One (1) 90 degree bracket

How to Specify:

Available in black only

Options:

Depth: 3"

Notes:

90 degree bracket is used to connect a worksurface to a gallery panel

- 24" deep surface: two (2) brackets
- 30" deep surface: three (3) brackets

Code	Price	Specifications	Weight (lb.)	Volume (ft ³)
L-HSSB	3	3", 6 Holes	0.50	0.09
L-HSSB-24	9	For 24"Deep	2.19	0.09
L-HSSB-30	15	For 30"Deep	3.00	0.09

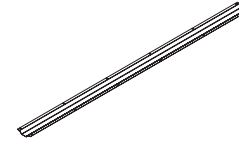

What's Included:

Horizontal Surface Support, installation hardware.

How to Specify:

The horizontal surface support is available only in silver.

Options:

width 51, 57, 63, 69, 75

Notes:

The horizontal surface support is used to support worksurfaces 54-inches and longer.

This item is mounted to the underside of a worksurface.

Code	Price	W (in)	Weight (lb)	Volume (ft ³)
L-CH00-54	81	51	4.00	0.05
L-CH00-60	87	57	4.50	0.05
L-CH00-66	94	63	5.00	0.06
L-CH00-72	98	69	5.50	0.06
L-CH00-78	104	75	6.00	0.07



Switch USA Pricebook
January 2026
Electrics

Electrics

Power Module	178
Starter Harness	179
Connector Harness	180
Male to Female Extension Harness	182
New York Junction Box	183
Chicago Electrical Box	184
Power Pole	185
Communication Kit	186
Conversion Kit	187

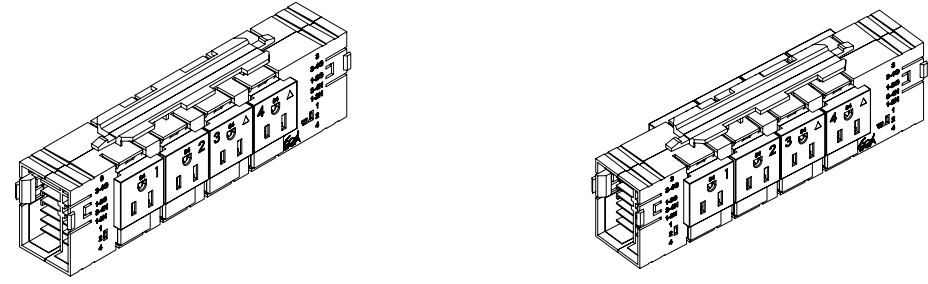

What's Included:

One (1) single power module with four (4) ac outlets or one (1) double sided power module with eight (8) ac outlets (four on each side)

How to Specify:

Available in grey only
Single sided, double sided

Options:

Width: 8"

Notes:

Power modules are installed in the center cut out power capable panels only

Double sided power module has four (4) ac outlets on each side

Refer to Switch electrical specification guide for more information

Code	Price	H	W	D	Weight (lb.)	Volume (ft ³)
single sided						
L-EM84-S	242	3	6	3	1.70	0.03
double sided						
L-EM84-D	386	3	6	3	2.00	0.03

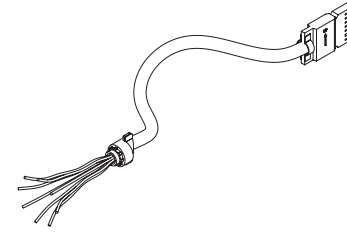

What's Included:

One (1) open wire starter harness

How to Specify:

Available in grey only
Single sided, double sided

Options:

Length: 72", 168"

Notes:

Switch electrical system is rated for 20 amps

Tayco recommends up to 8 workstations hardwired to one power source

Code	Price	L	D	Weight (lb.)	Volume (ft ³)
L-ES84-072-0	359	72	0.75	2.61	0.40
L-ES84-168-0	451	168	0.75	5.12	0.50

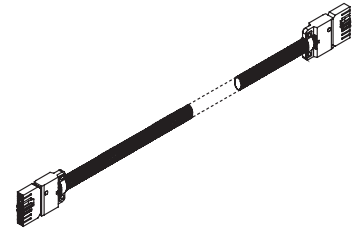

What's Included:

One (1) connector harness

How to Specify:

Available in grey only

Single sided, double sided

Options:

Length: 22"-181" in 3" increments

Notes:

Connector harness is used to connect two power modules together

Refer to installation guide for connector harness length calculation

Code	Price	Length	D	Weight (lb.)	Volume (ft ³)
L-EH84-22	182	22	0.75	0.60	0.20
L-EH84-25	187	25	0.75	0.70	0.20
L-EH84-28	194	28	0.75	0.80	0.20
L-EH84-31	201	31	0.75	0.80	0.20
L-EH84-34	208	34	0.75	0.90	0.20
L-EH84-37	214	37	0.75	1.00	0.20
L-EH84-40	223	40	0.75	1.10	0.20
L-EH84-43	229	43	0.75	1.20	0.20
L-EH84-46	232	46	0.75	1.30	0.20
L-EH84-49	239	49	0.75	1.50	0.20
L-EH84-52	245	52	0.75	1.50	0.20
L-EH84-55	256	55	0.75	1.60	0.20
L-EH84-58	259	58	0.75	1.70	0.20
L-EH84-61	267	61	0.75	1.80	0.20
L-EH84-64	271	64	0.75	1.90	0.20
L-EH84-67	281	67	0.75	1.90	0.20
L-EH84-70	284	70	0.75	2.00	0.20
L-EH84-73	295	73	0.75	1.95	0.20
L-EH84-76	301	76	0.75	2.04	0.20
L-EH84-79	307	79	0.75	2.12	0.20
L-EH84-82	312	82	0.75	2.12	0.20
L-EH84-85	317	85	0.75	2.37	0.20
L-EH84-88	325	88	0.75	2.37	0.20
L-EH84-91	331	91	0.75	2.37	0.20

Power & Data continued

Code	Price	Length	D	Weight (lb.)	Volume (ft ³)
L-EH84-94	338	94	0.75	2.53	0.20
L-EH84-97	346	97	0.75	2.53	0.20
L-EH84-100	351	100	0.75	2.70	0.20
L-EH84-103	358	103	0.75	2.70	0.20
L-EH84-106	364	106	0.75	2.86	0.20
L-EH84-109	373	109	0.75	2.86	0.20
L-EH84-112	377	112	0.75	3.03	0.20
L-EH84-115	385	115	0.75	3.03	0.20
L-EH84-118	391	118	0.75	3.19	0.20
L-EH84-121	398	121	0.75	3.36	0.20
L-EH84-124	402	124	0.75	3.36	0.20
L-EH84-127	412	127	0.75	3.52	0.20
L-EH84-130	421	130	0.75	3.52	0.20
L-EH84-133	424	133	0.75	3.39	0.20
L-EH84-136	429	136	0.75	3.69	0.20
L-EH84-139	437	139	0.75	3.85	0.20
L-EH84-142	441	142	0.75	3.85	0.20
L-EH84-145	452	145	0.75	3.85	0.20
L-EH84-148	602	148	0.75	3.85	0.20
L-EH84-151	609	151	0.75	4.18	0.20
L-EH84-154	616	154	0.75	4.26	0.20
L-EH84-157	623	157	0.75	4.35	0.20
L-EH84-160	629	160	0.75	4.43	0.20
L-EH84-163	634	163	0.75	4.51	0.20
L-EH84-166	641	166	0.75	4.59	0.20
L-EH84-169	650	169	0.75	4.68	0.20
L-EH84-172	655	172	0.75	4.76	0.20
L-EH84-175	662	175	0.75	4.84	0.20
L-EH84-178	666	178	0.75	4.92	0.20
L-EH84-181	675	181	0.75	5.01	0.20

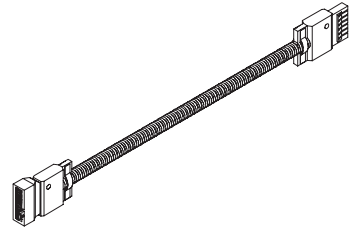

What's Included:

One (1) male to female extension harness

How to Specify:

Available in grey only
Single sided, double sided

Options:

Length: 44",122"

Notes:

Male to female extension harness is used to extend length of the starter harness

Code	Price	Length	D	Weight (lb.)
L-E8FM-044	232	44	0.75	0.30
L-E8FM-122	402	122	0.75	0.60

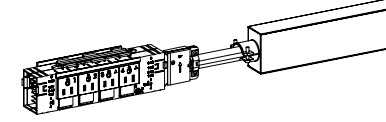

What's Included:

Panels 24", 30", 36" wide: One (1) New York junction box

Panels 42" or wider: One (1) New York junction box with single or double power module

How to Specify:

Panels 24", 30", 36" wide: Specify junction box without power module. Power module and starter harness must be specified speratley

Panels 42" or wider: Specify single or double power module with junction box

Options:

Junction Box width: 9"

Junction Box with power module width: 18"

Notes:

Male to female extension harness is used to extend length of the starter harness

Code	Price	Length	D	Weight (lb.)
L-NY84-004-D	811			
L-NY84-004-S	662			
L-NYEJ-84	230			

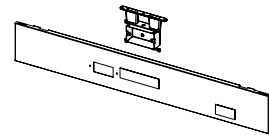

Single sided

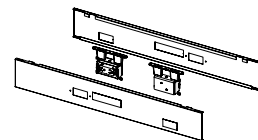

Double sided

What's Included:

Single Sided: One (1) electrical box with two (2) ac outlets and one (1) panel raceway

Double Sided: Two (2) single sided electrical boxes each with two (2) ac outlets and two (2) panel raceways

How to Specify:

Select corresponding size to match the panel width

Options:

Width: 30", 36", 42", 48", 54", 60", 72"

Notes:

Junction box is located on the left hand side of the panel

Code	Price	Length	W	Weight (lb.)
Single Sided				
L-JB0X-30-S	382	30		
L-JB0X-36-S	382	36		
L-JB0X-42-S	382	42		
L-JB0X-48-S	382	48		
L-JB0X-54-S	382	54		
L-JB0X-60-S	382	60		
Double Sided				
L-JB0X-30-D	760	30		
L-JB0X-36-D	760	36		
L-JB0X-42-D	760	42		
L-JB0X-48-D	760	48		
L-JB0X-54-D	760	54		
L-JB0X-60-D	760	60		

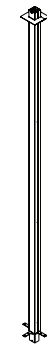

for 3 way connection(3W)



for 4 way connection(4W)

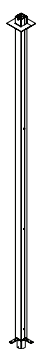

For 90 Degree Connection (N)

What's Included:

One (1) power pole, chosen mounting hardware

How to Specify:

Specify type based on panel connection: 90 degree, 3-way T, 4 way X and gallery panel mount

90 degree, 3-way T and 4-way X must be used with same height connecting panels

Use gallery panel mount type at the end of a run

Notes:

Options:

Connector type height: 96", 120"

Gallery panel height: 144"

Code	Price	H	W	D	Weight (lb.)	Volume (ft ³)
standard panel						
L-EP-P-120-3W	536	120	2	2	2.00	0.28
L-EP-P-120-4W	536	120	2	2	2.00	0.28
L-EP-P-120-N	536	120	2	2	2.00	0.28
L-EP-P-96-3W	482	96	2	2	1.50	0.22
L-EP-P-96-4W	482	96	2	2	1.50	0.22
L-EP-P-96-N	482	96	2	2	2.00	0.22
gallery panel						
L-EP-Y-144	663	144	2	2	2.00	0.33

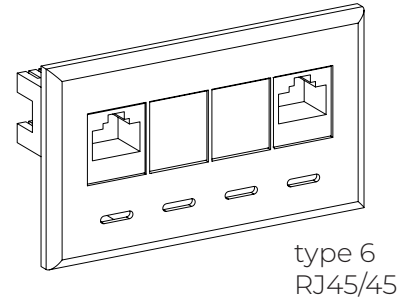
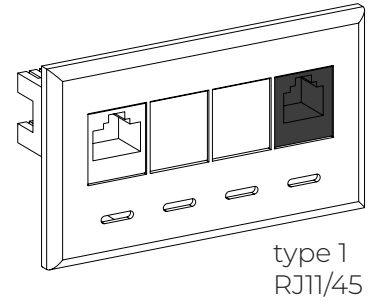

What's Included:

One (1) data plate with three (3) openings and chosen combination of RJ11/RJ45

How to Specify:

Specify RJ11 for phone connection
Specify RJ45 for data connection

Notes:

Data is placed on the right hand side of the cutout in the panel raceway

Options:

Panel cutout width: 2 3/4"

Panel cutout height: 1 3/8"

Code	Price	H	W	D	Weight (lb.)	Volume (ft ³)
type 1						
L-ECK1	174	2	4	1	0.24	0.00
type 6						
L-ECK6	174	2	4	1	0.24	0.00

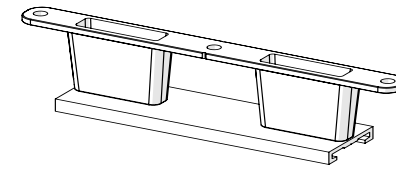

Non-Power Capable to Power Capable Panel Conversion Kit

What's Included:

One (1) power module mounting bracket

How to Specify:

Specify RJ11 for phone connection
Specify RJ45 for data connection

Options:

Notes:

Used to convert a non-power capable panel to a power capable panel

To be placed in the of the non-power capable panel raceway to convert to a power capable

Power module to be specified seperately

Code	Price	Weight (lb.)	Volume (ft ³)
RI-0300	27		



Switch USA Pricebook
January 2026
Storage

Storage

Pedestals	190
Underdesk Pedestal	190
Mobile	191
Upholstered Seat Pad	192
Lateral File	193
Underdesk	193
Freestanding	194
Credenza	195
Open Lateral	195
Storage Tower	196
Wardrobe Tower	197
Combo Tower	198
w/ Front Access	198
w/ Side Access	200
Panel Mounted Overheads - Cabinet	202
Flipper	202
Hinged Door	203
Shared	204
Cubby	206
Metal Shelf	207

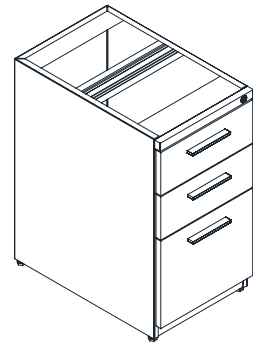

box/box/file

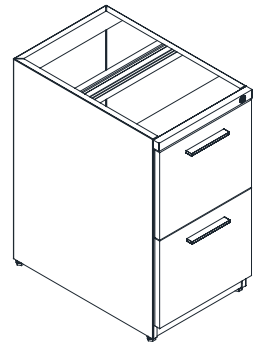

file/file

What's Included:

One (1) box/box/file or one (1) file/file underdesk pedestal

How to Specify:

Pedestal type: box/box/file, file/file

Notes:

Pedestal brackets must be ordered separately

Locks can be keyed alike or random

Options:

Height: 28"

Width: 16"

Depth: 23", 29"

Code	Price	H	W	D	Weight (lb.)	Volume (ft ³)
box/box/file						
L-FPBU-281623	1014	28	16	23	64.40	5.96
L-FPBU-281629	1047	28	16	29	81.20	7.52
file/file						
L-FPFU-281623	938	28	16	23	64.40	5.96
L-FPFU-281629	978	28	16	29	81.20	7.52

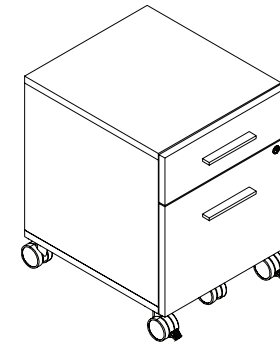

box/ file/no cushion

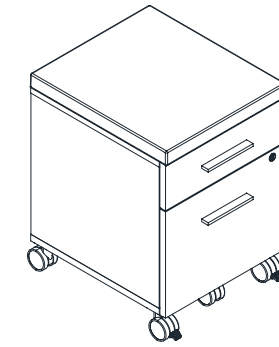

box/file w/ cushion

What's Included:

One (1) box/file mobile pedestal or one (1) box/file mobile pedestal with cushion, five (5) lockable casters

How to Specify:

With or without cushion

Refer to seating fabric card for cushion fabric selection

Choose handle type and finish

Choose depth

Choose silver or white for caster finish

Notes:

Locks can be keyed alike or random

Options:

Height: 21" without cushion, 22" with cushion

Width: 16"

Depth: 18"

Code	Price	H	W	D	Weight (lb.)	Volume (ft ³)
box/file/no cushion						
L-FPL0-211618	1033	21	16	18	43.20	3.50
box/file w/ cushion						
L-FPLS-221618	1189	22	16	18	45.26	3.67

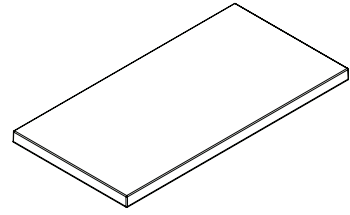

What's Included:

One (1) upholstered seat pad

How to Specify:

Refer to seating fabric card for fabric selection

Notes:

Options:

Height:	1"
Width:	24", 30", 36", 48", 60", 72"
Depth:	18"

Code	Price	H	W	D	Weight (lb.)	Volume (ft ³)
L-PAD-1824	346	24	24	2	2.40	0.67
L-PAD-1830	391	24	30	2	3.00	0.83
L-PAD-1836	438	24	36	2	3.60	1.00
L-PAD-1848	540	24	48	2	4.80	1.33
L-PAD-1860	635	24	60	2	6.00	1.67
L-PAD-1872	737	24	72	2	7.20	2.00

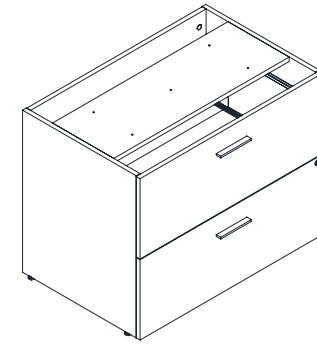

Lateral File lateral

What's Included:

One (1) two drawer underdesk lateral filing cabinet, each drawer is equipped with (2) bars for front to back filing

How to Specify:

Refer to laminate card for laminate selection
 Choose handle type and finish
 Choose depth

Notes:

Lateral brackets must be ordered separately
 Locks can be keyed alike or random

Options:

Height:	28"
Width:	30", 36"
Depth:	23", 29"

Code	Price	H	W	D	Weight (lb.)	Volume (ft ³)
underdesk 2 Drawer						
L-FL2U-283023	1289	28	30	23	107.33	11.18
L-FL2U-283029	1328	28	30	29	135.33	14.10
L-FL2U-283623	1392	28	36	23	128.80	13.42
L-FL2U-283629	1431	28	36	29	162.40	16.92

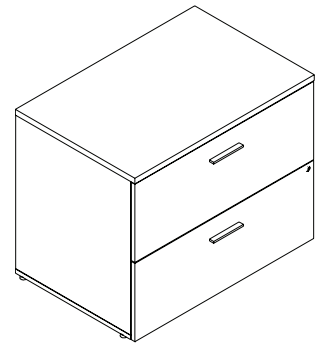

Lateral File
2 Drawer

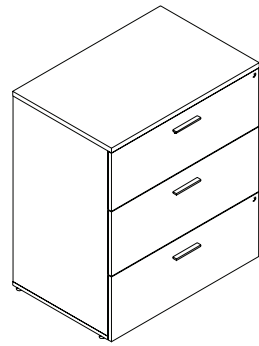

3 drawer

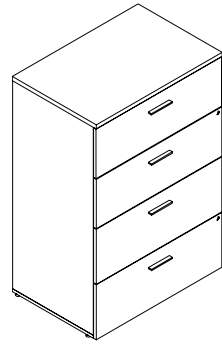

4 drawer

What's Included:

One (1) two drawer, three drawer or four drawer freestanding lateral filing cabinet with finished top, each drawer is equipped with (2) bars for front to back filing

How to Specify:

- Refer to laminate card for laminate selection
- Choose two drawer, three drawer or four drawers
- Choose handle type and finish
- Choose silver or white for caster finish

Options:

- Height: 29" for 2 drawer, 42" for 3 drawer, 54" for 4 drawer
- Width: 30", 36"
- Depth: 24"

Notes:

Locks can be keyed alike or random

Code	Price	H	W	D	Weight (lb.)	Volume (ft ³)
2 Drawer						
L-FL2F-293024	1590	29	30	24	116.00	12.08
L-FL2F-293624	1727	29	36	24	139.20	14.50
3 drawer						
L-FL3F-423024	2048	42	30	24	168.00	17.50
L-FL3F-423624	2212	42	36	24	201.60	21.00
4 drawer						
L-FL4F-543024	2482	54	30	24	216.00	22.50
L-FL4F-543624	2680	54	36	24	259.20	27.00

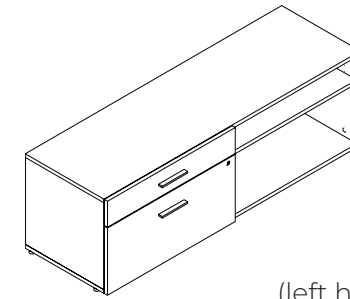

(left hand shown)

What's Included:

One (1) open lateral credenza, one (1) adjustable shelf for open cabinet

How to Specify:

- Choose right hand or left hand
- Refer to laminate card for laminate selection
- Choose handle type and finish

Options:

- Height: 22"
- Width: 48", 60", 72"
- Depth: 18"

Notes:

- Locks can be keyed alike or random
- Right handed has lateral on right side
- Left handed has lateral on left side
- Can be used as a surface support credenza, with credenza fixed support specified separately

Code	Price	H	W	D	Weight (lb.)	Volume (ft ³)
Left hand						
L-CRCL-224818-L	1272	22	48	18	115.20	11.00
L-CRCL-226018-L	1404	22	60	18	144.00	13.75
L-CRCL-227218-L	1535	22	72	18	172.80	16.50
Right hand						
L-CRCL-224818-R	1272	22	48	18	115.20	11.00
L-CRCL-226018-R	1404	22	60	18	144.00	13.75
L-CRCL-227218-R	1535	22	72	18	172.80	16.50

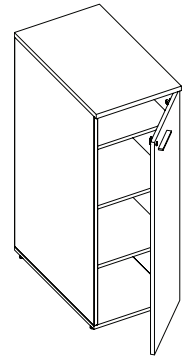

left hand shown

What's Included:

One (1) storage tower with one (1) adjustable shelf and (1) fixed shelf for 42" high or two (2) adjustable shelves and (1) fixed shelf for 50" high

How to Specify:

- Choose right hand or left hand
- Refer to laminate card for laminate selection
- Choose handle type and finish

Options:

Height:	42", 50"
Width:	18"
Depth:	24", 30"

Notes:

- Locks can be keyed alike or random
- Right handed has hinge on right side
- Left handed has hinge on left side

Code	Price	H	W	D	Weight (lb.)	Volume (ft ³)
Left hand						
L-FTSS-421824-L	1592	42	18	24	86.40	10.50
L-FTSS-421830-L	1622	42	18	30	108.00	13.13
L-FTSS-501824-L	1622	50	18	24	102.86	12.50
L-FTSS-501830-L	1642	50	18	30	128.57	15.63
Right hand						
L-FTSS-421824-R	1592	42	18	24	86.40	10.50
L-FTSS-421830-R	1622	42	18	30	108.00	13.13
L-FTSS-501824-R	1622	50	18	24	102.86	12.50
L-FTSS-501830-R	1642	50	18	30	128.57	15.63

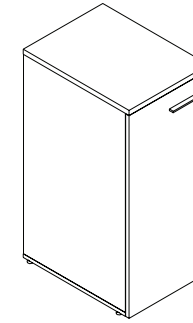

left hand shown

What's Included:

One (1) wardrobe tower, one (1) coat bar

How to Specify:

- Choose right hand or left hand
- Refer to laminate card for laminate selection
- Choose handle type and finish

Options:

Height:	42", 50"
Width:	18"
Depth:	24", 30"

Notes:

- Locks can be keyed alike or random
- Right handed has hinge on right side
- Left handed has hinge on left side

Code	Price	H	W	D	Weight (lb.)	Volume (ft ³)
Left hand						
L-FTCS-421824-L	1257	42	18	24	86.40	10.50
L-FTCS-421830-L	1339	42	18	30	108.00	13.13
L-FTCS-501824-L	1388	50	18	24	102.86	12.50
L-FTCS-501830-L	1478	50	18	30	128.57	15.63
Right hand						
L-FTCS-421824-R	1257	42	18	24	86.40	10.50
L-FTCS-421830-R	1339	42	18	30	108.00	13.13
L-FTCS-501824-R	1388	50	18	24	102.86	12.50
L-FTCS-501830-R	1478	50	18	30	128.57	15.63

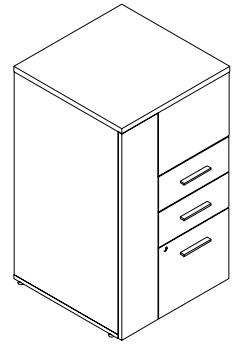

Combo Tower(left hand shown)

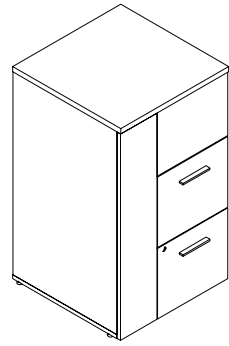

Combo Tower (left hand shown)

What's Included:

- One (1) combo tower with front access,
- one (1) coat bar,
- one (1) box/box/file or one(1) file/file drawers,
- one(1) cubby for 42" high or two (2) cubbies for 50" high

How to Specify:

Choose right hand or left hand

Refer to laminate card for laminate selection

Choose handle type and finish

Choose box/box/file, file/file drawers

Options:

Height: 42", 50"

Width: 24"

Depth: 24", 30"

Notes:

- Locks can be keyed alike or random
- Right handed has door on right side
- Left handed has door on left side

Code	Price	H	W	D	Weight (lb.)	Volume (ft ³)
box/box/file pedestal -left hand						
L-CWTB-422424-L	2668	42	24	24	127.00	14.00
L-CWTB-422430-L	2705	42	24	30	159.00	18.00
L-CWTB-502424-L	2705	50	24	24	152.00	17.00
L-CWTB-502430-L	2738	50	24	30	189.00	21.00
box/box/file pedestal - right hand						
L-CWTB-422424-R	2668	42	24	24	127.00	14.00
L-CWTB-422430-R	2705	42	24	30	159.00	18.00
L-CWTB-502424-R	2705	50	24	24	152.00	17.00
L-CWTB-502430-R	2738	50	24	30	189.00	21.00
file/file pedestal - left hand						
L-CWTF-422424-L	2644	42	24	24	127.00	14.00
L-CWTF-422430-L	2644	42	24	30	159.00	18.00
L-CWTF-502424-L	2644	50	24	24	152.00	17.00
L-CWTF-422430-L	2644	42	24	30	159.00	18.00
file/file pedestal - right hand						
L-CWTF-422424-R	2644	42	24	24	127.00	14.00
L-CWTF-422430-R	2644	42	24	30	159.00	18.00
L-CWTF-502424-R	2644	50	24	24	152.00	17.00
L-CWTF-502430-R	2644	50	24	30	189.00	21.00

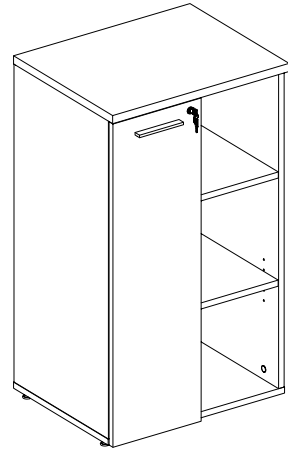

left hand shown

What's Included:

- One (1) combo tower with side access,
- one (1) coat bar,
- one (1) adjustable shelf and
- one (1) fixed shelf for 42" high or two (2) adjustable shelves and (1) fixed shelf for 50" high

How to Specify:

- Choose right hand or left hand
- Refer to laminate card for laminate selection
- Choose handle type and finish
- Choose box/box/file, file/file drawers

Notes:

- Locks can be keyed alike or random
- Right handed has door on right side
- Left handed has door on left side

Options:

Height:	42", 50"
Width:	24"
Depth:	18.75", 24", 30"

Code	Price	H	W	D	Weight (lb.)	Volume (ft ³)
Left Hand						
L-FTCO-422418-L	1297	41	24	18.75	85.00	11.00
L-FTCO-422424-L	1442	41	24	24	101.00	14.00
L-FTCO-422430-L	1618	41	24	30	121.00	17.00
L-FTCO-502418-L	1495	49	24	18.75	97.00	13.00
L-FTCO-502424-L	1661	49	24	24	115.00	16.00
L-FTCO-502430-L	1864	49	24	30	138.00	21.00
Right hand						
L-FTCO-422418-R	1297	41	24	18.75	85.00	11.00
L-FTCO-422424-R	1442	41	24	24	101.00	14.00
L-FTCO-422430-R	1618	41	24	30	121.00	17.00
L-FTCO-502418-R	1495	49	24	18.75	97.00	13.00
L-FTCO-502424-R	1661	49	24	24	115.00	16.00

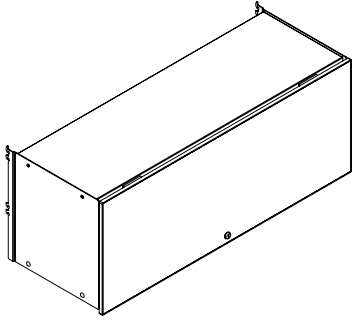

What's Included:

One (1) flipper cabinet

How to Specify:

Choose metal or laminate face

Choose white, black, silver, charcoal for metal face and body

Refer to laminate card for laminate face options

Notes:

Locks can be keyed alike or random

Flipper cabinet slides are easy-down pneumatic

Options:

Height*: 16"

Width: 30", 36", 42", 48", 54", 60"

Depth**: 15"

* Internal cabinet height is 13"

** Internal cabinet depth is 13"

Code	Price	H	W	D	Weight (lb.)	Volume (ft ³)
laminate face w/pneumatic slides						
L-SPFL-1530-P	682	16	30	15	32.73	4.17
L-SPFL-1536-P	687	16	36	15	39.27	5.00
L-SPFL-1542-P	712	16	42	15	45.82	5.83
L-SPFL-1548-P	718	16	48	15	52.36	6.67
L-SPFL-1554-P	746	16	54	15	58.91	7.50
L-SPFL-1560-P	753	16	60	15	65.46	8.33
metal face w/pneumatic slides						
L-SPFM-1530-P	694	16	30	15	32.73	4.17
L-SPFM-1536-P	714	16	36	15	39.27	5.00
L-SPFM-1542-P	737	16	42	15	45.82	5.83
L-SPFM-1548-P	761	16	48	15	52.36	6.67
L-SPFM-1554-P	778	16	54	15	58.91	7.50
L-SPFM-1560-P	803	16	60	15	65.46	8.33

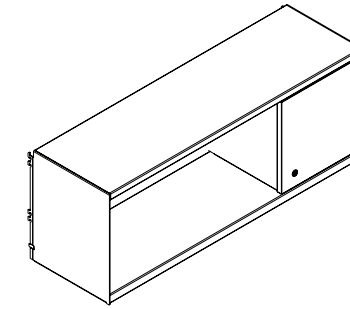
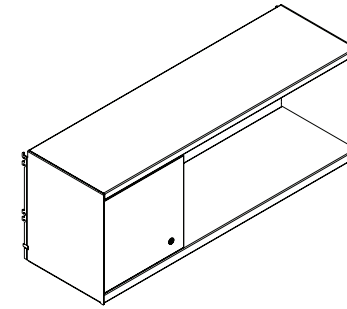

What's Included:

One (1) hinged cabinet, one (1) 12" wide hinged door

How to Specify:

Choose white, black, silver, charcoal for metal body

Refer to laminate card for laminate face options

Door on right or left side

Notes:

Locks can be keyed alike or random

OL refers to open on left side

LO refers to open on right side

Options:

Height*: 16"

Width: 36", 42", 48", 54", 60"

Depth**: 12"

* Internal cabinet height is 13"

** Internal cabinet depth is 12"

Code	Price	H	W	D	Weight (lb.)	Volume (ft ³)
closed/open						
L-SPLO-1536	981	16	36	15	43.20	5.00
L-SPLO-1542	1047	16	42	15	50.40	5.83
L-SPLO-1548	1071	16	48	15	57.60	6.67
L-SPLO-1554	1148	16	54	15	64.80	7.50
L-SPLO-1560	1165	16	60	15	72.00	8.33
open/closed						
L-SPOL-1536	981	16	36	15	43.20	5.00
L-SPOL-1542	1047	16	42	15	50.40	5.83
L-SPOL-1548	1071	16	48	15	57.60	6.67
L-SPOL-1554	1148	16	54	15	64.80	7.50
L-SPOL-1560	1165	16	60	15	72.00	8.33

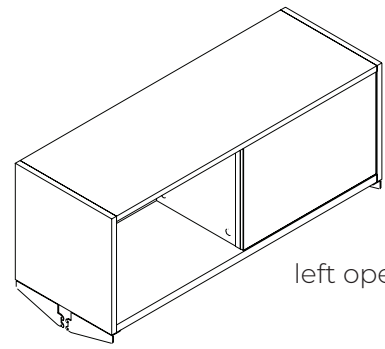

left open/right tackboard

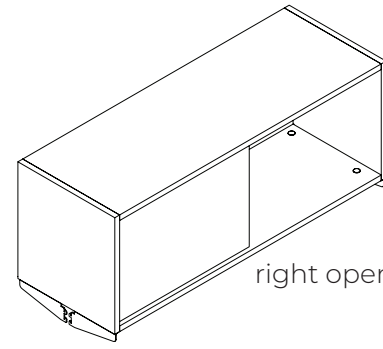

right open/ left melamine

What's Included:

One (1) shared cabinet, (1) tackboard if tackboard option is selected, four (4) panel mount cantilevers for up to 60"W or six (6) panel mount cantilevers for 66", 72"W

How to Specify:

- Choose white, black, silver, charcoal for cantilever
- Refer to laminate card for laminate face options
- Refer to panel fabric card for tackboard fabric options

Notes:

- OM refers to open on left side
- MO refers to open on right side
- OT refers to open on left side with tackboard on right side
- TO refers to open on right side with tackboard on left side

Options:

Height*:	16"
Width:	36", 42", 48", 54", 60", 66", 72
Depth**:	15"

* Internal cabinet height is 13" ** Internal cabinet depth is 13.5"

Code	Price	H	W	D	Weight (lb.)	Volume (ft ³)
left open/right tackboard						
L-STOT-161536	841	16	36	15	43.20	5.00
L-STOT-161542	895	16	42	15	50.40	5.83
L-STOT-161548	946	16	48	15	57.60	6.67
L-STOT-161554	998	16	54	15	64.80	7.50
L-STOT-161560	1050	16	60	15	72.00	8.33
L-STOT-161566	1105	16	66	15	79.20	9.17
L-STOT-161572	1160	16	72	15	86.40	10.00
right open/ left tackboard						
L-STTO-161536	841	16	36	15	43.20	5.00
L-STTO-161542	895	16	42	15	50.40	5.83
L-STTO-161548	946	16	48	15	57.60	6.67
L-STTO-161554	998	16	54	15	64.80	7.50
L-STTO-161560	1050	16	60	15	72.00	8.33
L-STTO-161566	1105	16	66	15	79.20	9.17
L-STTO-161572	1160	16	72	15	86.40	10.00

Code	Price	H	W	D	Weight (lb.)	Volume (ft ³)
right open/left melamine						
L-STMO-161536	633	16	36	15	43.20	5.00
L-STMO-161542	682	16	42	15	50.40	5.83
L-STMO-161548	726	16	48	15	57.60	6.67
L-STMO-161554	777	16	54	15	64.80	7.50
L-STMO-161560	825	16	60	15	72.00	8.33
L-STMO-161566	874	16	66	15	79.20	9.17
L-STMO-161572	925	16	72	15	86.40	10.00
left open/right melamine						
L-STOM-161536	633	16	36	15	43.20	5.00
L-STOM-161542	682	16	42	15	50.40	5.83
L-STOM-161548	726	16	48	15	57.60	6.67
L-STOM-161554	777	16	54	15	64.80	7.50
L-STOM-161560	825	16	60	15	72.00	8.33
L-STOM-161566	874	16	66	15	79.20	9.17
L-STOM-161572	925	16	72	15	86.40	10.00

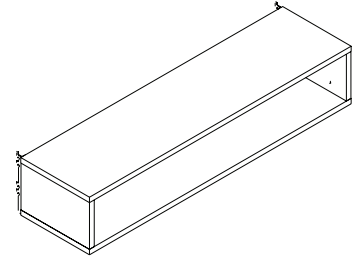

What's Included:

One (1) open cubby, two (2) mounting brackets

How to Specify:

Refer to laminate card for laminate face options

Notes:

Options:

Height*:	8"
Width:	24", 30", 36", 42", 48"
Depth**:	11"

* Internal cabinet height is 6.5"

** Internal cabinet depth is 11"

Code	Price	H	W	D	Weight (lb.)	Volume (ft ³)
L-SCS-081124	374	8	24	15	24.00	1.67
L-SCS-081130	390	8	30	15	27.00	2.08
L-SCS-081136	408	8	36	15	30.00	2.50
L-SCS-081142	425	8	42	15	33.00	2.92
L-SCS-081148	444	8	48	15	36.00	3.33

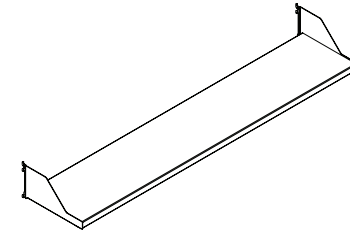

What's Included:

One (1) metal shelf

How to Specify:

Choose white, black, silver, charcoal for metal shelf

Notes:

Options:

Height:	6"
Width:	30", 36", 42", 48", 54", 60"
Depth:	12"

Code	Price	H	W	D	Weight (lb.)	Volume (ft ³)
L-SOOM-1230	365	2	30	12	14.40	0.42
L-SOOM-1236	385	2	36	12	17.28	0.50
L-SOOM-1242	400	2	42	12	20.16	0.58
L-SOOM-1248	413	2	48	12	23.04	0.67
L-SOOM-1254	429	2	54	12	25.92	0.75
L-SOOM-1260	446	2	60	12	28.80	0.83



Switch USA Pricebook
January 2026
Accessories

Accessories

<u>Desktop Power Module</u>	210
<u>Tasklight</u>	211
<u>Monitor Arm</u>	212
<u>Keyboard Tray</u>	213
<u>Work Organizers</u>	214
<u>Accessory Rail</u>	215
<u>Pencil Tray</u>	216

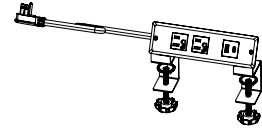

What's Included:

Clamp mount desktop power module equipped with two ac outlets, one USB A and one USB C charging ports, and one (1) three prong cord

How to Specify:

Can be used on freestanding surface or surface with 1" wireplay if connected to a panel

Available in black only

Dimensions:

Cord length: 120"

Power Module Width: 8"

Notes:

Clamp requires 1 3/4" x 8 1/8" undersurface clearance

Code	Price	H	W	D	Weight (lb.)	Volume (ft ³)
V-EMW-2AC	208	6	4	3	1.0	0.04

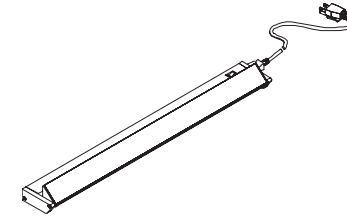

What's Included:

Task Light (1) and installation hardware.

How to Specify:

This product is available only in silver.

Notes:

The task light can be mounted beneath an overhead cabinet or shelf to provide focused lighting within the workstation.

The task light cord is 9-feet long from the end of the task light.

Task lights come with built-in occupancy sensor with 30 minute delay

Options:

Width 24", 36", 48"

Code	Price	H	W	D	Weight (lb.)	Volume (ft ³)
V-ELU-24	344	3	24	1	9.5	0.04
V-ELU-36	387	3	36	1	13.7	0.06
V-ELU-48	486	3	48	1	17.9	0.08

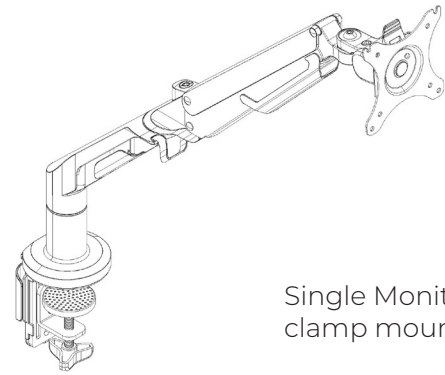

Single Monitor Arm - clamp mount

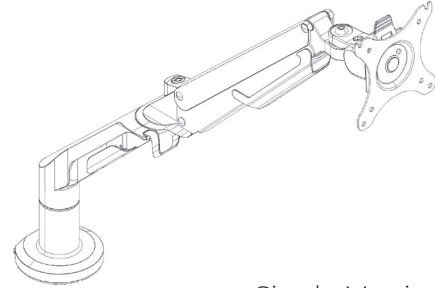

Single Monitor Arm - grommet mount

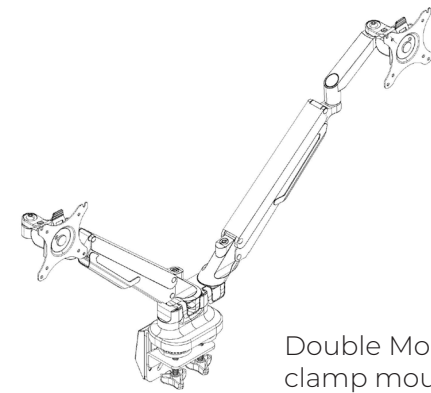

Double Monitor Arm - clamp mount

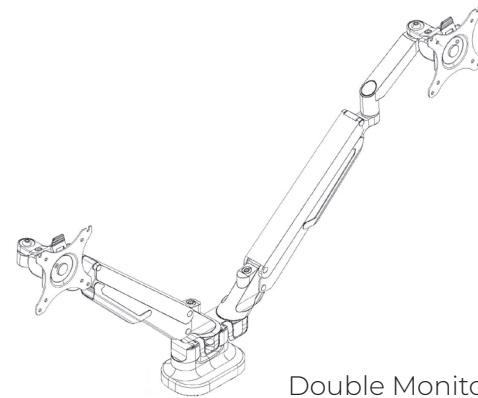

Double Monitor Arm - grommet mount

What's Included:

One monitor arm and installation hardware for both clamp and grommet mount

How to Specify:

- Specify type

Dimensions:

Vesa: 75x75 and 100x100

Code	Price
Monitor Arm - Single Mount	
V-AFMA-01	426
Monitor Arm - Double Mount	
V-AFMA-02	711

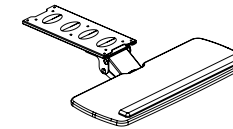

Articulating Keyboard Tray

What's Included:

Keyboard Tray, installation hardware.

How to Specify:

The articulating keyboards are available only in black.

Notes:

Keyboard trays provide adjustable ergonomic support for individuals in multi-task environments

Code	Price	H	W	D	Volume (ft ³)	Weight (lb)
Articulating Keyboard Tray						
V-KASX-2510	459	0	25	10	0	15

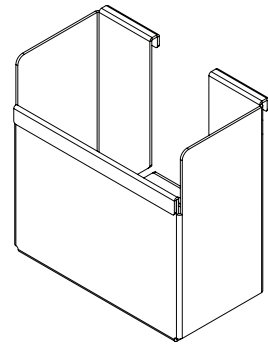

pencil holder

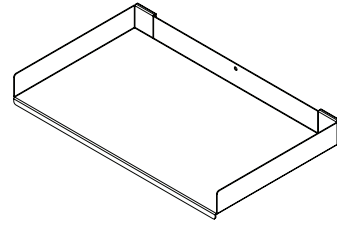

paper tray - legal

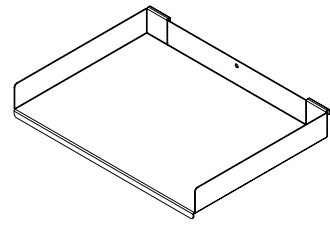

paper tray - letter

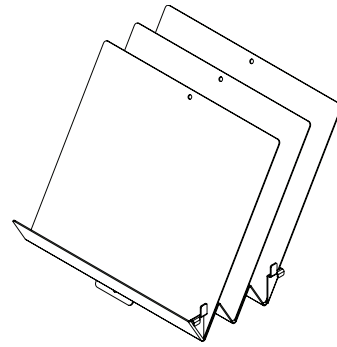

document sorter

What's Included:

One (1) paper tray or one (1) paper holder or one (1) paper sorter

How to Specify:

Refer to metal paint card for metal paint colors

Notes:

Dimensions:

Code	Price	H	W	D	Weight (lb.)	Volume (ft ³)
pen holder						
L-AAP0	131	6	4	2	0.32	
paper tray - legal						
L-AAP-13	161	11	13	1	3.20	
paper tray - letter						
L-AAP-9	141	11	9	1	2.10	
paper sorter						
L-AAS	249	10	10	10	3.20	

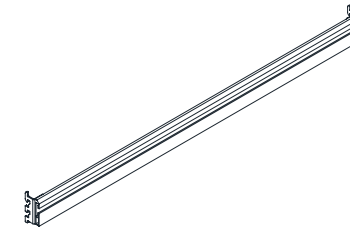

What's Included:

One (1) panel mount or wall mount accessory rail

How to Specify:

Panel mount, wall mount

Refer to metal paint card for metal paint colours

Dimensions:

Width: 24", 30", 36", 42", 48", 54", 60"

Notes:

Code	Price	H	W	D	Weight (lb.)	Volume (ft ³)
Panel Mounted						
L-AR-24	222	3	24	0.75	0.77	
L-AR-30	230	3	30	0.75	0.86	
L-AR-36	237	3	36	0.75	0.95	
L-AR-42	249	3	42	0.75	1.04	
L-AR-48	258	3	48	0.75	1.13	
L-AR-54	268	3	54	0.75	1.22	
L-AR-60	279	3	60	0.75	1.31	
Wall Mounted						
L-AR-24-W	222	3	24	0.75	0.77	
L-AR-30-W	230	3	30	0.75	0.86	
L-AR-36-W	237	3	36	0.75	0.95	
L-AR-42-W	249	3	42	0.75	1.04	
L-AR-48-W	258	3	48	0.75	1.13	
L-AR-54-W	268	3	54	0.75	1.22	
L-AR-60-W	279	3	60	0.75	1.31	

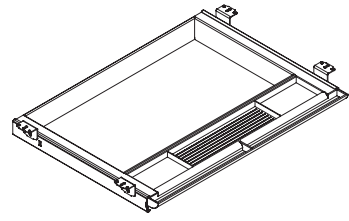

What's Included:

One (1) pencil tray

How to Specify:

Available in black only

Notes:

Available in black only

Dimensions:

Width: 24"

Depth: 16"

Code	Price	H	W	D	Weight (lb.)	Volume (ft ³)
V-ADPP	100	14	21	2	1.8	0.34