



Quick Ship USA Pricebook

January 2026

Caution	5
Statement of Line	6
Panels & Glass Blade	6
Storage	6
Worksurface & Supports	7
Connections & Trims	8
Electrics	9
Accessories	10
Fabrics	11
Laminates	12
Trims	13
Application Guidelines	14
Types of Surfaces	14
Types of Surfaces	14
Gallery Panel Planning	15
Connection Types - Fillers	16
Panels	18
standard panel - monolithic - fabric	20
non-powered	20
powered capable	22
gallery - solid	24
single span middle	24
single span end /no cutout	26
double span middle	28
double span end/no cutout	30
single span end /w cutout	32
double span end /w cutout	34
frameless blade	36
glass	36
gallery	37
vertical woodgrain	37
horizontal woodgrain	48
Connections & Trims	60
full height end trim	62
partial height end trim	63

full height t filler	64
partial height t filler	65
90 degree filler-full height	66
90 degree filler- partial height	67
partial height straight filler	68
adjustable wall connector	69
gallery panel filler	70
2-way connection	71
3-way t connection	72
4-way x connection	73
standard panel mount corner bracket	74
storage support bracket	75
Worksurface & Supports	76
straight worksurface w/o grommet	78
straight worksurface w grommet	82
straight worksurface w/ wire play	84
ladder gable	88
standard panel	88
gallery panel	90
lamineate gable	91
standard panel	91
gallery panel	92
freestanding	93
wrap lamineate gable	94
standard panel	94
gallery panel	95
storage support bracket	96
90 degree storage bracket	97
standard panel mounted cantilever arm	98
gallery panel mounted cantilever arm	99
flush plate	100

Storage	102
metal shelf	104
flipper cabinet	105
pedestals	106
underdesk pedestal	106
mobile	107
lateral file	108
Electrics	110
vertical wire manager	112
wire manager	113
starter harness	114
male to female extension harness	115
Chicago electrical box	116
New York junction box	117
desktop power module	118
power module	119
connector harness	120
communication kit	121
Accessories	122
keyboard tray	124
pencil drawer	125
LED tasklight	126
monitor arm	127
height adjustable base	128
straight	128
5 sided	129
task seating	130

Load Bottom Drawer First

- Operate one drawer at a time
- Units may tip if loaded incorrectly
- Units should be attached to a wall or other furniture to reduce tipping hazard
- Always load the heaviest files in the bottom drawer

Heavy Load

- Some products must be anchored to wall to ensure stability & safety.
- It is the owner and installers responsibility to ensure that the wall type and construction is of sufficient strength to carry the loads of any wall mounted products and their contents.
- Failure of the wall and anchors to support all imposed loads may result in property damage and/or personal injury.
- Tayco can provide size and empty weight of its products only. As wall blocking is considered a building construction process, Tayco cannot provide recommendations in this respect and cannot be responsible for damage or injury that may occur as a result of improper installation and/or blocking.

Instability Hazard

Mobile items on casters such as flip top, personal and movable tables of any type and storage items of any type may present an instability hazard if not secured correctly while in use or in storage. Flip top tables or training tables of any type, are inherently more unstable when folded. Tayco provides the following guidelines & warnings when using mobile products:

- Lock casters immediately after moving. Do not leave the casters unlocked when in use or in storage.
- Motion may increase the instability of any item with casters. If the wheels hit an obstruction the table's forward momentum often causes overturn, especially if the item is not equipped with wheel extensions. Exercise strong caution while moving these items.
- Use caution when abrupt level changes in the floor are present (such as a doorway or room threshold) as caster failure or tipping may result.
- Do not stand, sit or lean on mobile items for support. They are not intended for this use and personal injury or property damage may result.
- Mobile units that feature height adjustable elements must be lowered to the minimum compressed height when moving to prevent instability. It is also recommended the user remove all computer equipment or other accessories to prevent possible weight imbalance or damage to equipment.
- Failure to follow the guidelines above may result in property damage or personal injury.

Panels & Glass Blade

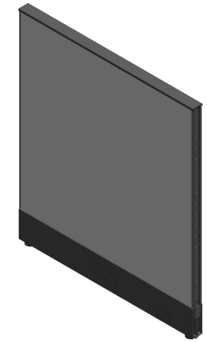

QL-PPFO
Standard Fabric Panel
H: 42", 50", 66", 82"
W: 24" - 60"
*66"H available up to 60"W
*82"H available up to 48"W

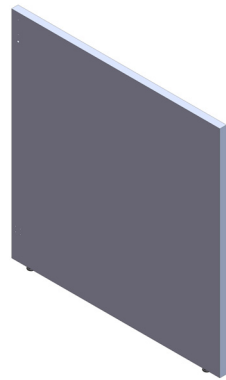

QL-PYSE-S1/ QL-PYSM-S1
Solid Single Gallery Panel
H: 42", 50"
W: 26" - 74"



QL-PYGE-S1/QL-PYSM-S1
Woodgrain Single Gallery Panel
H: 42", 50"
W: 26" - 56"

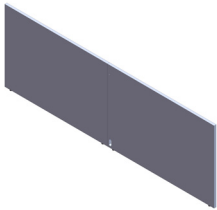

QL-PYSE-D1/D2/ QL-PYSM-D1/D2
Solid Double Gallery Panel
H: 42", 50"
W: 42" - 146"

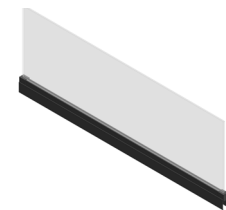

QL-VG-P
Frameless Frosted Glass Standard Panel Mount
H: 8"
W: 24" - 72"



QL-PYGE-01/02/ QL-PYGM-D1/D2
Woodgrain Double Gallery Panel
H: 42", 50"
W: 42" - 110"

Storage

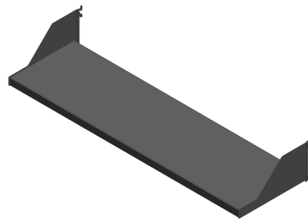

QL-S00M
Steel Shelf
H: 6"
W: 30" - 60"
D: 12"

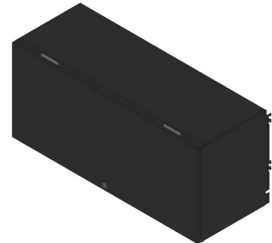

QL-SPFL/ QL-SPFM
Flipper Cabinet
H: 16"
W: 30" - 60"
D: 14"



QL-FL2U
2D Underdesk Lateral
H: 28"
W: 30", 36"
D: 23", 29"



QL-FPBU
BBF Underdesk Pedestal
H: 28"
W: 16"
D: 23", 29"



QL-FPFU
FF Underdesk Pedestal
H: 28"
W: 23", 29"



QL-FPLO
BF Mobile Pedestal
H: 21"
W: 16"
D: 18"

Worksurface & Supports



QL-WS00
Straight Worksurface
W: 24" - 96"
D: 20", 24", 30"



QL-WS00
Straight Worksurface with Cropped Depth
W: 23" - 96"
D: 19" - 30"



QL-WS0G
Straight Worksurface with Grommets
W: 24" - 96"
D: 20", 24", 30"



QL-HOEG/ QL-HOMG
Ladder Leg
H: 25", 28"
D: 20", 24", 30"



QL-HCEG
Laminate Gable Leg
H: 25", 28"
D: 20", 24", 30"



QL-HWEG
Wrap Gable
H: 25", 28"
D: 20", 24", 30"



QL-CCAB
Cantilever
H: 8"
D: 16", 22"



QL-HCB
Corner Bracket
H: 3"
W: 4"



QL-PWW
Mending Plate
D: 4"
W: 6"



QL-HSSB
Storage Support Bracket
H: 3"
D: 1"



QL-HPGP/ QL-HPSP
Pedestal to Panel Bracket
H: 28"
W: 1", 7"

Connections & Trims



QL-HETF
Standard End Trim
H: 34", 42", 50", 66", 82"
W: 2"



QL-HETP
End Trim (Partial)
H: 8", 16", 24", 32", 40", 48"
W: 2"

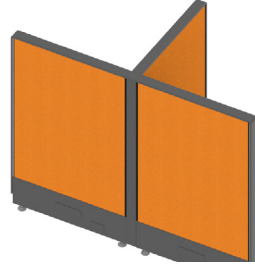

QL-HFTR
T Filler (Full)
H: 34", 42", 50", 66", 82"
W: 2"

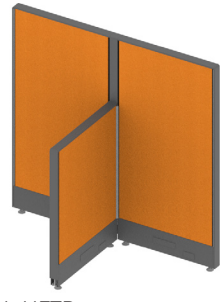

QL-HFTP
T Filler (Partial)
H: 8", 16", 24", 32", 40", 48"
W: 2"

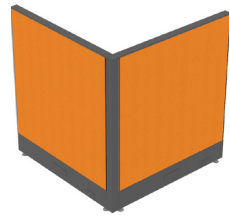

QL-HFNR
90 Degree Filler (Full)
H: 34", 42", 50", 66", 82"
W: 2"

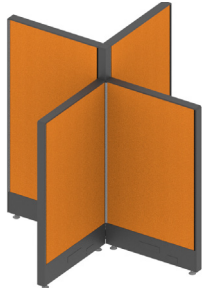

QL-HFNP
90 Degree Filler (Partial)
H: 8", 16", 24", 32", 40", 48"
W: 2"

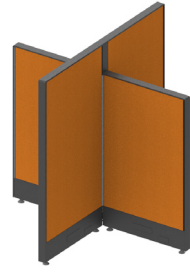

QL-HFSP
Strait Filler (Partial)
H: 8", 16", 24", 32", 40", 48"
W: 2"



QL-HW2/ QL-HW4/
QL-HW6
Wall Connector
H: 34", 42", 50", 66", 82"
W: 2", 4", 6"



QL-HYP
Gallery Panel Filler
H: 8", 16", 24", 32", 40",
48"
W: 1"



QL-HC2W-90-A
90 Degree A
Panel Connector



QL-HC2W-90-B
90 Degree B
Panel Connector



QL-HC2W-180-A
180 Degree A Panel
Connector

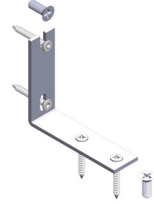

QL-HC2W-180-B
180 Degree B
Panel Connector



QL-HC3W-A
3 Way A Panel
Connector



QL-HC3W-B
3 Way B Panel
Connector



QL-HC3W-C
3 Way C Panel
Connector

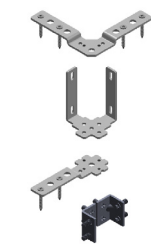

QL-HC3W-D
3 Way D Panel
Connector

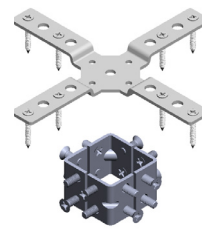

QL-HC4W-A
4 Way A Panel
Connector



QL-HC4W-B
4 Way B Panel
Connector

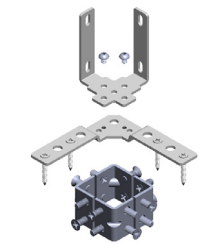

QL-HC4W-C
4 Way C Panel
Connector



QL-HC4W-D
4 Way D Panel
Connector

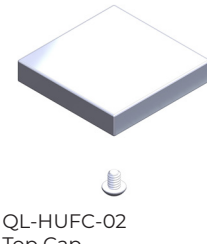

QL-HUFC-02
Top Cap
H: 2"
W: 2"

Electrics

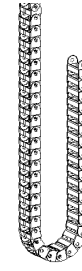

V-EE
E-Chain Wire Manager

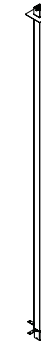

QL-EP-P/ QL-EP-Y
Wire Manager
3-way, 4-way, 90 degree
H: 120", 144"

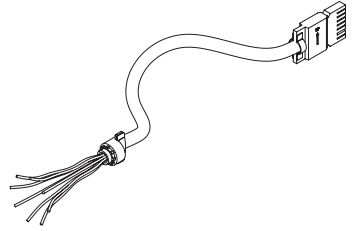

QL-ES84
Starter Harness
L: 72", 168"

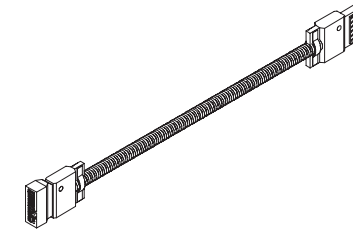

QL-E8FM
Male to Female Extension Harness
L: 44", 122"

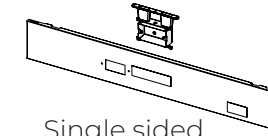

Single sided

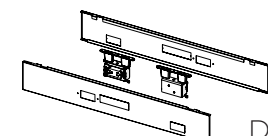

Double sided

QL-JBOX/ QL-NY84/QL-NYEJ
Junction Box, Single or Double Sided
W: 30"- 60"

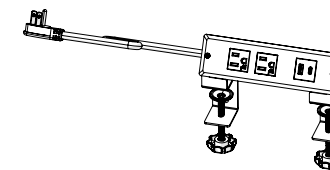

V-EMW
Clamp Mount Power Module

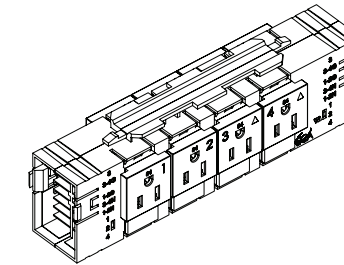

QL-EM84
Power Module

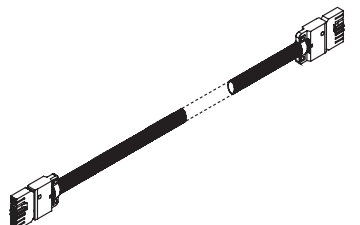

QL-EH84
Connector Harness
L: 22"-67"

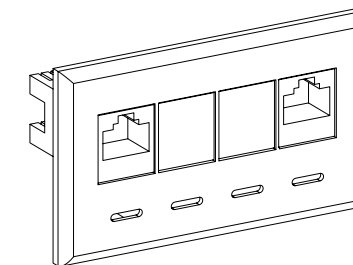

QL-ECK6
Communication Kit

type 6
RJ45/45

Accessories

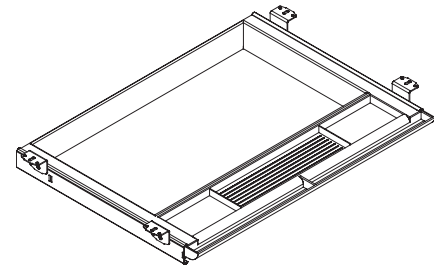

V-ADP
Plastic Pencil Drawer

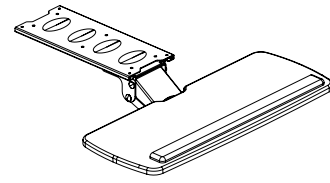

V-KASX
Articulating Keyboard Tray

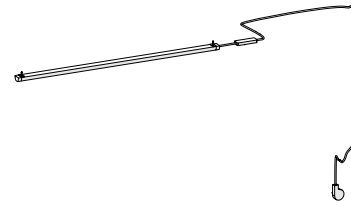

V-ELU
Halifax LED Light 30"

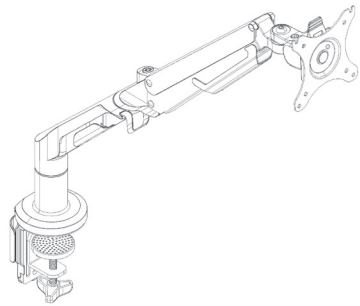

V-AFMA-01
Single Monitor Arm - clamp mount

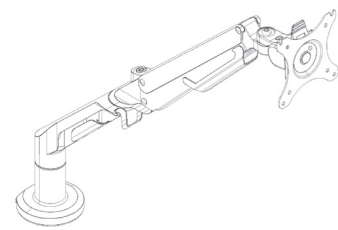

V-AFMA-01
Single Monitor Arm - grommet mount

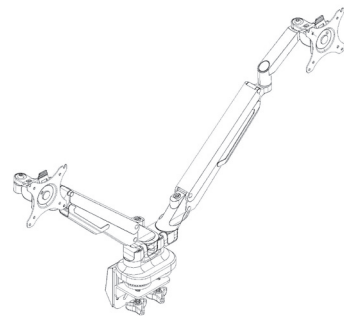

V-AFMA-02
Double Monitor Arm - clamp mount

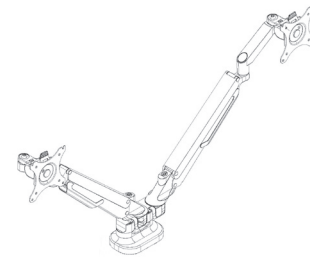

V-AFMA-02
Double Monitor Arm - grommet mount



R-HATB
Height Adjustable Base
W range: 40"-90"

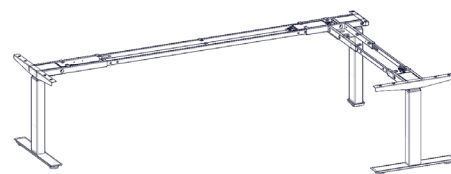

R-HA3B
5 Sided Base
W range: 46"-84"



J-MTCB
Task Seating
H: 39.25, W: 25.25", D: 25"

Fabrics

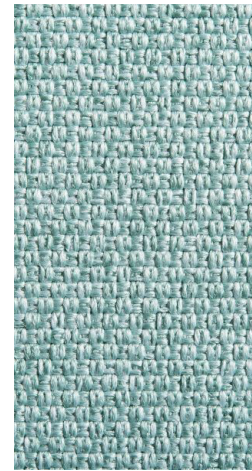

Seaside
Grade 1 - Ballo - F5191



Nightfall
Grade 1 - Ballo - F6161

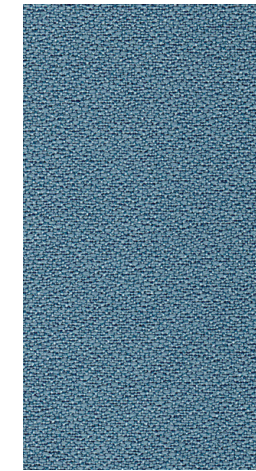

Fjord
Grade 1 - Commerce - F2181

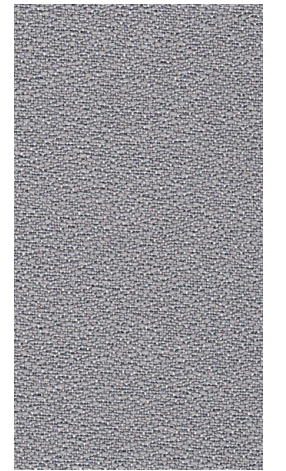

Grey
Grade 1 - Commerce - F2161

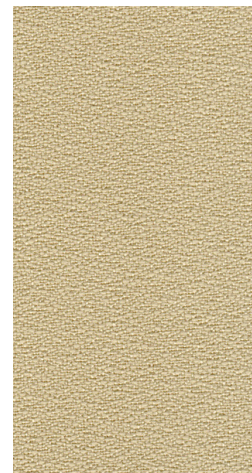

Slate
Grade 1 - Commerce - F2141



Steel Grey
Grade 1 - Commerce - F2171



Seed
Grade 1 - Reticolo - F4121

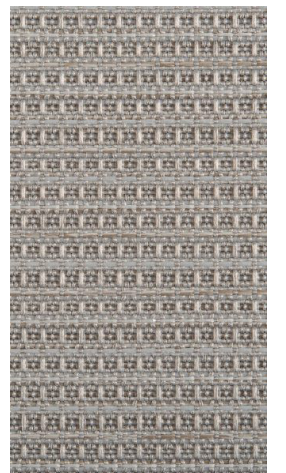

Stockinette
Grade 1 - Zapote - F4151

Laminates

Trims



Copa_Cabana
L133/V133



Fogo_Harbour
L165/V165

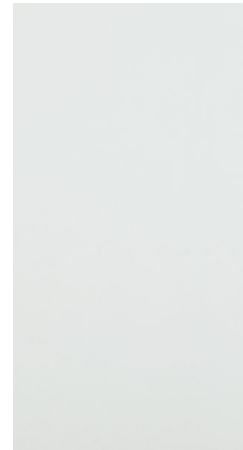

White
L121/V121



Megantic
L163/V163

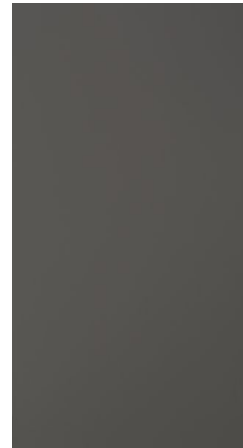

Moonlight
L164/V164



Sable_Island
L161/V161

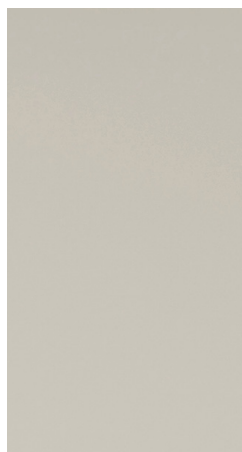

Summer_Drops
L154/V154



Tofino
L162/V162



Tuxedo
L132/V132

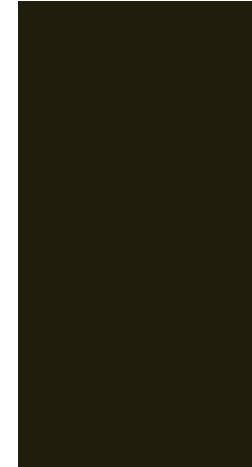

Black
P114



Charcoal
P139



Silver
P112

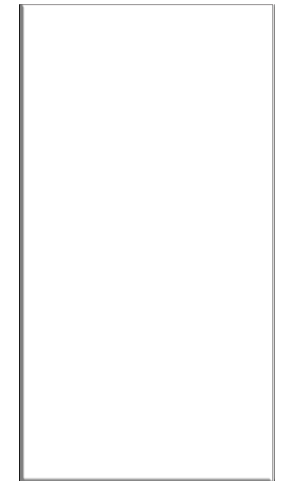

White
P121

Application Guidelines

Types of Surfaces

no grommet

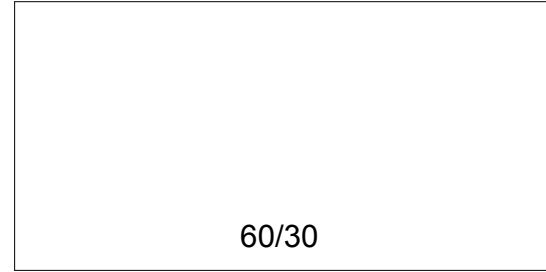
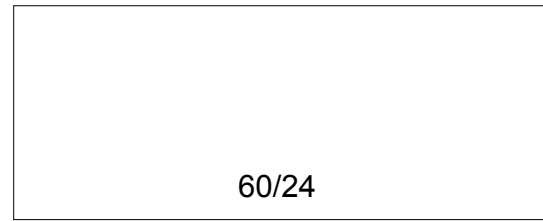

with grommet

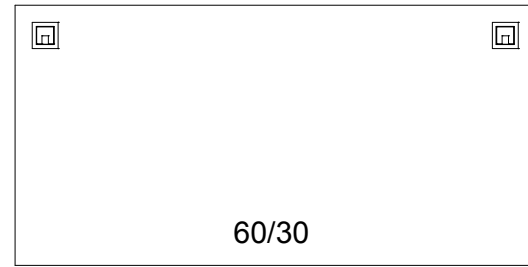
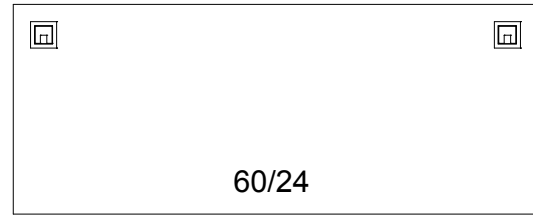

wireplay

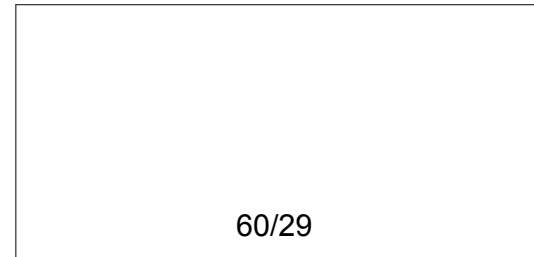
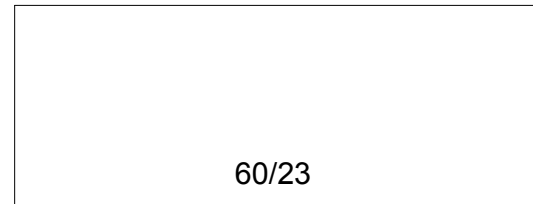

Gallery Panel Planning

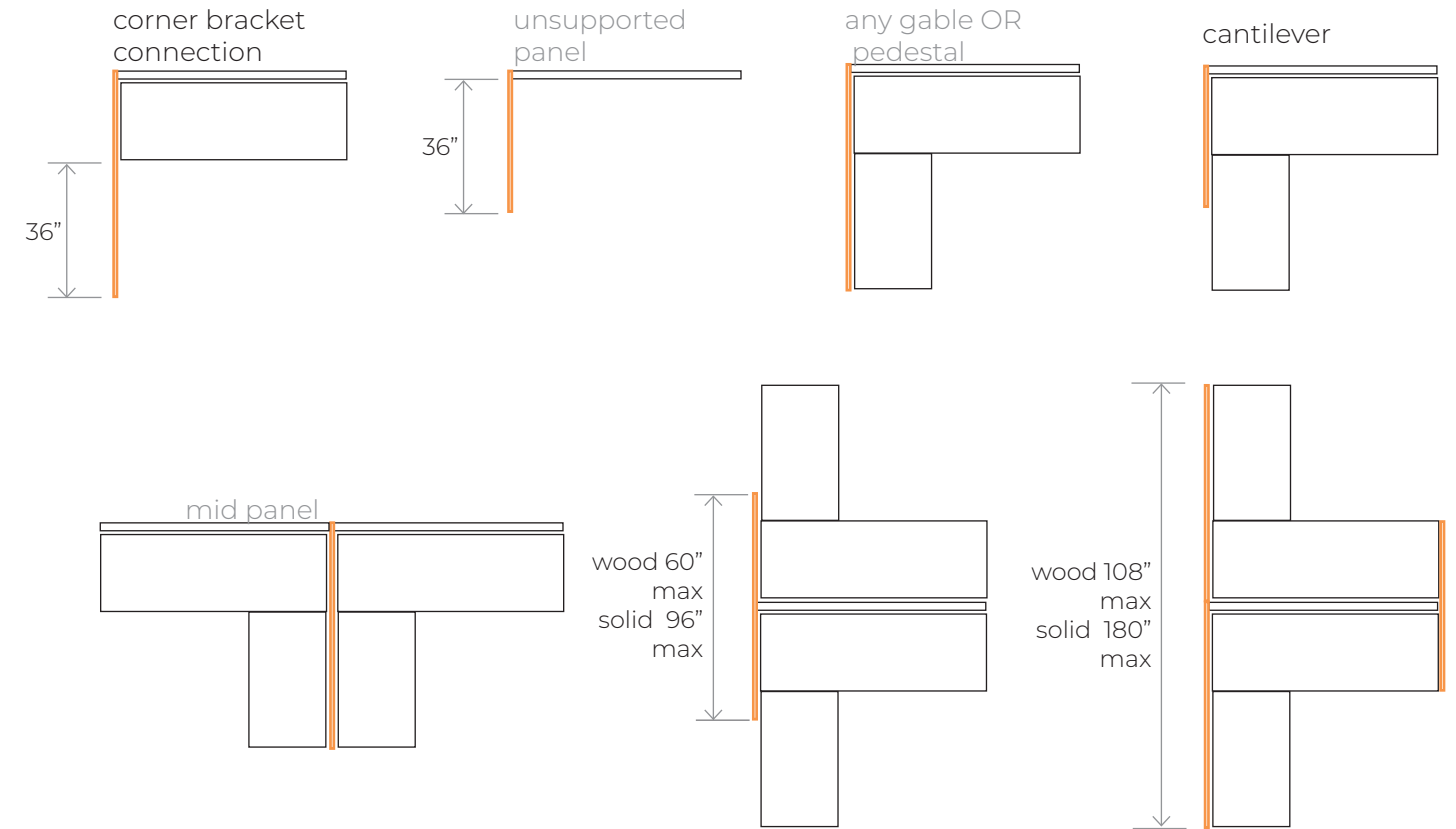

Connection Types - Fillers

2-Way 90° Connection

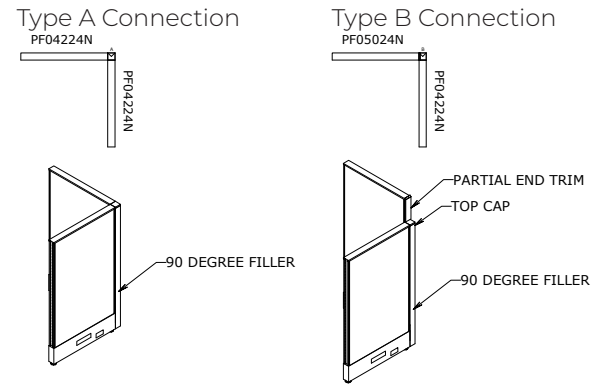

2-Way 180° Connection

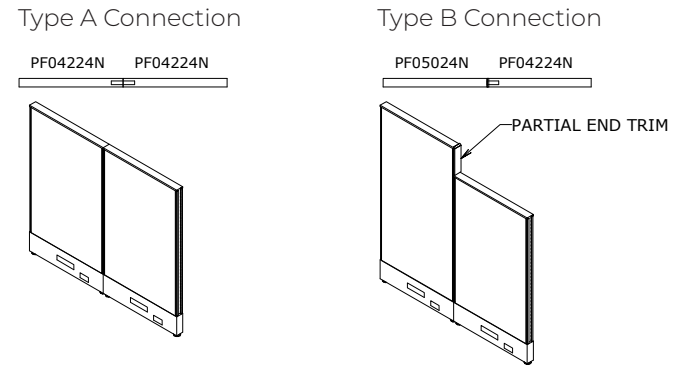

3-Way Connection

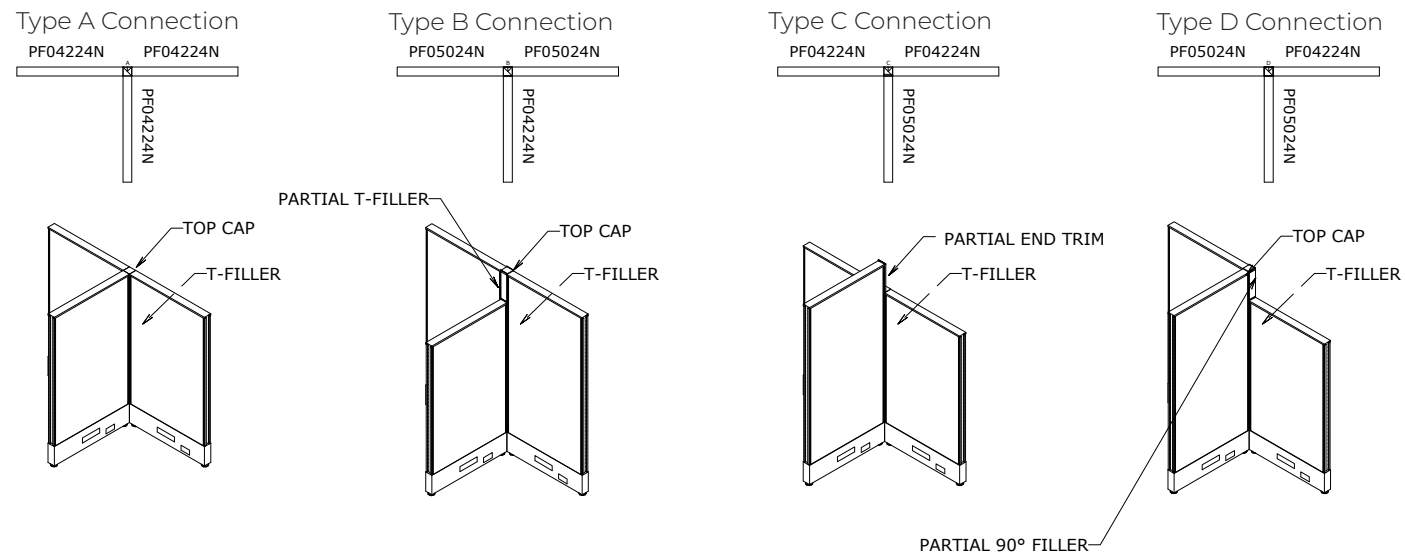

4-Way Connection

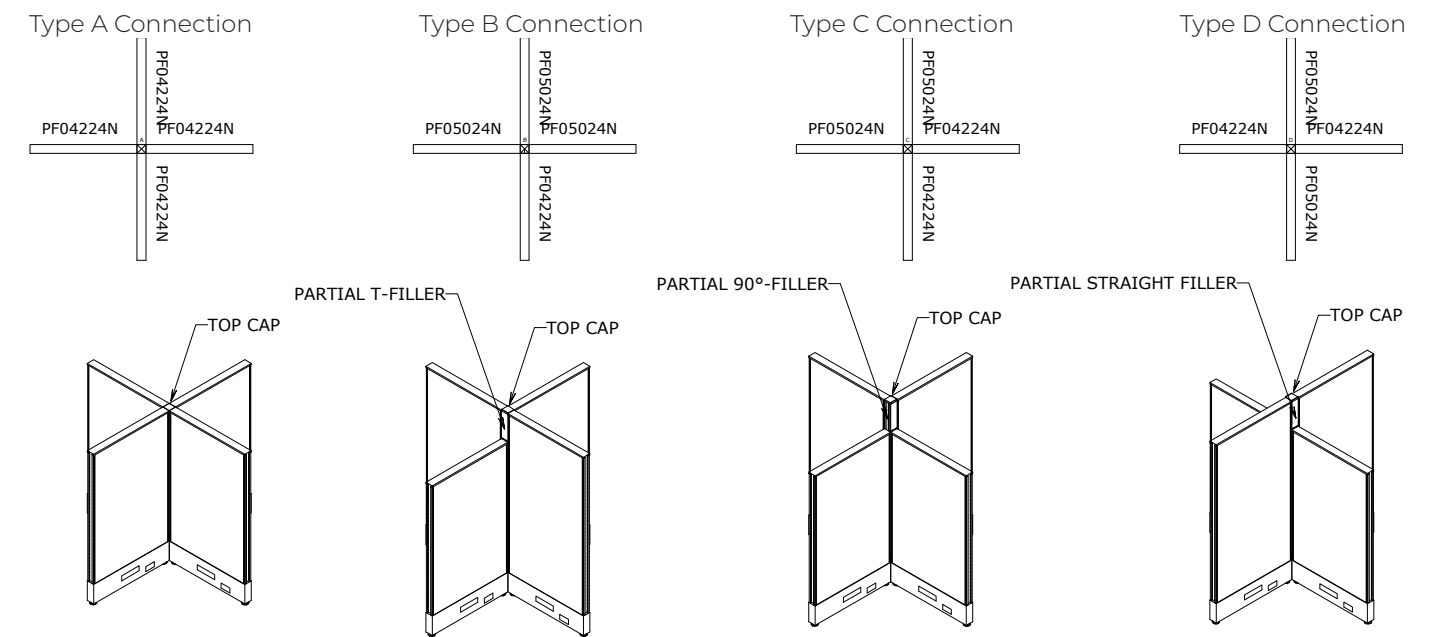



Quick Ship
USA Pricebook
January 2026
Panels

Panels

standard panel - monolithic	20
fabric	20
non powered	20
powered capable	22
gallery - solid	24
single span middle	24
single span end /no cutout	26
double span middle	28
double span end/no cutout	30
single span end /w cutout	32
double span end /w cutout	34
frameless blade	36
glass	36
gallery	37
vertical woodgrain	37
single span middle	37
double span middle	38
single span end /no cutout	40
double span end/no cutout	42
single span end /w cutout	44
double span end /w cutout	46
horizontal woodgrain	48
single span end/w cutout	48
double span end/w cutout	50
single span end /no cutout	52
double span end /no cutout	54
single span middle	56
double span middle	58

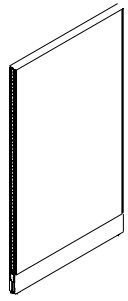

Standard Monolithic
Non-Powered Fabric Panel

What's Included:

One (1) 2" thick fabric panel with
1" incremented slotted channels,
Two (2) raceway covers,
One (1) top trim

How to Specify:

Refer to [page 11](#), Fabric Page for fabric
selections

Choose White, Black, Silver, Charcoal for Panel
Frame color

Options:

Height*: 42", 50", 66"

Width: 24", 30", 36", 42", 48", 54", 60"

Fabric

Metal Powder Coat Paint: White, Black, Silver, Charcoal

*34" high - 50" high available up to 72" wide, 66" high available up to 60" wide, 82" high available up to 48" wide

Notes:

Non-power capable panel.
Can be used in run with power-capable
panels and allows wires to pass through.
Panels are non tackable.

Code	Price	H	W	D	Weight (lb.)	Volume (ft ³)
QL-PPF0-4224-N	457	42	24	2	20.16	1.17
QL-PPF0-4230-N	493	42	30	2	25.20	1.46
QL-PPF0-4236-N	530	42	36	2	30.24	1.75
QL-PPF0-4242-N	566	42	42	2	35.28	2.04
QL-PPF0-4248-N	601	42	48	2	40.32	2.33
QL-PPF0-4254-N	637	42	54	2	45.36	2.63
QL-PPF0-4260-N	673	42	60	2	50.40	2.92
QL-PPF0-5024-N	493	50	24	2	24.00	1.39
QL-PPF0-5030-N	547	50	30	2	30.00	1.74
QL-PPF0-5036-N	601	50	36	2	36.00	2.08
QL-PPF0-5042-N	655	50	42	2	42.00	2.43
QL-PPF0-5048-N	710	50	48	2	48.00	2.78
QL-PPF0-5054-N	764	50	54	2	54.00	3.13
QL-PPF0-5060-N	814	50	60	2	60.00	3.47
QL-PPF0-6624-N	566	66	24	2	31.68	1.83
QL-PPF0-6630-N	629	66	30	2	39.60	2.29
QL-PPF0-6636-N	683	66	36	2	47.52	2.75
QL-PPF0-6642-N	737	66	42	2	55.44	3.21
QL-PPF0-6648-N	790	66	48	2	63.36	3.67
QL-PPF0-6654-N	862	66	54	2	71.28	4.13
QL-PPF0-6660-N	933	66	60	2	79.20	4.58

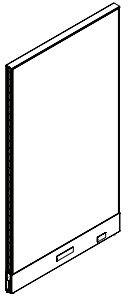

Standard Monolithic Powered Fabric Panel

What's Included:

One (1) 2" thick fabric panel with 1" incremented slotted channels, Two (2) raceway covers, One (1) top trim

How to Specify:

Refer to [page 11](#), Fabric Page for fabric selections

Choose White, Black, Silver, Charcoal for Panel Frame color

Notes:

Power capable panel with bracket for power module.

Power module must be specified separately.

Panels are non tackable.

Options:

Height*:	42", 50", 66
Width:	24", 30", 36", 42", 48", 54", 60"
Fabric	
Metal Powder Coat Paint:	White, Black, Silver, Charcoal

Code	Price	H	W	D	Weight (lb.)	Volume (ft ³)
QL-PPF0-4224-E	510	42	24	2	20.16	1.17
QL-PPF0-4230-E	547	42	30	2	25.20	1.46
QL-PPF0-4236-E	582	42	36	2	30.24	1.75
QL-PPF0-4242-E	621	42	42	2	35.28	2.04
QL-PPF0-4248-E	655	42	48	2	40.32	2.33
QL-PPF0-4254-E	692	42	54	2	45.36	2.63
QL-PPF0-4260-E	725	42	60	2	50.40	2.92
QL-PPF0-5024-E	547	50	24	2	24.00	1.39
QL-PPF0-5030-E	601	50	30	2	30.00	1.74
QL-PPF0-5036-E	655	50	36	2	36.00	2.08
QL-PPF0-5042-E	710	50	42	2	42.00	2.43
QL-PPF0-5048-E	764	50	48	2	48.00	2.78
QL-PPF0-5054-E	814	50	54	2	54.00	3.13
QL-PPF0-5060-E	868	50	60	2	60.00	3.47
QL-PPF0-6624-E	621	66	24	2	31.68	1.83
QL-PPF0-6630-E	683	66	30	2	39.60	2.29
QL-PPF0-6636-E	737	66	36	2	47.52	2.75
QL-PPF0-6642-E	790	66	42	2	55.44	3.21
QL-PPF0-6648-E	846	66	48	2	63.36	3.67
QL-PPF0-6654-E	916	66	54	2	71.28	4.13
QL-PPF0-6660-E	984	66	60	2	79.20	4.58

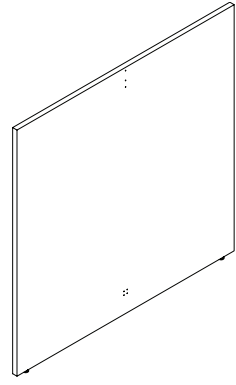

Single Span Middle
Solid Gallery Panel

What's Included:

One (1) 1"thick laminate gallery panel,
two (2) gallery panel top brackets

How to Specify:

Refer to [page 12](#), Laminate Page for laminate selections

Options:

Height: 42", 50"

Width: 26", 32", 38", 44", 50", 56", 62", 68", 74"

Laminate color

Notes:

Gallery panels come with pre-drilled holes on each side and bottom notch for wire routing

Gallery panels must be used between two standard fabric or laminate panels

Gallery panels must be the same height or lower than the connecting standard fabric or laminate panel

Code	Price	H	W	D	Weight (lb.)	Volume (ft ³)
QL-PYSM-4226-S1	358	42	26	1	21.84	0.63
QL-PYSM-4232-S1	399	42	32	1	26.88	0.78
QL-PYSM-4238-S1	438	42	38	1	31.92	0.92
QL-PYSM-4244-S1	480	42	44	1	36.96	1.07
QL-PYSM-4250-S1	521	42	50	1	42.00	1.22
QL-PYSM-4256-S1	556	42	56	1	47.04	1.36
QL-PYSM-4262-S1	598	42	62	1	52.08	1.51
QL-PYSM-4268-S1	639	42	68	1	57.12	1.65
QL-PYSM-4274-S1	682	42	74	1	62.16	1.80
QL-PYSM-5026-S1	396	50	26	1	26.00	0.75
QL-PYSM-5032-S1	439	50	32	1	32.00	0.93
QL-PYSM-5038-S1	485	50	38	1	38.00	1.10
QL-PYSM-5044-S1	536	50	44	1	44.00	1.27
QL-PYSM-5050-S1	581	50	50	1	50.00	1.45
QL-PYSM-5056-S1	630	50	56	1	56.00	1.62
QL-PYSM-5062-S1	678	50	62	1	62.00	1.79
QL-PYSM-5068-S1	720	50	68	1	68.00	1.97
QL-PYSM-5074-S1	771	50	74	1	74.00	2.14

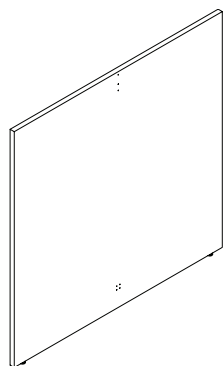

Single Span End Solid Gallery Panel

What's Included:

One (1) 1"thick laminate gallery panel, two (2) gallery panel top brackets

How to Specify:

Refer to [page 12](#), Laminate Page for laminate selections

Choose option for power cut out or no power cut out

Notes:

Gallery panels come with pre-drilled holes on each side and bottom notch for wire routing

Gallery panels must be used between two standard fabric or laminate panels

Gallery panels must be the same height or lower than the connecting standard fabric or laminate panel

Options:

Height: 42", 50"

Width: 26", 32", 38", 44", 50", 56", 62", 68", 74"

Laminate color

Power cut out, No power cut out

Code	Price	H	W	D	Weight (lb.)	Volume (ft ³)
left hand						
QL-PYSE-4226-S1L	311	42	26	1	21.84	0.63
QL-PYSE-4232-S1L	351	42	32	1	26.88	0.78
QL-PYSE-4238-S1L	391	42	38	1	31.92	0.92
QL-PYSE-4244-S1L	431	42	44	1	36.96	1.07
QL-PYSE-4250-S1L	473	42	50	1	42.00	1.22
QL-PYSE-4256-S1L	510	42	56	1	47.04	1.36
QL-PYSE-4262-S1L	552	42	62	1	52.08	1.51
QL-PYSE-4268-S1L	593	42	68	1	57.12	1.65
QL-PYSE-4274-S1L	634	42	74	1	62.16	1.80
QL-PYSE-5026-S1L	346	50	26	1	26.00	0.75
QL-PYSE-5032-S1L	396	50	32	1	32.00	0.93
QL-PYSE-5038-S1L	439	50	38	1	38.00	1.10
QL-PYSE-5044-S1L	486	50	44	1	44.00	1.27
QL-PYSE-5050-S1L	536	50	50	1	50.00	1.45
QL-PYSE-5056-S1L	582	50	56	1	56.00	1.62
QL-PYSE-5062-S1L	630	50	62	1	62.00	1.79
QL-PYSE-5068-S1L	678	50	68	1	68.00	1.97
QL-PYSE-5074-S1L	723	50	74	1	74.00	2.14
right hand						
QL-PYSE-4226-S1R	311	42	26	1	21.84	0.63
QL-PYSE-4232-S1R	351	42	32	1	26.88	0.78
QL-PYSE-4238-S1R	391	42	38	1	31.92	0.92
QL-PYSE-4244-S1R	431	42	44	1	36.96	1.07
QL-PYSE-4250-S1R	473	42	50	1	42.00	1.22
QL-PYSE-4256-S1R	510	42	56	1	47.04	1.36
QL-PYSE-4262-S1R	552	42	62	1	52.08	1.51
QL-PYSE-4268-S1R	593	42	68	1	57.12	1.65
QL-PYSE-4274-S1R	634	42	74	1	62.16	1.80
QL-PYSE-5026-S1R	346	50	26	1	26.00	0.75
QL-PYSE-5032-S1R	396	50	32	1	32.00	0.93
QL-PYSE-5038-S1R	439	50	38	1	38.00	1.10
QL-PYSE-5044-S1R	486	50	44	1	44.00	1.27
QL-PYSE-5050-S1R	536	50	50	1	50.00	1.45
QL-PYSE-5056-S1R	582	50	56	1	56.00	1.62
QL-PYSE-5062-S1R	630	50	62	1	62.00	1.79
QL-PYSE-5068-S1R	678	50	68	1	68.00	1.97
QL-PYSE-5074-S1R	723	50	74	1	74.00	2.14

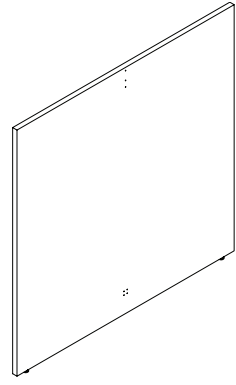

Single piece

Double Span Middle
Solid Gallery Panel

What's Included:

X"-X": One (1) 1"thick laminate gallery panel, two (2) gallery panel top brackets

X"-X": Two (2) 1"thick laminate gallery panel, four (4) gallery panel top brackets

How to Specify:

Refer to [page 12](#), Laminate Page for laminate selections

Notes:

Gallery panels come with pre-drilled holes on each side and bottom notch for wire routing

Gallery panels must be used between two standard fabric or laminate panels

Gallery panels must be the same height or lower than the connecting standard fabric or laminate panel

Options:

Height: 42", 50"

Width: 42", 50", 56", 62", 74", 86", 98", 110", 122", 134", 146"

Laminate color

Power cut out, no power cut out

Code	Price	H	W	D	Weight (lb.)	Volume (ft ³)
single piece						
QL-PYSM-4242-D1	465	42	42	1	35.28	1.02
QL-PYSM-4250-D1	521	42	50	1	42.00	1.22
QL-PYSM-4262-D1	598	42	62	1	52.08	1.51
QL-PYSM-4274-D1	682	42	74	1	62.16	1.80
QL-PYSM-4286-D1	761	42	86	1	72.24	2.09
QL-PYSM-5042-D1	521	50	42	1	42.00	1.22
QL-PYSM-5050-D1	581	50	50	1	50.00	1.45
QL-PYSM-5062-D1	678	50	62	1	62.00	1.79
QL-PYSM-5074-D1	771	50	74	1	74.00	2.14
QL-PYSM-5086-D1	865	50	86	1	86.00	2.49
2 pieces						
QL-PYSM-4298-D2	964	42	98	1	82.32	2.38
QL-PYSM-5098-D2	1089	50	98	1	98.00	2.84
QL-PYSM-42110-D2	1044	42	110	1	92.40	2.67
QL-PYSM-42122-D2	1123	42	122	1	102.48	2.97
QL-PYSM-42134-D2	1206	42	134	1	112.56	3.26
QL-PYSM-42146-D2	1287	42	146	1	122.64	3.55
QL-PYSM-50110-D2	1183	50	110	1	110.00	3.18
QL-PYSM-50122-D2	1277	50	122	1	122.00	3.53
QL-PYSM-50134-D2	1374	50	134	1	134.00	3.88
QL-PYSM-50146-D2	1468	50	146	1	146.00	4.22

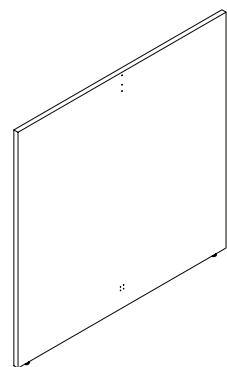

Single piece

Double Span End
Solid Gallery Panel
No Power Cutout

What's Included:

X"-X": One (1) 1"thick laminate gallery panel, two (2) gallery panel top brackets

X"-X": Two (2) 1"thick laminate gallery panel, four (4) gallery panel top brackets

How to Specify:

Refer to [page 12](#), Laminate Page for laminate selections

Choose option for power cut out or no power cut out

Options:

Height: 42", 50"

Width: 42", 50", 56", 62", 74", 86", 98", 110", 122", 134", 146"

Laminate color

Power cut out, no power cut out

Notes:

Gallery panels come with pre-drilled holes on each side and bottom notch for wire routing

Gallery panels must be used between two standard fabric or laminate panels

Gallery panels must be the same height or lower than the connecting standard fabric or laminate panel

Code	Price	H	W	D	Weight (lb.)	Volume (ft ³)
single piece						
QL-PYSE-4242-D1	421	42	42	1	35.28	1.02
QL-PYSE-4250-D1	473	42	50	1	42.00	1.22
QL-PYSE-4262-D1	552	42	62	1	52.08	1.51
QL-PYSE-4274-D1	634	42	74	1	62.16	1.80
QL-PYSE-4286-D1	713	42	86	1	72.24	2.09
QL-PYSE-5042-D1	473	50	42	1	42.00	1.22
QL-PYSE-5050-D1	536	50	50	1	50.00	1.45
QL-PYSE-5062-D1	630	50	62	1	62.00	1.79
QL-PYSE-5074-D1	723	50	74	1	74.00	2.14
QL-PYSE-5086-D1	820	50	86	1	86.00	2.49
2 pieces						
QL-PYSE-4298-D2	964	42	98	1	82.32	2.38
QL-PYSE-5098-D2	1089	50	98	1	98.00	2.84
QL-PYSE-42110-D2	1044	42	110	1	92.40	2.67
QL-PYSE-42122-D2	1123	42	122	1	102.48	2.97
QL-PYSE-42134-D2	1206	42	134	1	112.56	3.26
QL-PYSE-42146-D2	1287	42	146	1	122.64	3.55
QL-PYSE-50110-D2	1183	50	110	1	110.00	3.18
QL-PYSE-50122-D2	1277	50	122	1	122.00	3.53
QL-PYSE-50134-D2	1374	50	134	1	134.00	3.88
QL-PYSE-50146-D2	1468	50	146	1	146.00	4.22

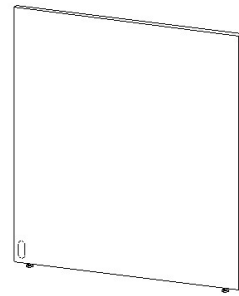

Single Span End Solid Gallery Panel with Power Cutout

What's Included:

One (1) 1"thick laminate gallery panel, two (2) gallery panel top brackets

How to Specify:

Refer to [page 12](#), Laminate Page for laminate selections

Choose option for power cut out or no power cut out

Options:

Height: 42", 50"

Width: 26", 32", 38", 44", 50", 56", 62", 68", 74"

Laminate color

Power cut out, No power cut out

Notes:

Gallery panels come with pre-drilled holes on each side and bottom notch for wire routing

Gallery panels must be used between two standard fabric or laminate panels

Gallery panels must be the same height or lower than the connecting standard fabric or laminate panel

Code	Price	H	W	D	Weight (lb.)	Volume (ft ³)
left hand						
QL-PCSE-4226-S1L	311	42	26	1	21.80	0.60
QL-PCSE-4232-S1L	351	42	32	1	26.90	0.80
QL-PCSE-4238-S1L	391	42	38	1	31.90	0.90
QL-PCSE-4244-S1L	431	42	44	1	37.00	1.10
QL-PCSE-4250-S1L	473	42	50	1	42.00	1.20
QL-PCSE-4256-S1L	510	42	56	1	47.00	1.40
QL-PCSE-4262-S1L	552	42	62	1	52.10	1.50
QL-PCSE-4268-S1L	593	42	68	1	57.10	1.70
QL-PCSE-4274-S1L	634	42	74	1	62.20	1.80
QL-PCSE-5026-S1L	346	50	26	1	26.00	0.80
QL-PCSE-5032-S1L	396	50	32	1	32.00	0.90
QL-PCSE-5038-S1L	439	50	38	1	38.00	1.10
QL-PCSE-5044-S1L	486	50	44	1	44.00	1.30
QL-PCSE-5050-S1L	536	50	50	1	50.00	1.40
QL-PCSE-5056-S1L	582	50	56	1	56.00	1.60
QL-PCSE-5062-S1L	630	50	62	1	62.00	1.80
QL-PCSE-5068-S1L	678	50	68	1	68.00	2.00
QL-PCSE-5074-S1L	723	50	74	1	74.00	2.10
right hand						
QL-PCSE-4226-S1R	311	42	26	1	21.80	0.60
QL-PCSE-4232-S1R	351	42	32	1	26.90	0.80
QL-PCSE-4238-S1R	391	42	38	1	31.90	0.90
QL-PCSE-4244-S1R	431	42	44	1	37.00	1.10
QL-PCSE-4250-S1R	473	42	50	1	42.00	1.20
QL-PCSE-4256-S1R	510	42	56	1	47.00	1.40
QL-PCSE-4262-S1R	552	42	62	1	52.10	1.50
QL-PCSE-4268-S1R	593	42	68	1	57.10	1.70
QL-PCSE-4274-S1R	634	42	74	1	62.20	1.80
QL-PCSE-5026-S1R	346	50	26	1	26.00	0.80
QL-PCSE-5032-S1R	396	50	32	1	32.00	0.90
QL-PCSE-5038-S1R	439	50	38	1	38.00	1.10
QL-PCSE-5044-S1R	486	50	44	1	44.00	1.30
QL-PCSE-5050-S1R	536	50	50	1	50.00	1.40
QL-PCSE-5056-S1R	582	50	56	1	56.00	1.60
QL-PCSE-5062-S1R	630	50	62	1	62.00	1.80
QL-PCSE-5068-S1R	678	50	68	1	68.00	2.00
QL-PCSE-5074-S1R	723	50	74	1	74.00	2.10

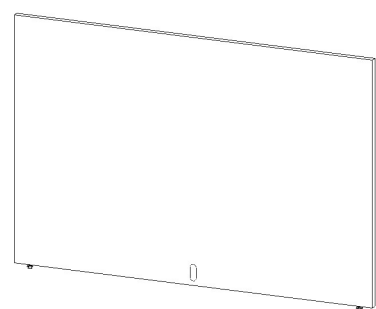

Single piece

Double Span End Solid Gallery Panel with Power Cutout

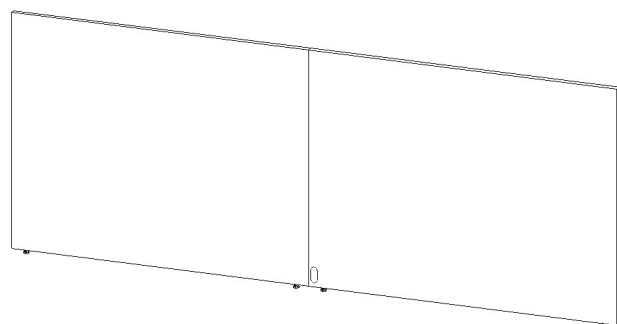

2 pieces

What's Included:

X"-X": One (1) 1"thick laminate gallery panel, two (2) gallery panel top brackets

X"-X": Two (2) 1"thick laminate gallery panel, four (4) gallery panel top brackets

How to Specify:

Refer to [page 12](#), Laminate Page for laminate selections

Choose option for power cut out or no power cut out

Options:

Height: 42", 50"

Width: 42", 50", 62", 74", 86", 98", 110", 122", 134", 146"

Laminate color

Power cut out, no power cut out

Notes:

Gallery panels come with pre-drilled holes on each side and bottom notch for wire routing

Gallery panels must be used between two standard fabric or laminate panels

Gallery panels must be the same height or lower than the connecting standard fabric or laminate panel

Code	Price	H	W	D	Weight (lb.)	Volume (ft ³)
single piece						
QL-PCSE-4242-D1	421	42	42	1	35.30	1.00
QL-PCSE-4250-D1	473	42	50	1	42.00	1.20
QL-PCSE-4262-D1	552	42	62	1	52.10	1.50
QL-PCSE-4274-D1	634	42	74	1	62.20	1.80
QL-PCSE-4286-D1	713	42	86	1	72.20	2.10
QL-PCSE-5042-D1	473	50	42	1	42.00	1.20
QL-PCSE-5050-D1	536	50	50	1	50.00	1.40
QL-PCSE-5062-D1	630	50	62	1	62.00	1.80
QL-PCSE-5074-D1	723	50	74	1	74.00	2.10
QL-PCSE-5086-D1	820	50	86	1	86.00	2.50
2 pieces						
QL-PCSE-4298-D2	964	42	98	1	91.10	2.60
QL-PCSE-42110-D2	1044	42	110	1	99.30	2.90
QL-PCSE-42122-D2	1123	42	122	1	92.40	2.70
QL-PCSE-42134-D2	1206	42	134	1	102.50	3.00
QL-PCSE-42146-D2	1287	42	146	1	112.60	3.30
QL-PCSE-5098-D2	1089	50	98	1	122.60	3.50
QL-PCSE-50110-D2	1183	50	110	1	110.00	3.20
QL-PCSE-50122-D2	1277	50	122	1	122.00	3.50
QL-PCSE-50134-D2	1374	50	134	1	134.00	3.90
QL-PCSE-50146-D2	1468	50	146	1	146.00	4.20

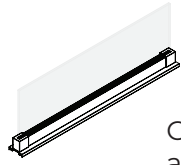

Glass Frameless Blade for Standard and Elevated Panels

Double span panel top mounted privacy screen can be placed across the width of two equal sized panels

What's Included:

One (1) tempered glass piece, One (1) channel extrusion, Two (2) end caps, One (1) top trim

How to Specify:

Refer to [page 13](#), Trims Page for metal finish options

Options:

Height: 8",
 Width: 24", 30", 36", 42", 48", 54", 60", 72"
 Frosted

Notes:

One (1) glass piece can span the width of one or two panels up to 72"W

Glass is tempered

Code	Price	H	W	D	Weight (lb.)	Volume (ft ³)
Glass screen - Frosted						
QL-VG-P-0824-F	699	8	24	1		
QL-VG-P-0830-F	739	8	30	1		
QL-VG-P-0836-F	809	8	36	1		
QL-VG-P-0842-F	867	8	42	1		
QL-VG-P-0848-F	875	8	48	1		
QL-VG-P-0854-F	944	8	54	1		
QL-VG-P-0860-F	952	8	60	1		
QL-VG-P-0872-F	1036	8	72	1		

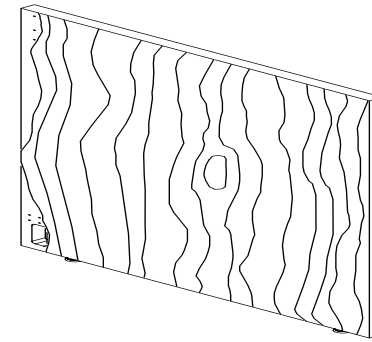

Single Span Middle Vertical Woodgrain Gallery Panel

What's Included:

One (1) 1" thick laminate gallery panel, two (2) gallery panel top brackets

How to Specify:

Refer to [page 12](#), Laminate Page for laminate selections

Options:

Height: 42", 50"
 Width: 26", 32", 38", 44", 50", 56"
 Laminate color

Notes:

Gallery panels come with pre-drilled holes on each side and bottom notch for wire routing

Gallery panels must be used between two standard fabric or laminate panels

Gallery panels must be the same height or lower than the connecting standard fabric or laminate panel

Code	Price	H	W	D	Weight (lb.)	Volume (ft ³)
QL-PYGM-4226-S1	358	42	26	1	21.84	0.63
QL-PYGM-4232-S1	399	42	32	1	26.88	0.78
QL-PYGM-4238-S1	438	42	38	1	31.92	0.92
QL-PYGM-4244-S1	480	42	44	1	36.96	1.07
QL-PYGM-4250-S1	521	42	50	1	42.00	1.22
QL-PYGM-4256-S1	556	42	56	1	47.04	1.36
QL-PYGM-5026-S1	396	50	26	1	26.00	0.75
QL-PYGM-5032-S1	439	50	32	1	32.00	0.93
QL-PYGM-5038-S1	485	50	38	1	38.00	1.10
QL-PYGM-5044-S1	536	50	44	1	44.00	1.27
QL-PYGM-5050-S1	581	50	50	1	50.00	1.45
QL-PYGM-5056-S1	630	50	56	1	56.00	1.62

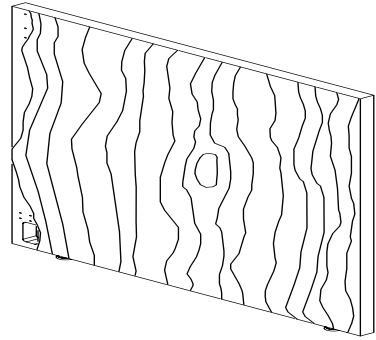

Double Span Middle
Vertical Woodgrain
Gallery Panel

What's Included:

X"-X": One (1) 1"thick laminate gallery panel, two (2) gallery panel top brackets

X"-X": Two (2) 1"thick laminate gallery panel, four (4) gallery panel top brackets

How to Specify:

Refer to [page 12](#), Laminate Page for laminate selections

Notes:

Gallery panels come with pre-drilled holes on each side and bottom notch for wire routing

Gallery panels must be used between two standard fabric or laminate panels

Gallery panels must be the same height or lower than the connecting standard fabric or laminate panel

Options:

Height: 42", 50"

Width: 42", 50", 62", 74", 86", 98", 110"

Laminate color

Code	Price	H	W	D	Weight (lb.)	Volume (ft ³)
single piece						
QL-PYGM-4242-D1	465	42	42	1	28.56	1.02
QL-PYGM-4250-D1	521	42	50	1	42.00	1.22
QL-PYGM-5042-D1	521	50	42	1	28.56	1.22
QL-PYGM-5050-D1	581	50	50	1	50.00	1.45
2 pieces						
QL-PYGM-4262-D2	720	42	62	1	52.08	1.51
QL-PYGM-4274-D2	804	42	74	1	62.16	1.80
QL-PYGM-4286-D2	883	42	86	1	72.24	2.09
QL-PYGM-4298-D2	964	42	98	1	82.32	2.38
QL-PYGM-5062-D2	806	50	62	1	62.00	1.79
QL-PYGM-5074-D2	897	50	74	1	74.00	2.14
QL-PYGM-5086-D2	993	50	86	1	86.00	2.49
QL-PYGM-5098-D2	1089	50	98	1	98.00	2.84
QL-PYGM-42110-D2	1044	42	110	1	92.40	2.67
QL-PYGM-50110-D2	1183	50	110	1	110.00	3.18

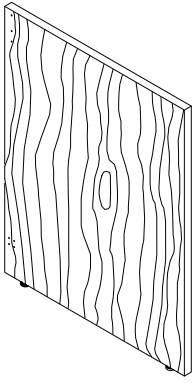

Single Span End
Vertical Woodgrain
Gallery Panel
No Power Cutout

What's Included:

One (1) 1"thick laminate gallery panel,
two (2) gallery panel top brackets

How to Specify:

Refer to [page 12](#), Laminate Page for laminate selections

Choose option for power cut out or no power cut out

Notes:

Gallery panels come with pre-drilled holes on each side and bottom notch for wire routing

Gallery panels must be used between two standard fabric or laminate panels

Gallery panels must be the same height or lower than the connecting standard fabric or laminate panel

Options:

Height: 42", 50"

Width: 26", 32", 38", 44", 50", 56"

Laminate color

Power cut out, No power cut out

Code	Price	H	W	D	Weight (lb.)	Volume (ft ³)
left hand						
QL-PYGE-4226-S1L	311	42	26	1	21.84	0.63
QL-PYGE-4232-S1L	351	42	32	1	26.88	0.78
QL-PYGE-4238-S1L	391	42	38	1	31.92	0.92
QL-PYGE-4244-S1L	431	42	44	1	36.96	1.07
QL-PYGE-4250-S1L	473	42	50	1	42.00	1.22
QL-PYGE-4256-S1L	510	42	56	1	47.04	1.36
QL-PYGE-5026-S1L	346	50	26	1	26.00	0.75
QL-PYGE-5032-S1L	396	50	32	1	32.00	0.93
QL-PYGE-5038-S1L	439	50	38	1	38.00	1.10
QL-PYGE-5044-S1L	486	50	44	1	44.00	1.27
QL-PYGE-5050-S1L	536	50	50	1	50.00	1.45
QL-PYGE-5056-S1L	582	50	56	1	56.00	1.62
right hand						
QL-PYGE-4226-S1R	311	42	26	1	21.84	0.63
QL-PYGE-4232-S1R	351	42	32	1	26.88	0.78
QL-PYGE-4238-S1R	391	42	38	1	31.92	0.92
QL-PYGE-4244-S1R	431	42	44	1	36.96	1.07
QL-PYGE-4250-S1R	473	42	50	1	42.00	1.22
QL-PYGE-4256-S1R	510	42	56	1	47.04	1.36
QL-PYGE-5026-S1R	346	50	26	1	26.00	0.75
QL-PYGE-5032-S1R	396	50	32	1	32.00	0.93
QL-PYGE-5038-S1R	439	50	38	1	38.00	1.10
QL-PYGE-5044-S1R	486	50	44	1	44.00	1.27
QL-PYGE-5050-S1R	536	50	50	1	50.00	1.45
QL-PYGE-5056-S1R	582	50	56	1	56.00	1.62

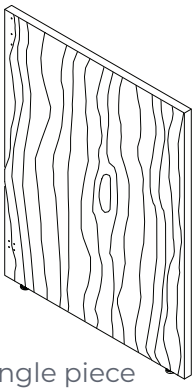

Double Span End
Vertical Woodgrain
Gallery Panel
No Power Cutout

Single piece

What's Included:

X"-X": One (1) 1"thick laminate gallery panel, two (2) gallery panel top brackets

X"-X": Two (2) 1"thick laminate gallery panel, four (4) gallery panel top brackets

How to Specify:

Refer to [page 12](#), Laminate Page for laminate selections

Choose option for power cut out or no power cut out

Options:

Height: 42", 50"

Width: 42", 50", 62", 74", 86", 98", 110"

Laminate color

Power cut out, no power cut out

Notes:

Gallery panels come with pre-drilled holes on each side and bottom notch for wire routing

Gallery panels must be used between two standard fabric or laminate panels

Gallery panels must be the same height or lower than the connecting standard fabric or laminate panel

Code	Price	H	W	D	Weight (lb.)	Volume (ft ³)
single piece						
QL-PYGE-4242-D1	421	42	42	1	28.56	1.02
QL-PYGE-4250-D1	473	42	50	1	42.00	1.22
QL-PYGE-5042-D1	473	50	42	1	28.56	1.22
QL-PYGE-5050-D1	536	50	50	1	50.00	1.45
2 pieces						
QL-PYGE-4262-D2	720	42	62	1	52.08	1.51
QL-PYGE-4274-D2	804	42	74	1	62.16	1.80
QL-PYGE-4286-D2	883	42	86	1	72.24	2.09
QL-PYGE-4298-D2	964	42	98	1	82.32	2.38
QL-PYGE-5062-D2	806	50	62	1	62.00	1.79
QL-PYGE-5074-D2	897	50	74	1	74.00	2.14
QL-PYGE-5086-D2	993	50	86	1	86.00	2.49
QL-PYGE-5098-D2	1089	50	98	1	98.00	2.84
QL-PYGE-42110-D2	1044	42	110	1	92.40	2.67
QL-PYGE-50110-D2	1183	50	110	1	110.00	3.18

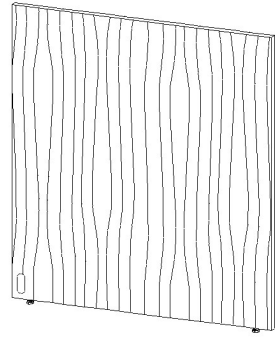

Single Span End
Vertical Woodgrain
Gallery Panel
with Power Cutout

What's Included:

One (1) 1"thick laminate gallery panel,
two (2) gallery panel top brackets

How to Specify:

Refer to [page 12](#), Laminate Page for laminate selections

Choose option for power cut out or no power cut out

Notes:

Gallery panels come with pre-drilled holes on each side and bottom notch for wire routing

Gallery panels must be used between two standard fabric or laminate panels

Gallery panels must be the same height or lower than the connecting standard fabric or laminate panel

Options:

Height: 42", 50"

Width: 26", 32", 38", 44", 50", 56"

Laminate color

Power cut out, No power cut out

Code	Price	H	W	D	Weight (lb.)	Volume (ft ³)
left hand						
QL-PCGE-4226-S1L	311	42	26	1	21.80	0.63
QL-PCGE-4232-S1L	351	42	32	1	26.90	0.78
QL-PCGE-4238-S1L	391	42	38	1	31.90	0.92
QL-PCGE-4244-S1L	431	42	44	1	37.00	1.07
QL-PCGE-4250-S1L	473	42	50	1	42.00	1.22
QL-PCGE-4256-S1L	510	42	56	1	47.00	1.36
QL-PCGE-5026-S1L	346	50	26	1	26.00	0.75
QL-PCGE-5032-S1L	396	50	32	1	32.00	0.93
QL-PCGE-5038-S1L	439	50	38	1	38.00	1.10
QL-PCGE-5044-S1L	486	50	44	1	44.00	1.27
QL-PCGE-5050-S1L	536	50	50	1	50.00	1.45
QL-PCGE-5056-S1L	582	50	56	1	56.00	1.62
right hand						
QL-PCGE-4226-S1R	311	42	26	1	21.80	0.63
QL-PCGE-4232-S1R	351	42	32	1	26.90	0.78
QL-PCGE-4238-S1R	391	42	38	1	31.90	0.92
QL-PCGE-4244-S1R	431	42	44	1	37.00	1.07
QL-PCGE-4250-S1R	473	42	50	1	42.00	1.22
QL-PCGE-4256-S1R	510	42	56	1	47.00	1.36
QL-PCGE-5026-S1R	346	50	26	1	26.00	0.75
QL-PCGE-5032-S1R	396	50	32	1	32.00	0.93
QL-PCGE-5038-S1R	439	50	38	1	38.00	1.10
QL-PCGE-5044-S1R	486	50	44	1	44.00	1.27
QL-PCGE-5050-S1R	536	50	50	1	50.00	1.45
QL-PCGE-5056-S1R	582	50	56	1	56.00	1.62

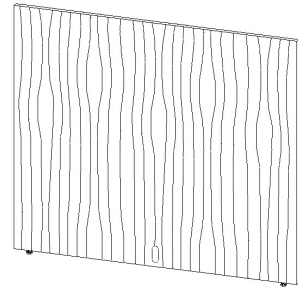

Single piece

Double Span End Vertical Woodgrain Gallery Panel with Power Cutout

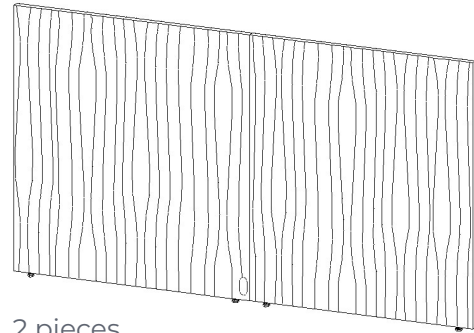

2 pieces

What's Included:

X"-X": One (1) 1"thick laminate gallery panel, two (2) gallery panel top brackets

X"-X": Two (2) 1"thick laminate gallery panel, four (4) gallery panel top brackets

How to Specify:

Refer to [page 12](#), Laminate Page for laminate selections

Choose option for power cut out or no power cut out

Options:

Height: 42", 50"

Width: 42", 50", 62", 74", 86", 98", 110"

Laminate color

Power cut out, no power cut out

Notes:

Gallery panels come with pre-drilled holes on each side and bottom notch for wire routing

Gallery panels must be used between two standard fabric or laminate panels

Gallery panels must be the same height or lower than the connecting standard fabric or laminate panel

Code	Price	H	W	D	Weight (lb.)	Volume (ft ³)
single piece						
QL-PCGE-4242-D1	421	42	42	1	28.60	1.02
QL-PCGE-4250-D1	473	42	50	1	42.00	1.22
QL-PCGE-5042-D1	473	50	42	1	28.60	1.22
QL-PCGE-5050-D1	536	50	50	1	50.00	1.45
2 pieces						
QL-PCGE-4262-D2	720	42	62	1	62.20	1.80
QL-PCGE-4274-D2	804	42	74	1	72.20	2.09
QL-PCGE-4286-D2	883	42	86	1	82.30	2.38
QL-PCGE-4298-D2	964	42	98	1	62.00	1.79
QL-PCGE-42110-D2	1044	42	110	1	74.00	2.14
QL-PCGE-5062-D2	806	50	62	1	86.00	2.49
QL-PCGE-5074-D2	897	50	74	1	98.00	2.84
QL-PCGE-5086-D2	993	50	86	1	74.80	2.16
QL-PCGE-5098-D2	1089	50	98	1	92.40	2.67
QL-PCGE-50110-D2	1183	50	110	1	110.00	3.18



Single Span End Horizontal Woodgrain Gallery Panel with Power Cutout

What's Included:

One (1) 1" thick laminate gallery panel, two (2) gallery panel top brackets

How to Specify:

Refer to [page 12](#), Laminate Page for laminate selections

Choose option for power cut out or no power cut out

Notes:

Gallery panels come with pre-drilled holes on each side and bottom notch for wire routing

Gallery panels must be used between two standard fabric or laminate panels

Gallery panels must be the same height or lower than the connecting standard fabric or laminate panel

Options:

Height: 42", 50"

Width: 26", 32", 38", 44", 50", 56", 62", 68", 74"

Laminate color

No power cut out

Code	Price	H	W	D	Weight (lb.)	Volume (ft ³)
left hand						
QL-PCHE-4226-S1L	311	42	26	1		
QL-PCHE-4232-S1L	351	42	32	1		
QL-PCHE-4238-S1L	391	42	38	1		
QL-PCHE-4244-S1L	431	42	44	1		
QL-PCHE-4250-S1L	473	42	50	1		
QL-PCHE-4256-S1L	510	42	56	1		
QL-PCHE-4262-S1L	552	42	62	1		
QL-PCHE-4268-S1L	593	42	68	1		
QL-PCHE-4274-S1L	634	42	74	1		
QL-PCHE-5026-S1L	346	50	26	1		
QL-PCHE-5032-S1L	396	50	32	1		
QL-PCHE-5038-S1L	439	50	38	1		
QL-PCHE-5044-S1L	486	50	44	1		
QL-PCHE-5050-S1L	536	50	50	1		
QL-PCHE-5056-S1L	582	50	56	1		
QL-PCHE-5062-S1L	630	50	62	1		
QL-PCHE-5068-S1L	678	50	68	1		
QL-PCHE-5074-S1L	723	50	74	1		
right hand						
QL-PCHE-4226-S1R	311	42	26	1		
QL-PCHE-4232-S1R	351	42	32	1		
QL-PCHE-4238-S1R	391	42	38	1		
QL-PCHE-4244-S1R	431	42	44	1		
QL-PCHE-4250-S1R	473	42	50	1		
QL-PCHE-4256-S1R	510	42	56	1		
QL-PCHE-4262-S1R	552	42	62	1		
QL-PCHE-4268-S1R	593	42	68	1		
QL-PCHE-4274-S1R	634	42	74	1		
QL-PCHE-5026-S1R	346	50	26	1		
QL-PCHE-5032-S1R	396	50	32	1		
QL-PCHE-5038-S1R	439	50	38	1		
QL-PCHE-5044-S1R	486	50	44	1		
QL-PCHE-5050-S1R	536	50	50	1		
QL-PCHE-5056-S1R	582	50	56	1		
QL-PCHE-5062-S1R	630	50	62	1		
QL-PCHE-5068-S1R	678	50	68	1		
QL-PCHE-5074-S1R	723	50	74	1		

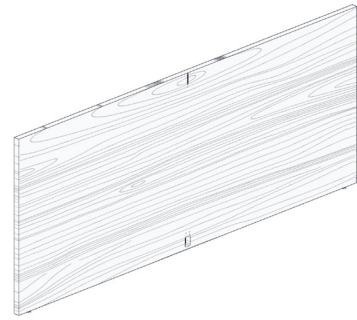

Single piece

Double Span End Horizontal Woodgrain Gallery Panel with Power Cutout

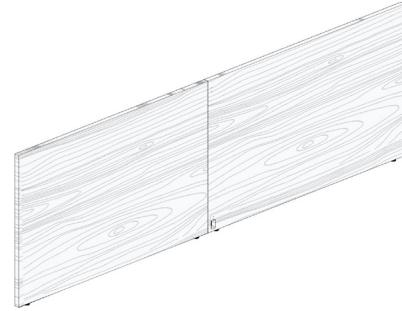

2 pieces

What's Included:

X"-X": One (1) 1"thick laminate gallery panel, two (2) gallery panel top brackets

X"-X": Two (2) 1"thick laminate gallery panel, four (4) gallery panel top brackets

How to Specify:

Refer to [page 12](#), Laminate Page for laminate selections

Choose option for power cut out or no power cut out

Notes:

Gallery panels come with pre-drilled holes on each side and bottom notch for wire routing

Gallery panels must be used between two standard fabric or laminate panels

Gallery panels must be the same height or lower than the connecting standard fabric or laminate panel

Options:

Height: 42", 50"

Width: 42", 50", 62", 74", 86", 98", 110", 122", 134", 146"

Laminate color

No power cut out

Code	Price	H	W	D	Weight (lb.)	Volume (ft ³)
single piece						
QL-PCHE-4242-D1	421	42	42	1		
QL-PCHE-4250-D1	473	42	50	1		
QL-PCHE-4262-D1	552	42	62	1		
QL-PCHE-4274-D1	634	42	74	1		
QL-PCHE-4286-D1	713	42	86	1		
QL-PCHE-5042-D1	473	50	42	1		
QL-PCHE-5050-D1	536	50	50	1		
QL-PCHE-5062-D1	630	50	62	1		
QL-PCHE-5074-D1	723	50	74	1		
QL-PCHE-5086-D1	820	50	86	1		
2 pieces						
QL-PCHE-4298-D2	964	42	98	1		
QL-PCHE-42110-D2	1044	42	110	1		
QL-PCHE-42122-D2	1123	42	122	1		
QL-PCHE-42134-D2	1206	42	134	1		
QL-PCHE-42146-D2	1287	42	146	1		
QL-PCHE-5098-D2	1089	50	98	1		
QL-PCHE-50110-D2	1183	50	110	1		
QL-PCHE-50122-D2	1277	50	122	1		
QL-PCHE-50134-D2	1374	50	134	1		
QL-PCHE-50146-D2	1468	50	146	1		



Single Span End Horizontal Woodgrain Gallery Panel No Power Cutout

What's Included:

One (1) 1" thick laminate gallery panel, two (2) gallery panel top brackets

How to Specify:

Refer to [page 12](#), Laminate Page for laminate selections

Choose option for power cut out or no power cut out

Options:

Height: 42", 50"

Width: 26", 32", 38", 44", 50", 56", 62", 68", 74"

Laminate color

Power cut out, no power cut out

Notes:

Gallery panels come with pre-drilled holes on each side and bottom notch for wire routing

Gallery panels must be used between two standard fabric or laminate panels

Gallery panels must be the same height or lower than the connecting standard fabric or laminate panel

Code	Price	H	W	D	Weight (lb.)	Volume (ft ³)
left hand						
QL-PYHE-4226-S1L	311	42	26	2		
QL-PYHE-4232-S1L	351	42	32	2		
QL-PYHE-4238-S1L	391	42	38	2		
QL-PYHE-4244-S1L	431	42	44	2		
QL-PYHE-4250-S1L	473	42	50	2		
QL-PYHE-4256-S1L	510	42	56	2		
QL-PYHE-4262-S1L	552	42	62	2		
QL-PYHE-4268-S1L	593	42	68	2		
QL-PYHE-4274-S1L	634	42	74	2		
QL-PYHE-5026-S1L	346	50	26	2		
QL-PYHE-5032-S1L	396	50	32	2		
QL-PYHE-5038-S1L	439	50	38	2		
QL-PYHE-5044-S1L	486	50	44	2		
QL-PYHE-5050-S1L	536	50	50	2		
QL-PYHE-5056-S1L	582	50	56	2		
QL-PYHE-5062-S1L	630	50	62	2		
QL-PYHE-5068-S1L	678	50	68	2		
QL-PYHE-5074-S1L	723	50	74	2		
right hand						
QL-PYHE-4226-S1R	311	42	26	2		
QL-PYHE-4232-S1R	351	42	32	2		
QL-PYHE-4238-S1R	391	42	38	2		
QL-PYHE-4244-S1R	431	42	44	2		
QL-PYHE-4250-S1R	473	42	50	2		
QL-PYHE-4256-S1R	510	42	56	2		
QL-PYHE-4262-S1R	552	42	62	2		
QL-PYHE-4268-S1R	593	42	68	2		
QL-PYHE-4274-S1R	634	42	74	2		
QL-PYHE-5026-S1R	346	50	26	2		
QL-PYHE-5032-S1R	396	50	32	2		
QL-PYHE-5038-S1R	439	50	38	2		
QL-PYHE-5044-S1R	486	50	44	2		
QL-PYHE-5050-S1R	536	50	50	2		
QL-PYHE-5056-S1R	582	50	56	2		
QL-PYHE-5062-S1R	630	50	62	2		
QL-PYHE-5068-S1R	678	50	68	2		
QL-PYHE-5074-S1R	723	50	74	2		



Single piece
Double Span End
Horizontal Woodgrain
Gallery Panel
No Power Cutout



Two pieces
Double Span End
Horizontal Woodgrain
Gallery Panel
No Power Cutout

What's Included:

- X"-X": One (1) 1"thick laminate gallery panel, two (2) gallery panel top brackets
- X"-X": Two (2) 1"thick laminate gallery panel, four (4) gallery panel top brackets

How to Specify:

Refer to [page 12](#), Laminate Page for laminate selections

Choose option for power cut out or no power cut out

Notes:

- Gallery panels come with pre-drilled holes on each side and bottom notch for wire routing
- Gallery panels must be used between two standard fabric or laminate panels
- Gallery panels must be the same height or lower than the connecting standard fabric or laminate panel

Options:

Height:

Width:

Laminate color

Power cut out, no power cut out

Code	Price	H	W	D	Weight (lb.)	Volume (ft ³)
single piece						
QL-PYHE-4242-D1	421	42	42	2		
QL-PYHE-4250-D1	473	42	50	2		
QL-PYHE-4262-D1	552	42	62	2		
QL-PYHE-4274-D1	634	42	74	2		
QL-PYHE-4286-D1	713	42	86	2		
QL-PYHE-5042-D1	473	50	42	2		
QL-PYHE-5050-D1	536	50	50	2		
QL-PYHE-5062-D1	630	50	62	2		
QL-PYHE-5074-D1	723	50	74	2		
QL-PYHE-5086-D1	820	50	86	2		
2 pieces						
QL-PYHE-4298-D2	204	42	98	2		
QL-PYHE-5098-D2	964	50	98	2		
QL-PYHE-42110-D2	1089	42	110	2		
QL-PYHE-42122-D2	1044	42	122	2		
QL-PYHE-42134-D2	1123	42	134	2		
QL-PYHE-42146-D2	1206	42	146	2		
QL-PYHE-50110-D2	1287	50	110	2		
QL-PYHE-50122-D2	1183	50	122	2		
QL-PYHE-50134-D2	1277	50	134	2		
QL-PYHE-50146-D2	1374	50	146	2		

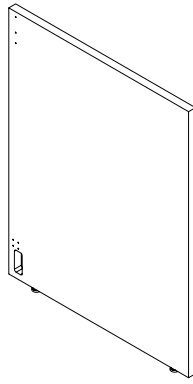

Single Span Middle
Horizontal Woodgrain
Gallery Panel

What's Included:

One (1) 1" thick laminate gallery panel, two (2) gallery panel top brackets

How to Specify:

Refer to [page 12](#), Laminate Page for laminate selections

Notes:

Gallery panels come with pre-drilled holes on each side and bottom notch for wire routing

Gallery panels must be used between two standard fabric or laminate panels

Gallery panels must be the same height or lower than the connecting standard fabric or laminate panel

Options:

Height: 42", 50"

Width: 26", 32", 38", 44", 50", 56", 62", 68", 74"

Laminate color

Code	Price	H	W	D	Weight (lb.)	Volume (ft ³)
QL-PYHM-4226-S1	358	42	26	2		
QL-PYHM-4232-S1	399	42	32	2		
QL-PYHM-4238-S1	438	42	38	2		
QL-PYHM-4244-S1	480	42	44	2		
QL-PYHM-4250-S1	521	42	50	2		
QL-PYHM-4256-S1	556	42	50	2		
QL-PYHM-4262-S1	598	42	62	2		
QL-PYHM-4268-S1	639	42	68	2		
QL-PYHM-4274-S1	682	42	74	2		
QL-PYHM-5026-S1	396	50	26	2		
QL-PYHM-5032-S1	439	50	32	2		
QL-PYHM-5038-S1	485	50	38	2		
QL-PYHM-5044-S1	536	50	44	2		
QL-PYHM-5050-S1	581	50	50	2		
QL-PYHM-5056-S1	630	50	50	2		
QL-PYHM-5062-S1	678	50	62	2		
QL-PYHM-5068-S1	720	50	68	2		
QL-PYHM-5074-S1	771	50	74	2		

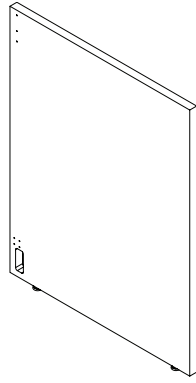

Double Span Middle
Horizontal Woodgrain
Gallery Panel

What's Included:

- X"-X": One (1) 1"thick laminate gallery panel, two (2) gallery panel top brackets
- X"-X": Two (2) 1"thick laminate gallery panel, four (4) gallery panel top brackets

How to Specify:

Refer to [page 12](#), Laminate Page for laminate selections

Notes:

- Gallery panels come with pre-drilled holes on each side and bottom notch for wire routing
- Gallery panels must be used between two standard fabric or laminate panels
- Gallery panels must be the same height or lower than the connecting standard fabric or laminate panel

Options:

Height:	42", 50"
Width:	42", 50", 62", 74", 86", 98", 110", 122", 134", 146"
Laminate color	

Code	Price	H	W	D	Weight (lb.)	Volume (ft ³)
1 Piece						
QL-PYHM-4242-D1	465	42	42	2		
QL-PYHM-4250-D1	521	42	50	2		
QL-PYHM-4262-D1	598	42	62	2		
QL-PYHM-4274-D1	682	42	74	2		
QL-PYHM-4286-D1	761	42	86	2		
QL-PYHM-5042-D1	521	50	42	2		
QL-PYHM-5050-D1	581	50	50	2		
QL-PYHM-5062-D1	678	50	62	2		
QL-PYHM-5074-D1	771	50	74	2		
QL-PYHM-5086-D1	865	50	86	2		
2 Pieces						
QL-PYHM-4298-D2	964	42	98	2		
QL-PYHM-5098-D2	1089	50	98	2		
QL-PYHM-42110-D2	1044	42	110	2		
QL-PYHM-42122-D2	1123	42	122	2		
QL-PYHM-42134-D2	1206	42	134	2		
QL-PYHM-42146-D2	1287	42	146	2		
QL-PYHM-50110-D2	1183	50	110	2		
QL-PYHM-50122-D2	1277	50	122	2		
QL-PYHM-50134-D2	1374	50	134	2		
QL-PYHM-50146-D2	1468	50	146	2		



Quick Ship
USA Pricebook
January 2026
**Connections
& Trims**

Connections & Trims

full height end trim	62
partial height end trim	63
full height t filler	64
partial height t filler	65
90 degree filler-full height	66
90 degree filler- partial height	67
partial height straight filler	68
adjustable wall connector	69
gallery panel filler	70
2-way connection	71
3-way t connection	72
4-way x connection	73
standard panel mount corner bracket	74
storage support bracket	75

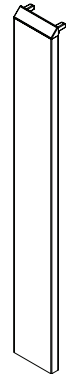

Full Height End Trim

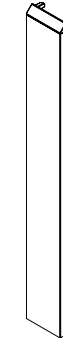

Partial Height End Trim

What's Included:

One (1) Full Height End Trim

How to Specify:

Choose White, Black, Silver, Charcoal for Full Height End Trim Color

Notes:

Options:

Height: 42", 50", 66"

Width: 2"

Standard

Code	Price	H	W	D	Weight (lb.)	Volume (ft ³)
QL-HETF-42	73	42	2	1	0.84	0.05
QL-HETF-50	85	50	2	1	1.00	0.06
QL-HETF-66	102	66	2	1	1.32	0.08

What's Included:

One (1) Partial Height End Trim

How to Specify:

Choose White, Black, Silver, Charcoal for Partial Height End Trim Color

Notes:

Options:

Height: 8", 16", 24"

Width: 2"

Code	Price	H	W	D	Weight (lb.)	Volume (ft ³)
QL-HETP-08	50	8	2	1	0.16	0.01
QL-HETP-16	56	16	2	1	0.32	0.02
QL-HETP-24	73	24	2	1	0.48	0.03



Full Height T Filler

What's Included:

One (1) Full Height T Filler

How to Specify:

Choose White, Black, Silver, Charcoal for Full Height T Filler

Notes:

Options:

Height: 42", 50", 66", 82"
 Width: 2"

Code	Price	H	W	D	Weight (lb.)	Volume (ft ³)
QL-HFTR-42	223	42	2	1	0.84	0.05
QL-HFTR-50	231	50	2	1	1.00	0.06
QL-HFTR-66	231	66	2	1	1.32	0.08



Partial Height T Filler

What's Included:

One (1) Partial Height T Filler

How to Specify:

Choose White, Black, Silver, Charcoal for Partial Height T Filler

Notes:

Options:

Height: 8", 16", 24"
 Width: 2"

Code	Price	H	W	D	Weight (lb.)	Volume (ft ³)
QL-HFTP-08	170	8	2	1	0.16	0.01
QL-HFTP-16	170	16	2	1	0.32	0.02
QL-HFTP-24	179	24	2	1	0.48	0.03



Full Height 90 Degree Filler

What's Included:

One (1) Full Height 90 Degree Filler

How to Specify:

Choose White, Black, Silver, Charcoal for Full Height 90 Degree Filler

Notes:

Options:

Height: 42", 50", 66"

Width: 2"

Code	Price	H	W	D	Weight (lb.)	Volume (ft ³)
QL-HFNR-42	194	42	2	1	0.72	0.05
QL-HFNR-50	206	50	2	1	1.00	0.06
QL-HFNR-66	221	66	2	1	1.32	0.08



Partial Height 90 Degree Filler

What's Included:

One (1) Partial Height 90 Degree Filler

How to Specify:

Choose White, Black, Silver, Charcoal for Partial Height 90 Degree Filler

Notes:

Options:

Height: 8", 16", 24"

Width: 2"

Code	Price	H	W	D	Weight (lb.)	Volume (ft ³)
QL-HFNP-08	75	8	2	1	0.16	0.01
QL-HFNP-16	131	16	2	1	0.32	0.02
QL-HFNP-24	143	24	2	1	0.48	0.03

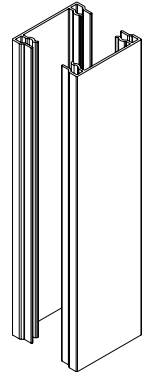

Partial Height Straight Filler

What's Included:

Partial Height Straight Filler

How to Specify:

Choose White, Black, Silver, Charcoal for Partial Height Straight Filler

Notes:

Options:

Height:	8", 16", 24"
Width:	2"

Code	Price	H	W	D	Weight (lb.)	Volume (ft ³)
QL-HFSP-08	56	8	2	1	0.16	0.01
QL-HFSP-16	95	16	2	1	0.32	0.02
QL-HFSP-24	104	24	2	1	0.48	0.03



138



mount 4



mount 6

Code	Price	H	W	D	Weight (lb.)	Volume (ft ³)
mount 2						
QL-HW2-42	187	42	2	2	1.68	0.10
QL-HW2-50	219	50	2	2	2.00	0.12
QL-HW2-66	270	66	2	2	2.64	0.15
mount 4						
QL-HW4-42	210	42	2	4	3.36	0.19
QL-HW4-50	237	50	2	4	4.00	0.23
QL-HW4-66	294	66	2	4	5.28	0.31
mount 6						
QL-HW6-42	231	42	2	6	5.04	0.29
QL-HW6-50	259	50	2	6	6.00	0.35
QL-HW6-66	313	66	2	6	7.92	0.46

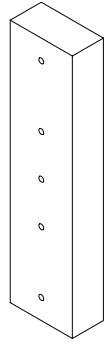

Partial Height Gallery Panel Filler

What's Included:

One (1) Partial Height Gallery Panel Filler

How to Specify:

Gallery Panel Filler matches laminate finish chosen on Gallery Panel

Options:

Height:	8", 16", 24", 32", 40", 48"
Width:	2"
Thickness:	1"

Notes:

Code	Price	H	W	D	Weight (lb.)	Volume (ft ³)
QL-HYP-08	87	8	1	1	0.08	0.00
QL-HYP-16	93	16	1	1	0.16	0.01
QL-HYP-24	117	24	1	1	0.24	0.01

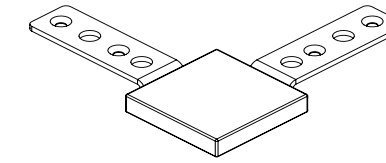

2-Way 90 degree Connection

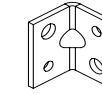

What's Included:

One (1) type A or type B straight or 90 degree connection bracket, accompanying screws

How to Specify:

Refer to [page 15](#) for connection type application guide

Code	Price	H	W	D	Weight (lb.)	Volume (ft ³)
2-Way Straight Connection						
QL-HC2W-180-A	24	1	2	3	0.02	0.00
QL-HC2W-180-B	21	1	2	3	0.02	0.00
2-Way 90 degree Connection						
QL-HC2W-90-A	56	1	2	3	0.02	0.00
QL-HC2W-90-B	56	1	2	3	0.02	0.00

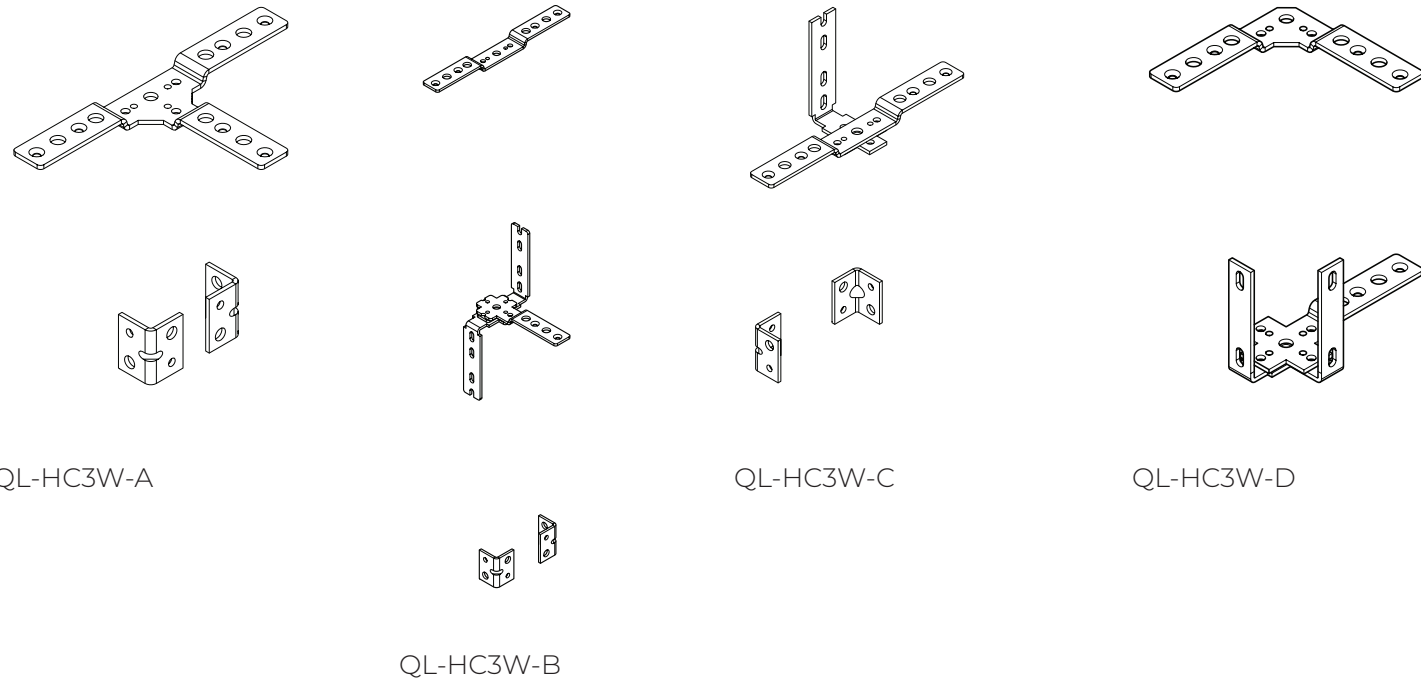

QL-HC3W-A

QL-HC3W-C

QL-HC3W-D

QL-HC3W-B

What's Included:

One (1) type A or type B straight or 90 degree connection bracket, accompanying screws

How to Specify:

Refer to [page 15](#) for connection type application guide

Notes:

Code	Price	H	W	D	Weight (lb.)	Volume (ft ³)
3 Way T Connectors						
QL-HC3W-A	97	1	2	3	0.02	0.00
QL-HC3W-B	126	1	2	3	0.02	0.00
QL-HC3W-C	93	1	2	3	0.02	0.00
QL-HC3W-D	119	1	2	3	0.02	0.00

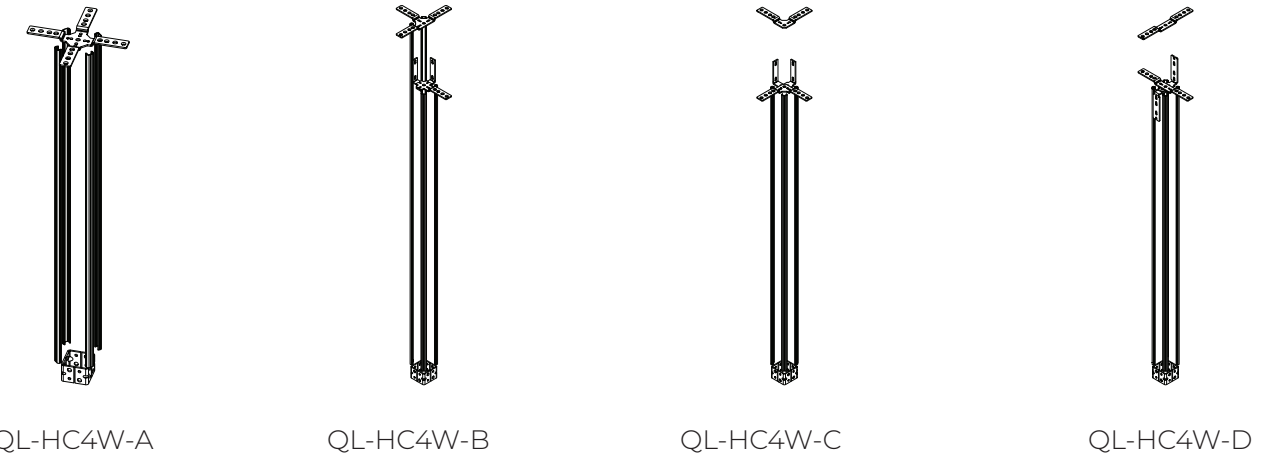

QL-HC4W-A

QL-HC4W-B

QL-HC4W-C

QL-HC4W-D

What's Included:

One (1) type A, B, C or D 4-Way X connection bracket, accompanying screws

How to Specify:

Refer to [page 16](#) for connection type application guide

Notes:

Code	Price	H	W	D	Weight (lb.)	Volume (ft ³)
4 way connectors						
QL-HC4W-A	156	1	2	3	0.02	0.00
QL-HC4W-B	197	1	2	3	0.02	0.00
QL-HC4W-C	177	1	2	3	0.02	0.00
QL-HC4W-D	183	1	2	3	0.02	0.00

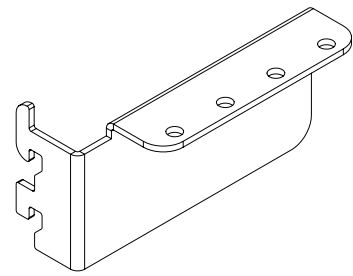

L-HCB
left hand shown

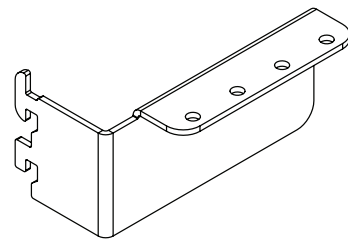

L-HCB1
left hand shown

What's Included:

One (1) standard panel mounted corner bracket

How to Specify:

Left, right
Full depth surface, surface with 1" wire play

Notes:

Worksurface with 1" wire play requires 1" offset bracket
Corner bracket available in black only

Options:

Code	Price	H	W	D	Weight (lb.)	Volume (ft ³)
QL-HCB-P-L	9	3	4	2	0.05	0.01
QL-HCB-P-R	9	3	4	2	0.05	0.01
QL-HCB1-P-L	17	3	4	2	0.05	0.01
QL-HCB1-P-R	17	3	4	2	0.05	0.01

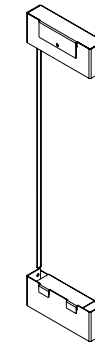

for gallery panel

What's Included:

panel to storage support bracket

How to Specify:

Available in white, black, charcoal, and silver

Notes:

Storage support bracket is used to connect off-modular storage to a surface

24" bracket is used to close 1" gap between storage and panel

30" bracket is used to close 7" gap between storage and panel

Options:

Width: 1"

Code	Price	H	W	Weight (lb.)	Volume (ft ³)
for gallery panel					
QL-HPGP-24	69	28	1	8.57	0.39
QL-HPGP-30	143	28	1	10.72	0.49



Quick Ship
USA Pricebook
January 2026

Worksurface & Supports

Worksurface & Supports

straight worksurface w/o grommet	78
straight worksurface w grommet	82
straight worksurface w/ wire play	84
ladder gable	88
standard panel	88
gallery panel	90
laminated gable	91
standard panel	91
gallery panel	92
freestanding	93
wrap laminated gable	94
standard panel	94
gallery panel	95
storage support bracket	96
90 degree storage bracket	97
standard panel mounted cantilever arm	98
gallery panel mounted cantilever arm	99
flush plate	100

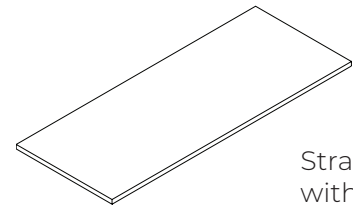

Straight Worksurface without Full Depth without Grommet

What's Included:

One (1) worksurface

How to Specify:

Refer to [page 12](#), Laminate Page for laminate selections

Options:

Width:	23", 24", 29", 30", 35", 36", 41", 42", 47", 48", 53", 54", 59", 60", 65", 66", 71", 72", 76", 77", 78", 82", 83", 84", 88", 89", 90", 94", 95", 96"
Depth:	20", 24", 30"
Thickness:	1"

Notes:

Worksurface is full depth to sit flush against panel with no grommet

Code	Price	Width	Depth	Thickness	Weight (lb.)	Volume (ft ³)
Straight Worksurface without Full Depth without Grommet						
QL-WS00-2320	253	23	20	1	9.20	0.27
QL-WS00-2420	253	24	20	1	9.60	0.28
QL-WS00-2920	307	29	20	1	11.60	0.34
QL-WS00-3020	307	30	20	1	12.00	0.35
QL-WS00-3520	325	35	20	1	14.00	0.41
QL-WS00-3620	325	36	20	1	14.40	0.42
QL-WS00-4120	359	41	20	1	16.40	0.47
QL-WS00-4220	359	42	20	1	16.80	0.49
QL-WS00-4720	397	47	20	1	18.80	0.54
QL-WS00-4820	397	48	20	1	19.20	0.56
QL-WS00-5320	484	53	20	1	21.20	0.61

Code	Price	Width	Depth	Thickness	Weight (lb.)	Volume (ft ³)
QL-WS00-5420	484	54	20	1	21.60	0.62
QL-WS00-5920	484	59	20	1	23.60	0.68
QL-WS00-6020	484	60	20	1	24.00	0.69
QL-WS00-6520	547	65	20	1	26.00	0.75
QL-WS00-6620	547	66	20	1	26.40	0.76
QL-WS00-7120	593	71	20	1	28.40	0.82
QL-WS00-7220	593	72	20	1	28.80	0.83
QL-WS00-7620	629	76	20	1	30.40	0.88
QL-WS00-7720	629	77	20	1	30.80	0.89
QL-WS00-7820	629	78	20	1	31.20	0.90
QL-WS00-8220	683	82	20	1	32.80	0.95
QL-WS00-8320	683	83	20	1	33.20	0.96
QL-WS00-8420	683	84	20	1	33.60	0.97
QL-WS00-8820	717	88	20	1	35.20	1.02
QL-WS00-8920	717	89	20	1	35.60	1.03
QL-WS00-9020	717	90	20	1	36.00	1.04
QL-WS00-9420	790	94	20	1	37.60	1.09
QL-WS00-9520	790	95	20	1	38.00	1.10
QL-WS00-9620	790	96	20	1	38.40	1.11
QL-WS00-2324	253	23	24	1	11.04	0.32
QL-WS00-2424	253	24	24	1	11.52	0.33
QL-WS00-2924	307	29	24	1	13.92	0.40
QL-WS00-3024	307	30	24	1	14.40	0.42
QL-WS00-3524	325	35	24	1	16.80	0.49
QL-WS00-3624	325	36	24	1	17.28	0.50
QL-WS00-4124	359	41	24	1	19.68	0.57

[2 of 4] continued on next page

Worksurface continued [3 of 4]

Code	Price	Width	Depth	Thickness	Weight (lb.)	Volume (ft ³)
QL-WS00-4224	359	42	24	1	20.16	0.58
QL-WS00-4724	397	47	24	1	22.56	0.65
QL-WS00-4824	397	48	24	1	23.04	0.67
QL-WS00-5324	484	53	24	1	25.44	0.74
QL-WS00-5424	484	54	24	1	25.92	0.75
QL-WS00-5924	484	59	24	1	28.32	0.82
QL-WS00-6024	484	60	24	1	28.80	0.83
QL-WS00-6524	547	65	24	1	31.20	0.90
QL-WS00-6624	547	66	24	1	31.68	0.92
QL-WS00-7124	593	71	24	1	34.08	0.99
QL-WS00-7224	593	72	24	1	34.56	1.00
QL-WS00-7624	629	76	24	1	36.48	1.06
QL-WS00-7724	629	77	24	1	36.96	1.07
QL-WS00-7824	629	78	24	1	37.44	1.08
QL-WS00-8224	683	82	24	1	39.36	1.14
QL-WS00-8324	683	83	24	1	39.84	1.15
QL-WS00-8424	683	84	24	1	40.32	1.17
QL-WS00-8824	717	88	24	1	42.24	1.22
QL-WS00-8924	717	89	24	1	42.72	1.24
QL-WS00-9024	717	90	24	1	43.20	1.25
QL-WS00-9424	790	94	24	1	45.12	1.31
QL-WS00-9524	790	95	24	1	45.60	1.32
QL-WS00-9624	790	96	24	1	46.08	1.33
QL-WS00-2330	307	23	30	1	13.80	0.40
QL-WS00-2430	307	24	30	1	14.40	0.42
QL-WS00-2930	359	29	30	1	17.40	0.50

Worksurface continued [4 of 4]

Code	Price	Width	Depth	Thickness	Weight (lb.)	Volume (ft ³)
QL-WS00-3030	359	30	30	1	18.00	0.52
QL-WS00-3530	401	35	30	1	21.00	0.61
QL-WS00-3630	401	36	30	1	21.60	0.62
QL-WS00-4130	437	41	30	1	24.60	0.71
QL-WS00-4230	437	42	30	1	25.20	0.73
QL-WS00-4730	473	47	30	1	28.20	0.82
QL-WS00-4830	473	48	30	1	28.80	0.83
QL-WS00-5330	536	53	30	1	31.80	0.92
QL-WS00-5430	536	54	30	1	32.40	0.94
QL-WS00-5930	565	59	30	1	35.40	1.02
QL-WS00-6030	565	60	30	1	36.00	1.04
QL-WS00-6530	650	65	30	1	39.00	1.13
QL-WS00-6630	650	66	30	1	39.60	1.15
QL-WS00-7130	665	71	30	1	42.60	1.23
QL-WS00-7230	665	72	30	1	43.20	1.25
QL-WS00-7630	726	76	30	1	45.60	1.32
QL-WS00-7730	726	77	30	1	46.20	1.34
QL-WS00-7830	726	78	30	1	46.80	1.35
QL-WS00-8230	789	82	30	1	49.20	1.42
QL-WS00-8330	789	83	30	1	49.80	1.44
QL-WS00-8430	789	84	30	1	50.40	1.46
QL-WS00-8830	900	88	30	1	52.80	1.53
QL-WS00-8930	900	89	30	1	53.40	1.55
QL-WS00-9030	900	90	30	1	54.00	1.56
QL-WS00-9430	977	94	30	1	56.40	1.63
QL-WS00-9530	977	95	30	1	57.00	1.65
QL-WS00-9630	977	96	30	1	57.60	1.67

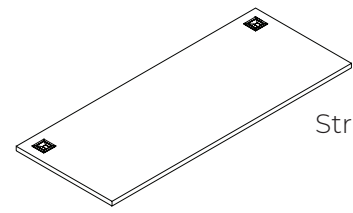

Straight Worksurface with Grommet

What's Included:

- One (1) worksurface
- 24"-48" - One (1) grommet cover for centre grommet
- 54"-96" - Two (2) grommet covers for grommet on each end

Notes:

- 24"-48" - One (1) grommet hole in the centre of the worksurface
- 54"-96" - Two (2) grommet holes on each end of the worksurface

How to Specify:

Refer to [page 12](#), Laminate Page for laminate selections

Options:

Width:	24", 30", 36", 42", 48", 54", 60", 66", 72", 78", 84", 90", 96"
Depth:	20", 24", 30"
Thickness:	1"

Code	Price	Wipth	Depth	Thickness	Weight (lb.)	Volume (ft ³)
QL-WS0G-2420	296	24	20	1	9.60	0.28
QL-WS0G-3020	340	30	20	1	12.00	0.35
QL-WS0G-3620	351	36	20	1	14.40	0.42
QL-WS0G-4220	397	42	20	1	16.80	0.49
QL-WS0G-4820	423	48	20	1	19.20	0.56
QL-WS0G-5420	536	54	20	1	21.60	0.62
QL-WS0G-6020	557	60	20	1	24.00	0.69
QL-WS0G-6620	623	66	20	1	26.40	0.76
QL-WS0G-7220	653	72	20	1	28.80	0.83
QL-WS0G-7820	709	78	20	1	31.20	0.90
QL-WS0G-8420	755	84	20	1	33.60	0.97
QL-WS0G-9020	868	90	20	1	36.00	1.04
QL-WS0G-9620	907	96	20	1	38.40	1.11

Code	Price	Wipth	Depth	Thickness	Weight (lb.)	Volume (ft ³)
QL-WS0G-2424	296	24	24	1	11.52	0.33
QL-WS0G-3024	340	30	24	1	14.40	0.42
QL-WS0G-3624	351	36	24	1	17.28	0.50
QL-WS0G-4224	397	42	24	1	20.16	0.58
QL-WS0G-4824	423	48	24	1	23.04	0.67
QL-WS0G-5424	536	54	24	1	25.92	0.75
QL-WS0G-6024	557	60	24	1	28.80	0.83
QL-WS0G-6624	623	66	24	1	31.68	0.92
QL-WS0G-7224	653	72	24	1	34.56	1.00
QL-WS0G-7824	709	78	24	1	37.44	1.08
QL-WS0G-8424	755	84	24	1	40.32	1.17
QL-WS0G-9024	868	90	24	1	43.20	1.25
QL-WS0G-9624	907	96	24	1	46.08	1.33
QL-WS0G-2430	340	24	30	1	14.40	0.42
QL-WS0G-3030	397	30	30	1	18.00	0.52
QL-WS0G-3630	425	36	30	1	21.60	0.62
QL-WS0G-4230	463	42	30	1	25.20	0.73
QL-WS0G-4830	500	48	30	1	28.80	0.83
QL-WS0G-5430	557	54	30	1	32.40	0.94
QL-WS0G-6030	591	60	30	1	36.00	1.04
QL-WS0G-6630	673	66	30	1	39.60	1.15
QL-WS0G-7230	692	72	30	1	43.20	1.25
QL-WS0G-7830	753	78	30	1	46.80	1.35
QL-WS0G-8430	811	84	30	1	50.40	1.46
QL-WS0G-9030	962	90	30	1	54.00	1.56
QL-WS0G-9630	997	96	30	1	57.60	1.67

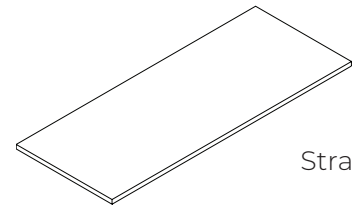

Straight Worksurface with 1" Wire Play

What's Included:

One (1) worksurface

How to Specify:

Refer to [page 12](#), Laminate Page for laminate selections

Options:

Width: 23", 24", 29", 30", 35", 36", 41", 42", 47", 48", 53", 54", 59", 60", 65", 66", 71", 72", 76", 77", 78", 82", 83", 84", 88", 89", 90", 94", 95", 96"

Depth: 19", 23", 29"

Thickness: 1"

Notes:

Worksurface sits 1" from the panel to allow for wire routing. No grommet is included with this worksurface

Code	Price	Height	Depth	Thickness	Weight (lb.)	Volume (ft ³)
Straight Worksurface with 1" Wire Play						
QL-WS00-2319	253	23	19	1	8.74	0.25
QL-WS00-2419	253	24	19	1	9.12	0.26
QL-WS00-2919	307	29	19	1	11.02	0.32
QL-WS00-3019	307	30	19	1	11.40	0.33
QL-WS00-3519	325	35	19	1	13.30	0.38
QL-WS00-3619	325	36	19	1	13.68	0.40
QL-WS00-4119	359	41	19	1	15.58	0.45
QL-WS00-4219	359	42	19	1	15.96	0.46
QL-WS00-4719	397	47	19	1	17.86	0.52
QL-WS00-4819	397	48	19	1	18.24	0.53
QL-WS00-5319	484	53	19	1	20.14	0.58
QL-WS00-5419	484	54	19	1	20.52	0.59

Code	Price	Height	Depth	Thickness	Weight (lb.)	Volume (ft ³)
QL-WS00-5919	484	59	19	1	22.42	0.65
QL-WS00-6019	484	60	19	1	22.80	0.66
QL-WS00-6519	547	65	19	1	24.70	0.71
QL-WS00-6619	547	66	19	1	25.08	0.73
QL-WS00-7119	593	71	19	1	26.98	0.78
QL-WS00-7219	593	72	19	1	27.36	0.79
QL-WS00-7619	629	76	19	1	28.88	0.84
QL-WS00-7719	629	77	19	1	29.26	0.85
QL-WS00-7819	629	78	19	1	29.64	0.86
QL-WS00-8219	683	82	19	1	31.16	0.90
QL-WS00-8319	683	83	19	1	31.54	0.91
QL-WS00-8419	683	84	19	1	31.92	0.92
QL-WS00-8819	717	88	19	1	33.44	0.97
QL-WS00-8919	717	89	19	1	33.82	0.98
QL-WS00-9019	717	90	19	1	34.20	0.99
QL-WS00-9419	790	94	19	1	35.72	1.03
QL-WS00-9519	790	95	19	1	36.10	1.04
QL-WS00-9619	790	96	19	1	36.48	1.06
QL-WS00-2323	253	23	23	1	10.58	0.31
QL-WS00-2423	253	24	23	1	11.04	0.32
QL-WS00-2923	307	29	23	1	13.34	0.39
QL-WS00-3023	307	30	23	1	13.80	0.40
QL-WS00-3523	325	35	23	1	16.10	0.47
QL-WS00-3623	325	36	23	1	16.56	0.48
QL-WS00-4123	359	41	23	1	18.86	0.55
QL-WS00-4223	359	42	23	1	19.32	0.56
QL-WS00-4723	397	47	23	1	21.62	0.63

[2 of 4] continued on next page

Worksurface continued [3 of 4]

Code	Price	Height	Depth	Thickness	Weight (lb.)	Volume (ft ³)
QL-WS00-4823	397	48	23	1	22.08	0.64
QL-WS00-5323	484	53	23	1	24.38	0.71
QL-WS00-5423	484	54	23	1	24.84	0.72
QL-WS00-5923	484	59	23	1	27.14	0.79
QL-WS00-6023	484	60	23	1	27.60	0.80
QL-WS00-6523	547	65	23	1	29.90	0.87
QL-WS00-6623	547	66	23	1	30.36	0.88
QL-WS00-7123	593	71	23	1	32.66	0.95
QL-WS00-7223	593	72	23	1	33.12	0.96
QL-WS00-7623	629	76	23	1	34.96	1.01
QL-WS00-7723	629	77	23	1	35.42	1.02
QL-WS00-7823	629	78	23	1	35.88	1.04
QL-WS00-8223	683	82	23	1	37.72	1.09
QL-WS00-8323	683	83	23	1	38.18	1.10
QL-WS00-8423	683	84	23	1	38.64	1.12
QL-WS00-8823	717	88	23	1	40.48	1.17
QL-WS00-8923	717	89	23	1	40.94	1.18
QL-WS00-9023	717	90	23	1	41.40	1.20
QL-WS00-9423	790	94	23	1	43.24	1.25
QL-WS00-9523	790	95	23	1	43.70	1.26
QL-WS00-9623	790	96	23	1	44.16	1.28
QL-WS00-2329	307	23	29	1	13.34	0.39
QL-WS00-2429	307	24	29	1	13.92	0.40
QL-WS00-2929	359	29	29	1	16.82	0.49
QL-WS00-3029	359	30	29	1	17.40	0.50
QL-WS00-3529	401	35	29	1	20.30	0.59
QL-WS00-3629	401	36	29	1	20.88	0.60
QL-WS00-4129	437	41	29	1	23.78	0.69

Worksurface continued [4 of 4]

Code	Price	Height	Depth	Thickness	Weight (lb.)	Volume (ft ³)
QL-WS00-4229	437	42	29	1	24.36	0.70
QL-WS00-4729	473	47	29	1	27.26	0.79
QL-WS00-4829	473	48	29	1	27.84	0.81
QL-WS00-5329	536	53	29	1	30.74	0.89
QL-WS00-5429	536	54	29	1	31.32	0.91
QL-WS00-5929	565	59	29	1	34.22	0.99
QL-WS00-6029	565	60	29	1	34.80	1.01
QL-WS00-6529	650	65	29	1	37.70	1.09
QL-WS00-6629	650	66	29	1	38.28	1.11
QL-WS00-7129	665	71	29	1	41.18	1.19
QL-WS00-7229	665	72	29	1	41.76	1.21
QL-WS00-7629	726	76	29	1	44.08	1.28
QL-WS00-7729	726	77	29	1	44.66	1.29
QL-WS00-7829	726	78	29	1	45.24	1.31
QL-WS00-8229	789	82	29	1	47.56	1.38
QL-WS00-8329	789	83	29	1	48.14	1.39
QL-WS00-8429	789	84	29	1	48.72	1.41
QL-WS00-8829	900	88	29	1	51.04	1.48
QL-WS00-8929	900	89	29	1	51.62	1.49
QL-WS00-9029	900	90	29	1	52.20	1.51
QL-WS00-9429	977	94	29	1	54.52	1.58
QL-WS00-9529	977	95	29	1	55.10	1.59
QL-WS00-9629	977	96	29	1	55.68	1.61

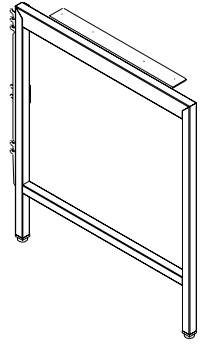

Standard Panel Ladder Gable

What's Included:

One (1) ladder gable, one (1) standard panel mount bracket, (1) surface to gable connector

How to Specify:

Choose White, Black, Silver, Charcoal for ladder gable color

Notes:

Ladder Gable can be used with worksurface with grommet, worksurface without grommet, worksurface for 1" wire play

Mid gable is used at the surface joint

Options:

Height: 28"

Depth: 20", 24", 30"

Ladder Gable Paint Color: Silver, White, Black, Charcoal

End gable: (Left hand, right hand) or mid gable

Code	Price	H	W	D	Weight (lb.)	Volume (ft ³)
Left hand						
QL-HOEG-P-2820-L	402	25	20	2	10.00	0.58
QL-HOEG-P-2824-L	411	28	24	2	13.44	0.78
QL-HOEG-P-2830-L	427	28	30	2	16.80	0.97
Right hand						
QL-HOEG-P-2820-R	402	28	20	2	11.20	0.65
QL-HOEG-P-2824-R	411	28	24	2	13.44	0.78
QL-HOEG-P-2830-R	427	28	30	2	16.80	0.97
Mid						
QL-HOMG-P-2820	402	28	20	2	11.20	0.65
QL-HOMG-P-2824	411	28	24	2	13.44	0.78
QL-HOMG-P-2830	427	28	30	2	16.80	0.97

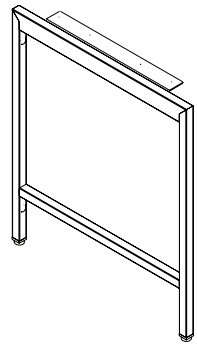

Gallery Panel Ladder Gable

What's Included:

One (1) ladder gable, one (1) gallery panel mount bracket, (1) surface to gable connector

How to Specify:

Choose White, Black, Silver, Charcoal for ladder gable color

Options:

Height:	28"
Width:	20", 24", 30"
Ladder Gable Paint Color::	Silver, White, Black, Charcoal
End gable:	(Left hand, right hand) or mid gable

Notes:

Ladder Gable can be used with worksurface with grommet, worksurface without grommet, worksurface for 1" wire play

Mid gable is used at the surface joint

Code	Price	H	W	D	Weight (lb.)	Volume (ft ³)
Left hand						
QL-HOEG-P-2820-L	402	25	20	2	10.00	0.58
QL-HOEG-P-2824-L	411	28	24	2	13.44	0.78
QL-HOEG-P-2830-L	427	28	30	2	16.80	0.97
Right hand						
QL-HOEG-P-2820-R	402	28	20	2	11.20	0.65
QL-HOEG-P-2824-R	411	28	24	2	13.44	0.78
QL-HOEG-P-2830-R	427	28	30	2	16.80	0.97
Mid						
QL-HOMG-P-2820	402	28	20	2	11.20	0.65
QL-HOMG-P-2824	411	28	24	2	13.44	0.78
QL-HOMG-P-2830	427	28	30	2	16.80	0.97

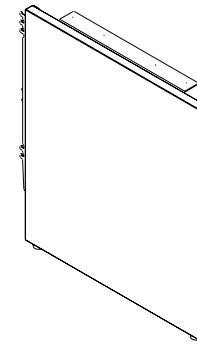

Standard Panel Laminate Gable

What's Included:

One (1) laminate gable, one (1) standard panel mount bracket, (1) surface to gable connector

How to Specify:

Laminate Gable Paint Color: Silver, White, Black, Charcoal

Laminate Gable Laminate Color: Refer to [page 12](#), Laminate Page for laminate selections

End gable (Left hand, right hand)

Options:

Height:	, 28"
Width:	20", 24", 30"

Notes:

Laminate Gable can be used with worksurface with grommet, worksurface without grommet, worksurface for 1" wire play

Code	Price	H	W	D	Weight (lb.)	Volume (ft ³)
Left hand						
QL-HCEG-P-2812-L	240	28	12	2	10.00	0.39
QL-HCEG-P-2820-L	271	28	20	2	11.20	0.65
QL-HCEG-P-2824-L	294	28	24	2	13.44	0.78
QL-HCEG-P-2830-L	322	28	30	2	16.80	0.97
Right hand						
QL-HCEG-P-2812-R	240	28	12	2	10.00	0.39
QL-HCEG-P-2820-R	271	28	20	2	11.20	0.65
QL-HCEG-P-2824-R	294	28	24	2	13.44	0.78
QL-HCEG-P-2830-R	322	28	30	2	16.80	0.97

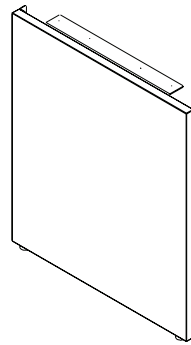

Gallery Panel
Laminate Gable

What's Included:

One (1) laminate gable, one (1) gallery panel mount bracket, (1) surface to gable connector

How to Specify:

Laminate Gable Paint Color: Silver, White, Black, Charcoal

Laminate Gable Laminate Color: Refer to [page 12](#), Laminate Page for laminate selections

End gable (Left hand, right hand)

Options:

Height: 28"

Width: 20", 24", 30"

Notes:

Laminate Gable can be used with worksurface with grommet, worksurface without grommet, worksurface for 1" wire play

Code	Price	H	W	D	Weight (lb.)	Volume (ft ³)
Left hand						
QL-HCEG-Y-2812-L	231	28	12	2	11.20	0.39
QL-HCEG-Y-2820-L	265	28	20	2	11.20	0.65
QL-HCEG-Y-2824-L	283	28	24	2	13.44	0.78
QL-HCEG-Y-2830-L	312	28	30	2	16.80	0.97
Right hand						
QL-HCEG-Y-2812-R	231	28	12	2	11.20	0.39
QL-HCEG-Y-2820-R	265	28	20	2	11.20	0.65
QL-HCEG-Y-2824-R	283	28	24	2	13.44	0.78
QL-HCEG-Y-2830-R	312	28	30	2	16.80	0.97

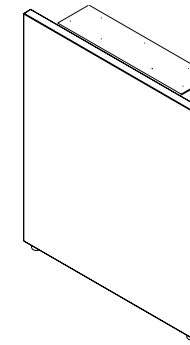

Freestanding Laminate Gable

What's Included:

One (1) laminate gable, (1) surface to gable connector

How to Specify:

Laminate Gable Paint Color: Silver, White, Black, Charcoal

Laminate Gable Laminate Color: Refer to [page 12](#), Laminate Page for laminate selections

Options:

Height: 28"

Width: 20", 24", 30"

Notes:

Laminate Gable can be used with worksurface with grommet, worksurface without grommet, worksurface for 1" wire play

Freestanding gable is used when one side of the surface is connected to a panel and the other is open

Code	Price	H	W	D	Weight (lb.)	Volume (ft ³)
QL-HCEG-S-2820	283	28	20	2	11.20	0.65
QL-HCEG-S-2824	307	28	24	2	13.44	0.78
QL-HCEG-S-2830	335	28	30	2	16.80	0.97

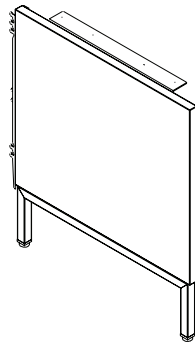

Standard Panel
Wrap Laminate Gable

What's Included:

One (1) wrap gable, one (1) standard panel mount bracket, (1) surface to gable connector

How to Specify:

Laminate Gable Paint Color: Silver, White, Black, Charcoal

Laminate Gable Laminate Color: Refer to [page 12](#).
Laminate Page for laminate selections
End gable (Left hand, right hand)

Options:

Heights*: 28"

Width: 20", 24", 30"

*25" high to be used to Tech Drop surface

Notes:

Wrap Laminate Gable can be used with worksurface with grommet, worksurface without grommet, worksurface for 1" wire play

Freestanding gable is used when one side of the surface is connected to a panel and the other is open

Code	Price	H	W	D	Weight (lb.)	Volume (ft ³)
Left hand						
QL-HWEG-P-2820-L	457	28	20	2	11.20	0.65
QL-HWEG-P-2824-L	473	28	24	2	13.44	0.78
QL-HWEG-P-2830-L	524	28	30	2	16.80	0.97
Right hand						
QL-HWEG-P-2820-R	457	28	20	2	11.20	0.65
QL-HWEG-P-2824-R	473	28	24	2	13.44	0.78
QL-HWEG-P-2830-R	524	28	30	2	16.80	0.97

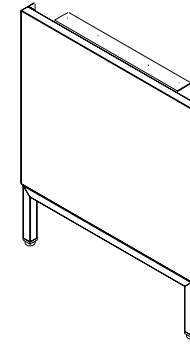

Gallery Panel
Wrap Laminate Gable

What's Included:

One (1) wrap gable, one (1) gallery panel mount bracket, (1) surface to gable connector

How to Specify:

Laminate Gable Paint Color: Silver, White, Black, Charcoal

Laminate Gable Laminate Color: Refer to [page 12](#).
Laminate Page for laminate selections

End gable (Left hand, right hand)

Options:

Height*: 28"

Width: 20", 24", 30"

*25" high to be used to Tech Drop surface

Notes:

Wrap Laminate Gable can be used with worksurface with grommet, worksurface without grommet, worksurface for 1" wire play

Freestanding gable is used when one side of the surface is connected to a panel and the other is open

Code	Price	H	W	D	Weight (lb.)	Volume (ft ³)
Left hand						
QL-HWEG-Y-2820-L	457	28	20	2	11.20	0.65
QL-HWEG-Y-2824-L	473	28	24	2	13.44	0.78
QL-HWEG-Y-2830-L	525	28	30	2	16.80	0.97
Right hand						
QL-HWEG-Y-2820-R	457	28	20	2	11.20	0.65
QL-HWEG-Y-2824-R	473	28	24	2	13.44	0.78
QL-HWEG-Y-2830-R	525	28	30	2	16.80	0.97

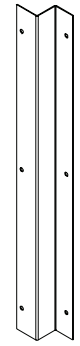

for standard panel



for gallery panel

What's Included:

panel to storage support bracket

How to Specify:

Available in white, black, charcoal, and silver

Notes:

Storage support bracket is used to connect off-modular storage to a surface

24" bracket is used to close 1" gap between storage and panel

30" bracket is used to close 7" gap between storage and panel

Options:

Depth: 24", 30"

Code	Price	H	W	Depth	Weight (lb.)	Volume (ft ³)
for standard panel - left hand						
QL-HPSP-24-L	55	28	1	24	8.57	0.39
QL-HPSP-24-R	55	28	1	24	8.57	0.39
for standard panel -right hand						
QL-HPSP-30-L	101	28	1	30	10.71	0.49
QL-HPSP-30-R	101	28	1	30	10.71	0.49
for gallery panel						
QL-HPGP-24	69	28	1	24	8.57	0.39
QL-HPGP-30	143	28	1	30	10.72	0.49

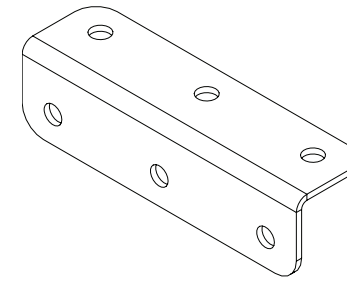

What's Included:

One (1) 90 degree bracket

How to Specify:

Available in black only

Notes:

90 degree bracket is used to connect a worksurface to a gallery panel

24" deep surface: two (2) brackets
30" deep surface: three (3) brackets

Options:

Width: 3"

Code	Price	Specifications	Weight (lb.)	Volume (ft ³)
QL-HSSB	3	3", 6 Holes	0.50	0.09
QL-HSSB-24	9	3", 6 Holes	2.19	0.09
QL-HSSB-30	15	3", 6 Holes	3.00	0.09

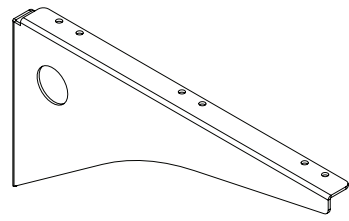

Standard Panel Mounted Cantilever Arm

What's Included:

One (1) standard panel mounted cantilever arm

How to Specify:

Left, right, mid

Notes:

Cantilever available in black only

Options:

Width: 16", 22"

Code	Price	H	W	D	Weight (lb.)	Volume (ft ³)
intermediate						
QL-CCAB-P-16	69	8	16	2	2.56	0.15
QL-CCAB-P-22	76	8	22	2	3.52	0.21
left hand						
QL-CCAB-P-16-L	69	8	16	2	1.92	0.11
QL-CCAB-P-22-L	76	8	22	2	2.64	0.15
right hand						
QL-CCAB-P-16-R	69	8	16	2	1.92	0.11
QL-CCAB-P-22-R	76	8	22	2	2.64	0.15

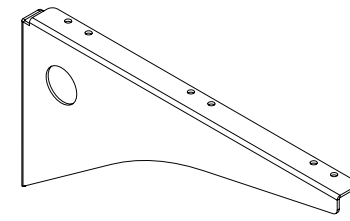

Gallery Panel Mounted Cantilever Arm

What's Included:

One (1) gallery panel mounted cantilever arm

How to Specify:

Left, right, mid

Notes:

Cantilever available in black only

Options:

Depth: 16", 22"

Code	Price	H	W	D	Weight (lb.)	Volume (ft ³)
intermediate						
QL-CCAB-Y-16	69	8	16	2	2.56	0.15
QL-CCAB-Y-22	76	8	22	2	3.52	0.21
left hand						
QL-CCAB-Y-16-L	69	8	16	2	1.92	0.11
QL-CCAB-Y-22-L	76	8	22	2	2.64	0.15
right hand						
QL-CCAB-Y-16-R	69	8	16	2	1.92	0.11
QL-CCAB-Y-22-R	76	8	22	2	2.64	0.15

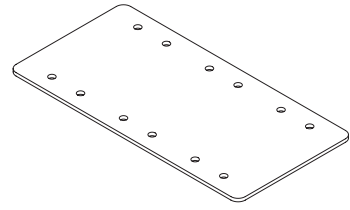

What's Included:

One (1) flush plate

How to Specify:

Flush Plate Paint Colour: Silver

Notes:

Flush plate is used at surface joint to connect two surfaces together

Options:

Width: 5.5"

Depth: 3"

Code	Price	H	W	D	Weight (lb.)	Volume (ft ³)
QL-PWW	48	3	5.5	0	1.00	0.00



Quick Ship
USA Pricebook
January 2026
Storage

Storage

<u>metal shelf</u>	104
<u>flipper cabinet</u>	105
<u>pedestals</u>	106
<u>underdesk pedestal</u>	106
<u>mobile</u>	107
<u>lateral file</u>	108

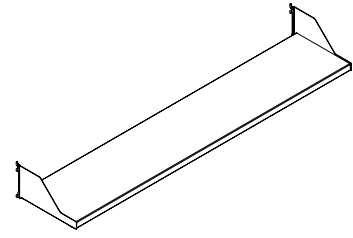

What's Included:

One (1) metal shelf

How to Specify:

Choose white, black, silver, charcoal for metal shelf

Notes:

Options:

Height:	6"
Width:	30", 36", 42", 48", 54", 60"
Depth:	12"

Code	Price	H	W	D	Weight (lb.)	Volume (ft ³)
QL-SOOM-1230	365	2	30	12	14.40	0.42
QL-SOOM-1236	385	2	36	12	17.28	0.50
QL-SOOM-1242	400	2	42	12	20.16	0.58
QL-SOOM-1248	413	2	48	12	23.04	0.67
QL-SOOM-1254	429	2	54	12	25.92	0.75
QL-SOOM-1260	446	2	60	12	28.80	0.83

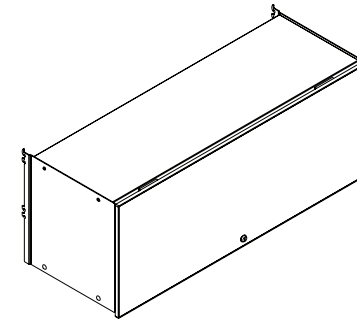

What's Included:

One (1) laminate flipper cabinet

How to Specify:

Choose laminate face

Refer to [page 12](#), Laminate Page for laminate selections

Notes:

Locks can be keyed alike or random
Flipper cabinet slides are easy-down pneumatic

Options:

Height*:	16"
Width:	30", 36", 42", 48", 54", 60"
Depth**:	15"

* Internal cabinet height is 13"

** Internal cabinet depth is 13"

Code	Price	H	W	D	Weight (lb.)	Volume (ft ³)
laminate face w/pneumatic slides						
QL-SPFL-1530-P	682	16	30	15	32.73	4.17
QL-SPFL-1536-P	687	16	36	15	39.27	5.00
QL-SPFL-1542-P	712	16	42	15	45.82	5.83
QL-SPFL-1548-P	718	16	48	15	52.36	6.67
QL-SPFL-1554-P	746	16	54	15	58.91	7.50
QL-SPFL-1560-P	753	16	60	15	65.46	8.33

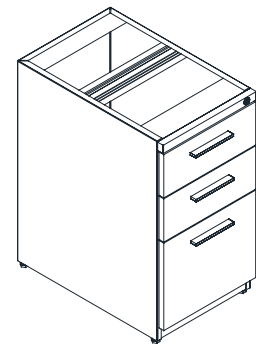

box/box/file

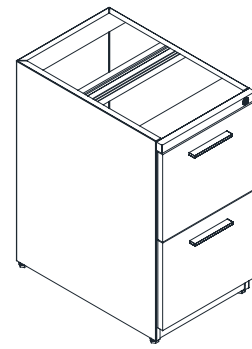

file/file

What's Included:

One (1) box/box/file or one (1) file/file underdesk pedestal

How to Specify:

Pedestal type: box/box/file, file/file

Notes:

Pedestal brackets must be ordered separately

Locks can be keyed alike or random

Options:

Height: 28"

Width: 16"

Depth: 23", 29"

Code	Price	H	W	D	Weight (lb.)	Volume (ft ³)
box/box/file						
QL-FPBU-281623	1014	28	16	23	64.40	5.96
QL-FPBU-281629	1047	28	16	29	81.20	7.52
file/file						
QL-FPFU-281623	938	28	16	23	64.40	5.96
QL-FPFU-281629	978	28	16	29	81.20	7.52

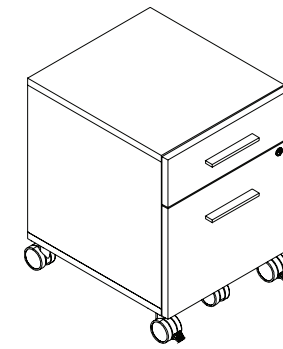

box/ file/no cushion

What's Included:

One (1) box/file mobile pedestal or one (1) box/file mobile pedestal with cushion, five (5) lockable casters

How to Specify:

Choose handle type and finish

Choose depth

Choose silver or white for caster finish

Notes:

Locks can be keyed alike or random

Options:

Height: 21" without cushion

Width: 16"

Depth: 18"

Code	Price	H	W	D	Weight (lb.)	Volume (ft ³)
box/file/no cushion						
QL-FPL0-211618	1033	21	16	18	43.20	3.50

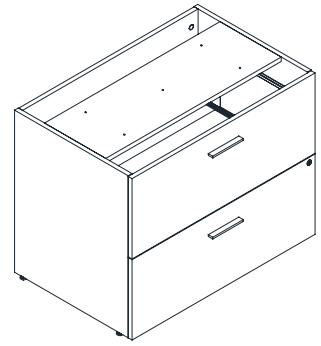

Lateral Underdesk File

What's Included:

One (1) two drawer underdesk lateral filing cabinet, each drawer is equipped with (2) bars for front to back filing

How to Specify:

Refer to [page 12](#), Laminate Page for laminate selections

Choose handle type and finish

Choose depth

Options:

Height: 28"

Width: 30", 36"

Depth: 23", 29"

Notes:

Lateral brackets must be ordered seperately

Locks can be keyed alike or random

Code	Price	H	W	D	Weight (lb.)	Volume (ft ³)
underdesk 2 Drawer						
QL-FL2U-283023	1289	28	30	23	107.33	11.18
QL-FL2U-283029	1328	28	30	29	135.33	14.10
QL-FL2U-283623	1392	28	36	23	128.80	13.42
QL-FL2U-283629	1431	28	36	29	162.40	16.92



Quick Ship
USA Pricebook
January 2026
Electrics

Electrics

vertical wire manager	112
wire manager	113
starter harness	114
male to female extension harness	115
Chicago electrical box	116
New York junction box	117
desktop power module	118
power module	119
connector harness	120
communication kit	121

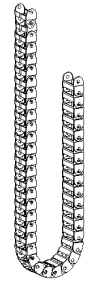

E-Chain Wire Manager

Notes:

E-Chain is available in black only

Code	Price	H	W	D	Volume (ft ³)	Weight (lb)
e-chain wire manager						
V-EE-28	336	28			1.00	1



for 3 way connection(3W)



for 4 way connection(4W)

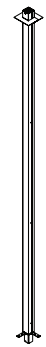

For 90 Degree Connection (N)

What's Included:

One (1) power pole, chosen mounting hardware

How to Specify:

Specify type based on panel connection: 90 degree, 3-way T, 4 way X and gallery panel mount

90 degree, 3-way T and 4-way X must be used with same height connecting panels

Use gallery panel mount type at the end of a run

Options:

Connector type height: 120"

Gallery panel height: 144"

Notes:

Code	Price	H	W	D	Weight (lb.)	Volume (ft ³)
standard panel						
QL-EP-P-120-3W	536	120	2	2	2.00	0.28
QL-EP-P-120-4W	536	120	2	2	2.00	0.28
QL-EP-P-120-N	536	120	2	2	2.00	0.28
gallery panel						
QL-EP-Y-144	663	144	2	2	2.00	0.33

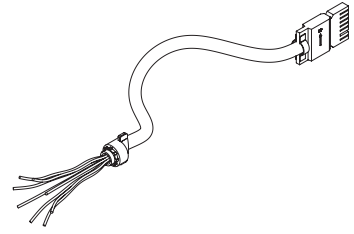

What's Included:

One (1) open wire starter harness

How to Specify:

Available in grey only

Single sided, double sided

Notes:

Switch electrical system is rated for 20 amps

Tayco recommends up to 8 workstations hardwired to one power source

Options:

Length: 72", 168"

Code	Price	L	D	Weight (lb.)	Volume (ft ³)
QL-ES84-072-0	359	72	0.75	3	0.40
QL-ES84-168-0	451	168	0.75	5	0.50

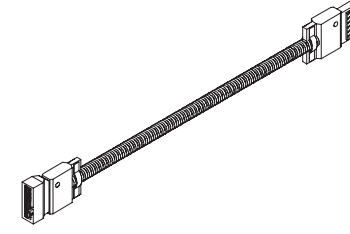

What's Included:

One (1) male to female extension harness

How to Specify:

Available in grey only

Single sided, double sided

Options:

Length: 44", 122"

Notes:

Male to female extension harness is used to extend length of the starter harness

Code	Price	Length	D	Weight (lb.)
QL-E8FM-044	232	44	0.75	0
QL-E8FM-122	402	122	0.75	1

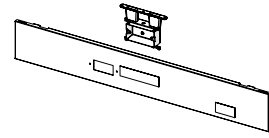

Single sided

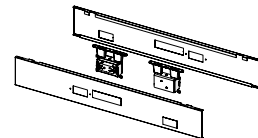

Double sided

What's Included:

Single Sided: One (1) electrical box with two (2) ac outlets and one (1) panel raceway

Double Sided: Two (2) single sided electrical boxes each with two (2) ac outlets and two (2) panel raceways

How to Specify:

Select corresponding size to match the panel width

Options:

Width: 30", 36", 42", 48", 54", 60", 72"

Notes:

Junction box is located on the left hand side of the panel

Code	Price	Width	Weight (lb.)
Single Sided			
QL-JB0X-30-S	382	30	
QL-JB0X-36-S	382	36	
QL-JB0X-42-S	382	42	
QL-JB0X-48-S	382	48	
QL-JB0X-54-S	382	54	
QL-JB0X-60-S	382	60	
Double Sided			
QL-JB0X-30-D	760	30	
QL-JB0X-36-D	760	36	
QL-JB0X-42-D	760	42	
QL-JB0X-48-D	760	48	
QL-JB0X-54-D	760	54	
QL-JB0X-60-D	760	60	

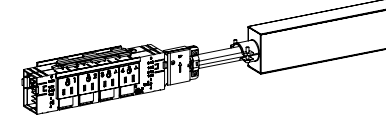

What's Included:

Panels 24", 30", 36" wide: One (1) New York junction box

Panels 42" or wider: One (1) New York junction box with single or double power module

How to Specify:

Panels 24", 30", 36" wide: Specify junction box without power module. Power module and starter harness must be specified speratley

Panels 42" or wider: Specify single or double power module with junction box

Options:

Junction Box width: 9"

Junction Box with power module width: 18"

Notes:

Male to female extension harness is used to extend length of the starter harness

Code	Price	Length	D	Weight (lb.)
QL-NY84-004-D	811			
QL-NY84-004-S	662			
QL-NYEJ-84	230			

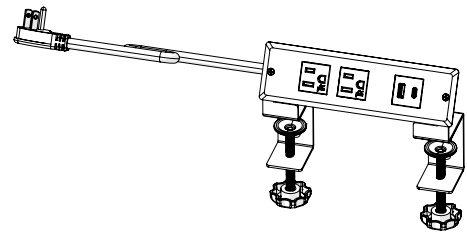

clamp mount desktop power module equipped with:
two AC outlets,
one USB A and
one USB C charging ports, and
one (1) three prong cord

Code	Price	H	W	D	Volume	Weight
clamp mount desktop power module (2 AC outlets and 1 ea USB A & C ports)						
V-EMW-2AC	208	6	4	3	1.00	0.04

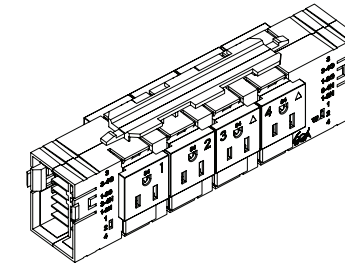
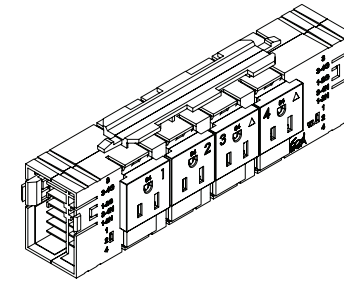

What's Included:

One (1) single power module with four (4) ac outlets or one (1) double sided power module with eight (8) ac outlets (four on each side)

How to Specify:

Available in grey only

Single sided, double sided

Options:

Width: 8"

Notes:

Power modules are installed in the center cut out power capable panels only

Double sided power module has four (4) ac outlets on each side

Refer to Switch electrical specification guide for more information

Code	Price	H	W	D	Weight (lb.)	Volume (ft ³)
single sided						
QL-EM84-S	242	3	6	3	1.70	0.03
double sided						
QL-EM84-D	386	3	6	3	2.00	0.03

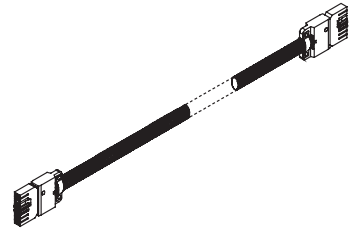

What's Included:

One (1) connector harness

How to Specify:

Available in grey only

Single sided, double sided

Options:

Length: 22"-67" in 3" increments

Notes:

Connector harness is used to connect two power modules together

Refer to installation guide for connector harness length calculation

Code	Price	Length	D	Weight (lb.)	Volume (ft ³)
QL-EH84-22	182	22	0.75	1	0.20
QL-EH84-25	187	25	0.75	1	0.20
QL-EH84-28	194	28	0.75	1	0.20
QL-EH84-31	201	31	0.75	1	0.20
QL-EH84-34	208	34	0.75	1	0.20
QL-EH84-37	214	37	0.75	1	0.20
QL-EH84-40	223	40	0.75	1	0.20
QL-EH84-43	229	43	0.75	1	0.20
QL-EH84-46	232	46	0.75	1	0.20
QL-EH84-49	239	49	0.75	2	0.20
QL-EH84-52	245	52	0.75	2	0.20
QL-EH84-55	256	55	0.75	2	0.20
QL-EH84-58	259	58	0.75	2	0.20
QL-EH84-61	267	61	0.75	2	0.20
QL-EH84-64	271	64	0.75	2	0.20
QL-EH84-67	281	67	0.75	2	0.20

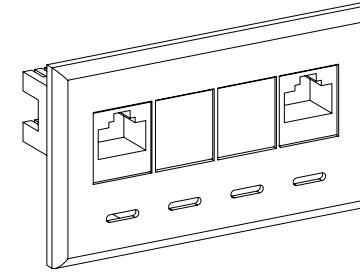

type 6
RJ45/45

What's Included:

One (1) data plate with three (3) openings and chosen combination of RJ45

How to Specify:

Specify RJ45 for data connection

Notes:

Data is placed on the right hand side of the cutout in the panel raceway

Options:

Panel cutout width: 2 3/4"

Panel cutout height: 1 3/8"

Code	Price	H	W	D	Weight (lb.)	Volume (ft ³)
type 6						
QL-ECK6	174	2	4	1	0.24	0



Quick Ship
USA Pricebook
January 2026
Accessories

Accessories

<u>keyboard tray</u>	124
<u>pencil drawer</u>	125
<u>LED tasklight</u>	126
<u>monitor arm</u>	127
<u>height adjustable base</u>	128
<u>straight</u>	128
<u>5 sided</u>	129
<u>task seating</u>	130

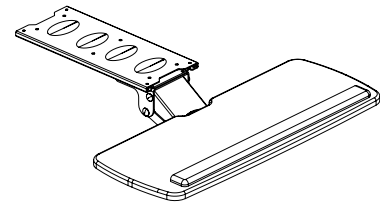

Articulating Keyboard Tray

What's Included:

Keyboard Tray, installation hardware.

How to Specify:

The articulating keyboard is available only in black.

Notes:

Keyboard trays provide adjustable ergonomic support for individuals in multi-task environments

Code	Price	H	W	D	Volume (ft ³)	Weight (lb)
Articulating Keyboard Tray						
V-KASX-2510	459	0	25	10	0.00	15

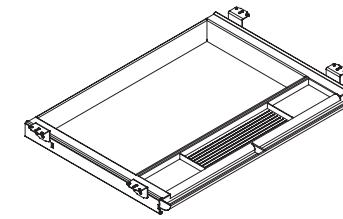

Plastic Pencil Drawer

What's Included:

One (1) pencil tray

How to Specify:

Available in black only

Notes:

Available in black only

Dimensions:

Width: 24"

Depth: 16"

Code	Price	H	W	D	Weight (lb.)	Volume (ft ³)
V-ADPP	100	2.8	21	16	2	0.62

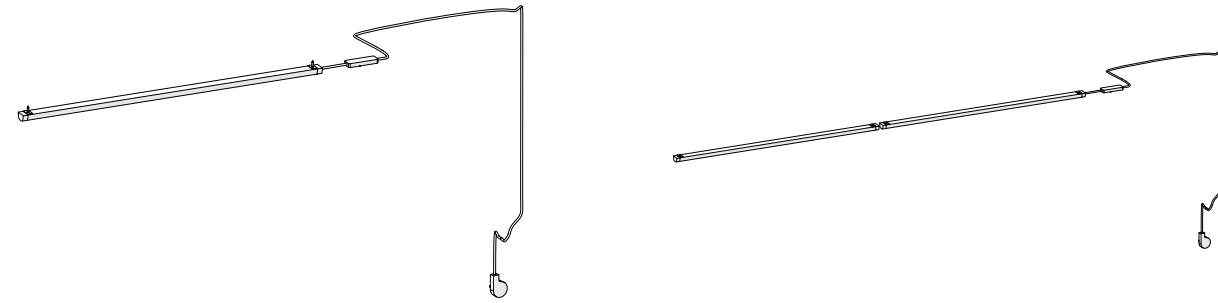

Halifax LED Light 30"(1) with transformer, Wire manager, Mounting Plate and hardware

Halifax LED Light 30"(2) with transformer, Wire manager, Mounting Plate and hardware

What's Included:

- LED Tasklight
- Transformer
- Mounting Plate
- Mounting Hardware

Notes:

7284 consists of two 30" lights
Hardware includes screws for wood overhead and magnets for metal overheads

How to Specify:

3666 fits under overheads between 36"-66"W
7284 fits under overheads between 72"-84"W

Options:

Available in Silver only

Code	Price
LED Tasklight	
V-ELU-3666	481
V-ELU-7284	891

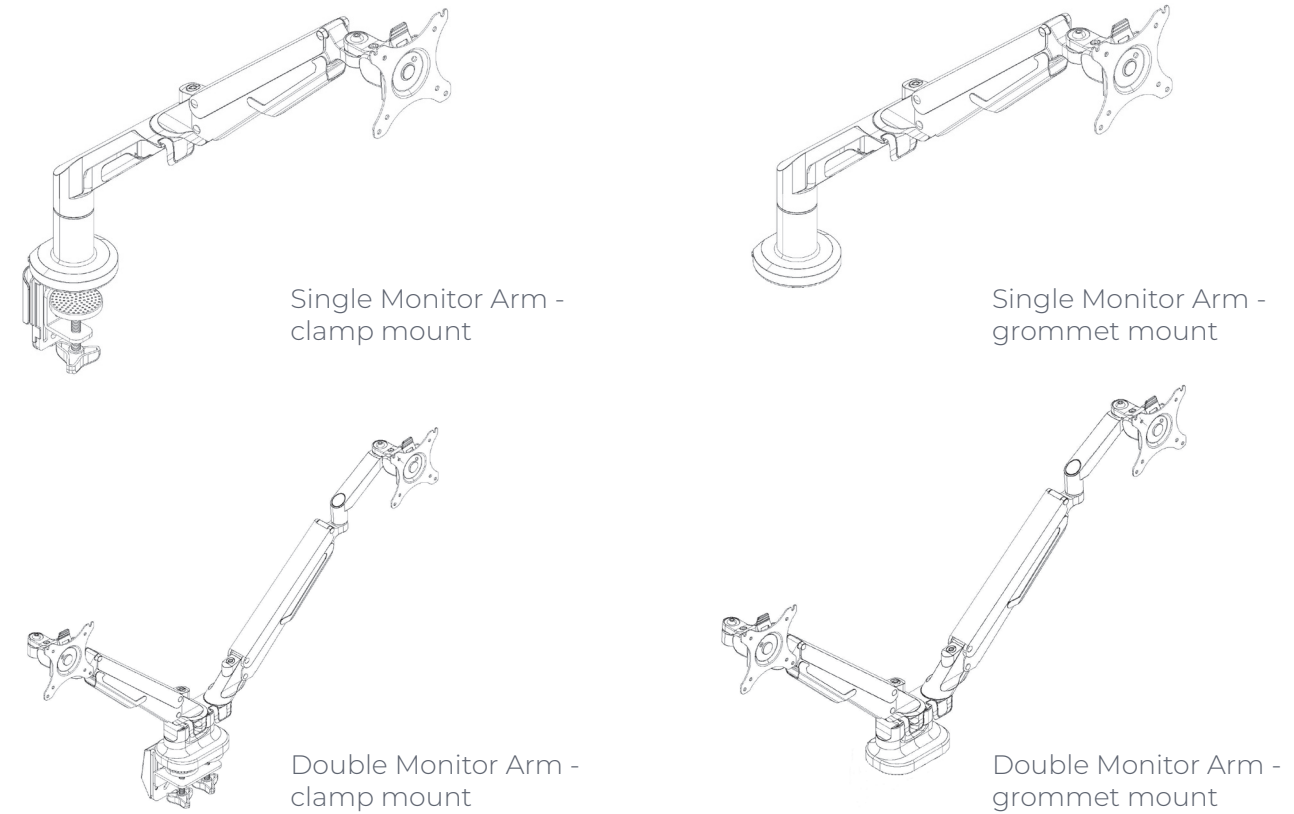

What's Included:

One monitor arm and installation hardware for both clamp and grommet mount

How to Specify:

- Specify type

Notes:

Available in silver only
Single Monitor Arm
• Screen Size - 17"-36"
• Load Capacity - 6.6-26.4lbs/3-12kg
• Tilt Range - -90 degrees - -15 degrees
Dual Monitor Arm
• Screen Size - 17"-32"
• Load Capacity - 4.4-19.8lbs/2-9kg
• Tilt Range - -90 degrees - -15 degrees

Dimensions:

Vesa: 75x75 and 100x100

Code	Price
Monitor Arm - Single Mount	
V-AFMA-01	426
Monitor Arm - Double Mount	
V-AFMA-02	711

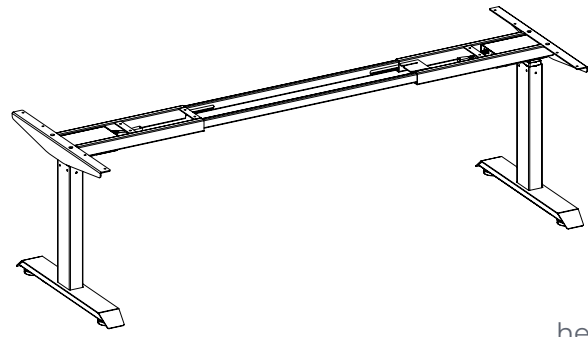

height adjustable base

What's Included:

Set of height adjustable supports (1) and one digital height display unit (1).

How to Specify:

Grommet can be specified in silver or white.

Edge color will default to match the surface color of the worksurface unless otherwise specified.

Pinch points are taken into account in all of the Integrated tables.

Options:

Leg color silver white black

Notes:

Table height can be adjusted to 25" from the ground and raised to a maximum height of 51" from the ground.

Load capacity of 275lb with worksurface.

straight - base

Code	Price	W Range (in)	D(in)	Weight (lb)	Volume (ft ³)
R-HATB-S-G3	1671	40"-72"	24	88.00	2.80
R-HATB-L-G3	1710	76"-90"	24	90.00	2.86

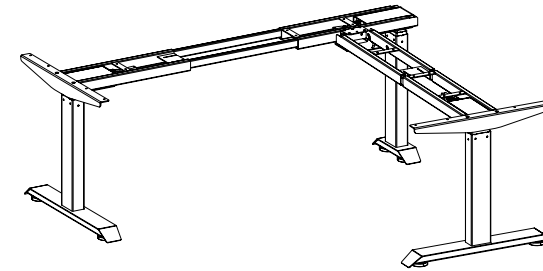

5 sided base

What's Included:

Set of height adjustable supports (1) and one digital height display unit (1).

How to Specify:

Pinch points are taken into account in all of the Integrated tables.

Options:

Leg color silver white black

Notes:

Table height can be adjusted to 25" from the ground and raised to a maximum height of 51" from the ground.

Load capacity of 330lb with worksurface.

5 sided base

Code	Price	W Range (in)	D (in)	Volume (ft ³)	Weight (lb)
R-HA3B-S-G3	3371	46"-72"	24	146.00	4.22
R-HA3B-L-G3	3408	58"-84"	24	148.00	4.27



Dimensions:

Overall height: 39.25"
 Overall width adj. arm: 25.25"
 Overall width fixed arm: 25"
 Overall depth: 25"

Notes:

Advanced mesh distributes excellent support while being soft and warm to the touch and offers unimpeded airflow for maximum comfort.

Height adjustable arm with 3 directional movements.

J1 casters are suitable for hard surfaces and carpet flooring.

Adjustable lumbar support is built into the frame offering comfort and support with clean lines.

Streamlined, premium control with side tension allows for consistent and balanced support throughout its ride.

Frame is available in black finish with 701M black mesh.

Options:

finish color	B black finish with 701M black mesh
arms	AL adjustable arms
seat slider	O no seat slider
seat fabric	701A black
packaging	Unassembled

Black Finish Frame - Fixed Arms

	Code	Price	Volume (ft ³)	Weight (lb)
J1 Fabric	J-MTCB-AL0-A	1031	7.00	45