



Metro Pricebook

January 2026

contents

Caution	7
Overview	8
Statement of Line	13
Step-by-step order placement	31
Straight Desk	32
straight executive	34
straight professional	36
straight partial modesty executive	38
straight partial modesty professional	40
straight full recessed modesty executive	42
straight full recessed modesty professional	44
arc full recessed modesty executive	46
arc full recessed modesty professional	47
Tables	48
D-table executive	50
D-table professional	51
J-table executive	52
J-table professional	53
P-table executive	54
P-table professional	55
F-table executive	56
F-table professional	57
U-table executive	58
U-table professional	59
C-table executive	60
C-table professional	61
Corners	62
straight front corner full modesty executive	64
straight front corner full modesty professional	65
straight front corner partial modesty executive	66
straight front corner partial modesty professional	67
straight front corner full modesty no gables executive	68

straight front corner full modesty no gables professional	69
curved front corner full modesty executive	70
curved front corner full modesty professional	71
curved front corner partial modesty executive	72
curved front corner partial modesty professional	73
curved front corner full modesty no gables executive	74
curved front corner full modesty no gables professional	75
Unitized Desks	76
curved front w/full modesties, full and partial gables executive	78
curved front w/full modesties, full and partial gables professional	79
curved front w/full modesties, no gables executive	80
curved front w/full modesties, no gables professional	81
curved front w/partial modesty executive	82
curved front w/ partial modesties professional	83
Bridges	84
bowed bridge full modesty executive	86
bowed bridge full modesty professional	87
bowed bridge partial modesty executive	88
bowed bridge partial modesty professional	89
Returns	90
straight return full modesty executive	92
straight return full modesty professional	94
straight return partial modesty executive	96
straight return partial modesty professional	98
double lateral file executive	102
double lateral file professional	103
double storage cabinet executive	104
double storage cabinet professional	105
lateral file and storage cabinet executive	106
lateral file and storage cabinet professional	107
lateral file and storage cabinet executive	108
lateral file and storage cabinet professional	109
tops executive	110
tops professional	111
open w door executive	112
open w door professional	112

Supports	114
intermediate support	116
cantilever	117
reinforcement bar	118
Filing & Storage	120
pedestals	122
pedestals w/ seat cushion	124
underdesk storage cabinet	125
underdesk combo pedestal BBF & FF	126
underdesk 2-drawer lateral file	127
freestanding storage cabinet executive	128
freestanding storage cabinet professional	129
freestanding combo pedestal BBF & FF executive	130
freestanding combo pedestal BBF & FF professional	131
freestanding 2-drawer lateral file executive	132
freestanding 2-drawer lateral file professional	133
freestanding 3-drawer lateral file executive	134
freestanding 3-drawer lateral file professional	135
freestanding 4-drawer lateral file executive	136
freestanding 4-drawer lateral file professional	137
freestanding storage tower executive	138
freestanding storage tower professional	139
freestanding combo storage tower BBF executive	140
freestanding combo storage tower BBF professional	141
freestanding combo storage tower FF executive	142
freestanding combo storage tower FF professional	143
freestanding wardrobe storage tower executive	144
freestanding wardrobe storage tower professional	145
freestanding storage tower double door executive	146
freestanding storage tower double door professional	147
freestanding combo lateral storage double door executive	148
freestanding combo lateral storage double door professional	149
freestanding combo lateral storage glazed double door executive	150
freestanding combo lateral storage glazed double door professional	151
bookcase executive	152
bookcase professional	154

Overhead Storage	156
open hutch executive	158
open hutch professional	159
hinged door hutch executive	160
hinged door hutch professional	161
glazed door hutch executive	162
glazed door hutch professional	163
open hutch w/ pidgeon holes executive	164
open hutch w/ pidgeon holes professional	165
hinged door hutch w/ pidgeon holes executive	166
hinged door hutch w/ pidgeon holes professional	167
wall mounted hinged door hutch executive	168
wall mounted hinged door hutch professional	169
wall mounted glazed door hutch executive	170
wall mounted glazed door hutch professional	171
Tabletops	172
1.5" Straight Tabletop w/ Grommet executive	174
1" Straight Tabletop w/ Grommet professional	176
1.5" Straight Tabletop - no grommets executive	178
1" Straight Tabletop - no grommets professional	180
1.5" D-Tabletop executive	182
1" D-Tabletop professional	183
1.5" O-Tabletop executive	184
1" O-Tabletop professional	185
Bases	186
cross base	188
post support base	189
open metal gable	190
Reception Unit	192
executive	194
professional	195
Service Write Up Desk	196
w/ Straight Front Countertop executive	198
w/ Straight Front Countertop professional	199
w/ Arc Countertop executive	200
w/ Arc Countertop professional	201

Coffee & End Tables	202
coffee and end table executive	204
coffee and end table professional	205
Conference	206
table top	208
straight tabletop	208
straight tabletop w/power and data	210
boat-shaped tabletop	212
boat-shaped tabletop w/power and data	214
racetrack tabletop	216
racetrack tabletop w/power and data	218
tapered tabletop	220
tapered tabletop w/ power and data	221
table base	222
gable & modesty base	222
elliptical base	226
table base configuration	230
options	231
Ellora Grommet add-ons	231
filing and storage	232
serving cabinet	232
storage cabinet w/shelves	233
combo cabinet w/storage & lateral files	234
double door cabinet w/shelves	235
combo cabinet	236
storage cabinet w/coat bar and shelves	237
computer desk	238
Accessories	240
keyboard tray	242
tackboard for hutch	243
pencil drawer	244
task light	245
monitor arm	246
wire manager	247

Caution

Load Bottom Drawer First

- Operate one drawer at a time
- Units may tip if loaded incorrectly
- Units should be attached to a wall or other furniture to reduce tipping hazard
- Always load the heaviest files in the bottom drawer

Heavy Load

- Some products must be anchored to wall to ensure stability & safety.
- It is the owner and installers responsibility to ensure that the wall type and construction is of sufficient strength to carry the loads of any wall mounted products and their contents.
- Failure of the wall and anchors to support all imposed loads may result in property damage and/or personal injury.
- Tayco can provide size and empty weight of its products only. As wall blocking is considered a building construction process, Tayco cannot provide recommendations in this respect and cannot be responsible for damage or injury that may occur as a result of improper installation and/or blocking.

Instability Hazard

Mobile items on casters such as flip top, personal and movable tables of any type and storage items of any type may present an instability hazard if not secured correctly while in use or in storage. Flip top tables or training tables of any type, are inherently more unstable when folded. Tayco provides the following guidelines & warnings when using mobile products:

- Lock casters immediately after moving. Do not leave the casters unlocked when in use or in storage.
- Motion may increase the instability of any item with casters. If the wheels hit an obstruction the table's forward momentum often causes overturn, especially if the item is not equipped with wheel extensions. Exercise strong caution while moving these items.
- Use caution when abrupt level changes in the floor are present (such as a doorway or room threshold) as caster failure or tipping may result.
- Do not stand, sit or lean on mobile items for support. They are not intended for this use and personal injury or property damage may result.
- Mobile units that feature height adjustable elements must be lowered to the minimum compressed height when moving to prevent instability. It is also recommended the user remove all computer equipment or other accessories to prevent possible weight imbalance or damage to equipment.
- Failure to follow the guidelines above may result in property damage or personal injury.

Overview

Tayco introduces Metro, a full line of case goods and conference furniture.

Metro is divided into three distinct product groups for ease of specifying: Executive, Professional and Conference. The prefix of the product code indicates the product group.

- T – Metro Executive
- TL – Metro Professional
- TB – Metro Conference

Metro Executive and Professional series contain the building blocks for the CEO's office, a flexible team environment or a welcoming reception area. An abundance of freestanding storage towers are available for places to hang your coat, file important papers or store personal items. Whether you need to create an impression, save space or encourage collaboration, Metro does it all.

Metro Conference can be formal or casual, a place for working meetings, video-conferencing or large presentations. It customizes to your needs through a wide selection of sizes and mix-and-match table shapes and base styles. Cabinetry has been made larger to match the proportions of the conference room. Accessory items such as audiovisual cabinets, mobile media centers, lecterns, whiteboards and serving cabinets round out the line.

Metro Executive and Conference feature 1.5"-thick worksurfaces, hutch and freestanding storage tops. These items also have a choice of Straight or Gothic trim styles. Metro Professional has 1"-thick worksurfaces, hutch tops, filing and storage tops with a straight 2-mm vinyl edge.

desks, returns, bridges and credenzas

Desks are available with a choice of recessed or flush modesties. Metro desks, end gables and modesties are made with 45 lb./cubic foot density industrial-grade composite wood core, finished on both sides. Many pieces are available with partial or full modesties. Partial modesties (12"H) should be ordered only for pieces located next to a wall. Otherwise, full modesties should be used.

pedestals

All pedestal drawers are outfitted with full extension slides. Drawers can be easily removed by releasing the small catches on either side of the slide. Pedestals come standard with locks. One lock will lock both file drawers in a file/file pedestal and one box drawer and the file drawer in the box/box/file pedestal. File drawers will accommodate legal- or letter-size documents.

freestanding storage and combo cabinets

Various combination filing and storage units provide a place to hang a coat, store personal items and documents to suit any individual's needs.

intermediate gable supports

Some configurations require the use of an intermediate gable support. This support must be ordered separately. The situations requiring an intermediate gable support are:

- > For use under surfaces 60" wide or greater where there is no filing or storage to support the worksurface (see picture 1). This applies to Metro Professional only. The intermediate support is not necessary for Metro Executive configurations, unless a hutch is placed over a bridge or return surface (see picture 2).

surfaces 60" wide or greater

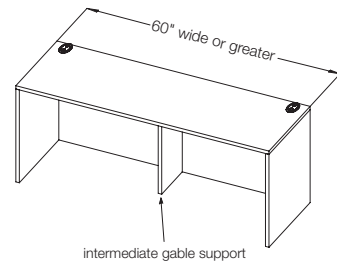

picture 1

under surfaces with a hutch

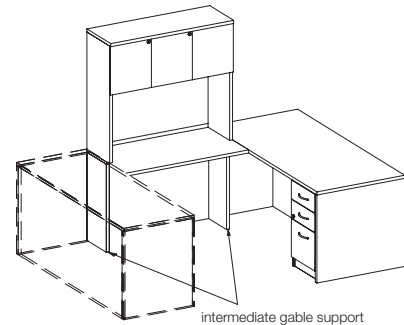

picture 2

- > Under return surfaces where the return meets the primary desk or Peninsula table. This applies to Metro Professional only.

The 12" wide intermediary gable is for 21"- and 24"-deep surfaces and the 18"-wide intermediate gable is used with 30"- and 36"-deep worksurfaces.

universal gable support

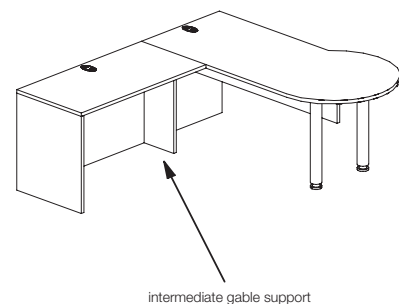

picture 3

accessories

Computer accessories include flat-screen monitor arms, articulating keyboard trays and CPU holders.

Heavy-duty flat-screen monitor arms adjust to the user while storing wires within the arm. The monitor mounting plate meets VESA standards to accommodate most monitors. Monitor arms can be grommet- or clamp-mounted to the worksurface. Articulating and retractable keyboard trays and mobile or underdesk-mounted CPU holders complete the workstation.

Hutch-mounted tackboards can be finished in any Tayco standard fabric to match the office decor. The conference room whiteboard comes standard with a dry erase board and two fabric-wrapped tackboards.

Standard task lights are available in two sizes and come with vertical wire management. An optional task light is available.

hutches and cabinets

Hutch and cabinet doors come in a choice of classic laminate or aluminum-framed frosted acrylic. Hutches with laminate doors always come standard with locking doors.

Hutches come open or closed, with or without pigeonholes and a flexible apron for wire management. Optional hutch mounted tackboards finished in any of Tayco fabrics can be ordered to complete the look.

coffee and end tables

Metro coffee and end tables coordinate with reception units and are available with or without a fixed shelf.

bookcases

Straight and radius bookcases have height-adjustable shelves with the exception of any desk-height shelves. They are fixed to add structural stability to the bookcase.

handle details

Six handle options are available in choice of colors. Melbourne is the standard handle option unless otherwise specified on your Purchase Order. All Executive and Professional handles are 5" long.

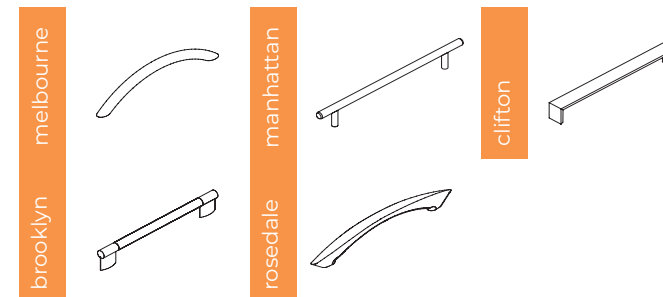

default vinyl color selections

Each laminate comes with matching vinyl trim color unless otherwise specified on your purchase order. Refer to the laminate finish card for details.

edge profile

Metro Executive, Professional and Conference is available in a straight edge profile.



Straight profile is available in:

- > Executive
- > Professional
- > Conference

decorative trim placement

Generally the decorative trim is placed on the exposed surface edge.
Straight trim is applied to surface edges that are placed next to a wall or another surface.

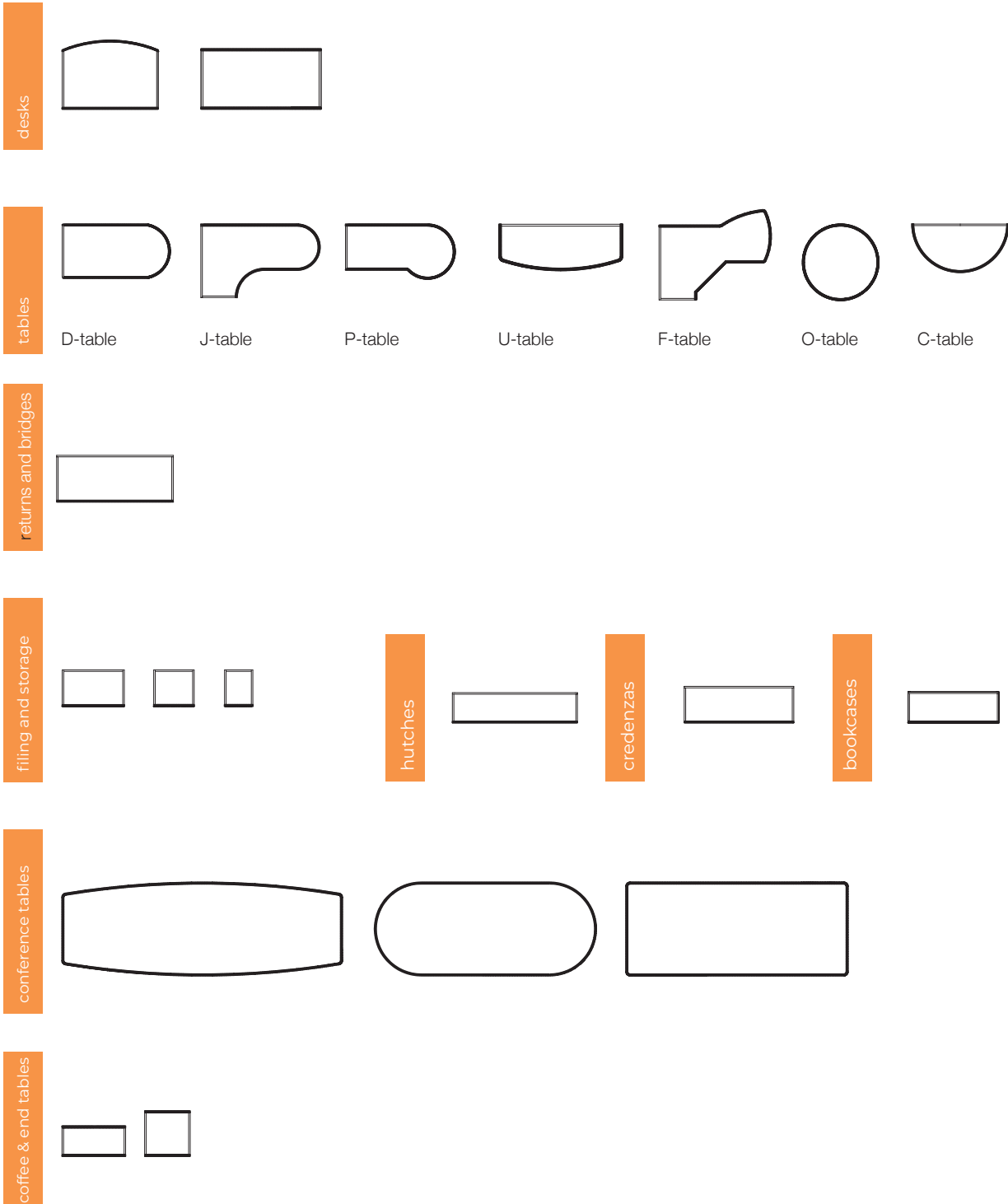

grain direction

Horizontal Surfaces

When ordering a directional laminate, the grain will run the direction of the width of the worksurface (excluding bridge surfaces), hutch or storage top. Grain on bridge modesty runs vertically so the grain will run the same direction on the entire suite.

Vertical Surfaces

Directional laminates run vertically on vertical surfaces such as cabinet doors, pedestal drawer fronts and gables, as well as all cabinet, lateral file and pedestal kick-plates. The grain runs horizontally across the width of modesty panels.

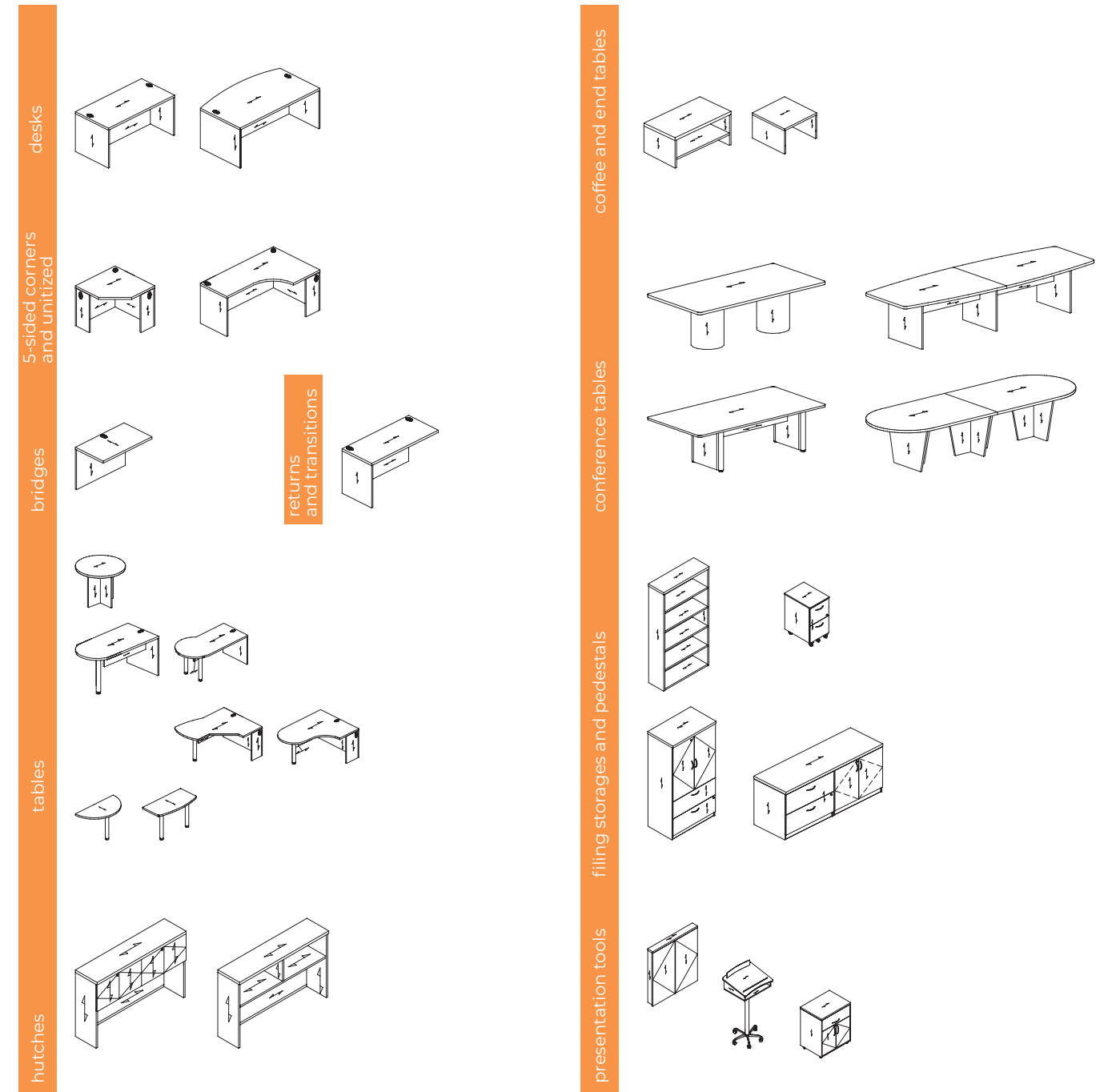

Note: Boardroom tables with tops comprised of 2 or more pieces will not have a consistent grain pattern.

filing options

Pedestal file drawers can accommodate letter- or legal-size documents. Letter-size papers can be filed either front to back or side to side. Lateral drawers can accommodate front to back or side to side filing of legal- or letter-size documents.

Disclaimer: Please note that lateral file drawers are intended for filing letter and legal size paper front to back or side to side only. For details and weight restrictions please contact customer service.

lateral file drawers

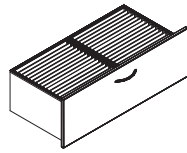

Lateral File Drawer (36W & 42W)
Legal filing – front to back
Underdesk: 15"
Freestanding: 15"

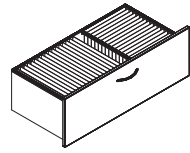

Lateral File Drawer (36W & 42W)
Legal filing – side to side
Letter filing – front to back
Underdesk: 15"
Freestanding: 15"

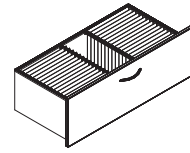

Lateral File Drawer (30W, 36W & 42W)
Letter filing – front to back
Underdesk: 15"
Freestanding: 15"

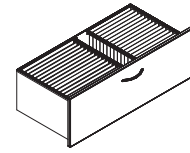

Lateral File Drawer (36W & 42W)
Letter & legal filing – front to back
Underdesk: 15"
Freestanding: 15"

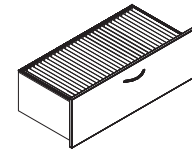

Lateral File Drawer (30W, 36W & 42W)
Legal filing – side to side
Underdesk:
30W-25½"
36W-31½"
42W-37½"

Freestanding:
30W-25½"
36W-31½"
42W-37½"

box drawer



Box Drawer
Box Height: 3"
Box Depth: 15"
Box Width: 12"

file drawers

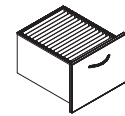

File Drawer
Letter filing – front to back
Underdesk: 15"
Freestanding: 15"

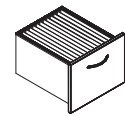

File Drawer
Legal filing – side to side
Underdesk: 12"
Freestanding: 12"

grommets

Grommets are available in black or silver to coordinate with furniture.

Black is the standard grommet option unless otherwise specified on your Purchase Order.

Components Including Grommets

- > Peninsula tables
- > Arc desks with pedestals
- > Straight desks with recessed modesties and pedestals

Straight desks with flush modesties and without pedestals

- > Returns without pedestals
- > 24" deep returns with pedestal
- > 30" deep returns with pedestal
- > 24" deep desks with flush modesties and pedestals
- > 30" deep desks with flush modesties and pedestals
- > 36" deep desks with flush modesties and pedestals
- > Bridges
- > Straight transition worksurfaces
- > 5-sided corner worksurfaces
- > Unitized desks
- > Reception units

Components Available With or Without Grommets

- > Arc desks without pedestals
- > Straight desks with recessed modesties and without pedestals

Components Without Grommets

- > Credenzas
- > 21" deep desks with pedestal
- > 21" deep returns with pedestal
- > "U" and "C" Tables

Grommet Placement

Surfaces up to and including 48" wide have one grommet located at back center of the surface. Surfaces 54" wide and wider have two grommets at either side of the back of the surface.

Statement of Line

Professional Desks

1" Thick Desks

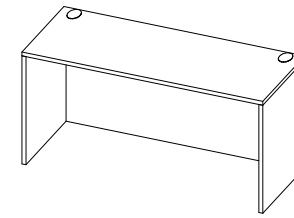

TL-TSOG
Straight w/ Full Modesty
W: 30"- 96"
D: 21"- 30"
H: 29"

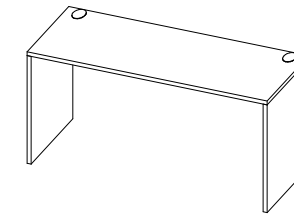

TL-TSOZ
Straight w/ Partial Modesty
W: 30"- 96"
D: 21"- 30"
H: 29"

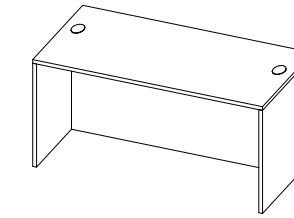

TL-TSRG
Straight w/ Full Recessed Modesty
W: 60"- 96"
D: 30"- 36"
H: 29"

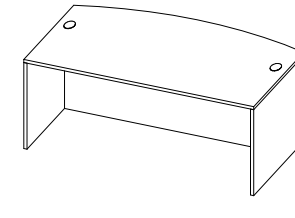

TL-TARG
Arc w/ Full Recessed Modesty
W: 72"- 96"
D: 36"
H: 29"

Professional Tables

1" Thick

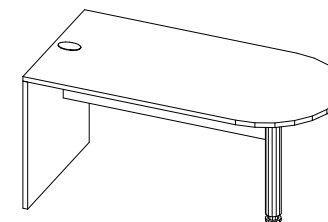

TL-TD0G
D-Table
W: 60"- 84"
D: 30"-36"
H: 29"

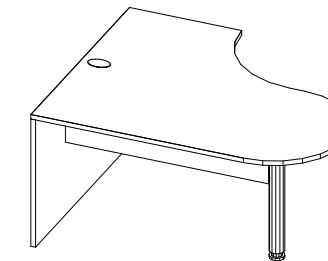

TL-TJ0G-L / TL-TJ0G-R
J-Table (Left Hand shown)
W: 60"- 84"
D: 24"
H: 29"

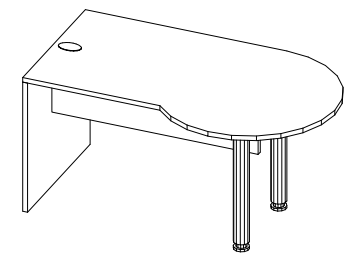

TL-TP0G-L / TL-TP0G-R
P-Table (Left Hand shown)
W: 60"- 84"
D: 30"
H: 29"

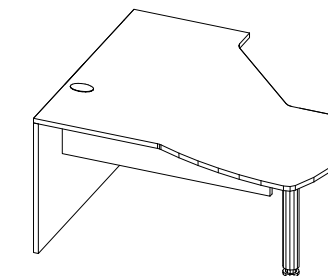

TL-TFSG-L / TL-TFSG-R
F-Table (Left Hand shown)
W: 60"- 84"
D: 24"
H: 29"

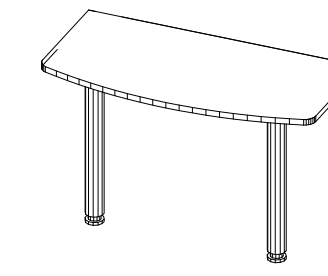

TL-WEU0
U-Table
W: 42"- 60"
D: 24"
H: 29"

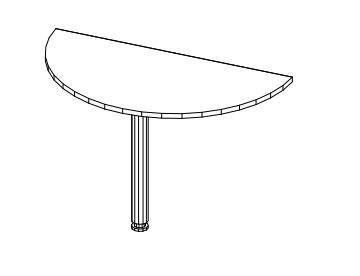

TL-TC00
C-Table
W: 42"- 60"
D: 21"-30"
H: 29"

Executive Desks

1.5" Thick Desks

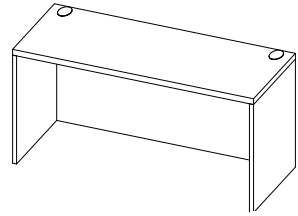

T-TSOG
Straight w/ Full Modesty
W: 30"- 96"
D: 21"- 30"
H: 29.5"

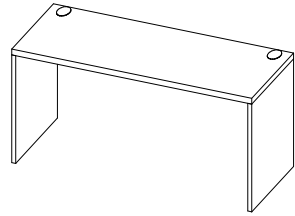

T-TSOZ
Straight w/ Partial Modesty
W: 30"- 96"
D: 21"-30"
H: 29.5"

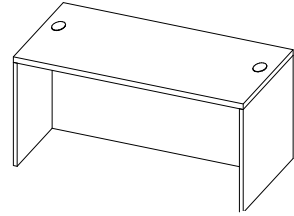

T-TSRG
Straight w/ Full Recessed Modesty
W: 60"- 96"
D: 30"-36"
H: 29.5"

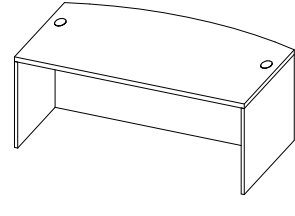

T-TARG
Arc w/ Full Recessed Modesty
W: 72"- 96"
D: 36"
H: 29.5"

Executive Tables

1.5" Thick

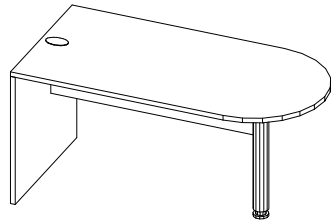

T-TD0G
D-Table
W: 60"- 84"
D: 30"- 36"
H: 29.5"

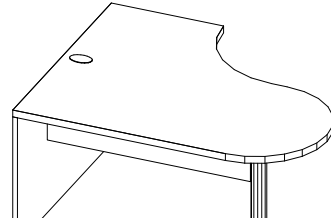

T-TJ0G-L / T-TJ0G-R
J-Table (Left Hand shown)
W: 60"- 84"
D: 24"
H: 29.5"

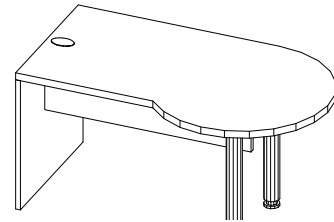

T-TP0G-L / T-TP0G-R
P-Table (Left Hand shown)
W: 60"- 84"
D: 30"
H: 29.5"

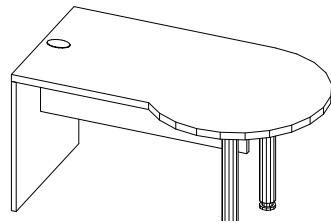

T-TFSG-L / T-TFSG-R
F-Table (Left Hand shown)
W: 60"- 84"
D: 24"
H: 29.5"

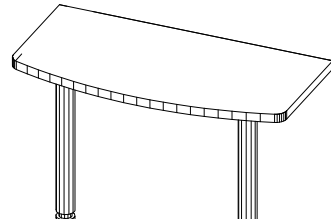

T-WEU0
U-Table
W: 42"- 60"
D: 24"
H: 29.5"

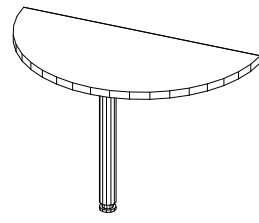

T-TC00
C-Table
W: 42"- 60"
D: 21"-30"
H: 29.5"

Professional Corners

1" Thick

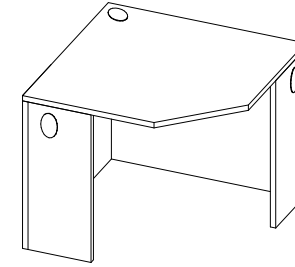

TL-W5S0
Straight Front
Full Modesty w/ Intermediate Gable
W: 36"- 42"
D: 21"- 24"
H: 29"

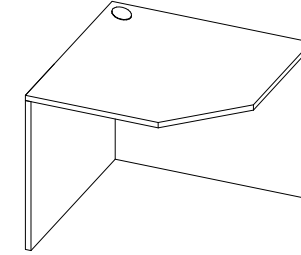

TL-W5S0-N
Straight Front
Full Modesty/ No Intermediate Gable
W: 36"- 42"
D: 21"- 24"
H: 29"

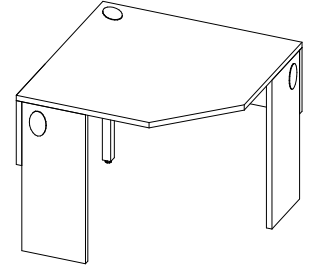

TL-W5S0-P
Straight Front
Partial Modesty w/ Intermediate Gable
W: 36"- 42"
D: 21"- 24"
H: 29"

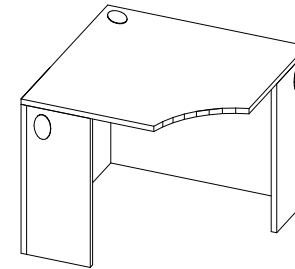

TL-W5C0
Curve Front
Full Modesty w/ Intermediate Gable
W: 36"- 42"
D: 21"- 24"
H: 29"

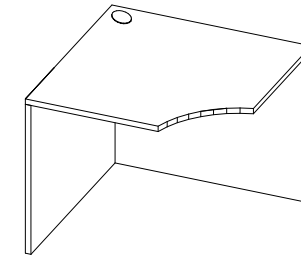

TL-W5C0-N
Curve Front
Full Modesty/ No Intermediate Gable
W: 36"- 42"
D: 21"- 24"
H: 29"

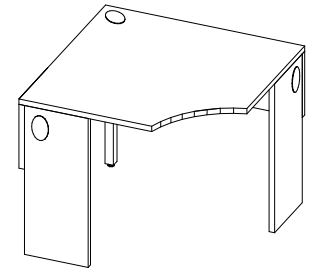

TL-W5C0-P
Curve Front
Partial Modesty w/ Intermediate Gable
W: 36"- 42"
D: 21"- 24"
H: 29"

Professional Unitized Desks

1" Thick

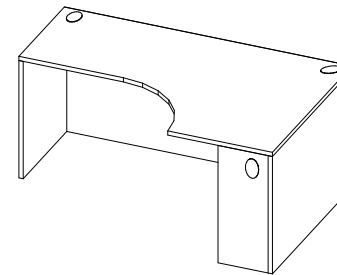

TL-UC4G-L / TL-UC4G-R
Unitized Desk (Left Hand shown)
Full Modesty w/ Intermediate Gable
W: 66"- 72"
D: 39"- 42"
Other D: 21" - 24"
H: 29"

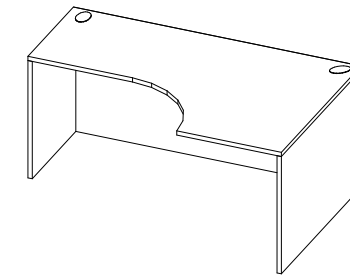

TL-UC4G-L-N / TL-UC4G-R-N
Unitized Desk - (Left Hand shown)
Full Modesty/ No Intermediate Gable
W: 66"- 72"
D: 39"- 42"
Other D: 21" - 24"
H: 29"

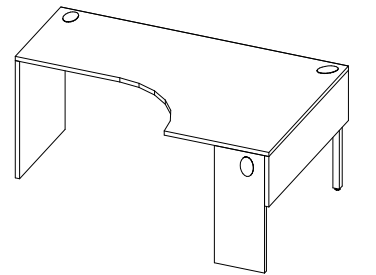

TL-UC4Z-L / TL-UC4G-R
Unitized Desk (Left Hand shown)
Partial Modesty w/ Intermediate Gable
W: 66"- 72"
D: 39"- 42"
Other D: 21" - 24"
H: 29"

Executive Corners

1.5" Thick

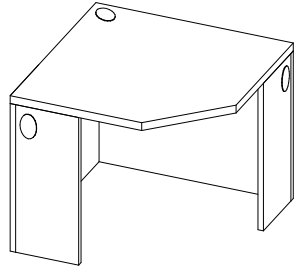

T-W5S0
Straight Front
Full Modesty w/ Intermediate Gable
W: 36" - 42"
D: 21" - 24"
H: 29.5"

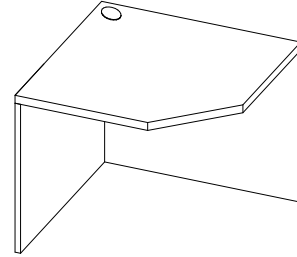

T-W5S0-N
Straight Front
Full Modesty/ No Intermediate Gable
W: 36" - 42"
D: 21" - 24"
H: 29.5"

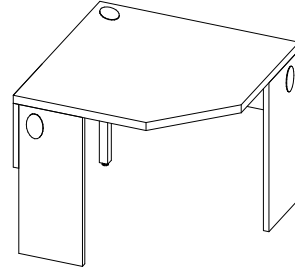

T-W5S0-P
Straight Front
Partial Modesty w/ Intermediate Gable
W: 36" - 42"
D: 21" - 24"
H: 29.5"

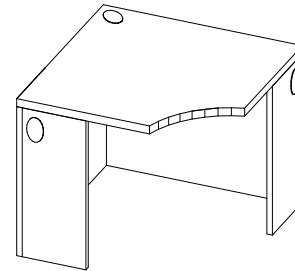

T-W5C0
Curve Front
Full Modesty w/ Intermediate Gable
W: 36" - 42"
D: 21" - 24"
H: 29.5"

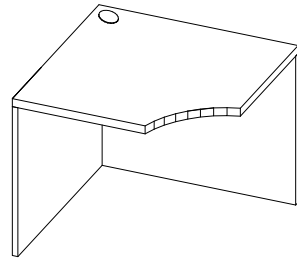

T-W5C0-N
Curve Front
Full Modesty/ No Intermediate Gable
W: 36" - 42"
D: 21" - 24"
H: 29.5"

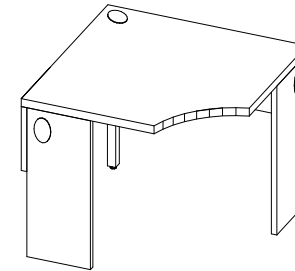

T-W5C0-P
Curve Front
Partial Modesty w/ Intermediate Gable
W: 36" - 42"
D: 21" - 24"
H: 29.5"

Executive Unitized Desks

1.5" Thick

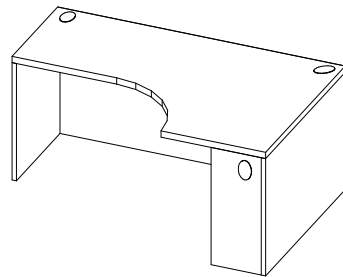

T-UC4G-L / T-UC4G-R
Unitized Desk (Left Hand shown)
Full Modesty w/ Intermediate Gable
W: 66" - 72"
D: 39" - 42"
Other D: 21" - 24"
H: 29.5"

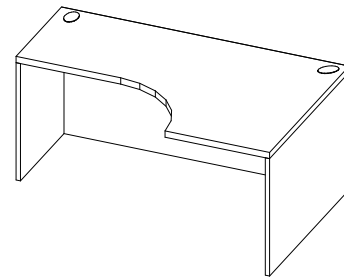

T-UC4G-L-N / T-UC4G-R-N
Unitized Desk (Left Hand shown)
Full Modesty/ No Intermediate Gable
W: 66" - 72"
D: 39" - 42"
Other D: 21" - 24"
H: 29.5"

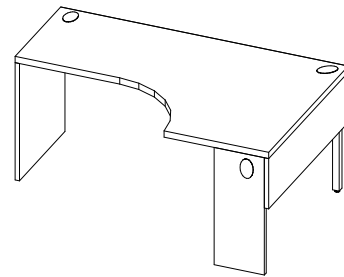

T-UC4Z-L / T-UC4G-R
Unitized Desk (Left Hand shown)
Partial Modesty w/ Intermediate Gable
W: 66" - 72"
D: 39" - 42"
Other D: 21" - 24"
H: 29.5"

Professional Bridges

1" Thick

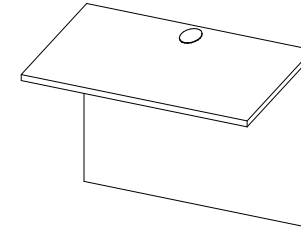

TL-BS0G
Straight w/ Full Modesty
W: 30" - 48"
D: 21" - 24"
H: 29"

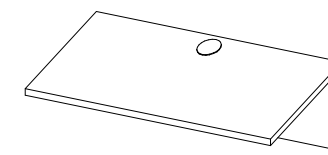

TL-BS0Z
Straight w/ Partial Modesty
W: 30" - 48"
D: 21" - 24"
H: 29"

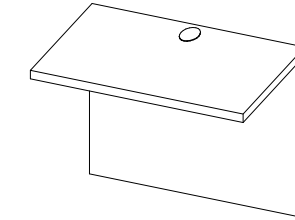

T-BS0G
Straight w/ Full Modesty
W: 30" - 48"
D: 21" - 24"
H: 29.5"

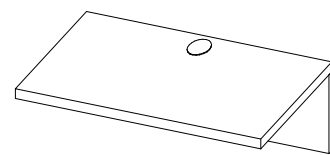

T-BS0Z
Straight w/ Partial Modesty
W: 30" - 48"
D: 21" - 24"
H: 29.5"

Professional Returns

1" Thick

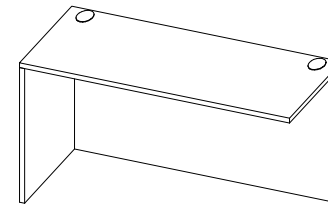

TL-WS1G-L / TL-WS1G-R
Straight w/ Full Modesty
(Left Hand shown)
W: 24" - 60"
D: 21" - 30"
H: 29"

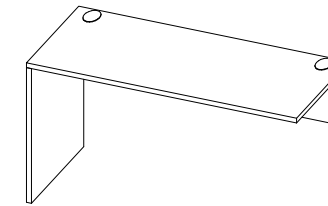

TL-WS1Z-L / TL-WS1Z-R
Straight w/ Partial Modesty
(Left Hand shown)
W: 24" - 60"
D: 21" - 30"
H: 29"

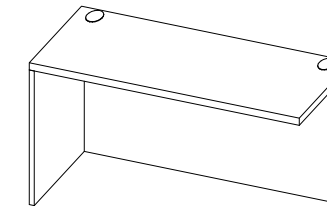

T-WS1G-L / T-WS1G-R
Straight w/ Full Modesty
(Left Hand shown)
W: 24" - 60"
D: 21" - 30"
H: 29.5"

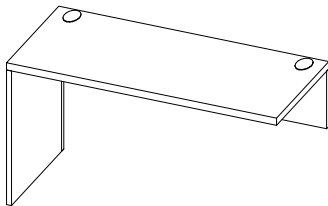

T-WS1Z-L / T-WS1Z-R
Straight w/ Partial Modesty
(Left Hand shown)
W: 24" - 60"
D: 21" - 30"
H: 29.5"

Credenza Top

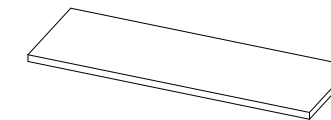

T-WSS0
1.5" Thick Credenza Top
W: 60" - 84"
D: 21"

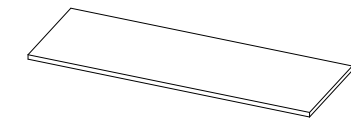

TL-WSS0
1" Thick Credenza Top
W: 60" - 84"
D: 21"

Professional Credenzas

1" Thick

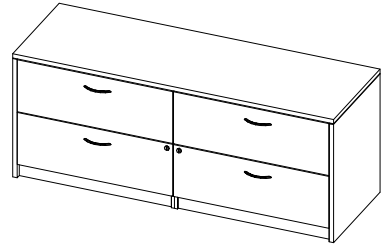

TL-CRLL
Credenza w/ Double Lateral
Files
W: 72"
D: 21" - 24"
H: 29"

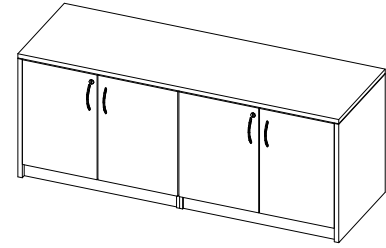

TL-CRSS
Credenza w/ Double Stor-
age Files
W: 72"
D: 21" - 24"
H: 29"

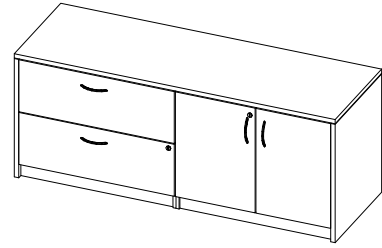

TL-CRLS
Credenza w/ Lateral File LH,
Storage Cabinet RH
W: 72"
D: 21" - 24"
H: 29"

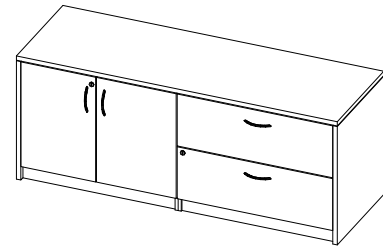

TL-CRSL
Credenza w/ Storage Cabi-
net LH,
Lateral File RH
W: 72"
D: 21" - 24"
H: 29"

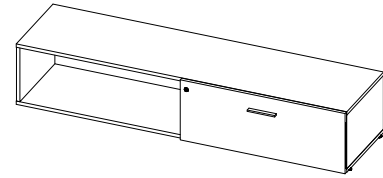

U-CRCL-L / U-CRCL-R
Open Credenza w/ Door
W: 72"
D: 18"
H: 15"

Executive Credenzas

1.5" Thick Top

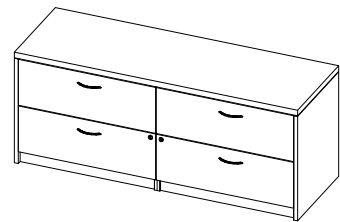

T-CRLL
Credenza w/ Double Lateral
Files
W: 72"
D: 21" - 24"
H: 29.5"

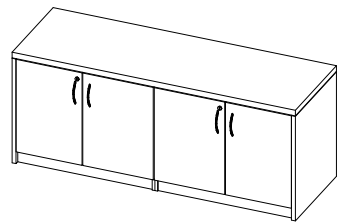

T-CRSS
Credenza w/ Double Stor-
age Files
W: 72"
D: 21" - 24"
H: 29.5"

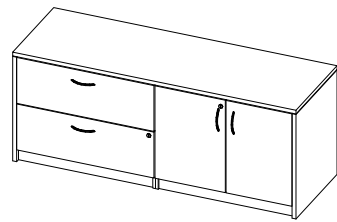

T-CRLS
Credenza w/ Lateral
File LH,
Storage Cabinet RH
W: 72"
D: 21" - 24"
H: 29.5"

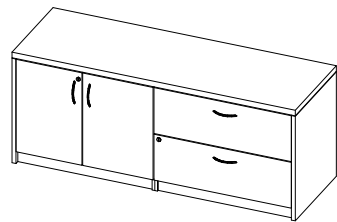

T-CRSL
Credenza w/ Storage Cabi-
net LH,
Lateral File RH
W: 72"
D: 21" - 24"
H: 29.5"

Supports

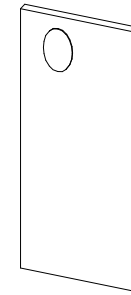

T-CGUO
Intermediate Gable Support
W: 12" - 18"
D: 1"
H: 28"

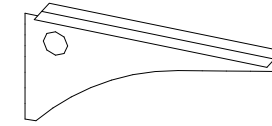

K-CCAB
Center Cantilever Support
W: 16" - 22"

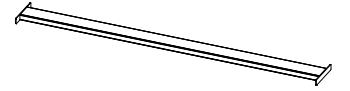

U-HRBO
Reinforcement Bar
W: 27" - 90"

Pedestals

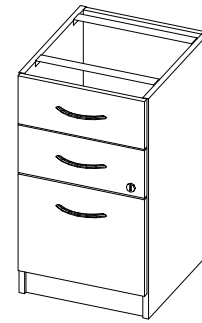

T-FPBU
Underdesk Box/Box/File
W: 16"
D: 18" - 24"
H: 28"

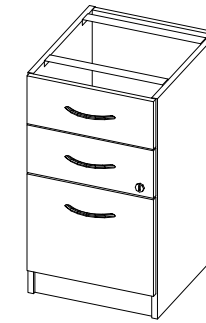

T-FPBU-X
Underdesk Box/Box/File
Full Back
W: 16"
D: 18" - 24"
H: 28"

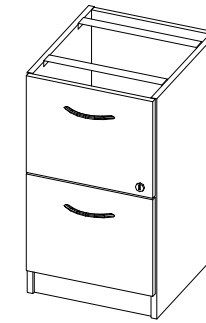

T-FPFU
Underdesk File/File
W: 16"
D: 18" - 24"
H: 28"

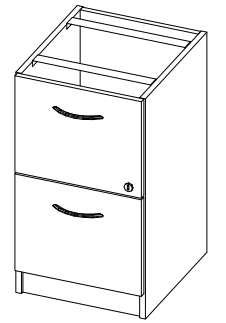

T-FPFU-X
Underdesk File/File
Full Back
W: 16"
D: 18" - 24"
H: 28"



T-FPSU
Suspended Box/File
W: 16"
D: 18"
H: 16"

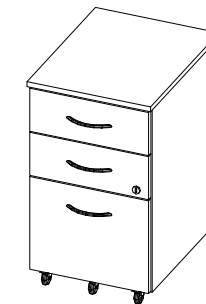

T-FPBM
Mobile Box/Box/File
W: 16"
D: 21"
H: 28"

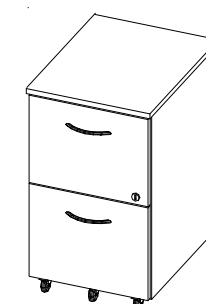

T-FPFM
Mobile File/File
W: 16"
D: 21"
H: 28"

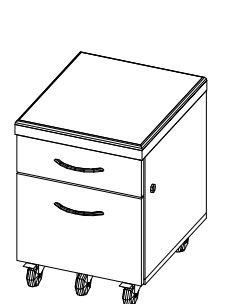

T-1030
Mobile Box/File w/ Seat
Cushion
W: 16"
D: 18"
H: 23"

Filing & Storage

Professional & Executive

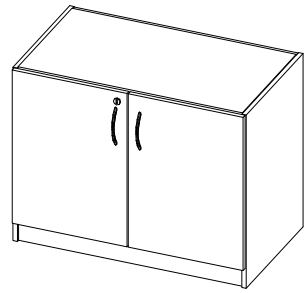

T-FSUO
Underdesk Storage Cabinet
W: 30" - 42"
D: 19" - 21"
H: 28"

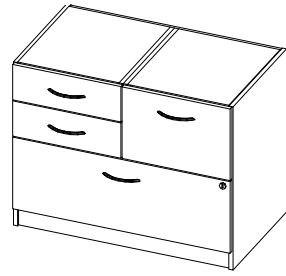

T-FPJU-L / T-FPJU-R
Underdesk Combo Pedestal
w/Box/Box/File and File/File
LH/ RH (LH shown)
W: 36"
D: 20" - 21"
H: 28"

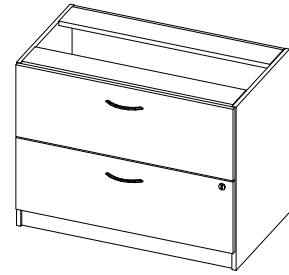

T-FL2U
Underdesk 2-Drawer Lat-
eral File
W: 30" - 42"
D: 20" - 21"
H: 28"

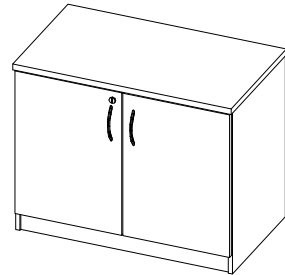

T-FSFO
1.5" Freestanding Storage
Cabinet
W: 30" - 42"
D: 21"
H: 29.5"

Professional Filing & Storage

1" Thick

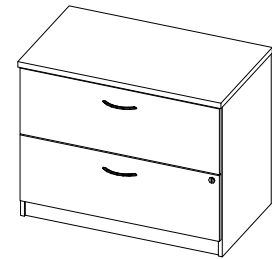

TL-FL2F
Freestanding 2-Drawer Lateral File
W: 30" - 42"
D: 21"
H: 29"

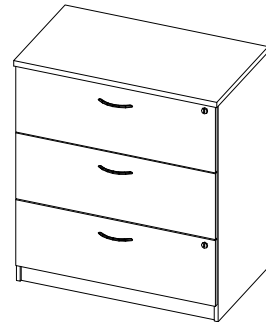

TL-FL3F
Freestanding 3-Drawer Lateral File
W: 30" - 36"
D: 21"
H: 40"

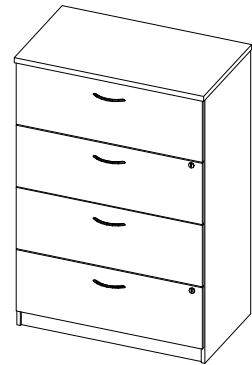

TL-FL4F
Freestanding 4-Drawer Lateral File
W: 30" - 36"
D: 21"
H: 52"

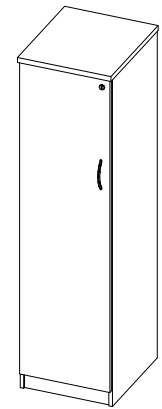

TL-FSDS-L / TL-FSDS-R
Storage Cabinet w/
Shelves
(Left Hand shown)
W: 18"
D: 21"
H: 67"

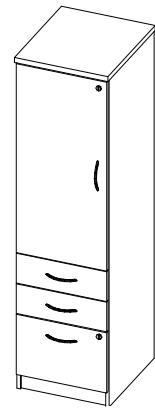

TL-FCSB-L / TL-FCSB-R
Combo Cabinet w/Storage
and Box/Box/File
(Left Hand shown)
W: 18"
D: 21"
H: 67"

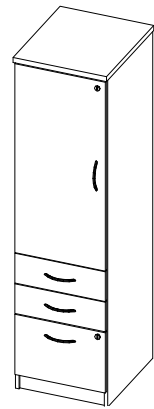

TL-FCSF-L / TL-FCSF-R
Combo Cabinet w/
Storage and File/File
(Left Hand shown)
W: 18"
D: 21"
H: 67"

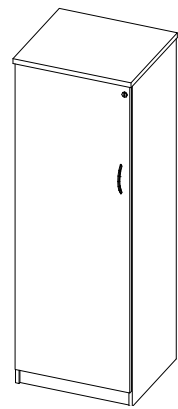

TL-FSDC-L / TL-FSDC-R
Storage Cabinet w/ Coat
Bar and Shelves
(Left Hand shown)
W: 24"
D: 21"
H: 67"

Professional Filing & Storage

1" Thick

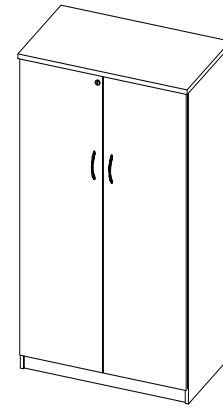

TL-FSDS
Double Door Storage
Cabinet
w/ Shelves
W: 36"
D: 21"
H: 67"

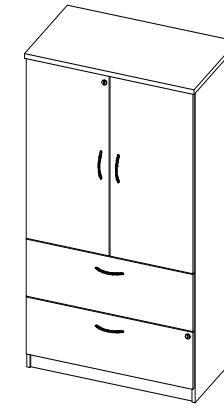

TL-FCSL
Combo Cabinet w/Storage
and Lateral File
W: 36"
D: 21"
H: 67"

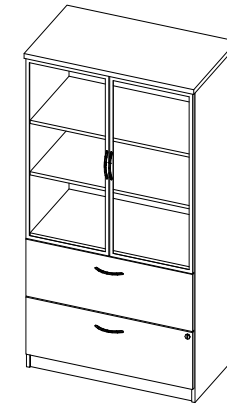

TL-FCSL-G
Combo Cabinet w/Storage,
Lateral File, Glazed Double
Doors
W: 36"
D: 21"
H: 67"

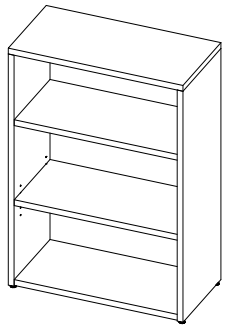

TL-SBOX
Bookcase
W: 24" - 42"
D: 12"/ 15"/ 21"
H: 29"/ 42"/ 54"/ 67"/ 77"

Executive Filing & Storage

1.5" Thick

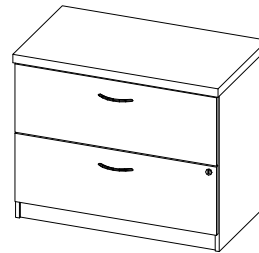

T-FL2F
Freestanding 2-Drawer Lateral File
W: 30" - 42"
D: 21"
H: 29.5"

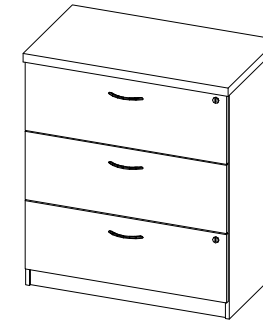

T-FL3F
Freestanding 3-Drawer Lateral File
W: 30" - 36"
D: 21"
H: 40.5"

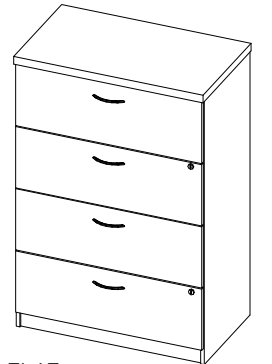

T-FL4F
Freestanding 4-Drawer Lateral File
W: 30" - 36"
D: 21"
H: 52.5"

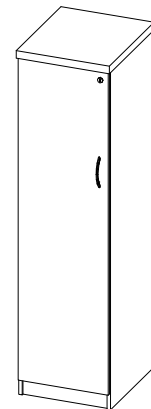

T-FSDS-L / T-FSDS-R
Storage Cabinet w/ Shelves
(Left Hand shown)
W: 18"
D: 21"
H: 68"

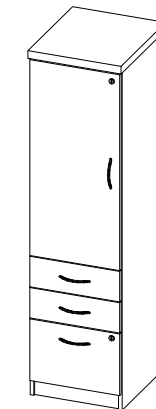

T-FCSB-L / T-FCSB-R
Combo Cabinet w/Storage
and Box/Box/File
(Left Hand shown)
W: 18"
D: 21"
H: 68"

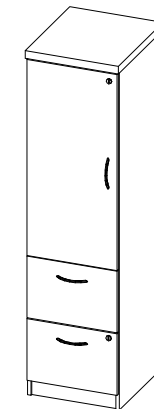

T-FCSF-L / T-FCSF-R
Combo Cabinet w/Storage
and File/File
(Left Hand shown)
W: 18"
D: 21"
H: 68"

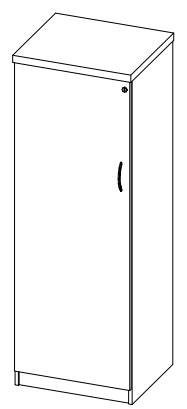

T-FSDC-L / T-FSDC-R
Storage Cabinet w/ Coat Bar
and Shelves
(Left Hand shown)
W: 24"
D: 21"
H: 68"

Executive Filing & Storage

1.5" Thick

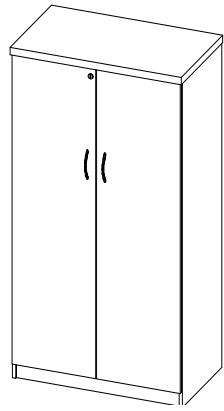

T-FSDS
Double Door Storage Cabinet
w/ Shelves
W: 36"
D: 21"
H: 68"

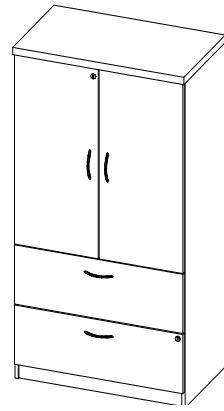

T-FCSL
Combo Cabinet w/Storage
and Lateral File
W: 36"
D: 21"
H: 68"

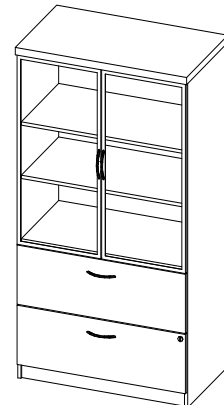

T-FCSL-G
Combo Cabinet w/Storage,
Lateral File. Glazed Double
Doors
W: 36"
D: 21"
H: 68"

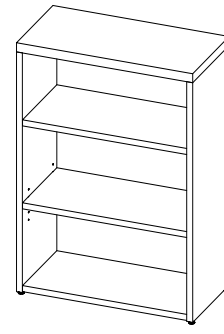

T-SBOX
Bookcase
W: 24" - 42"
D: 12"/15"/21"
H: 29"/42"/54"/68"/78"

Professional Overhead Storage

1" Thick

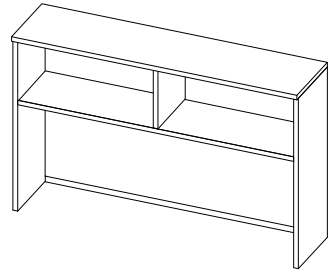

TL-SH00
Open Hutch
W: 30" - 84"
D: 15"
H: 38.5"

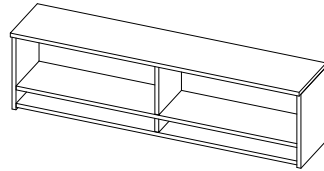

TL-SHOS
Wall Mounted Open Hutch
W: 72"
D: 15.5"
H: 20.19"

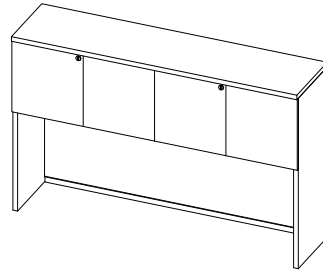

TL-SHH0
Hinged Door Hutch
W: 30" - 84"
D: 15"
H: 38.5"

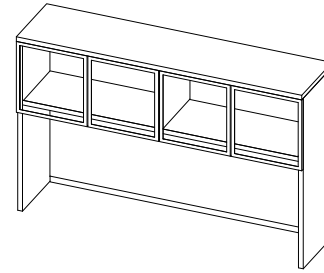

TL-SHH0-G
Hinged Door Hutch w/ Acrylic
Doors
W: 30" - 84"
D: 15"
H: 38.5"

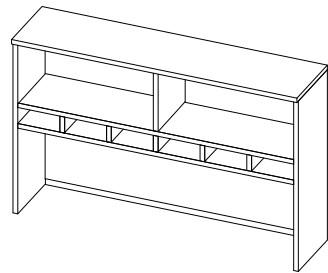

TL-SHOP
Open Hutch w/ Pigeon Holes
W: 30" - 84"
D: 15"
H: 38.5"

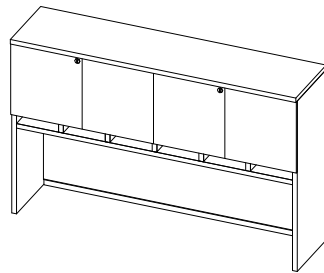

TL-SHHP-L
Hinged Door Hutch w/ Pigeon
Holes
W: 30" - 84"
D: 15"
H: 38.5"

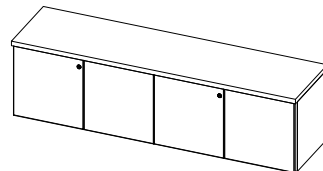

TL-SHHW-L
Wall Mounted Hinged Door
Hutch
W: 30" - 72"
D: 15"
H: 16.5"

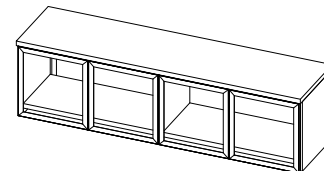

TL-SHHW-G
Wall Mounted Hinged Door
Hutch w/ Acrylic Doors
W: 30" - 72"
D: 15"
H: 16.5"

Executive Overhead Storage

1.5" Thick

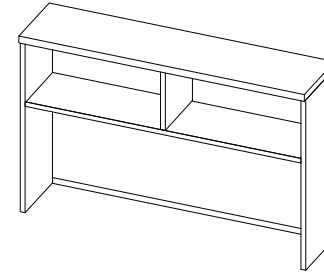

T-SH00
Open Hutch
W: 30" - 84"
D: 15"
H: 38.5"

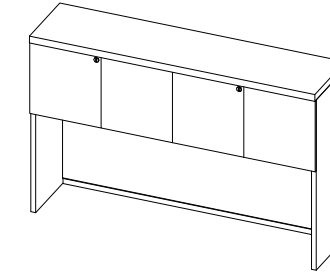

T-SHH0
Hinged Door Hutch
W: 30" - 84"
D: 15"
H: 38.5"

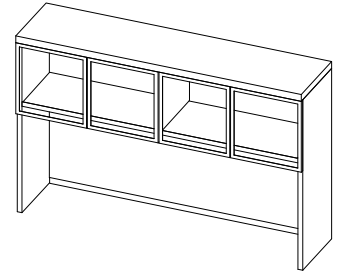

T-SHH0-G
Hinged Door Hutch w/ Acrylic
Doors
W: 30" - 84"
D: 15"
H: 38.5"

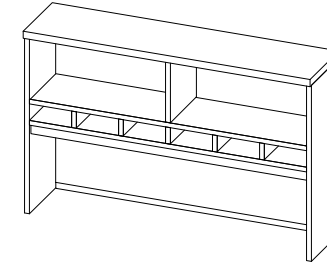

T-SHOP
Open Hutch w/ Pigeon Holes
W: 30" - 84"
D: 15"
H: 38.5"

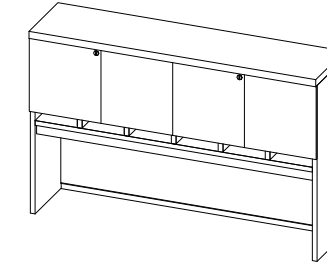

T-SHHP-L
Hinged Door Hutch w/ Pigeon
Holes
W: 30" - 84"
D: 15"
H: 38.5"

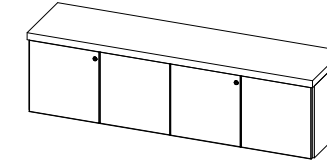

T-SHHW-L
Wall Mounted Hinged Door
Hutch
W: 30" - 72"
D: 15"
H: 16.5"

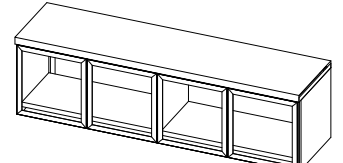

T-SHHW-G
Wall Mounted Hinged Door
Hutch w/ Acrylic Doors
W: 30" - 72"
D: 15"
H: 16.5"

Professional Table Tops

1" Thick

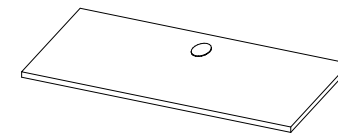

U-WS0G
Straight Tabletop w/ Grom-
met
W: 18" - 96"
D: 18" - 36"

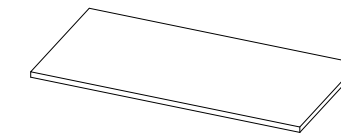

U-WS0N
Straight Tabletop - No Grom-
met
W: 18" - 96"
D: 18" - 36"

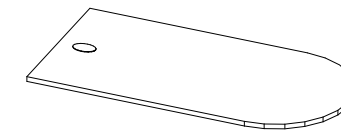

U-WDTG
D-Tabletop
W: 60" - 84"
D: 24" - 36"

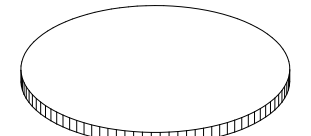

TL-WOXX
O-Tabletop
W: 24" - 60"
D: 24" - 60"

Executive Table Tops

1.5" Thick

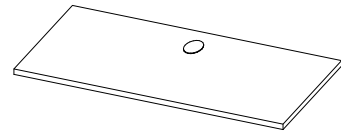

U-WS0G
Straight Tabletop w/ Grom-
met
W: 18" - 96"
D: 18" - 36"

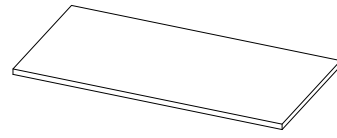

U-WS0N
Straight Tabletop - No Grom-
met
W: 18" - 96"
D: 18" - 36"

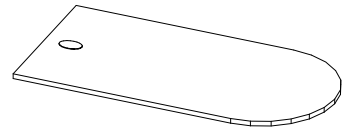

U-WDTG
D-Tabletop
W: 60" - 84"
D: 24" - 36"

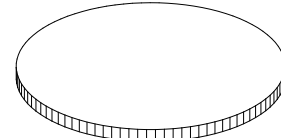

TL-WOXX
O-Tabletop
W: 24" - 60"
D: 24" - 60"

Bases

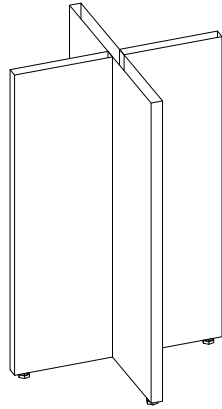

T-B6
Cross Base
W: 18" - 48"
D: 18" - 48"
H: 28"

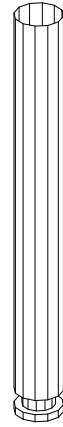

TB-BASE-1
Post Support Base
W: 3"
D: 3"
H: 28"

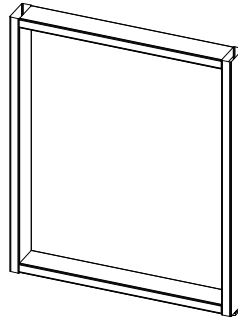

U-CG0M
Open Metal Gable
W: 12" - 36"
D: 3"
H: 28"/13.81"

Professional Reception Unit

1" Thick

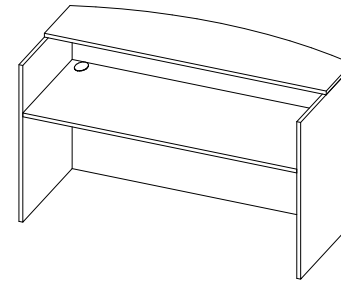

TL-RCOG
Reception Unit w/ Countertop
W: 72"
D: 30"
H: 43"

Executive Reception Unit

1.5" Thick

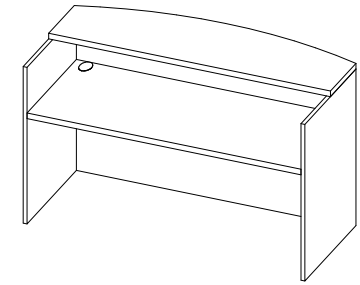

T-RCOG
Reception Unit w/ Countertop
W: 72"
D: 30"
H: 43"

Professional Service Write Up Desk

1" Thick

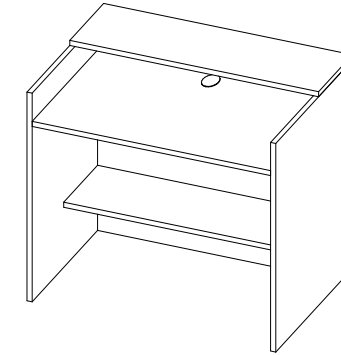

TL-RCWG-S
Service Write Up Desk w/ Straight
Countertop
W: 30 - 84"
D: 30"
H: 43"

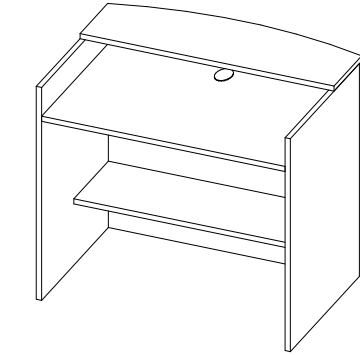

TL-RCWG-A
Service Write Up Desk w/ Arc Counter-
top
W: 30 - 84"
D: 30"
H: 43"

Executive Service Write Up Desk

1.5" Thick

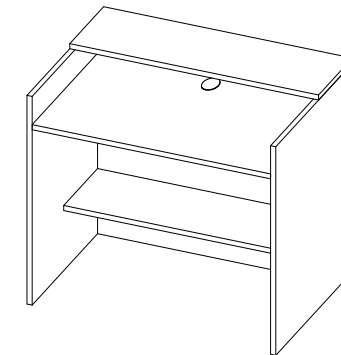

T-RCWG-S
Service Write Up Desk w/ Straight
Countertop
W: 30 - 84"
D: 30"
H: 43"

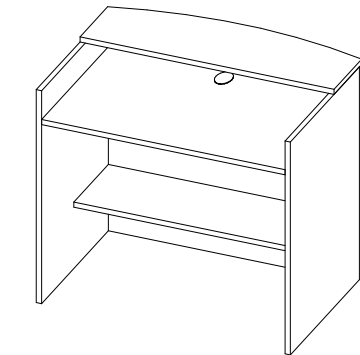

T-RCWG-A
Service Write Up Desk w/ Arc Counter-
top
W: 30 - 84"
D: 30"
H: 43"

Professional Coffee & End Table

1" Thick

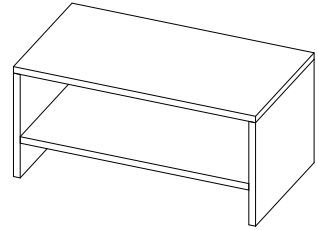

TL-TCTO
Coffee Table
W: 36" - 48"
D: 20"
H: 17"

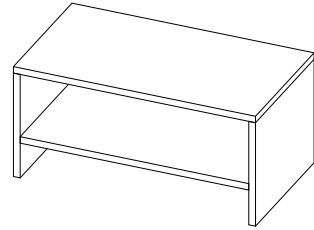

TL-TCTS
Coffee Table with Fixed
Shelf
W: 36"
D: 20"
H: 17"

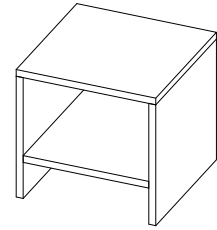

TL-TCTO
End Table
W: 20" - 30"
D: 20" - 30"
H: 19"

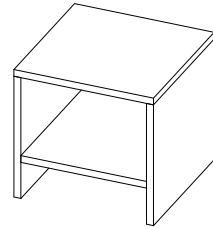

TL-TCTS
End Table with Fixed
Shelf
W: 20" - 30"
D: 20" - 30"
H: 19"

Executive Coffee & End Table

1.5" Thick

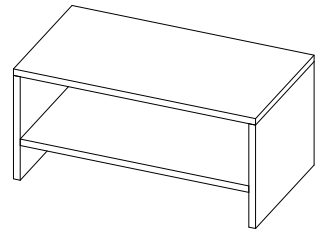

T-TCTO
Coffee Table
W: 36" - 48"
D: 20"
H: 17.5"

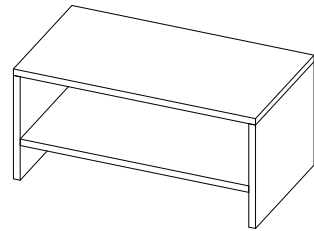

T-TCTS
Coffee Table with Fixed
Shelf
W: 36"
D: 20"
H: 17.5"

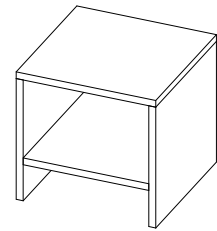

T-TCTO
End Table
W: 20" - 30"
D: 20" - 30"
H: 19.5"

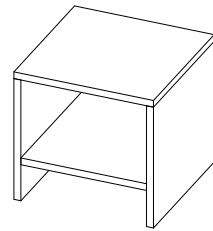

T-TCTS
End Table with Fixed
Shelf
W: 20" - 30"
D: 20" - 30"
H: 19.5"

Conference Table Tops

1.5" Thick

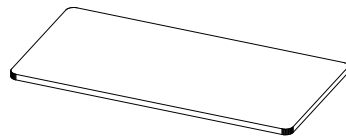

TB-MSSX
Straight Tabletop
W: 72" - 240"
D: 36" - 60"

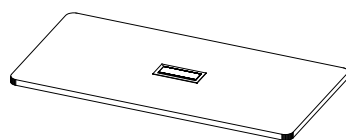

TB-MSSP
Straight Tabletop with
Power
W: 72" - 240"
D: 36" - 60"

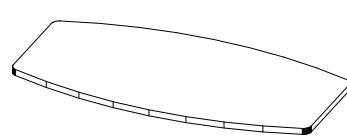

TB-MBBX
Boat-Shaped Tabletop
W: 72" - 240"
D: 36" - 60"

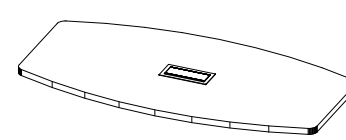

TB-MBBP
Boat-Shaped Tabletop with
Power
W: 72" - 240"
D: 36" - 60"

Conference Table Tops

1.5" Thick

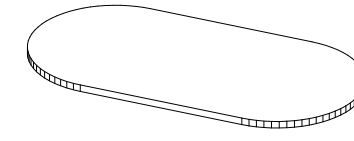

TB-MRRX
Racetrack Tabletop
W: 72" - 240"
D: 36" - 60"

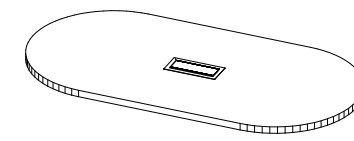

TB-MRRP
Racetrack Tabletop with
Power
W: 72" - 240"
D: 36" - 60"

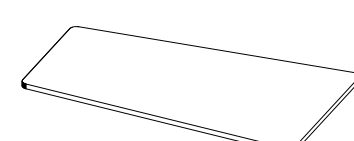

TB-MTTX
Tapered Tabletop
W: 84" - 240"
D: 48" - 78"

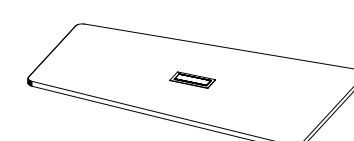

TB-MTTP
Tapered Tabletop with
Power
W: 84" - 240"
D: 48" - 78"

Conference Gable & Modesty Base

1.5" Thick

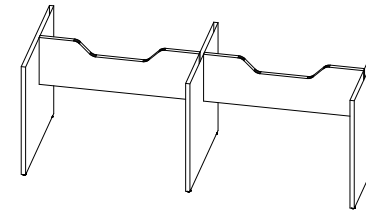

TB-B4
Gable Base for Straight/Boat
Tabletop
W: 42" - 60"
D: 21" - 240"
H: 28"

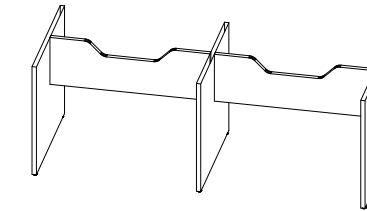

TB-B4-R
Gable Base for Racetrack
Tabletop
W: 48" - 60"
D: 84" - 240"
H: 28"

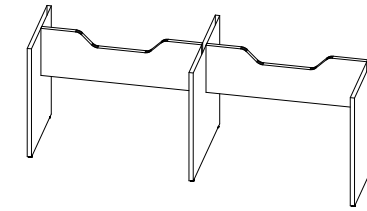

TB-B4-T
Gable Base for Tapered
Tabletop
W: 48" - 78"
D: 84" - 240"
H: 28"

Conference Elliptical Base

1.5" Thick

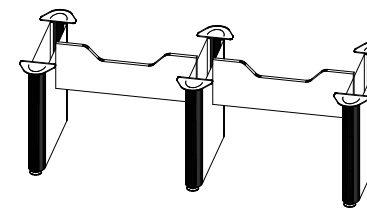

TB-B5
Elliptical Base for
Straight/Boat Tabletop
W: 36" - 60"
D: 72" - 204"
H: 28"

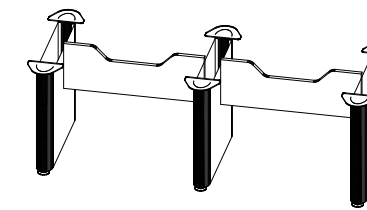

TB-B5-R
Elliptical Base for Race-
track Tabletop
W: 48" - 60"
D: 84" - 204"
H: 28"

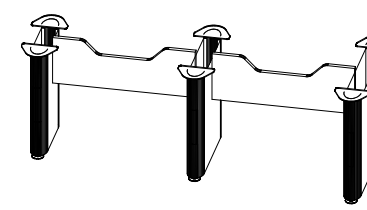

TB-B5-T
Elliptical Base for Tapered
Tabletop
W: 48" - 60"
D: 84" - 204"
H: 28"

Ellora Grommet Add-ons

Options



T-RJ45



T-RJ11



T-HDMI



T-VGA



T-STEREO

Conference Filing and Storage

1.5" Thick

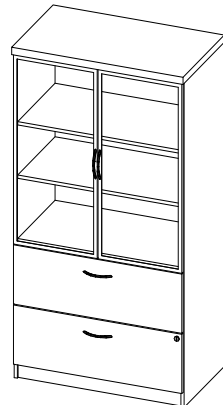

TB-FCSL-G
Combo Cabinet with Storage, Lateral Files and Acrylic Doors
W: 36"
D: 21"
H: 78"

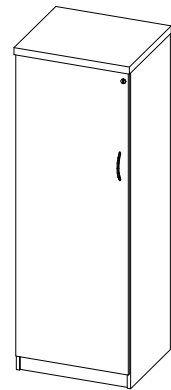

TB-FSDC-L / TB-FSDC-R
Storage Cabinet with Coat Bar and Shelves (Left Hand shown)
W: 24"
D: 21"
H: 78"

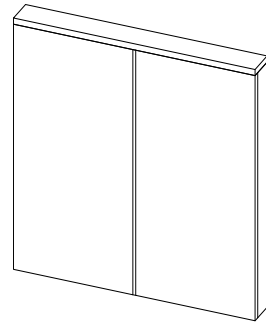

TB-VB00
Whiteboard Cabinet
W: 48"
D: 5.6"
H: 51"

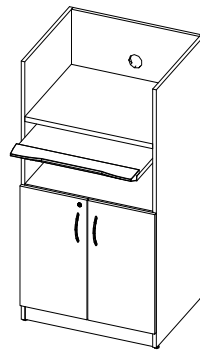

U-TCDS
1" Computer Desk with 1.5" Top
W: 28"
D: 24"
H: 54"

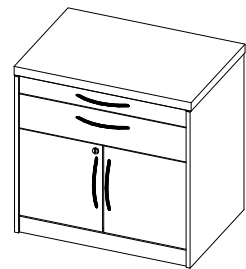

TB-FCS0
Serving Cabinet
W: 30" - 36"
D: 21"
H: 29.5"

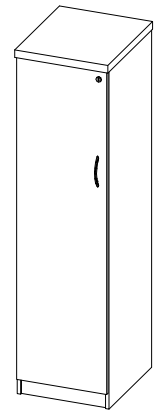

TB-FSDS-L / TB-FSDS-R
Storage Cabinet with Shelves (Left Hand shown)
W: 18"
D: 21"
H: 78"

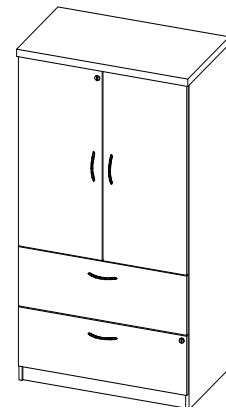

TB-FCSL
Combo Cabinet with Storage and Lateral Files
W: 36"
D: 21"
H: 78"

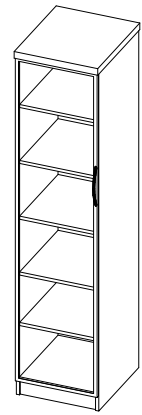

TB-FSDS-LG / TB-FSDS-RG
Storage Cabinet with Shelves and Acrylic Doors (Left Hand shown)
W: 18"
D: 21"
H: 78"

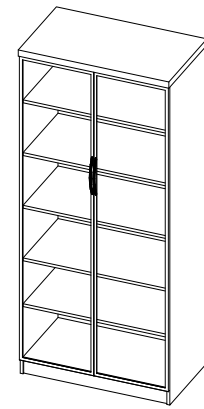

TB-FSDS-G
Double Door Storage Cabinet with Shelves and Acrylic Doors
W: 36"
D: 21"
H: 78"

Accessories

Keyboard

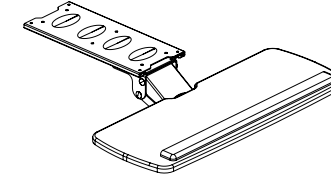

V-KASX
Articulating Keyboard Tray
W: 25"
D: 10"

Tackboard for Hutch

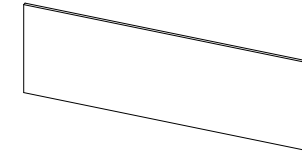

V-ATH0
14"H Tackboard for Hutch with Pigeon Holes
W: 27" - 81"
D: 0.5"
H: 14"

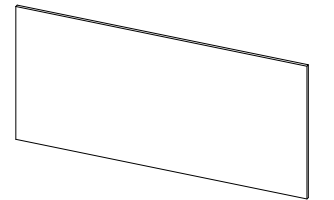

V-ATH0
21"H Tackboard for Hutch without Pigeon Holes
W: 27" - 81"
D: 0.5"
H: 21"

Pencil Drawer

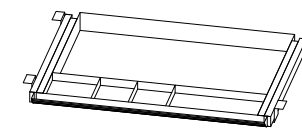

V-ADPP
Plastic Pencil Drawer
W: 21"
D: 16"
H: 2.8"

Tasklight



V-ELU
Task Light
W: 24"/36"

Monitor Arm

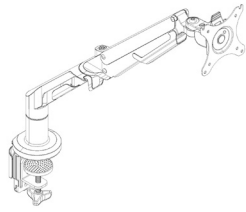

V-AFMA-01
Monitor Arm -
Single Mount

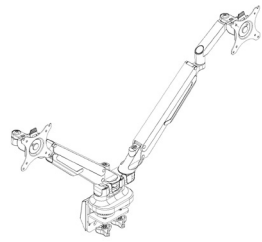

V-AFMA-02
Monitor Arm -
Double Mount

CPU Holder

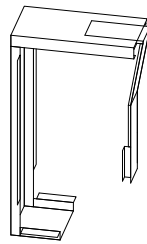

V-ACPU
CPU Holder - Fixed Mount
W: 8.5"
D: 11.5"
H: 18"

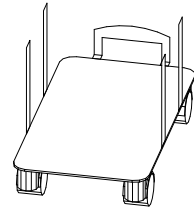

V-ACPU-M
CPU Holder - Mobile
W: 15.5"
D: 9"
H: 4.3"

Wire Manager



V-EE00
Vertical Wire Manager
W: 4"
D: 4"
H: 28"

step-by-step order placement

1. purchase order number
2. quantity
3. product codes and descriptions
4. finishes
5. options
6. provide a drawing or Tayco quotation number
7. shipping address, on-site contact name and phone number
8. shipping instructions
9. confirm access to elevators, loading dock, etc.
10. requested ship date/installation date
11. submit a completed Tayco installation checklist if Tayco is installing the furniture
12. discount, net price and freight charges
13. keep Tayco order numbers on file for reference when placing additional orders



Metro Pricebook
January 2026
Straight Desk

straight

Executive

<u>straight</u>	34
<u>straight partial modesty</u>	38
<u>straight full recessed modesty</u>	42
<u>arc full recessed modesty</u>	46

Professional

<u>straight</u>	36
<u>straight partial modesty</u>	40
<u>straight full recessed modesty</u>	44
<u>arc full recessed modesty</u>	47

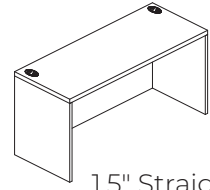

1.5" Straight Desk/Full Modesty

How to Specify:

Each laminate comes with matching vinyl trim color unless otherwise specified on your purchase order. Refer to the laminate finish card for details.

Notes:

Options:

laminate color

edge profile

grommet color

How to Order and Read your Code:

T or TL **TSOG** **60** **21**
 product line item width depth

Code	Price	H	W	D	Volume (ft ³)	Weight (lb)
T-TS0G-6021	1078	29.5	60	21	21.51	122.55
T-TS0G-6621	1136	29.5	66	21	23.66	131.97
T-TS0G-7221	1182	29.5	72	21	25.81	141.39
T-TS0G-7821	1233	29.5	78	21	27.96	150.81
T-TS0G-8421	1303	29.5	84	21	30.11	160.23
T-TS0G-9021	1498	29.5	90	21	32.27	169.65
T-TS0G-9621	1498	29.5	96	21	34.42	179.07
T-TS0G-3024	859	29.5	30	24	12.29	92.02
T-TS0G-3624	911	29.5	36	24	14.75	111.14
T-TS0G-4224	950	29.5	42	24	17.21	130.26
T-TS0G-4824	1006	29.5	48	24	19.67	149.38
T-TS0G-5424	1064	29.5	54	24	22.13	168.5
T-TS0G-6024	1123	29.5	60	24	24.58	187.62
T-TS0G-6624	1182	29.5	66	24	27.04	206.74
T-TS0G-7224	1224	29.5	72	24	29.5	225.86
T-TS0G-7824	1285	29.5	78	24	31.96	244.98
T-TS0G-8424	1353	29.5	84	24	34.42	264.1
T-TS0G-9024	1723	29.5	90	24	36.88	283.22
T-TS0G-9624	1723	29.5	96	24	39.33	302.34
T-TS0G-3030	904	29.5	30	30	15.36	99.05
T-TS0G-3630	973	29.5	36	30	18.44	110.58
T-TS0G-4230	1031	29.5	42	30	21.51	122.11
T-TS0G-4830	1099	29.5	48	30	24.58	133.64
T-TS0G-5430	1182	29.5	54	30	27.66	145.17
T-TS0G-6030	1233	29.5	60	30	30.73	156.7
T-TS0G-6630	1285	29.5	66	30	33.8	168.23
T-TS0G-7230	1335	29.5	72	30	36.88	179.76
T-TS0G-7830	1419	29.5	78	30	39.95	191.29
T-TS0G-8430	1489	29.5	84	30	43.02	202.82
T-TS0G-9030	1771	29.5	90	30	46.09	214.35
T-TS0G-9630	1819	29.5	96	30	49.17	225.88

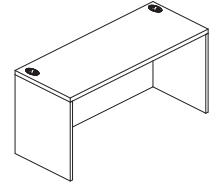

1" Straight Desk w/Full Modesty

How to Specify:

Each laminate comes with matching vinyl trim color unless otherwise specified on your purchase order. Refer to the laminate finish card for details.

Notes:

Options:

laminate color

grommet color

Code	Price	H	W	D	Volume (ft ³)	Weight (lb)
TL-TS0G-6021	993	29	60	21	21.15	107.7
TL-TS0G-6621	1050	29	66	21	23.26	117.12
TL-TS0G-7221	1090	29	72	21	25.38	126.54
TL-TS0G-7821	1145	29	78	21	27.49	135.96
TL-TS0G-8421	1209	29	84	21	29.6	145.38
TL-TS0G-9021	1312	29	90	21	31.72	154.8
TL-TS0G-9621	1312	29	96	21	33.83	164.22
TL-TS0G-3024	794	29	30	24	12.08	77.17
TL-TS0G-3624	849	29	36	24	14.5	96.29
TL-TS0G-4224	881	29	42	24	16.92	115.41
TL-TS0G-4824	931	29	48	24	19.33	134.53
TL-TS0G-5424	983	29	54	24	21.75	153.65
TL-TS0G-6024	1038	29	60	24	24.17	172.77
TL-TS0G-6624	1090	29	66	24	26.58	191.89
TL-TS0G-7224	1136	29	72	24	29	211.01
TL-TS0G-7824	1186	29	78	24	31.42	230.13
TL-TS0G-8424	1250	29	84	24	33.83	249.25
TL-TS0G-9024	1574	29	90	24	36.25	268.37
TL-TS0G-9624	1646	29	96	24	38.67	287.49
TL-TS0G-3030	838	29	30	30	15.1	84.2
TL-TS0G-3630	903	29	36	30	18.13	95.73
TL-TS0G-4230	955	29	42	30	21.15	107.26
TL-TS0G-4830	1020	29	48	30	24.17	118.79
TL-TS0G-5430	1089	29	54	30	27.19	130.32
TL-TS0G-6030	1145	29	60	30	30.21	141.85
TL-TS0G-6630	1186	29	66	30	33.23	153.38
TL-TS0G-7230	1236	29	72	30	36.25	164.91
TL-TS0G-7830	1310	29	78	30	39.27	176.44
TL-TS0G-8430	1379	29	84	30	42.29	187.97
TL-TS0G-9030	1623	29	90	30	45.31	199.5
TL-TS0G-9630	1710	29	96	30	48.33	211.03

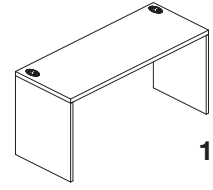

1.5" Straight Desk w/Partial Modesty

How to Specify:

Each laminate comes with matching vinyl trim color unless otherwise specified on your purchase order. Refer to the laminate finish card for details.

Notes:

Partial modesties are 12"H.

Options:

laminate color

edge profile

grommet color

Code	Price	H	W	D	Volume (ft ³)	Weight (lb)
T-TS0Z-6021	1078	29.5	60	21	21.51	97.81
T-TS0Z-6621	1136	29.5	66	21	23.66	104.54
T-TS0Z-7221	1182	29.5	72	21	25.81	111.27
T-TS0Z-7821	1233	29.5	78	21	27.96	118
T-TS0Z-8421	1303	29.5	84	21	30.11	124.73
T-TS0Z-9021	1498	29.5	90	21	32.27	131.46
T-TS0Z-9621	1814	29.5	96	21	34.42	138.19
T-TS0Z-3024	859	29.5	30	24	12.29	71.33
T-TS0Z-3624	911	29.5	36	24	14.75	78.75
T-TS0Z-4224	950	29.5	42	24	17.21	86.17
T-TS0Z-4824	1006	29.5	48	24	19.67	93.59
T-TS0Z-5424	1064	29.5	54	24	22.13	101.01
T-TS0Z-6024	1123	29.5	60	24	24.58	108.43
T-TS0Z-6624	1182	29.5	66	24	27.04	115.85
T-TS0Z-7224	1224	29.5	72	24	29.5	123.27
T-TS0Z-7824	1285	29.5	78	24	31.96	130.69
T-TS0Z-8424	1353	29.5	84	24	34.42	138.11
T-TS0Z-9024	1574	29.5	90	24	36.88	145.53
T-TS0Z-9624	1903	29.5	96	24	39.33	152.95
T-TS0Z-3030	904	29.5	30	30	15.36	75.35
T-TS0Z-3630	973	29.5	36	30	18.44	83.98
T-TS0Z-4230	1031	29.5	42	30	21.51	92.6
T-TS0Z-4830	1099	29.5	48	30	24.58	101.23
T-TS0Z-5430	1182	29.5	54	30	27.66	109.85
T-TS0Z-6030	1233	29.5	60	30	30.73	118.48
T-TS0Z-6630	1285	29.5	66	30	33.8	127.1
T-TS0Z-7230	1335	29.5	72	30	36.88	135.73
T-TS0Z-7830	1419	29.5	78	30	39.95	144.35
T-TS0Z-8430	1489	29.5	84	30	43.02	152.98
T-TS0Z-9030	1791	29.5	90	30	46.09	161.6
T-TS0Z-9630	1903	29.5	96	30	49.17	170.23



How to Specify:

Each laminate comes with matching vinyl trim color unless otherwise specified on your purchase order. Refer to the laminate finish card for details.

Notes:

Partial modesties are 12"H.

Options:

laminate color

grommet color

Code	Price	H	W	D	Volume (ft ³)	Weight (lb)
TL-TS0Z-6021	993	29	60	21	21.15	81.41
TL-TS0Z-6621	1050	29	66	21	23.26	86.6
TL-TS0Z-7221	1090	29	72	21	25.38	91.79
TL-TS0Z-7821	1145	29	78	21	27.49	96.98
TL-TS0Z-8421	1209	29	84	21	29.6	102.17
TL-TS0Z-9021	1312	29	90	21	31.72	107.36
TL-TS0Z-9621	1408	29	96	21	33.83	112.55
TL-TS0Z-3024	794	29	30	24	12.08	61.95
TL-TS0Z-3624	849	29	36	24	14.5	67.5
TL-TS0Z-4224	881	29	42	24	16.92	73.05
TL-TS0Z-4824	931	29	48	24	19.33	78.6
TL-TS0Z-5424	983	29	54	24	21.75	84.15
TL-TS0Z-6024	1038	29	60	24	24.17	89.7
TL-TS0Z-6624	1090	29	66	24	26.58	95.25
TL-TS0Z-7224	1136	29	72	24	29	100.8
TL-TS0Z-7824	1186	29	78	24	31.42	106.35
TL-TS0Z-8424	1250	29	84	24	33.83	111.9
TL-TS0Z-9024	1574	29	90	24	36.25	117.45
TL-TS0Z-9624	1646	29	96	24	38.67	123
TL-TS0Z-3030	838	29	30	30	15.1	63.48
TL-TS0Z-3630	903	29	36	30	18.13	69.97
TL-TS0Z-4230	955	29	42	30	21.15	76.46
TL-TS0Z-4830	1020	29	48	30	24.17	82.95
TL-TS0Z-5430	1089	29	54	30	27.19	89.44
TL-TS0Z-6030	1145	29	60	30	30.21	95.93
TL-TS0Z-6630	1186	29	66	30	33.23	102.42
TL-TS0Z-7230	1236	29	72	30	36.25	108.91
TL-TS0Z-7830	1310	29	78	30	39.27	115.4
TL-TS0Z-8430	1379	29	84	30	42.29	121.89
TL-TS0Z-9030	1597	29	90	30	45.31	128.38
TL-TS0Z-9630	1710	29	96	30	48.33	134.87

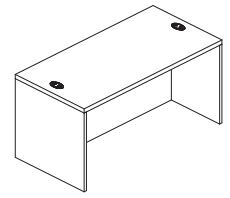

1.5" Straight Desk w/Recessed Full Modesty and Grommets

How to Specify:

Each laminate comes with matching vinyl trim color unless otherwise specified on your purchase order. Refer to the laminate finish card for details.

Options:

laminate color

edge profile

grommet color

Notes:

Recessed modesty:

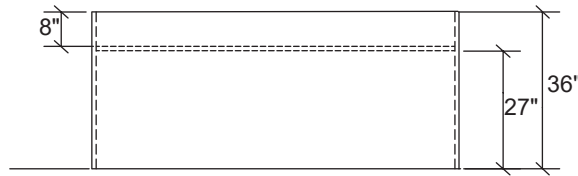

Code	Price	H	W	D	Volume (ft ³)	Weight (lb)
T-TSRG-6030	1257	29.5	60	30	30.73	156.7
T-TSRG-6630	1303	29.5	66	30	33.8	168.23
T-TSRG-7230	1364	29.5	72	30	36.88	179.76
T-TSRG-7830	1442	29.5	78	30	39.95	191.29
T-TSRG-8430	1511	29.5	84	30	43.02	202.82
T-TSRG-9030	1845	29.5	90	30	46.09	214.35
T-TSRG-9630	1923	29.5	96	30	49.17	225.88
T-TSRG-6036	1456	29.5	60	36	36.88	178.2
T-TSRG-6636	1511	29.5	66	36	40.56	190.8
T-TSRG-7236	1569	29.5	72	36	44.25	203.4
T-TSRG-7836	1637	29.5	78	36	47.94	216
T-TSRG-8436	1696	29.5	84	36	51.63	228.6
T-TSRG-9036	1941	29.5	90	36	55.31	241.2
T-TSRG-9636	2024	29.5	96	36	59	253.8

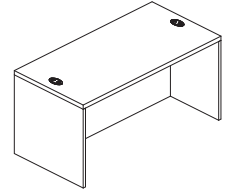

1" Straight Desk w/Recessed Full Modesty and Grommets

How to Specify:

Each laminate comes with matching vinyl trim color unless otherwise specified on your purchase order. Refer to the laminate finish card for details.

Notes:

Recessed modesty:

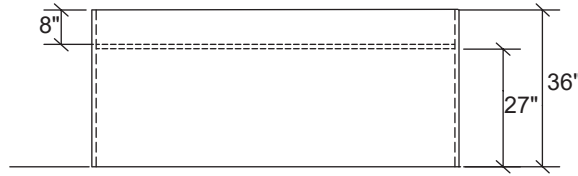

Options:

laminate color

grommet color

Code	Price	H	W	D	Volume (ft ³)	Weight (lb)
TL-TSRG-6030	1164	29	60	30	30.21	137.93
TL-TSRG-6630	1209	29	66	30	33.23	149.46
TL-TSRG-7230	1262	29	72	30	36.25	160.99
TL-TSRG-7830	1332	29	78	30	39.27	172.52
TL-TSRG-8430	1397	29	84	30	42.29	184.05
TL-TSRG-9030	1648	29	90	30	45.31	195.58
TL-TSRG-9630	1782	29	96	30	48.33	207.11
TL-TSRG-6036	1348	29	60	36	36.25	150.3
TL-TSRG-6636	1397	29	66	36	39.88	160.2
TL-TSRG-7236	1451	29	72	36	43.5	170.1
TL-TSRG-7836	1515	29	78	36	47.13	180
TL-TSRG-8436	1571	29	84	36	50.75	189.9
TL-TSRG-9036	1733	29	90	36	54.38	199.8
TL-TSRG-9636	1880	29	96	36	58	209.7

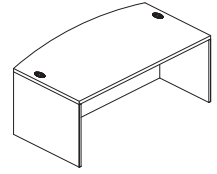

1.5" Arc Desk w/Recessed Full Modesty and Grommets

How to Specify:

Each laminate comes with matching vinyl trim color unless otherwise specified on your purchase order. Refer to the laminate finish card for details.

Options:

- laminate color

- edge profile

- grommet color

Notes:

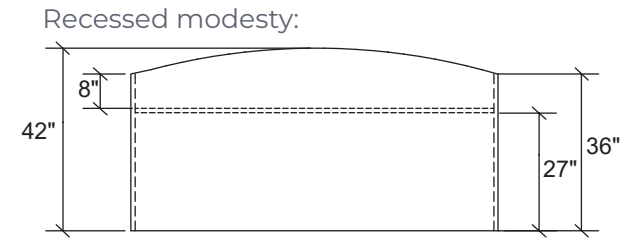

Code	Price	H	W	D	Volume (ft ³)	Weight (lb)
T-TARG-7236	1819	29.5	72	36	44.25	216.17
T-TARG-7836	1903	29.5	78	36	47.94	230.43
T-TARG-8436	1988	29.5	84	36	51.63	244.69
T-TARG-9036	2102	29.5	90	36	55.31	258.95
T-TARG-9636	2205	29.5	96	36	59	273.21

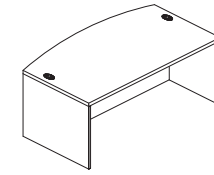

1" Arc Desk w/Recessed Full Modesty and Grommets

How to Specify:

Each laminate comes with matching vinyl trim color unless otherwise specified on your purchase order. Refer to the laminate finish card for details.

Options:

- laminate color

- grommet color

Notes:

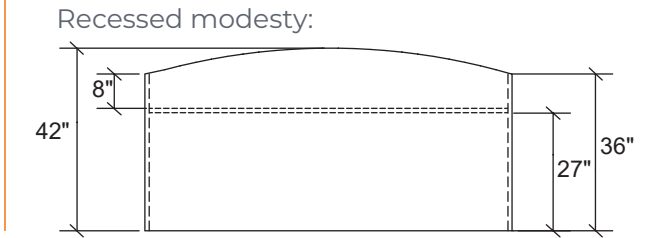

Code	Price	H	W	D	Volume (ft ³)	Weight (lb)
TL-TARG-7236	1692	29	72	36	43.5	178.09
TL-TARG-7836	1776	29	78	36	47.13	188.84
TL-TARG-8436	1864	29	84	36	50.75	199.59
TL-TARG-9036	1941	29	90	36	54.38	210.34
TL-TARG-9636	2024	29	96	36	58	221.09

Executive

D-table	50
J-table	52
P-table	54
F-table	56
U-table	58
C-table	60

Professional

D-table	51
J-table	53
P-table	55
F-table	57
U-table	59
C-table	61

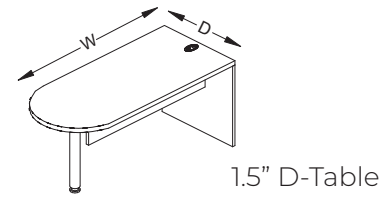

How to Specify:

Each laminate comes with matching vinyl trim color unless otherwise specified on your purchase order. Refer to the laminate finish card for details.

Options:

- laminate color

- edge profile

- grommet color

- metal color (for post support)

Notes:

36\"/>

How to Order and Read your Code:

T or TL **TD0G** **60** **30**
 product line item width depth

Code	Price	H	W	D	Volume (ft ³)	Weight (lb)
T-TD0G-6030	1502	29.5	60	30	30.73	108.29
T-TD0G-6630	1550	29.5	66	30	33.8	117.27
T-TD0G-7230	1603	29.5	72	30	36.88	126.25
T-TD0G-7830	1651	29.5	78	30	39.95	135.23
T-TD0G-8430	1699	29.5	84	30	43.02	144.21
T-TD0G-6036	1612	29.5	60	36	36.88	131.34
T-TD0G-6636	1675	29.5	66	36	40.56	141.76
T-TD0G-7236	1711	29.5	72	36	44.25	152.18
T-TD0G-7836	1756	29.5	78	36	47.94	162.6
T-TD0G-8436	1807	29.5	84	36	51.63	173.02

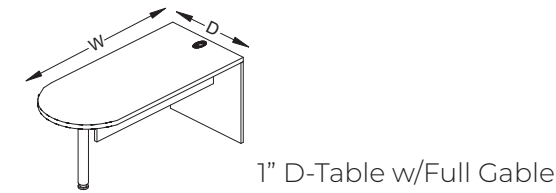

How to Specify:

Each laminate comes with matching vinyl trim color unless otherwise specified on your purchase order. Refer to the laminate finish card for details.

Options:

- laminate color

- grommet color

- metal color (for post support)

Notes:

36\"/>

Code	Price	H	W	D	Volume (ft ³)	Weight (lb)
TL-TD0G-6030	1232	29	60	30	30.21	86.48
TL-TD0G-6630	1285	29	66	30	33.23	92.95
TL-TD0G-7230	1331	29	72	30	36.25	99.42
TL-TD0G-7830	1379	29	78	30	39.27	105.9
TL-TD0G-8430	1432	29	84	30	42.29	112.38
TL-TD0G-6036	1344	29	60	36	36.25	107.18
TL-TD0G-6636	1403	29	66	36	39.88	115.76
TL-TD0G-7236	1442	29	72	36	43.5	124.34
TL-TD0G-7836	1490	29	78	36	47.13	132.92
TL-TD0G-8436	1542	29	84	36	50.75	141.5

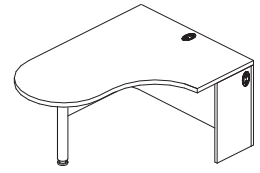

1.5" J-Table, LH Shown

How to Specify:

Each laminate comes with matching vinyl trim color unless otherwise specified on your purchase order. Refer to the laminate finish card for details.

Notes:

Options:

- laminate color

- edge profile

- grommet color

- metal color (for post support)

Code	Price	H	W	D	Volume (ft ³)	Weight (lb)
Left Hand						
T-TJ0G-604824-L	1979	29.5	60	24	24.58	149.48
T-TJ0G-664824-L	2111	29.5	66	24	27.04	158.56
T-TJ0G-724824-L	2219	29.5	72	24	29.5	167.64
T-TJ0G-784824-L	2335	29.5	78	24	31.96	176.72
T-TJ0G-844824-L	2446	29.5	84	24	34.42	185.8
Right Hand						
T-TJ0G-604824-R	1979	29.5	60	24	24.58	149.48
T-TJ0G-664824-R	2111	29.5	66	24	27.04	158.56
T-TJ0G-724824-R	2219	29.5	72	24	29.5	167.64
T-TJ0G-784824-R	2335	29.5	78	24	31.96	176.72
T-TJ0G-844824-R	2446	29.5	84	24	34.42	185.8

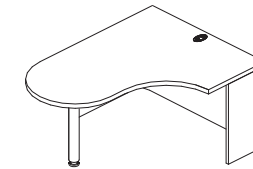

1" J-Table, LH Shown

How to Specify:

Each laminate comes with matching vinyl trim color unless otherwise specified on your purchase order. Refer to the laminate finish card for details.

Notes:

36"D D-tables include two post supports.

Options:

- laminate color

- grommet color

- metal color (for post support)

Code	Price	H	W	D	Volume (ft ³)	Weight (lb)
Left Hand						
TL-TJ0G-604824L	1846	29	60	24	24.17	120.67
TL-TJ0G-664824L	1981	29	66	24	26.58	127.15
TL-TJ0G-724824L	2087	29	72	24	29	133.63
TL-TJ0G-784824L	2206	29	78	24	31.42	140.11
TL-TJ0G-844824L	2313	29	84	24	33.83	146.59
Right Hand						
TL-TJ0G-604824R	1846	29	60	24	24.17	120.67
TL-TJ0G-664824R	1981	29	66	24	26.58	127.15
TL-TJ0G-724824R	2087	29	72	24	29	133.63
TL-TJ0G-784824R	2206	29	78	24	31.42	140.11
TL-TJ0G-844824R	2313	29	84	24	33.83	146.59

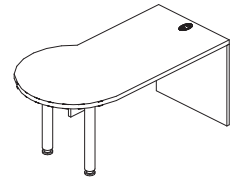

1.5" P-Table, LH Shown

How to Specify:

Each laminate comes with matching vinyl trim color unless otherwise specified on your purchase order. Refer to the laminate finish card for details.

Notes:

Options:

- laminate color

- edge profile

- grommet color

- metal color (for post support)

Code	Price	H	W	D	Volume (ft ³)	Weight (lb)
Left Hand						
T-TP0G-6030-L	1819	29.5	60	30	30.73	119.92
T-TP0G-6630-L	1903	29.5	66	30	33.8	128.78
T-TP0G-7230-L	1967	29.5	72	30	36.88	137.64
T-TP0G-7830-L	2046	29.5	78	30	39.95	146.5
T-TP0G-8430-L	2119	29.5	84	30	43.02	155.36
Right Hand						
T-TP0G-6030-R	1819	29.5	60	30	30.73	119.92
T-TP0G-6630-R	1903	29.5	66	30	33.8	128.78
T-TP0G-7230-R	1967	29.5	72	30	36.88	137.64
T-TP0G-7830-R	2046	29.5	78	30	39.95	146.5
T-TP0G-8430-R	2119	29.5	84	30	43.02	155.36

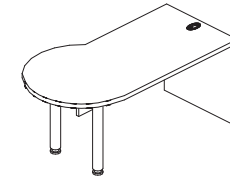

1" P-Table, LH Shown

How to Specify:

Each laminate comes with matching vinyl trim color unless otherwise specified on your purchase order. Refer to the laminate finish card for details.

Notes:

36"D D-tables include two post supports.

Options:

- laminate color

- grommet color

- metal color (for post support)

Code	Price	H	W	D	Volume (ft ³)	Weight (lb)
Left Hand						
TL-TP0G-6030-L	1692	29	60	30	30.21	96.51
TL-TP0G-6630-L	1776	29	66	30	33.23	103.34
TL-TP0G-7230-L	1838	29	72	30	36.25	110.17
TL-TP0G-7830-L	1917	29	78	30	39.27	117
TL-TP0G-8430-L	1989	29	84	30	42.29	123.83
Right Hand						
TL-TP0G-6030-R	1692	29	60	30	30.21	96.51
TL-TP0G-6630-R	1776	29	66	30	33.23	103.34
TL-TP0G-7230-R	1838	29	72	30	36.25	110.17
TL-TP0G-7830-R	1917	29	78	30	39.27	117
TL-TP0G-8430-R	1989	29	84	30	42.29	123.83

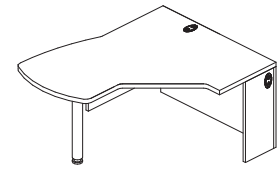

1.5" F-Table, LH Shown

How to Specify:

Each laminate comes with matching vinyl trim color unless otherwise specified on your purchase order. Refer to the laminate finish card for details.

Notes:

Options:

- laminate color

- edge profile

- grommet color

- metal color (for post support)

Code	Price	H	W	D	Volume (ft ³)	Weight (lb)
Left Hand						
T-TFSG-604824-L	2328	29.5	60	24	24.58	152.9
T-TFSG-664824-L	2377	29.5	66	24	27.04	161.05
T-TFSG-724824-L	2427	29.5	72	24	29.5	169.2
T-TFSG-784824-L	2473	29.5	78	24	31.96	177.35
T-TFSG-844824-L	2523	29.5	84	24	34.42	185.5
Right Hand						
T-TFSG-604824-R	2328	29.5	60	24	24.58	152.9
T-TFSG-664824-R	2377	29.5	66	24	27.04	161.05
T-TFSG-724824-R	2427	29.5	72	24	29.5	169.2
T-TFSG-784824-R	2473	29.5	78	24	31.96	177.35
T-TFSG-844824-R	2523	29.5	84	24	34.42	185.5

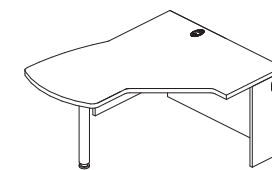

1" F-Table, LH Shown

How to Specify:

Each laminate comes with matching vinyl trim color unless otherwise specified on your purchase order. Refer to the laminate finish card for details.

Notes:

Options:

- laminate color

- grommet color

- metal color (for post support)

Code	Price	H	W	D	Volume (ft ³)	Weight (lb)
Left Hand						
TL-TFSG-604824L	2254	29	60	24	24.17	123.35
TL-TFSG-664824L	2292	29	66	24	26.58	129.35
TL-TFSG-724824L	2333	29	72	24	29	135.35
TL-TFSG-784824L	2373	29	78	24	31.42	141.35
TL-TFSG-844824L	2412	29	84	24	33.83	147.35
Right Hand						
TL-TFSG-604824R	2254	29	60	24	24.17	123.35
TL-TFSG-664824R	2292	29	66	24	26.58	129.35
TL-TFSG-724824R	2333	29	72	24	29	135.35
TL-TFSG-784824R	2373	29	78	24	31.42	141.35
TL-TFSG-844824R	2412	29	84	24	33.83	147.35

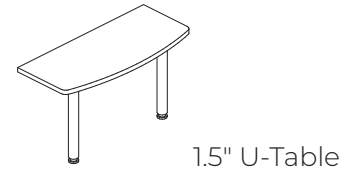

How to Specify:

Each laminate comes with matching vinyl trim color unless otherwise specified on your purchase order. Refer to the laminate finish card for details.

Notes:

Options:

- laminate color

- edge profile

- metal color (for post support)

Code	Price	H	W	D	Volume (ft ³)	Weight (lb)
T-WEU0-4224	1112	29.5	42	24	17.21	51.19
T-WEU0-4824	1149	29.5	48	24	19.67	56.54
T-WEU0-6024	1356	29.5	60	24	24.58	61.88

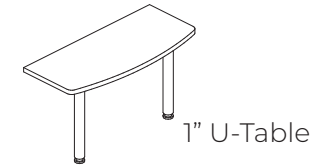

How to Specify:

Each laminate comes with matching vinyl trim color unless otherwise specified on your purchase order. Refer to the laminate finish card for details.

Notes:

Options:

- laminate color

- metal color (for post support)

Code	Price	H	W	D	Volume (ft ³)	Weight (lb)
TL-WEU0-4224	960	29	42	24	16.92	38.79
TL-WEU0-4824	997	29	48	24	19.33	42.36
TL-WEU0-6024	1204	29	60	24	24.17	45.92

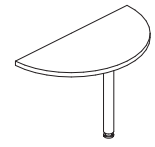

1.5" C-Table

How to Specify:

Each laminate comes with matching vinyl trim color unless otherwise specified on your purchase order. Refer to the laminate finish card for details.

Notes:

Options:

laminate color

edge profile

metal color (for post support)

Code	Price	H	W	D	Volume (ft ³)	Weight (lb)
T-TC00-4221	801	29.5	42	21	15.06	34
T-TC00-4824	921	29.5	48	24	19.67	42.1
T-TC00-6030	1038	29.5	60	30	30.73	50

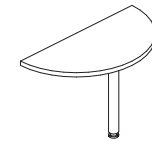

1" C-Table

How to Specify:

Each laminate comes with matching vinyl trim color unless otherwise specified on your purchase order. Refer to the laminate finish card for details.

Notes:

Options:

laminate color

metal color (for post support)

Code	Price	H	W	D	Volume (ft ³)	Weight (lb)
TL-TC00-4221	744	29	42	21	14.8	25
TL-TC00-4824	862	29	48	24	19.33	30.56
TL-TC00-6030	982	29	60	30	30.21	36.12



Metro Pricebook
January 2026
Corners

corners

Executive

straight front corner

<u>full modesty</u>	64
<u>partial modesty</u>	66
<u>full modesty no gables</u>	68

curved front corner

<u>full modesty</u>	70
<u>partial modesty</u>	72
<u>full modesty no gables</u>	74

Professional

straight front corner

<u>full modesty</u>	65
<u>partial modesty</u>	67
<u>full modesty no gables</u>	69

curved front corner

<u>full modesty</u>	71
<u>partial modesty</u>	73
<u>full modesty no gables</u>	75

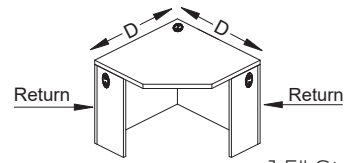

1.5" Straight Front Corner Worksurface
w/Full Modesties

How to Specify:

Each laminate comes with matching vinyl trim color unless otherwise specified on your purchase order. Refer to the laminate finish card for details.

Options:

laminate color

edge profile

grommet color

How to Order and Read your Code:

T or TL	W5S0	36	21
product line	item	depth	return size

Code	Price	H	D	Return	Volume (ft ³)	Weight (lb)
T-W5S0-3621	1233	29.5	36	21	12.91	114.3
T-W5S0-3624	1233	29.5	36	24	14.75	116.21
T-W5S0-4221	1451	29.5	42	21	15.06	137.24
T-W5S0-4224	1451	29.5	42	24	17.21	139.52

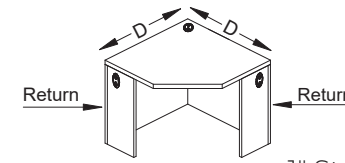

1" Straight Front Corner Worksurface
w/Full Modesties

How to Specify:

Each laminate comes with matching vinyl trim color unless otherwise specified on your purchase order. Refer to the laminate finish card for details.

Options:

laminate color

grommet color

Code	Price	H	D	Return	Volume (ft ³)	Weight (lb)
TL-W5S0-3621	1145	29	36	21	12.69	99.2
TL-W5S0-3624	1145	29	36	24	14.5	100.27
TL-W5S0-4221	1345	29	42	21	14.8	117.14
TL-W5S0-4224	1345	29	42	24	16.92	118.66

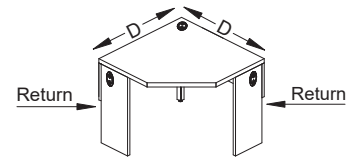

1.5" Straight Front Corner Worksurface w/Partial Modesties and Post

How to Specify:

Each laminate comes with matching vinyl trim color unless otherwise specified on your purchase order. Refer to the laminate finish card for details.

Notes:

Partial modesties are 12"H.

Options:

- laminate color

- edge profile

- grommet color

- metal color (for post support)

Code	Price	H	D	Return	Volume (ft ³)	Weight (lb)
T-W5S0-3621-P	1233	29.5	36	21	12.91	84.74
T-W5S0-3624-P	1233	29.5	36	24	14.75	86.65
T-W5S0-4221-P	1451	29.5	42	21	15.06	102.88
T-W5S0-4224-P	1451	29.5	42	24	17.21	105.16

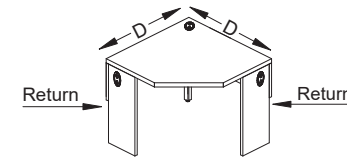

1" Straight Front Corner Worksurface w/Partial Modesties and Post

How to Specify:

Each laminate comes with matching vinyl trim color unless otherwise specified on your purchase order. Refer to the laminate finish card for details.

Notes:

Partial modesties are 12"H.

Options:

- laminate color

- grommet color

- metal color (for post support)

Code	Price	H	D	Return	Volume (ft ³)	Weight (lb)
TL-W5S0-3621-P	1145	29	36	21	12.69	69.94
TL-W5S0-3624-P	1145	29	36	24	14.5	70.71
TL-W5S0-4221-P	1345	29	42	21	14.8	82.78
TL-W5S0-4224-P	1345	29	42	24	16.92	84.3

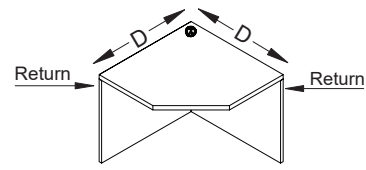

1.5" Straight Front Corner Worksurface
w/Full Modesties, No Gables

How to Specify:

Each laminate comes with matching vinyl trim color unless otherwise specified on your purchase order. Refer to the laminate finish card for details.

Options:

- laminates color _____
- edge profile _____
- grommet color _____

Code	Price	H	D	Return	Volume (ft ³)	Weight (lb)
T-W5S0-3621-N	904	29.5	36	21	12.91	114.3
T-W5S0-3624-N	904	29.5	36	24	14.75	116.21
T-W5S0-4221-N	1124	29.5	42	21	15.06	137.24
T-W5S0-4224-N	1124	29.5	42	24	17.21	139.52

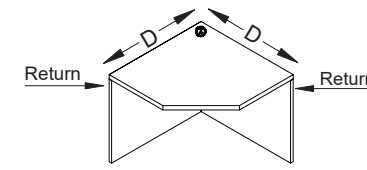

1" Straight Front Corner Worksurface
w/Full Modesties, No Gables

How to Specify:

Each laminate comes with matching vinyl trim color unless otherwise specified on your purchase order. Refer to the laminate finish card for details.

Options:

- laminates color _____
- grommet color _____

Code	Price	H	D	Return	Volume (ft ³)	Weight (lb)
TL-W5S0-3621-N	815	29.5	36	21	12.91	99.2
TL-W5S0-3624-N	815	29.5	36	24	14.75	100.27
TL-W5S0-4221-N	1018	29.5	42	21	15.06	117.14
TL-W5S0-4224-N	1018	29.5	42	24	17.21	118.66

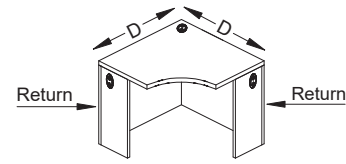

1.5" Curved Front Corner Worksurface
w/Full Modesties

How to Specify:

Each laminate comes with matching vinyl trim color unless otherwise specified on your purchase order. Refer to the laminate finish card for details.

Options:

laminate color

edge profile

grommet color

Code	Price	H	D	Return	Volume (ft ³)	Weight (lb)
T-W5C0-3621	1233	29.5	36	21	12.91	112.21
T-W5C0-3624	1233	29.5	36	24	14.75	114.6
T-W5C0-4221	1451	29.5	42	21	15.06	132.52
T-W5C0-4224	1451	29.5	42	24	17.21	136.12

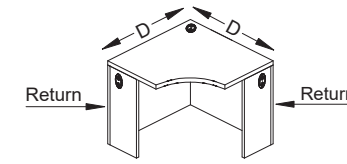

1" Curved Front Corner Worksurface
w/Full Modesties

How to Specify:

Each laminate comes with matching vinyl trim color unless otherwise specified on your purchase order. Refer to the laminate finish card for details.

Options:

laminate color

grommet color

Code	Price	H	D	Return	Volume (ft ³)	Weight (lb)
TL-W5C0-3621	1145	29	36	21	12.69	97.54
TL-W5C0-3624	1145	29	36	24	14.5	98.3
TL-W5C0-4221	1345	29	42	21	14.8	113.86
TL-W5C0-4224	1345	29	42	24	16.92	116.26

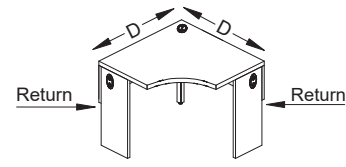

1.5" Curved Front Corner Worksurface
w/Partial Modesties and Post

How to Specify:

Each laminate comes with matching vinyl trim color unless otherwise specified on your purchase order. Refer to the laminate finish card for details.

Notes:

Partial modesties are 12"H.

Options:

- laminate color

- edge profile

- grommet color

- metal color (for post support)

Code	Price	H	D	Return	Volume (ft ³)	Weight (lb)
T-W5C0-3621-P	1233	29.5	36	21	12.91	82.62
T-W5C0-3624-P	1233	29.5	36	24	14.75	85.1
T-W5C0-4221-P	1451	29.5	42	21	15.06	94.27
T-W5C0-4224-P	1451	29.5	42	24	17.21	97.87

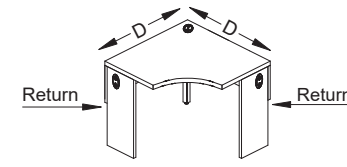

1" Curved Front Corner Worksurface
w/Partial Modesties and Post

How to Specify:

Each laminate comes with matching vinyl trim color unless otherwise specified on your purchase order. Refer to the laminate finish card for details.

Notes:

Partial modesties are 12"H.

Options:

- laminate color

- grommet color

- metal color (for post support)

Code	Price	H	D	Return	Volume (ft ³)	Weight (lb)
TL-W5C0-3621-P	1145	29	36	21	12.69	67.98
TL-W5C0-3624-P	1145	29	36	24	14.5	68.74
TL-W5C0-4221-P	1345	29	42	21	14.8	75.61
TL-W5C0-4224-P	1345	29	42	24	16.92	78.01

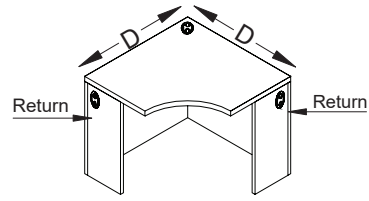

1.5" Curved Front Corner Worksurface
w/Full Modesties, No Gables

How to Specify:

Each laminate comes with matching vinyl trim color unless otherwise specified on your purchase order. Refer to the laminate finish card for details.

Options:

- laminate color _____
- edge profile _____
- grommet color _____

Code	Price	H	D	Return	Volume (ft ³)	Weight (lb)
T-W5C0-3621-N	904	29.5	36	21	12.91	112.21
T-W5C0-3624-N	904	29.5	36	24	14.75	114.6
T-W5C0-4221-N	1124	29.5	42	21	15.06	132.52
T-W5C0-4224-N	1124	29.5	42	24	17.21	136.12

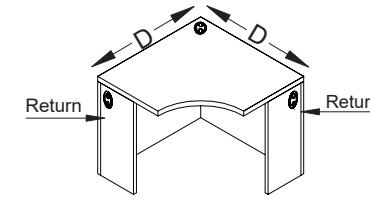

1" Curved Corner Worksurface
w/Full Modesties, No Gables

How to Specify:

Each laminate comes with matching vinyl trim color unless otherwise specified on your purchase order. Refer to the laminate finish card for details.

Options:

- laminate color _____
- grommet color _____

Code	Price	H	D	Return	Volume (ft ³)	Weight (lb)
TL-W5C0-3621-N	815	29.5	36	21	12.91	97.54
TL-W5C0-3624-N	815	29.5	36	24	14.75	98.3
TL-W5C0-4221-N	1018	29.5	42	21	15.06	113.66
TL-W5C0-4224-N	1018	29.5	42	24	17.21	116.26



Metro Pricebook
January 2026
Unitized Desks

unitized desks

Executive

<u>w/full modesties, full and partial gables</u>	78
<u>w/full modesties, no gables</u>	80
<u>w/partial modesty</u>	82

Professional

<u>w/full modesties, full and partial gables</u>	79
<u>w/full modesties, no gables</u>	81
<u>w/ partial modesties</u>	83

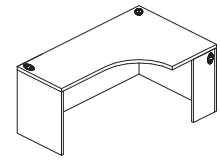

1.5" Curved Front Unitized Desk w/Full Modesties, Full and Partial Gables, LH Shown

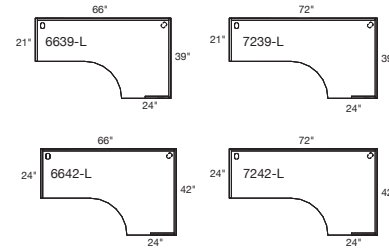

How to Specify:

Each laminate comes with matching vinyl trim color unless otherwise specified on your purchase order. Refer to the laminate finish card for details.

Notes:

Options:

- laminate color

- edge profile

- grommet color

Code	Price	H	W	D	Volume (ft ³)	Weight (lb)
T-UC4G-6639-L	1900	29.5	66	39	43.94	146.65
T-UC4G-7239-L	2024	29.5	72	39	47.94	181.17
T-UC4G-6639-R	1900	29.5	66	39	43.94	146.65
T-UC4G-7239-R	2024	29.5	72	39	47.94	181.17
T-UC4G-6642-L	1979	29.5	66	42	47.32	184.39
T-UC4G-7242-L	2373	29.5	72	42	51.63	194.16
T-UC4G-6642-R	1979	29.5	66	42	47.32	184.39
T-UC4G-7242-R	2373	29.5	72	42	51.63	194.16

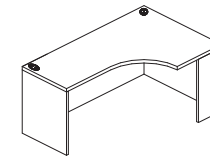

1" Curved Front Unitized Desk w/Full Modesties, Full and Partial Gables, LH Shown

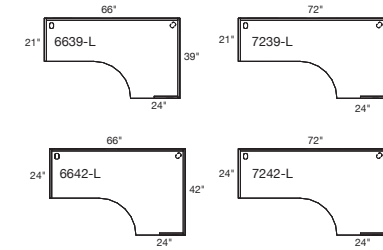

How to Specify:

Each laminate comes with matching vinyl trim color unless otherwise specified on your purchase order. Refer to the laminate finish card for details.

Notes:

Options:

- laminate color

- grommet color

Code	Price	H	W	D	Volume (ft ³)	Weight (lb)
TL-UC4G-6639-L	1763	29	66	39	43.2	120.6
TL-UC4G-7239-L	1874	29	72	39	47.13	153.9
TL-UC4G-6639-R	1763	29	66	39	43.2	120.6
TL-UC4G-7239-R	1874	29	72	39	47.13	153.9
TL-UC4G-6642-L	1833	29	66	42	46.52	161.1
TL-UC4G-7242-L	2200	29	72	42	50.75	170.55
TL-UC4G-6642-R	1833	29	66	42	46.52	161.1
TL-UC4G-7242-R	2200	29	72	42	50.75	170.55

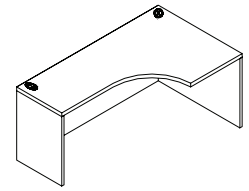

1.5" Curved Front Unitized Desk
w/Full Modesties, No Gables
LH Shown

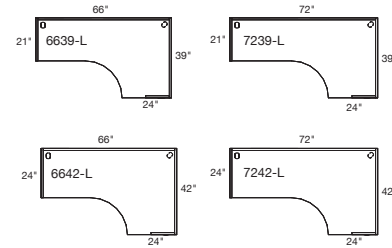

How to Specify:

Each laminate comes with matching vinyl trim color unless otherwise specified on your purchase order. Refer to the laminate finish card for details.

Notes:

Options:

- laminate color

- edge profile

- grommet color

Code	Price	H	W	D	Volume (ft ³)	Weight (lb)
T-UC4G-6639-L-N	1739	29.5	66	39	43.94	146.65
T-UC4G-7239-L-N	1864	29.5	72	39	47.94	181.17
T-UC4G-6639-R-N	1739	29.5	66	39	43.94	146.65
T-UC4G-7239-R-N	1864	29.5	72	39	47.94	181.17
T-UC4G-6642-L-N	1814	29.5	66	42	47.32	184.39
T-UC4G-7242-L-N	2207	29.5	72	42	51.63	194.16
T-UC4G-6642-R-N	1814	29.5	66	42	47.32	184.39
T-UC4G-7242-R-N	2207	29.5	72	42	51.63	194.16

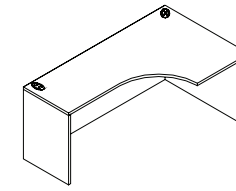

1" Curved Front Unitized Desk
w/Full Modesties, No Gables
LH Shown

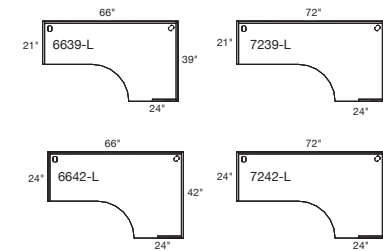

How to Specify:

Each laminate comes with matching vinyl trim color unless otherwise specified on your purchase order. Refer to the laminate finish card for details.

Notes:

Options:

- laminate color

- grommet color

Code	Price	H	W	D	Volume (ft ³)	Weight (lb)
TL-UC4G-6639-L-N	1597	29.5	66	39	43.94	120.6
TL-UC4G-7239-L-N	1711	29.5	72	39	47.94	153.9
TL-UC4G-6639-R-N	1597	29.5	66	39	43.94	120.6
TL-UC4G-7239-R-N	1711	29.5	72	39	47.94	153.9
TL-UC4G-6642-L-N	1666	29.5	66	42	47.32	161.1
TL-UC4G-7242-L-N	2031	29.5	72	42	51.63	170.55
TL-UC4G-6642-R-N	1666	29.5	66	42	47.32	161.1
TL-UC4G-7242-R-N	2031	29.5	72	42	51.63	170.55

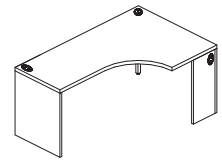

1.5" Curved Front Unitized Desk w/Partial Modesties, Full and Partial Gables, LH Shown

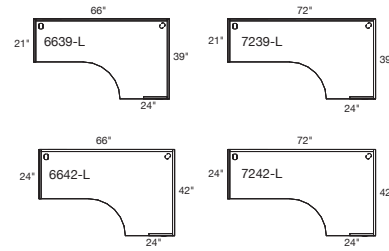

How to Specify:

Each laminate comes with matching vinyl trim color unless otherwise specified on your purchase order. Refer to the laminate finish card for details.

Notes:

Partial modesties are 12"H.

Options:

- laminate color

- edge profile

- grommet color

- metal color (for post support)

Code	Price	H	W	D	Volume (ft ³)	Weight (lb)
T-UC4Z-6639-L	1900	29.5	66	39	43.94	104.04
T-UC4Z-7239-L	2024	29.5	72	39	47.94	110.22
T-UC4Z-6639-R	1900	29.5	66	39	43.94	104.04
T-UC4Z-7239-R	2024	29.5	72	39	47.94	110.22
T-UC4Z-6642-L	1979	29.5	66	42	47.32	137.95
T-UC4Z-7242-L	2373	29.5	72	42	51.63	149.72
T-UC4Z-6642-R	1979	29.5	66	42	47.32	137.95
T-UC4Z-7242-R	2373	29.5	72	42	51.63	149.72

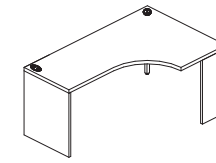

1" Curved Front Unitized Desk w/Partial Modesties, Full and Partial Gables, LH Shown

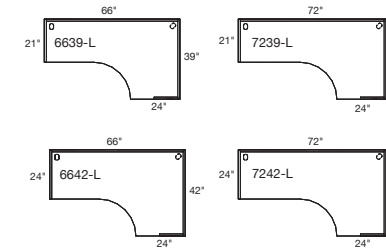

How to Specify:

Each laminate comes with matching vinyl trim color unless otherwise specified on your purchase order. Refer to the laminate finish card for details.

Notes:

Partial modesties are 12"H.

Options:

- laminate color

- grommet color

- metal color (for post support)

Code	Price	H	W	D	Volume (ft ³)	Weight (lb)
TL-UC4Z-6639-L	1763	29	66	39	43.2	99.79
TL-UC4Z-7239-L	1874	29	72	39	47.13	108.77
TL-UC4Z-6639-R	1763	29	66	39	43.2	99.79
TL-UC4Z-7239-R	1874	29	72	39	47.13	108.77
TL-UC4Z-6642-L	1833	29	66	42	46.52	114.66
TL-UC4Z-7242-L	2200	29	72	42	50.75	126.11
TL-UC4Z-6642-R	1833	29	66	42	46.52	114.66
TL-UC4Z-7242-R	2200	29	72	42	50.75	126.11



Metro Pricebook
January 2026
Bridges

bridges

Executive

bowed bridge

full modesty 86

partial modesty 88

Professional

bowed bridge

full modesty 87

partial modesty 89

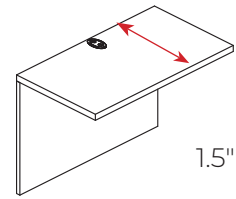

1.5" Straight Bridge w/Full Modesty

How to Specify:

Each laminate comes with matching vinyl trim color unless otherwise specified on your purchase order. Refer to the laminate finish card for details.

Notes:

Options:

laminate color

edge profile

grommet color

Code	Price	H	W	D	Volume (ft ³)	Weight (lb)
T-BS0G-3021	572	29.5	30	21	10.76	46.17
T-BS0G-3621	616	29.5	36	21	12.91	55.5
T-BS0G-4221	687	29.5	42	21	15.06	64.83
T-BS0G-4821	730	29.5	48	21	17.21	74.16
T-BS0G-3024	598	29.5	30	24	12.29	49.5
T-BS0G-3624	642	29.5	36	24	14.75	60
T-BS0G-4224	712	29.5	42	24	17.21	70.5
T-BS0G-4824	801	29.5	48	24	19.67	81

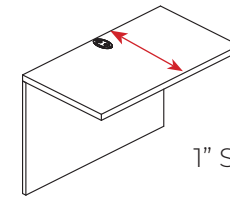

1" Straight Bridge w/Full Modesty

How to Specify:

Each laminate comes with matching vinyl trim color unless otherwise specified on your purchase order. Refer to the laminate finish card for details.

Notes:

Options:

laminate color

grommet color

Code	Price	H	W	D	Volume (ft ³)	Weight (lb)
TL-BS0G-3021	540	29	30	21	10.57	38
TL-BS0G-3621	582	29	36	21	12.69	45.78
TL-BS0G-4221	647	29	42	21	14.8	53.56
TL-BS0G-4821	691	29	48	21	16.92	61.34
TL-BS0G-3024	565	29	30	24	12.08	40.35
TL-BS0G-3624	605	29	36	24	14.5	48.6
TL-BS0G-4224	667	29	42	24	16.92	56.85
TL-BS0G-4824	758	29	48	24	19.33	65.1

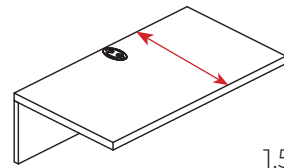

1.5" Straight Bridge w/Partial Modesty

How to Specify:

Each laminate comes with matching vinyl trim color unless otherwise specified on your purchase order. Refer to the laminate finish card for details.

Notes:

Partial modesties are 12"H.

Options:

laminate color

edge profile

grommet color

Code	Price	H	W	D	Volume (ft ³)	Weight (lb)
T-BS0Z-3021	572	29.5	30	21	10.76	33.67
T-BS0Z-3621	616	29.5	36	21	12.91	43
T-BS0Z-4221	687	29.5	42	21	15.06	52.33
T-BS0Z-4821	730	29.5	48	21	17.21	61.66
T-BS0Z-3024	598	29.5	30	24	12.29	33.3
T-BS0Z-3624	642	29.5	36	24	14.75	43.8
T-BS0Z-4224	712	29.5	42	24	17.21	54.3
T-BS0Z-4824	801	29.5	48	24	19.67	64.8

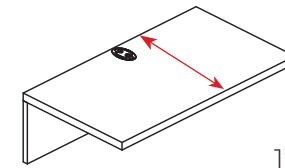

1" Straight Bridge w/Partial Modesty

How to Specify:

Each laminate comes with matching vinyl trim color unless otherwise specified on your purchase order. Refer to the laminate finish card for details.

Notes:

Partial modesties are 12"H.

Options:

laminate color

grommet color

Code	Price	H	W	D	Volume (ft ³)	Weight (lb)
TL-BS0Z-3021	540	29	30	21	10.57	25.4
TL-BS0Z-3621	582	29	36	21	12.69	33.18
TL-BS0Z-4221	647	29	42	21	14.8	40.96
TL-BS0Z-4821	691	29	48	21	16.92	48.74
TL-BS0Z-3024	565	29	30	24	12.08	27.75
TL-BS0Z-3624	605	29	36	24	14.5	36
TL-BS0Z-4224	667	29	42	24	16.92	44.25
TL-BS0Z-4824	758	29	48	24	19.33	52.5



Metro Pricebook
January 2026
Returns

returns

Executive

straight return full modesty 92

straight return partial modesty 96

Professional

straight return full modesty 94

straight return partial modesty 98

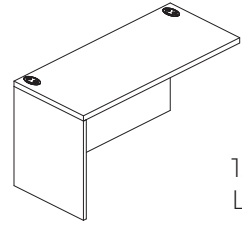

1.5" Straight Return w/Full Modesty, LH Shown

How to Specify:

Each laminate comes with matching vinyl trim color unless otherwise specified on your purchase order. Refer to the laminate finish card for details.

Notes:

1 grommet for width 48" or less
2 grommets for width 54" and wider

Options:

laminate color

edge profile

grommet color

Code	Price	H	W	D	Volume (ft ³)	Weight (lb)
T-WS1G-2421-L	838	29.5	24	21	8.6	51.3
T-WS1G-3021-L	849	29.5	30	21	10.76	60.74
T-WS1G-3621-L	861	29.5	36	21	12.91	70.18
T-WS1G-4221-L	877	29.5	42	21	15.06	79.62
T-WS1G-4821-L	923	29.5	48	21	17.21	89.06
T-WS1G-5421-L	969	29.5	54	21	19.36	98.5
T-WS1G-6021-L	1021	29.5	60	21	21.51	107.94
T-WS1G-2421-R	838	29.5	24	21	8.6	51.3
T-WS1G-3021-R	849	29.5	30	21	10.76	60.74
T-WS1G-3621-R	861	29.5	36	21	12.91	70.18
T-WS1G-4221-R	877	29.5	42	21	15.06	79.62
T-WS1G-4821-R	923	29.5	48	21	17.21	89.06
T-WS1G-5421-R	969	29.5	54	21	19.36	98.5
T-WS1G-6021-R	1021	29.5	60	21	21.51	107.94
T-WS1G-2424-L	849	29.5	24	24	9.83	56.65
T-WS1G-3024-L	861	29.5	30	24	12.29	65.92
T-WS1G-3624-L	877	29.5	36	24	14.75	75.19
T-WS1G-4224-L	900	29.5	42	24	17.21	84.46
T-WS1G-4824-L	946	29.5	48	24	19.67	93.73
T-WS1G-5424-L	993	29.5	54	24	22.13	103
T-WS1G-6024-L	1045	29.5	60	24	24.58	112.27
T-WS1G-2424-R	849	29.5	24	24	9.83	56.65
T-WS1G-3024-R	861	29.5	30	24	12.29	65.92
T-WS1G-3624-R	877	29.5	36	24	14.75	75.19
T-WS1G-4224-R	900	29.5	42	24	17.21	84.46
T-WS1G-4824-R	946	29.5	48	24	19.67	93.73
T-WS1G-5424-R	993	29.5	54	24	22.13	103
T-WS1G-6024-R	1045	29.5	60	24	24.58	112.27
T-WS1G-2430-L	923	29.5	24	30	12.29	66.42
T-WS1G-3030-L	946	29.5	30	30	15.36	77.42
T-WS1G-3630-L	982	29.5	36	30	18.44	88.42
T-WS1G-4230-L	1021	29.5	42	30	21.51	99.42
T-WS1G-4830-L	1054	29.5	48	30	24.58	110.42
T-WS1G-5430-L	1090	29.5	54	30	27.66	121.42
T-WS1G-6030-L	1151	29.5	60	30	30.73	132.42
T-WS1G-2430-R	923	29.5	24	30	12.29	66.42
T-WS1G-3030-R	946	29.5	30	30	15.36	77.42
T-WS1G-3630-R	982	29.5	36	30	18.44	88.42
T-WS1G-4230-R	1021	29.5	42	30	21.51	99.42
T-WS1G-4830-R	1054	29.5	48	30	24.58	110.42
T-WS1G-5430-R	1090	29.5	54	30	27.66	121.42
T-WS1G-6030-R	1151	29.5	60	30	30.73	132.42

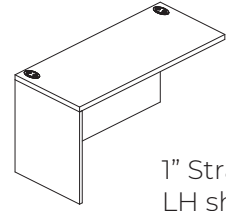

1" Straight return w/Full Modesty
LH shown

How to Specify:

Each laminate comes with matching vinyl trim color unless otherwise specified on your purchase order. Refer to the laminate finish card for details.

Notes:

1 grommet for width 48" or less
2 grommets for width 54" and wider

Options:

laminate color

grommet color

Code	Price	H	W	D	Volume (ft ³)	Weight (lb)
TL-WS1G-2421-L	687	29	24	21	8.46	45
TL-WS1G-3021-L	699	29	30	21	10.57	52.4
TL-WS1G-3621-L	712	29	36	21	12.69	59.8
TL-WS1G-4221-L	720	29	42	21	14.8	67.2
TL-WS1G-4821-L	770	29	48	21	16.92	74.6
TL-WS1G-5421-L	819	29	54	21	19.03	82
TL-WS1G-6021-L	864	29	60	21	21.15	89.4
TL-WS1G-2421-R	687	29	24	21	8.46	45
TL-WS1G-3021-R	699	29	30	21	10.57	52.4
TL-WS1G-3621-R	712	29	36	21	12.69	59.8
TL-WS1G-4221-R	720	29	42	21	14.8	67.2
TL-WS1G-4821-R	770	29	48	21	16.92	74.6
TL-WS1G-5421-R	819	29	54	21	19.03	82
TL-WS1G-6021-R	864	29	60	21	21.15	89.4
TL-WS1G-2424-L	699	29	24	24	9.67	48.75
TL-WS1G-3024-L	712	29	30	24	12.08	56.55
TL-WS1G-3624-L	720	29	36	24	14.5	64.35
TL-WS1G-4224-L	746	29	42	24	16.92	72.15
TL-WS1G-4824-L	792	29	48	24	19.33	79.95
TL-WS1G-5424-L	844	29	54	24	21.75	87.75
TL-WS1G-6024-L	892	29	60	24	24.17	95.55
TL-WS1G-2424-R	699	29	24	24	9.67	48.75
TL-WS1G-3024-R	712	29	30	24	12.08	56.55
TL-WS1G-3624-R	720	29	36	24	14.5	64.35
TL-WS1G-4224-R	746	29	42	24	16.92	72.15
TL-WS1G-4824-R	792	29	48	24	19.33	79.95
TL-WS1G-5424-R	844	29	54	24	21.75	87.75
TL-WS1G-6024-R	892	29	60	24	24.17	95.55
TL-WS1G-2430-L	770	29	24	30	12.08	56.7
TL-WS1G-3030-L	792	29	30	30	15.1	65.73
TL-WS1G-3630-L	832	29	36	30	18.13	74.76
TL-WS1G-4230-L	864	29	42	30	21.15	83.79
TL-WS1G-4830-L	904	29	48	30	24.17	92.82
TL-WS1G-5430-L	943	29	54	30	27.19	101.85
TL-WS1G-6030-L	1004	29	60	30	30.21	110.88
TL-WS1G-2430-R	770	29	24	30	12.08	56.7
TL-WS1G-3030-R	792	29	30	30	15.1	65.73
TL-WS1G-3630-R	832	29	36	30	18.13	74.76
TL-WS1G-4230-R	864	29	42	30	21.15	83.79
TL-WS1G-4830-R	904	29	48	30	24.17	92.82
TL-WS1G-5430-R	943	29	54	30	27.19	101.85
TL-WS1G-6030-R	1004	29	60	30	30.21	110.88

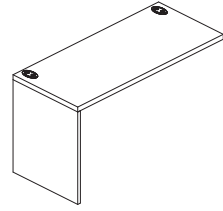

1.5" Straight Return w/Partial Modesty, LH Shown

How to Specify:

Each laminate comes with matching vinyl trim color unless otherwise specified on your purchase order. Refer to the laminate finish card for details.

Notes:

Partial modesties are 12"H
 1 grommet for width 48" or less
 2 grommets for width 54" and wider

Options:

laminate color

edge profile

grommet color

Code	Price	H	W	D	Volume (ft ³)	Weight (lb)
T-WS1Z-2421-L	838	29.5	24	21	8.6	41.4
T-WS1Z-3021-L	849	29.5	30	21	10.76	48.66
T-WS1Z-3621-L	861	29.5	36	21	12.91	58.1
T-WS1Z-4221-L	877	29.5	42	21	15.06	67.54
T-WS1Z-4821-L	923	29.5	48	21	17.21	76.98
T-WS1Z-5421-L	969	29.5	54	21	19.36	86.42
T-WS1Z-6021-L	1021	29.5	60	21	21.51	95.86
T-WS1Z-2421-R	838	29.5	24	21	8.6	41.4
T-WS1Z-3021-R	849	29.5	30	21	10.76	48.66
T-WS1Z-3621-R	861	29.5	36	21	12.91	58.1
T-WS1Z-4221-R	877	29.5	42	21	15.06	67.54
T-WS1Z-4821-R	923	29.5	48	21	17.21	76.98
T-WS1Z-5421-R	969	29.5	54	21	19.36	86.42
T-WS1Z-6021-R	1021	29.5	60	21	21.51	95.86
T-WS1Z-2424-L	849	29.5	24	24	9.83	46.35
T-WS1Z-3024-L	861	29.5	30	24	12.29	55.62
T-WS1Z-3624-L	877	29.5	36	24	14.75	64.89
T-WS1Z-4224-L	900	29.5	42	24	17.21	74.16
T-WS1Z-4824-L	946	29.5	48	24	19.67	83.43
T-WS1Z-5424-L	993	29.5	54	24	22.13	92.7
T-WS1Z-6024-L	1045	29.5	60	24	24.58	101.97
T-WS1Z-2424-R	849	29.5	24	24	9.83	46.35
T-WS1Z-3024-R	861	29.5	30	24	12.29	55.62
T-WS1Z-3624-R	877	29.5	36	24	14.75	64.89
T-WS1Z-4224-R	900	29.5	42	24	17.21	74.16
T-WS1Z-4824-R	946	29.5	48	24	19.67	83.43
T-WS1Z-5424-R	993	29.5	54	24	22.13	92.7
T-WS1Z-6024-R	1045	29.5	60	24	24.58	101.97
T-WS1Z-2430-L	923	29.5	24	30	12.29	58.5
T-WS1Z-3030-L	946	29.5	30	30	15.36	69.5
T-WS1Z-3630-L	982	29.5	36	30	18.44	80.5
T-WS1Z-4230-L	1021	29.5	42	30	21.51	91.5
T-WS1Z-4830-L	1054	29.5	48	30	24.58	102.5
T-WS1Z-5430-L	1090	29.5	54	30	27.66	113.5
T-WS1Z-6030-L	1151	29.5	60	30	30.73	124.5
T-WS1Z-2430-R	923	29.5	24	30	12.29	58.5
T-WS1Z-3030-R	946	29.5	30	30	15.36	69.5
T-WS1Z-3630-R	982	29.5	36	30	18.44	80.5
T-WS1Z-4230-R	1021	29.5	42	30	21.51	91.5
T-WS1Z-4830-R	1054	29.5	48	30	24.58	102.5
T-WS1Z-5430-R	1090	29.5	54	30	27.66	113.5
T-WS1Z-6030-R	1151	29.5	60	30	30.73	124.5

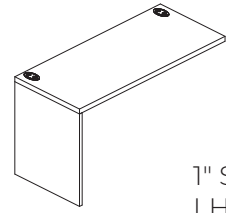

1" Straight Return w/partial Modesty, LH Shown

How to Specify:

Each laminate comes with matching vinyl trim color unless otherwise specified on your purchase order. Refer to the laminate finish card for details.

Notes:

Partial modesties are 12"H
 1 grommet for width 48" or less
 2 grommets for width 54" and wider

Options:

laminate color

grommet color

Code	Price	H	W	D	Volume (ft ³)	Weight (lb)
TL-WS1Z-2421-L	687	29	24	21	8.46	35.1
TL-WS1Z-3021-L	699	29	30	21	10.57	42.5
TL-WS1Z-3621-L	712	29	36	21	12.69	49.9
TL-WS1Z-4221-L	720	29	42	21	14.8	57.3
TL-WS1Z-4821-L	770	29	48	21	16.92	64.7
TL-WS1Z-5421-L	819	29	54	21	19.03	72.1
TL-WS1Z-6021-L	864	29	60	21	21.15	79.5
TL-WS1Z-2421-R	687	29	24	21	8.46	35.1
TL-WS1Z-3021-R	699	29	30	21	10.57	42.5
TL-WS1Z-3621-R	712	29	36	21	12.69	49.9
TL-WS1Z-4221-R	720	29	42	21	14.8	57.3
TL-WS1Z-4821-R	770	29	48	21	16.92	64.7
TL-WS1Z-5421-R	819	29	54	21	19.03	72.1
TL-WS1Z-6021-R	864	29	60	21	21.15	79.5
TL-WS1Z-2424-L	699	29	24	24	9.67	36.9
TL-WS1Z-3024-L	712	29	30	24	12.08	44.7
TL-WS1Z-3624-L	720	29	36	24	14.5	52.5
TL-WS1Z-4224-L	746	29	42	24	16.92	60.3
TL-WS1Z-4824-L	792	29	48	24	19.33	68.1
TL-WS1Z-5424-L	844	29	54	24	21.75	75.9
TL-WS1Z-6024-L	892	29	60	24	24.17	83.7
TL-WS1Z-2424-R	699	29	24	24	9.67	36.9
TL-WS1Z-3024-R	712	29	30	24	12.08	44.7
TL-WS1Z-3624-R	720	29	36	24	14.5	52.5
TL-WS1Z-4224-R	746	29	42	24	16.92	60.3
TL-WS1Z-4824-R	792	29	48	24	19.33	68.1
TL-WS1Z-5424-R	844	29	54	24	21.75	75.9
TL-WS1Z-6024-R	892	29	60	24	24.17	83.7
TL-WS1Z-2430-L	770	29	24	30	12.08	49.35
TL-WS1Z-3030-L	792	29	30	30	15.1	58.38
TL-WS1Z-3630-L	832	29	36	30	18.13	67.41
TL-WS1Z-4230-L	864	29	42	30	21.15	76.44
TL-WS1Z-4830-L	904	29	48	30	24.17	85.47
TL-WS1Z-5430-L	943	29	54	30	27.19	94.5
TL-WS1Z-6030-L	1004	29	60	30	30.21	103.53
TL-WS1Z-2430-R	770	29	24	30	12.08	49.35
TL-WS1Z-3030-R	792	29	30	30	15.1	58.38
TL-WS1Z-3630-R	832	29	36	30	18.13	67.41
TL-WS1Z-4230-R	864	29	42	30	21.15	76.44
TL-WS1Z-4830-R	904	29	48	30	24.17	85.47
TL-WS1Z-5430-R	943	29	54	30	27.19	94.5
TL-WS1Z-6030-R	1004	29	60	30	30.21	103.53



Metro Pricebook
January 2026
Credenzas

credenzas

Executive

<u>double lateral file</u>	102
<u>double storage cabinet</u>	104
<u>lateral file and storage cabinet</u>	106
<u>lateral file and storage cabinet</u>	108
<u>tops</u>	110

Professional

<u>double lateral file</u>	103
<u>double storage cabinet</u>	105
<u>lateral file and storage cabinet</u>	107
<u>lateral file and storage cabinet</u>	109
<u>tops</u>	111
<u>open w door</u>	112

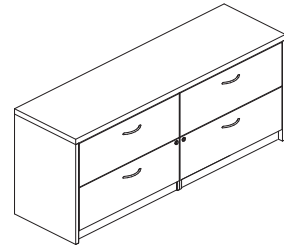

1.5" Credenza w/Double Lateral Files

How to Specify:

Each laminate comes with matching vinyl trim color unless otherwise specified on your purchase order. Refer to the laminate finish card for details.

Notes:

Options:

laminate color

edge profile

handle color

handle style

Code	Price	H	W	D	Volume (ft ³)	Weight (lb)
T-CRLL-7221	3018	29.5	72	21	25.81	232.65
T-CRLL-7224	3205	29.5	72	24	29.5	250.64

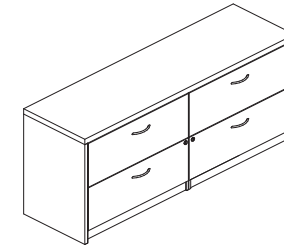

1" Credenza w/Double Lateral Files

How to Specify:

Each laminate comes with matching vinyl trim color unless otherwise specified on your purchase order. Refer to the laminate finish card for details.

Notes:

Options:

laminate color

handle color

handle style

Code	Price	H	W	D	Volume (ft ³)	Weight (lb)
TL-CRLL-7221	2850	29	72	21	25.38	205.87
TL-CRLL-7224	3019	29	72	24	29	220

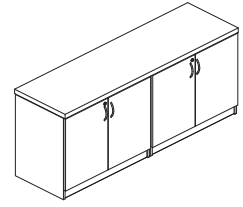

1.5" Credenza w/Double Storage Cabinets

How to Specify:

Each laminate comes with matching vinyl trim color unless otherwise specified on your purchase order. Refer to the laminate finish card for details.

Notes:

Cabinets and laterals include locks and keys.

Options:

laminate color

edge profile

handle color

handle style

Code	Price	H	W	D	Volume (ft ³)	Weight (lb)
T-CRSS-7221	2355	29.5	72	21	25.81	267
T-CRSS-7224	2517	29.5	72	24	29.5	272

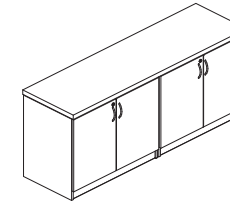

1" Credenza w/Double Storage Cabinets

How to Specify:

Each laminate comes with matching vinyl trim color unless otherwise specified on your purchase order. Refer to the laminate finish card for details.

Notes:

Cabinets and laterals include locks and keys.

Options:

laminate color

handle color

handle style

Code	Price	H	W	D	Volume (ft ³)	Weight (lb)
TL-CRSS-7221	2223	29	72	21	25.38	225.45
TL-CRSS-7224	2376	29	72	24	29	236.26

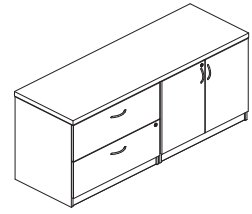

1.5" Credenza w/Lateral File on Left-Hand Side, Storage Cabinet on Right-Hand Side

How to Specify:

Each laminate comes with matching vinyl trim color unless otherwise specified on your purchase order. Refer to the laminate finish card for details.

Notes:

Cabinets and laterals include locks and keys.

Options:

laminate color

edge profile

handle color

handle style

Code	Price	H	W	D	Volume (ft ³)	Weight (lb)
T-CRLS-7221	2722	29.5	72	21	25.81	229.05
T-CRLS-7224	2951	29.5	72	24	29.5	247.04

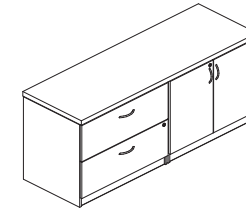

1" Credenza w/Lateral File on Left-Hand Side, Storage Cabinet on Right-Hand Side

How to Specify:

Each laminate comes with matching vinyl trim color unless otherwise specified on your purchase order. Refer to the laminate finish card for details.

Notes:

Cabinets and laterals include locks and keys.

Options:

laminate color

handle color

handle style

Code	Price	H	W	D	Volume (ft ³)	Weight (lb)
TL-CRLS-7221	2571	29	72	21	25.38	211.03
TL-CRLS-7224	2780	29	72	24	29	222.74

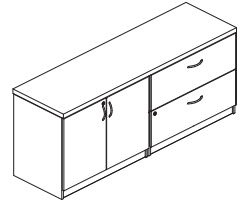

1.5" Credenza w/Storage Cabinet on Left-Hand Side, Lateral File on Right-Hand Side

How to Specify:

Each laminate comes with matching vinyl trim color unless otherwise specified on your purchase order. Refer to the laminate finish card for details.

Notes:

Cabinets and laterals include locks and keys.

Options:

laminate color

edge profile

handle color

handle style

Code	Price	H	W	D	Volume (ft ³)	Weight (lb)
T-CRSL-7221	2722	29.5	72	21	25.81	229.05
T-CRSL-7224	2951	29.5	72	24	29.5	247.04

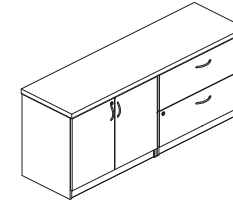

1" Credenza w/Storage Cabinet on Left-Hand Side, Lateral File on Right-Hand Side

How to Specify:

Each laminate comes with matching vinyl trim color unless otherwise specified on your purchase order. Refer to the laminate finish card for details.

Notes:

Cabinets and laterals include locks and keys.

Options:

laminate color

handle color

handle style

Code	Price	H	W	D	Volume (ft ³)	Weight (lb)
TL-CRSL-7221	2571	29	72	21	25.38	211.03
TL-CRSL-7224	2780	29	72	24	29	222.74

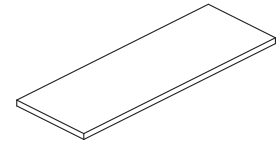

1.5" Credenza Top

How to Specify:

Each laminate comes with matching vinyl trim color unless otherwise specified on your purchase order. Refer to the laminate finish card for details.

Notes:

Options:

laminate color

edge profile

handle color

handle style

Code	Price	H	W	D	Volume (ft ³)	Weight (lb)
T-WSS0-6021	486	1.5	60	21	1.09	49.21
T-WSS0-6621	535	1.5	66	21	1.2	54.14
T-WSS0-7221	560	1.5	72	21	1.31	59.07
T-WSS0-7821	607	1.5	78	21	1.42	64
T-WSS0-8421	655	1.5	84	21	1.53	68.93

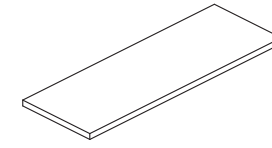

1" Credenza Top

How to Specify:

Each laminate comes with matching vinyl trim color unless otherwise specified on your purchase order. Refer to the laminate finish card for details.

Notes:

Options:

laminate color

handle color

handle style

Code	Price	H	W	D	Volume (ft ³)	Weight (lb)
TL-WSS0-6021	435	1	60	21	0.73	32.81
TL-WSS0-6621	477	1	66	21	0.8	36.09
TL-WSS0-7221	500	1	72	21	0.88	39.37
TL-WSS0-7821	541	1	78	21	0.95	42.65
TL-WSS0-8421	583	1	84	21	1.02	45.93

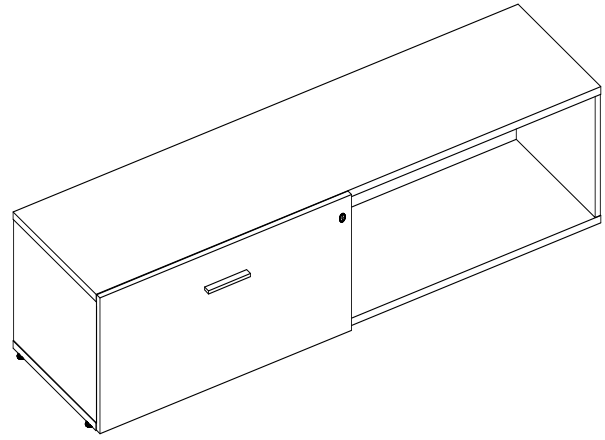

How to Specify:

Each laminate comes with matching vinyl trim color unless otherwise specified on your purchase order. Refer to the laminate finish card for details.

Notes:

Cabinets and laterals include locks and keys.

Options:

laminate color

edge profile

handle color

handle style

Code	Price	H	W	D	Volume (ft ³)	Weight (lb)
U-CRCL-157218-L	2250	14.19	72	19.13	93.91	11.31
U-CRCL-157218-R	2250	14.19	72	19.13	93.91	11.31



Metro Pricebook
January 2026
Supports

supports

Executive & Professional

<u>intermediate support</u>	116
<u>cantilever</u>	117
<u>reinforcement bar</u>	118



Intermediate Gable Support

How to Specify:

Each laminate comes with matching vinyl trim color unless otherwise specified on your purchase order. Refer to the laminate finish card for details.

Notes:

Options:

- laminate color
- grommet color

Code	Price	H	W	D	Volume (ft ³)	Weight (lb)
T-CGU0-12	229	28	12	1	0.19	8.75
T-CGU0-18	244	28	18	1	0.29	13.12

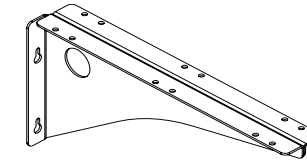

Center Cantilever Support

How to Specify:

Cantilevers are used to join 2 desks w/full modesty. Intermediate gable is required instead of cantilever when hatch sits on top of a desk.

Notes:

Options:

- cantilever available in black only

Code	Price	H	W	D	Volume (ft ³)	Weight (lb)
K-CCAB-16	120	0	16	0	3	0.1
K-CCAB-22	129	0	22	0	3	0.1

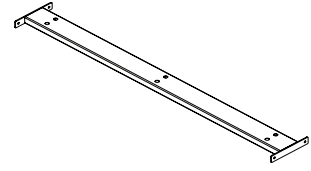

Reinforcement Bar

How to Specify:

Options:

metal support color

Code	Price	H	W	D	Volume (ft ³)	Weight (lb)
U-HRB0-27	218	1	27	6	0.2	2.5
U-HRB0-30	223	1	30	6	0.24	2.25
U-HRB0-33	229	1	33	6	0.28	2.5
U-HRB0-36	235	1	36	6	0.32	2.75
U-HRB0-39	239	1	39	6	0.36	3
U-HRB0-42	244	1	42	6	0.4	3.25
U-HRB0-45	249	1	45	6	0.44	3.5
U-HRB0-48	253	1	48	6	0.48	3.75
U-HRB0-51	263	1	51	6	0.52	4
U-HRB0-54	267	1	54	6	0.56	4.25
U-HRB0-57	275	1	57	6	0.6	4.5
U-HRB0-60	278	1	60	6	0.64	4.75
U-HRB0-63	282	1	63	6	0.68	5
U-HRB0-66	303	1	66	6	0.72	5.25
U-HRB0-69	308	1	69	6	0.76	5.5
U-HRB0-72	330	1	72	6	0.8	5.75
U-HRB0-75	342	1	75	6	0.84	6
U-HRB0-78	355	1	78	6	0.88	6.25
U-HRB0-81	371	1	81	6	0.92	6.5
U-HRB0-84	387	1	84	6	0.96	6.75
U-HRB0-87	403	1	87	6	1	7
U-HRB0-90	420	1	90	6	1.04	7.25



Metro Pricebook
January 2026

Filing & Storage

filing and storage

Executive & Professional

pedestals	122
pedestals w/ seat cushion	124
underdesk storage cabinet	125
underdesk combo pedestal BBF & FF	126
underdesk 2-drawer lateral file	127

Executive

freestanding storage cabinet	128
freestanding combo pedestal BBF & FF	130
freestanding 2-drawer lateral file	132
freestanding 3-drawer lateral file	134
freestanding 4-drawer lateral file	136
freestanding storage tower	138
freestanding combo storage tower BBF	140
freestanding combo storage tower FF	142
freestanding wardrobe storage tower	144
freestanding storage tower double door	146
freestanding combo lateral storage double door	148
freestanding combo lateral storage glazed double door	150
bookcase	152

Professional

freestanding storage cabinet	129
freestanding combo pedestal BBF & FF	131
freestanding 2-drawer lateral file	133
freestanding 3-drawer lateral file	135
freestanding 4-drawer lateral file	137
freestanding storage tower	139
freestanding combo storage tower BBF	141
freestanding combo storage tower FF	143
freestanding wardrobe storage tower	145
freestanding storage tower double door	147
freestanding combo lateral storage double door	149
freestanding combo lateral storage glazed double door	151
bookcase	154

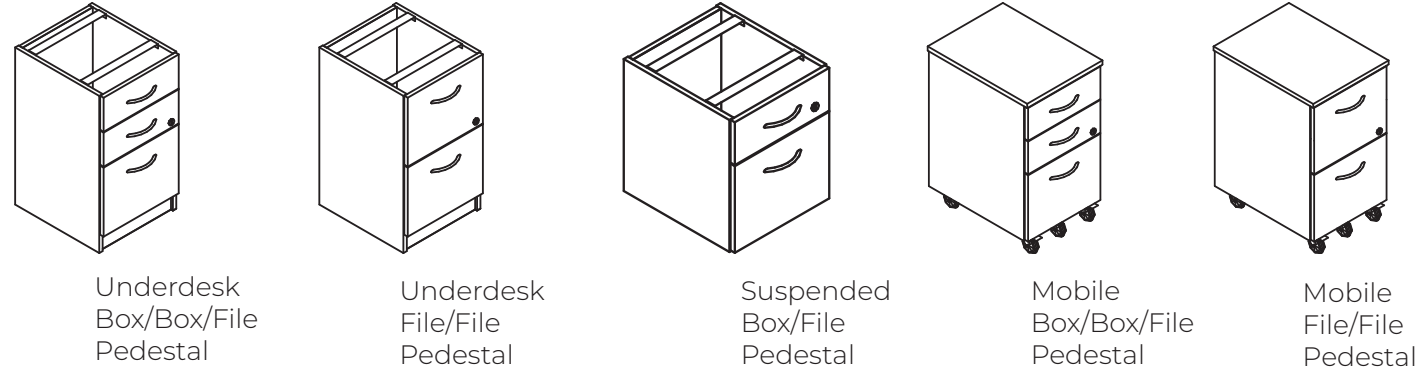

How to Specify:

Each laminate comes with matching vinyl trim color unless otherwise specified on your purchase order. Refer to the laminate finish card for details.

Notes:

Pedestals include lock and keys.

Options:

laminate color _____

handle color _____

handle style _____

back full back

Code	Price	H	W	D	Volume (ft ³)	Weight (lb)
Underdesk Box/Box/File Pedestal						
T-FPBU-1618	1052	28	16	18	4.67	55
T-FPBU-1624	1124	28	16	24	6.22	55
T-FPBU-1618-X	1151	28	16	18	4.67	55
T-FPBU-1624-X	1305	28	16	24	6.22	55
Underdesk File/File Pedestal						
T-FPFU-1618	1052	28	16	18	4.67	55
T-FPFU-1624	1124	28	16	24	6.22	55
T-FPFU-1618-X	1151	28	16	18	4.67	55
T-FPFU-1624-X	1305	28	16	24	6.22	55
Suspended Box/File Pedestal						
T-FPSU-1618	746	16	16	18	2.67	44
Mobile Box/Box/File Pedestal						
T-FPBM-1621	1382	28	16	21	5.44	74
Mobile File/File Pedestal						
T-FPFM-1621	1382	28	16	21	5.44	68

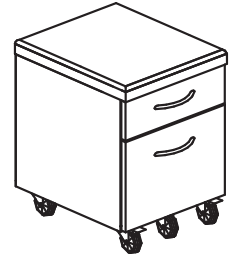

Mobile Box/File Pedestal w/
Upholstered Seat Cushion

How to Specify:

Each laminate comes with matching vinyl trim color unless otherwise specified on your purchase order. Refer to the laminate finish card for details.

Notes:

Pedestals include lock and keys.

Options:

- laminate color

- handle color

- handle style

- fabric color (for upholstered seat cushion, refer to seating fabric cards)

CODE	PRICE	H	W	D	VOLUME (FT ³)	WEIGHT (LB)
Mobile Box/File Pedestal w/Upholstered Seat Cushion						
T-1030-1618	1686	21	16	18	6.88	55

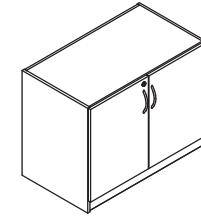

Underdesk Storage
Cabinet

How to Specify:

Each laminate comes with matching vinyl trim color unless otherwise specified on your purchase order. Refer to the laminate finish card for details.

Notes:

Cabinets and lateral files include lock and keys.

Options:

- laminate color

- handle color

- handle style

Code	Price	H	W	D	Volume (ft ³)	Weight (lb)
T-FSU0-3020	1289	28	30	19	9.72	88
T-FSU0-3620	1396	28	36	19	11.67	102
T-FSU0-4220	1502	28	42	19	13.61	117
T-FSU0-3021	1289	28	30	21	10.21	92
T-FSU0-3621	1396	28	36	21	12.25	107
T-FSU0-4221	1502	28	42	21	14.29	122

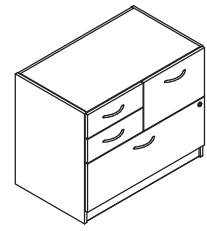

Underdesk Combo Pedestal
w/Box/Box/File and File/File,
LH Shown

How to Specify:

Each laminate comes with matching vinyl trim color unless otherwise specified on your purchase order. Refer to the laminate finish card for details.

Notes:

Cabinets and lateral files include lock and keys.

Options:

laminate color

handle color

handle style

Code	Price	H	W	D	Volume (ft ³)	Weight (lb)
T-FPJU-3620-L	2033	28	36	20	11.67	121
T-FPJU-3621-L	2033	28	36	21	12.25	122
T-FPJU-3620-R	2033	28	36	20	11.67	121
T-FPJU-3621-R	2033	28	36	21	12.25	122

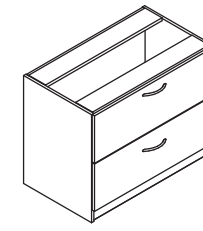

Underdesk 2-Drawer
Lateral File

How to Specify:

Each laminate comes with matching vinyl trim color unless otherwise specified on your purchase order. Refer to the laminate finish card for details.

Notes:

Cabinets and lateral files include lock and keys.

Options:

laminate color

handle color

handle style

Code	Price	H	W	D	Volume (ft ³)	Weight (lb)
T-FL2U-3020	1663	28	30	20	9.72	82.06
T-FL2U-3620	1723	28	36	20	11.67	86.64
T-FL2U-4220	1819	28	42	20	13.61	89.35
T-FL2U-3021	1663	28	30	21	10.21	84.6
T-FL2U-3621	1723	28	36	21	12.25	88.02
T-FL2U-4221	1819	28	42	21	14.29	91.44

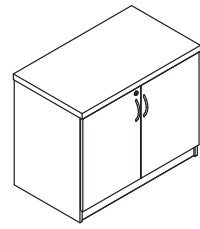

1.5" Freestanding Storage Cabinet

How to Specify:

Each laminate comes with matching vinyl trim color unless otherwise specified on your purchase order. Refer to the laminate finish card for details.

Notes:

Cabinets and lateral files include lock and keys.

Options:

laminate color

edge profile (for freestanding cabinet)

handle color

handle style

Code	Price	H	W	D	Volume (ft ³)	Weight (lb)
T-FSF0-3021	1419	29.5	30	21	10.76	98
T-FSF0-3621	1522	29.5	36	21	12.91	111
T-FSF0-4221	1625	29.5	42	21	15.06	124

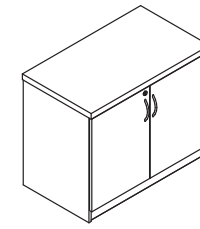

1" Freestanding Storage Cabinet

How to Specify:

Each laminate comes with matching vinyl trim color unless otherwise specified on your purchase order. Refer to the laminate finish card for details.

Notes:

Cabinets and lateral files include lock and keys.

Options:

laminate color

edge profile (for freestanding cabinet)

handle color

handle style

Code	Price	H	W	D	Volume (ft ³)	Weight (lb)
TL-FSF0-3021	1356	29	30	21	10.57	88
TL-FSF0-3621	1462	29	36	21	12.69	97
TL-FSF0-4221	1565	29	42	21	14.8	106

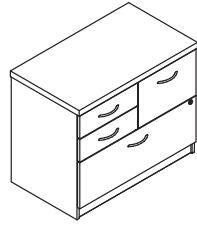

1.5" Freestanding Combo Pedestal w/Box/Box/File and File/File, LH Shown

How to Specify:

Each laminate comes with matching vinyl trim color unless otherwise specified on your purchase order. Refer to the laminate finish card for details.

Options:

laminate color

edge profile (for freestanding cabinet)

handle color

handle style

Notes:

Cabinets and lateral files include lock and keys.

Code	Price	H	W	D	Volume (ft ³)	Weight (lb)
T-FPJF-3621-L	2129	29.5	36	21	12.91	130
T-FPJF-3621-R	2129	29.5	36	21	12.91	130

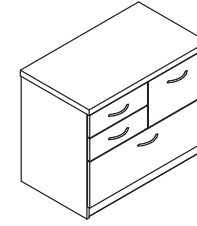

1" Freestanding Combo Pedestal w/Box/Box/File and File/File, LH Shown

How to Specify:

Each laminate comes with matching vinyl trim color unless otherwise specified on your purchase order. Refer to the laminate finish card for details.

Options:

laminate color

handle color

handle style

Notes:

Cabinets and lateral files include lock and keys.

Code	Price	H	W	D	Volume (ft ³)	Weight (lb)
TL-FPJF-3621-L	2084	29	36	21	12.69	130
TL-FPJF-3621-R	2084	29	36	21	12.69	130

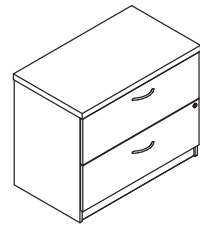

1.5" Freestanding 2-Drawer Lateral File

How to Specify:

Each laminate comes with matching vinyl trim color unless otherwise specified on your purchase order. Refer to the laminate finish card for details.

Notes:

Cabinets and lateral files include lock and keys.

Options:

laminate color

edge profile (for freestanding cabinet)

handle color

handle style

Code	Price	H	W	D	Volume (ft ³)	Weight (lb)
T-FL2F-3021	1776	29.5	30	21	10.76	108.9
T-FL2F-3621	1833	29.5	36	21	12.91	117.27
T-FL2F-4221	1923	29.5	42	21	15.06	125.64

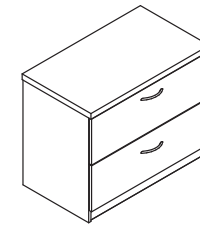

1" Freestanding 2-Drawer Lateral File

How to Specify:

Each laminate comes with matching vinyl trim color unless otherwise specified on your purchase order. Refer to the laminate finish card for details.

Notes:

Cabinets and lateral files include lock and keys.

Options:

laminate color

handle color

handle style

Code	Price	H	W	D	Volume (ft ³)	Weight (lb)
TL-FL2F-3021	1721	29	30	21	10.57	92.7
TL-FL2F-3621	1777	29	36	21	12.69	107.1
TL-FL2F-4221	1872	29	42	21	14.8	121.5

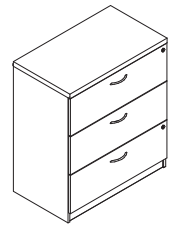

1.5" Freestanding 3-Drawer Lateral File

How to Specify:

Each laminate comes with matching vinyl trim color unless otherwise specified on your purchase order. Refer to the laminate finish card for details.

Notes:

Cabinets and lateral files include lock and keys.

Options:

laminate color

edge profile (for freestanding cabinet)

handle color

handle style

Code	Price	H	W	D	Volume (ft ³)	Weight (lb)
T-FL3F-3021	2207	40.5	30	21	14.77	145
T-FL3F-3621	2302	40.5	36	21	17.72	154.96

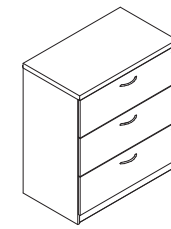

1" Freestanding 3-Drawer Lateral File

How to Specify:

Each laminate comes with matching vinyl trim color unless otherwise specified on your purchase order. Refer to the laminate finish card for details.

Notes:

Cabinets and lateral files include lock and keys.

Options:

laminate color

handle color

handle style

Code	Price	H	W	D	Volume (ft ³)	Weight (lb)
TL-FL3F-3021	1939	40	30	21	14.58	136.5
TL-FL3F-3621	2033	40	36	21	17.5	144.25

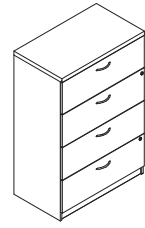

1.5" Freestanding 4-Drawer Lateral File

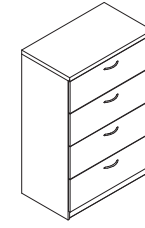

1" Freestanding 4-Drawer Lateral File

How to Specify:

Each laminate comes with matching vinyl trim color unless otherwise specified on your purchase order. Refer to the laminate finish card for details.

Notes:

Cabinets and lateral files include lock and keys.

Options:

laminate color

edge profile (for freestanding cabinet)

handle color

handle style

How to Specify:

Each laminate comes with matching vinyl trim color unless otherwise specified on your purchase order. Refer to the laminate finish card for details.

Notes:

Cabinets and lateral files include lock and keys.

Options:

laminate color

handle color

handle style

Code	Price	H	W	D	Volume (ft ³)	Weight (lb)
T-FL4F-3021	2890	52.5	30	21	19.14	171.3
T-FL4F-3621	2983	52.5	36	21	22.97	183.24

Code	Price	H	W	D	Volume (ft ³)	Weight (lb)
TL-FL4F-3021	2617	52	30	21	18.96	153.1
TL-FL4F-3621	2713	52	36	21	22.75	162.98

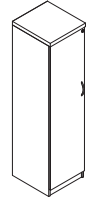

1.5" Storage Cabinet w/Shelves,
LH Shown

How to Specify:

Each laminate comes with matching vinyl trim color unless otherwise specified on your purchase order. Refer to the laminate finish card for details.

Notes:

Cabinets and lateral files include lock and keys.

Options:

laminate color

edge profile

handle color

handle style

Code	Price	H	W	D	Volume (ft ³)	Weight (lb)
T-FSDS-1821-L	1574	68	18	21	14.88	133.65
T-FSDS-1821-R	1574	68	18	21	14.88	133.65

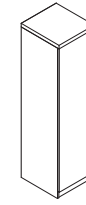

1" Storage Cabinet w/Shelves,
LH Shown

How to Specify:

Each laminate comes with matching vinyl trim color unless otherwise specified on your purchase order. Refer to the laminate finish card for details.

Notes:

Cabinets and lateral files include lock and keys.

Options:

laminate color

handle color

handle style

Code	Price	H	W	D	Volume (ft ³)	Weight (lb)
TL-FSDS-1821-L	1511	67	18	21	14.66	128.7
TL-FSDS-1821-R	1511	67	18	21	14.66	128.7

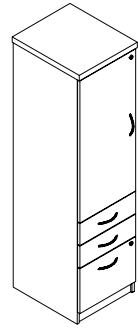

1.5" Combo Cabinet w/Storage and Box/Box/File,

How to Specify:

Each laminate comes with matching vinyl trim color unless otherwise specified on your purchase order. Refer to the laminate finish card for details.

Notes:

Cabinets and lateral files include lock and keys.

Options:

laminate color

edge profile

handle color

handle style

Code	Price	H	W	D	Volume (ft ³)	Weight (lb)
T-FCSB-1821-L	2473	68	18	21	14.88	168
T-FCSB-1821-R	2473	68	18	21	14.88	168

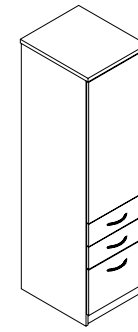

1" Combo Cabinet w/Storage and Box/Box/File,

How to Specify:

Each laminate comes with matching vinyl trim color unless otherwise specified on your purchase order. Refer to the laminate finish card for details.

Notes:

Cabinets and lateral files include lock and keys.

Options:

laminate color

handle color

handle style

Code	Price	H	W	D	Volume (ft ³)	Weight (lb)
TL-FCSB-1821-L	2205	67	18	21	14.66	163
TL-FCSB-1821-R	2205	67	18	21	14.66	163



1.5" Combo Cabinet w/Storage and File/File, LH Shown

How to Specify:

Each laminate comes with matching vinyl trim color unless otherwise specified on your purchase order. Refer to the laminate finish card for details.

Notes:

Cabinets and lateral files include lock and keys.

Options:

laminate color

edge profile

handle color

handle style

Code	Price	H	W	D	Volume (ft ³)	Weight (lb)
T-FCSF-1821-L	2473	68	18	21	14.88	162
T-FCSF-1821-R	2473	68	18	21	14.88	162



1" Combo Cabinet w/Storage and File/File, LH Shown

How to Specify:

Each laminate comes with matching vinyl trim color unless otherwise specified on your purchase order. Refer to the laminate finish card for details.

Notes:

Cabinets and lateral files include lock and keys.

Options:

laminate color

handle color

handle style

Code	Price	H	W	D	Volume (ft ³)	Weight (lb)
TL-FCSF-1821-L	2205	67	18	21	14.66	129
TL-FCSF-1821-R	2205	67	18	21	14.66	129

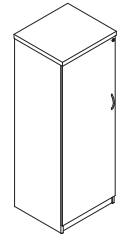

1.5" Storage Cabinet w/Coat Bar and Shelves,

How to Specify:

Each laminate comes with matching vinyl trim color unless otherwise specified on your purchase order. Refer to the laminate finish card for details.

Notes:

Cabinets and lateral files include lock and keys.

Options:

laminate color

edge profile

handle color

handle style

Code	Price	H	W	D	Volume (ft ³)	Weight (lb)
T-FSDC-2421-L	1697	68	24	21	19.83	179.64
T-FSDC-2421-R	1697	68	24	21	19.83	179.64

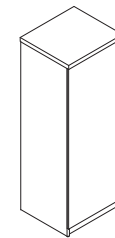

1" Storage Cabinet w/Coat Bar and Shelves,

How to Specify:

Each laminate comes with matching vinyl trim color unless otherwise specified on your purchase order. Refer to the laminate finish card for details.

Notes:

Cabinets and lateral files include lock and keys.

Options:

laminate color

handle color

handle style

Code	Price	H	W	D	Volume (ft ³)	Weight (lb)
TL-FSDC-2421-L	1634	67	24	21	19.54	169.95
TL-FSDC-2421-R	1634	67	24	21	19.54	169.95

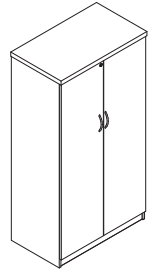

1.5" Double Door Storage Cabinet w/Shelves

How to Specify:

Each laminate comes with matching vinyl trim color unless otherwise specified on your purchase order. Refer to the laminate finish card for details.

Notes:

Cabinets and lateral files include lock and keys.

Options:

laminate color

edge profile

handle color

handle style

Code	Price	H	W	D	Volume (ft ³)	Weight (lb)
T-FSDS-3021	2389	68	30	21	25	196
T-FSDS-3621	2473	68	36	21	29.75	204.96

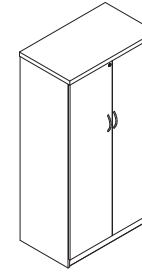

1" Double Door Storage Cabinet w/Shelves

How to Specify:

Each laminate comes with matching vinyl trim color unless otherwise specified on your purchase order. Refer to the laminate finish card for details.

Notes:

Cabinets and lateral files include lock and keys.

Options:

laminate color

handle color

handle style

Code	Price	H	W	D	Volume (ft ³)	Weight (lb)
TL-FSDS-3021	2217	67	30	21	24	180
TL-FSDS-3621	2301	67	36	21	29.31	195.39

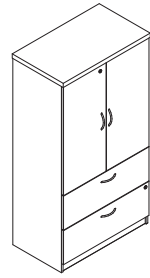

1.5" Combo Cabinet w/Storage and Lateral File

How to Specify:

Each laminate comes with matching vinyl trim color unless otherwise specified on your purchase order. Refer to the laminate finish card for details.

Notes:

Cabinets and lateral files include lock and keys.

Options:

- laminate color _____
- edge profile _____
- handle color _____
- handle style _____

Code	Price	H	W	D	Volume (ft ³)	Weight (lb)
T-FCSL-3621	2935	68	36	21	29.75	260.82

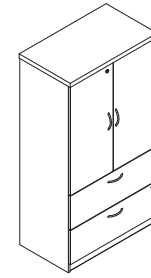

1" Combo Cabinet w/Storage and Lateral File

How to Specify:

Each laminate comes with matching vinyl trim color unless otherwise specified on your purchase order. Refer to the laminate finish card for details.

Notes:

Cabinets and lateral files include lock and keys.

Options:

- laminate color _____
- handle color _____
- handle style _____

Code	Price	H	W	D	Volume (ft ³)	Weight (lb)
TL-FCSL-3621	2667	67	36	21	29.31	251.25

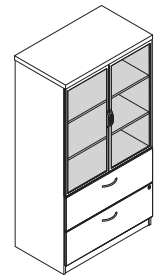

1.5" Combo Cabinet w/Storage, Lateral File

How to Specify:

Each laminate comes with matching vinyl trim color unless otherwise specified on your purchase order. Refer to the laminate finish card for details.

Notes:

Only laminate drawers include lock and keys.

Options:

- _____ laminate color
- _____ edge profile
- _____ metal color (for acrylic door frame)
- _____ handle color
- _____ handle style

Code	Price	H	W	D	Volume (ft ³)	Weight (lb)
T-FCSL-3621-G	4728	68	36	21	29.75	222.62

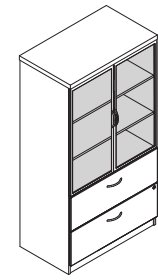

1" Combo Cabinet w/Storage, Lateral File

How to Specify:

Each laminate comes with matching vinyl trim color unless otherwise specified on your purchase order. Refer to the laminate finish card for details.

Notes:

Only laminate drawers include lock and keys.

Options:

- _____ laminate color
- _____ metal color (for acrylic door frame)
- _____ handle color
- _____ handle style

Code	Price	H	W	D	Volume (ft ³)	Weight (lb)
TL-FCSL-3621-G	4474	67	36	21	29.31	213.05

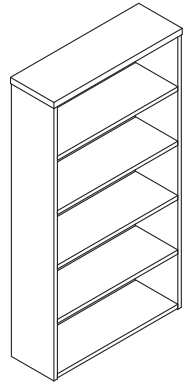

1.5" bookcase

How to Specify:

Each laminate comes with matching vinyl trim color unless otherwise specified on your purchase order. Refer to the laminate finish card for details.

Notes:

Book cases have adjustable shelves and one fixed shelf at desk height.

All bookcases come with a solid laminate back in matching color.

Number of shelves includes shelf on bottom of bookcase.

Options:

laminate color

Code	Price	H	W	D	Volume (ft ³)	Weight (lb)	# of Shelves
12" Deep							
T-SB0X-292412	762	29	24	12	4.8	51.61	2H
T-SB0X-293012	838	29	30	12	6	60.72	2H
T-SB0X-293612	911	29	36	12	7.3	69.83	2H
T-SB0X-294212	986	29	42	12	8.5	78.93	2H
T-SB0X-422412	953	42	24	12	7	70.73	3H
T-SB0X-423012	1038	42	30	12	8.8	82.94	3H
T-SB0X-423612	1128	42	36	12	10.5	95.14	3H
T-SB0X-424212	1216	42	42	12	12.3	107.35	3H
T-SB0X-542412	1119	54	24	12	9	88.85	4H
T-SB0X-543012	1221	54	30	12	11.3	104.04	4H
T-SB0X-543612	1328	54	36	12	13.5	119.23	4H
T-SB0X-544212	1432	54	42	12	15.8	134.42	4H
T-SB0X-682412	1299	68	24	12	11.3	108.38	5H
T-SB0X-683012	1425	68	30	12	14.2	126.79	5H
T-SB0X-683612	1551	68	36	12	17	145.19	5H
T-SB0X-684212	1678	68	42	12	19.8	163.59	5H
T-SB0X-782412	1465	78	24	12	13	124.48	6H
T-SB0X-783012	1609	78	30	12	16.3	145.65	6H
T-SB0X-783612	1755	78	36	12	19.5	166.81	6H
T-SB0X-784212	1899	78	42	12	22.8	187.98	6H
15" Deep							
T-SB0X-292415	861	29	24	15	6	61.91	2H
T-SB0X-293015	944	29	30	15	7.6	72.59	2H
T-SB0X-293615	1027	29	36	15	9.1	83.26	2H
T-SB0X-294215	1112	29	42	15	10.6	93.94	2H
T-SB0X-422415	1069	42	24	15	8.8	84.62	3H
T-SB0X-423015	1170	42	30	15	10.9	98.84	3H
T-SB0X-423615	1270	42	36	15	13.1	113.06	3H
T-SB0X-424215	1369	42	42	15	15.3	127.28	3H
T-SB0X-542415	1257	54	24	15	11.3	106.17	4H
T-SB0X-543015	1371	54	30	15	14.1	123.82	4H
T-SB0X-543615	1495	54	36	15	16.9	141.48	4H
T-SB0X-544215	1611	54	42	15	19.7	159.13	4H
T-SB0X-682415	1462	68	24	15	14.2	129.29	5H
T-SB0X-683015	1602	68	30	15	17.7	150.6	5H
T-SB0X-683615	1747	68	36	15	21.3	171.91	5H
T-SB0X-684215	1889	68	42	15	24.8	193.23	5H
T-SB0X-782415	1648	78	24	15	16.3	149.27	6H
T-SB0X-783015	1808	78	30	15	20.3	173.79	6H
T-SB0X-783615	1974	78	36	15	24.4	198.32	6H
T-SB0X-784215	2136	78	42	15	28.4	222.84	6H

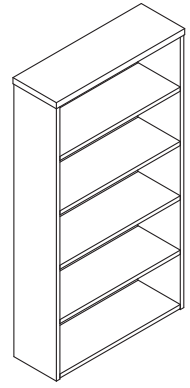

1" bookcase

12" or 15" Deep

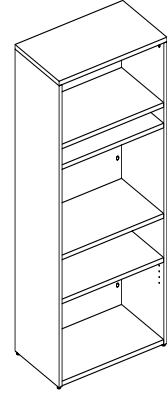

21" Deep

How to Specify:

Each laminate comes with matching vinyl trim color unless otherwise specified on your purchase order. Refer to the laminate finish card for details.

Notes:

Book cases have adjustable shelves and one fixed shelf at desk height.

All bookcases come with a solid laminate back in matching color.

Number of shelves includes shelf on bottom of bookcase.

Options:

laminate color

edge profile

Code	Price	H	W	D	Volume (ft ³)	Weight (lb)	# of Shelves
12" Deep							
TL-SB0X-292412	704	29	24	12	4.8	48.03	2H
TL-SB0X-293012	779	29	30	12	6	56.24	2H
TL-SB0X-293612	850	29	36	12	7.3	64.45	2H
TL-SB0X-294212	925	29	42	12	8.5	72.66	2H
TL-SB0X-422412	900	42	24	12	7	67.15	3H
TL-SB0X-423012	986	42	30	12	8.8	78.46	3H
TL-SB0X-423612	1078	42	36	12	10.5	89.77	3H
TL-SB0X-424212	1164	42	42	12	12.3	101.08	3H
TL-SB0X-542412	1057	54	24	12	9	85.27	4H
TL-SB0X-543012	1166	54	30	12	11.3	99.56	4H
TL-SB0X-543612	1274	54	36	12	13.5	113.86	4H
TL-SB0X-544212	1389	54	42	12	15.8	128.15	4H
TL-SB0X-672412	1236	67	24	12	11.2	104.8	5H
TL-SB0X-673012	1370	67	30	12	14	122.31	5H
TL-SB0X-673612	1504	67	36	12	16.8	139.81	5H
TL-SB0X-674212	1637	67	42	12	19.5	157.32	5H
TL-SB0X-772412	1403	77	24	12	12.8	120.9	6H
TL-SB0X-773012	1550	77	30	12	16	141.17	6H
TL-SB0X-773612	1698	77	36	12	19.3	161.44	6H
TL-SB0X-774212	1849	77	42	12	22.5	181.7	6H
15" Deep							
TL-SB0X-292415	790	29	24	15	6	57.43	2H
TL-SB0X-293015	877	29	30	15	7.6	66.99	2H
TL-SB0X-293615	959	29	36	15	9.1	76.54	2H
TL-SB0X-294215	1043	29	42	15	10.6	86.1	2H
TL-SB0X-422415	1009	42	24	15	8.8	80.14	3H
TL-SB0X-423015	1112	42	30	15	10.9	93.24	3H
TL-SB0X-423615	1209	42	36	15	13.1	106.34	3H
TL-SB0X-424215	1309	42	42	15	15.3	119.44	3H
TL-SB0X-542415	1187	54	24	15	11.3	101.69	4H
TL-SB0X-543015	1312	54	30	15	14.1	118.23	4H
TL-SB0X-543615	1437	54	36	15	16.9	134.76	4H
TL-SB0X-544215	1563	54	42	15	19.7	151.3	4H
TL-SB0X-672415	1391	67	24	15	14	124.81	5H
TL-SB0X-673015	1543	67	30	15	17.4	145	5H
TL-SB0X-673615	1694	67	36	15	20.9	165.19	5H
TL-SB0X-674215	1844	67	42	15	24.4	185.39	5H
TL-SB0X-772415	1576	77	24	15	16	144.04	6H
TL-SB0X-773015	1744	77	30	15	20.1	167.45	6H
TL-SB0X-773615	1913	77	36	15	24.1	190.85	6H
TL-SB0X-774215	2083	77	42	15	28.1	214.25	6H
21" Deep							
TL-SB0S-673621	2682	67.38	36	21	29.48	151.94	4H



Metro Pricebook
January 2026

Overhead Storage

overhead storage

Executive

<u>open hutch</u>	156
<u>hinged door hutch</u>	158
<u>glazed door hutch</u>	160
<u>open hutch w/ pidgeon holes</u>	162
<u>hinged door hutch w/ pidgeon holes</u>	164
<u>wall mounted hinged door hutch</u>	166
<u>wall mounted glazed door hutch</u>	168

Professional

<u>open hutch</u>	157
<u>hinged door hutch</u>	159
<u>glazed door hutch</u>	161
<u>open hutch w/ pidgeon holes</u>	163
<u>hinged door hutch w/ pidgeon holes</u>	165
<u>wall mounted hinged door hutch</u>	167
<u>wall mounted glazed door hutch</u>	169

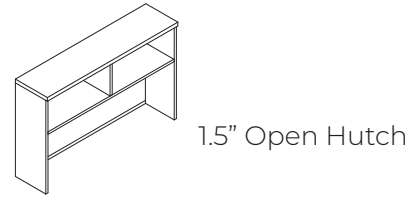

How to Specify:

Each laminate comes with matching vinyl trim color unless otherwise specified on your purchase order. Refer to the laminate finish card for details.

Notes:

Number of Openings and Doors per Hutch										
width(in)	30	36	42	48	54	60	66	72	78	84
openings	1	1	2	2	2	2	2	2	2	2

Options:

- laminate color

- edge profile

- metal color (for acrylic door frames)

- acrylic color (for doors)

Code	Price	H	W	D	Volume (ft ³)	Weight (lb)
T-SH00-1530	849	39	30	15	10.16	75.62
T-SH00-1536	982	39	36	15	12.19	84.86
T-SH00-1542	1021	39	42	15	14.22	94.1
T-SH00-1548	1128	39	48	15	16.25	103.34
T-SH00-1554	1224	39	54	15	18.28	112.58
T-SH00-1560	1324	39	60	15	20.31	121.82
T-SH00-1566	1408	39	66	15	22.34	131.06
T-SH00-1572	1515	39	72	15	24.38	140.3
T-SH00-1578	1603	39	78	15	26.41	149.54
T-SH00-1584	1697	39	84	15	28.44	158.78

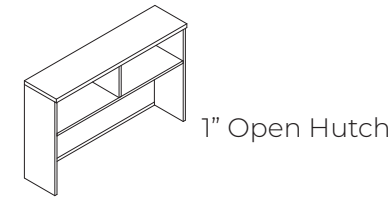

How to Specify:

Each laminate comes with matching vinyl trim color unless otherwise specified on your purchase order. Refer to the laminate finish card for details.

Notes:

Number of Openings and Doors per Hutch										
width(in)	30	36	42	48	54	60	66	72	78	84
openings	1	1	2	2	2	2	2	2	2	2

Options:

- laminate color

- metal color (for acrylic door frames)

- acrylic color (for doors)

Code	Price	H	W	D	Volume (ft ³)	Weight (lb)
TL-SH00-1530	699	38.5	30	15	16.08	69.79
TL-SH00-1536	832	38.5	36	15	18.91	79.03
TL-SH00-1542	864	38.5	42	15	21.75	88.27
TL-SH00-1548	979	38.5	48	15	24.59	97.51
TL-SH00-1554	1074	38.5	54	15	27.42	106.75
TL-SH00-1560	1172	38.5	60	15	30.26	115.99
TL-SH00-1566	1257	38.5	66	15	33.1	125.23
TL-SH00-1572	1368	38.5	72	15	35.93	134.47
TL-SH00-1578	1449	38.5	78	15	38.77	143.71
TL-SH00-1584	1548	38.5	84	15	41.61	152.95

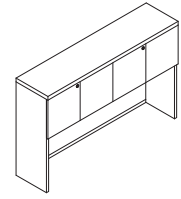

1.5" Hinged-Door Hutch

How to Specify:

Each laminate comes with matching vinyl trim color unless otherwise specified on your purchase order. Refer to the laminate finish card for details.

Notes:

Number of Openings and Doors per Hutch										
width(in)	30	36	42	48	54	60	66	72	78	84
openings	1	1	2	2	2	2	2	2	2	2
doors	2	2	3	3	3	4	4	4	4	4

Laminate doors include locks and keys.

Options:

laminate color

edge profile

Code	Price	H	W	D	Volume (ft ³)	Weight (lb)
T-SHH0-1530-L	1306	39	30	15	10.16	85.07
T-SHH0-1536-L	1379	39	36	15	12.19	94.31
T-SHH0-1542-L	1574	39	42	15	14.22	103.55
T-SHH0-1548-L	1711	39	48	15	16.25	117.51
T-SHH0-1554-L	1857	39	54	15	18.28	126.75
T-SHH0-1560-L	1979	39	60	15	20.31	140.72
T-SHH0-1566-L	2099	39	66	15	22.34	149.96
T-SHH0-1572-L	2207	39	72	15	24.38	159.2
T-SHH0-1578-L	2315	39	78	15	26.41	168.44
T-SHH0-1584-L	2401	39	84	15	28.44	177.68

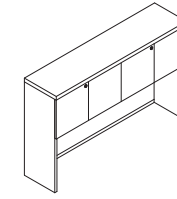

1" Hinged-Door Hutch

How to Specify:

Each laminate comes with matching vinyl trim color unless otherwise specified on your purchase order. Refer to the laminate finish card for details.

Notes:

Number of Openings and Doors per Hutch										
width(in)	30	36	42	48	54	60	66	72	78	84
openings	1	1	2	2	2	2	2	2	2	2
doors	2	2	3	3	3	4	4	4	4	4

Laminate doors include locks and keys.

Options:

laminate color

metal color (for acrylic door frames)

Code	Price	H	W	D	Volume (ft ³)	Weight (lb)
TL-SHH0-1530-L	1168	38.5	30	15	16.08	79.24
TL-SHH0-1536-L	1232	38.5	36	15	18.91	88.48
TL-SHH0-1542-L	1408	38.5	42	15	21.75	102.44
TL-SHH0-1548-L	1525	38.5	48	15	24.59	111.68
TL-SHH0-1554-L	1661	38.5	54	15	27.42	120.92
TL-SHH0-1560-L	1765	38.5	60	15	30.26	134.89
TL-SHH0-1566-L	1873	38.5	66	15	33.1	144.13
TL-SHH0-1572-L	1970	38.5	72	15	35.93	153.37
TL-SHH0-1578-L	2070	38.5	78	15	38.77	162.61
TL-SHH0-1584-L	2146	38.5	84	15	41.61	171.85

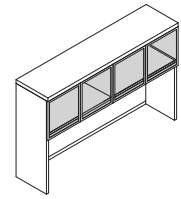

1.5" Hinged-Door Hutch w/Acrylic Doors

How to Specify:

Each laminate comes with matching vinyl trim color unless otherwise specified on your purchase order. Refer to the laminate finish card for details.

Notes:

Number of Openings and Doors per Hutch										
width(in)	30	36	42	48	54	60	66	72	78	84
openings	1	1	2	2	2	2	2	2	2	2
doors	2	2	3	3	3	4	4	4	4	4

Acrylic doors do not have locks

Options:

laminate color

edge profile

metal color (for acrylic door frames)

acrylic color (for doors)

Code	Price	H	W	D	Volume (ft ³)	Weight (lb)
T-SHH0-1530-G	2099	39	30	15	10.16	88.22
T-SHH0-1536-G	2267	39	36	15	12.19	96.56
T-SHH0-1542-G	2429	39	42	15	14.22	105.8
T-SHH0-1548-G	3011	39	48	15	16.25	122.24
T-SHH0-1554-G	3188	39	54	15	18.28	131.48
T-SHH0-1560-G	3749	39	60	15	20.31	147.92
T-SHH0-1566-G	3823	39	66	15	22.34	157.16
T-SHH0-1572-G	3993	39	72	15	24.38	166.4
T-SHH0-1578-G	4113	39	78	15	26.41	175.64
T-SHH0-1584-G	4222	39	84	15	28.44	184.88

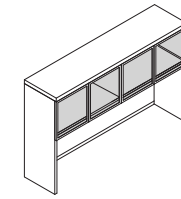

1" Hinged-Door Hutch w/Acrylic Doors

How to Specify:

Each laminate comes with matching vinyl trim color unless otherwise specified on your purchase order. Refer to the laminate finish card for details.

Notes:

Number of Openings and Doors per Hutch										
width(in)	30	36	42	48	54	60	66	72	78	84
openings	1	1	2	2	2	2	2	2	2	2
doors	2	2	3	3	3	4	4	4	4	4

Acrylic doors do not have locks and keys.

Options:

laminate color

metal color (for acrylic door frames)

acrylic color (for doors)

Code	Price	H	W	D	Volume (ft ³)	Weight (lb)
TL-SHH0-1530-G	1831	38.5	30	15	16.08	82.39
TL-SHH0-1536-G	1996	38.5	36	15	18.91	91.63
TL-SHH0-1542-G	2156	38.5	42	15	21.75	107.17
TL-SHH0-1548-G	2737	38.5	48	15	24.59	116.41
TL-SHH0-1554-G	2921	38.5	54	15	27.42	125.65
TL-SHH0-1560-G	3478	38.5	60	15	30.26	142.09
TL-SHH0-1566-G	3550	38.5	66	15	33.1	151.33
TL-SHH0-1572-G	3721	38.5	72	15	35.93	160.57
TL-SHH0-1578-G	3841	38.5	78	15	38.77	169.81
TL-SHH0-1584-G	3952	38.5	84	15	41.61	179.05

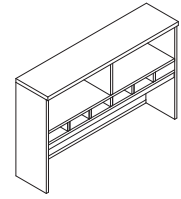

1.5" Open Hutch w/Pigeonholes

How to Specify:

Each laminate comes with matching vinyl trim color unless otherwise specified on your purchase order. Refer to the laminate finish card for details.

Notes:

Number of Openings and Doors per Hutch										
width(in)	30	36	42	48	54	60	66	72	78	84
openings	1	1	2	2	2	2	2	2	2	2
# of pigeon holes	3	3	4	4	5	6	6	7	8	8

Options:

laminate color

edge profile

Code	Price	H	W	D	Volume (ft ³)	Weight (lb)
T-SHOP-1530	1186	39	30	15	10.16	87.77
T-SHOP-1536	1370	39	36	15	12.19	97.01
T-SHOP-1542	1419	39	42	15	14.22	111.69
T-SHOP-1548	1574	39	48	15	16.25	120.93
T-SHOP-1554	1711	39	54	15	18.28	135.58
T-SHOP-1560	1844	39	60	15	20.31	148.2
T-SHOP-1566	1967	39	66	15	22.34	157.44
T-SHOP-1572	2122	39	72	15	24.38	170.74
T-SHOP-1578	2231	39	78	15	26.41	183.36
T-SHOP-1584	2377	39	84	15	28.44	195.99

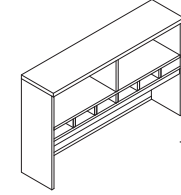

1" Open Hutch w/Pigeonholes

How to Specify:

Each laminate comes with matching vinyl trim color unless otherwise specified on your purchase order. Refer to the laminate finish card for details.

Notes:

Number of Openings and Doors per Hutch										
width(in)	30	36	42	48	54	60	66	72	78	84
openings	1	1	2	2	2	2	2	2	2	2
# of pigeon holes	3	3	4	4	5	6	6	7	8	8

Options:

laminate color

Code	Price	H	W	D	Volume (ft ³)	Weight (lb)
TL-SHOP-1530	918	38.5	30	15	16.08	81.94
TL-SHOP-1536	1100	38.5	36	15	18.91	91.18
TL-SHOP-1542	1149	38.5	42	15	21.75	105.86
TL-SHOP-1548	1305	38.5	48	15	24.59	115.1
TL-SHOP-1554	1442	38.5	54	15	27.42	129.75
TL-SHOP-1560	1572	38.5	60	15	30.26	142.37
TL-SHOP-1566	1696	38.5	66	15	33.1	151.61
TL-SHOP-1572	1856	38.5	72	15	35.93	164.91
TL-SHOP-1578	1963	38.5	78	15	38.77	177.53
TL-SHOP-1584	2109	38.5	84	15	41.61	190.16

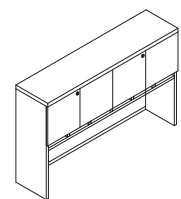

1.5" Hinged-Door Hutch w/Pigeonholes

How to Specify:

Each laminate comes with matching vinyl trim color unless otherwise specified on your purchase order. Refer to the laminate finish card for details.

Notes:

Number of Openings and Doors per Hutch										
width(in)	30	36	42	48	54	60	66	72	78	84
openings	1	1	2	2	2	2	2	2	2	2
# of pigeon holes	3	3	4	4	5	6	6	7	8	8

Options:

laminate color

edge profile

Code	Price	H	W	D	Volume (ft ³)	Weight (lb)
T-SHHP-1530-L	1612	39	30	15	10.16	97.22
T-SHHP-1536-L	1717	39	36	15	12.19	106.46
T-SHHP-1542-L	1943	39	42	15	14.22	121.14
T-SHHP-1548-L	2129	39	48	15	16.25	135.1
T-SHHP-1554-L	2312	39	54	15	18.28	149.75
T-SHHP-1560-L	2457	39	60	15	20.31	167.1
T-SHHP-1566-L	2538	39	66	15	22.34	176.34
T-SHHP-1572-L	2699	39	72	15	24.38	189.64
T-SHHP-1578-L	2815	39	78	15	26.41	202.26
T-SHHP-1584-L	2927	39	84	15	28.44	214.89

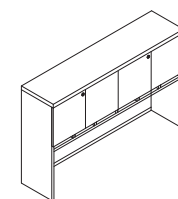

1" Hinged-Door Hutch w/Pigeonholes

How to Specify:

Each laminate comes with matching vinyl trim color unless otherwise specified on your purchase order. Refer to the laminate finish card for details.

Notes:

Number of Openings and Doors per Hutch										
width(in)	30	36	42	48	54	60	66	72	78	84
openings	1	1	2	2	2	2	2	2	2	2
# of pigeon holes	3	3	4	4	5	6	6	7	8	8

Options:

laminate color

metal color (for acrylic door frame)

Code	Price	H	W	D	Volume (ft ³)	Weight (lb)
TL-SHHP-1530-L	1344	38.5	30	15	16.08	91.39
TL-SHHP-1536-L	1446	38.5	36	15	18.91	100.63
TL-SHHP-1542-L	1676	38.5	42	15	21.75	120.03
TL-SHHP-1548-L	1864	38.5	48	15	24.59	129.27
TL-SHHP-1554-L	2044	38.5	54	15	27.42	143.92
TL-SHHP-1560-L	2193	38.5	60	15	30.26	161.27
TL-SHHP-1566-L	2269	38.5	66	15	33.1	170.51
TL-SHHP-1572-L	2434	38.5	72	15	35.93	183.81
TL-SHHP-1578-L	2547	38.5	78	15	38.77	196.43
TL-SHHP-1584-L	2657	38.5	84	15	41.61	209.06

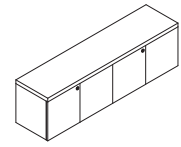

1.5" Wall-Mounted Hinged-Door Hutch

How to Specify:

Each laminate comes with matching vinyl trim color unless otherwise specified on your purchase order. Refer to the laminate finish card for details.

Notes:

Number of Openings and Doors per Hutch										
width(in)	30	36	42	48	54	60	66	72	78	84
openings	1	1	2	2	2	2	2	2	2	2
doors	2	2	3	3	3	4	4	4	4	4

Laminate doors include locks and keys.

Install wall-mounted overheads directly onto permanent studs. Please refer to installation instructions.

Options:

laminate color

edge profile

Code	Price	H	W	D	Volume (ft ³)	Weight (lb)
T-SHHW-1530-L	933	17	30	15	4.43	46.9
T-SHHW-1536-L	990	17	36	15	5.31	52.99
T-SHHW-1542-L	1105	17	42	15	6.2	59.08
T-SHHW-1548-L	1164	17	48	15	7.08	65.17
T-SHHW-1554-L	1219	17	54	15	7.97	71.26
T-SHHW-1560-L	1332	17	60	15	8.85	77.35
T-SHHW-1566-L	1389	17	66	15	9.74	83.44
T-SHHW-1572-L	1446	17	72	15	10.63	89.53

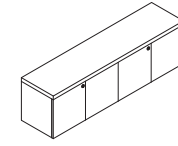

1" Wall-Mounted Hinged-Door Hutch

How to Specify:

Each laminate comes with matching vinyl trim color unless otherwise specified on your purchase order. Refer to the laminate finish card for details.

Notes:

Number of Openings and Doors per Hutch										
width(in)	30	36	42	48	54	60	66	72	78	84
openings	1	1	2	2	2	2	2	2	2	2
doors	2	2	3	3	3	4	4	4	4	4

Laminate doors include locks and keys.

Install wall-mounted overheads directly onto permanent studs. Please refer to installation instructions.

Options:

laminate color

Code	Price	H	W	D	Volume (ft ³)	Weight (lb)
TL-SHHW-1530-L	893	16.5	30	15	7.67	42.05
TL-SHHW-1536-L	944	16.5	36	15	9.02	46.84
TL-SHHW-1542-L	1050	16.5	42	15	10.37	51.63
TL-SHHW-1548-L	1095	16.5	48	15	11.72	56.42
TL-SHHW-1554-L	1147	16.5	54	15	13.07	61.21
TL-SHHW-1560-L	1254	16.5	60	15	14.43	66
TL-SHHW-1566-L	1301	16.5	66	15	15.78	70.79
TL-SHHW-1572-L	1353	16.5	72	15	17.13	75.58

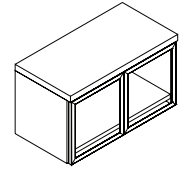

1.5" Wall-Mounted Hinged-Door Hutch w/Acrylic Doors

How to Specify:

Each laminate comes with matching vinyl trim color unless otherwise specified on your purchase order. Refer to the laminate finish card for details.

Notes:

Number of Openings and Doors per Hutch										
width(in)	30	36	42	48	54	60	66	72	78	84
openings	1	1	2	2	2	2	2	2	2	2
doors	2	2	3	3	3	4	4	4	4	4

Acrylic doors do not have locks and keys.

Install wall-mounted overheads directly onto permanent studs. Please refer to installation instructions.

Options:

laminate color

edge profile

metal color (for acrylic door frame)

acrylic color (door)

Code	Price	H	W	D	Volume (ft ³)	Weight (lb)
T-SHHW-1530-G	1791	17	30	15	4.43	46.9
T-SHHW-1536-G	1937	17	36	15	5.31	52.99
T-SHHW-1542-G	2239	17	42	15	6.2	59.08
T-SHHW-1548-G	2385	17	48	15	7.08	65.17
T-SHHW-1554-G	2590	17	54	15	7.97	71.26
T-SHHW-1560-G	2910	17	60	15	8.85	77.35
T-SHHW-1566-G	3054	17	66	15	9.74	83.44
T-SHHW-1572-G	3201	17	72	15	10.63	89.53

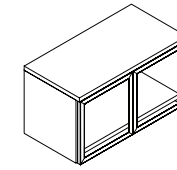

1" Wall-Mounted Hinged-Door Hutch w/Acrylic Doors

How to Specify:

Each laminate comes with matching vinyl trim color unless otherwise specified on your purchase order. Refer to the laminate finish card for details.

Notes:

Number of Openings and Doors per Hutch										
width(in)	30	36	42	48	54	60	66	72	78	84
openings	1	1	2	2	2	2	2	2	2	2
doors	2	2	3	3	3	4	4	4	4	4

Acrylic doors do not have locks and keys.

Install wall-mounted overheads directly onto permanent studs. Please refer to installation instructions.

Options:

laminate color

metal color (for acrylic door frame)

acrylic color (door)

Code	Price	H	W	D	Volume (ft ³)	Weight (lb)
TL-SHHW-1530-G	1747	16.5	30	15	7.67	42.05
TL-SHHW-1536-G	1888	16.5	36	15	9.02	46.84
TL-SHHW-1542-G	2179	16.5	42	15	10.37	51.63
TL-SHHW-1548-G	2322	16.5	48	15	11.72	56.42
TL-SHHW-1554-G	2517	16.5	54	15	13.07	61.21
TL-SHHW-1560-G	2830	16.5	60	15	14.43	66
TL-SHHW-1566-G	2966	16.5	66	15	15.78	70.79
TL-SHHW-1572-G	3107	16.5	72	15	17.13	75.58



Metro Pricebook
January 2026

Tabletops

tabletops

Executive

<u>1.5" Straight Tabletop w/ Grommet</u>	172
<u>1.5" Straight Tabletop - no grommets</u>	176
<u>1.5" D-Tabletop</u>	180
<u>1.5" O-Tabletop</u>	182

Professional

<u>1" Straight Tabletop w/ Grommet</u>	174
<u>1" Straight Tabletop - no grommets</u>	178
<u>1" D-Tabletop</u>	181
<u>1" O-Tabletop</u>	183

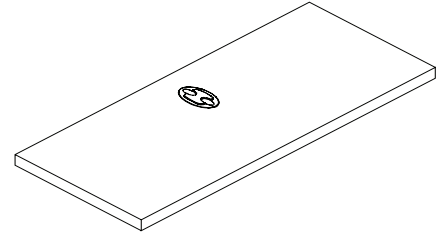

1.5" Straight Tabletop w/ Grommet

How to Specify:

Each laminate comes with matching vinyl trim color unless otherwise specified on your purchase order. Refer to the laminate finish card for details.

Notes:

1 grommet for width 48" or less
2 grommets for width 54" and wider

Options:

laminate color

edge profile

grommet color

Code	Price	H	W	D	Volume (ft ³)	Weight (lb)
UT-WS0G-1818	399	1.5	18	18	0.28	9.96
UT-WS0G-2418	422	1.5	24	18	0.38	14.28
UT-WS0G-3018	450	1.5	30	18	0.47	18.6
UT-WS0G-3618	472	1.5	36	18	0.56	22.92
UT-WS0G-4218	535	1.5	42	18	0.66	27.24
UT-WS0G-4818	565	1.5	48	18	0.75	31.56
UT-WS0G-5418	666	1.5	54	18	0.84	35.88
UT-WS0G-6018	727	1.5	60	18	0.94	40.2
UT-WS0G-6618	832	1.5	66	18	1.03	44.52
UT-WS0G-7218	880	1.5	72	18	1.13	48.84
UT-WS0G-7818	954	1.5	78	18	1.22	53.16
UT-WS0G-8418	1031	1.5	84	18	1.31	57.48
UT-WS0G-9018	1178	1.5	90	18	1.41	61.8
UT-WS0G-9618	1269	1.5	96	18	1.5	66.12
UT-WS0G-1824	434	1.5	18	24	0.38	12.96
UT-WS0G-2424	457	1.5	24	24	0.5	17.28
UT-WS0G-3024	485	1.5	30	24	0.63	21.6
UT-WS0G-3624	499	1.5	36	24	0.75	25.92
UT-WS0G-4224	583	1.5	42	24	0.88	30.24
UT-WS0G-4824	627	1.5	48	24	1	34.56
UT-WS0G-5424	759	1.5	54	24	1.13	38.88

Code	Price	H	W	D	Volume (ft ³)	Weight (lb)
UT-WS0G-6024	794	1.5	60	24	1.25	43.2
UT-WS0G-6624	885	1.5	66	24	1.38	47.52
UT-WS0G-7224	923	1.5	72	24	1.5	51.84
UT-WS0G-7824	1005	1.5	78	24	1.63	56.16
UT-WS0G-8424	1085	1.5	84	24	1.75	60.48
UT-WS0G-9024	1235	1.5	90	24	1.88	64.8
UT-WS0G-9624	1333	1.5	96	24	2	69.12
UT-WS0G-1830	450	1.5	18	30	0.47	16.2
UT-WS0G-2430	485	1.5	24	30	0.63	21.6
UT-WS0G-3030	570	1.5	30	30	0.78	27
UT-WS0G-3630	605	1.5	36	30	0.94	32.4
UT-WS0G-4230	653	1.5	42	30	1.09	37.8
UT-WS0G-4830	706	1.5	48	30	1.25	43.2
UT-WS0G-5430	790	1.5	54	30	1.41	48.6
UT-WS0G-6030	838	1.5	60	30	1.56	54
UT-WS0G-6630	955	1.5	66	30	1.72	59.4
UT-WS0G-7230	979	1.5	72	30	1.88	64.8
UT-WS0G-7830	1066	1.5	78	30	2.03	70.2
UT-WS0G-8430	1151	1.5	84	30	2.19	75.6
UT-WS0G-9030	1309	1.5	90	30	2.34	81
UT-WS0G-9630	1419	1.5	96	30	2.5	86.4
UT-WS0G-1836	472	1.5	18	36	0.56	19.44
UT-WS0G-2436	546	1.5	24	36	0.75	25.92
UT-WS0G-3036	605	1.5	30	36	0.94	32.4
UT-WS0G-3636	627	1.5	36	36	1.13	38.88
UT-WS0G-4236	681	1.5	42	36	1.31	45.36
UT-WS0G-4836	736	1.5	48	36	1.5	51.84
UT-WS0G-5436	821	1.5	54	36	1.69	58.32
UT-WS0G-6036	877	1.5	60	36	1.88	64.8
UT-WS0G-6636	997	1.5	66	36	2.06	71.28
UT-WS0G-7236	1026	1.5	72	36	2.25	77.76
UT-WS0G-7836	1114	1.5	78	36	2.44	84.24
UT-WS0G-8436	1204	1.5	84	36	2.63	90.72
UT-WS0G-9036	1369	1.5	90	36	2.81	97.2
UT-WS0G-9636	1474	1.5	96	36	3	103.68

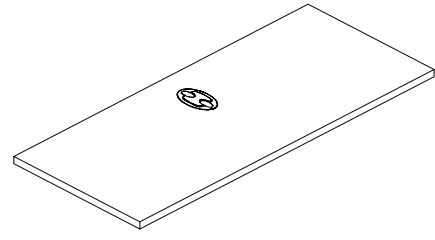

1" Straight Tabletop w/ Grommet

How to Specify:

Each laminate comes with matching vinyl trim color unless otherwise specified on your purchase order. Refer to the laminate finish card for details.

Notes:

1 grommet for width 48" or less
2 grommets for width 54" and wider

Options:

laminate color

grommet color

Code	Price	H	W	D	Volume (ft ³)	Weight (lb)
U-WS0G-1818	298	1	18	18	0.19	6.64
U-WS0G-2418	313	1	24	18	0.25	9.52
U-WS0G-3018	336	1	30	18	0.31	12.4
U-WS0G-3618	348	1	36	18	0.38	15.28
U-WS0G-4218	397	1	42	18	0.44	18.16
U-WS0G-4818	414	1	48	18	0.5	21.04
U-WS0G-5418	496	1	54	18	0.57	23.92
U-WS0G-6018	538	1	60	18	0.63	26.8
U-WS0G-6618	611	1	66	18	0.69	29.68
U-WS0G-7218	652	1	72	18	0.75	32.56
U-WS0G-7818	705	1	78	18	0.82	35.44
U-WS0G-8418	762	1	84	18	0.88	38.32
U-WS0G-9018	865	1	90	18	0.94	41.2
U-WS0G-9618	941	1	96	18	1	44.08
U-WS0G-1824	319	1	18	24	0.25	8.64
U-WS0G-2424	337	1	24	24	0.33	11.52
U-WS0G-3024	360	1	30	24	0.41	14.4
U-WS0G-3624	370	1	36	24	0.5	17.28
U-WS0G-4224	434	1	42	24	0.59	20.16
U-WS0G-4824	465	1	48	24	0.67	23.04
U-WS0G-5424	560	1	54	24	0.75	25.92
U-WS0G-6024	585	1	60	24	0.83	28.8

Code	Price	H	W	D	Volume (ft ³)	Weight (lb)
U-WS0G-6624	655	1	66	24	0.92	31.68
U-WS0G-7224	685	1	72	24	1	34.56
U-WS0G-7824	742	1	78	24	1.09	37.44
U-WS0G-8424	804	1	84	24	1.17	40.32
U-WS0G-9024	911	1	90	24	1.25	43.2
U-WS0G-9624	990	1	96	24	1.33	46.08
U-WS0G-1830	336	1	18	30	0.31	10.8
U-WS0G-2430	360	1	24	30	0.42	14.4
U-WS0G-3030	422	1	30	30	0.52	18
U-WS0G-3630	444	1	36	30	0.63	21.6
U-WS0G-4230	485	1	42	30	0.73	25.2
U-WS0G-4830	523	1	48	30	0.83	28.8
U-WS0G-5430	584	1	54	30	0.94	32.4
U-WS0G-6030	619	1	60	30	1.04	36
U-WS0G-6630	706	1	66	30	1.15	39.6
U-WS0G-7230	726	1	72	30	1.25	43.2
U-WS0G-7830	788	1	78	30	1.36	46.8
U-WS0G-8430	850	1	84	30	1.46	50.4
U-WS0G-9030	969	1	90	30	1.57	54
U-WS0G-9630	1049	1	96	30	1.67	57.6
U-WS0G-1836	348	1	18	36	0.37	12.96
U-WS0G-2436	409	1	24	36	0.5	17.28
U-WS0G-3036	444	1	30	36	0.62	21.6
U-WS0G-3636	465	1	36	36	0.75	25.92
U-WS0G-4236	505	1	42	36	0.88	30.24
U-WS0G-4836	546	1	48	36	1	34.56
U-WS0G-5436	610	1	54	36	1.13	38.88
U-WS0G-6036	647	1	60	36	1.25	43.2
U-WS0G-6636	736	1	66	36	1.38	47.52
U-WS0G-7236	759	1	72	36	1.5	51.84
U-WS0G-7836	821	1	78	36	1.63	56.16
U-WS0G-8436	892	1	84	36	1.75	60.48
U-WS0G-9036	1018	1	90	36	1.88	64.8
U-WS0G-9636	1090	1	96	36	2	69.12

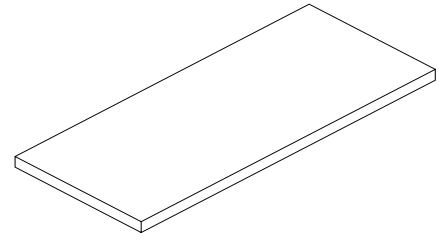

1.5" Straight Tabletop

How to Specify:

Each laminate comes with matching vinyl trim color unless otherwise specified on your purchase order. Refer to the laminate finish card for details.

Notes:

Options:

laminate color

edge profile

Code	Price	H	W	D	Volume (ft ³)	Weight (lb)
UT-WS0N-1818	363	1.5	18	18	0.28	9.96
UT-WS0N-2418	383	1.5	24	18	0.38	14.28
UT-WS0N-3018	413	1.5	30	18	0.47	18.6
UT-WS0N-3618	435	1.5	36	18	0.56	22.92
UT-WS0N-4218	499	1.5	42	18	0.66	27.24
UT-WS0N-4818	525	1.5	48	18	0.75	31.56
UT-WS0N-5418	639	1.5	54	18	0.84	35.88
UT-WS0N-6018	694	1.5	60	18	0.94	40.2
UT-WS0N-6618	790	1.5	66	18	1.03	44.52
UT-WS0N-7218	840	1.5	72	18	1.13	48.84
UT-WS0N-7818	911	1.5	78	18	1.22	53.16
UT-WS0N-8418	993	1.5	84	18	1.31	57.48
UT-WS0N-9018	1140	1.5	90	18	1.41	61.8
UT-WS0N-9618	1230	1.5	96	18	1.5	66.12
UT-WS0N-1824	398	1.5	18	24	0.38	12.96
UT-WS0N-2424	416	1.5	24	24	0.5	17.28
UT-WS0N-3024	444	1.5	30	24	0.63	21.6
UT-WS0N-3624	463	1.5	36	24	0.75	25.92
UT-WS0N-4224	546	1.5	42	24	0.88	30.24
UT-WS0N-4824	594	1.5	48	24	1	34.56
UT-WS0N-5424	719	1.5	54	24	1.13	38.88
UT-WS0N-6024	760	1.5	60	24	1.25	43.2

Code	Price	H	W	D	Volume (ft ³)	Weight (lb)
UT-WS0N-6624	845	1.5	66	24	1.38	47.52
UT-WS0N-7224	887	1.5	72	24	1.5	51.84
UT-WS0N-7824	967	1.5	78	24	1.63	56.16
UT-WS0N-8424	1049	1.5	84	24	1.75	60.48
UT-WS0N-9024	1199	1.5	90	24	1.88	64.8
UT-WS0N-9624	1301	1.5	96	24	2	69.12
UT-WS0N-1830	411	1.5	18	30	0.47	16.2
UT-WS0N-2430	444	1.5	24	30	0.63	21.6
UT-WS0N-3030	535	1.5	30	30	0.78	27
UT-WS0N-3630	570	1.5	36	30	0.94	32.4
UT-WS0N-4230	615	1.5	42	30	1.09	37.8
UT-WS0N-4830	666	1.5	48	30	1.25	43.2
UT-WS0N-5430	759	1.5	54	30	1.41	48.6
UT-WS0N-6030	801	1.5	60	30	1.56	54
UT-WS0N-6630	915	1.5	66	30	1.72	59.4
UT-WS0N-7230	946	1.5	72	30	1.88	64.8
UT-WS0N-7830	1031	1.5	78	30	2.03	70.2
UT-WS0N-8430	1119	1.5	84	30	2.19	75.6
UT-WS0N-9030	1272	1.5	90	30	2.34	81
UT-WS0N-9630	1377	1.5	96	30	2.5	86.4
UT-WS0N-1836	434	1.5	18	36	0.56	19.44
UT-WS0N-2436	507	1.5	24	36	0.75	25.92
UT-WS0N-3036	570	1.5	30	36	0.94	32.4
UT-WS0N-3636	592	1.5	36	36	1.13	38.88
UT-WS0N-4236	646	1.5	42	36	1.31	45.36
UT-WS0N-4836	699	1.5	48	36	1.5	51.84
UT-WS0N-5436	790	1.5	54	36	1.69	58.32
UT-WS0N-6036	837	1.5	60	36	1.88	64.8
UT-WS0N-6636	960	1.5	66	36	2.06	71.28
UT-WS0N-7236	992	1.5	72	36	2.25	77.76
UT-WS0N-7836	1078	1.5	78	36	2.44	84.24
UT-WS0N-8436	1168	1.5	84	36	2.63	90.72
UT-WS0N-9036	1331	1.5	90	36	2.81	97.2
UT-WS0N-9636	1436	1.5	96	36	3	103.68

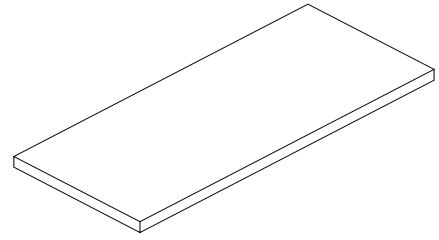

1" Straight Tabletop

How to Specify:

Each laminate comes with matching vinyl trim color unless otherwise specified on your purchase order. Refer to the laminate finish card for details.

Notes:

Options:

laminate color

Code	Price	H	W	D	Volume (ft ³)	Weight (lb)
U-WS0N-1818	270	1	18	18	0.19	6.64
U-WS0N-2418	282	1	24	18	0.25	9.52
U-WS0N-3018	308	1	30	18	0.31	12.4
U-WS0N-3618	320	1	36	18	0.38	15.28
U-WS0N-4218	370	1	42	18	0.44	18.16
U-WS0N-4818	387	1	48	18	0.5	21.04
U-WS0N-5418	470	1	54	18	0.57	23.92
U-WS0N-6018	513	1	60	18	0.63	26.8
U-WS0N-6618	584	1	66	18	0.69	29.68
U-WS0N-7218	622	1	72	18	0.75	32.56
U-WS0N-7818	680	1	78	18	0.82	35.44
U-WS0N-8418	734	1	84	18	0.88	38.32
U-WS0N-9018	844	1	90	18	0.94	41.2
U-WS0N-9618	910	1	96	18	1	44.08
U-WS0N-1824	295	1	18	24	0.25	8.64
U-WS0N-2424	310	1	24	24	0.33	11.52
U-WS0N-3024	335	1	30	24	0.41	14.4
U-WS0N-3624	340	1	36	24	0.5	17.28
U-WS0N-4224	409	1	42	24	0.59	20.16
U-WS0N-4824	438	1	48	24	0.67	23.04
U-WS0N-5424	535	1	54	24	0.75	25.92
U-WS0N-6024	565	1	60	24	0.83	28.8
U-WS0N-6624	625	1	66	24	0.92	31.68
U-WS0N-7224	656	1	72	24	1	34.56
U-WS0N-7824	718	1	78	24	1.09	37.44

Code	Price	H	W	D	Volume (ft ³)	Weight (lb)
U-WS0N-8424	778	1	84	24	1.17	40.32
U-WS0N-9024	891	1	90	24	1.25	43.2
U-WS0N-9624	964	1	96	24	1.33	46.08
U-WS0N-6624	625	1	66	24	0.92	31.68
U-WS0N-7224	656	1	72	24	1	34.56
U-WS0N-7824	718	1	78	24	1.09	37.44
U-WS0N-8424	778	1	84	24	1.17	40.32
U-WS0N-9024	891	1	90	24	1.25	43.2
U-WS0N-9624	964	1	96	24	1.33	46.08
U-WS0N-1830	307	1	18	30	0.31	10.8
U-WS0N-2430	335	1	24	30	0.42	14.4
U-WS0N-3030	397	1	30	30	0.52	18
U-WS0N-3630	422	1	36	30	0.63	21.6
U-WS0N-4230	459	1	42	30	0.73	25.2
U-WS0N-4830	496	1	48	30	0.83	28.8
U-WS0N-5430	560	1	54	30	0.94	32.4
U-WS0N-6030	592	1	60	30	1.04	36
U-WS0N-6630	681	1	66	30	1.15	39.6
U-WS0N-7230	700	1	72	30	1.25	43.2
U-WS0N-7830	762	1	78	30	1.36	46.8
U-WS0N-8430	827	1	84	30	1.46	50.4
U-WS0N-9030	946	1	90	30	1.57	54
U-WS0N-9630	1024	1	96	30	1.68	57.6
U-WS0N-1836	324	1	18	36	0.37	12.96
U-WS0N-2436	383	1	24	36	0.5	17.28
U-WS0N-3036	422	1	30	36	0.62	21.6
U-WS0N-3636	439	1	36	36	0.75	25.92
U-WS0N-4236	477	1	42	36	0.88	30.24
U-WS0N-4836	521	1	48	36	1	34.56
U-WS0N-5436	584	1	54	36	1.13	38.88
U-WS0N-6036	623	1	60	36	1.25	43.2
U-WS0N-6636	713	1	66	36	1.38	47.52
U-WS0N-7236	731	1	72	36	1.5	51.84
U-WS0N-7836	794	1	78	36	1.63	56.16
U-WS0N-8436	864	1	84	36	1.75	60.48
U-WS0N-9036	990	1	90	36	1.88	64.8
U-WS0N-9636	1066	1	96	36	2	69.12

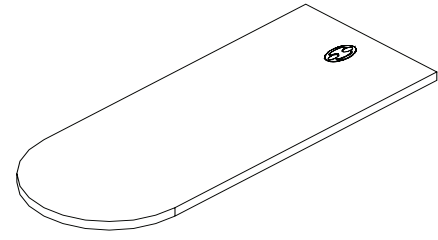

How to Specify:

Each laminate comes with matching vinyl trim color unless otherwise specified on your purchase order. Refer to the laminate finish card for details.

Options:

laminate color

edge profile

grommet color

Code	Price	H	W	D	Volume (ft ³)	Weight (lb)
UT-WDTG-6024	990	1.5	60	24	1.25	41.18
UT-WDTG-6624	1163	1.5	66	24	1.38	45.35
UT-WDTG-7224	1254	1.5	72	24	1.5	49.51
UT-WDTG-7824	1444	1.5	78	24	1.63	53.67
UT-WDTG-8424	1513	1.5	84	24	1.75	57.83
UT-WDTG-6030	1092	1.5	60	30	1.56	47.45
UT-WDTG-6630	1285	1.5	66	30	1.72	52.31
UT-WDTG-7230	1385	1.5	72	30	1.88	57.17
UT-WDTG-7830	1601	1.5	78	30	2.03	62.03
UT-WDTG-8430	1678	1.5	84	30	2.19	66.89
UT-WDTG-6036	1204	1.5	60	36	1.88	58.61
UT-WDTG-6636	1410	1.5	66	36	2.06	64.16
UT-WDTG-7236	1516	1.5	72	36	2.25	69.71
UT-WDTG-7836	1749	1.5	78	36	2.44	75.26
UT-WDTG-8436	1842	1.5	84	36	2.63	80.81

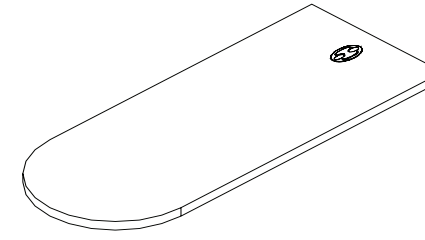

How to Specify:

Each laminate comes with matching vinyl trim color unless otherwise specified on your purchase order. Refer to the laminate finish card for details.

Options:

laminate color

grommet color

Code	Price	H	W	D	Volume (ft ³)	Weight (lb)
U-WDTG-6024	821	1	60	24	0.83	27.46
U-WDTG-6624	967	1	66	24	0.92	30.23
U-WDTG-7224	1004	1	72	24	1	33.01
U-WDTG-7824	1207	1	78	24	1.09	35.78
U-WDTG-8424	1265	1	84	24	1.17	38.56
U-WDTG-6030	910	1	60	30	1.04	31.64
U-WDTG-6630	1071	1	66	30	1.15	34.88
U-WDTG-7230	1154	1	72	30	1.25	38.11
U-WDTG-7830	1331	1	78	30	1.36	41.35
U-WDTG-8430	1396	1	84	30	1.46	44.59
U-WDTG-6036	998	1	60	36	1.25	39.07
U-WDTG-6636	1182	1	66	36	1.38	42.77
U-WDTG-7236	1269	1	72	36	1.5	46.47
U-WDTG-7836	1458	1	78	36	1.63	50.17
U-WDTG-8436	1537	1	84	36	1.75	53.87

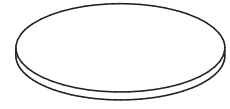

How to Specify:

Each laminate comes with matching vinyl trim color unless otherwise specified on your purchase order. Refer to the laminate finish card for details.

Options:

laminate color

edge profile (for o-tabletop)

Code	Price	H	W	D	Volume (ft ³)	Weight (lb)
T-WOXX-24	540	1.5	24	24	0.5	32.4
T-WOXX-30	540	1.5	30	30	0.78	40.5
T-WOXX-36	540	1.5	36	36	1.13	39.76
T-WOXX-42	691	1.5	42	42	1.53	54.11
T-WOXX-48	780	1.5	48	48	2	70.68
T-WOXX-54	877	1.5	54	54	2.53	72.9
T-WOXX-60	969	1.5	60	60	3.13	81

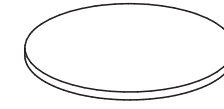

How to Specify:

Each laminate comes with matching vinyl trim color unless otherwise specified on your purchase order. Refer to the laminate finish card for details.

laminate color

Code	Price	H	W	D	Volume (ft ³)	Weight (lb)
TL-WOXX-24	432	1	24	24	1.2	32.4
TL-WOXX-30	465	1	30	30	1.5	40.5
TL-WOXX-36	511	1	36	36	4.63	26.5
TL-WOXX-42	653	1	42	42	6.12	36.07
TL-WOXX-48	731	1	48	48	7.82	47.12
TL-WOXX-54	821	1	54	54	2.7	72.9
TL-WOXX-60	904	1	60	60	3	81



Metro Pricebook
January 2026

Bases

bases

<u>cross base</u>	186
<u>post support base</u>	187
<u>open metal gable</u>	188

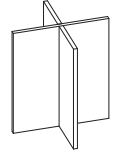

Cross base

Notes:

4 post supports required for each o-tabletop.

Options:

laminat color

Code	Price	H	W	D	Volume (ft ³)	Weight (lb)
T-B6-30	499	28	18	18	7.63	24.99
T-B6-36	499	28	24	24	14.52	33.64
T-B6-42	517	28	30	30	21.41	42.29
T-B6-48	552	28	36	36	29.63	49.23
T-B6-54	567	28	42	42	37.85	56.17
T-B6-60	598	28	48	48	46.07	63.11



Post Support Base

Notes:

4 post supports required for each o-tabletop.

Options:

metal color (for post support)

Code	Price	H	W	D	Volume (ft ³)	Weight (lb)
TB-BASE-1	434	28	3	3	0.85	7

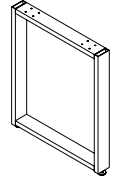

Open Metal Gable

Options:

metal color (for gables)

Code	Price	H	W	D	Volume (ft ³)	Weight (lb)
U-CG0M-12	450	28	12	0.3	0.58	6
U-CG0M-18	511	28	18	0.4	0.88	10
U-CG0M-21	540	28	21	0.45	1.02	12
U-CG0M-24	571	28	24	0.5	1.17	14
U-CG0M-30	634	28	30	0.6	1.46	18
U-CG0M-36	694	28	36	0.7	1.75	22
U-CG0M-1813	326	13	18	0.4		5
U-CG0M-2413	403	13	24	0.4		7
U-CG0M-3013	411	13	30	0.4		9
U-CG0M-3613	456	13	36	0.4		11



Metro Pricebook
January 2026
Reception Unit

reception unit

executive 192

professional 193

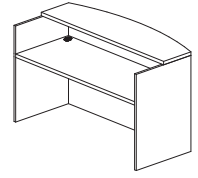

1.5" Reception Unit w/Countertop

How to Specify:

Each laminate comes with matching vinyl trim color unless otherwise specified on your purchase order. Refer to the laminate finish card for details.

Options:

laminate color

edge profile

grommet color

Code	Price	H	W	D	Volume (ft ³)	Weight (lb)
T-RC0G-7230	2548	43.5	72	30	54.38	272.25

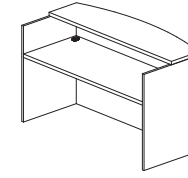

1" Reception Unit w/Countertop

How to Specify:

Each laminate comes with matching vinyl trim color unless otherwise specified on your purchase order. Refer to the laminate finish card for details.

Options:

laminate color

grommet color

Code	Price	H	W	D	Volume (ft ³)	Weight (lb)
TL-RC0G-7230	2275	43	72	30	53.75	228.15



Metro Pricebook
January 2026

Service Write Up Desk

service write up desk

Executive

w/ Straight Front Countertop 196

w/ Arc Countertop 198

Professional

w/ Straight Front Countertop 197

w/ Arc Countertop 199

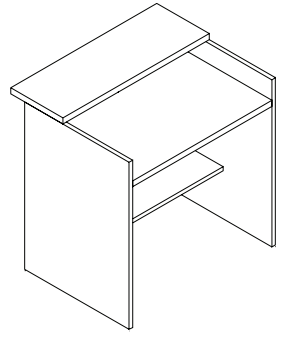

1.5" Service Write Up Desk w/ Straight Countertop

How to Specify:

Each laminate comes with matching vinyl trim color unless otherwise specified on your purchase order. Refer to the laminate finish card for details.

Options:

laminate color

edge profile

Code	Price	H	W	D	Volume (ft ³)	Weight (lb)
T-RCWG-3030-S	1983	43	30	30	25.46	94
T-RCWG-3630-S	2087	43	36	30	30.55	97
T-RCWG-4230-S	2207	43	42	30	35.64	100
T-RCWG-4830-S	2322	43	48	30	40.73	103
T-RCWG-5430-S	2412	43	54	30	45.82	106
T-RCWG-6030-S	2507	43	60	30	50.91	109
T-RCWG-6630-S	2597	43	66	30	56	112
T-RCWG-7230-S	2730	43	72	30	61.09	115
T-RCWG-7830-S	2854	43	78	30	66.18	118
T-RCWG-8430-S	2971	43	84	30	71.28	121

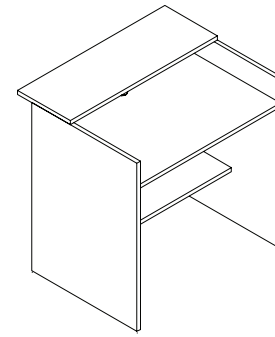

1" Service Write Up Desk w/ Straight Countertop

How to Specify:

Each laminate comes with matching vinyl trim color unless otherwise specified on your purchase order. Refer to the laminate finish card for details.

Options:

laminate color

Code	Price	H	W	D	Volume (ft ³)	Weight (lb)
TL-RCWG-3030-S	1851	43	30	30	22.4	88
TL-RCWG-3630-S	1983	43	36	30	26.88	91
TL-RCWG-4230-S	2075	43	42	30	31.35	94
TL-RCWG-4830-S	2167	43	48	30	35.83	97
TL-RCWG-5430-S	2261	43	54	30	40.31	100
TL-RCWG-6030-S	2352	43	60	30	44.79	103
TL-RCWG-6630-S	2446	43	66	30	49.27	106
TL-RCWG-7230-S	2576	43	72	30	53.75	109
TL-RCWG-7830-S	2745	43	78	30	58.23	112
TL-RCWG-8430-S	2839	43	84	30	62.71	115

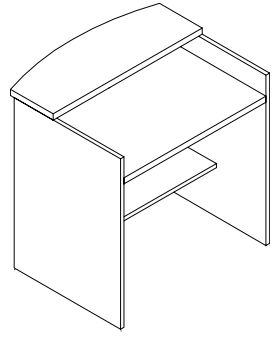

1.5" Service Write Up Desk w/ Arc Countertop

How to Specify:

Each laminate comes with matching vinyl trim color unless otherwise specified on your purchase order. Refer to the laminate finish card for details.

Options:

laminate color

edge profile

Code	Price	H	W	D	Volume (ft ³)	Weight (lb)
T-RCWG-3030-A	2219	43	30	30	25.46	94
T-RCWG-3630-A	2289	43	36	30	30.55	97
T-RCWG-4230-A	2394	43	42	30	35.64	100
T-RCWG-4830-A	2508	43	48	30	40.73	103
T-RCWG-5430-A	2540	43	54	30	45.82	106
T-RCWG-6030-A	2777	43	60	30	50.91	109
T-RCWG-6630-A	2869	43	66	30	56	112
T-RCWG-7230-A	2979	43	72	30	61.09	115
T-RCWG-7830-A	3148	43	78	30	66.18	118
T-RCWG-8430-A	3267	43	84	30	71.28	121

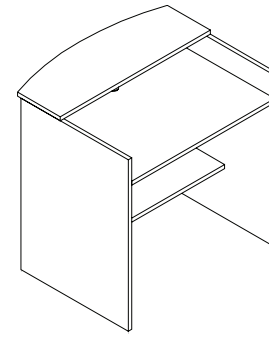

1" Service Write Up Desk w/ Arc Countertop

How to Specify:

Each laminate comes with matching vinyl trim color unless otherwise specified on your purchase order. Refer to the laminate finish card for details.

Options:

laminate color

Code	Price	H	W	D	Volume (ft ³)	Weight (lb)
TL-RCWG-3030-A	1993	43	30	30	22.4	88
TL-RCWG-3630-A	2084	43	36	30	26.88	91
TL-RCWG-4230-A	2176	43	42	30	31.35	94
TL-RCWG-4830-A	2268	43	48	30	35.83	97
TL-RCWG-5430-A	2361	43	54	30	40.31	100
TL-RCWG-6030-A	2473	43	60	30	44.79	103
TL-RCWG-6630-A	2547	43	66	30	49.27	106
TL-RCWG-7230-A	2678	43	72	30	53.75	109
TL-RCWG-7830-A	2839	43	78	30	58.23	112
TL-RCWG-8430-A	2979	43	84	30	62.71	115



Metro Pricebook
January 2026
Coffee & End Tables

coffee and end tables

Executive

coffee and end table 202

Professional

coffee and end table 203

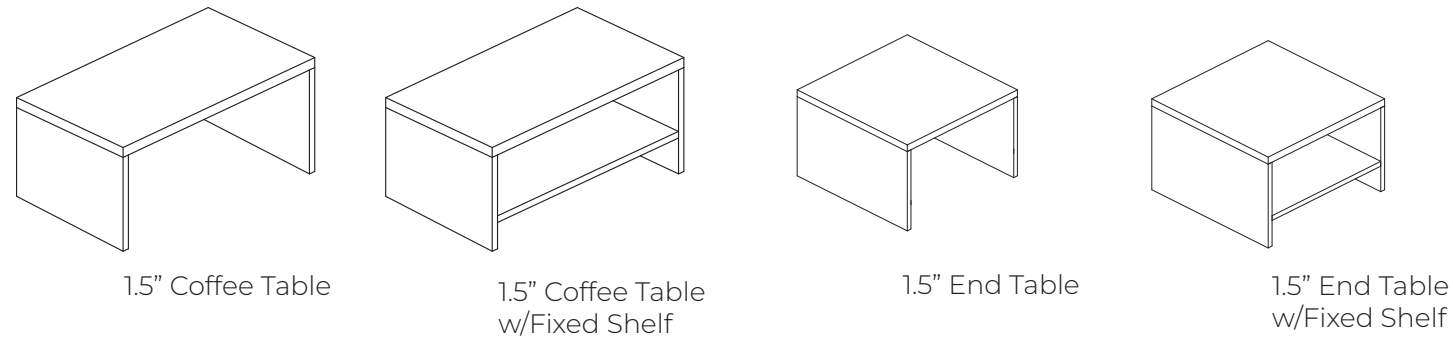

How to Specify:

Each laminate comes with matching vinyl trim color unless otherwise specified on your purchase order. Refer to the laminate finish card for details.

Options:

laminate color

edge profile

Code	Price	H	W	D	Volume (ft ³)	Weight (lb)
Coffee Table						
T-TCT0-362017	535	17.5	36	20	7.29	48.6
T-TCT0-422017	571	17.5	42	20	8.51	53.93
T-TCT0-482017	616	17.5	48	20	9.72	59.26
Coffee Table w/Fixed Shelf						
T-TCTS-362017	655	17.5	36	20	7.29	66.3
T-TCTS-422017	691	17.5	42	20	8.51	74.25
T-TCTS-482017	739	17.5	48	20	9.72	82.2
End Table						
T-TCT0-202019	499	19.5	20	20	4.51	35.7
T-TCT0-242419	560	19.5	24	24	6.5	47.03
T-TCT0-303019	691	19.5	30	30	10.16	58.36
End Table w/Fixed Shelf						
T-TCTS-202019	616	19.5	20	20	4.51	51.36
T-TCTS-242419	681	19.5	24	24	6.5	62.87
T-TCTS-303019	813	19.5	30	30	10.16	78.65

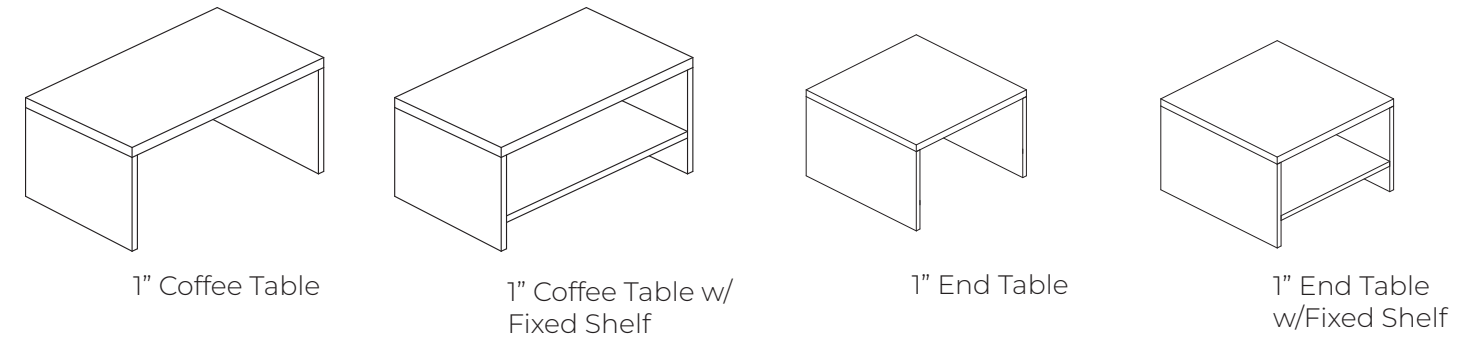

How to Specify:

Each laminate comes with matching vinyl trim color unless otherwise specified on your purchase order. Refer to the laminate finish card for details.

Options:

laminate color

Code	Price	H	W	D	Volume (ft ³)	Weight (lb)
Coffee Table						
TL-TCT0-362017	480	17	36	20	7.08	39.45
TL-TCT0-422017	516	17	42	20	8.26	43.02
TL-TCT0-482017	566	17	48	20	9.44	46.59
Coffee Table w/Fixed Shelf						
TL-TCTS-362017	602	17	36	20	7.08	56.7
TL-TCTS-362017	602	17	36	20	7.08	56.7
TL-TCTS-362017	602	17	36	20	7.08	56.7
End Table						
TL-TCT0-202019	440	19	20	20	4.4	30.66
TL-TCT0-242419	506	19	24	24	6.33	39.3
TL-TCT0-303019	640	19	30	30	9.9	47.94
End Table w/Fixed Shelf						
TL-TCTS-202019	566	19	20	20	4.4	40.03
TL-TCTS-242419	625	19	24	24	6.33	53.05
TL-TCTS-303019	759	19	30	30	9.9	69.81



Metro Pricebook
January 2026
Conference

conference

table top	208
straight tabletop	208
straight tabletop w/power and data	210
boat-shaped tabletop	212
boat-shaped tabletop w/power and data	214
racetrack tabletop	216
racetrack tabletop w/power and data	218
tapered tabletop	220
tapered tabletop w/ power and data	221
table base	222
gable & modesty base	222
elliptical base	226
table base configuration	230
options	231
Ellora Grommet add-ons	231
filing and storage	232
serving cabinet	232
storage cabinet w/shelves	233
combo cabinet w/storage & lateral files	234
double door cabinet w/shelves	235
combo cabinet	236
storage cabinet w/coat bar and shelves	237
presentation tools	238
whiteboard cabinet	238
computer desk	239

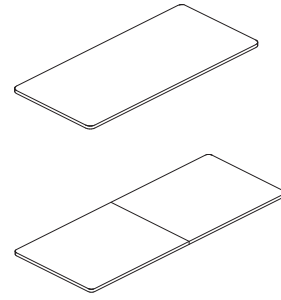

1.5" Straight Tabletop

How to Specify:

Each laminate comes with matching vinyl trim color unless otherwise specified on your purchase order. Refer to the laminate finish card for details.

Notes:

Tabletops 72"-96"W are configured in one-piece top.

Tabletops 108"-192"W are configured in two-piece tops.

Tabletops 204"-240"W are configured in three-piece tops.

Options:

laminate color

edge profile

Code	Price	H	W	D	Volume (ft ³)	Weight (lb)
TB-MSSX-7236	901	1.5	72	36	2.25	89.91
TB-MSSX-7242	1128	1.5	72	42	2.62	104.92
TB-MSSX-8436	1036	1.5	84	36	2.62	104.92
TB-MSSX-8442	1225	1.5	84	42	3.06	122.43
TB-MSSX-8448	1306	1.5	84	48	3.5	139.93
TB-MSSX-9636	1130	1.5	96	36	3	119.93
TB-MSSX-9642	1325	1.5	96	42	3.5	139.93
TB-MSSX-9648	1370	1.5	96	48	4	159.94
TB-MSSX-10848	1642	1.5	108	48	4.49	179.76
TB-MSSX-10854	1941	1.5	108	54	5.05	202.27
TB-MSSX-10860	1974	1.5	108	60	5.62	224.78
TB-MSSX-12048	1794	1.5	120	48	4.99	199.77
TB-MSSX-12054	2120	1.5	120	54	5.62	224.78
TB-MSSX-12060	2153	1.5	120	60	6.24	249.79
TB-MSSX-13248	1943	1.5	132	48	5.49	219.78
TB-MSSX-13254	2301	1.5	132	54	6.18	247.29

Code	Price	H	W	D	Volume (ft ³)	Weight (lb)
TB-MSSX-13260	2335	1.5	132	60	6.87	274.8
TB-MSSX-14448	2095	1.5	144	48	5.99	239.78
TB-MSSX-14454	2483	1.5	144	54	6.74	269.8
TB-MSSX-14460	2517	1.5	144	60	7.49	299.81
TB-MSSX-15648	2250	1.5	156	48	6.49	259.69
TB-MSSX-15654	2667	1.5	156	54	7.3	292.3
TB-MSSX-15660	2699	1.5	156	60	8.12	324.82
TB-MSSX-16848	2633	1.5	168	48	6.99	279.8
TB-MSSX-16854	2845	1.5	168	54	7.87	314.81
TB-MSSX-16860	2879	1.5	168	60	8.74	349.83
TB-MSSX-18048	2672	1.5	180	48	7.49	299.81
TB-MSSX-18054	3027	1.5	180	54	8.43	337.32
TB-MSSX-18060	3063	1.5	180	60	9.37	374.84
TB-MSSX-19248	2701	1.5	192	48	7.99	319.82
TB-MSSX-19254	3211	1.5	192	54	8.99	359.83
TB-MSSX-19260	3242	1.5	192	60	9.99	399.85
TB-MSSX-20448	2996	1.5	204	48	8.49	339.63
TB-MSSX-20454	3549	1.5	204	54	9.55	382.15
TB-MSSX-20460	3598	1.5	204	60	10.61	424.67
TB-MSSX-21648	3146	1.5	216	48	8.99	359.64
TB-MSSX-21654	3729	1.5	216	54	10.11	404.66
TB-MSSX-21660	3780	1.5	216	60	11.24	449.68
TB-MSSX-22848	3298	1.5	228	48	9.49	379.65
TB-MSSX-22854	3912	1.5	228	54	10.67	427.17
TB-MSSX-22860	3960	1.5	228	60	11.86	474.69
TB-MSSX-24048	3687	1.5	240	48	9.99	399.66
TB-MSSX-24054	4092	1.5	240	54	11.24	449.68
TB-MSSX-24060	4143	1.5	240	60	12.49	499.7
TB-MSSX-22860	3960	1.5	228	60	11.86	474.69
TB-MSSX-24048	3687	1.5	240	48	9.99	399.66
TB-MSSX-24054	4092	1.5	240	54	11.24	449.68
TB-MSSX-24060	4143	1.5	240	60	12.49	499.7

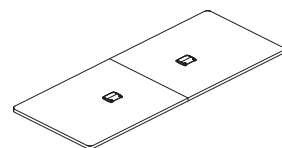

1.5" Straight Tabletop w/Power and Data

How to Specify:

Each laminate comes with matching vinyl trim color unless otherwise specified on your purchase order. Refer to the laminate finish card for details.

Notes:

Tabletops 72"-96"W are configured in one-piece top.
 Tabletops 108"-192"W are configured in two-piece tops.
 Tabletops 204"-240"W are configured in three-piece tops.
 Single-piece tabletops are equipped with one power and data grommet, two-piece tabletops are equipped with two power and data grommets, and three-piece tabletops are equipped with three power and data grommets.
 Two power and dual USB-A receptacles with 3 open slots to accommodate RJ11, RJ45, HDMI, VGA or Stereo. Items for 3 open slots must be specified and purchased separately.

Boardroom tables with tops comprised of 2 or more pieces will not have a consistent grain pattern.

Options:

laminate color

edge profile

grommet color (for tabletops with power and data)

Code	Price	H	W	D	Volume (ft ³)	Weight (lb)
TB-MSSP-7236	2144	1.5	72	36	2.2	87.99
TB-MSSP-7242	2372	1.5	72	42	2.57	102.99
TB-MSSP-8436	2280	1.5	84	36	2.57	102.99
TB-MSSP-8442	2470	1.5	84	42	3.01	120.5
TB-MSSP-8448	2552	1.5	84	48	3.45	138.01
TB-MSSP-9636	2376	1.5	96	36	2.95	118
TB-MSSP-9642	2571	1.5	96	42	3.45	138.01
TB-MSSP-9648	2615	1.5	96	48	3.95	158.01
TB-MSSP-10848	4129	1.5	108	48	4.43	178.17
TB-MSSP-10854	4430	1.5	108	54	4.49	200.68
TB-MSSP-10860	4464	1.5	108	60	5.56	223.19
TB-MSSP-12048	4279	1.5	120	48	4.93	198.18
TB-MSSP-12054	4610	1.5	120	54	5.56	223.19
TB-MSSP-12060	4640	1.5	120	60	6.18	248.2
TB-MSSP-13248	4431	1.5	132	48	5.43	218.19

Code	Price	H	W	D	Volume (ft ³)	Weight (lb)
TB-MSSP-13254	4789	1.5	132	54	6.12	245.7
TB-MSSP-13260	4820	1.5	132	60	6.81	273.21
TB-MSSP-14448	4583	1.5	144	48	5.93	238.19
TB-MSSP-14454	4970	1.5	144	54	6.68	268.21
TB-MSSP-14460	5005	1.5	144	60	7.43	298.22
TB-MSSP-15648	4735	1.5	156	48	6.43	258.2
TB-MSSP-15654	5152	1.5	156	54	7.24	290.72
TB-MSSP-15660	5187	1.5	156	60	8.06	323.23
TB-MSSP-16848	5124	1.5	168	48	6.93	278.21
TB-MSSP-16854	5333	1.5	168	54	7.81	313.22
TB-MSSP-16860	5367	1.5	168	60	8.68	348.24
TB-MSSP-18048	5156	1.5	180	48	7.43	298.22
TB-MSSP-18054	5513	1.5	180	54	8.37	335.73
TB-MSSP-18060	5548	1.5	180	60	9.31	373.25
TB-MSSP-19248	5191	1.5	192	48	7.93	318.23
TB-MSSP-19254	5696	1.5	192	54	8.93	358.24
TB-MSSP-19260	5728	1.5	192	60	9.93	398.26
TB-MSSP-20448	6725	1.5	204	48	8.4	337.25
TB-MSSP-20454	7281	1.5	204	54	9.46	379.77
TB-MSSP-20460	7330	1.5	204	60	10.52	422.28
TB-MSSP-21648	6878	1.5	216	48	8.9	357.26
TB-MSSP-21654	7462	1.5	216	54	10.02	402.28
TB-MSSP-21660	7509	1.5	216	60	11.15	447.29
TB-MSSP-22848	7027	1.5	228	48	9.4	377.27
TB-MSSP-22854	7642	1.5	228	54	10.58	424.79
TB-MSSP-22860	7690	1.5	228	60	11.77	472.3
TB-MSSP-24048	7419	1.5	240	48	9.9	397.27
TB-MSSP-24054	7824	1.5	240	54	11.15	447.29
TB-MSSP-24060	7872	1.5	240	60	12.4	497.31



1.5" Boat-Shaped Tabletop

How to Specify:

Each laminate comes with matching vinyl trim color unless otherwise specified on your purchase order. Refer to the laminate finish card for details.

Notes:

Tabletops 72"-96"W are configured in one-piece top.

Tabletops 108"-192"W are configured in two-piece tops.

Tabletops 204"-240"W are configured in three-piece tops.

Options:

laminate color

edge profile

Code	Price	H	W	D	Volume (ft ³)	Weight (lb)
TB-MBBX-7236	901	1.5	72	36	2	80.81
TB-MBBX-7242	1128	1.5	72	42	2.38	95.09
TB-MBBX-8436	1036	1.5	84	36	2.33	93.4
TB-MBBX-8442	1225	1.5	84	42	2.77	110.91
TB-MBBX-8448	1306	1.5	84	48	3.21	128.42
TB-MBBX-9636	1130	1.5	96	36	2.67	106.72
TB-MBBX-9642	1325	1.5	96	42	3.17	126.73
TB-MBBX-9648	1370	1.5	96	48	3.67	146.74
TB-MBBX-10848	1642	1.5	108	48	4.12	164.78
TB-MBBX-10854	1941	1.5	108	54	4.68	187.3
TB-MBBX-10860	1974	1.5	108	60	5.24	209.8
TB-MBBX-12048	1794	1.5	120	48	4.58	183.12
TB-MBBX-12054	2120	1.5	120	54	5.2	208.12
TB-MBBX-12060	2153	1.5	120	60	5.82	233.14
TB-MBBX-13248	1943	1.5	132	48	5.04	201.44
TB-MBBX-13254	2301	1.5	132	54	5.72	228.96

Code	Price	H	W	D	Volume (ft ³)	Weight (lb)
TB-MBBX-13260	2335	1.5	132	60	6.4	256.46
TB-MBBX-14448	2095	1.5	144	48	5.5	219.78
TB-MBBX-14454	2483	1.5	144	54	6.24	249.8
TB-MBBX-14460	2517	1.5	144	60	7	279.8
TB-MBBX-15648	2250	1.5	156	48	5.96	238.12
TB-MBBX-15654	2667	1.5	156	54	6.76	270.62
TB-MBBX-15660	2699	1.5	156	60	7.58	303.14
TB-MBBX-16848	2633	1.5	168	48	6.4	256.44
TB-MBBX-16854	2845	1.5	168	54	7.28	291.48
TB-MBBX-16860	2879	1.5	168	60	8.16	326.48
TB-MBBX-18048	2672	1.5	180	48	6.86	274.78
TB-MBBX-18054	3027	1.5	180	54	7.8	313.8
TB-MBBX-18060	3063	1.5	180	60	8.74	349.82
TB-MBBX-19248	2701	1.5	192	48	7.32	293.12
TB-MBBX-19254	3211	1.5	192	54	8.32	333.14
TB-MBBX-19260	3242	1.5	192	60	9.32	373.16
TB-MBBX-20448	2996	1.5	204	48	7.78	344.36
TB-MBBX-20454	3549	1.5	204	54	8.84	353.87
TB-MBBX-20460	3598	1.5	204	60	9.9	396.39
TB-MBBX-21648	3146	1.5	216	48	8.24	329.69
TB-MBBX-21654	3729	1.5	216	54	9.36	374.71
TB-MBBX-21660	3780	1.5	216	60	10.49	419.73
TB-MBBX-22848	3298	1.5	228	48	8.7	348.03
TB-MBBX-22854	3912	1.5	228	54	9.88	395.55
TB-MBBX-22860	3960	1.5	228	60	11.07	443.07
TB-MBBX-24048	3687	1.5	240	48	9.15	366.37
TB-MBBX-24054	4092	1.5	240	54	6.1	416.39
TB-MBBX-24060	4143	1.5	240	60	11.65	466.41



1.5" Boat-Shaped Tabletop w/Power and Data

How to Specify:

Each laminate comes with matching vinyl trim color unless otherwise specified on your purchase order. Refer to the laminate finish card for details.

Notes:

Tabletops 72"-96"W are configured in one-piece top.

Tabletops 108"-192"W are configured in two-piece tops.

Tabletops 204"-240"W are configured in three-piece tops.

Single-piece tabletops are equipped with one power and data grommet, two-piece tabletops are equipped with two power and data grommets, and three-piece tabletops are equipped with three power and data grommets.

Two power and dual USB-A receptacles with 3 open slots to accommodate RJ11, RJ45, HDMI, VGA or Stereo. Items for 3 open slots must be specified and purchased separately.

Boardroom tables with tops comprised of 2 or more pieces will not have a consistent grain pattern.

Options:

laminate color

edge profile

grommet color (for tabletops with power and data)

Code	Price	H	W	D	Volume (ft ³)	Weight (lb)
TB-MBBP-7236	2144	1.5	72	36	1.95	78.15
TB-MBBP-7242	2372	1.5	72	42	2.33	93.16
TB-MBBP-8436	2280	1.5	84	36	2.29	91.47
TB-MBBP-8442	2470	1.5	84	42	2.72	108.98
TB-MBBP-8448	2552	1.5	84	48	3.16	126.49
TB-MBBP-9636	2376	1.5	96	36	2.62	104.8
TB-MBBP-9642	2571	1.5	96	42	3.12	124.8
TB-MBBP-9648	2615	1.5	96	48	3.62	144.81
TB-MBBP-10848	4129	1.5	108	48	4.02	160.92
TB-MBBP-10854	4430	1.5	108	54	4.58	183.44
TB-MBBP-10860	4464	1.5	108	60	5.14	205.94
TB-MBBP-12048	4279	1.5	120	48	4.48	179.26
TB-MBBP-12054	4610	1.5	120	54	5.1	204.26

Code	Price	H	W	D	Volume (ft ³)	Weight (lb)
TB-MBBP-12060	4640	1.5	120	60	5.72	229.28
TB-MBBP-13248	4431	1.5	132	48	4.94	197.6
TB-MBBP-13254	4789	1.5	132	54	5.62	225.1
TB-MBBP-13260	4820	1.5	132	60	6.32	252.62
TB-MBBP-14448	4583	1.5	144	48	5.4	215.92
TB-MBBP-14454	4970	1.5	144	54	6.14	245.94
TB-MBBP-14460	5005	1.5	144	60	6.9	275.94
TB-MBBP-15648	4735	1.5	156	48	5.86	234.26
TB-MBBP-15654	5152	1.5	156	54	6.66	266.78
TB-MBBP-15660	5187	1.5	156	60	7.48	299.28
TB-MBBP-16848	5124	1.5	168	48	6.32	252.6
TB-MBBP-16854	5333	1.5	168	54	7.18	287.6
TB-MBBP-16860	5367	1.5	168	60	8.06	322.62
TB-MBBP-18048	5156	1.5	180	48	6.78	270.92
TB-MBBP-18054	5513	1.5	180	54	7.7	308.44
TB-MBBP-18060	5548	1.5	180	60	8.64	345.96
TB-MBBP-19248	5191	1.5	192	48	7.22	289.26
TB-MBBP-19254	5696	1.5	192	54	8.22	329.28
TB-MBBP-19260	5728	1.5	192	60	9.22	369.3
TB-MBBP-20448	6725	1.5	204	48	7.69	308.97
TB-MBBP-20454	7281	1.5	204	54	8.75	351.49
TB-MBBP-20460	7330	1.5	204	60	9.81	394.01
TB-MBBP-21648	6878	1.5	216	48	8.15	327.31
TB-MBBP-21654	7462	1.5	216	54	9.27	373.33
TB-MBBP-21660	7509	1.5	216	60	10.4	417.35
TB-MBBP-22848	7027	1.5	228	48	8.61	345.65
TB-MBBP-22854	7642	1.5	228	54	9.4	393.17
TB-MBBP-22860	7690	1.5	228	60	10.98	440.69
TB-MBBP-24048	7419	1.5	240	48	9.06	363.99
TB-MBBP-24054	7824	1.5	240	54	10.31	414.01
TB-MBBP-24060	7872	1.5	240	60	11.56	464.03

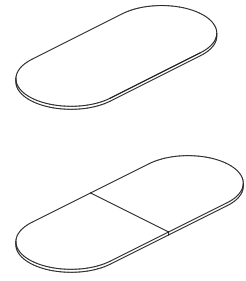

1.5" Racetrack Tabletop

How to Specify:

Each laminate comes with matching vinyl trim color unless otherwise specified on your purchase order. Refer to the laminate finish card for details.

Notes:

- Tabletops 72"-96"W are configured in one-piece top.
- Tabletops 108"-192"W are configured in two-piece tops.
- Tabletops 204"-240"W are configured in three-piece tops.

Options:

- laminate color
- edge profile

Code	Price	H	W	D	Volume (ft ³)	Weight (lb)
TB-MRRX-7236	901	1.5	72	36	2.01	80.37
TB-MRRX-7242	1128	1.5	72	42	2.3	91.89
TB-MRRX-8436	1036	1.5	84	36	2.38	95.38
TB-MRRX-8442	1225	1.5	84	42	2.73	109.4
TB-MRRX-8448	1306	1.5	84	48	3.07	122.88
TB-MRRX-9636	1130	1.5	96	36	2.76	110.38
TB-MRRX-9642	1325	1.5	96	42	3.17	126.9
TB-MRRX-9648	1370	1.5	96	48	3.57	142.89
TB-MRRX-10848	1642	1.5	108	48	4.06	162.62
TB-MRRX-10854	1941	1.5	108	54	4.52	180.56
TB-MRRX-10860	1974	1.5	108	60	4.94	197.96
TB-MRRX-12048	1794	1.5	120	48	4.56	182.6
TB-MRRX-12054	2120	1.5	120	54	5.08	203.06

Code	Price	H	W	D	Volume (ft ³)	Weight (lb)
TB-MRRX-12060	2153	1.5	120	60	5.58	222.98
TB-MRRX-13248	1943	1.5	132	48	5.06	202.62
TB-MRRX-13254	2301	1.5	132	54	5.64	225.58
TB-MRRX-13260	2335	1.5	132	60	6.2	247.98
TB-MRRX-14448	2095	1.5	144	48	5.56	222.64
TB-MRRX-14454	2483	1.5	144	54	6.2	248.08
TB-MRRX-14460	2517	1.5	144	60	6.82	273
TB-MRRX-15648	2250	1.5	156	48	6.06	242.64
TB-MRRX-15654	2667	1.5	156	54	6.76	270.6
TB-MRRX-15660	2699	1.5	156	60	7.44	298.02
TB-MRRX-16848	2633	1.5	168	48	6.56	262.66
TB-MRRX-16854	2845	1.5	168	54	7.32	293.1
TB-MRRX-16860	2879	1.5	168	60	8.08	323.02
TB-MRRX-18048	2672	1.5	180	48	7.06	282.66
TB-MRRX-18054	3027	1.5	180	54	7.88	315.62
TB-MRRX-18060	3063	1.5	180	60	8.7	348.04
TB-MRRX-19248	2701	1.5	192	48	7.56	302.66
TB-MRRX-19254	3211	1.5	192	54	8.44	338.12
TB-MRRX-19260	3242	1.5	192	60	9.32	373.04
TB-MRRX-20448	2996	1.5	204	48	8.06	322.58
TB-MRRX-20454	3549	1.5	204	54	9.01	360.53
TB-MRRX-20460	3598	1.5	204	60	9.94	397.95
TB-MRRX-21648	3146	1.5	216	48	8.56	342.59
TB-MRRX-21654	3729	1.5	216	54	9.57	383.04
TB-MRRX-21660	3780	1.5	216	60	10.56	422.97
TB-MRRX-22848	3298	1.5	228	48	9.06	362.59
TB-MRRX-22854	3912	1.5	228	54	10.13	405.55
TB-MRRX-22860	3960	1.5	228	60	11.19	447.97
TB-MRRX-24048	3687	1.5	240	48	9.56	382.6
TB-MRRX-24054	4092	1.5	240	54	10.7	428.06
TB-MRRX-24060	4143	1.5	240	60	11.82	472.98



1.5" Racetrack Tabletop w/Power and Data

How to Specify:

Each laminate comes with matching vinyl trim color unless otherwise specified on your purchase order. Refer to the laminate finish card for details.

Notes:

Tabletops 72"-96"W are configured in one-piece top.
 Tabletops 108"-192"W are configured in two-piece tops.
 Tabletops 204"-240"W are configured in three-piece tops.
 Single-piece tabletops are equipped with one power and data grommet, two-piece tabletops are equipped with two power and data grommets, and three-piece tabletops are equipped with three power and data grommets.
 Two power and dual USB-A receptacles with 3 open slots to accommodate RJ11, RJ45, HDMI, VGA or Stereo. Items for 3 open slots must be specified and purchased separately.
 Boardroom tables with tops comprised of 2 or more pieces will not have a consistent grain pattern.

Options:

- laminate color

- edge profile

- grommet color (for tabletops with power and data)

Code	Price	H	W	D	Volume (ft ³)	Weight (lb)
TB-MRRP-7236	2144	1.5	72	36	1.96	78.44
TB-MRRP-7242	2372	1.5	72	42	2.25	89.96
TB-MRRP-8436	2280	1.5	84	36	2.34	93.45
TB-MRRP-8442	2470	1.5	84	42	2.69	107.47
TB-MRRP-8448	2552	1.5	84	48	3.02	120.95
TB-MRRP-9636	2376	1.5	96	36	2.71	108.46
TB-MRRP-9642	2571	1.5	96	42	3.12	124.98
TB-MRRP-9648	2615	1.5	96	48	3.52	140.96
TB-MRRP-10848	4129	1.5	108	48	3.96	158.76
TB-MRRP-10854	4430	1.5	108	54	4.42	176.7
TB-MRRP-10860	4464	1.5	108	60	4.86	194.12
TB-MRRP-12048	4279	1.5	120	48	4.46	178.76
TB-MRRP-12054	4610	1.5	120	54	4.98	199.22

Code	Price	H	W	D	Volume (ft ³)	Weight (lb)
TB-MRRP-12060	4640	1.5	120	60	5.48	219.12
TB-MRRP-13248	4431	1.5	132	48	4.96	198.78
TB-MRRP-13254	4789	1.5	132	54	5.54	221.72
TB-MRRP-13260	4820	1.5	132	60	6.1	244.14
TB-MRRP-14448	4583	1.5	144	48	5.46	218.78
TB-MRRP-14454	4970	1.5	144	54	6.1	244.24
TB-MRRP-14460	5005	1.5	144	60	6.72	269.14
TB-MRRP-15648	4735	1.5	156	48	5.96	238.78
TB-MRRP-15654	5152	1.5	156	54	6.66	266.74
TB-MRRP-15660	5187	1.5	156	60	7.36	294.16
TB-MRRP-16848	5124	1.5	168	48	6.46	258.8
TB-MRRP-16854	5333	1.5	168	54	7.22	289.24
TB-MRRP-16860	5367	1.5	168	60	7.98	319.16
TB-MRRP-18048	5156	1.5	180	48	6.96	278.8
TB-MRRP-18054	5513	1.5	180	54	7.8	311.76
TB-MRRP-18060	5548	1.5	180	60	8.6	344.18
TB-MRRP-19248	5191	1.5	192	48	7.46	298.82
TB-MRRP-19254	5696	1.5	192	54	8.36	334.24
TB-MRRP-19260	5728	1.5	192	60	9.22	369.18
TB-MRRP-20448	6725	1.5	204	48	7.97	320.19
TB-MRRP-20454	7281	1.5	204	54	8.92	358.15
TB-MRRP-20460	7330	1.5	204	60	9.85	395.57
TB-MRRP-21648	6878	1.5	216	48	8.47	340.2
TB-MRRP-21654	7462	1.5	216	54	9.48	380.66
TB-MRRP-21660	7509	1.5	216	60	10.48	420.58
TB-MRRP-22848	7027	1.5	228	48	8.97	360.21
TB-MRRP-22854	7642	1.5	228	54	10.04	403.17
TB-MRRP-22860	7690	1.5	228	60	11.1	445.59
TB-MRRP-24048	7419	1.5	240	48	9.47	380.22
TB-MRRP-24054	7824	1.5	240	54	10.61	425.68
TB-MRRP-24060	7872	1.5	240	60	11.73	470.6

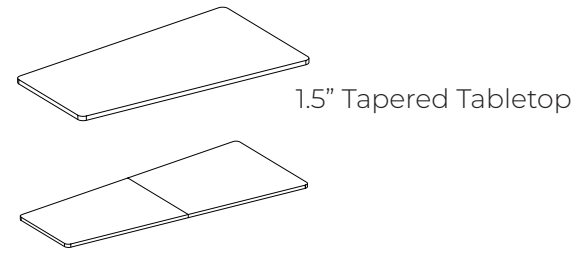

1.5" Tapered Tabletop

How to Specify:

Each laminate comes with matching vinyl trim color unless otherwise specified on your purchase order. Refer to the laminate finish card for details.

Notes:

- Tabletops 72"-96"W are configured in one-piece top.
- Tabletops 108"-192"W are configured in two-piece tops.
- Tabletops 204"-240"W are configured in three-piece tops.

Options:

- laminate color
- edge profile
- grommet color (for tabletops with power and data)

Code	Price	H	W	D	Volume (ft ³)	Weight (lb)
TB-MTTX-844836	1311	1.5	84	48	3.06	122.43
TB-MTTX-964836	1344	1.5	96	48	3.5	139.93
TB-MTTX-1085436	1915	1.5	108	54	4.21	168.5
TB-MTTX-1086042	1948	1.5	108	60	4.77	191.01
TB-MTTX-1205436	2095	1.5	120	54	4.68	187.26
TB-MTTX-1206042	2129	1.5	120	60	5.3	212.27
TB-MTTX-1326042	2310	1.5	132	60	5.84	233.53
TB-MTTX-1446042	2494	1.5	144	60	6.37	254.79
TB-MTTX-1326648	2509	1.5	132	66	6.52	260.85
TB-MTTX-1447254	2918	1.5	144	72	7.86	314.62
TB-MTTX-1687254	3475	1.5	168	72	9.17	367.14
TB-MTTX-1927860	4161	1.5	192	78	11.48	459.49
TB-MTTX-2167860	4929	1.5	216	78	12.92	517.01
TB-MTTX-2406048	4047	1.5	240	60	11.23	449.49



1.5" Tapered Tabletop w/Power and Data

How to Specify:

Each laminate comes with matching vinyl trim color unless otherwise specified on your purchase order. Refer to the laminate finish card for details.

Notes:

- Tabletops 72"-96"W are configured in one-piece top.
- Tabletops 108"-192"W are configured in two-piece tops.
- Tabletops 204"-240"W are configured in three-piece tops.
- Single-piece tabletops are equipped with one power and data grommet, two-piece tabletops are equipped with two power and data grommets, and three-piece tabletops are equipped with three power and data grommets.
- Two power and dual USB-A receptacles with 3 open slots to accommodate RJ11, RJ45, HDMI, VGA or Stereo. Items for 3 open slots must be specified and purchased separately.
- Boardroom tables with tops comprised of 2 or more pieces will not have a consistent grain pattern.

Options:

- laminate color
- edge profile
- grommet color (for tabletops with power and data)

Code	Price	H	W	D	Volume (ft ³)	Weight (lb)
TB-MTTP-1085436	4399	1.5	108	54	4.15	166.91
TB-MTTP-1086042	4434	1.5	108	60	4.71	189.42
TB-MTTP-1205436	4581	1.5	120	54	4.62	185.67
TB-MTTP-1206042	4613	1.5	120	60	5.24	210.68
TB-MTTP-1326042	4808	1.5	132	60	5.78	231.94
TB-MTTP-1446042	4977	1.5	144	60	6.31	253.2
TB-MTTP-844836	2554	1.5	84	48	3.01	120.53
TB-MTTP-964836	2588	1.5	96	48	3.45	138
TB-MTTP-1326648	4994	1.5	132	66	6.46	259.26
TB-MTTP-1447254	5403	1.5	144	72	7.8	313.03
TB-MTTP-1687254	5957	1.5	168	72	9.11	365.55
TB-MTTP-1927860	7891	1.5	192	78	11.39	457.11
TB-MTTP-2167860	8658	1.5	216	78	12.83	514.63
TB-MTTP-2406048	7776	1.5	240	60	11.14	447.1



Notes:

Refer to page 230 for base configuration requirements for selected tabletops

Options:

laminate color

metal color (for post support base)

for Straight/Boat Tabletops

Code	Price	H	W	D	Volume (ft ³)	Weight (lb)
TB-B4-7236	611	28	42	21	14.29	41.45
TB-B4-7242	611	28	42	24	16.33	52.15
TB-B4-8436	611	28	54	21	18.38	44.55
TB-B4-8442	627	28	54	24	21	55.89
TB-B4-8448	685	28	42	84	1.27	51.53
TB-B4-9636	627	28	30	96	1.07	43.54
TB-B4-9642	662	28	36	96	1.16	47.38
TB-B4-9648	741	28	66	30	32.08	63.75
TB-B4-10848	1046	28	77	30	37.43	67.75
TB-B4-10854	1150	28	54	108	2.18	88.49
TB-B4-10860	1250	28	60	108	2.47	100
TB-B4-12048	1089	28	89	30	43.26	71.99
TB-B4-12054	1195	28	54	120	2.26	91.82
TB-B4-12060	1296	28	60	120	2.55	103.34
TB-B4-13248	1134	28	101	30	49.1	76.23
TB-B4-13254	1238	28	54	132	2.35	95.16
TB-B4-13260	1335	28	60	132	2.63	106.67
TB-B4-14448	1185	28	113	30	54.93	80.47

Code	Price	H	W	D	Volume (ft ³)	Weight (lb)
TB-B4-14454	1289	28	54	144	2.43	98.88
TB-B4-14460	1389	28	60	144	2.72	110.4
TB-B4-15648	1230	28	48	156	2.23	90.7
TB-B4-15654	1331	28	54	156	2.51	102.22
TB-B4-15660	1432	28	60	156	2.8	113.73
TB-B4-16848	1272	28	48	168	2.31	94.04
TB-B4-16854	1376	28	54	168	2.6	105.55
TB-B4-16860	1475	28	60	168	2.89	117.07
TB-B4-18048	1316	28	48	180	2.39	97.37
TB-B4-18054	1421	28	54	180	2.59	108.98
TB-B4-18060	1522	28	60	180	2.97	120.4
TB-B4-19248	1360	28	48	192	2.48	100.71
TB-B4-19254	1465	28	54	192	2.76	112.22
TB-B4-19260	1565	28	60	192	3.05	123.74
TB-B4-20448	1666	28	48	204	3	122.06
TB-B4-20454	1806	28	54	204	3.39	137.42
TB-B4-20460	1937	28	60	204	3.77	152.77
TB-B4-21648	1715	28	48	216	3.09	125.79
TB-B4-21654	1855	28	54	216	3.47	141.14
TB-B4-21660	1984	28	60	216	3.85	156.5
TB-B4-22848	1763	28	48	228	3.17	129.13
TB-B4-22854	1899	28	54	228	3.55	144.48
TB-B4-22860	2030	28	60	228	3.98	159.84
TB-B4-24048	1805	28	48	240	3.25	132.46
TB-B4-24054	1943	28	54	240	3.64	147.81
TB-B4-24060	2075	28	60	240	4.02	163.17

for Racetrack Top

Code	Price	H	W	D	Volume (ft ³)	Weight (lb)
TB-B4-8448R	668	28	48	84	1.24	50.41
TB-B4-9648R	717	28	48	96	1.33	53.95
TB-B4-10848R	1031	28	48	108	1.86	75.86
TB-B4-10854R	1121	28	54	108	2.12	86.26
TB-B4-10860R	1207	28	60	108	2.38	96.67
TB-B4-12048R	1074	28	48	120	1.95	79.19
TB-B4-12054R	1163	28	54	120	2.21	89.6
TB-B4-12060R	1250	28	60	120	2.47	100
TB-B4-13248R	1121	28	48	132	2.03	82.53
TB-B4-13254R	1208	28	54	132	2.29	92.93
TB-B4-13260R	1296	28	60	132	2.55	103.34
TB-B4-14448R	1168	28	48	144	2.12	86.26
TB-B4-14454R	1257	28	54	144	2.38	96.66
TB-B4-14460R	1341	28	60	144	2.63	106.67
TB-B4-15648R	1210	28	48	156	2.2	89.59
TB-B4-15654R	1301	28	54	156	2.46	99.99
TB-B4-15660R	1389	28	60	156	2.72	110.4
TB-B4-16848R	1257	28	48	168	2.28	92.92
TB-B4-16854R	1345	28	54	168	2.54	103.33
TB-B4-16860R	1432	28	60	168	2.8	113.73
TB-B4-18048R	1301	28	48	180	2.37	96.26
TB-B4-18054R	1391	28	54	180	2.63	106.66
TB-B4-18060R	1475	28	60	180	2.89	117.07
TB-B4-19248R	1344	28	48	192	2.48	99.59
TB-B4-19254R	1433	28	54	192	2.71	110
TB-B4-19260R	1522	28	60	192	2.97	120.4
TB-B4-20448R	1649	28	48	204	2.95	120.97
TB-B4-20454R	1776	28	54	204	3.33	135.19
TB-B4-20460R	1890	28	60	204	3.69	149.44
TB-B4-21648R	1698	28	48	216	3.06	124.68
TB-B4-21654R	1822	28	54	216	3.41	138.92
TB-B4-21660R	1940	28	60	216	3.77	152.77
TB-B4-22848R	1742	28	48	228	3.14	128.01
TB-B4-22854R	1869	28	54	228	3.5	142.26
TB-B4-22860R	1984	28	60	228	3.85	156.5
TB-B4-24048R	1789	28	48	240	3.23	131.35
TB-B4-24054R	1914	28	54	240	3.58	145.59
TB-B4-24060R	2030	28	60	240	3.94	159.83

for Tapered Tabletop

Code	Price	H	W	D	Volume (ft ³)	Weight (lb)
TB-B4-844836T	637	28	48	84	1.13	45.77
TB-B4-964836T	680	28	48	96	1.21	19.3
TB-B4-1085436T	1028	28	54	108	1.81	73.77
TB-B4-1205436T	1071	28	54	120	1.9	77.11
TB-B4-1086042T	1112	28	60	108	2.04	82.73
TB-B4-1206042T	1154	28	60	120	2.12	86.06
TB-B4-1326042T	1198	28	60	132	2.2	89.4
TB-B4-1326648T	1802	28	66	132	2.47	100.56
TB-B4-1447254T	1976	28	72	144	2.65	108
TB-B4-1687254T	2097	28	72	168	2.83	115.44
TB-B4-1927860T	2473	28	78	192	3.01	122.88
TB-B4-2167860T	2566	28	78	216	5.22	211.32
TB-B4-2406048T	2239	28	60	240	4.19	170.01

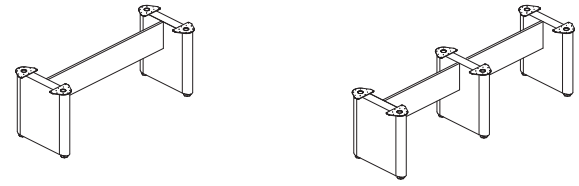

Elliptical Base

Notes:

Refer to page [230](#) for base configuration requirements for selected tabletops

Options:

laminate color

metal color

for Tapered Tabletop

Code	Price	H	W	D	Volume (ft ³)	Weight (lb)
TB-B5-844836T	1771	28	48	84	1.09	66.33
TB-B5-964836T	1815	28	48	96	1.17	69.86
TB-B5-1085436T	2678	28	54	108	1.81	106.9
TB-B5-1086042T	2842	28	60	108	2.21	123.15
TB-B5-1205436T	2718	28	54	120	1.89	110.23
TB-B5-1206042T	2881	28	60	120	2.3	126.49
TB-B5-1326042T	2924	28	60	132	2.38	129.82
TB-B5-1326648T	3069	28	66	132	2.46	133.15
TB-B5-1446042T	2971	28	60	144	2.54	133.5
TB-B5-1447254T	4126	28	72	144	2.7	134.2
TB-B5-1687254T	4416	28	72	168	2.86	134.9
TB-B5-1927860T	5058	28	78	192	3.02	135.6
TB-B5-2167860T	5376	28	78	216	3.97	205.04
TB-B5-2406048T	5110	28	60	240	4.13	212.1

for Racetrack Tabletop

Code	Price	H	W	D	Volume (ft ³)	Weight (lb)
TB-B5-8448R	1794	28	48	84	1.19	70.64
TB-B5-9648R	1838	28	48	96	1.28	74.17
TB-B5-10848R	2708	28	48	108	1.78	105.79
TB-B5-10854R	2794	28	54	108	2.16	120.93
TB-B5-10860R	2942	28	60	108	2.54	136.08
TB-B5-12048R	2751	28	48	120	1.86	109.12
TB-B5-12054R	2836	28	54	120	2.24	124.27
TB-B5-12060R	2986	28	60	120	2.62	139.41
TB-B5-13248R	2791	28	48	132	1.95	112.45
TB-B5-13254R	2877	28	54	132	2.33	127.6
TB-B5-13260R	3027	28	60	132	2.7	142.75
TB-B5-14448R	2730	28	48	144	2.03	116.18
TB-B5-14454R	2830	28	54	144	2.41	130.93
TB-B5-14460R	3067	28	60	144	2.79	146.08
TB-B5-15648R	2878	28	48	156	2.12	119.52
TB-B5-15654R	2963	28	54	156	2.49	134.66
TB-B5-15660R	3113	28	60	156	2.87	149.81
TB-B5-16848R	2919	28	48	168	2.2	122.85
TB-B5-16854R	3004	28	54	168	2.58	138
TB-B5-16860R	3157	28	60	168	2.96	153.14
TB-B5-18048R	2960	28	48	180	2.28	126.19
TB-B5-18054R	3043	28	54	180	2.66	141.33
TB-B5-18060R	3190	28	60	180	3.04	156.48
TB-B5-19248R	3001	28	48	192	2.37	129.52
TB-B5-19254R	3086	28	54	192	2.74	144.67
TB-B5-19260R	3239	28	60	192	3.12	159.81
TB-B5-20448R	4554	28	48	204	2.85	160.58
TB-B5-20454R	4665	28	54	204	3.37	181.14
TB-B5-20460R	4865	28	60	204	3.88	201.71
TB-B5-21648R	4466	28	48	216	2.94	164.31
TB-B5-21654R	4603	28	54	216	3.45	184.48
TB-B5-21660R	4931	28	60	216	3.97	205.04
TB-B5-22848R	4684	28	48	228	3.02	167.64
TB-B5-22854R	4793	28	54	228	3.54	188.2
TB-B5-22860R	4991	28	60	228	4.05	208.77
TB-B5-24048R	4743	28	48	240	3.11	170.97
TB-B5-24054R	4858	28	54	240	3.62	191.54
TB-B5-24060R	5054	28	60	240	4.13	212.1

for Straight/Boat Tabletops

Code	Price	H	W	D	Volume (ft ³)	Weight (lb)
TB-B5-7236	1612	28	36	72	0.87	57.58
TB-B5-7242	1669	28	42	72	1	63
TB-B5-8436	1651	28	36	84	0.95	60.91
TB-B5-8442	1710	28	42	84	1.09	66.33
TB-B5-8448	1807	28	84	48	1.22	71.75
TB-B5-9636	1696	28	36	96	1.03	64.45
TB-B5-9642	1752	28	42	96	1.17	69.86
TB-B5-9648	1850	28	48	96	1.3	75.3
TB-B5-10848	2720	28	48	108	1.81	106.9
TB-B5-10854	2823	28	54	108	2.21	123.15
TB-B5-10860	2986	28	60	108	2.62	139.41
TB-B5-12048	2762	28	48	120	1.89	110.23
TB-B5-12054	2863	28	54	120	2.3	126.49
TB-B5-12060	3027	28	60	120	2.7	142.75
TB-B5-13248	2802	28	48	132	1.97	113.57
TB-B5-13254	2904	28	54	132	2.38	129.82
TB-B5-13260	3067	28	60	132	2.79	146.08
TB-B5-14448	2850	28	48	144	2.06	117.29
TB-B5-14454	2950	28	54	144	2.47	133.55
TB-B5-14460	3113	28	60	144	2.87	149.81
TB-B5-15648	2892	28	48	156	2.14	120.63
TB-B5-15654	2992	28	54	156	2.55	136.88
TB-B5-15660	3157	28	60	156	2.96	153.14
TB-B5-16848	2927	28	48	168	2.23	123.96
TB-B5-16854	3028	28	54	168	2.63	140.22

Code	Price	H	W	D	Volume (ft ³)	Weight (lb)
TB-B5-16860	3190	28	60	168	3.04	156.48
TB-B5-18048	2974	28	48	180	2.31	127.3
TB-B5-18054	3072	28	54	180	2.72	143.55
TB-B5-18060	3239	28	60	180	3.12	159.81
TB-B5-19248	3013	28	48	192	2.39	130.63
TB-B5-19254	3113	28	54	192	2.8	146.89
TB-B5-19260	3281	28	60	192	3.21	163.15
TB-B5-20448	4571	28	48	204	2.88	161.69
TB-B5-20454	4709	28	54	204	3.42	183.37
TB-B5-20460	4928	28	60	204	3.97	205.04

Tabletop Sizes **Post Support**



72" x 36"	4
84" x 36"	4
72" x 42"	4
84" x 42"	4
96" x 48"	4



108" x 48"	6
120" x 48"	6
132" x 48"	6
144" x 48"	6



T-RJ45



T-RJ11



T-VGA



T-STEREO

Code	Price
T-RJ45	230
T-RJ11	87
T-HDMI	223
T-VGA	278
T-STEREO	58

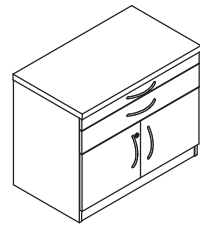

1.5" Serving Cabinet

How to Specify:

Each laminate comes with matching vinyl trim color unless otherwise specified on your purchase order. Refer to the laminate finish card for details.

Notes:

Cabinets and lateral files include lock and keys.

Options:

laminate color

edge profile

handle color

handle style

Code	Price	H	W	D	Volume (ft ³)	Weight (lb)
TB-FCS0-3021	1837	29.5	30	21	16.48	110.08
TB-FCS0-3621	2482	29.5	36	21	19.39	123.75



1.5" Storage Cabinet w/Shelves, LH Shown

How to Specify:

Each laminate comes with matching vinyl trim color unless otherwise specified on your purchase order. Refer to the laminate finish card for details.

Notes:

Cabinets and lateral files include lock and keys.

Options:

laminate color

edge profile

handle color

handle style

Code	Price	H	W	D	Volume (ft ³)	Weight (lb)
TB-FSDS-1821-L	1659	78	18	21	26.1	146.7
TB-FSDS-1821-R	1659	78	18	21	26.1	146.7

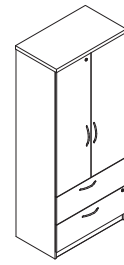

1.5" Combo Cabinet w/Storage and Lateral Files

How to Specify:

Each laminate comes with matching vinyl trim color unless otherwise specified on your purchase order. Refer to the laminate finish card for details.

Notes:

Cabinets and lateral files include lock and keys.

Options:

- laminate color _____
- edge profile _____
- handle color _____
- handle style _____

Code	Price	H	W	D	Volume (ft ³)	Weight (lb)
TB-FCSL-3621	3085	78	36	21	47.45	279.9

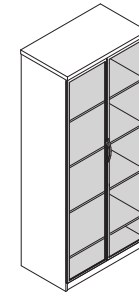

1.5" Double Door Storage Cabinet w/Shelves and Acrylic Doors

How to Specify:

Each laminate comes with matching vinyl trim color unless otherwise specified on your purchase order. Refer to the laminate finish card for details.

Notes:

Options:

- laminate color _____
- edge profile _____
- handle color _____
- handle style _____
- metal color (for doors) _____
- acrylic color (for doors) _____

Code	Price	H	W	D	Volume (ft ³)	Weight (lb)
TB-FSDS-3621-G	4422	78	36	21	47.45	225.45

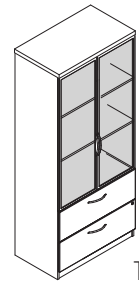

1.5" Combo Cabinet w/Storage, Lateral Files and Acrylic Doors

How to Specify:

Each laminate comes with matching vinyl trim color unless otherwise specified on your purchase order. Refer to the laminate finish card for details.

Notes:

There are no locks for acrylic doors.

Options:

- laminate color _____
- edge profile _____
- handle color _____
- handle style _____
- metal color (for acrylic doors) _____
- acrylic color (for acrylic doors) _____

Code	Price	H	W	D	Volume (ft ³)	Weight (lb)
TB-FCSL-3621-G	4967	78	36	21	47.45	278.1

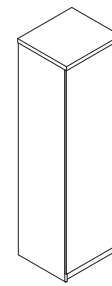

1.5" Storage Cabinet w/Coat Bar and Shelves, LH Shown

How to Specify:

Each laminate comes with matching vinyl trim color unless otherwise specified on your purchase order. Refer to the laminate finish card for details.

Notes:

Cabinets and lateral files include lock and keys.

Options:

- laminate color _____
- edge profile _____
- handle color _____
- handle style _____

Code	Price	H	W	D	Volume (ft ³)	Weight (lb)
TB-FSDC-2421-L	1785	78	24	21	13.22	194.4
TB-FSDC-2421-R	1785	78	24	21	13.22	194.4

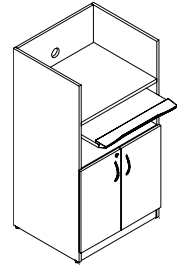

1" Computer Desk with 1.5" top

How to Specify:

Each laminate comes with matching vinyl trim color unless otherwise specified on your purchase order. Refer to the laminate finish card for details.

Notes:

Comes with locks for cabinets.

Options:

laminate color

edge profile

handle color

handle style

grommet color

Code	Price	H	W	D	Volume (ft ³)	Weight (lb)
U-TCDS-542824	4573	54	28	24	21	80



Metro Pricebook
January 2026
Accessories

accessories

<u>keyboard tray</u>	242
<u>tackboard for hutch</u>	243
<u>pencil drawer</u>	244
<u>task light</u>	245
<u>monitor arm</u>	246
<u>wire manager</u>	247

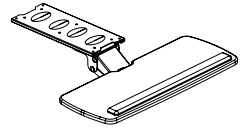

Articulating Keyboard Tray

What's Included:

Keyboard Tray, installation hardware.

How to Specify:

The articulating keyboards are available only in black.

Notes:

Keyboard trays provide adjustable ergonomic support for individuals in multi-task environments

Code	Price	H	W	D	Volume (ft ³)	Weight (lb)
Articulating Keyboard Tray						
V-KASX-2510	459	0	25	10	0	15

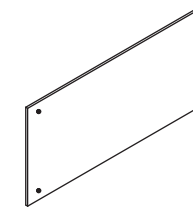

14"H Tackboard for Hutch w/Pigeonholes

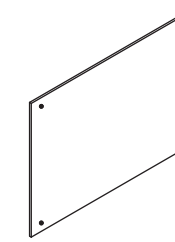

21"H Tackboard for Hutch without Pigeonholes

Options:

fabric color (for tackboard)

Code	Price	H	W	D	Volume (ft ³)	Weight (lb)
14"H Tackboard for Hutch w/Pigeonholes						
V-ATH0-1427	254	14	27	0.5	0.81	1.7
V-ATH0-1433	268	14	33	0.5	0.96	2.1
V-ATH0-1439	278	14	39	0.5	1.12	2.5
V-ATH0-1445	290	14	45	0.5	1.28	2.9
V-ATH0-1451	302	14	51	0.5	1.43	3.3
V-ATH0-1457	307	14	57	0.5	1.59	3.7
V-ATH0-1463	322	14	63	0.5	1.74	4.1
V-ATH0-1469	336	14	69	0.5	1.9	4.5
V-ATH0-1475	368	14	75	0.5	2.06	4.9
V-ATH0-1481	422	14	81	0.5	2.21	5.4
21"H Tackboard for Hutch without Pigeonholes						
V-ATH0-2127	350	21	27	0.5	1.12	2.7
V-ATH0-2133	366	21	33	0.5	1.34	3.1
V-ATH0-2139	402	21	39	0.5	1.56	3.5
V-ATH0-2145	436	21	45	0.5	1.77	3.9
V-ATH0-2151	474	21	51	0.5	1.99	4.3
V-ATH0-2157	522	21	57	0.5	2.21	4.7
V-ATH0-2163	571	21	63	0.5	2.42	5.1
V-ATH0-2169	637	21	69	0.5	2.64	5.5
V-ATH0-2175	655	21	75	0.5	2.86	5.9
V-ATH0-2181	681	21	81	0.5	3.07	6.3

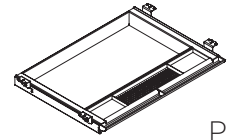

Plastic Pencil Drawer

Notes:

Plastic Pencil Drawers are available in black only.

Code	Price	H	W	D	Volume (ft ³)	Weight (lb)
V-ADPP	100	2.8	21	16	0.62	2

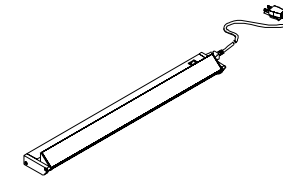

Task Light

Notes:

Task light comes in black finish.

Task lights come with built-in occupancy sensor with 30 minute delay

Code	Price	H	W	D	Volume (ft ³)	Weight (lb)
V-ELU-24	344	0	24.53	0	0	9.5
V-ELU-36	387	0	36.39	0	0	13.7
V-ELU-48	486	0	48.15	0.15	0	17.9

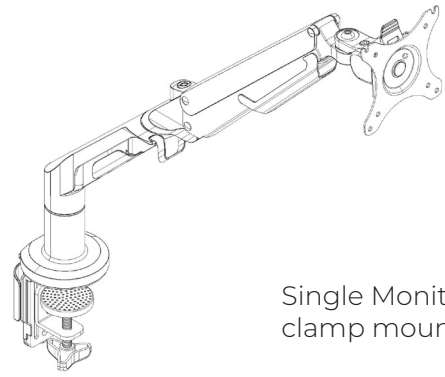

Single Monitor Arm - clamp mount

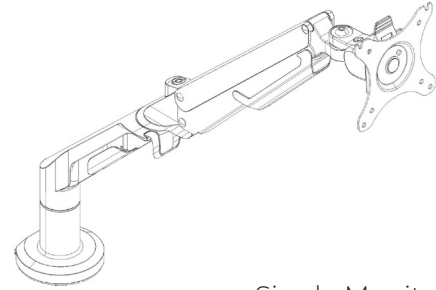

Single Monitor Arm - grommet mount

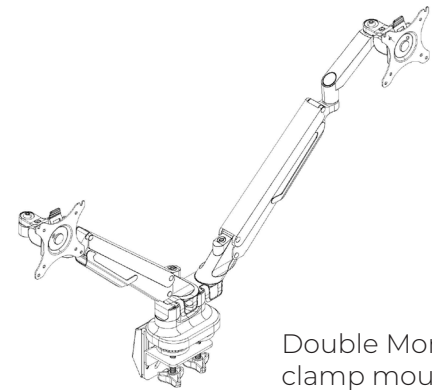

Double Monitor Arm - clamp mount

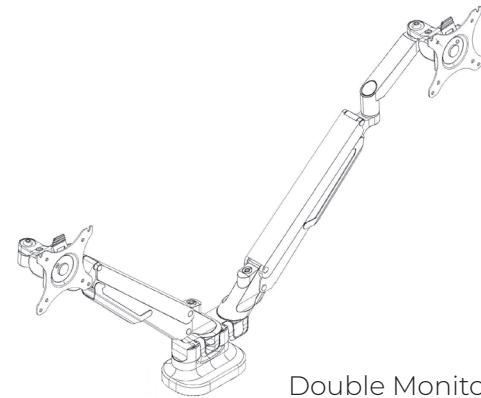

Double Monitor Arm - grommet mount

What's Included:

One monitor arm and installation hardware for both clamp and grommet mount

How to Specify:

- Specify type

Dimensions:

Vesa: 75x75 and 100x100

Code	Price
Monitor Arm - Single Mount	
V-AFMA-01	426
Monitor Arm - Double Mount	
V-AFMA-02	711

Notes:

Available in silver only

Single Monitor Arm

- Screen Size - 17"-36"
- Load Capacity - 6.6-26.4lbs/3-12kg
- Tilt Range - -90 degrees - -15 degrees

Dual Monitor Arm

- Screen Size - 17"-32"
- Load Capacity - 4.4-19.8lbs/2-9kg
- Tilt Range - -90 degrees - -15 degrees



Vertical Wire Manager

Notes:

Wire manager is available in silver only.

Code	Price	H	W	D	Volume (ft ³)	Weight (lb)
V-EE00	362	28	4	4	0.25	1