

tayco®

Halifax Pricebook  
May 2023

# Tables & Casegoods

Contract Number: PC70284

Caution	5
Tables	6
A-Leg	7
Super Ellipse   Standing	8
Super Ellipse   Seated	10
Super Ellipse   Coffee	12
Rectangle   Standing	14
Rectangle   Seated	16
Rectangle   Coffee	18
Rectangle   Mobile	20
Video   Standing	22
Video   Seated	24
Square   Seated	26
Square   Coffee	27
Circle   Seated	28
Circle   Coffee	29
Squircle   Seated	30
Squircle   Coffee	31
Trilobe   Seated	32
Trilobe   Coffee	33
V-Leg	34
Super Ellipse   Standing	34
Super Ellipse   Seated	36
Super Ellipse   Coffee	38
Rectangle   Standing	40
Rectangle   Seated	42
Rectangle   Coffee	44
Video   Standing	46
Video   Seated	48
Square   Seated	50
Square   Coffee	51
Circle   Seated	52
Circle   Coffee	53
Squircle   Seated	54
Squircle   Coffee	55
Trilobe   Seated	56
Trilobe   Coffee	57

Desking	58
Freestanding A-Leg	60
Freestanding V-Leg	62
Freestanding Hanging Pedestal	64
Low Credenza Mount   A-Leg Hutch & Gallery Wall	66
Low Credenza Mount   A-Leg Short Gable	68
Low Credenza Mount   V-Leg Hutch & Gallery Wall	70
Low Credenza Mount   V-Leg Short Gable	72
Low Credenza Mount   No Leg Hutch & Gallery Wall	74
Low Credenza Mount   No Leg Short Gable	76
High Credenza Mount   A leg	78
High Credenza Mount   V leg	80
Height Adjustable Table	82
Height Adjustable Table Suspended Pedestal	84
Height Adjustable Table Credenza integrated	86
Height Adjustable Table Credenza & Pedestal	88
Worksurface No Grommet	90
Worksurface w/ Grommet	92
Bridge	94
Reinforcement Bar	96
Modesty	98
Worksurface Support & Hardware	100
Table Support	102
Storage	104
Pedestal   Underdesk	106
Pedestal   Underdesk w/ hinged Door	108
Pedestal   Mobile	110
Lateral   Underdesk & Freestanding Box/File	112
Lateral   Single File	114
Lateral   Freestanding File Drawers	116
Lateral   Freestanding w/ Shelf	118
Lateral   Underdesk w/ Shelf	119
Low Credenza   Hinged Doors	120
Low Credenza   Sliding Doors	122
Low Credenza Open & Lateral	124
Low Credenza   End Cap	126
High Credenza   Hinged Door	128

High Credenza   Lateral & Doors	130
High Credenza   Open & Lateral	132
High Credenza   Shelf Above Sliding Door	134
High Credenza   Open Shelf Above Lateral	136
Credenza   Raised Back	137
Credenza Open End Box w/ Top	138
Cushion	140
Gallery Wall	142
Mobile Credenza   Open & Lateral	144
Hutch   Laminate w/ Hinged doors	146
Hutch   Laminate w/ Sliding Door	148
Hutch   Metal w/ Hinged doors	150
Hutch   Metal w/ Sliding Door	152
Hutch   Wall Mounted w/ Hinged door	154
Hutch   Wall mounted w/ Sliding Door	156
Accent Shelf	158
Combo Cabinet   Open Shelf/File Drawer	160
Combo Cabinet   Lateral Storage	162
Locker Tower w/shelves	164
Locker w/ side access	166
Bookcase	168
Audio Visual Unit	170
Support	171
Audio Visual   Mounted Video Table	172
<b>Accessories</b>	<b>174</b>
PET Acoustic board	176
Power	178
Purse Hook, Shelf, Metal Storage	179
Tasklight	180
Monitor Arm	181

Caution

**Load Bottom Drawer First**

- Operate one drawer at a time
- Units may tip if loaded incorrectly
- Units should be attached to a wall or other furniture to reduce tipping hazard
- Always load the heaviest files in the bottom drawer

**Heavy Load**

- Some products must be anchored to wall to ensure stability & safety.
- It is the owner and installers responsibility to ensure that the wall type and construction is of sufficient strength to carry the loads of any wall mounted products and their contents.
- Failure of the wall and anchors to support all imposed loads may result in property damage and/or personal injury.
- Tayco can provide size and empty weight of its products only. As wall blocking is considered a building construction process, Tayco cannot provide recommendations in this respect and cannot be responsible for damage or injury that may occur as a result of improper installation and/or blocking.

**Instability Hazard**

Mobile items on casters such as flip top, personal and movable tables of any type and storage items of any type may present an instability hazard if not secured correctly while in use or in storage. Flip top tables or training tables of any type, are inherently more unstable when folded. Tayco provides the following guidelines & warnings when using mobile products:

- Lock casters immediately after moving. Do not leave the casters unlocked when in use or in storage.
- Motion may increase the instability of any item with casters. If the wheels hit an obstruction the table's forward momentum often causes overturn, especially if the item is not equipped with wheel extensions. Exercise strong caution while moving these items.
- Use caution when abrupt level changes in the floor are present (such as a doorway or room threshold) as caster failure or tipping may result.
- Do not stand, sit or lean on mobile items for support. They are not intended for this use and personal injury or property damage may result.
- Mobile units that feature height adjustable elements must be lowered to the minimum compressed height when moving to prevent instability. It is also recommended the user remove all computer equipment or other accessories to prevent possible weight imbalance or damage to equipment.
- Failure to follow the guidelines above may result in property damage or personal injury.



# Halifax Pricebook May 2023 Tables

## Tables

### A-Leg

Super Ellipse   Standing	8
Super Ellipse   Seated	10
Super Ellipse   Coffee	12
Rectangle   Standing	14
Rectangle   Seated	16
Rectangle   Coffee	18
Rectangle   Mobile	20
Video   Standing	22
Video   Seated	24
Square   Seated	26
Square   Coffee	27
Circle   Seated	28
Circle   Coffee	29
Squircle   Seated	30
Squircle   Coffee	31
Trilobe   Seated	32
Trilobe   Coffee	33

### V-Leg

Super Ellipse   Standing	34
Super Ellipse   Seated	36
Super Ellipse   Coffee	38
Rectangle   Standing	40
Rectangle   Seated	42
Rectangle   Coffee	44
Video   Standing	46
Video   Seated	48
Square   Seated	50
Square   Coffee	51
Circle   Seated	52
Circle   Coffee	53
Squircle   Seated	54
Squircle   Coffee	55
Trilobe   Seated	56
Trilobe   Coffee	57



No Power



With Power

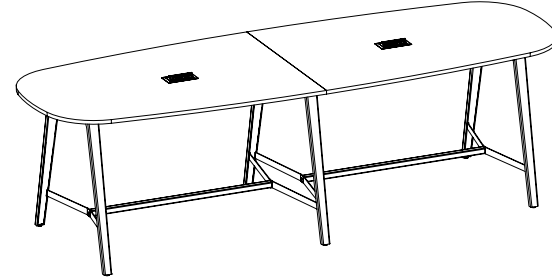
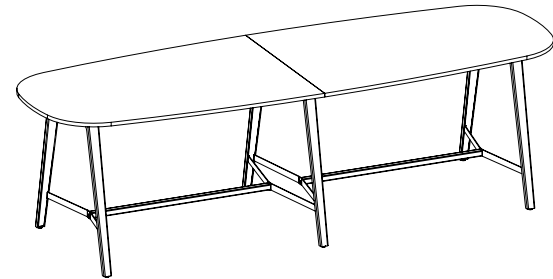

**What's Included:**

- 1" thick super ellipse top
- Sizes: 60"-96: 1-piece top, 4 A-legs with removable infill
- Sizes: 108"-144: 2-piece top, 6 A-legs with removable infill
- Reinforcement bar(s)
- Leg support structure
- Optional Electrics

In-surface powered option comes with one grommet per table piece with 2 AC outlets, dual USB-A chargers, and a blank slot to add an optional HDMI, RJ11, or RJ45 (see [page 180](#) for more options)

**How to Specify:**

Table is sold with base

Each laminate comes with matching vinyl trim unless otherwise specified on the order cover sheet

Infill can match the paint finish of the A-leg or can be specified in a different finish

**Options:**

Widths: 72", 84", 96", 108", 120", 132", 144"

Depths: 30", 36", 42", 48"

Worksurface Laminate

A-Leg paint

A-Leg infill paint

Electrics

**Notes:**

Table corners have 4" radius

Table legs come with adjustable glides up to 1/2"

A-leg has removable infill for wire management capabilities

One of the A-Legs will come with an infill with a small hole to run wires out the bottom

Reinforcement bars have wire management capabilities

**Optional Electrics**

In-surface power+USB module available, offered in silver finish

Optional side-mount USB module, offered in black finish

**No Power**

Code	Price	H	W	D	Vol.	Wt.
H-MEAN-427236	2342	42	72	36	7	104
H-MEAN-427242	2914	42	72	42	8	121
H-MEAN-427248	3090	42	72	48	10	138
H-MEAN-428436	2422	42	84	36	8	121
H-MEAN-428442	3003	42	84	42	10	141
H-MEAN-428448	3185	42	84	48	11	161
H-MEAN-429636	2561	42	96	36	10	138
H-MEAN-429642	3145	42	96	42	11	161
H-MEAN-429648	3335	42	96	48	13	184
H-MEAN-4210836	3073	42	108	36	11	156
H-MEAN-4210842	4875	42	108	42	13	181
H-MEAN-4210848	5079	42	108	48	14	207
H-MEAN-4212036	3225	42	120	36	12	173
H-MEAN-4212042	5055	42	120	42	14	202
H-MEAN-4212048	5259	42	120	48	16	230
H-MEAN-4213236	3301	42	132	36	13	190
H-MEAN-4213242	5156	42	132	42	15	222
H-MEAN-4213248	5359	42	132	48	18	253
H-MEAN-4214436	3376	42	144	36	14	207
H-MEAN-4214442	5301	42	144	42	17	242
H-MEAN-4214448	5489	42	144	48	19	276

**Power**

Code	Price	H	W	D	Vol.	Wt.
H-MEAP-427242	3882	42	72	42	8	121
H-MEAP-427248	4057	42	72	48	10	138
H-MEAP-428442	3969	42	84	42	10	141
H-MEAP-428448	4151	42	84	48	11	161
H-MEAP-429642	4112	42	96	42	11	161
H-MEAP-429648	4303	42	96	48	13	184
H-MEAP-4210842	7383	42	108	42	13	181
H-MEAP-4210848	7588	42	108	48	14	207
H-MEAP-4212042	7560	42	120	42	14	202
H-MEAP-4212048	7765	42	120	48	16	230
H-MEAP-4213242	7662	42	132	42	15	222
H-MEAP-4213248	7866	42	132	48	18	253
H-MEAP-4214442	7807	42	144	42	17	242
H-MEAP-4214448	7997	42	144	48	19	276

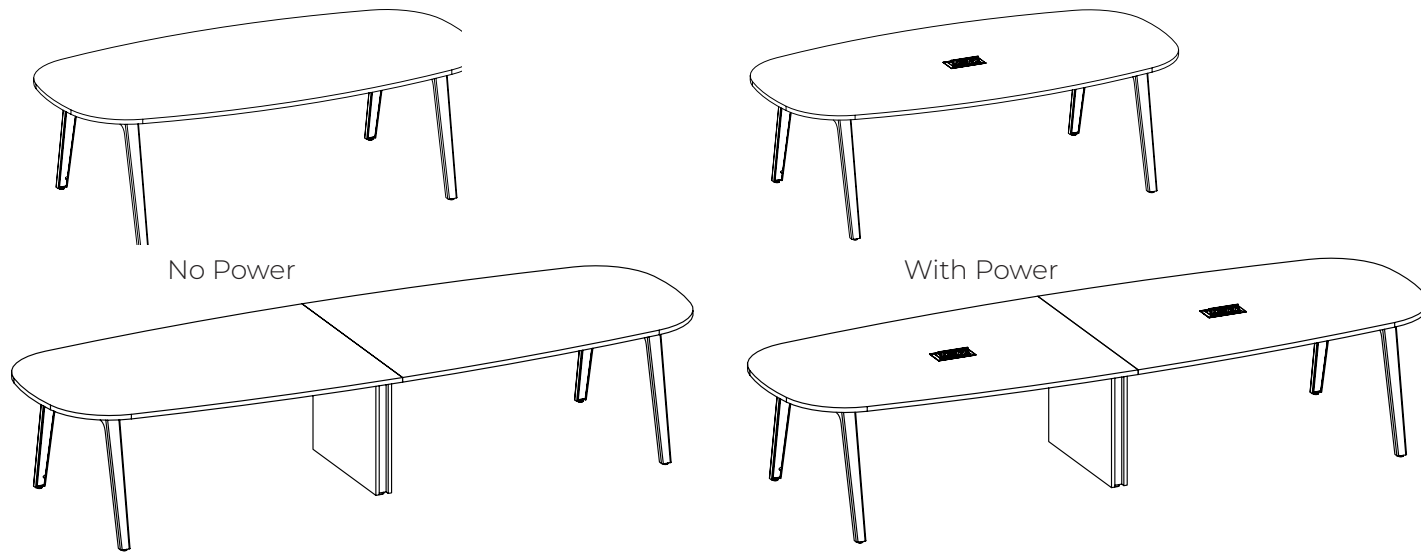

**What's Included:**

- 1" thick super ellipse top
- Sizes: 60"-96: 1-piece top, 4 A-legs with removable infill
- Sizes: 108"-144: 2-piece top, 4 A-legs with removable infill and mid plinth
- Reinforcement bar(s)
- Optional Electrics
  - In-surface powered option comes with one grommet per table piece with 2 AC outlets, dual USB-A chargers, and a blank slot to add an optional HDMI, RJ11, or RJ45 (see [page 178](#) for more options)

**How to Specify:**

Table is sold with base

Each laminate comes with matching vinyl trim unless otherwise specified on the order cover sheet

Infill can match the paint finish of the A-leg or can be specified in a different finish

**Options:**

Widths: 72", 84", 96", 108", 120", 132", 144"

Depths: 30", 36", 42", 48"

Worksurface Laminate

A-Leg paint

A-Leg infill paint

Electrics

**Notes:**

Table corners have 4" radius

Table legs come with adjustable glides up to 1/2"

A-leg has removable infill for wire management capabilities

One of the A-Legs will come with an infill with a small hole to run wires out the bottom

Reinforcement bars have wire management capabilities

Optional Electrics

In-surface power+USB module available, offered in silver finish

Optional side-mount USB module, offered in black finish

**No Power**

Code	Price	H	W	D	Vol.	Wt.
H-MEAN-297236	2136	29	72	36	5.22	75.17
H-MEAN-297242	2198	29	72	42	6.09	87.7
H-MEAN-297248	2376	29	72	48	6.96	100.22
H-MEAN-298436	2213	29	84	36	6.09	87.7
H-MEAN-298442	2283	29	84	42	7.11	102.31
H-MEAN-298448	2468	29	84	48	8.12	116.93
H-MEAN-299636	2343	29	96	36	6.96	100.22
H-MEAN-299642	2420	29	96	42	8.12	116.93
H-MEAN-299648	2613	29	96	48	9.28	133.63
H-MEAN-2910836	3509	29	108	36	7.83	112.75
H-MEAN-2910842	3846	29	108	42	9.14	131.54
H-MEAN-2910848	3982	29	108	48	10.44	150.34
H-MEAN-2912036	3655	29	120	36	10.44	150.34
H-MEAN-2912042	4017	29	120	42	10.15	146.16
H-MEAN-2912048	4153	29	120	48	11.6	167.04
H-MEAN-2913236	3698	29	132	36	9.57	137.81
H-MEAN-2913242	4085	29	132	42	11.17	160.78
H-MEAN-2913248	4223	29	132	48	12.76	183.74
H-MEAN-2914436	3813	29	144	36	10.44	150.34
H-MEAN-2914442	4224	29	144	42	12.18	175.39
H-MEAN-2914448	4364	29	144	48	12.18	175.39

**Power**

Code	Price	H	W	D	Vol.	Wt.
H-MEAP-297236	3098	29	72	36	5.22	75.17
H-MEAP-297242	3166	29	72	42	6.09	87.7
H-MEAP-297248	3343	29	72	48	6.96	100.22
H-MEAP-298436	3175	29	84	36	6.09	87.7
H-MEAP-298442	3251	29	84	42	7.11	102.31
H-MEAP-298448	3434	29	84	48	8.12	116.93
H-MEAP-299636	3311	29	96	36	6.96	100.22
H-MEAP-299642	3386	29	96	42	8.12	116.93
H-MEAP-299648	3577	29	96	48	9.28	133.63
H-MEAP-2910836	#N/A	29	108	36	7.83	112.75
H-MEAP-2910842	6351	29	108	42	9.14	131.54
H-MEAP-2910848	6489	29	108	48	10.44	150.34
H-MEAP-2912036	#N/A	29	120	36	8.7	125.28
H-MEAP-2912042	6522	29	120	42	10.15	146.16
H-MEAP-2912048	6662	29	120	48	11.6	167.04
H-MEAP-2913236	#N/A	29	132	36	9.57	137.81
H-MEAP-2913242	6592	29	132	42	11.17	160.78
H-MEAP-2913248	6730	29	132	48	12.76	183.74
H-MEAP-2914436	#N/A	29	144	36	10.44	150.34
H-MEAP-2914442	6731	29	144	42	12.18	175.39
H-MEAP-2914448	6870	29	144	48	13.92	200.45

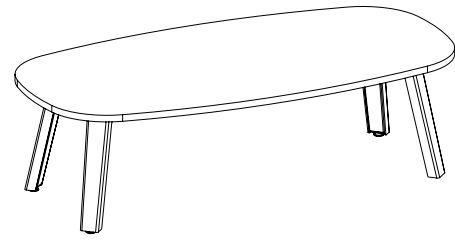

Coffee Table

**What's Included:**

- 3/4" thick super ellipse top
- 4 A-legs with infill

**How to Specify:**

Table is sold with base

Each laminate comes with matching vinyl trim unless otherwise specified on the order cover sheet

Infill can match the paint finish of the A-leg or can be specified in a different finish

**Notes:**

Table corners have 4" radius

Table legs come with adjustable glides up to 1/2"

A-leg has removable infill for wire management capabilities

One of the A-Legs will come with an infill with a small hole to run wires out the bottom

**Options:**

24"D: Widths: 36", 42", 48", 54", 60"

30"D: Widths: 48", 54", 60"

36"D: Widths: 60"

Height: 14"

Worksurface Laminate

A-Leg paint finish

A-Leg infill paint finish

Code	Price	H	W	D	Volume	Weight
H-TEAN-143624	1144	14	36	24	1	12
H-TEAN-144224	1158	14	42	24	1	14
H-TEAN-144824	1174	14	48	24	1	16
H-TEAN-144830	1200	14	48	30	1	20
H-TEAN-145424	1189	14	54	24	1	18
H-TEAN-145430	1219	14	54	30	2	23
H-TEAN-146024	1202	14	60	24	1	20
H-TEAN-146030	1236	14	60	30	2	25
H-TEAN-146036	1272	14	60	36	2	30



No Power

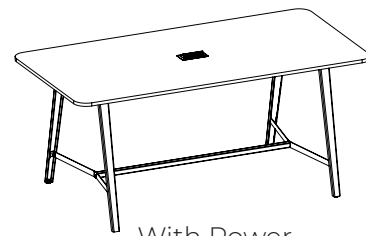

With Power

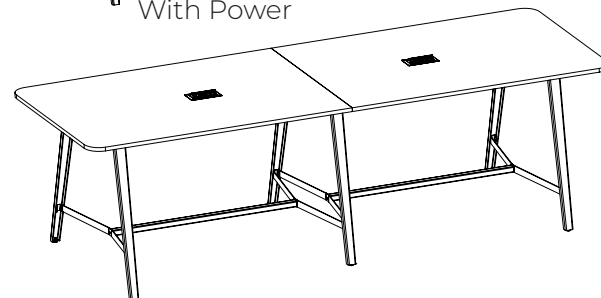
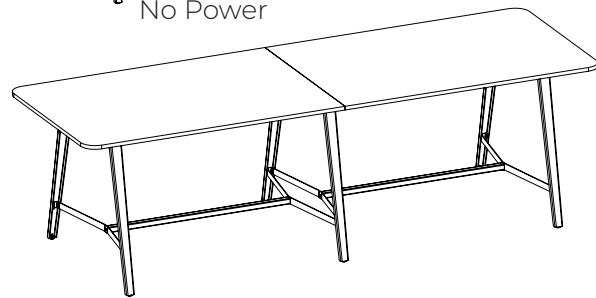

**What's Included:**

- 1" thick rectangular top
- Sizes: 60"-96: 1-piece top, 4 A-legs with removable infill
- Sizes: 108"-144: 2-piece top, 6 A-legs with removable infill
- Reinforcement bar(s)
- Optional Electrics

In-surface powered option comes with one grommet per table piece with 2 AC outlets, dual USB-A chargers, and a blank slot to add an optional HDMI, RJ11, or RJ45 (see [page 178](#) for more options)

**How to Specify:**

Table is sold with base

Each laminate comes with matching vinyl trim unless otherwise specified on the order cover sheet

Infill can match the paint finish of the A-leg or can be specified in a different finish

**Options:**

Widths: 60", 72", 84", 96", 108", 120", 132", 144"

Depths: 36", 42", 48"

Height: 42"

Worksurface Laminate

A-Leg & leg support structure paint finish

A-Leg infill paint finish

Electrics

**Notes:**

Table corners have 4" radius

Table legs come with adjustable glides up to 1/2"

A-leg has removable infill for wire management capabilities

One of the A-Legs will come with an infill with a small hole to run wires out the bottom

Reinforcement bars have wire management capabilities

Optional Electrics

In-surface power+USB module available, offered in silver finish

Optional side-mount USB module, offered in black finish

**No Power**

Code	Price	H	W	D	Vol.	Wt.
H-MRAN-426036	2587	42	60	36	6	86
H-MRAN-426042	2879	42	60	42	7	101
H-MRAN-426048	2962	42	60	48	8	115
H-MRAN-427236	2822	42	72	36	7	104
H-MRAN-427242	2995	42	72	42	8	121
H-MRAN-427248	3088	42	72	48	10	138
H-MRAN-428436	2903	42	84	36	8	121
H-MRAN-428442	3086	42	84	42	10	141
H-MRAN-428448	3182	42	84	48	11	161
H-MRAN-429636	3038	42	96	36	10	138
H-MRAN-429642	3229	42	96	42	11	161
H-MRAN-429648	3331	42	96	48	13	184
H-MRAN-4210836	4523	42	108	36	11	156
H-MRAN-4210842	4974	42	108	42	13	181
H-MRAN-4210848	5066	42	108	48	14	207
H-MRAN-4212036	4673	42	120	36	12	173
H-MRAN-4212042	5150	42	120	42	14	202
H-MRAN-4212048	5244	42	120	48	16	230
H-MRAN-4213236	4752	42	132	36	13	190
H-MRAN-4213242	5254	42	132	42	15	222
H-MRAN-4213248	5345	42	132	48	18	253
H-MRAN-4214436	4871	42	144	36	14	207
H-MRAN-4214442	5399	42	144	42	17	242
H-MRAN-4214448	5492	42	144	48	19	276

**Power**

Code	Price	H	W	D	Vol.	Wt.
H-MRAP-426036	3555	42	60	36	6	86
H-MRAP-426042	3846	42	60	42	7	101
H-MRAP-426048	3928	42	60	48	8	115
H-MRAP-427236	3786	42	72	36	7	104
H-MRAP-427242	3964	42	72	42	8	121
H-MRAP-427248	4054	42	72	48	10	138
H-MRAP-428436	3869	42	84	36	8	121
H-MRAP-428442	4051	42	84	42	10	141
H-MRAP-428448	4149	42	84	48	11	161
H-MRAP-429636	4005	42	96	36	10	138
H-MRAP-429642	4194	42	96	42	11	161
H-MRAP-429648	4300	42	96	48	13	184
H-MRAP-4210836	7030	42	108	36	11	156
H-MRAP-4210842	7480	42	108	42	13	181
H-MRAP-4210848	7574	42	108	48	14	207
H-MRAP-4212036	7183	42	120	36	12	173
H-MRAP-4212042	7659	42	120	42	14	202
H-MRAP-4212048	7751	42	120	48	16	230
H-MRAP-4213236	7257	42	132	48	13	190
H-MRAP-4213242	7758	42	132	42	15	222
H-MRAP-4213248	7852	42	132	48	18	253
H-MRAP-4214436	7378	42	144	36	14	207
H-MRAP-4214442	7905	42	144	42	17	242
H-MRAP-4214448	7998	42	144	48	19	276



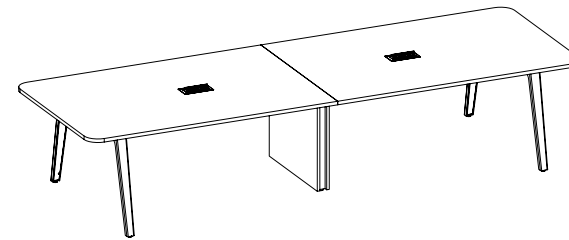
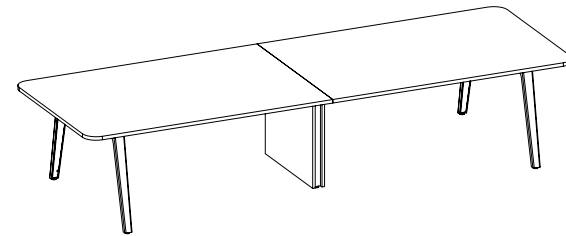

**What's Included:**

- 1" thick rectangular top
- Sizes: 60"-96: 1-piece top, 4 A-legs with removable infill
- Sizes: 108"-144: 2-piece top, 4 A-legs with removable infill and mid plinth
- Reinforcement bar(s)
- Optional Electrics

In-surface powered option comes with one grommet per table piece with 2 AC outlets, dual USB-A chargers, and a blank slot to add an optional HDMI, RJ11, or RJ45 (see [page 178](#) for more options)

**How to Specify:**

Table is sold with base

Each laminate comes with matching vinyl trim unless otherwise specified on the order cover sheet

Infill can match the paint finish of the A-leg or can be specified in a different finish

**Options:**

Widths: 60", 72", 84", 96", 108", 120", 132", 144"

Depths: 30", 36", 42", 48"

Worksurface Laminate

A-Leg paint

A-Leg infill paint

Electrics

**Notes:**

Table corners have 4" radius

Table legs come with adjustable glides up to 1/2"

A-leg has removable infill for wire management capabilities

One of the A-Legs will come with an infill with a small hole to run wires out the bottom

Reinforcement bars have wire management capabilities

Optional Electrics

In-surface power+USB module available, offered in silver finish

Optional side-mount USB module, offered in black finish

**No Power**

Code	Price	H	W	D	Vol.	Wt.
H-MRAN-296030	2006	29	60	30	4	52
H-MRAN-296036	2065	29	60	36	4	63
H-MRAN-296042	2235	29	60	42	5	73
H-MRAN-296048	2284	29	60	48	6	84
H-MRAN-297230	2093	29	72	30	4	63
H-MRAN-297236	2156	29	72	36	5	75
H-MRAN-297242	2262	29	72	42	6	88
H-MRAN-297248	2390	29	72	48	6	88
H-MRAN-298430	2166	29	84	30	5	73
H-MRAN-298436	2235	29	84	36	6	88
H-MRAN-298442	2421	29	84	42	7	102
H-MRAN-298448	2482	29	84	48	8	117
H-MRAN-299630	2289	29	96	30	6	84
H-MRAN-299636	2364	29	96	36	7	100
H-MRAN-299642	2556	29	96	42	8	117
H-MRAN-299648	2625	29	96	48	9	134
H-MRAN-2910830	3449	29	108	30	7	94
H-MRAN-2910836	3531	29	108	36	8	113
H-MRAN-2910842	3982	29	108	42	9	132
H-MRAN-2910848	3997	29	108	48	10	150
H-MRAN-2912030	3585	29	120	30	7	104
H-MRAN-2912036	3678	29	120	36	9	125
H-MRAN-2912042	4153	29	120	42	10	146
H-MRAN-2912048	4169	29	120	48	12	167
H-MRAN-2913230	3622	29	132	30	8	115
H-MRAN-2913236	3719	29	132	36	10	138
H-MRAN-2913242	4223	29	132	42	11	161
H-MRAN-2913248	4237	29	132	48	13	184
H-MRAN-2914430	3730	29	144	30	9	125
H-MRAN-2914436	3835	29	144	36	10	150
H-MRAN-2914442	4364	29	144	42	12	175
H-MRAN-2914448	4377	29	144	48	14	200

**Power**

Code	Price	H	W	D	Vol.	Wt.
H-MRAP-296030	2973	29	60	30	4	52
H-MRAP-296036	3029	29	60	36	4	63
H-MRAP-296042	3204	29	60	42	5	73
H-MRAP-296048	3252	29	60	48	6	84
H-MRAP-297230	3061	29	72	30	4	63
H-MRAP-297236	3123	29	72	36	5	75
H-MRAP-297242	3229	29	72	42	6	88
H-MRAP-297248	3358	29	72	48	7	100
H-MRAP-298430	3133	29	84	30	5	73
H-MRAP-298436	3204	29	84	36	6	88
H-MRAP-298442	3387	29	84	42	7	102
H-MRAP-298448	3450	29	84	48	8	117
H-MRAP-299630	3256	29	96	30	6	84
H-MRAP-299636	3331	29	96	36	7	100
H-MRAP-299642	3523	29	96	42	8	117
H-MRAP-299648	3593	29	96	48	9	134
H-MRAP-2910830	5954	29	108	30	7	94
H-MRAP-2910836	6040	29	108	36	8	113
H-MRAP-2910842	6489	29	108	42	9	132
H-MRAP-2910848	6505	29	108	48	10	150
H-MRAP-2912030	6094	29	120	30	7	104
H-MRAP-2912036	6184	29	120	36	9	125
H-MRAP-2912042	6662	29	120	42	10	146
H-MRAP-2912048	6675	29	120	48	12	167
H-MRAP-2913230	6133	29	132	30	8	115
H-MRAP-2913236	6227	29	132	36	10	138
H-MRAP-2913242	6730	29	132	42	11	161
H-MRAP-2913248	6744	29	132	48	11	184
H-MRAP-2914430	6239	29	144	30	9	125
H-MRAP-2914436	6340	29	144	36	10	150
H-MRAP-2914442	6870	29	144	42	12	175
H-MRAP-2914448	6885	29	144	48	14	200

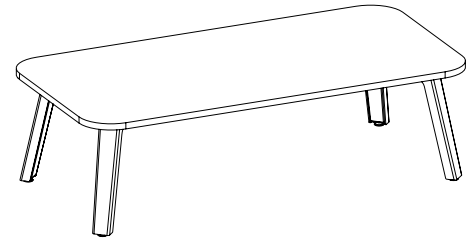

Coffee Table

**What's Included:**

- 3/4" thick rectangular top
- 4 A-legs with infill

**How to Specify:**

Table is sold with base

Each laminate comes with matching vinyl trim unless otherwise specified on the order cover sheet

Infill can match the paint finish of the A-leg or can be specified in a different finish

**Notes:**

Table corners have 4" radius

Table legs come with adjustable glides up to 1/2"

A-leg has removable infill for wire management capabilities

One of the A-Legs will come with an infill with a small hole to run wires out the bottom

**Options:**

24"D: Widths: 36", 42", 48", 54", 60"

30"D: Widths: 48", 54", 60"

36"D: Widths: 60"

Height: 14"

Worksurface Laminate

A-Leg paint finish

A-Leg infill paint finish

Code	Price	H	W	D	Volume	Weight
H-TRAN-143624	1120	14	36	24	1	12
H-TRAN-144224	1134	14	42	24	1	14
H-TRAN-144824	1146	14	48	24	1	16
H-TRAN-144830	1174	14	48	30	1	20
H-TRAN-145424	1161	14	54	24	1	18
H-TRAN-145430	1194	14	54	30	2	23
H-TRAN-146024	1175	14	60	24	1	20
H-TRAN-146030	1210	14	60	30	2	25
H-TRAN-146036	1243	14	60	36	2	30

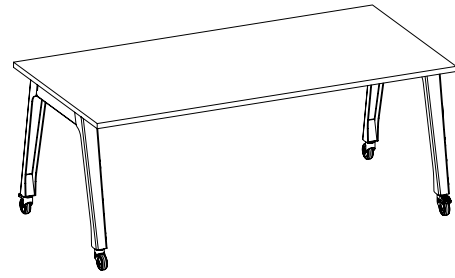

Mobile Table

**What's Included:**

- 1" thick rectangular top
- 4 A-legs with caster cover
- 4 casters

**How to Specify:**

Table is sold with base and casters

**Notes:**

Table corners have 4" radius  
 One of the A-Legs will come with an infill with a small hole to run wires out the bottom

**Options:**

- 24"D: Widths: 36", 42", 48", 54", 60", 72"
- 30"D: Widths: 48", 54", 60", 72"
- 36"D: Widths: 60", 72"
- Height: 29"
- Worksurface Laminate
- A-Leg paint finish
- A-Leg caster cover paint

Code	Price	H	W	D	Volume	Weight
H-ZRAN-293624	1328	29	36	24	2	25
H-ZRAN-294224	1341	29	42	24	2	29
H-ZRAN-294824	1780	29	48	24	2	33
H-ZRAN-295424	1807	29	54	24	3	38
H-ZRAN-296024	1843	29	60	24	3	42
H-ZRAN-297224	1904	29	72	24	3	50
H-ZRAN-294830	2081	29	48	30	3	42
H-ZRAN-295430	2129	29	54	30	3	47
H-ZRAN-296030	2188	29	60	30	4	52
H-ZRAN-297230	2289	29	72	30	4	63
H-ZRAN-296036	2272	29	60	36	4	63
H-ZRAN-297236	2379	29	72	36	5	75

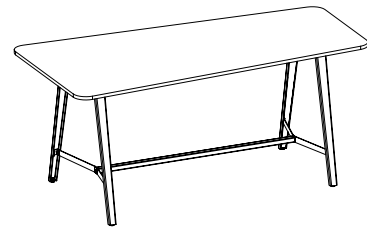

No Power



With Power

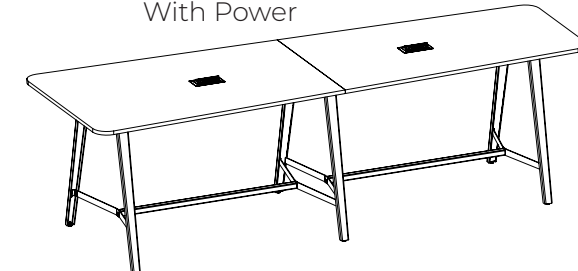
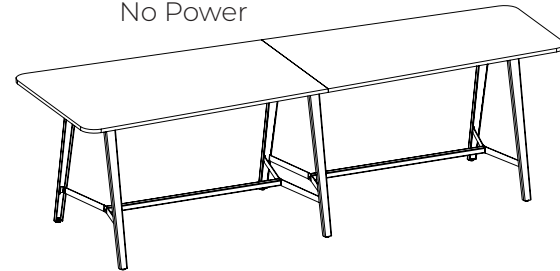

**What's Included:**

- 1" thick video top
- Sizes: 60"-96": 1-piece top, 4 A-legs with removable infill
- Sizes: 108"-144": Sizes: 108"-144": 2-piece top, 6 A-legs with removable infill
- Reinforcement bar(s)
- Optional Electrics
  - In-surface powered option comes with one grommet per table piece with 2 AC outlets, dual USB-A chargers, and a blank slot to add an optional HDMI, RJ11, or RJ45 (see [page 178](#) for more options)

**How to Specify:**

Table is sold with base

Each laminate comes with matching vinyl trim unless otherwise specified on the order cover sheet

Infill can match the paint finish of the A-leg or can be specified in a different finish

**Notes:**

Table corners have 4" radius

Table legs come with adjustable glides up to 1/2"

A-leg has removable infill for wire management capabilities

One of the A-Legs will come with an infill with a small hole to run wires out the bottom

Reinforcement bars have wire management capabilities

Optional Electrics

In-surface power+USB module available, offered in silver finish

Optional side-mount USB module, offered in black finish

**Options:**

Widths: 72", 84", 96", 108", 120", 132", 144"

Depths: 48"

Worksurface Laminate

A-Leg paint

A-Leg infill paint

Electrics

**No Power**

Code	Price	H	W	D	Vol.	Wt.
H-MVAN-427248	3023	42	72	48	10	138
H-MVAN-428448	3116	42	84	48	11	161
H-MVAN-429648	3266	42	96	48	13	184
H-MVAN-4210848	5013	42	108	48	14	207
H-MVAN-4212048	5190	42	120	48	16	230
H-MVAN-4213248	5291	42	132	48	18	253
H-MVAN-4214448	5437	42	144	48	19	276

**Power**

Code	Price	H	W	D	Vol.	Wt.
H-MVAP-427248	3990	42	72	48	10	138
H-MVAP-428448	4084	42	84	48	11	161
H-MVAP-429648	4233	42	96	48	13	184
H-MVAP-4210848	7521	42	108	48	14	207
H-MVAP-4212048	7697	42	120	48	16	230
H-MVAP-4213248	7799	42	132	48	18	253
H-MVAP-4214448	7945	42	144	48	19	276

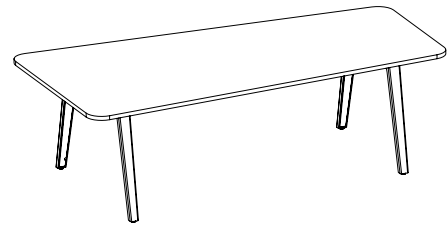

No Power

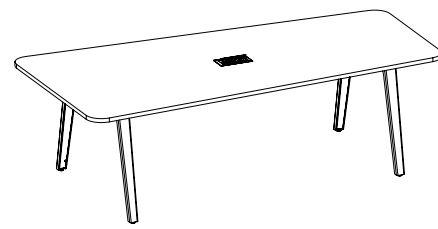

With Power

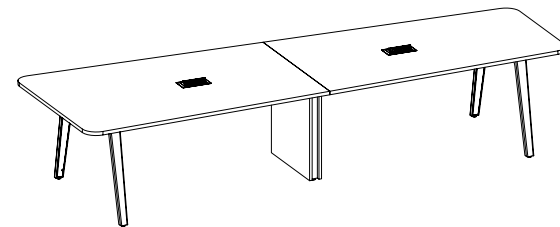
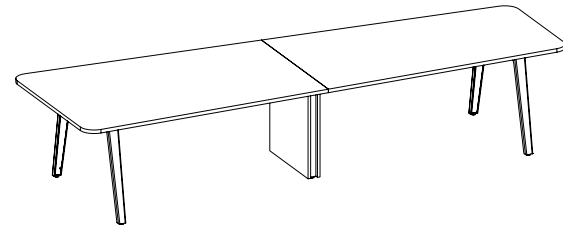

**What's Included:**

- 1" thick video top
- Sizes: 60"-96: 1-piece top, 4 A-legs with removable infill
- Sizes: 108"-144: 2-piece top, 4 A-legs with removable infill and mid plinth
- Reinforcement bar(s)
- Optional Electrics
  - In-surface powered option comes with one grommet per table piece with 2 AC outlets, dual USB-A chargers, and a blank slot to add an optional HDMI, RJ11, or RJ45 (see [page 178](#) for more options)

**How to Specify:**

Table is sold with base

Each laminate comes with matching vinyl trim unless otherwise specified on the order cover sheet

Infill can match the paint finish of the A-leg or can be specified in a different finish

**Options:**

Widths: 72", 84", 96", 108", 120", 132", 144"

Depths: 42", 48"

Worksurface Laminate

A-Leg paint

A-Leg infill paint

Electrics

**Notes:**

Table corners have 4" radius

Table legs come with adjustable glides up to 1/2"

A-leg has removable infill for wire management capabilities

One of the A-Legs will come with an infill with a small hole to run wires out the bottom

Reinforcement bars have wire management capabilities

Optional Electrics

In-surface power+USB module available, offered in silver finish

Optional side-mount USB module, offered in black finish

**No Power**

Code	Price	H	W	D	Vol.	Wt.
H-MVAN-297242	2214	29	72	42	6	88
H-MVAN-297248	2334	29	72	48	7	100
H-MVAN-298442	2298	29	84	42	7	102
H-MVAN-298448	2424	29	84	48	8	117
H-MVAN-299642	2434	29	96	42	8	117
H-MVAN-299648	2567	29	96	48	9	134
H-MVAN-2910842	3715	29	108	42	9	132
H-MVAN-2910848	3827	29	108	48	10	150
H-MVAN-2912042	3884	29	120	42	10	146
H-MVAN-2912048	4000	29	120	48	12	167
H-MVAN-2913242	3956	29	132	42	11	161
H-MVAN-2913248	4067	29	132	48	13	184
H-MVAN-2914442	4096	29	144	42	12	175
H-MVAN-2914448	4208	29	144	48	14	200

**Power**

Code	Price	H	W	D	Vol.	Wt.
H-MVAP-297242	3181	29	72	42	6	88
H-MVAP-297248	3301	29	72	48	7	100
H-MVAP-298442	3265	29	84	42	7	102
H-MVAP-298448	3391	29	84	48	8	117
H-MVAP-299642	3402	29	96	42	8	117
H-MVAP-299648	3534	29	96	48	9	134
H-MVAP-2910842	6219	29	108	42	9	132
H-MVAP-2910848	6335	29	108	48	10	150
H-MVAP-2912042	6393	29	120	42	10	146
H-MVAP-2912048	6505	29	120	48	12	167
H-MVAP-2913242	6460	29	132	42	11	161
H-MVAP-2913248	6577	29	132	48	13	184
H-MVAP-2914442	6601	29	144	42	12	175
H-MVAP-2914448	6713	29	144	48	14	200

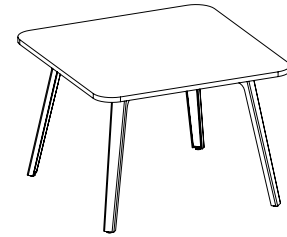

**What's Included:**

- 1" thick square top
- 4 A-legs with removable infill

**How to Specify:**

Table is sold with base

Each laminate comes with matching vinyl trim unless otherwise specified on the order cover sheet

Infill can match the paint finish of the A-leg or can be specified in a different finish

**Notes:**

Table corners have 4" radius

Table legs come with adjustable glides up to 1/2"

A-leg has removable infill for wire management capabilities

One of the A-Legs will come with an infill with a small hole to run wires out the bottom

**Options:**

Widths: 36", 42", 48"

Depths: 36", 42", 48"

Worksurface Laminate

A-Leg paint

A-Leg infill paint

Electrics

Code	Price	H	W	D	Volume	Weight
H-MSAN-293636	2092	29	36	36	3	38
H-MSAN-294242	2113	29	42	42	4	51
H-MSAN-294848	2130	29	48	48	5	67

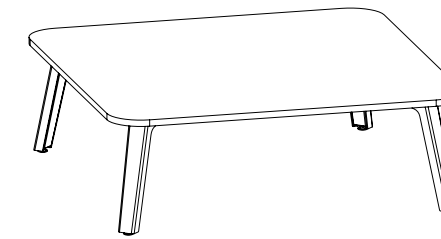

Coffee Table

**What's Included:**

- 3/4" thick square top
- 4 A-legs with infill

**How to Specify:**

Table is sold with base

Each laminate comes with matching vinyl trim unless otherwise specified on the order cover sheet

Infill can match the paint finish of the A-leg or can be specified in a different finish

**Notes:**

Table corners have 4" radius

Table legs come with adjustable glides up to 1/2"

A-leg has removable infill for wire management capabilities

**Options:**

Depths: 30", 36", 42", 48"

Height: 14"

Worksurface Laminate

A-Leg paint finish

A-Leg infill paint finish

Code	Price	H	W	D	Volume	Weight
H-TSAN-143030	1122	14	30	30	1	13
H-TSAN-143636	1159	14	36	36	1	18
H-TSAN-144242	1279	14	42	42	2	25
H-TSAN-144848	1311	14	48	48	2	32



**What's Included:**

- 1" circle top
- 3 A-legs with removable infill

**How to Specify:**

Table is sold with base

Each laminate comes with matching vinyl trim unless otherwise specified on the order cover sheet

Infill can match the paint finish of the A-leg or can be specified in a different finish

**Notes:**

Table corners have 4" radius

Table legs come with adjustable glides up to 1/2"

A-leg has removable infill for wire management capabilities

One of the A-Legs will come with an infill with a small hole to run wires out the bottom

**Options:**

Widths: 36", 42", 48"

Depths: 36", 42", 48"

Worksurface Laminate

A-Leg paint

A-Leg infill paint

Electrics

Code	Price	H	W	D	Volume	Weight
H-MOAN-293636	1529	29	36	36	3	38
H-MOAN-294242	1751	29	42	42	4	51
H-MOAN-294848	1766	29	48	48	5	67

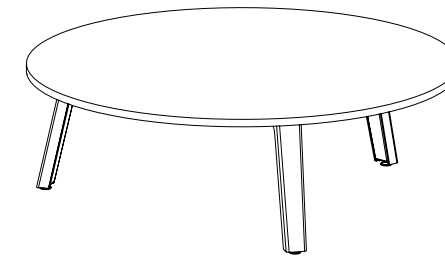

Coffee Table

**What's Included:**

- 3/4" thick circle top
- 3 A-legs with infill

**How to Specify:**

Table is sold with base

Each laminate comes with matching vinyl trim unless otherwise specified on the order cover sheet

Infill can match the paint finish of the A-leg or can be specified in a different finish

**Notes:**

Table corners have 4" radius

Table legs come with adjustable glides up to 1/2"

A-leg has removable infill for wire management capabilities

**Options:**

Depths: 30", 36", 42", 48"

Height: 14"

Worksurface Laminate

A-Leg paint finish

A-Leg infill paint finish

Code	Price	H	W	D	Volume	Weight
H-TOAN-143030	914	14	30	30	1	13
H-TOAN-143636	1037	14	36	36	1	18
H-TOAN-144242	1073	14	42	42	2	25
H-TOAN-144848	1103	14	48	48	2	32



**What's Included:**

- 1" squircle top
- 4 A-legs with removable infill

**How to Specify:**

Table is sold with base

Each laminate comes with matching vinyl trim unless otherwise specified on the order cover sheet

Infill can match the paint finish of the A-leg or can be specified in a different finish

**Notes:**

Table corners have 4" radius

Table legs come with adjustable glides up to 1/2"

A-leg has removable infill for wire management capabilities

One of the A-Legs will come with an infill with a small hole to run wires out the bottom

**Options:**

Widths: 36", 42", 48"

Depths: 36", 42", 48"

Worksurface Laminate

A-Leg paint

A-Leg infill paint

Electrics

Code	Price	H	W	D	Volume	Weight
H-MQAN-293636	1946	29	36	36	3	38
H-MQAN-294242	2167	29	42	42	4	51
H-MQAN-294848	2180	29	48	48	5	67

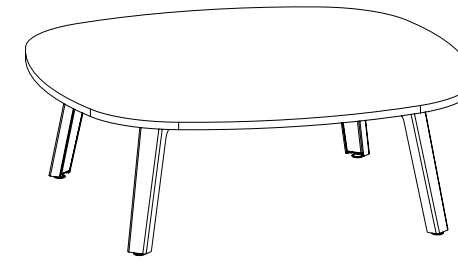

Coffee Table

**What's Included:**

- 3/4" thick squircle top
- 4 A-legs with infill

**How to Specify:**

Table is sold with base

Each laminate comes with matching vinyl trim unless otherwise specified on the order cover sheet

Infill can match the paint finish of the A-leg or can be specified in a different finish

**Notes:**

Table corners have 4" radius

Table legs come with adjustable glides up to 1/2"

A-leg has removable infill for wire management capabilities

**Options:**

Depths: 30", 36", 42", 48"

Height: 14"

Worksurface Laminate

A-Leg paint finish

A-Leg infill paint finish

Code	Price	H	W	D	Volume	Weight
H-TQAN-143030	1146	14	30	30	1	13
H-TQAN-143636	1272	14	36	36	1	18
H-TQAN-144242	1305	14	42	42	2	25
H-TQAN-144848	1339	14	48	48	2	32





**What's Included:**

- 1" trilobe top
- 3 A-legs with removable infill

**How to Specify:**

Table is sold with base

Each laminate comes with matching vinyl trim unless otherwise specified on the order cover sheet

Infill can match the paint finish of the A-leg or can be specified in a different finish

**Notes:**

Table corners have 4" radius

Table legs come with adjustable glides up to 1/2"

A-leg has removable infill for wire management capabilities

One of the A-Legs will come with an infill with a small hole to run wires out the bottom

**Options:**

Widths: 36", 42", 48"

Depths: 36", 42", 48"

Worksurface Laminate

A-Leg paint

A-Leg infill paint

Electrics

Code	Price	H	W	D	Volume	Weight
H-MTAN-293636	1529	29	36	36	3	38
H-MTAN-294242	1751	29	42	42	4	51
H-MTAN-294848	1766	29	48	48	4	51

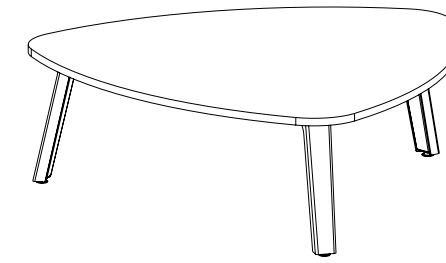

Coffee Table

**What's Included:**

- 3/4" thick trilobe top
- 3 A-legs with infill

**How to Specify:**

Table is sold with base

Each laminate comes with matching vinyl trim unless otherwise specified on the order cover sheet

Infill can match the paint finish of the A-leg or can be specified in a different finish

**Notes:**

Table corners have 4" radius

Table legs come with adjustable glides up to 1/2"

A-leg has removable infill for wire management capabilities

**Options:**

Depths: 30", 36", 42", 48"

Height: 14"

Worksurface Laminate

A-Leg paint finish

A-Leg infill paint finish

Code	Price	H	W	D	Volume	Weight
H-TTAN-143030	914	14	30	30	1	13
H-TTAN-143636	1037	14	36	36	1	18
H-TTAN-144242	1073	14	42	42	2	25
H-TTAN-144848	1103	14	48	48	2	32

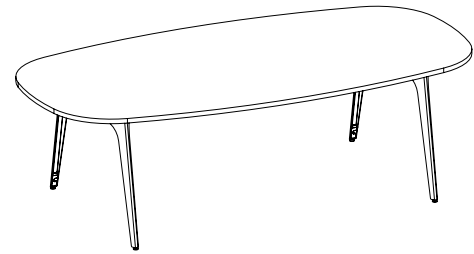

No Power



With Power

**What's Included:**

- 1" thick super ellipse top
- 4 V-legs with magnetic wire escape
- Reinforcement bar(s)
- Optional Electrics

In-surface powered option comes with one grommet per table piece with 2 AC outlets, dual USB-A chargers, and a blank slot to add an optional HDMI, RJ11, or RJ45 (see [page 178](#) for more options)

If in-surface power option is specified, wire management strips are included in the V-legs

Side-mount USB option comes with 2 USB-A chargers (see [page 178](#) for more options)

**How to Specify:**

Table is sold with base

Each laminate comes with matching vinyl trim unless otherwise specified on the order cover sheet

**Notes:**

Table corners have 4" radius

Table legs come with adjustable glides up to 1/2"

48" and 54"W are finish offered in 30"D

Magnetic wire escape offered in charcoal finish

Reinforcement bars have wire management capabilities

Optional Electrics

In-surface power+USB module available, offered in silver finish

Optional side-mount USB module, offered in black finish

**Options:**

Depths: 36", 42", 48"

Widths: 72", 84", 96"

Height: 42"

Worksurface Laminate

V-leg paint finish

**No Power**

Code	Price	H	W	D	Vol.	Wt.
H-MEVN-427242	2726	42	72	42	8.4	120.96
H-MEVN-427248	2741	42	72	48	9.6	138.24
H-MEVN-428442	2824	42	84	42	9.8	141.12
H-MEVN-428448	2838	42	84	48	11.2	161.28
H-MEVN-429642	2961	42	96	42	11.2	161.28
H-MEVN-429648	2974	42	96	48	12.8	184.32

**Power**

Code	Price	H	W	D	Vol.	Wt.
H-MEVP-427242	3693	42	72	42	8.4	120.96
H-MEVP-427248	3707	42	72	48	9.6	138.24
H-MEVP-428442	3788	42	84	42	8.4	141.12
H-MEVP-428448	3804	42	84	48	11.2	161.28
H-MEVP-429642	3927	42	96	42	11.2	161.28
H-MEVP-429648	3942	42	96	48	12.8	184.32

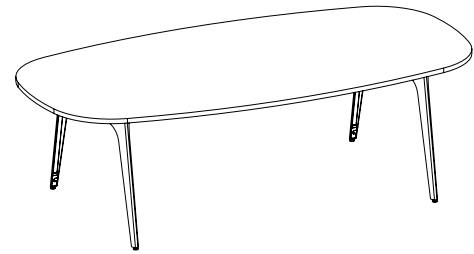

No Power



With Power

**What's Included:**

- 1" thick super ellipse top
- 4 V-legs with magnetic wire escape
- Reinforcement bar(s)
- Optional Electrics

In-surface powered option comes with one grommet per table piece with 2 AC outlets, dual USB-A chargers, and a blank slot to add an optional HDMI, RJ11, or RJ45 (see [page 178](#) for more options)

If in-surface power option is specified, wire management strips are included in the V-legs

Side-mount USB option comes with 2 USB-A chargers (see [page 178](#) for more options)

**How to Specify:**

Table is sold with base

Each laminate comes with matching vinyl trim unless otherwise specified on the order cover sheet

**Notes:**

Table corners have 4" radius

Table legs come with adjustable glides up to 1/2"

48" and 54"W are finish offered in 30"D

Magnetic wire escape offered in charcoal finish

Reinforcement bars have wire management capabilities

Optional Electrics

In-surface power+USB module available, offered in silver finish

Optional side-mount USB module, offered in black finish

**Options:**

Depths: 36", 42" 48"

Widths: 72", 84", 96"

Height: 29"

Worksurface Laminate

V-leg paint finish

**No Power**

Code	Price	H	W	D	Vol.	Wt.
H-MEVN-297236	2272	29	72	36	5	75
H-MEVN-297242	2432	29	72	42	6	88
H-MEVN-297248	2445	29	72	48	7	100
H-MEVN-298436	2340	29	84	36	6	88
H-MEVN-298442	2529	29	84	42	7	102
H-MEVN-298448	2543	29	84	48	8	117
H-MEVN-299636	2452	29	96	36	7	100
H-MEVN-299642	2666	29	96	42	8	117
H-MEVN-299648	2682	29	96	48	9	134

**Power**

Code	Price	H	W	D	Vol.	Wt.
H-MEVP-297236	3237	29	72	36	5	75
H-MEVP-297242	3399	29	72	42	6	88
H-MEVP-297248	3413	29	72	48	6	88
H-MEVP-298436	3308	29	84	36	6	88
H-MEVP-298442	3496	29	84	42	6	88
H-MEVP-298448	3510	29	84	48	8	117
H-MEVP-299636	3420	29	96	36	7	100
H-MEVP-299642	3633	29	96	42	8	117
H-MEVP-299648	3647	29	96	48	9	134

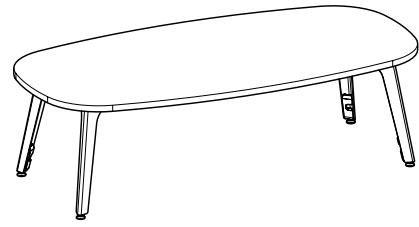

**What's Included:**

- 3/4" thick super ellipse top
- 4 V-legs with magnetic wire escape

**How to Specify:**

Table is sold with base

Each laminate comes with matching vinyl trim unless otherwise specified on the order cover sheet

**Notes:**

Table corners have 4" radius

Table legs come with adjustable glides up to 1/2"

Magnetic wire escape offered in charcoal finish

**Options:**

24"D: Widths: 36", 42", 48", 54", 60"

30"D: Widths: 48", 54", 60"

36"D: Widths: 60"

Height: 14"

Worksurface Laminate

V-leg paint finish

Code	Price	H	W	D	Volume	Weight
H-TEVN-143624	871	14	36	24	1	12
H-TEVN-144224	883	14	42	24	1	14
H-TEVN-144824	898	14	48	24	1	16
H-TEVN-144830	928	14	48	30	1	20
H-TEVN-145424	912	14	54	24	1	18
H-TEVN-145430	944	14	54	30	2	23
H-TEVN-146024	930	14	60	24	1	20
H-TEVN-146030	960	14	60	24	1	20
H-TEVN-146036	1134	14	60	36	2	30

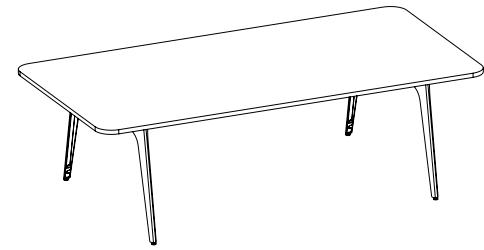

No Power



With Power

**What's Included:**

- 1" thick rectangular top
- 4 V-legs with magnetic wire escape
- Reinforcement bar(s)
- Optional Electrics
  - In-surface powered option comes with one grommet per table piece with 2 AC outlets, dual USB-A chargers, and a blank slot to add an optional HDMI, RJ11, or RJ45 (see [page 178](#) for more options)
  - If in-surface power option is specified, wire management strips are included in the V-legs
  - Side-mount USB option comes with 2 USB-A chargers (see [page 178](#) for more options)

**Notes:**

- Table corners have 4" radius
- Table legs come with adjustable glides up to 1/2"
- 48" and 54"W are finish offered in 30"D
- Magnetic wire escape offered in charcoal finish
- Reinforcement bars have wire management capabilities
- Optional Electrics
  - In-surface power+USB module available, offered in silver finish
  - Optional side-mount USB module, offered in black finish

**How to Specify:**

Table is sold with base

Each laminate comes with matching vinyl trim unless otherwise specified on the order cover sheet

**Options:**

Depths:	36", 42" 48"
Widths:	60", 72", 84", 96"
Height:	42"
Worksurface Laminate	
V-leg paint finish	

**No Power**

Code	Price	H	W	D	Vol.	Wt.
H-MRVN-426036	2471	42	60	36	6	86
H-MRVN-426042	2605	42	60	42	7	101
H-MRVN-426048	2620	42	60	48	8	115
H-MRVN-427236	2540	42	72	36	7	104
H-MRVN-427242	2702	42	72	42	8	121
H-MRVN-427248	2717	42	72	48	10	138
H-MRVN-428436	2650	42	84	36	8	121
H-MRVN-428442	2839	42	84	42	10	141
H-MRVN-428448	2853	42	84	48	11	161
H-MRVN-429636	2760	42	96	36	10	138
H-MRVN-429642	2973	42	96	42	11	161
H-MRVN-429648	2988	42	96	48	11	161

**Power**

Code	Price	H	W	D	Vol.	Wt.
H-MRVP-426036	3435	42	60	36	6	86
H-MRVP-426042	3572	42	60	42	6	101
H-MRVP-426048	3585	42	60	48	8	115
H-MRVP-427236	3507	42	72	36	7	104
H-MRVP-427242	3669	42	72	42	8	121
H-MRVP-427248	3683	42	72	48	10	138
H-MRVP-428436	3619	42	84	36	8	121
H-MRVP-428442	3807	42	84	42	10	141
H-MRVP-428448	3821	42	84	48	11	161
H-MRVP-429636	3727	42	96	36	11	138
H-MRVP-429642	3941	42	96	42	11	161
H-MRVP-429648	3956	42	96	48	13	184

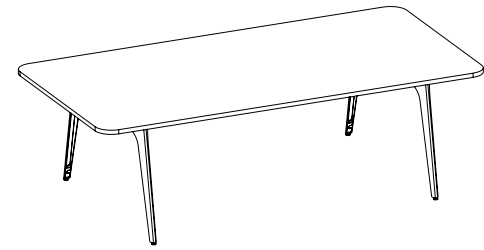

No Power



With Power

**What's Included:**

- 1" thick rectangular top
- 4 V-legs with magnetic wire escape
- Reinforcement bar(s)
- Optional Electrics

In-surface powered option comes with one grommet per table piece with 2 AC outlets, dual USB-A chargers, and a blank slot to add an optional HDMI, RJ11, or RJ45 (see [page 178](#) for more options)

If in-surface power option is specified, wire management strips are included in the V-legs

Side-mount USB option comes with 2 USB-A chargers (see [page 178](#) for more options)

**Notes:**

Table corners have 4" radius

Table legs come with adjustable glides up to 1/2"

48" and 54"W are finish offered in 30"D

Magnetic wire escape offered in charcoal finish

Reinforcement bars have wire management capabilities

Optional Electrics

In-surface power+USB module available, offered in silver finish

Optional side-mount USB module, offered in black finish

**How to Specify:**

Table is sold with base

Each laminate comes with matching vinyl trim unless otherwise specified on the order cover sheet

**Options:**

30"D: Widths: 60"

36",42",48"D: Widths: 60", 72", 84", 96"

Height: 29"

Worksurface Laminate

V-leg paint finish

**No Power**

Code	Price	H	W	D	Vol.	Wt.
H-MRVN-296030	2141	29	60	30	4	52
H-MRVN-296036	2175	29	60	36	4	63
H-MRVN-296042	2311	29	60	42	5	73
H-MRVN-296048	2325	29	60	48	6	84
H-MRVN-297230	2176	29	72	30	4	63
H-MRVN-297236	2217	29	72	36	5	75
H-MRVN-297242	2379	29	72	42	6	88
H-MRVN-297248	2395	29	72	48	7	100
H-MRVN-298430	2240	29	84	30	5	73
H-MRVN-298436	2288	29	84	36	6	88
H-MRVN-298442	2476	29	84	42	7	102
H-MRVN-298448	2490	29	84	48	8	117
H-MRVN-299630	2345	29	96	30	6	84
H-MRVN-299636	2399	29	96	36	7	100
H-MRVN-299642	2615	29	96	42	8	117
H-MRVN-299648	2627	29	96	48	9	134

**Power**

Code	Price	H	W	D	Vol.	Wt.
H-MRVP-296030	3109	29	60	30	4	52
H-MRVP-296036	3143	29	60	36	4	63
H-MRVP-296042	3278	29	60	42	5	73
H-MRVP-296048	3291	29	60	48	6	84
H-MRVP-297230	3144	29	72	30	4	63
H-MRVP-297236	3183	29	72	36	5	75
H-MRVP-297242	3347	29	72	42	6	88
H-MRVP-297248	3361	29	72	48	7	100
H-MRVP-298430	3209	29	84	30	5	73
H-MRVP-298436	3255	29	84	36	6	88
H-MRVP-298442	3443	29	84	42	7	102
H-MRVP-298448	3457	29	84	48	8	117
H-MRVP-299630	3313	29	96	30	6	84
H-MRVP-299636	3366	29	96	36	7	100
H-MRVP-299642	3579	29	96	42	8	117
H-MRVP-299648	3594	29	96	48	9	134

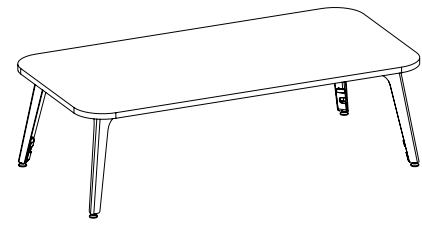

**What's Included:**

- 3/4" thick rectangular top
- 4 V-legs with magnetic wire escape

**How to Specify:**

Table is sold with base

Each laminate comes with matching vinyl trim unless otherwise specified on the order cover sheet

**Notes:**

Table corners have 4" radius

Table legs come with adjustable glides up to 1/2"

Magnetic wire escape offered in charcoal finish

**Options:**

24"D: Widths: 36", 42", 48", 54", 60"

30"D: Widths: 48", 54", 60"

36"D: Widths: 60"

Height: 14"

Worksurface Laminate

V-leg paint finish

Code	Price	H	W	D	Volume	Weight
H-TRVN-143624	843	14	36	24	1	12
H-TRVN-144224	857	14	42	24	1	14
H-TRVN-144824	873	14	48	24	1	16
H-TRVN-144830	899	14	48	30	1	20
H-TRVN-145424	887	14	54	24	1	18
H-TRVN-145430	919	14	54	30	2	23
H-TRVN-146024	900	14	60	24	1	20
H-TRVN-146030	935	14	60	30	2	25
H-TRVN-146036	970	14	60	36	2	30

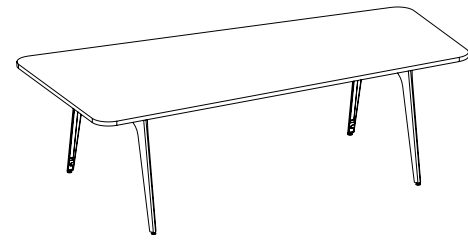

No Power

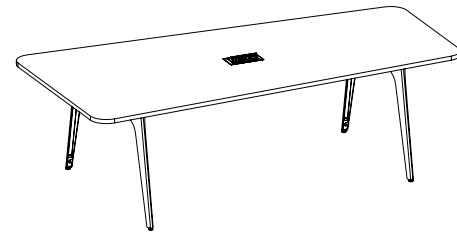

With Power

**What's Included:**

- 1" thick video top
- 4 V-legs with magnetic wire escape
- Reinforcement bar(s)
- Optional Electrics

In-surface powered option comes with one grommet per table piece with 2 AC outlets, dual USB-A chargers, and a blank slot to add an optional HDMI, RJ11, or RJ45 (see [page 178](#) for more options)

If in-surface power option is specified, wire management strips are included in the V-legs

Side-mount USB option comes with 2 USB-A chargers (see [page 178](#) for more options)

**How to Specify:**

Table is sold with base

Each laminate comes with matching vinyl trim unless otherwise specified on the order cover sheet

**Notes:**

Table corners have 4" radius

Table legs come with adjustable glides up to 1/2"

48" and 54"W are finish offered in 30"D

Magnetic wire escape offered in charcoal finish

Reinforcement bars have wire management capabilities

Optional Electrics

In-surface power+USB module available, offered in silver finish

Optional side-mount USB module, offered in black finish

**Options:**

Depths: 48"

Widths: 72", 84", 96"

Height: 42"

Worksurface Laminate

V-leg paint finish

**No Power**

Code	Price	H	W	D	Vol.	Wt.
H-MVFN-427248	2757	42	72	48	10	138
H-MVFN-428448	2893	42	84	48	11	161
H-MVFN-429648	3027	42	96	48	11	161

**Power**

Code	Price	H	W	D	Vol.	Wt.
H-MVFP-427248	3721	42	72	48	10	138
H-MVFP-428448	3860	42	84	48	11	161
H-MVFP-429648	3995	42	96	48	13	184



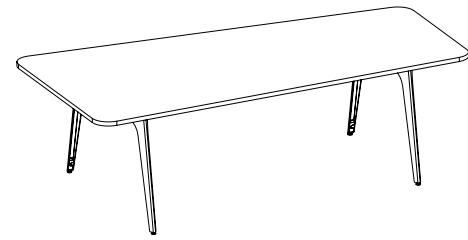

No Power

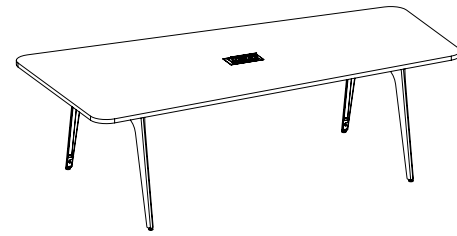

With Power

**What's Included:**

- 1" thick video top
- 4 V-legs with magnetic wire escape
- Reinforcement bar(s)
- Optional Electrics

In-surface powered option comes with one grommet per table piece with 2 AC outlets, dual USB-A chargers, and a blank slot to add an optional HDMI, RJ11, or RJ45 (see [page 178](#) for more options)

If in-surface power option is specified, wire management strips are included in the V-legs

Side-mount USB option comes with 2 USB-A chargers (see [page 178](#) for more options)

**How to Specify:**

Table is sold with base

Each laminate comes with matching vinyl trim unless otherwise specified on the order cover sheet

**Notes:**

Table corners have 4" radius

Table legs come with adjustable glides up to 1/2"

48" and 54"W are finish offered in 30"D

Magnetic wire escape offered in charcoal finish

Reinforcement bars have wire management capabilities

Optional Electrics

In-surface power+USB module available, offered in silver finish

Optional side-mount USB module, offered in black finish

**Options:**

Depths: 42", 48"D

Widths: 72", 84", 96"

Height: 29

Worksurface Laminate

V-leg paint finish

**No Power**

Code	Price	H	W	D	Vol.	Wt.
H-MVVN-297242	2432	29	72	42	6	88
H-MVVN-297248	2445	29	72	48	7	100
H-MVVN-298442	2529	29	84	42	7	102
H-MVVN-298448	2543	29	84	48	8	117
H-MVVN-299642	2666	29	96	42	8	117
H-MVVN-299648	2682	29	96	48	9	134

**Power**

Code	Price	H	W	D	Vol.	Wt.
H-MVVP-297242	3399	29	72	42	6	88
H-MVVP-297248	3413	29	72	48	7	100
H-MVVP-298442	3496	29	84	42	7	102
H-MVVP-298448	3510	29	84	48	13	117
H-MVVP-299642	3633	29	96	42	8	117
H-MVVP-299648	3647	29	96	48	8	117

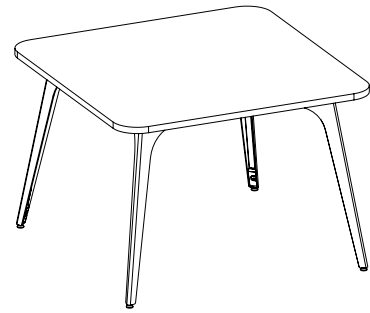

**What's Included:**

- 1" thick square top
- 4 V-legs with magnetic wire escape

**How to Specify:**

Table is sold with base

Each laminate comes with matching vinyl trim unless otherwise specified on the order cover sheet

**Options:**

Widths: 36", 42", 48"

Depths: 36", 42", 48"

Worksurface Laminate

V-Leg Paint Finish

**Notes:**

Table corners have 4" radius

Table legs come with adjustable glides up to 1/2"

48" and 54"W are finish offered in 30"D

Magnetic wire escape offered in charcoal finish

Code	Price	H	W	D	Volume	Weight
H-MSVN-293636	1673	29	36	36	3	38
H-MSVN-294242	1751	29	42	42	3	38
H-MSVN-294848	1827	29	48	48	5	67

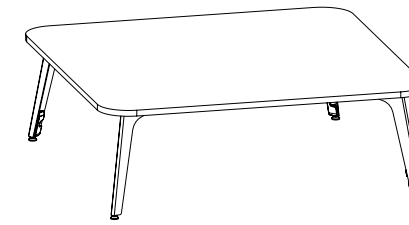

**What's Included:**

- 3/4" thick square top
- 4 V-legs with magnetic wire escape

**How to Specify:**

Table is sold with base

Each laminate comes with matching vinyl trim unless otherwise specified on the order cover sheet

**Options:**

Depths: 30", 36", 42", 48"

Height: 14"

Worksurface Laminate

V-leg paint finish

**Notes:**

Table corners have 4" radius

Table legs come with adjustable glides up to 1/2"

Magnetic wire escape offered in charcoal finish

Code	Price	H	W	D	Volume	Weight
H-TSVN-143030	847	14	30	30	1	13
H-TSVN-143636	886	14	36	36	1	18
H-TSVN-144242	1003	14	42	42	2	25
H-TSVN-144848	1037	14	48	48	2	32



**What's Included:**

- 1" thick circle top
- 3 V-legs with magnetic wire escape

**How to Specify:**

Table is sold with base

Each laminate comes with matching vinyl trim unless otherwise specified on the order cover sheet

**Notes:**

Table corners have 4" radius  
 Table legs come with adjustable glides up to 1/2"  
 48" and 54"W are finish offered in 30"D  
 Magnetic wire escape offered in charcoal finish

**Options:**

Widths: 36", 42", 48"

Depths: 36", 42", 48"

Worksurface Laminate

V-Leg Paint Finish

Code	Price	H	W	D	Volume	Weight
H-MOVN-293636	1365	29	36	36	3	38
H-MOVN-294242	1484	29	42	42	3	38
H-MOVN-294848	1520	29	48	48	5	67

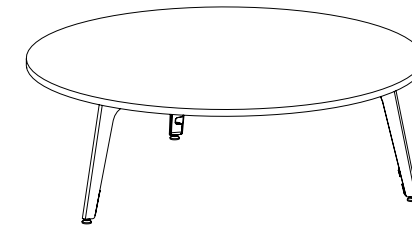

**What's Included:**

- 3/4" thick circle top
- 3 V-legs with magnetic wire escape

**How to Specify:**

Table is sold with base

Each laminate comes with matching vinyl trim unless otherwise specified on the order cover sheet

**Notes:**

Table corners have 4" radius  
 Table legs come with adjustable glides up to 1/2"  
 Magnetic wire escape offered in charcoal finish

**Options:**

Depths: 30", 36", 42", 48"

Height: 14"

Worksurface Laminate

V-leg paint finish

Code	Price	H	W	D	Volume	Weight
H-TOVN-143030	708	14	30	30	1	13
H-TOVN-143636	832	14	36	36	1	18
H-TOVN-144242	864	14	42	42	2	25
H-TOVN-144848	898	14	48	48	2	32



**What's Included:**

- 1" thick squircle top
- 4 V-legs with magnetic wire escape

**How to Specify:**

Table is sold with base

Each laminate comes with matching vinyl trim unless otherwise specified on the order cover sheet

**Notes:**

- Table corners have 4" radius
- Table legs come with adjustable glides up to 1/2"
- Magnetic wire escape offered in charcoal finish

**Options:**

Widths: 36", 42", 48"

Depths: 36", 42", 48"

Worksurface Laminate

V-Leg Paint Finish

Code	Price	H	W	D	Volume	Weight
H-MQVN-293636	1728	29	36	36	3	38
H-MQVN-294242	1846	29	42	42	4	51
H-MQVN-294848	1879	29	48	48	4	51

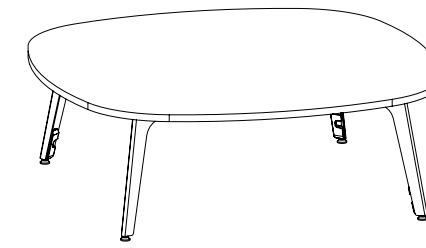

**What's Included:**

- 3/4" thick squircle top
- 4 V-legs with magnetic wire escape

**How to Specify:**

Table is sold with base

Each laminate comes with matching vinyl trim unless otherwise specified on the order cover sheet

**Notes:**

- Table corners have 4" radius
- Table legs come with adjustable glides up to 1/2"
- Magnetic wire escape offered in charcoal finish

**Options:**

Depths: 30", 36", 42", 48"

Height: 14"

Worksurface Laminate

V-leg paint finish

Code	Price	H	W	D	Volume	Weight
H-TQVN-143030	873	14	30	30	1	13
H-TQVN-143636	996	14	36	36	1	18
H-TQVN-144242	1030	14	42	42	2	25
H-TQVN-144848	1064	14	48	48	2	32



**What's Included:**

- 1" thick trilobe top
- 3 V-legs with magnetic wire escape

**How to Specify:**

Table is sold with base

Each laminate comes with matching vinyl trim unless otherwise specified on the order cover sheet

**Options:**

Widths: 36", 42", 48"

Depths: 36", 42", 48"

Worksurface Laminate

V-Leg Paint Finish

**Notes:**

Table corners have 4" radius

Table legs come with adjustable glides up to 1/2"

Magnetic wire escape offered in charcoal finish

Code	Price	H	W	D	Volume	Weight
H-MTVN-293636	1365	29	36	36	3	38
H-MTVN-294242	1484	29	42	42	4	51
H-MTVN-294848	1520	29	48	48	5	67

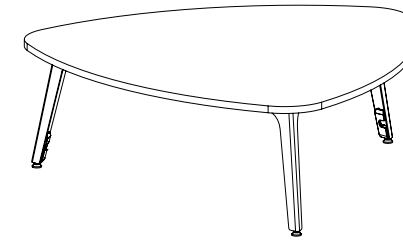

**What's Included:**

- 3/4" thick trilobe top
- 3 V-legs with magnetic wire escape

**How to Specify:**

Table is sold with base

Each laminate comes with matching vinyl trim unless otherwise specified on the order cover sheet

**Options:**

Depths: 30", 36", 42", 48"

Height: 14"

Worksurface Laminate

V-leg paint finish

**Notes:**

Table corners have 4" radius

Table legs come with adjustable glides up to 1/2"

Magnetic wire escape offered in charcoal finish

Code	Price	H	W	D	Volume	Weight
H-TTVN-143030	873	14	30	30	1	13
H-TTVN-143636	996	14	36	36	1	18
H-TTVN-144242	1030	14	42	42	2	25
H-TTVN-144848	1064	14	48	48	2	32



Halifax Pricebook  
May 2023  
**Desking**

Freestanding	
A-Leg	60
V-Leg	62
Hanging Pedestal	64
Low Credenza Mount	
A-Leg Hutch & Gallery Wall	66
A-Leg Short Gable	68
V-Leg Hutch & Gallery Wall	70
V-Leg Short Gable	72
No Leg Hutch & Gallery Wall	74
No Leg Short Gable	76
High Credenza Mount	
A leg	78
V leg	80
Height Adjustable Table	82
Suspended Pedestal	84
Credenza integrated	86
Credenza & Pedestal	88
Worksurface	
No Grommet	90
w/ Grommet	92
Bridge	94
Reinforcement Bar	96
Modesty	98
Worksurface Support & Hardware	100
Table Support	102

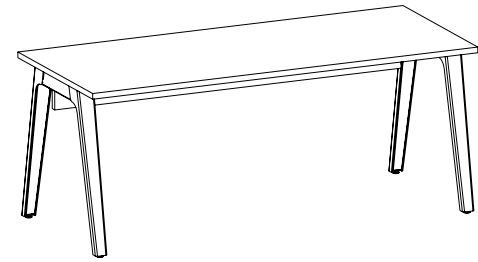

A-Leg No Grommet

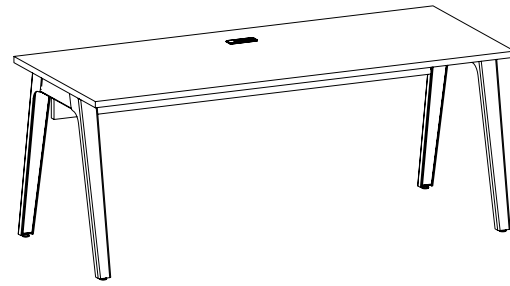

A-Leg With Grommet

**What's Included:**

- Worksurface
- 2 A-leg gables
- reinforcement bar
- modesty

**Notes:**

One of the A-Legs will come with an infill with a small hole to run wires out the bottom

**Options:**

Widths: 60", 66", 72", 78", 84"

Depths: 30"

Laminate

Paint Finish

Electrics

A-Leg

Code	Price	H	W	D	Volume	Weight
<b>No Grommet</b>						
H-TFAN-296030	2355	29	60	30	5	61
H-TFAN-296630	2404	29	66	30	6	68
H-TFAN-297230	2454	29	72	30	6	74
H-TFAN-297830	2529	29	78	30	7	80
H-TFAN-298430	2558	29	84	30	7	86
<b>w/ Grommet</b>						
H-TFAH-296030	2360	29	60	30	5	61
H-TFAH-296630	2408	29	66	30	6	68
H-TFAH-297230	2460	29	72	30	6	74
H-TFAH-297830	2533	29	78	30	7	80
H-TFAH-298430	2562	29	84	30	7	86



V-Leg No Grommet



V-Leg With Grommet

What's Included:

- Worksurface
- 2 A-leg gables
- reinforcement bar
- modesty

Notes:

Options:

Widths: 60", 66", 72", 78", 84"

---

Depths: 30"

---

Laminate

---

Paint Finish

---

Electrics

---

V-Leg

Code	Price	H	W	D	Vol.	Wt.
<b>No Grommet</b>						
H-TFVN-296030	2180	29	60	30	5	61
H-TFVN-296630	2200	29	66	30	6	68
H-TFVN-297230	2229	29	72	30	6	74
H-TFVN-297830	2278	29	78	30	7	80
H-TFVN-298430	2302	29	84	30	7	86
<b>w/ Grommet</b>						
H-TFVH-296030	2186	29	60	30	5	61
H-TFVH-296630	2203	29	66	30	6	68
H-TFVH-297230	2233	29	72	30	6	74
H-TFVH-297830	2283	29	78	30	7	80
H-TFVH-298430	2309	29	84	30	7	86



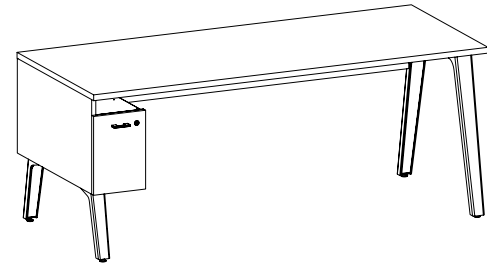

no Grommet

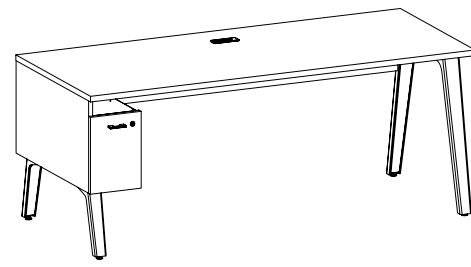

With Grommet

**What's Included:**

- Desk with a hanging pedestal with A-Leg

**How to Specify:**

Hanging pedestal on RH or LH

**Notes:**

Hanging pedestal has a 9-1/2"W file drawer

**Options:**

Widths: 60", 66", 72"

Depths: 30"

Laminate

Paint Finish

Electrics

**A-Leg**

Code	Price	H	W	D	Volume	Weight
<b>No Grommet</b>						
H-TSAN-296030-L	2928	29	60	30	5	61
H-TSAN-296630-L	2954	29	66	30	6	68
H-TSAN-297230-L	3014	29	72	30	6	74
H-TSAN-296030-R	2928	29	60	30	5	61
H-TSAN-296630-R	2954	29	66	30	6	68
H-TSAN-297230-R	3014	29	72	30	6	74
<b>w/ Grommet</b>						
H-TSAH-296030-L	2933	29	60	30	5	61
H-TSAH-296630-L	2959	29	66	30	6	68
H-TSAH-297230-L	3016	29	72	30	6	74
H-TSAH-296030-R	2933	29	60	30	5	61
H-TSAH-296630-R	2959	29	66	30	6	68
H-TSAH-297230-R	3016	29	72	30	6	74

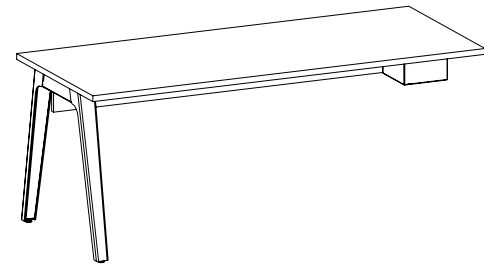

no Grommet

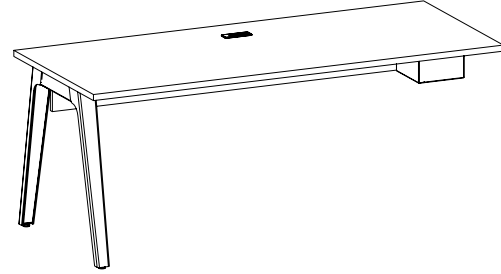

With Grommet

**What's Included:**

- Worksurface
- Modesty
- A-leg
- Reinforcement bar
- Credenza mounting box

**How to Specify:**

**Notes:**

Application is for layout with a freestanding hutch or a gallery wall

One of the A-Legs will come with an infill with a small hole to run wires out the bottom

**Options:**

Widths: 60", 66", 72", 78", 84"

Depths: 30"

Laminate

Paint Finish

Electrics

Code	Price	H	W	D	Volume	Weight
<b>w/ Grommet</b>						
H-TLAN-296030-L	1848	29	60	30	5.0	61
H-TLAN-296630-L	1898	29	66	30	6.0	68
H-TLAN-297230-L	1949	29	72	30	6.0	74
H-TLAN-297830-L	2023	29	78	30	7.0	80
H-TLAN-298430-L	2048	29	84	30	7.0	86
H-TLAN-296030-R	1848	29	60	30	5.0	61
H-TLAN-296630-R	1898	29	66	30	6.0	68
H-TLAN-297230-R	1949	29	72	30	6.0	74
H-TLAN-297830-R	2023	29	78	30	7.0	80
H-TLAN-298430-R	2048	29	84	30	7.0	86
<b>No Grommet</b>						
H-TLAH-296030-L	1852	29	60	30	5.0	61
H-TLAH-296630-L	1902	29	66	30	6.0	68
H-TLAH-297230-L	1953	29	72	30	6.0	74
H-TLAH-297830-L	2027	29	78	30	7.0	80
H-TLAH-298430-L	2053	29	84	30	7.0	86
H-TLAH-296030-R	1852	29	60	30	5.0	61
H-TLAH-296630-R	1902	29	66	30	6.0	68
H-TLAH-297230-R	1953	29	72	30	6.0	74
H-TLAH-297830-R	2027	29	78	30	7.0	80
H-TLAH-298430-R	2053	29	84	30	7.0	86

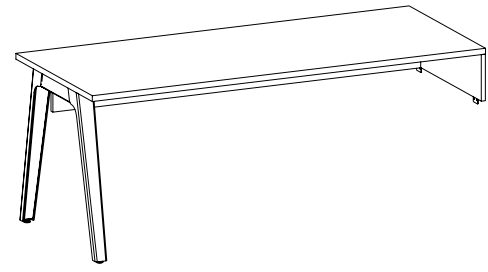

no Grommet

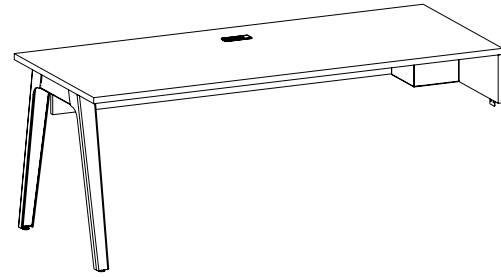

With Grommet

**What's Included:**

- Worksurface
- Short Gable
- Modesty
- A-leg
- Reinforcement bar
- Credenza mounting box

**How to Specify:**

**Notes:**

Application is for layout that does not include a freestanding hutch or a gallery wall  
 One of the A-Legs will come with an infill with a small hole to run wires out the bottom

**Options:**

Widths: 60", 66", 72", 78", 84"

Depths: 30"

Laminate

Paint Finish

Electrics

Code	Price	H	W	D	Volume	Weight
<b>No Grommet</b>						
H-TLSAN-296030-GL	1955	29	60	30	5.0	61
H-TLSAN-296630-GL	2004	29	66	30	6.0	68
H-TLSAN-297230-GL	2056	29	72	30	6.0	74
H-TLSAN-297830-GL	2130	29	78	30	7.0	80
H-TLSAN-298430-GL	2156	29	84	30	7.0	86
H-TLSAN-296030-GR	1955	29	60	30	5.0	61
H-TLSAN-296630-GR	2004	29	66	30	6.0	68
H-TLSAN-297230-GR	2056	29	72	30	6.0	74
H-TLSAN-297830-GR	2130	29	78	30	7.0	80
H-TLSAN-298430-GR	2156	29	84	30	7.0	86
<b>w/ Grommet</b>						
H-TLSAH-296030-GL	1958	29	60	30	5.0	61
H-TLSAH-296630-GL	2008	29	66	30	6.0	68
H-TLSAH-297230-GL	2060	29	72	30	6.0	74
H-TLSAH-297830-GL	2134	29	78	30	7.0	80
H-TLSAH-298430-GL	2162	29	84	30	7.0	86
H-TLSAH-296030-GR	1958	29	60	30	5.0	61
H-TLSAH-296630-GR	2008	29	66	30	6.0	68
H-TLSAH-297230-GR	2060	29	72	30	6.0	74
H-TLSAH-297830-GR	2134	29	78	30	7.0	80
H-TLSAH-298430-GR	2162	29	84	30	7.0	86

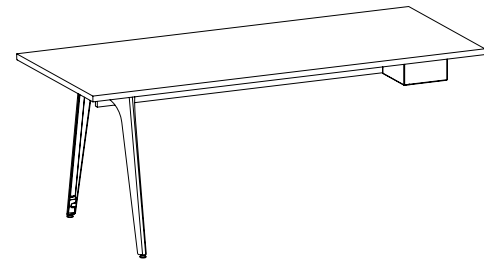

no Grommet

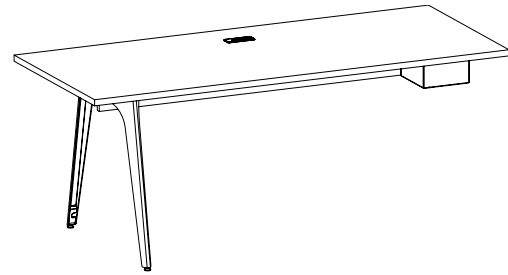

With Grommet

**What's Included:**

- Worksurface
- Modesty
- V-leg
- Reinforcement bar
- Credenza mounting box

**How to Specify:**

**Notes:**

Application is for layout with a freestanding hutch or a gallery wall

**Options:**

Widths: 60", 66", 72", 78", 84"

Depths: 30"

Laminate

Paint Finish

Electrics

Code	Price	H	W	D	Volume	Weight
<b>No Grommet</b>						
H-TLVN-296030-L	1605	29	60	30	5.0	61
H-TLVN-296630-L	1634	29	66	30	6.0	68
H-TLVN-297230-L	1683	29	72	30	6.0	74
H-TLVN-297830-L	1706	29	78	30	7.0	80
H-TLVN-298430-L	1747	29	84	30	7.0	86
H-TLVN-296030-R	1605	29	60	30	5.0	61
H-TLVN-296630-R	1634	29	66	30	6.0	68
H-TLVN-297230-R	1683	29	72	30	6.0	74
H-TLVN-297830-R	1706	29	78	30	7.0	80
H-TLVN-298430-R	1747	29	84	30	7.0	86
<b>w/ Grommet</b>						
H-TLVH-296030-L	1609	29	60	30	5.0	61
H-TLVH-296630-L	1638	29	66	30	6.0	68
H-TLVH-297230-L	1686	29	72	30	6.0	74
H-TLVH-297830-L	1709	29	78	30	7.0	80
H-TLVH-298430-L	1752	29	84	30	7.0	86
H-TLVH-296030-R	1609	29	60	30	5.0	61
H-TLVH-296630-R	1638	29	66	30	6.0	68
H-TLVH-297230-R	1686	29	72	30	6.0	74
H-TLVH-297830-R	1709	29	78	30	7.0	80
H-TLVH-298430-R	1752	29	84	30	7.0	86

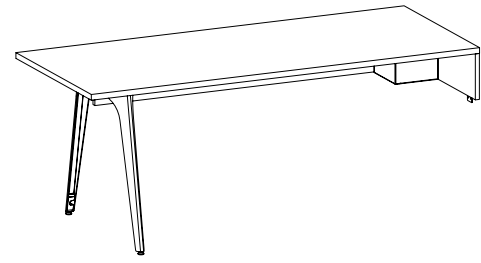

no Grommet



With Grommet

**What's Included:**

- Worksurface
- Short Gable
- Modesty
- V-leg
- Reinforcement bar
- Credenza mounting box

**How to Specify:**

**Notes:**

Application is for layout that does not include a freestanding hutch or a gallery wall

**Options:**

Widths: 60", 66", 72", 78", 84"

Depths: 30"

Laminate

Paint Finish

Electrics

Code	Price	H	W	D	Volume	Weight
<b>No Grommet</b>						
H-TLSVN-296030-GL	1740	29	60	30	5.0	61
H-TLSVN-296630-GL	1768	29	66	30	6.0	68
H-TLSVN-297230-GL	1819	29	72	30	6.0	74
H-TLSVN-297830-GL	1843	29	78	30	7.0	80
H-TLSVN-298430-GL	1887	29	84	30	7.0	86
H-TLSVN-296030-GR	1740	29	60	30	5.0	61
H-TLSVN-296630-GR	1768	29	66	30	6.0	68
H-TLSVN-297230-GR	1819	29	72	30	6.0	74
H-TLSVN-297830-GR	1843	29	78	30	7.0	80
H-TLSVN-298430-GR	1887	29	84	30	7.0	86
<b>w/ Grommet</b>						
H-TLSVH-296030-GL	1744	29	60	30	5.0	61
H-TLSVH-296630-GL	1771	29	66	30	6.0	68
H-TLSVH-297230-GL	1825	29	72	30	6.0	74
H-TLSVH-297830-GL	1848	29	78	30	7.0	80
H-TLSVH-298430-GL	1890	29	84	30	7.0	86
H-TLSVH-296030-GR	1744	29	60	30	5.0	61
H-TLSVH-296630-GR	1771	29	66	30	6.0	68
H-TLSVH-297230-GR	1825	29	72	30	6.0	74
H-TLSVH-297830-GR	1848	29	78	30	7.0	80
H-TLSVH-298430-GR	1890	29	84	30	7.0	86

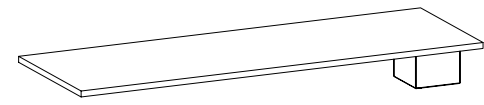

no Grommet

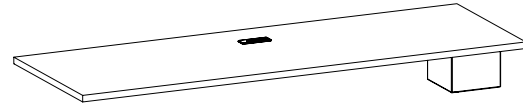

With Grommet

**What's Included:**

- Worksurface
- Credenza mounting bo

**How to Specify:**

Modesty, support and reinforcement bar to be specified separately

**Notes:**

Application is for layout with a freestanding hutch or a gallery wall

**Options:**

Widths: 60", 66", 72", 78", 84"

Depths: 19", 24", 30"

Laminate

Paint Finish

Electrics

No Grommet

w/Grommet

Code	Price	H	W	D	Vol.	Wt.	Code	Price	H	W	D	Vol.	Wt.
H-TLSN-296019-L	358	29	60	19	5.0	39	H-TLSH-296019-L	361	29	60	19	5.0	39
H-TLSN-296619-L	366	29	66	19	6.0	43	H-TLSH-296619-L	374	29	66	19	6.0	43
H-TLSN-297219-L	382	29	72	19	6.0	47	H-TLSH-297219-L	385	29	72	19	6.0	47
H-TLSN-297819-L	391	29	78	19	7.0	51	H-TLSH-297819-L	397	29	78	19	7.0	51
H-TLSN-298419-L	404	29	84	19	7.0	54	H-TLSH-298419-L	408	29	84	19	7.0	54
H-TLSN-296019-R	358	29	60	19	5.0	39	H-TLSH-296019-R	361	29	60	19	5.0	39
H-TLSN-296619-R	366	29	66	19	6.0	43	H-TLSH-296619-R	374	29	66	19	6.0	43
H-TLSN-297219-R	382	29	72	19	6.0	47	H-TLSH-297219-R	385	29	72	19	6.0	47
H-TLSN-297819-R	391	29	78	19	7.0	51	H-TLSH-297819-R	397	29	78	19	7.0	51
H-TLSN-298419-R	404	29	84	19	7.0	54	H-TLSH-298419-R	408	29	84	19	7.0	54
H-TLSN-296024-L	385	29	60	24	5.0	49	H-TLSH-296024-L	388	29	60	24	5.0	49
H-TLSN-296624-L	400	29	66	24	6.0	54	H-TLSH-296624-L	404	29	66	24	6.0	54
H-TLSN-297224-L	413	29	72	24	6.0	59	H-TLSH-297224-L	419	29	72	24	6.0	59
H-TLSN-297824-L	428	29	78	24	7.0	64	H-TLSH-297824-L	432	29	78	24	7.0	64
H-TLSN-298424-L	444	29	84	24	7.0	69	H-TLSH-298424-L	448	29	84	24	7.0	69
H-TLSN-296024-R	385	29	60	24	5.0	49	H-TLSH-296024-R	388	29	60	24	5.0	49
H-TLSN-296624-R	400	29	66	24	6.0	54	H-TLSH-296624-R	404	29	66	24	6.0	54
H-TLSN-297224-R	413	29	72	24	6.0	59	H-TLSH-297224-R	419	29	72	24	6.0	59
H-TLSN-297824-R	428	29	78	24	7.0	64	H-TLSH-297824-R	432	29	78	24	7.0	64
H-TLSN-298424-R	444	29	84	24	7.0	69	H-TLSH-298424-R	448	29	84	24	7.0	69
H-TLSN-296030-L	419	29	60	30	5.0	61	H-TLSH-296030-L	424	29	60	30	5.0	61
H-TLSN-296630-L	436	29	66	30	6.0	68	H-TLSH-296630-L	443	29	66	30	6.0	68
H-TLSN-297230-L	454	29	72	30	6.0	74	H-TLSH-297230-L	459	29	72	30	6.0	74
H-TLSN-297830-L	473	29	78	30	7.0	80	H-TLSH-297830-L	475	29	78	30	7.0	80
H-TLSN-298430-L	491	29	84	30	7.0	86	H-TLSH-298430-L	494	29	84	30	7.0	86
H-TLSN-296030-R	419	29	60	30	5.0	61	H-TLSH-296030-R	424	29	60	30	5.0	61
H-TLSN-296630-R	436	29	66	30	6.0	68	H-TLSH-296630-R	443	29	66	30	6.0	68
H-TLSN-297230-R	454	29	72	30	6.0	74	H-TLSH-297230-R	459	29	72	30	6.0	74
H-TLSN-297830-R	473	29	78	30	7.0	80	H-TLSH-297830-R	475	29	78	30	7.0	80
H-TLSN-298430-R	491	29	84	30	7.0	86	H-TLSH-298430-R	494	29	84	30	7.0	86

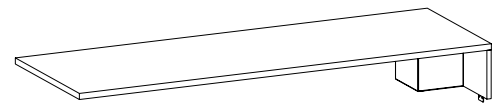

no Grommet

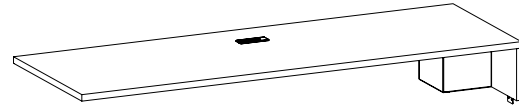

With Grommet

**What's Included:**

- Worksurface
- Short Gable
- Credenza mounting box

**How to Specify:**

Need modesty, supports, and reinforcement bar to be specified separately

**Notes:**

Application is for layout that does not include a freestanding hutch or a gallery wall

**Options:**

Widths: 60", 66", 72", 78", 84"

Depths: 19", 24", 30"

Laminate

Paint Finish

Electrics

No Grommet

Code	Price	H	W	D	Vol.	Wt.
H-TLSN-296019-GL	362	29	60	19		
H-TLSN-296619-GL	464	29	66	19	6.0	43
H-TLSN-297219-GL	475	29	72	19	6.0	47
H-TLSN-297819-GL	488	29	78	19	7.0	51
H-TLSN-298419-GL	499	29	84	19	7.0	54
H-TLSN-296019-GR	362	29	60	19		
H-TLSN-296619-GR	464	29	66	19	6.0	43
H-TLSN-297219-GR	475	29	72	19	6.0	47
H-TLSN-297819-GR	488	29	78	19	7.0	51
H-TLSN-298419-GR	499	29	84	19	7.0	54
H-TLSN-296024-GL	391	29	60	24	5.0	49
H-TLSN-296624-GL	499	29	66	24	6.0	54
H-TLSN-297224-GL	516	29	72	24	6.0	59
H-TLSN-297824-GL	530	29	78	24	7.0	64
H-TLSN-298424-GL	545	29	84	24	7.0	69
H-TLSN-296024-GR	391	29	60	24	5.0	49
H-TLSN-296624-GR	499	29	66	24	6.0	54
H-TLSN-297224-GR	516	29	72	24	6.0	59
H-TLSN-297824-GR	530	29	78	24	7.0	64
H-TLSN-298424-GR	545	29	84	24	7.0	69
H-TLSN-296030-GL	426	29	60	30	5.0	61
H-TLSN-296630-GL	545	29	66	30	6.0	68
H-TLSN-297230-GL	561	29	72	30	6.0	74
H-TLSN-297830-GL	581	29	78	30	7.0	80
H-TLSN-298430-GL	596	29	84	30	7.0	86
H-TLSN-296030-GR	426	29	60	30	5.0	61
H-TLSN-296630-GR	545	29	66	30	6.0	68
H-TLSN-297230-GR	561	29	72	30	6.0	74
H-TLSN-297830-GR	581	29	78	30	7.0	80
H-TLSN-298430-GR	596	29	84	30	7.0	86

With Grommet

Code	Price	H	W	D	Vol.	Wt.
H-TLSH-296019-GL	377	29	60	19	5.0	39
H-TLSH-296619-GL	469	29	66	19	6.0	43
H-TLSH-297219-GL	481	29	72	19	6.0	47
H-TLSH-297819-GL	493	29	78	19	7.0	51
H-TLSH-298419-GL	504	29	84	19	7.0	54
H-TLSH-296019-GR	377	29	60	19	5.0	39
H-TLSH-296619-GR	469	29	66	19	6.0	43
H-TLSH-297219-GR	481	29	72	19	6.0	47
H-TLSH-297819-GR	493	29	78	19	7.0	51
H-TLSH-298419-GR	504	29	84	19	7.0	54
H-TLSH-296024-GL	404	29	60	24	5.0	49
H-TLSH-296624-GL	504	29	66	24	6.0	54
H-TLSH-297224-GL	519	29	72	24	6.0	59
H-TLSH-297824-GL	534	29	78	24	7.0	64
H-TLSH-298424-GL	548	29	84	24	7.0	69
H-TLSH-296024-GR	404	29	60	24	5.0	49
H-TLSH-296624-GR	504	29	66	24	6.0	54
H-TLSH-297224-GR	519	29	72	24	6.0	59
H-TLSH-297824-GR	534	29	78	24	7.0	64
H-TLSH-298424-GR	548	29	84	24	7.0	69
H-TLSH-296030-GL	439	29	60	30	5.0	61
H-TLSH-296630-GL	548	29	66	30	6.0	68
H-TLSH-297230-GL	565	29	72	30	6.0	74
H-TLSH-297830-GL	583	29	78	30	7.0	80
H-TLSH-298430-GL	602	29	84	30	7.0	86
H-TLSH-296030-GR	439	29	60	30	5.0	61
H-TLSH-296630-GR	548	29	66	30	6.0	68
H-TLSH-297230-GR	565	29	72	30	6.0	74
H-TLSH-297830-GR	583	29	78	30	7.0	80
H-TLSH-298430-GR	602	29	84	30	7.0	86

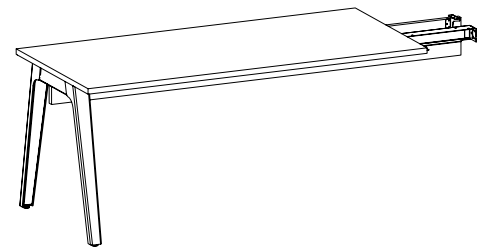

No Grommet

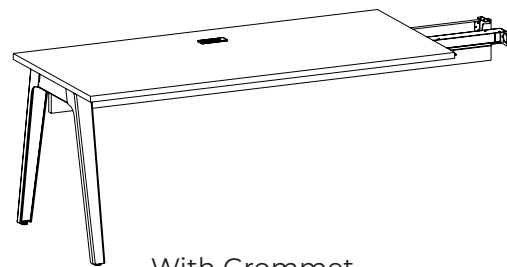

With Grommet

**What's Included:**

- Worksurface
- Modesty
- Reinforcement bar
- Supporting Leg

**Notes:**

One of the A-Legs will come with an infill with a small hole to run wires out the bottom

**Options:**

Widths: 42" 48", 54", 60", 66"

Depths: 30"

Laminate

Paint Finish

Electrics

A-Leg

Code	Price	H	W	D	Volume	Weight
<b>No Grommet</b>						
H-THAN-294230-L	1657	29	42	30	5.0	61
H-THAN-294830-L	1681	29	48	30	6.0	68
H-THAN-295430-L	1703	29	54	30	6.0	55
H-THAN-296030-L	1728	29	60	30	7.0	61
H-THAN-296630-L	1750	29	66	30	7.0	68
H-THAN-294230-R	1657	29	42	30	5.0	61
H-THAN-294830-R	1681	29	48	30	6.0	68
H-THAN-295430-R	1703	29	54	30	6.0	55
H-THAN-296030-R	1728	29	60	30	7.0	61
H-THAN-296630-R	1750	29	66	30	7.0	68
<b>w/ Grommet</b>						
H-THAH-294230-L	1660	29	42	30	5.0	43
H-THAH-294830-L	1683	29	48	30	6.0	49
H-THAH-295430-L	1706	29	54	30	6.0	55
H-THAH-296030-L	1731	29	60	30	7.0	61
H-THAH-296630-L	1753	29	66	30	7.0	68
H-THAH-294230-R	1660	29	42	30	5.0	43
H-THAH-294830-R	1683	29	48	30	6.0	49
H-THAH-295430-R	1706	29	54	30	6.0	55
H-THAH-296030-R	1731	29	60	30	7.0	61
H-THAH-296630-R	1753	29	66	30	7.0	68



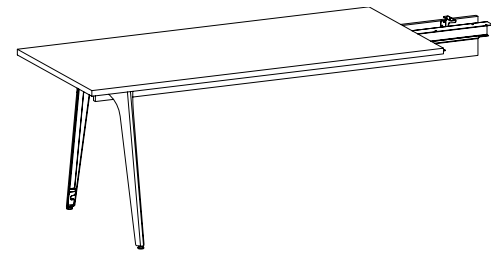

No Grommet

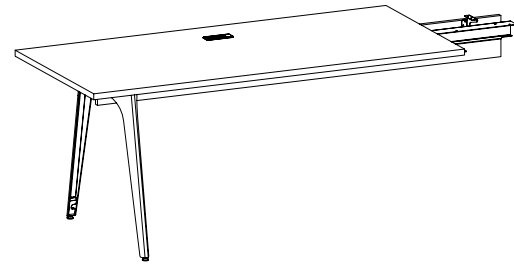

With Grommet

What's Included:

- Worksurface
- Modesty
- Reinforcement bar
- Supporting Leg

Notes:

Options:

Widths: 42" 48", 54", 60", 66"

Depths: 30"

Laminate

Paint Finish

Electrics

V-Leg

Code	Price	H	W	D	Volume	Weight
<b>No Grommet</b>						
H-THVN-294230-L	1411	29	42	30	5.0	61
H-THVN-294830-L	1439	29	48	30	6.0	68
H-THVN-295430-L	1489	29	54	30	6.0	55
H-THVN-296030-L	1514	29	60	30	7.0	61
H-THVN-296630-L	1555	29	66	30	7.0	68
H-THVN-294230-R	1411	29	42	30	5.0	61
H-THVN-294830-R	1439	29	48	30	6.0	68
H-THVN-295430-R	1489	29	54	30	6.0	55
H-THVN-296030-R	1514	29	60	30	7.0	61
H-THVN-296630-R	1555	29	66	30	7.0	68
<b>w/ Grommet</b>						
H-THVH-294230-L	1418	29	42	30	5.0	43
H-THVH-294830-L	1443	29	48	30	6.0	49
H-THVH-295430-L	1495	29	54	30	6.0	55
H-THVH-296030-L	1520	29	60	30	7.0	61
H-THVH-296630-L	1560	29	66	30	7.0	68
H-THVH-294230-R	1418	29	42	30	5.0	43
H-THVH-294830-R	1443	29	48	30	6.0	49
H-THVH-295430-R	1495	29	54	30	6.0	55
H-THVH-296030-R	1520	29	60	30	7.0	61
H-THVH-296630-R	1560	29	66	30	7.0	68

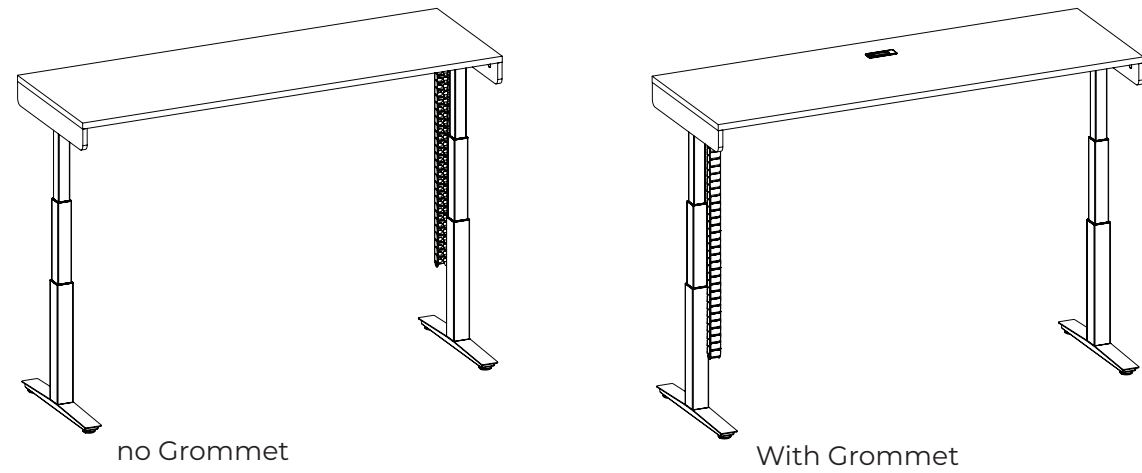

What's Included:

- Height Adjustable Table Base
- e-chain
- Worksurface

How to Specify:

Notes:

Options:

Widths: 60", 66", 72"

Depths: 24", 30"

Laminate

Paint Finish

Electrics

Code	Price	H	W	D	Volume	Weight
<b>No Grommet</b>						
H-HATN-A-6024	1903	26	60	24	3.0	128
H-HATN-A-6624	1922	26	66	24	4.0	132
H-HATN-A-7224	1935	26	72	24	5.0	136
H-HATN-A-6030	1973	26	60	30	4.0	132
H-HATN-A-6630	1993	26	66	30	5.0	136
H-HATN-A-7230	2011	26	72	30	6.0	140
<b>w/ Grommet</b>						
H-HATH-A-6024	1909	26	60	24	3.0	128
H-HATH-A-6624	1925	26	66	24	4.0	132
H-HATH-A-7224	1938	26	72	24	5.0	136
H-HATH-A-6030	1977	26	60	30	4.0	132
H-HATH-A-6630	1997	26	66	30	5.0	136
H-HATH-A-7230	2016	26	72	30	6.0	140

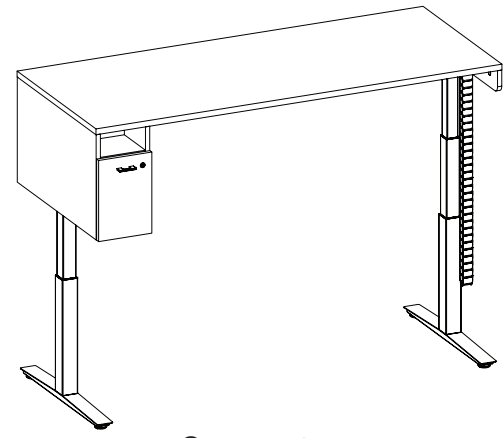

no Grommet

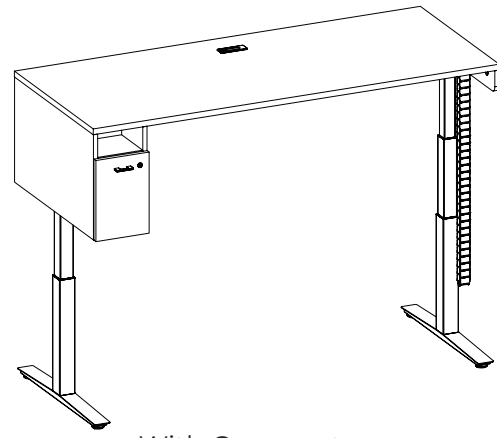

With Grommet

**What's Included:**

- Height Adjustable Table Base
- e-chain
- Worksurface
- Suspended storage

**How to Specify:**

LH storage or RH storage

**Notes:**

**Options:**

Widths: 60", 66", 72"

Depths: 24", 30"

Laminate

Paint Finish

Electrics

Code	Price	H	W	D	Volume	Weight
<b>No Grommet</b>						
H-HATN-B-6030-L	2594	26	60	30	4.0	132
H-HATN-B-6630-L	2613	26	66	30	5.0	136
H-HATN-B-7230-L	2629	26	72	30	6.0	140
H-HATN-B-6030-R	2594	26	60	30	4.0	132
H-HATN-B-6630-R	2613	26	66	30	5.0	136
H-HATN-B-7230-R	2629	26	72	30	6.0	140
<b>w/ Grommet</b>						
H-HATH-B-6030-L	2598	26	60	30	4.0	132
H-HATH-B-6630-L	2616	26	66	30	5.0	136
H-HATH-B-7230-L	2635	26	72	30	6.0	140
H-HATH-B-6030-R	2598	26	60	30	4.0	132
H-HATH-B-6630-R	2616	26	66	30	5.0	136
H-HATH-B-7230-R	2635	26	72	30	6.0	140

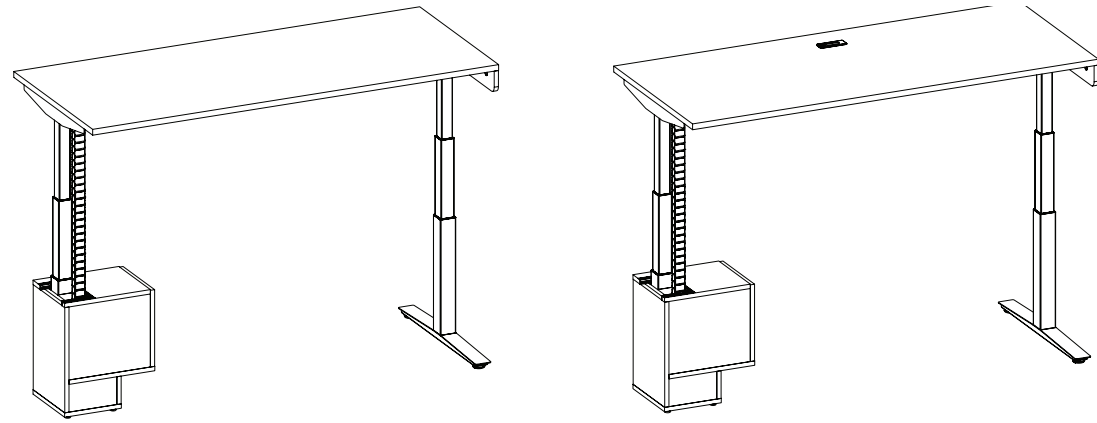

no Grommet

With Grommet

**What's Included:**

- Height Adjustable Table Base
- e-chain
- Worksurface
- Suspended storage
- Credenza Box

**Notes:**

**How to Specify:**

Extension to the RH or Extension to the LH

**Options:**

Widths: 60", 66", 72"

Depths: 24", 30"

Laminate

Paint Finish

Electrics

**No Grommet**

**w/Grommet**

Code	Price	H	W	D	Vol.	Wt.
H-HATN-6-6024-L	2872	26	60	24	3.0	128
H-HATN-6-6624-L	2883	26	66	24	4.0	132
H-HATN-6-7224-L	2899	26	72	24	5.0	136
H-HATN-6-6024-R	2872	26	60	24	3.0	128
H-HATN-6-6624-R	2883	26	66	24	4.0	132
H-HATN-6-7224-R	2899	26	72	24	5.0	136
H-HATN-6-6030-L	2925	26	60	30	4.0	132
H-HATN-6-6630-L	2944	26	66	30	5.0	136
H-HATN-6-7230-L	2963	26	72	30	6.0	140
H-HATN-6-6030-R	2925	26	60	30	4.0	132
H-HATN-6-6630-R	2944	26	66	30	5.0	136
H-HATN-6-7230-R	2963	26	72	30	6.0	140
H-HATN-9-6024-L	2889	26	60	24	3.0	128
H-HATN-9-6624-L	2904	26	66	24	4.0	132
H-HATN-9-7224-L	2921	26	72	24	5.0	136
H-HATN-9-6024-R	2889	26	60	24	3.0	128
H-HATN-9-6624-R	2904	26	66	24	4.0	132
H-HATN-9-7224-R	2921	26	72	24	5.0	136
H-HATN-9-6030-L	2945	26	60	30	4.0	132
H-HATN-9-6630-L	2965	26	66	30	5.0	136
H-HATN-9-7230-L	2983	26	72	30	6.0	140
H-HATN-9-6030-R	2945	26	60	30	4.0	132
H-HATN-9-6630-R	2965	26	66	30	5.0	136
H-HATN-9-7230-R	2983	26	72	30	6.0	140

Code	Price	H	W	D	Vol.	Wt.
H-HATH-6-6024-L	2886	26	60	24	3.0	132
H-HATH-6-6624-L	2896	26	66	24	4.0	132
H-HATH-6-7224-L	2912	26	72	24	5.0	136
H-HATH-6-6024-R	2886	26	60	24	3.0	132
H-HATH-6-6624-R	2896	26	66	24	4.0	132
H-HATH-6-7224-R	2912	26	72	24	5.0	136
H-HATH-6-6030-L	2939	26	60	30	4.0	132
H-HATH-6-6630-L	2959	26	66	30	5.0	136
H-HATH-6-7230-L	2976	26	72	30	6.0	140
H-HATH-6-6030-R	2939	26	60	30	4.0	132
H-HATH-6-6630-R	2959	26	66	30	5.0	136
H-HATH-6-7230-R	2976	26	72	30	6.0	140
H-HATH-9-6024-L	2903	26	60	24	3.0	128
H-HATH-9-6624-L	2917	26	66	24	4.0	132
H-HATH-9-7224-L	2935	26	72	24	5.0	136
H-HATH-9-6024-R	2903	26	60	24	3.0	128
H-HATH-9-6624-R	2917	26	66	24	4.0	132
H-HATH-9-7224-R	2935	26	72	24	5.0	136
H-HATH-9-6030-L	2960	26	60	30	4.0	132
H-HATH-9-6630-L	2978	26	66	30	5.0	136
H-HATH-9-7230-L	2999	26	72	30	6.0	140
H-HATH-9-6030-R	2960	26	60	30	4.0	132
H-HATH-9-6630-R	2978	26	66	30	5.0	136
H-HATH-9-7230-R	2999	26	72	30	6.0	140

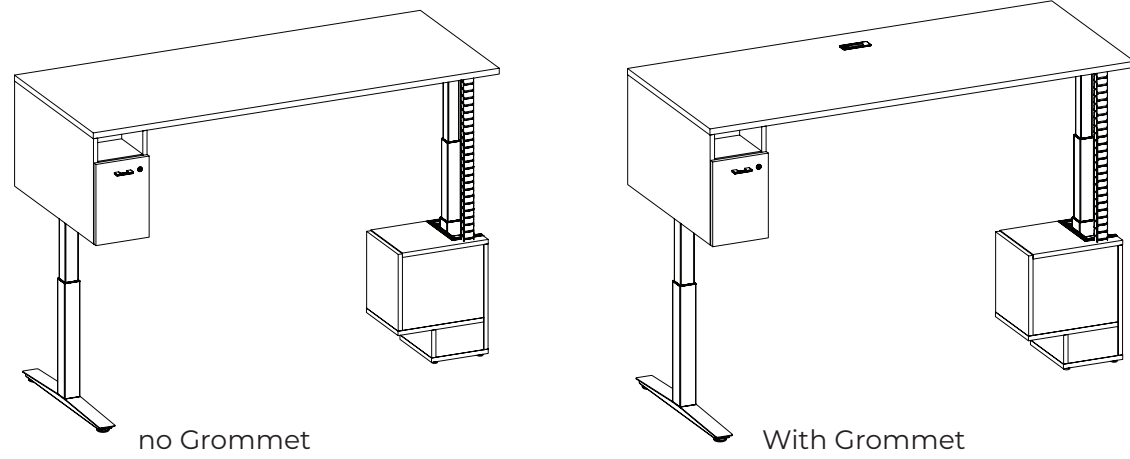

**What's Included:**

- Height Adjustable Table Base
- e-chain
- Worksurface
- Suspended storage
- Credenza Box

**How to Specify:**

Extension to the RH or Extension to the LH

**Notes:**

**Options:**

Widths: 60", 66", 72"

Depths: 24", 30"

Laminate

Paint Finish

Electrics

Code	Price	H	W	D	Volume	Weight
<b>No Grommet</b>						
H-HATN-D6-6030-L	3544	26	60	30	4.0	132
H-HATN-D6-6030-R	3544	26	60	30	4.0	132
H-HATN-D6-6630-L	3553	26	66	30	5.0	136
H-HATN-D6-6630-R	3553	26	66	30	5.0	136
H-HATN-D6-7230-L	3572	26	72	30	6.0	140
H-HATN-D6-7230-R	3572	26	72	30	6.0	140
H-HATN-D9-6030-L	3559	26	60	30	4.0	132
H-HATN-D9-6030-R	3559	26	60	30	4.0	132
H-HATN-D9-6630-L	3576	26	66	30	5.0	136
H-HATN-D9-6630-R	3576	26	66	30	5.0	136
H-HATN-D9-7230-L	3594	26	72	30	6.0	140
H-HATN-D9-7230-R	3594	26	72	30	6.0	140
<b>w/ Grommet</b>						
H-HATH-D6-6030-L	3559	26	60	30	4.0	132
H-HATH-D6-6630-L	3565	26	66	30	5.0	136
H-HATH-D6-7230-L	3584	26	72	30	6.0	140
H-HATH-D6-6030-R	3559	26	60	30	4.0	132
H-HATH-D6-6630-R	3565	26	66	30	5.0	136
H-HATH-D6-7230-R	3584	26	72	30	6.0	140
H-HATH-D9-6030-L	3572	26	60	30	4.0	132
H-HATH-D9-6630-L	3589	26	66	30	5.0	136
H-HATH-D9-7230-L	3610	26	72	30	6.0	140
H-HATH-D9-6030-R	3572	26	60	30	4.0	132
H-HATH-D9-6630-R	3589	26	66	30	5.0	136
H-HATH-D9-7230-R	3610	26	72	30	6.0	140

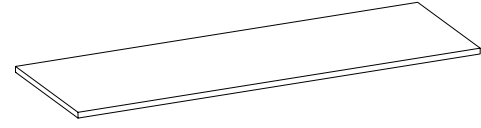

no Grommet

**What's Included:**

- Worksurface
- Grommet cover if grommet option is selected

**How to Specify:**

**Notes:**

Woodgrain runs side-to-side

**Options:**

Widths: 24", 30", 36", 42", 48", 54", 60", 66", 72", 78", 84"

Depths: 19", 24", 30", 36"

Laminate

Paint Finish

Electrics

Code	Price	H	W	D	Volume	Weight
H-WS0N-2419	239	1	24	19	0.4	8
H-WS0N-3019	259	1	30	19	0.4	10
H-WS0N-3619	267	1	36	19	0.4	11
H-WS0N-4219	309	1	42	19	0.5	13
H-WS0N-4819	326	1	48	19	0.5	15
H-WS0N-5419	394	1	54	19	1.0	17
H-WS0N-6019	428	1	60	19	1.0	19
H-WS0N-6619	488	1	66	19	1.0	21
H-WS0N-7219	521	1	72	19	1.0	23
H-WS0N-7819	568	1	78	19	1.0	25
H-WS0N-8419	614	1	84	19	1.0	25
H-WS0N-2424	253	1	24	24	1.0	10
H-WS0N-3024	266	1	30	24	1.0	12
H-WS0N-3624	278	1	36	24	1.0	14
H-WS0N-4224	330	1	42	24	1.0	17
H-WS0N-4824	354	1	48	24	1.0	19
H-WS0N-5424	432	1	54	24	1.0	22
H-WS0N-6024	457	1	60	24	1.0	24
H-WS0N-6624	507	1	66	24	1.0	26
H-WS0N-7224	532	1	72	24	1.0	29
H-WS0N-7824	585	1	78	24	1.0	31
H-WS0N-8424	629	1	84	24	1.0	34
H-WS0N-3630	342	1	36	30	1.0	18
H-WS0N-4230	373	1	42	30	1.0	21
H-WS0N-4830	402	1	48	30	1.0	24
H-WS0N-5430	455	1	54	30	1.0	27
H-WS0N-6030	481	1	60	30	1.0	30
H-WS0N-6630	552	1	66	30	1.0	33
H-WS0N-7230	565	1	72	30	1.0	36
H-WS0N-7830	622	1	78	30	1.0	39
H-WS0N-8430	672	1	84	30	1.0	42
H-WS0N-5436	475	1	54	36	1.0	32
H-WS0N-6036	506	1	60	36	1.0	36
H-WS0N-6636	579	1	66	36	1.0	40
H-WS0N-7236	595	1	72	36	1.0	43
H-WS0N-7836	648	1	78	36	1.0	47
H-WS0N-8436	704	1	84	36	1.0	50

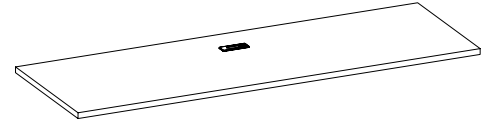

w/ Grommet

**What's Included:**

- Worksurface
- Grommet cover if grommet option is selected

**How to Specify:**

**Notes:**

Woodgrain runs side-to-side  
 Grommet in the center back

**Options:**

Widths: 24", 30", 36", 42", 48", 54", 60", 66", 72", 78", 84"

Depths: 19", 24", 30", 36"

Laminate

Paint Finish

Electrics

Code	Price	H	W	D	Volume	Weight
H-WS0H-2419	262	1	24	19	0.4	8
H-WS0H-3019	281	1	30	19	0.4	10
H-WS0H-3619	290	1	36	19	0.4	11
H-WS0H-4219	330	1	42	19	0.5	13
H-WS0H-4819	348	1	48	19	0.5	15
H-WS0H-5419	413	1	54	19	1.0	17
H-WS0H-6019	449	1	60	19	1.0	19
H-WS0H-6619	510	1	66	19	1.0	21
H-WS0H-7219	545	1	72	19	1.0	23
H-WS0H-7819	590	1	78	19	1.0	25
H-WS0H-8419	638	1	84	19	1.0	27
H-WS0H-2424	278	1	24	24	1.0	10
H-WS0H-3024	288	1	30	24	1.0	12
H-WS0H-3624	300	1	36	24	1.0	14
H-WS0H-4224	351	1	42	24	1.0	17
H-WS0H-4824	380	1	48	24	1.0	19
H-WS0H-5424	455	1	54	24	1.0	22
H-WS0H-6024	476	1	60	24	1.0	24
H-WS0H-6624	530	1	66	24	1.0	26
H-WS0H-7224	553	1	72	24	1.0	29
H-WS0H-7824	603	1	78	24	1.0	31
H-WS0H-8424	652	1	84	24	1.0	34
H-WS0H-3630	361	1	36	30	1.0	18
H-WS0H-4230	395	1	42	30	1.0	21
H-WS0H-4830	427	1	48	30	1.0	24
H-WS0H-5430	475	1	54	30	1.0	27
H-WS0H-6030	503	1	60	30	1.0	30
H-WS0H-6630	575	1	66	30	1.0	33
H-WS0H-7230	590	1	72	30	1.0	36
H-WS0H-7830	641	1	78	30	1.0	39
H-WS0H-8430	691	1	84	30	1.0	42
H-WS0H-5436	496	1	54	36	1.0	32
H-WS0H-6036	527	1	60	36	1.0	36
H-WS0H-6636	597	1	66	36	1.0	40
H-WS0H-7236	615	1	72	36	1.0	43
H-WS0H-7836	667	1	78	36	1.0	47
H-WS0H-8436	725	1	84	36	1.0	50





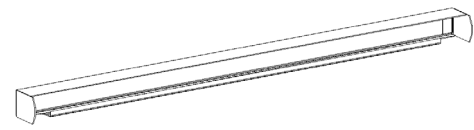

A-Leg

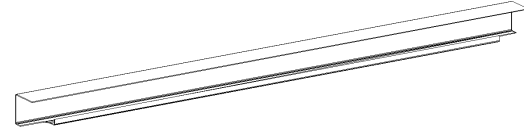

V-Leg

**What's Included:**

- Reinforcement bar and screws

**How to Specify:**

A-leg reinforcement bar needs to cover the full span between 2 A-legs or 1 A-leg to surface support storage

V-leg reinforcement bar does not connect to legs

**Notes:**

Bridge surfaces are supported by V-leg reinforcement bars

**Options:**

Widths: 24", 33", 39", 42", 45", 48", 51", 54", 57", 60", 63", 66", 69", 72", 78"

Depths: 2"

Laminate

Paint Finish

Electrics

Code	Price	H	W	D	Vol.	Wt.
<b>A-Leg</b>						
H-HRBA-24	257	2	24	2	0.2	6
H-HRBA-33	264	2	33	2	0.3	8
H-HRBA-39	267	2	39	2	0.3	10
H-HRBA-42	285	2	42	2	0.4	10
H-HRBA-45	294	2	45	2	0.4	11
H-HRBA-48	297	2	48	2	0.4	12
H-HRBA-51	310	2	51	2	0.4	13
H-HRBA-54	319	2	54	2	0.5	13
H-HRBA-57	327	2	57	2	1.0	14
H-HRBA-60	333	2	60	2	1.0	15
H-HRBA-63	337	2	63	2	1.0	16
H-HRBA-66	348	2	66	2	1.0	16
H-HRBA-69	352	2	69	2	1.0	17
H-HRBA-72	374	2	72	2	1.0	18
H-HRBA-78	375	2	78	2	1.0	19
<b>V-Leg</b>						
H-HRBV-24	119	2	24	2	0.2	6
H-HRBV-33	122	2	33	2	0.3	8
H-HRBV-39	128	2	39	2	0.3	10
H-HRBV-42	142	2	42	2	0.4	10
H-HRBV-45	154	2	45	2	0.4	11
H-HRBV-48	156	2	48	2	0.4	12
H-HRBV-51	164	2	51	2	0.4	13
H-HRBV-54	178	2	54	2	0.5	13
H-HRBV-57	184	2	57	2	1.0	14
H-HRBV-60	190	2	60	2	1.0	15
H-HRBV-63	193	2	63	2	1.0	16
H-HRBV-66	205	2	66	2	1.0	16
H-HRBV-69	210	2	69	2	1.0	17
H-HRBV-72	230	2	72	2	1.0	18
H-HRBV-78	231	2	78	2	1.0	19

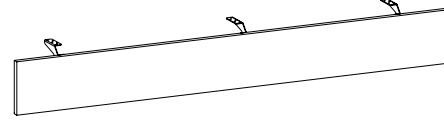

Modesty

**What's Included:**

- 6"H laminate modesty and mounting brackets

**How to Specify:**

**Notes:**

woodgrain on the modesty runs horizontally

**Options:**

Widths: 40", 43", 46", 49", 53, 53", 55", 59", 61", 64", 65", 66", 67", 71", 72", 73", 77", 79"

Depths: 0.75"

Laminate

Paint Finish

Electrics

Code	Price	H	W	D	Vol.	Wt.
H-TM-0640	257	6	40	1	0.3	5
H-TM-0643	262	6	43	1	0.3	5
H-TM-0646	264	6	46	1	0.3	6
H-TM-0649	266	6	49	1	0.3	6
H-TM-0652	268	6	52	1	0.4	6
H-TM-0653	270	6	53	1	0.4	6
H-TM-0655	271	6	55	1	0.4	7
H-TM-0658	277	6	55	1	0.4	7
H-TM-0659	278	6	59	1	0.4	7
H-TM-0661	279	6	61	1	0.4	7
H-TM-0664	282	6	64	1	0.4	8
H-TM-0665	283	6	65	1	0.4	8
H-TM-0666	285	6	66	1	0.4	8
H-TM-0667	286	6	67	1	0.5	8
H-TM-0670	287	6	67	1	0.5	8
H-TM-0671	288	6	71	1	0.5	9
H-TM-0672	289	6	72	1	0.5	9
H-TM-0673	290	6	73	1	0.5	9
H-TM-0677	293	6	77	1	1.0	9
H-TM-0678	294	6	77	1	1.0	9
H-TM-0679	297	6	79	1	1.0	9

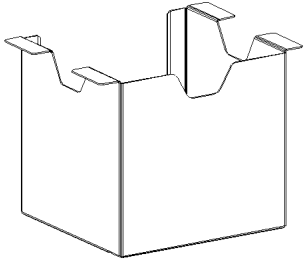

Support Box

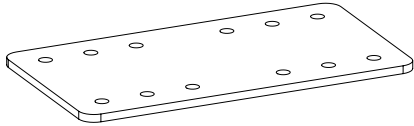

WS to WS Flush Plate

**What's Included:**

- Worksurface support & hardware

**How to Specify:**

A-leg reinforcement bar needs to cover the full span between 2 A-legs or 1 A-leg to surface support storage

V-leg reinforcement bar does not connect to legs

**Notes:**

Bridge surfaces are supported by V-leg reinforcement bars

**Options:**

- Widths: 24", 33", 39", 42", 45", 48", 51", 54", 57", 60", 63", 66", 69", 72", 78"
- Depths: 2"
- Laminate
- Paint Finish
- Electrics

Code	Price	H	W	D	Vol.	Wt.
<b>Support Box</b>						
H-HBOX	140	2	78	2	1.0	19
<b>WS to WS Flush Plate</b>						
H-HFP	43	2	78	2	1.0	19

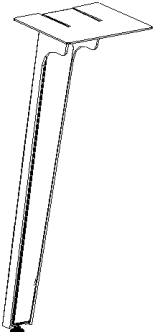

Single A-Leg

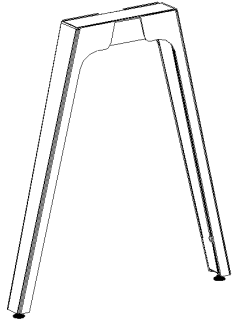

Double A-Leg

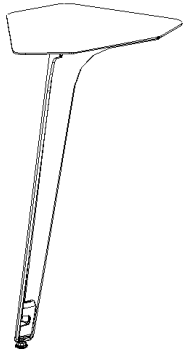

Single V-Leg

**What's Included:**

- Table Support Leg & Hardware

**How to Specify:**

**Notes:**

One of the A-Legs will come with an infill with a small hole to run wires out the bottom

**Options:**

Widths:

Depths:

Laminate

Paint Finish

Electrics

Code	Price	H	W	D	Volume	Weight
<b>A-Leg</b>						
Single/Seated Height						
H-HTA1-28	398	28	2	2	1.0	5
Double/Seated Height						
H-HTA2-2824	616	28	2	2	1.0	5
H-HTA2-2830	627	28	2	2	1.0	6
H-HTA2-2836	637	28	2	2	1.0	7
H-HTA2-2842	703	28	2	2	1.0	8
H-HTA2-2848	711	28	2	2	1.0	9
Double/Standing Height						
H-HTA2-4136	782	28	2	2	1.0	7
H-HTA2-4142	845	28	2	2	1.0	8
H-HTA2-4148	858	28	2	2	1.0	9
<b>V-Leg</b>						
Single/Seated Height						
H-HTV1-28	351	28	2	2	1.0	5
Single/Standing Height						
H-HTV1-41	419	28	2	2	1.0	7



Halifax Pricebook  
 May 2023  
**Storage**

<b>Pedestal</b>	
Underdesk	106
Underdesk w/ hinged Door	108
Mobile	110
<b>Lateral</b>	
Underdesk & Freestanding Box/File	112
Single File	114
Freestanding File Drawers	116
Freestanding w/ Shelf	118
Underdesk w/ Shelf	119
<b>Low Credenza</b>	
Hinged Doors	120
Sliding Doors	122
Open & Lateral	124
End Cap	126
<b>High Credenza</b>	
Hinged Door	128
Lateral & Doors	130
Open & Lateral	132
Shelf Above Sliding Door	134
Open Shelf Above Lateral	136
Credenza   Raised Back	137
Credenza Open End Box w/ Top	138
Cushion	140
Gallery Wall	142
Mobile Credenza   Open & Lateral	144
<b>Hutch</b>	
Laminate w/ Hinged doors	146
Laminate w/ Sliding Door	148
Metal w/ Hinged doors	150
Metal w/ Sliding Door	152
Wall Mounted w/ Hinged door	154
Wall mounted w/ Sliding Door	156
Accent Shelf	158
Combo Cabinet   Open Shelf/File Drawer	160
Combo Cabinet   Lateral Storage	162
Locker Tower w/shelves	164
Locker w/ side access	166
Bookcase	168
Audio Visual Unit	170
Support	171
Audio Visual   Mounted Video Table	172

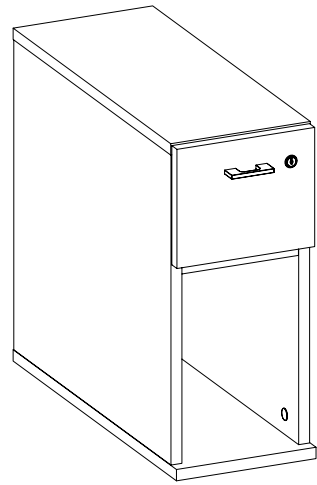

Box/Open

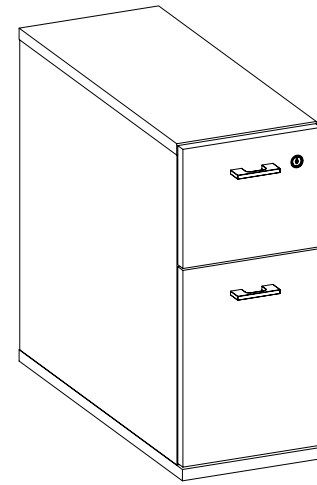

Box/File

**What's Included:**

- Underdesk Box/Open Pedestal or
- Underdesk Box/File Pedestal

**How to Specify:**

- Legs to be specified separately

**Notes:**

**Options:**

Widths: 10", 16"

Depths: 19", 24", 30"

Laminate

Paint Finish

Electrics

**Box/Open**

Code	Price	H	W	D	Volume	Weight
H-FPBO-281019	725	28	10	19	3.0	20
H-FPBO-281619	779	28	16	19	4.0	34
H-FPBO-281624	825	28	16	24	5.0	43
H-FPBO-281024	758	28	10	19	3.0	26
H-FPBO-281030	805	28	10	19	4.0	32
H-FPBO-281630	879	28	16	30	7.0	54

**Box/File**

Code	Price	H	W	D	Volume	Weight
H-FPBF-281019	952	28	9.5	19	3.0	22
H-FPBF-281619	982	28	16	19	5.0	39.5
H-FPBF-281024	979	28	9.5	24	3.2	25.54
H-FPBF-281624	999	28	16	24	5.4	43.01
H-FPBF-281030	993	28	9.5	30	4.0	31.92
H-FPBF-281630	1014	28	16	30	6.7	53.76

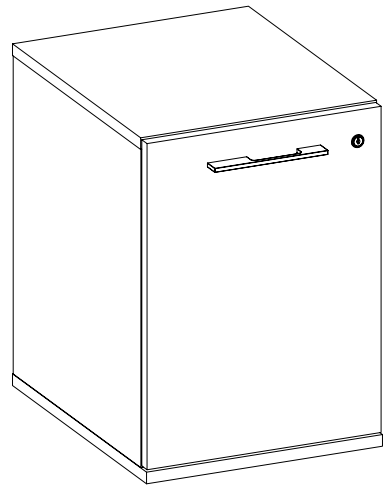

Left hand hinged door

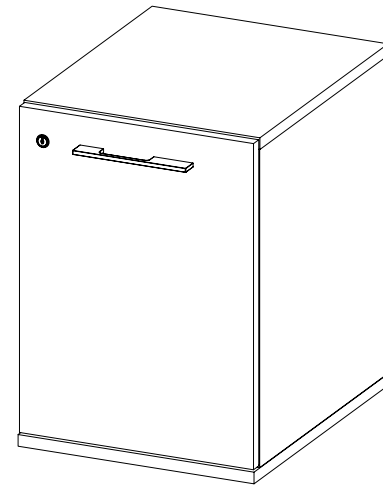

Right hand hinged door

**What's Included:**

- Underdesk Storage Pedestal

**How to Specify:**

- Legs to be specified separately

**Notes:**

**Options:**

Widths: 10", 16"

Depths: 19", 24", 30"

Laminate

Paint Finish

Electrics

Code	Price	H	W	D	Volume	Weight
H-FPH0-281019-L	704	28	10	19	3.0	20
H-FPH0-281019-R	704	28	10	19	3.0	20
H-FPH0-281619-L	758	28	16	19	4.0	34
H-FPH0-281619-R	758	28	16	19	4.0	34
H-FPH0-281024-L	738	28	10	24	3.0	26
H-FPH0-281024-R	738	28	10	24	3.0	26
H-FPH0-281624-L	805	28	16	24	5.0	43
H-FPH0-281624-R	805	28	16	24	5.0	43
H-FPH0-281030-L	779	28	10	30	3.0	32
H-FPH0-281030-R	779	28	10	30	3.0	32
H-FPH0-281630-L	851	28	16	30	7.0	53
H-FPH0-281630-R	851	28	16	30	7.0	53

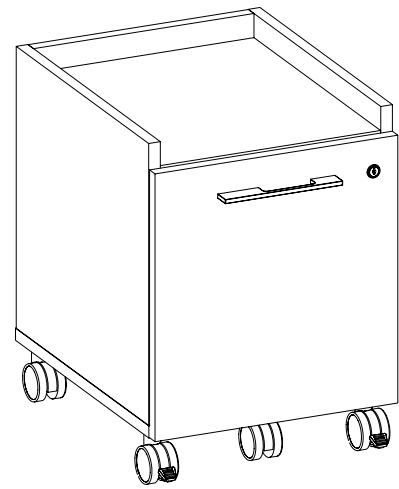

File

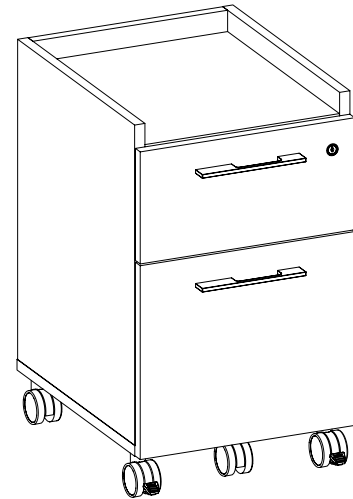

Box/File

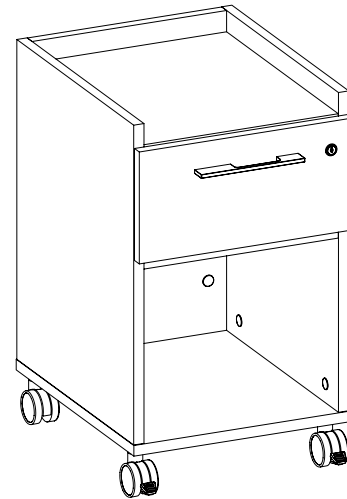

Box Drawer/  
Open Bottom

**What's Included:**

- Mobile Pedestal

**How to Specify:**

- Legs to be specified separately

**Notes:**

**Options:**

Widths: 16"

Depths: 19", 20"

Laminate

Paint Finish

Electrics

Code	Price	H	W	D	Volume	Weight
<b>File</b>						
H-FP0F-221620-M	850	22	16	19	4.0	34
<b>Box/File</b>						
H-FPBF-271620-M	905	27	16	19	4.0	34
<b>Box Drawer/Open Bottom</b>						
H-FPBO-271620-M	898	27	16	20	4.0	34





Underdesk



Freestanding

**What's Included:**

- Underdesk Box/File Lateral

**How to Specify:**

- Legs to be specified separately

**Notes:**

**Options:**

Widths: 24", 30", 36", 42"

Depths: 19", 24"

Laminate

Paint Finish

Electrics

Code	Price	H	W	D	Volume	Weight
<b>Underdesk</b>						
H-FLBU-282419	1196	28	24	19	8.0	55
H-FLBU-283019	1258	28	30	19	8.0	60
H-FLBU-283619	1378	28	36	19	10.0	72
H-FLBU-284219	1390	28	42	19	12.0	84
H-FLBU-282424	1239	28	24	24	9.0	59
H-FLBU-283024	1305	28	30	24	8.0	60
H-FLBU-283624	1509	28	36	24	10.0	72
H-FLBU-284224	1451	28	42	24	12.0	84
<b>Freestanding</b>						
H-FLBF-292419	1401	29	24	19	8.0	56
H-FLBF-293019	1476	29	30	19	8.0	60
H-FLBF-293619	1538	29	36	19	10.0	72
H-FLBF-294219	1597	29	42	19	12.0	84
H-FLBF-292424	1442	29	24	24	9.0	60
H-FLBF-293024	1520	29	30	24	10.0	76
H-FLBF-293624	1586	29	36	24	13.0	91
H-FLBF-294224	1650	29	42	24	15.0	106

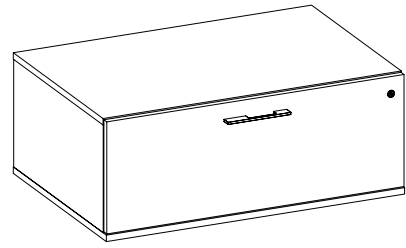

Single File

**What's Included:**

- Single Lateral

**How to Specify:**

- Legs to be specified separately

**Notes:**

**Options:**

Widths: 24", 30", 36", 42"

Depths: 19", 24"

Laminate

Paint Finish

Electrics

Code	Price	H	W	D	Volume	Weight
H-FL1F-202419	947	20	24	19	6.0	42
H-FL1F-203019	997	20	30	19	6.0	46
H-FL1F-203619	1048	20	36	19	7.0	55
H-FL1F-204219	1101	20	42	19	8.0	64
H-FL1F-202424	990	20	24	24	6.0	54
H-FL1F-203024	1040	20	30	24	7.0	58
H-FL1F-203624	1096	20	36	24	9.0	69
H-FL1F-204224	1158	20	42	24	10.0	81

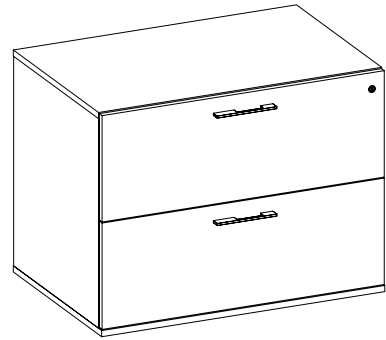

2 Drawers



3 Drawers

**What's Included:**

- Freestanding Lateral

**How to Specify:**

- Legs to be specified separately

**Notes:**

**Options:**

Widths: 24", 30", 36", 42"

Depths: 19", 24"

Laminate

Paint Finish

Electrics

Code	Price	H	W	D	Volume	Weight
<b>2 Drawer</b>						
H-FL2F-342419	1379	34	24	19	10.0	72
H-FL2F-343019	1453	34	30	19	10.0	78
H-FL2F-343619	1507	34	36	19	93.0	93
H-FL2F-344219	1614	34	42	19	14.0	109
H-FL2F-342424	1415	34	24	24	10.0	79
H-FL2F-343024	1488	34	30	24	12.0	98
H-FL2F-343624	1601	34	36	24	15.0	118
H-FL2F-344224	1715	34	42	24	17.0	137
<b>3 Drawer</b>						
H-FL3F-472419	2230	47	24	19	13.0	98
H-FL3F-473019	2347	47	30	19	13.0	107
H-FL3F-473619	2430	47	36	19	16.0	129
H-FL3F-474219	2616	47	47	19	19.0	150
H-FL3F-472424	2279	47	24	24	14.0	118
H-FL3F-473024	2399	47	30	24	17.0	135
H-FL3F-473624	2599	47	36	24	20.0	162
H-FL3F-474224	2800	47	47	19	24.0	190



Freestanding w/ Shelf

**What's Included:**

- Underdesk w/shelf

**How to Specify:**

- Legs to be specified separately

**Options:**

Widths: 24",30", 36", 42"

Depths: 19", 24"

Height: 29"

Laminate

Paint Finish

Electrics

**Notes:**

Code	Price	H	W	D	Volume	Weight
H-FLSF-292419	1030	29	24	19	8.0	56
H-FLSF-293019	1085	29	30	19	8.0	60
H-FLSF-293619	1151	29	36	19	10.0	72
H-FLSF-294219	1219	29	42	19	12.0	84
H-FLSF-292424	1087	29	24	19	9.0	60
H-FLSF-293024	1144	29	30	24	10.0	76
H-FLSF-293624	1279	29	36	24	13.0	91
H-FLSF-294224	1291	29	42	19	15.0	106



Underdesk w/ Shelf

**What's Included:**

- Underdesk w/shelf

**How to Specify:**

- Legs to be specified separately

**Options:**

Widths: 24",30", 36", 42"

Depths: 19", 24"

Height: 29"

Laminate

Paint Finish

Electrics

**Notes:**

Code	Price	H	W	D	Volume	Weight
H-FLSU-282419	1003	28	24	24	8.3	51
H-FLSU-282424	1057	28	24	19	8.3	56
H-FLSU-283019	1019	28	30	24	8.3	55.11
H-FLSU-283024	1076	28	30	19	8.3	60.14
H-FLSU-283619	1081	28	36	24	8.3	67.23
H-FLSU-283624	1200	28	36	19	8.3	72.56
H-FLSU-284219	1145	28	42	24	8.3	79.15
H-FLSU-284224	1213	28	42	19	8.3	92.13

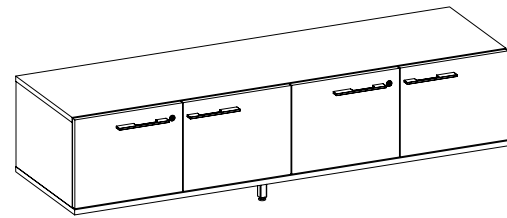

no Grommet

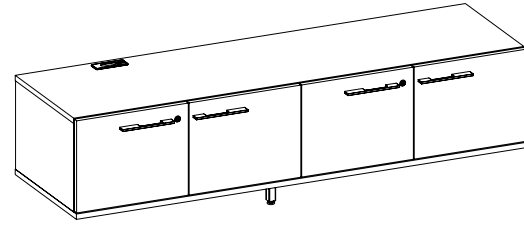

With Grommet

**What's Included:**

- Low Credenza

**How to Specify:**

- Legs to be specified separately

**Options:**

Widths: 30", 36", 42", 48", 54", 60", 66", 72", 78", 84"

Depths: 16", 19"

Height: 20"

Laminate

Paint Finish

Electrics

**Notes:**

**No Grommet**

Code	Price	H	W	D	Vol.	Wt.
H-CRHH-203016	748	20	30	16	8.0	35
H-CRHH-203616	789	20	36	16	10.0	42
H-CRHH-204216	878	20	42	16	11.0	50
H-CRHH-204816	919	20	48	16	13.0	57
H-CRHH-205416	1001	20	54	16	14.0	65
H-CRHH-206016	1091	20	60	16	16.0	73
H-CRHH-206616	1133	20	66	16	17.0	80
H-CRHH-207216	1173	20	72	16	19.0	88
H-CRHH-207816	1213	20	78	16	21.0	95
H-CRHH-208416	1256	20	84	16	22.0	103

Code	Price	H	W	D	Vol.	Wt.
H-CRHH-204219	964	20	42	16	11.0	53
H-CRHH-203019	823	20	30	19	8.0	38
H-CRHH-203619	867	20	36	19	10.0	46
H-CRHH-204819	1008	20	48	19	13.0	61
H-CRHH-205419	1097	20	54	19	14.0	68
H-CRHH-206019	1196	20	60	19	16.0	76
H-CRHH-206619	1239	20	66	19	17.0	84
H-CRHH-207219	1285	20	72	19	19.0	91
H-CRHH-207819	1332	20	78	19	21.0	99
H-CRHH-208419	1376	20	84	16	22.0	106

**w/Grommet - left hand**

Code	Price	H	W	D	Vol.	Wt.
H-CRHH-203016-L	880	20	30	16	8.0	35
H-CRHH-203616-L	921	20	36	16	10.0	42
H-CRHH-204216-L	1124	20	42	16	11.0	50
H-CRHH-204816-L	1163	20	48	16	13.0	57
H-CRHH-205416-L	1291	20	54	16	14.0	65
H-CRHH-206016-L	1332	20	60	16	16.0	73
H-CRHH-206616-L	1522	20	66	16	17.0	80
H-CRHH-207216-L	1561	20	72	16	19.0	88
H-CRHH-207816-L	1601	20	78	16	21.0	95
H-CRHH-208416-L	1641	20	84	16	22.0	103
H-CRHH-203019-L	906	20	30	19	8.0	38
H-CRHH-203619-L	947	20	36	19	10.0	46
H-CRHH-204219-L	1163	20	42	16	11.0	53
H-CRHH-204819-L	1205	20	48	19	13.0	61
H-CRHH-205419-L	1338	20	54	19	14.0	68
H-CRHH-206019-L	1377	20	60	19	16.0	76
H-CRHH-206619-L	1573	20	66	19	17.0	84
H-CRHH-207219-L	1614	20	72	19	19.0	91
H-CRHH-207819-L	1662	20	78	19	21.0	99
H-CRHH-208419-L	1701	20	84	16	22.0	106

**w/Grommet - right hand**

Code	Price	H	W	D	Vol.	Wt.
H-CRHH-203016-R	880	20	30	16	8.0	35
H-CRHH-203616-R	921	20	36	16	10.0	42
H-CRHH-204216-R	1124	20	42	16	11.0	50
H-CRHH-204816-R	1163	20	48	16	13.0	57
H-CRHH-205416-R	1291	20	54	16	14.0	65
H-CRHH-206016-R	1332	20	60	16	16.0	73
H-CRHH-206616-R	1522	20	66	16	17.0	80
H-CRHH-207216-R	1561	20	72	16	19.0	88
H-CRHH-207816-R	1601	20	78	16	21.0	95
H-CRHH-208416-R	1641	20	84	16	22.0	103
H-CRHH-204219-R	1163	20	42	16	11.0	53
H-CRHH-208419-R	1701	20	84	16	22.0	106
H-CRHH-203019-R	906	20	30	19	8.0	38
H-CRHH-203619-R	947	20	36	19	10.0	46
H-CRHH-204819-R	1205	20	48	19	13.0	61
H-CRHH-205419-R	1338	20	54	19	14.0	68
H-CRHH-206019-R	1377	20	60	19	16.0	76
H-CRHH-206619-R	1573	20	66	19	17.0	84
H-CRHH-207219-R	1614	20	72	19	19.0	91
H-CRHH-207819-R	1662	20	78	19	21.0	99

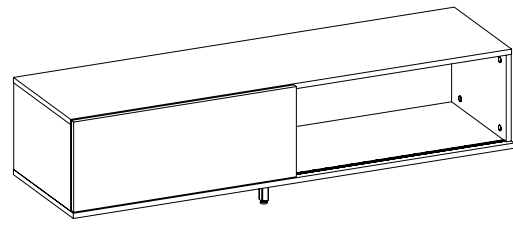

no Grommet

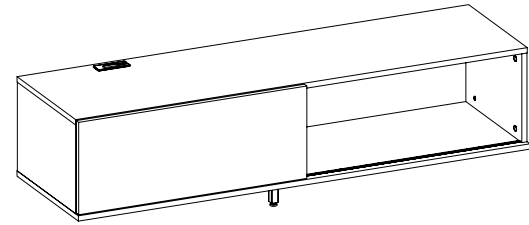

With Grommet

**What's Included:**

- Low Credenza

**How to Specify:**

- Legs to be specified separately

**Notes:**

**Options:**

Widths: 30", 36", 42", 48", 54", 60", 66", 72", 78", 84"

Depths: 16", 19"

Height:

Laminate

Paint Finish

Electrics

**No Grommet**

Code	Price	H	W	D	Vol.	Wt.
H-CRSD-203016	1085	20	30	16	8.0	28
H-CRSD-203616	1126	20	36	16	10.0	35
H-CRSD-204216	1175	20	42	16	11.0	41
H-CRSD-204816	1219	20	48	16	13.0	48
H-CRSD-205416	1357	20	54	16	14.0	54
H-CRSD-206016	1406	20	60	16	16.0	61
H-CRSD-206616	1450	20	66	16	17.0	66
H-CRSD-207216	1498	20	72	16	19.0	74
H-CRSD-207816	1540	20	78	16	21.0	80
H-CRSD-208416	1590	20	84	16	22.0	86

Code	Price	H	W	D	Vol.	Wt.
H-CRSD-203619	1161	20	36	19	10.0	39
H-CRSD-203019	1113	20	30	19	8.0	33
H-CRSD-204219	1211	20	42	19	11.0	46
H-CRSD-204819	1260	20	48	19	13.0	52
H-CRSD-205419	1400	20	54	19	14.0	59
H-CRSD-206019	1450	20	60	19	16.0	65
H-CRSD-206619	1498	20	66	19	17.0	72
H-CRSD-207219	1547	20	72	19	19.0	78
H-CRSD-207819	1604	20	78	19	21.0	85
H-CRSD-208419	1652	20	84	19	22.0	91

**No Grommet- left hand**

Code	Price	H	W	D	Vol.	Wt.
H-CRSD-203016-L	1150	20	30	16	8.0	28
H-CRSD-203616-L	1198	20	36	16	10.0	35
H-CRSD-204216-L	1247	20	42	16	11.0	41
H-CRSD-204816-L	1296	20	48	16	13.0	48
H-CRSD-205416-L	1443	20	54	16	14.0	54
H-CRSD-206016-L	1492	20	60	16	16.0	61
H-CRSD-206616-L	1543	20	66	16	17.0	66
H-CRSD-207216-L	1592	20	72	16	19.0	74
H-CRSD-207816-L	1640	20	78	16	21.0	80
H-CRSD-208416-L	1690	20	84	16	22.0	86
H-CRSD-203019-L	1185	20	30	19	8.0	33
H-CRSD-203619-L	1234	20	36	19	10.0	39
H-CRSD-204219-L	1289	20	42	19	11.0	46
H-CRSD-204819-L	1339	20	48	19	13.0	52
H-CRSD-205419-L	1486	20	54	19	14.0	59
H-CRSD-206019-L	1543	20	60	19	16.0	65
H-CRSD-206619-L	1592	20	66	19	17.0	72
H-CRSD-207219-L	1646	20	72	19	19.0	78
H-CRSD-207819-L	1695	20	78	19	21.0	85
H-CRSD-208419-L	1752	20	84	19	22.0	91

**w/Grommet- right hand**

Code	Price	H	W	D	Vol.	Wt.
H-CRSD-203616-R	1198	20	36	16	10.0	35
H-CRSD-203016-R	1150	20	30	16	8.0	28
H-CRSD-204216-R	1247	20	42	16	11.0	41
H-CRSD-204816-R	1296	20	48	16	13.0	48
H-CRSD-205416-R	1443	20	54	16	14.0	54
H-CRSD-206016-R	1492	20	60	16	16.0	61
H-CRSD-206616-R	1543	20	66	16	17.0	66
H-CRSD-207216-R	1592	20	72	16	19.0	74
H-CRSD-207816-R	1640	20	78	16	21.0	80
H-CRSD-208416-R	1690	20	84	16	22.0	86
H-CRSD-203019-R	1185	20	30	19	8.0	33
H-CRSD-203619-R	1234	20	36	19	10.0	39
H-CRSD-204219-R	1289	20	42	19	11.0	46
H-CRSD-204819-R	1339	20	48	19	13.0	52
H-CRSD-205419-R	1486	20	54	19	14.0	59
H-CRSD-206019-R	1543	20	60	19	16.0	65
H-CRSD-206619-R	1592	20	66	19	17.0	72
H-CRSD-207219-R	1646	20	72	19	19.0	78
H-CRSD-207819-R	1695	20	78	19	21.0	85
H-CRSD-208419-R	1752	20	84	19	22.0	91

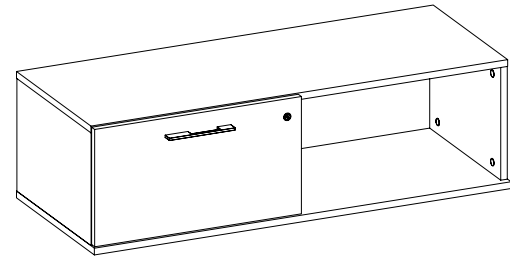

Lateral/Open No Grommet

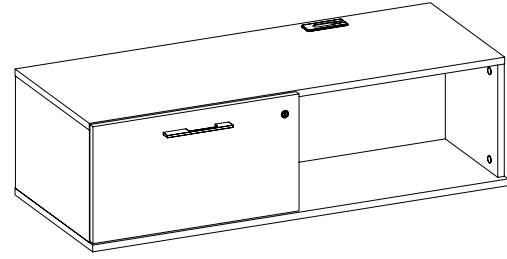

Lateral/Open With Grommet

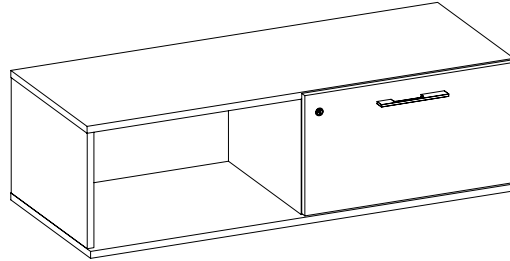

Open/Lateral No Grommet

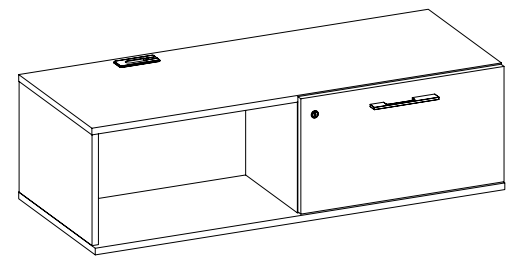

Open/Lateral w/ Grommet

**What's Included:**

- Low Credenza

**How to Specify:**

- Legs to be specified separately

**Notes:**

**Options:**

Widths: 48", 54", 60", 66", 72", 78", 84"

Depths: 19"

Laminate

Paint Finish

Electrics

**No Grommet**

Code	Price	H	W	D	Vol.	Wt.
Lateral/Open						
H-CRLO-204819	1152	20	48	19	13.0	61
H-CRLO-205419	1286	20	54	19	14.0	68
H-CRLO-206019	1342	20	60	19	16.0	76
H-CRLO-206619	1384	20	66	19	17.0	84
H-CRLO-207219	1439	20	72	19	19.0	91
H-CRLO-207819	1476	20	78	19	21.0	99
H-CRLO-208419	1531	20	84	19	22.0	106
Open/Lateral						
H-CROL-204819	1152	20	48	19	13.0	61
H-CROL-205419	1286	20	54	19	14.0	68
H-CROL-206019	1342	20	60	19	16.0	76
H-CROL-206619	1384	20	66	19	17.0	84
H-CROL-207219	1439	20	72	19	19.0	91
H-CROL-207819	1476	20	78	19	21.0	99
H-CROL-208419	1531	20	84	19	22.0	106

**w/Grommet**

Code	Price	H	W	D	Vol.	Wt.
Lateral/Open						
H-CRLO-204819-R	1238	20	48	19	13.0	61
H-CRLO-205419-R	1379	20	54	19	14.0	68
H-CRLO-206019-R	1436	20	60	19	16.0	76
H-CRLO-206619-R	1477	20	66	19	17.0	84
H-CRLO-207219-R	1540	20	72	19	19.0	91
H-CRLO-207819-R	1582	20	78	19	21.0	99
H-CRLO-208419-R	1638	20	84	19	22.0	106
Open/Lateral						
H-CROL-204819-L	1238	20	48	19	13.0	61
H-CROL-205419-L	1379	20	54	19	14.0	68
H-CROL-206019-L	1436	20	60	19	16.0	76
H-CROL-206619-L	1477	20	66	19	17.0	84
H-CROL-207219-L	1540	20	72	19	19.0	91
H-CROL-207819-L	1582	20	78	19	21.0	99
H-CROL-208419-L	1638	20	84	19	22.0	106

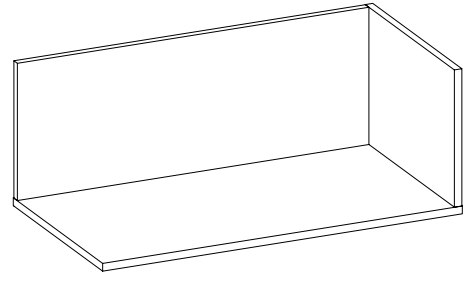

End Cap-  
LH shown

**What's Included:**

- Low Credenza End Cap Open Shelf

**How to Specify:**

- Legs to be specified separately
- Open to RH or LH

**Notes:**

**Options:**

Widths: 9", 12", 15", 18", 21", 27", 30", 36", 39", 42", 45", 48"

Depths: 16", 19"

Height: 20", 29"

Laminate

Paint Finish

Electrics?

Code	Price	H	W	D	Vol.	Wt.
H-CREC-200916-L	253	29	9	16	1.0	8
H-CREC-200916-R	253	20	9	16	1.0	8
H-CREC-201216-L	266	20	12	16	2.0	11
H-CREC-201216-R	266	20	12	16	2.0	11
H-CREC-201516-L	276	20	15	16	2.0	14
H-CREC-201516-R	276	20	15	16	2.0	14
H-CREC-201816-L	282	20	18	16	2.0	17
H-CREC-201816-R	282	20	18	16	2.0	17
H-CREC-202116-L	293	20	21	16	2.0	20
H-CREC-202116-R	293	20	21	16	2.0	20
H-CREC-202416-L	309	20	24	16	2.0	23
H-CREC-202416-R	309	20	24	16	2.0	23
H-CREC-202716-L	316	20	27	16	2.0	26
H-CREC-202716-R	316	20	27	16	2.0	26
H-CREC-203016-L	325	20	30	16	2.0	29
H-CREC-203016-R	325	20	30	16	2.0	29
H-CREC-203316-L	338	20	33	16	2.0	32
H-CREC-203316-R	338	20	33	16	2.0	32
H-CREC-203616-L	343	20	36	16	2.0	35
H-CREC-203616-R	343	20	36	16	2.0	35
H-CREC-203916-L	358	20	39	16	2.0	38
H-CREC-203916-R	358	20	39	16	2.0	38
H-CREC-204216-L	363	20	42	16	3.0	41
H-CREC-204216-R	363	20	42	16	3.0	41
H-CREC-204516-L	373	20	45	16	3.0	44
H-CREC-204516-R	373	20	45	16	3.0	44
H-CREC-204816-L	386	20	48	16	3.0	47
H-CREC-204816-R	386	20	48	16	3.0	47

Code	Price	H	W	D	Vol.	Wt.
H-CREC-200919-L	261	20	9	19	2.0	10
H-CREC-200919-R	261	20	9	19	2.0	10
H-CREC-201219-L	276	20	12	19	2.0	13
H-CREC-201219-R	276	20	12	19	2.0	13
H-CREC-201519-L	282	20	15	19	2.0	16
H-CREC-201519-R	282	20	15	19	2.0	16
H-CREC-201819-L	287	20	18	19	2.0	19
H-CREC-201819-R	287	20	18	19	2.0	19
H-CREC-202119-L	293	20	21	19	2.0	22
H-CREC-202119-R	293	20	21	19	2.0	22
H-CREC-202419-L	309	20	24	19	2.0	25
H-CREC-202419-R	309	20	24	19	2.0	25
H-CREC-202719-L	327	20	27	19	2.0	27
H-CREC-202719-R	327	20	27	19	2.0	27
H-CREC-203019-L	339	20	30	19	2.0	31
H-CREC-203019-R	339	20	30	19	2.0	31
H-CREC-203319-L	350	20	33	19	2.0	33
H-CREC-203319-R	350	20	33	19	2.0	33
H-CREC-203619-L	353	20	36	19	2.0	37
H-CREC-203619-R	353	20	36	19	2.0	37
H-CREC-203919-L	365	20	39	19	3.0	40
H-CREC-203919-R	365	20	39	19	3.0	40
H-CREC-204219-L	374	20	42	19	3.0	43
H-CREC-204219-R	374	20	42	19	3.0	43
H-CREC-204519-L	382	20	45	19	3.0	46
H-CREC-204519-R	382	20	45	19	3.0	46
H-CREC-204819-L	397	20	48	19	3.0	49
H-CREC-204819-R	397	20	48	19	3.0	49



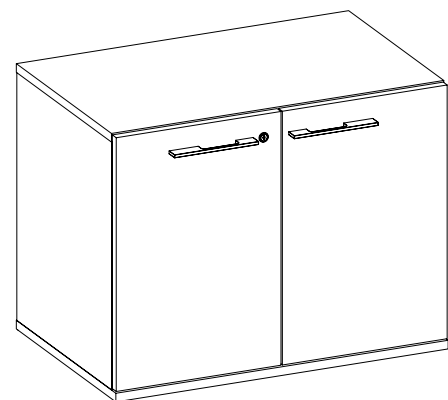

High Credenza w/ hinged door

**What's Included:**

- High Credenza

**How to Specify:**

Legs to be specified separately

**Notes:**

**Options:**

Widths: 30", 36", 42", 48", 54", 60", 66", 72", 78", 84"

Depths: 19", 24"

Height: 29"

Laminate

Paint Finish

Electrics

Code	Price	H	W	D	Volume	Weight
H-CRHH-293019	1134	29	30	19	11.0	55
H-CRHH-293619	1221	29	36	19	14.0	66
H-CRHH-294219	1318	29	42	19	16.0	77
H-CRHH-294819	1522	29	48	19	18.0	88
H-CRHH-295419	1684	29	54	19	18.0	96
H-CRHH-296019	1751	29	60	19	23.0	110
H-CRHH-296619	1898	29	66	19	23.0	118
H-CRHH-297219	1960	29	72	19	28.0	132
H-CRHH-297819	2024	29	78	19	28.0	140
H-CRHH-298419	2079	29	84	19	32.0	154
H-CRHH-293024	1200	29	30	24	15.0	70
H-CRHH-293624	1294	29	36	24	17.0	84
H-CRHH-294224	1558	29	42	24	20.0	97
H-CRHH-294824	1632	29	48	24	23.0	111
H-CRHH-295424	1803	29	54	24	18.0	117
H-CRHH-296024	1876	29	60	24	29.0	139
H-CRHH-296624	2037	29	66	24	29.0	145
H-CRHH-297224	2109	29	72	24	35.0	167
H-CRHH-297824	2178	29	78	24	35.0	175
H-CRHH-298424	2247	29	84	24	41.0	195

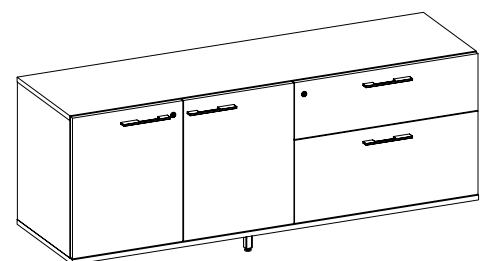

High Credenza w/ Lateral & Doors



High Credenza w/Doors & Lateral

**What's Included:**

- High Credenza

**How to Specify:**

Legs to be specified separately

**Notes:**

**Options:**

Widths: 48", 54", 60", 66", 72", 78", 84"

Depths: 19", 24"

Height: 29"

Laminate

Paint Finish

Electrics

Code	Price	H	W	D	Volume	Weight
<b>Hinged Door &amp; Lateral</b>						
H-CRHL-294819	1549	29	48	19	18.0	76
H-CRHL-295419	1680	29	54	19	18.0	81
H-CRHL-296019	1733	29	60	19	23.0	94
H-CRHL-296619	1775	29	66	18	23.0	100
H-CRHL-297219	1817	29	72	19	28.0	113
H-CRHL-297819	1965	29	78	19	28.0	120
H-CRHL-298419	2028	29	84	19	32.0	132
H-CRHL-294824	1641	29	48	24	23.0	95
H-CRHL-295424	1769	29	54	24	23.0	101
H-CRHL-296024	1836	29	60	24	29.0	119
H-CRHL-296624	1885	29	66	24	29.0	125
H-CRHL-297224	1926	29	72	24	35.0	143
H-CRHL-297824	2091	29	78	24	35.0	150
H-CRHL-298424	2162	29	84	24	41.0	167
<b>Lateral &amp; Hinged Door</b>						
H-CRLH-294819	1549	29	48	19	18.0	76
H-CRLH-295419	1680	29	54	19	18.0	81
H-CRLH-296019	1733	29	60	19	23.0	94
H-CRLH-296619	1775	29	66	19	23.0	100
H-CRLH-297219	1817	29	72	19	28.0	113
H-CRLH-297819	1965	29	78	19	28.0	120
H-CRLH-298419	2028	29	84	19	32.0	132
H-CRLH-294824	1641	29	48	24	23.0	95
H-CRLH-295424	1769	29	54	24	23.0	101
H-CRLH-296024	1836	29	60	24	29.0	119
H-CRLH-296624	1885	29	66	24	29.0	125
H-CRLH-297224	1926	29	72	24	35.0	143
H-CRLH-297824	2091	29	78	24	35.0	150
H-CRLH-298424	2162	29	84	24	41.0	167



High Credenza w/ Lateral & Open

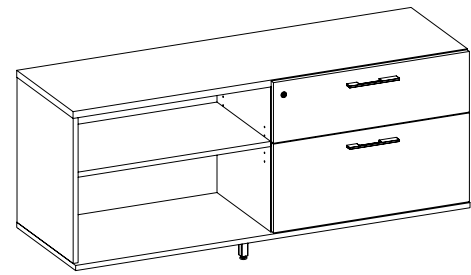

High Credenza w/ Open & Lateral

**What's Included:**

- High Credenza

**How to Specify:**

Legs to be specified separately

**Notes:**

**Options:**

Widths: 48", 60", 72", 84"

Depths: 19", 24"

Laminate

Paint Finish

Electrics

Code	Price	H	W	D	Volume	Weight
<b>Lateral &amp; Open</b>						
H-CRLO-294819	1605	29	48	19	18.0	88
H-CRLO-296019	1802	29	60	19	23.0	110
H-CRLO-297219	1902	29	72	19	28.0	132
H-CRLO-298419	2011	29	84	19	32.0	154
H-CRLO-294824	1695	29	48	24	23.0	111
H-CRLO-296024	1913	29	60	24	29.0	139
H-CRLO-297224	2028	29	72	24	35.0	167
H-CRLO-298424	2151	29	84	24	41.0	195
<b>Open &amp; Lateral</b>						
H-CROL-294819	1605	29	48	19	18.0	88
H-CROL-296019	1802	29	60	19	23.0	110
H-CROL-297219	1902	29	72	19	28.0	132
H-CROL-298419	2011	29	84	19	32.0	154
H-CROL-294824	1695	29	48	24	23.0	111
H-CROL-296024	1913	29	60	24	29.0	139
H-CROL-297224	2028	29	72	24	35.0	167
H-CROL-298424	2151	29	84	24	41.0	195

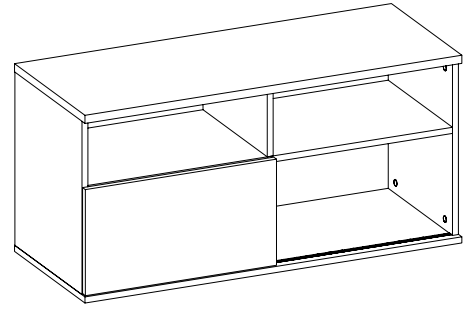

High Credenza w/ Shelf above Sliding Door

**What's Included:**

- High Credenza

**How to Specify:**

Legs to be specified separately

**Notes:**

**Options:**

Widths: 48", 54", 60", 66", 72", 78", 84"

Depths: 19", 24"

Height: 29"

Laminate

Paint Finish

Electrics

Code	Price	H	W	D	Volume	Weight
H-CRFS-294819	1442	29	48	19	18.4	75.57
H-CRFS-294824	1538	29	48	24	23.2	95.45
H-CRFS-295419	1582	29	54	19	18.4	83
H-CRFS-295424	1691	29	54	24	23.2	86
H-CRFS-296019	1645	29	60	19	23.0	94.46
H-CRFS-296024	1753	29	60	24	29.0	119.31
H-CRFS-296619	1704	29	66	19	23.0	100
H-CRFS-296624	1825	29	66	24	29.0	125
H-CRFS-297219	1762	29	72	19	27.6	113.35
H-CRFS-297224	1894	29	72	24	34.8	143.18
H-CRFS-297819	1825	29	78	19	27.6	120
H-CRFS-297824	1957	29	78	24	34.8	150
H-CRFS-298419	1882	29	84	19	32.1	132.24
H-CRFS-298424	2028	29	84	24	40.6	167.04

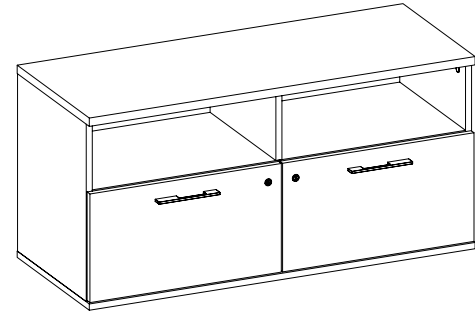

High Credenza w/ Open Shelf above Lateral

**What's Included:**

- High Credenza

**How to Specify:**

Legs to be specified separately

**Notes:**

**Options:**

Widths: 48", 54", 60", 66", 72", 78", 84"

Depths: 19", 24"

Height: 29"

Laminate

Paint Finish

Electrics

Code	Price	H	W	D	Volume	Weight
H-CRFL-294819	1667	29	48	19	18.4	88.16
H-CRFL-294824	1766	29	48	24	23.2	111.36
H-CRFL-296019	1884	29	60	19	23.0	110.2
H-CRFL-296024	1979	29	60	24	29.0	139.2
H-CRFL-297219	2032	29	72	19	27.6	132.24
H-CRFL-297224	2152	29	72	24	34.8	167.04
H-CRFL-298419	2195	29	84	19	32.1	154.28
H-CRFL-298424	2324	29	84	24	40.6	194.88

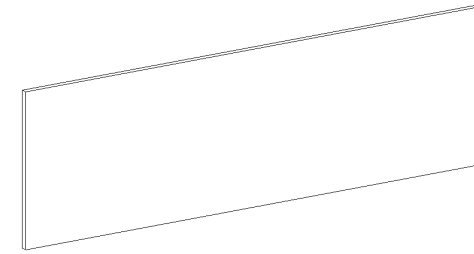

Raised Back for Credenza

**What's Included:**

- Laminate raised credenza panel

**How to Specify:**

**Notes:**

**Options:**

Widths: 48", 54", 60", 66", 72", 78", 84"

Depths: 0.75"

Height: 18"

Laminate

Paint Finish

Electrics?

Code	Price	H	W	D	Volume	Weight
H-CRB0-1848	292	18	48	1	4.0	4
H-CRB0-1854	314	18	54	1	1.0	4
H-CRB0-1860	337	18	60	1	1.0	5
H-CRB0-1866	363	18	66	1	1.1	5.28
H-CRB0-1872	413	18	72	1	1.2	5.76
H-CRB0-1878	450	18	78	1	1.3	6.24
H-CRB0-1884	493	18	84	1	1.4	6.72

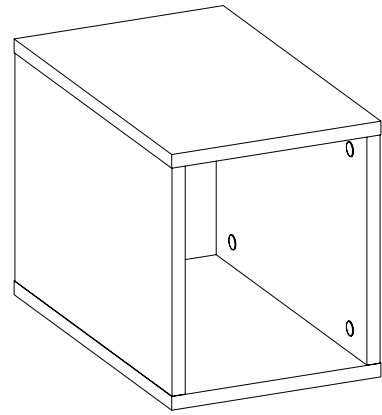

Credenza Open End Box

**What's Included:**

- Credenza End Box

**How to Specify:**

- Used beside the Integrated Height Adjustable Table Box to make up the full width
- Legs to be specified separately

**Notes:**

**Options:**

Widths: 9", 12"

Depths: 16", 19"

Height: 20"

Laminate

Paint Finish

Electrics?

Code	Price	H	W	D	Volume	Weight
H-CREB-200916	363	20	9	16	2.0	12
H-CREB-201216	404	20	12	16	2.0	14
H-CREB-200919	375	20	9	19	2.0	14
H-CREB-201219	419	20	12	19	3.0	18

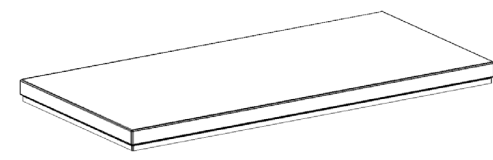

Credenza Cushion

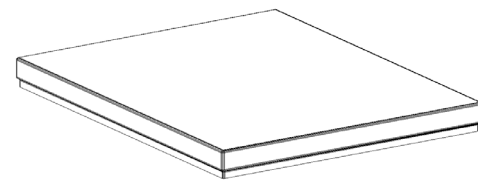

Pedestal Cushion

**What's Included:**

- upholstered cushion

**How to Specify:**

- Used beside the Integrated Height Adjustable Table Box to make up the full width
- Legs to be specified separately

**Notes:**

Credenza cushions leave 1.5" gap on all 4 sides of the credenza top

**Options:**

Widths: 21", 27", 33", 39", 45", 51", 57", 63", 69", 75", 81"

Depths: 13, 16"

Height: 2"

Cushion Fabric

Code	Price	H	W	D	Volume	Weight
<b>Credenza cushion</b>						
H-AC-2113	281	2	21	13	0.2	3
H-AC-2713	316	2	27	13	0.2	4
H-AC-3313	353	2	33	13	0.3	4
H-AC-3913	399	2	39	13	0.3	5
H-AC-4513	435	2	45	13	0.4	6
H-AC-5113	476	2	51	13	0.4	7
H-AC-5713	515	2	57	13	0.5	7
H-AC-6313	556	2	63	13	1.0	8
H-AC-6913	595	2	69	13	1.0	9
H-AC-7513	636	2	75	13	1.0	10
H-AC-8113	674	2	81	13	1.0	11
H-AC-2116	293	2	21	16	0.2	3
H-AC-2716	333	2	27	16	0.3	4
H-AC-3316	374	2	33	16	0.4	5
H-AC-3916	420	2	39	16	0.4	6
H-AC-4516	459	2	45	16	0.5	7
H-AC-5116	503	2	51	16	1.0	8
H-AC-5716	542	2	57	16	1.0	9
H-AC-6316	589	2	63	16	1.0	10
H-AC-6916	627	2	69	16	1.0	11
H-AC-7516	668	2	75	16	1.0	12
H-AC-8116	711	2	81	16	1.0	13
<b>Pedestal Cushion</b>						
H-FPAC-16	278	1.25	16	19	0.7	2

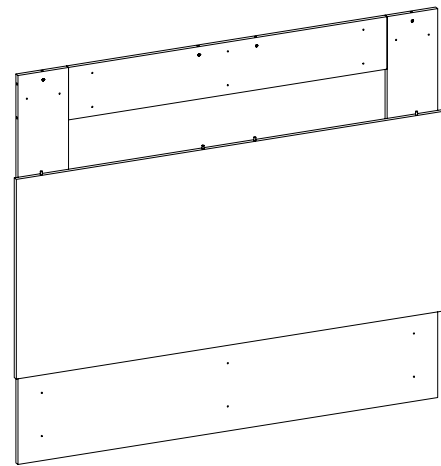

Gallery Wall for Accent Shelves

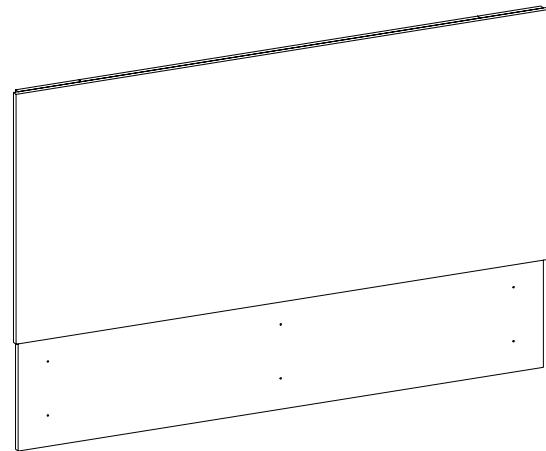

No Overheads

**What's Included:**

- Gallery wall backer,
- Gallery wall Front

**How to Specify:**

**Notes:**

**Options:**

Widths: 48", 60", 66", 72", 84", 96"

Depths: 0.75"

Height: 33", 49"

Laminate

Paint Finish

Electrics

Code	Price	H	W	D	Volume	Weight
<b>For Accent Shelves</b>						
H-CGWA-4948	964	49	48	1	0.4	12
H-CGWA-4960	1031	49	60	1	1.0	15
H-CGWA-4972	1118	49	72	1	1.0	18
H-CGWA-4984	1218	49	84	1	1.0	21
H-CGWA-4996	1253	49	96	1	1.0	21
<b>No Overheads</b>						
H-CGWN-3348	932	33	48	1	0.3	8
H-CGWN-3354	964	33	48	1	0.3	9
H-CGWN-3360	999	33	60	1	0.4	10
H-CGWN-3366	1031	33	66	1	0.4	10
H-CGWN-3372	1091	33	72	1	0.5	12
H-CGWN-3378	1124	33	78	1	0.5	13
H-CGWN-3384	1157	33	84	1	1.0	14
H-CGWN-3390	1185	33	90	1	1.0	15
H-CGWN-3396	1218	33	96	1	1.0	17



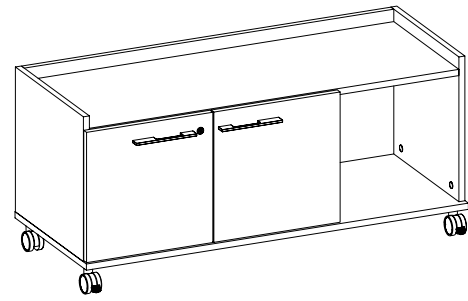

Mobile Credenza w/ Hinged Door/Open

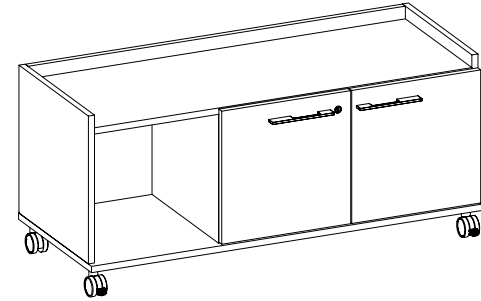

Mobile Credenza w/Open/Hinged Door

**What's Included:**

- Mobile Credenza

**How to Specify:**

**Notes:**

**Options:**

Widths: 30", 36", 42", 48"

Depths: 19"

Height: 20"

Laminate

Paint Finish

Electrics?

Code	Price	H	W	D	Volume	Weight
<b>Hinged Door/Open</b>						
H-CMHO-203019	898	20	30	19	17.0	60
H-CMHO-203619	927	20	36	19	17.0	72
H-CMHO-204219	946	20	42	19	17.0	84
H-CMHO-204819	971	20	48	19	17.0	96
<b>Open/Hinged Door</b>						
H-CMOH-203019	898	20	30	19	17.0	60
H-CMOH-203619	927	20	36	19	17.0	72
H-CMOH-204219	946	20	42	19	17.0	84
H-CMOH-204819	971	20	48	19	17.0	96

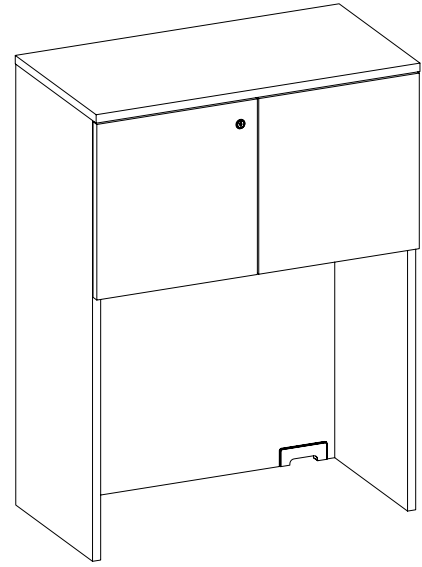

Laminate w/ hinged Door

**What's Included:**

- Laminate Gable Hutch

**How to Specify:**

To Match the width of the desk or credenza it is mounted on

**Notes:**

Item ships assembled

**Options:**

Widths: 30", 36", 42", 48", 54", 60", 66", 72", 78" 84"

Depths: 16 "

Laminate

Paint Finish

Electrics

Code	Price	H	W	D	Volume	Weight
H-SHH0-403016	978	40	30	16	10.0	56
H-SHH0-403616	1030	40	36	16	12.0	67
H-SHH0-404216	1180	40	42	16	14.0	78
H-SHH0-404816	1277	40	48	16	16.0	90
H-SHH0-405416	1387	40	54	16	18.0	101
H-SHH0-406016	1475	40	60	16	19.0	112
H-SHH0-406616	1568	40	66	16	21.0	123
H-SHH0-407216	1646	40	72	16	23.0	134
H-SHH0-407816	1730	40	78	16	25.0	146
H-SHH0-408416	1793	40	84	16	27.0	157
H-SHH0-496016	1563	49	60	16	24.0	137
H-SHH0-496616	1662	49	66	16	26.0	151
H-SHH0-497216	1745	49	72	16	29.0	165
H-SHH0-497816	1834	49	78	16	31.0	178
H-SHH0-498416	1901	49	84	16	33.0	192

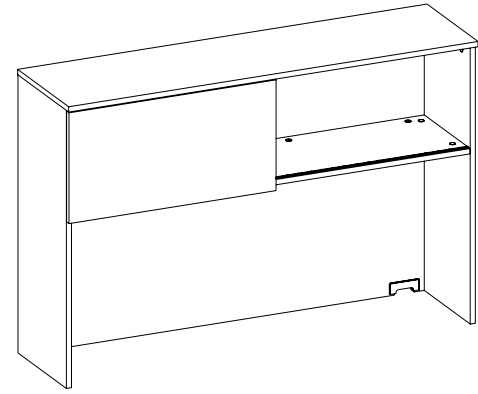

Laminate w/ sliding Door

**What's Included:**

- Laminate Gable Hutch

**How to Specify:**

To Match the width of the desk or credenza it is mounted on

**Notes:**

Item ships assembled

**Options:**

Widths: 30", 36", 42", 48", 54", 60", 66", 72", 78" 84"

Depths: 16 "

Laminate

Paint Finish

Electrics

Code	Price	H	W	D	Volume	Weight
H-SHS0-403016	1097	40	30	16	10.0	56
H-SHS0-403616	1157	40	36	16	12.0	67
H-SHS0-404216	1279	40	42	16	14.0	78
H-SHS0-404816	1332	40	48	16	16.0	90
H-SHS0-405416	1390	40	54	16	18.0	101
H-SHS0-406016	1444	40	60	16	19.0	112
H-SHS0-406616	1504	40	66	16	21.0	123
H-SHS0-407216	1558	40	72	16	23.0	134
H-SHS0-407816	1619	40	78	16	25.0	146
H-SHS0-408416	1671	40	84	16	27.0	157
H-SHS0-496016	1520	49	60	16	24.0	137
H-SHS0-496616	1577	49	66	16	26.0	151
H-SHS0-497216	1638	49	72	16	29.0	165
H-SHS0-497816	1705	49	78	16	31.0	178
H-SHS0-498416	1766	49	84	16	33.0	192

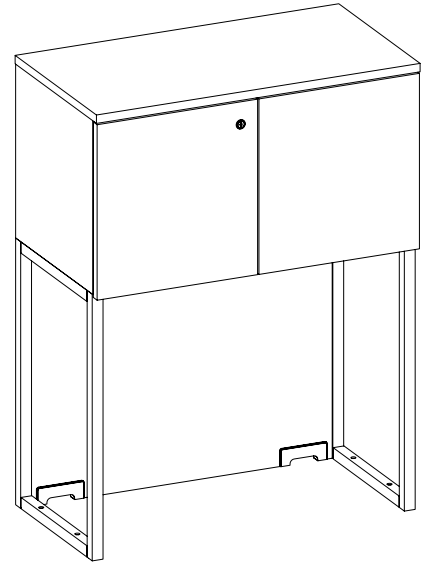

Metal w/ hinged Door

**What's Included:**

- Metal Gable Hutch

**How to Specify:**

To Match the width of the desk or credenza it is mounted on

**Notes:**

Item ships assembled

**Options:**

Widths: 30", 36", 42", 48", 54", 60", 66", 72", 78" 84"

Depths: 16 "

Laminate

Paint Finish

Electrics

Code	Price	H	W	D	Volume	Weight
H-SHHM-403016	1462	40	30	16	10.0	56
H-SHHM-403616	1507	40	36	16	12.0	67
H-SHHM-404216	1713	40	42	16	14.0	78
H-SHHM-404816	1766	40	48	16	16.0	90
H-SHHM-405416	1813	40	54	16	18.0	101
H-SHHM-406016	1866	40	60	16	19.0	112
H-SHHM-406616	2070	40	66	16	19.0	123
H-SHHM-407216	2115	40	72	16	23.0	134
H-SHHM-407816	2169	40	75	16	25.0	146
H-SHHM-408416	2215	40	84	16	27.0	157
H-SHHM-496016	1946	49	60	16	24.0	137
H-SHHM-496616	2155	49	66	16	26.0	151
H-SHHM-497216	2211	49	72	16	29.0	165
H-SHHM-497816	2263	49	78	16	31.0	178
H-SHHM-498416	2314	49	84	16	33.0	192

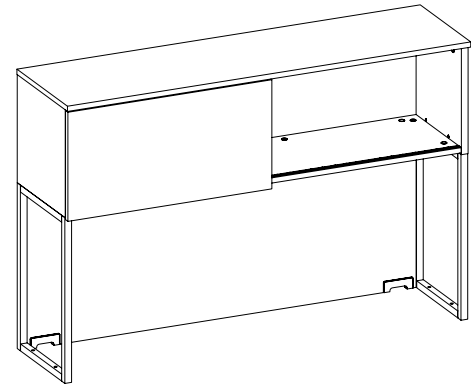

Metal w/ sliding Door

**What's Included:**

- Metal Gable Hutch

**How to Specify:**

To Match the width of the desk or credenza it is mounted on

**Notes:**

Item ships assembled

**Options:**

Widths: 30", 36", 42", 48", 54", 60", 66", 72", 78" 84"

Depths: 16 "

Laminate

Paint Finish

Electrics

Code	Price	H	W	D	Volume	Weight
H-SHSM-403016	1642	40	30	16	10.0	56
H-SHSM-403616	1703	40	36	16	12.0	67
H-SHSM-404216	1755	40	42	16	14.0	78
H-SHSM-404816	1815	40	48	16	16.0	90
H-SHSM-405416	1868	40	54	16	18.0	101
H-SHSM-406016	1928	40	60	16	19.0	112
H-SHSM-406616	1982	40	66	16	21.0	123
H-SHSM-407216	2042	40	72	16	23.0	134
H-SHSM-407816	2094	40	78	16	25.0	146
H-SHSM-408416	2155	40	84	16	27.0	157
H-SHSM-496016	2008	49	60	16	24.0	137
H-SHSM-496616	2069	49	66	16	26.0	151
H-SHSM-497216	2129	49	72	16	29.0	165
H-SHSM-497816	2188	49	78	16	31.0	178
H-SHSM-498416	2254	49	84	16	33.0	192

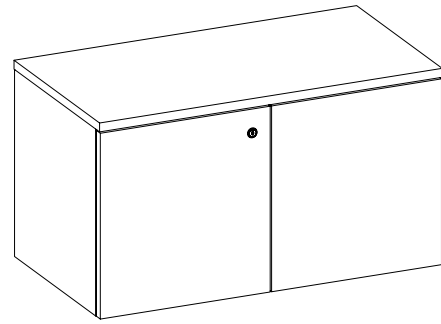

Wall mounted w/ hinged Door

**What's Included:**

- Wall mounted hinged door hutch

**How to Specify:**

To Match the width of the desk or credenza it is mounted on

**Notes:**

Item ships assembled

**Options:**

Widths: 30", 36", 42", 48", 54", 60", 66", 72", 78" 84"

---

Depths: 16"

---

Laminate

---

Paint Finish

---

Electrics

---

Code	Price	H	W	D	Volume	Weight
H-SWH0-153016	748	15	30	16	10.0	56
H-SWH0-153616	789	15	36	16	12.0	67
H-SWH0-154216	878	15	42	16	14.0	78
H-SWH0-154816	919	15	48	16	16.0	90
H-SWH0-155416	957	15	54	16	18.0	101
H-SWH0-156016	1049	15	60	16	19.0	112
H-SWH0-156616	1089	15	66	16	21.0	123
H-SWH0-157216	1130	15	72	16	23.0	134
H-SWH0-157816	1172	15	78	16	25.0	146
H-SWH0-158416	1212	15	84	16	27.0	157

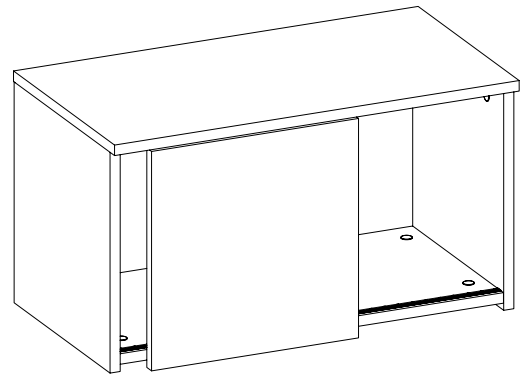

Wall mounted w/ sliding Door

**What's Included:**

- Wall mounted sliding door hutch

**How to Specify:**

To Match the width of the desk or credenza it is mounted on

**Notes:**

Item ships assembled

**Options:**

Widths: 30", 36", 42", 48", 54", 60", 66", 72", 78" 84"

Depths: 16 "

Laminate

Paint Finish

Electrics

Code	Price	H	W	D	Volume	Weight
H-SWS0-153016	903	15	30	16	10.0	56
H-SWS0-153616	948	15	36	16	12.0	67
H-SWS0-154216	994	15	42	16	14.0	78
H-SWS0-154816	1038	15	42	16	16.0	90
H-SWS0-155416	1078	15	54	16	18.0	101
H-SWS0-156016	1123	15	60	16	19.0	112
H-SWS0-156616	1166	15	66	16	21.0	123
H-SWS0-157216	1212	15	72	16	23.0	134
H-SWS0-157816	1257	15	78	16	25.0	146
H-SWS0-158416	1295	15	84	16	27.0	157

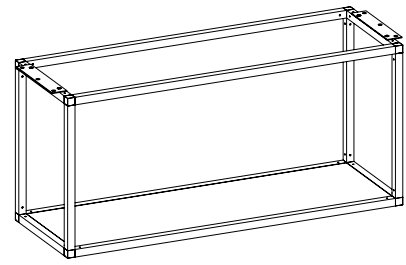

Side Mount/ No Back

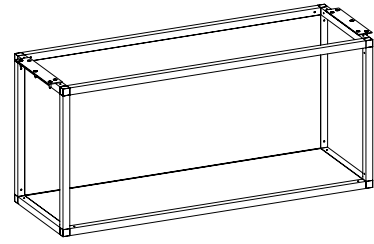

Side Mount w/ Back

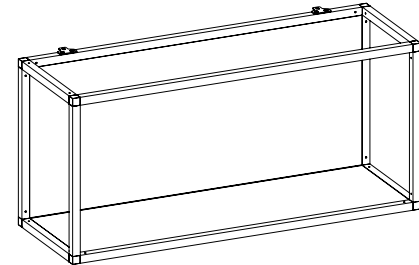

Gallery Wall Mount w/Back

**What's Included:**

- Accent Shelf

**How to Specify:**

Side mount accent shelf needs storage supporting the shelf on LH and RH

**Notes:**

Gallery wall mounted accent shelf cannot be mounted to a drywall

**Options:**

Widths: 30", 36", 42", 48"

Depths: 12"

Height: 16.5"

Laminate

Paint Finish

Electrics

Code	Price	H	W	D	Volume	Weight
<b>Side Mount/ No Back</b>						
H-ASSM-163012	2057	17	30	12	9.0	50
H-ASSM-163612	2101	17	36	12	11.0	60
H-ASSM-164212	2169	17	42	12	12.0	71
H-ASSM-164812	2241	16	48	12	14.0	81
<b>Side Mount w/ Back</b>						
H-ASSM-163012-B	2166	17	30	12	9.0	50
H-ASSM-163612-B	2211	17	36	12	11.0	60
H-ASSM-164212-B	2277	17	42	12	12.0	71
H-ASSM-164812-B	2350	17	48	12	14.0	81
<b>Gallery Wall Mount w/Back</b>						
H-ASWM-163012	2166	17	30	12	9.0	50
H-ASWM-163612	2211	15	36	12	11.0	60
H-ASWM-164212	2277	17	42	12	12.0	71
H-ASWM-164812	2350	16	48	12	14.0	81



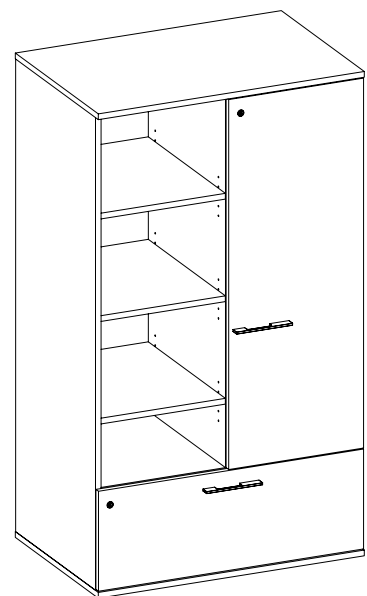

Combo Cabinet - Right  
w/Open Shelf/File Drawer

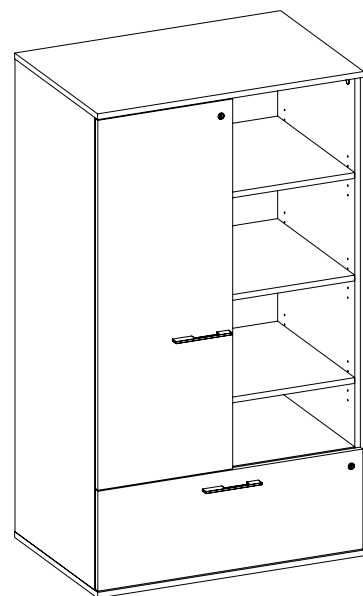

Combo Cabinet - Left  
w/Open Shelf/File Drawer

**What's Included:**

- Combo Closet

**How to Specify:**

Legs to be specified separately

**Notes:**

**Options:**

Widths: 24", 30", 36"

Depths: 19", 24"

Laminate

Paint Finish

Electrics

Code	Price	H	W	D	Volume	Weight
H-FCCF-532419-L	1429	53	24	19	13.0	102
H-FCCF-533019-L	1564	53	30	19	13.0	102
H-FCCF-533619-L	1650	53	36	19	13.0	102
H-FCCF-532419-R	1429	53	24	19	13.0	102
H-FCCF-533019-R	1564	53	30	19	13.0	102
H-FCCF-533619-R	1650	53	36	19	13.0	102
H-FCCF-532424-L	1450	53	24	24	15.0	122
H-FCCF-533024-L	1658	53	30	24	15.0	122
H-FCCF-533624-L	1751	53	36	24	15.0	122
H-FCCF-532424-R	1450	53	24	24	15.0	122
H-FCCF-533024-R	1658	53	30	24	15.0	122
H-FCCF-533624-R	1751	53	36	24	15.0	122
H-FCCF-692419-L	1521	69	24	19	17.0	132
H-FCCF-693019-L	1709	69	30	19	17.0	132
H-FCCF-693619-L	1812	69	36	19	17.0	132
H-FCCF-692419-R	1521	69	24	19	17.0	132
H-FCCF-693019-R	1709	69	30	19	17.0	132
H-FCCF-693619-R	1812	69	36	19	17.0	132
H-FCCF-692424-L	1593	69	24	24	20.0	159
H-FCCF-693024-L	1825	69	30	24	20.0	159
H-FCCF-693624-L	1932	69	36	24	20.0	159
H-FCCF-692424-R	1593	69	24	24	20.0	159
H-FCCF-693024-R	1825	69	30	24	20.0	159
H-FCCF-693624-R	1932	69	36	24	20.0	159

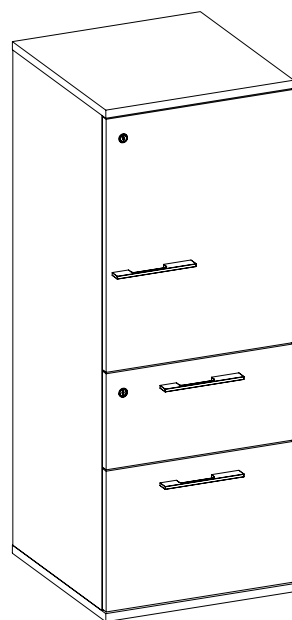

Combo Cabinet w/ single door

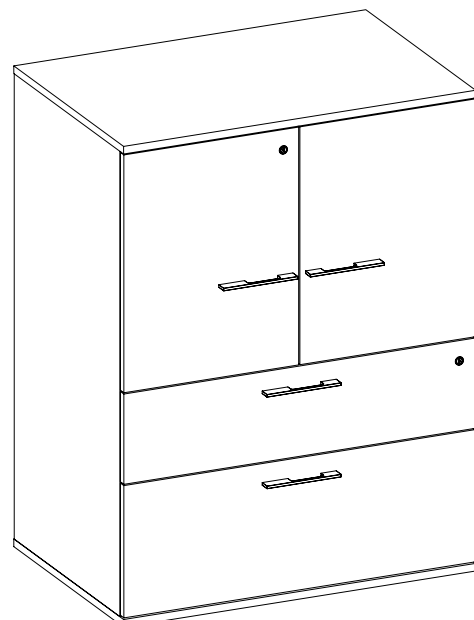

Combo Cabinet w/ double door

**What's Included:**

- Combo Cabinet

**How to Specify:**

Legs to be specified separately

**Notes:**

**Options:**

Widths: 18", 24", 30", 36", 42"

Depths: 19", 24"

Laminate

Paint Finish

Electrics

Code	Price	H	W	D	Volume	Weight
<b>Single door</b>						
H-FCSL-531819-L	1467	53	18	19	13.0	95
H-FCSL-531819-R	1467	53	18	19	13.0	95
H-FCSL-531824-L	1544	53	18	24	13.0	99
H-FCSL-531824-R	1544	53	18	24	13.0	99
H-FCSL-691819-L	1659	69	18	19	17.0	122
H-FCSL-691819-R	1659	69	18	19	17.0	122
H-FCSL-691824-L	1714	69	18	24	17.0	130
H-FCSL-691824-R	1714	69	18	24	17.0	130
<b>Double Door</b>						
H-FCSL-532419	1832	53	24	19	13.0	102
H-FCSL-533019	1946	53	30	19	16.0	127
H-FCSL-533619	2066	53	36	19	19.0	153
H-FCSL-534219	2178	53	36	24	22.0	178
H-FCSL-532424	1916	53	24	19	15.0	122
H-FCSL-533024	2042	53	30	24	19.0	153
H-FCSL-533624	2169	53	36	24	23.0	183
H-FCSL-534224	2283	53	42	24	27.0	214
H-FCSL-692419	2010	69	24	19	17.0	132
H-FCSL-693019	2142	69	30	19	21.0	166
H-FCSL-693619	2229	69	36	19	25.0	199
H-FCSL-694219	2342	69	42	19	29.0	232
H-FCSL-692424	2122	69	24	24	20.0	159
H-FCSL-693024	2269	69	30	24	25.0	199
H-FCSL-693624	2416	69	36	24	30.0	238
H-FCSL-694224	2529	69	42	19	35.0	278

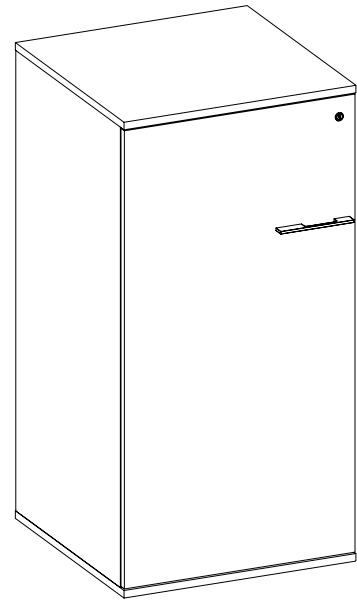

Locker Tower with Shelves

**What's Included:**

- Locker Tower with Shelves

**How to Specify:**

Legs to be specified separately

**Notes:**

**Options:**

Widths: 12", 18", 24"

Depths: 16", 19", 24", 30"

Laminate

Paint Finish

Electrics

Code	Price	H	W	D	Vol.	Wt.
H-FCKT-531216-L	1124	53	12	16	5.0	34
H-FCKT-531816-L	1238	53	18	16	7.0	51
H-FCKT-532416-L	1362	53	24	16	11.0	68
H-FCKT-531216-R	1124	53	12	16	5.0	34
H-FCKT-531816-R	1238	53	18	16	7.0	51
H-FCKT-532416-R	1362	53	24	16	11.0	68
H-FCKT-531219-L	1174	53	12	19	6.0	40
H-FCKT-531819-L	1318	53	18	19	8.0	60
H-FCKT-532419-L	1450	53	24	19	10.0	81
H-FCKT-531219-R	1174	53	12	19	6.0	40
H-FCKT-531819-R	1318	53	18	19	8.0	60
H-FCKT-532419-R	1450	53	24	19	10.0	81
H-FCKT-531224-L	1269	53	12	24	7.0	51
H-FCKT-531824-L	1411	53	18	24	9.0	76
H-FCKT-532424-L	1558	53	24	24	11.0	102
H-FCKT-531224-R	1269	53	12	24	7.0	51
H-FCKT-531824-R	1411	53	18	24	9.0	76
H-FCKT-532424-R	1558	53	24	24	11.0	102
H-FCKT-531230-L	1367	53	12	30	8.0	64
H-FCKT-531830-L	1509	53	18	30	10.0	95
H-FCKT-532430-L	1668	53	24	30	12.0	127
H-FCKT-531230-R	1367	53	12	30	8.0	64
H-FCKT-531830-R	1509	53	18	30	10.0	95

Code	Price	H	W	D	Vol.	Wt.
H-FCKT-532430-R	1668	53	24	30	12.0	127
H-FCKT-691216-L	1272	69	12	16	13.0	44
H-FCKT-691816-L	1415	69	18	16	9.0	66
H-FCKT-692416-L	1563	69	24	16	12.0	88
H-FCKT-691216-R	1272	69	12	16	13.0	44
H-FCKT-691816-R	1415	69	18	16	9.0	66
H-FCKT-692416-R	1563	69	24	16	12.0	88
H-FCKT-691219-L	1360	69	12	19	6.0	52
H-FCKT-691819-L	1503	69	18	19	9.0	79
H-FCKT-692419-L	1664	69	24	19	13.0	105
H-FCKT-691219-R	1360	69	12	19	6.0	52
H-FCKT-691819-R	1503	69	18	19	9.0	79
H-FCKT-692419-R	1664	69	24	19	13.0	105
H-FCKT-691224-L	1502	69	12	24	7.0	66
H-FCKT-691824-L	1618	69	18	24	10.0	99
H-FCKT-692424-L	1792	69	24	24	14.0	132
H-FCKT-691224-R	1502	69	12	24	7.0	66
H-FCKT-691824-R	1618	69	18	24	10.0	99
H-FCKT-692424-R	1792	69	24	24	14.0	132
H-FCKT-691230-L	1587	69	12	30	8.0	83
H-FCKT-691830-L	1730	69	18	30	11.0	124
H-FCKT-692430-L	1918	69	24	30	15.0	166
H-FCKT-691230-R	1587	69	12	30	8.0	83

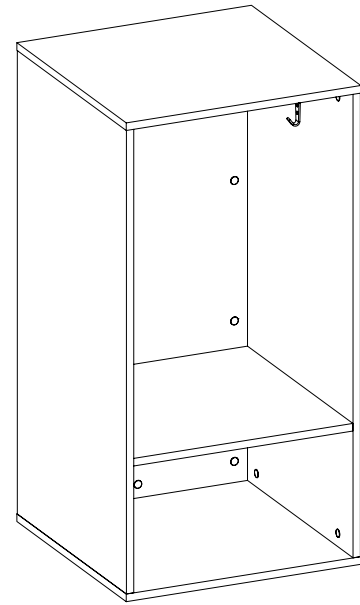

Side Access Locker w/ Open Shelf/Open Bottom

**What's Included:**

- Side Access Locker with a shelf and coat hooks

**How to Specify:**

Legs to be specified separately

**Notes:**

**Options:**

Widths: 12", 18", 24"

Depths: 16", 19", 24"

Laminate

Paint Finish

Electrics

Code	Price	H	W	D	Volume	Weight
H-FCCO-531816	777	53	18	16	7.0	44
H-FCCO-532416	831	53	16	24	10.0	58
H-FCCO-531819	876	53	18	19	8.0	52
H-FCCO-532419	886	53	24	19	11.0	69
H-FCCO-531824	882	53	18	24	9.0	65
H-FCCO-532424	943	53	24	24	12.0	87
H-FCCO-691816	850	69	18	16	9.0	57
H-FCCO-692416	910	69	24	16	12.0	76
H-FCCO-691819	895	69	18	19	10.0	67
H-FCCO-692419	960	69	19	24	13.0	90
H-FCCO-691824	976	69	18	24	11.0	85
H-FCCO-692424	1051	69	24	24	14.0	114

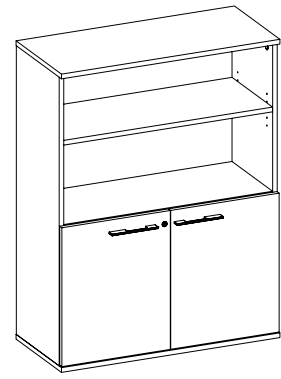

Bottom hinged

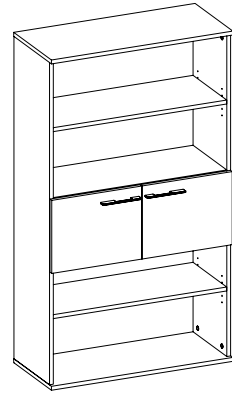

Middle hinged

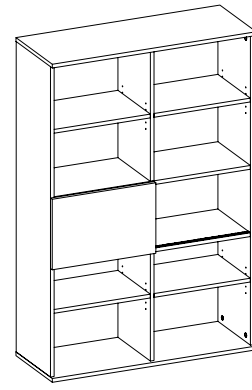

Sliding Door

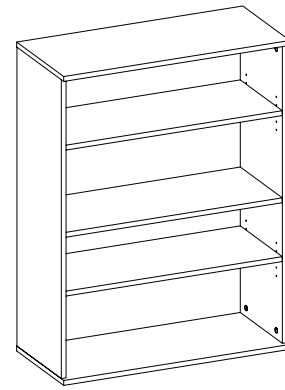

Open

**What's Included:**

- Bookcase

**How to Specify:**

Legs to be specified separately

**Notes:**

**Options:**

Widths: 24", 30", 36", 42", 48", 54", 60"

Depths: 16"

Height: 53", 69"

Laminate

Paint Finish

Electrics

Code	Price	H	W	D	Vol.	Wt.
<b>Bottom Hinged</b>						
H-BCBH-532416	1316	53	24	16	7.0	42
H-BCBH-533016	1405	53	30	16	9.0	50
H-BCBH-533616	1489	53	36	16	10.0	59
H-BCBH-534216	1802	53	42	16	12.0	67
H-BCBH-534816	1885	53	48	16	13.0	76
H-BCBH-535416	2039	53	54	16	15.0	84
H-BCBH-536016	2132	53	60	16	16.0	92
H-BCBH-692416	1484	69	24	16	10.0	56
H-BCBH-693016	1590	69	30	16	12.0	67
H-BCBH-693616	1686	69	36	16	14.0	78
H-BCBH-694216	2041	69	42	16	16.0	90
H-BCBH-694816	2145	69	48	16	18.0	101
H-BCBH-695416	2342	69	54	16	19.0	112
H-BCBH-696016	2441	69	60	16	21.0	123
<b>Middle Hinged</b>						
H-BCMh-693016	1547	69	30	16	12.0	67
H-BCMh-693616	1645	69	36	16	14.0	78
H-BCMh-694216	1993	69	42	16	16.0	90
H-BCMh-694816	2090	69	48	16	18.0	101
H-BCMh-695416	2259	69	54	16	19.0	112
H-BCMh-696016	2357	69	54	16	21.0	123
<b>Sliding Door</b>						
H-BCMS-693016	1734	69	30	16	12.0	67
H-BCMS-693616	1945	69	36	16	14.0	78
H-BCMS-694216	2048	69	42	16	16.0	90
H-BCMS-694816	2261	69	48	16	18.0	101
H-BCMS-695416	2434	69	54	16	19.0	112
H-BCMS-696016	2548	69	60	16	21.0	123

Code	Price	H	W	D	Vol.	Wt.
<b>Open</b>						
H-BCOO-532416	993	53	24	16	7.0	42
H-BCOO-533016	1098	53	30	16	9.0	50
H-BCOO-533616	1200	53	36	16	10.0	59
H-BCOO-534216	1345	53	42	16	12.0	67
H-BCOO-534816	1423	53	48	16	13.0	76
H-BCOO-535416	1570	53	54	16	15.0	84
H-BCOO-536016	1640	53	60	16	16.0	92
H-BCOO-692416	1162	69	24	16	10.0	56
H-BCOO-693016	1289	69	30	16	12.0	67
H-BCOO-693616	1416	69	36	16	14.0	78
H-BCOO-694216	1593	69	42	16	16.0	90
H-BCOO-694816	1676	69	48	19	18.0	101
H-BCOO-695416	1866	69	54	16	19.0	112
H-BCOO-696016	1956	69	60	16	21.0	123
H-BCOO-532419	1092	53	24	19	8.0	47
H-BCOO-533019	1208	53	30	19	9.0	50
H-BCOO-533619	1322	53	36	19	12.0	66
H-BCOO-534219	1443	53	42	19	13.0	76
H-BCOO-534819	1528	53	48	19	15.0	85
H-BCOO-535419	1703	53	54	19	16.0	95
H-BCOO-536019	1780	53	60	19	18.0	104
H-BCOO-692419	1279	69	24	19	11.0	63
H-BCOO-693019	1419	69	30	19	13.0	76
H-BCOO-693619	1557	69	36	19	15.0	89
H-BCOO-694219	1709	69	42	16	18.0	101
H-BCOO-694819	1810	69	48	19	20.0	114
H-BCOO-695419	2005	69	54	19	22.0	127
H-BCOO-696019	2102	69	60	19	24.0	139

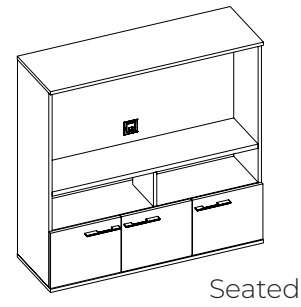

Seated

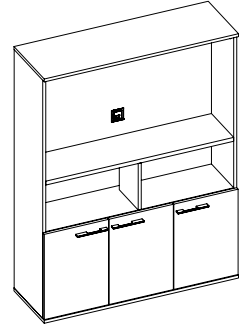

Standing

**What's Included:**

- AV Unit

**How to Specify:**

Legs to be specified separately

**Notes:**

- Seated 48"W unit accommodates up to 40" flat screen TV
- Seated 60"W unit accommodates up to 65" flat screen TV
- Standing 48"W unit accommodates up to 48" flat screen TV

**Options:**

Widths: 48", 60"

Depths: 16"

Height: 53", 69"

Laminate

Paint Finish

Electrics

Code	Price	H	W	D	Volume	Weight
<b>Seated w/finished Back</b>						
H-AVL0-534816	2134	53	48	16	16.0	142
H-AVL0-696016	2578	69	60	16	27.0	232
<b>Seated /no finished back</b>						
H-AVLN-534816	1888	53	48	16	21.0	142
H-AVLN-696016	2219	69	60	16	21.0	232
<b>Standing w/finished back</b>						
H-AVS0-694816	2342	69	48	16	16.0	185
<b>Standing /no finished back</b>						
H-AVSN-694816	2041	69	48	16	27.0	185

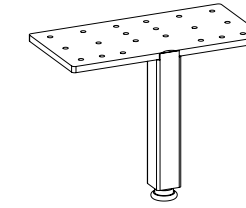
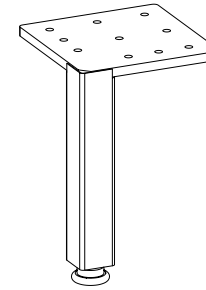

**What's Included:**

- 1 Storage support leg and hardware

**How to Specify:**

- Single or Shared
- Shared leg is used the front of two cabinet joints

**Options:**

Widths: 0

Depths: 0

Laminate

Paint Finish

Electrics

Code	Price	H	W	D	Volume	Weight
H-HCL-1	45	6	0	0	0.0	1
H-HCL-2	47	6	0	0	0.0	2

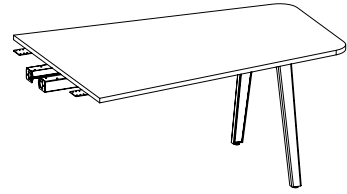

A-Leg No Grommet

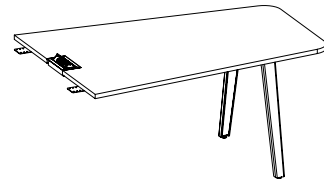

A-Leg Grommet

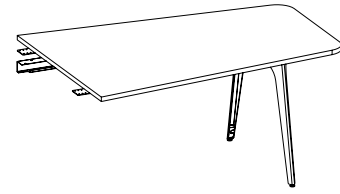

V-Leg No Grommet

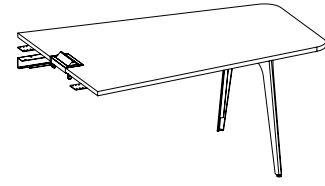

V-Leg Grommet

**What's Included:**

- Worksurface
- Legs
- Reinforcement Bars
- Optional Power

**How to Specify:**

6" smaller than the width of the AV Unit

**Notes:**

One of the A-Legs will come with an infill with a small hole to run wires out the bottom

**Options:**

Widths: 48", 60", 72", 84"

Depths: 42", 54",

Laminate

Paint Finish

Electrics

**A-Leg**

Code	Price	H	W	D	Vol.	Wt.
No Grommet						
H-TAAN-294842	1442	29	48	42	5.0	69
H-TAAN-294854	1585	29	48	54	5.0	88
H-TAAN-296042	1547	29	60	42	6.0	86
H-TAAN-296054	1703	29	60	54	6.0	111
H-TAAN-297254	1847	29	72	54	7.0	133
H-TAAN-298454	1992	29	84	54	8.0	155
H-TAAN-424842	1605	42	48	42	5.0	100
H-TAAN-426042	1709	42	60	42	6.0	125
w/ Grommet						
H-TAAH-294842	2473	29	48	42	5.0	69
H-TAAH-294854	2615	29	48	54	5.0	88
H-TAAH-296042	2577	29	60	42	6.0	86
H-TAAH-296054	2735	29	60	54	6.0	111
H-TAAH-297254	2878	29	72	54	7.0	133
H-TAAH-298454	3022	29	84	54	8.0	155
H-TAAH-424842	2637	42	48	42	5.0	100
H-TAAH-426042	2741	42	60	42	6.0	125

**V-Leg**

Code	Price	H	W	D	Vol.	Wt.
No Grommet						
H-TAVN-294842	1353	29	48	42	5.0	69
H-TAVN-294854	1408	29	48	54	5.0	88
H-TAVN-296042	1423	29	60	42	6.0	86
H-TAVN-296054	1495	29	60	54	6.0	111
H-TAVN-297254	1570	29	72	54	7.0	133
H-TAVN-298454	1686	29	84	54	8.0	155
H-TAVN-424842	1499	42	48	42	5.0	100
H-TAVN-426042	1570	42	60	42	6.0	125
w/ Grommet						
H-TAVH-294842	2382	29	48	42	5.0	69
H-TAVH-294854	2439	29	48	54	5.0	88
H-TAVH-296042	2452	29	60	42	6.0	86
H-TAVH-296054	2523	29	60	54	6.0	111
H-TAVH-297254	2600	29	72	54	7.0	133
H-TAVH-298454	2717	29	84	54	8.0	155
H-TAVH-424842	2529	42	48	42	5.0	100
H-TAVH-426042	2599	42	60	42	6.0	125



Halifax Pricebook  
May 2023  
**Accessories**

Accessories

PET Acoustic board	176
Power	178
Purse Hook, Shelf, Metal Storage	179
Tasklight	180
Monitor Arm	181



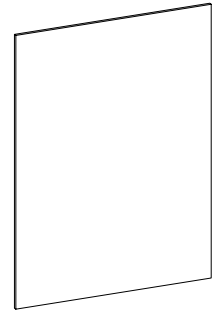

Gallery Wall Slim

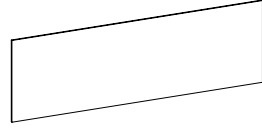

Gallery Wall/ Hutch - High Credenza

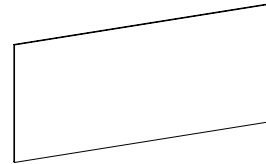

Gallery Wall/ Hutch - Low Credenza

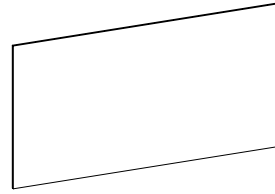

Locker Tower

**What's Included:**

- PET acoustic board

**How to Specify:**

**Notes:**

**Options:**

Widths: 9", 12", 18", 24", 26", 32", 38", 44", 50", 56", 62", 68", 74", 80", 86", 92"

Depths: 0.5"

Laminate

Paint Finish

Electrics

Code	Price	H	W	D	Volume	Weight
<b>For Gallery Wall Slim</b>						
H-PFG-3209	146	32	9	1	0.1	1
H-PFG-3212	166	32	12	1	0.1	2
H-PFG-3218	257	32	18	1	0.2	3
H-PFG-3224	270	32	24	0	0.2	4
<b>For Gallery Wall / Hutch - High Credenza</b>						
H-PFH-2226	283	22	26	1	0.2	3
H-PFH-2232	292	22	32	1	0.2	1
H-PFH-2238	378	22	38	1	0.3	4.18
H-PFH-2244	395	22	44	1	0.3	5
H-PFH-2250	560	22	50	1	0.3	6
H-PFH-2256	565	22	56	1	0.4	6
H-PFH-2262	571	22	62	1	0.4	7
H-PFH-2268	575	22	68	1	0.5	7
H-PFH-2274	673	22	74	1	0.5	8
H-PFH-2280	677	22	80	1	1.0	9
H-PFH-2286	685	22	86	1	1.0	9
H-PFH-2292	689	22	92	1	1.0	10
<b>For Gallery Wall / Hutch - Low Credenza</b>						
H-PFH-3126	285	31	26	1	0.2	4
H-PFH-3132	287	31	32	1	0.3	5
H-PFH-3138	384	31	38	1	0.4	6
H-PFH-3144	389	31	44	1	0.4	7
H-PFH-3150	560	31	50	1	0.5	8
H-PFH-3156	563	31	56	1	1.0	9
H-PFH-3162	567	31	62	1	1.0	10
H-PFH-3168	569	31	68	1	1.0	11
H-PFH-3174	673	31	74	1	1.0	11
H-PFH-3180	679	31	80	1	1.0	12
H-PFH-3186	685	31	86	1	1.0	13
H-PFH-3192	689	31	92	1	1.0	14
<b>For Locker Tower</b>						
H-PFL-4718	326	47	18	1	0.3	4
H-PFL-4724	330	47	24	1	0.3	5
H-PFL-6318	486	63	18	1	0.3	6
H-PFL-6324	563	63	24	1	0.3	7

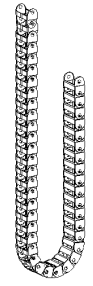

E-Chain Wire Manager

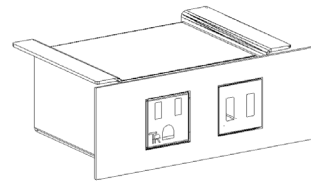

Grommet, Side Mounted, Side Mounted Module  
1 Outlet + Dual USB Ports With Power And USB

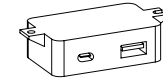
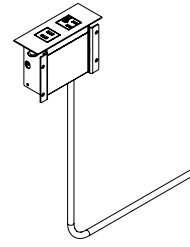

Side Mounted USB A & C,  
1 Module, with AC Adapter

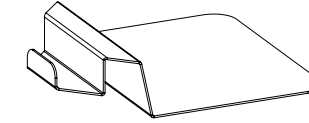
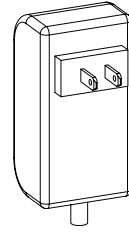

Purse Hook

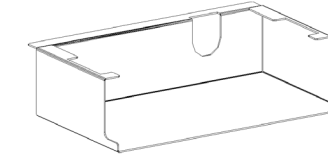

Under Mount Open Shelf

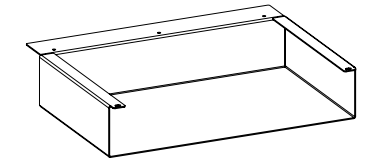

Metal Storage,-  
For Under Hutch

Code	Price	H	W	D	Volume	Weight
E-Chain Wire Manager						
V-EE-28	278	28	0	0	1.0	1.0
Grommet, Side Mounted, 1 Outlet + Dual USB Ports						
H-EGS-U	283	28	0	0	0.1	1.0
USB adapter (1ea USB A & C ports with adapter)						
V-ESMU-A	169				2.0	2.0
Side Mounted USB, 4 Module, With Hub						
V-ESMU-K	939				2.0	2.0
Side Mounted Module With Power And USB						
V-ESMU-P	245				2.0	2.0
RJ11 Jack W/84" Cable						
H-RJ11	73				0.2	1.1
RJ45, Cat6 W/Cord 72", Black						
H-RJ45	193				0.2	1.2
HDMI Coupler, 18"Cord,F/F						
H-HDMI	186				0.2	1.1

Code	Price	H	W	D	Volume	Weight
Purse Hook						
H-APH	164	0	0	0	2.2	0.5
Under Mount Open Shelf						
H-AUS-1209	134	3	12	9	0.3	1
Metal Storage,For Under Hutch						
H-SHUS-031409	138	4	14	10	0.0	0

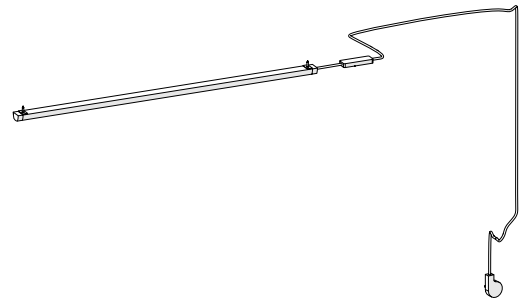

Halifax LED Light 30"(1) with transformer, Wire manager, Mounting Plate and hardware

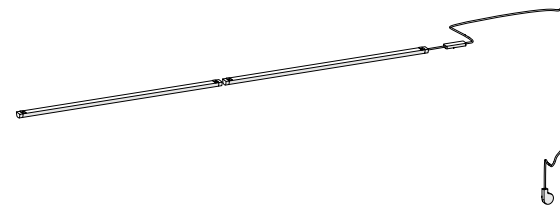

Halifax LED Light 30"(2) with transformer, Wire manager, Mounting Plate and hardware

**What's Included:**

- LED Tasklight
- Transformer
- Mounting Plate
- Mounting Hardware

**How to Specify:**

3666 fits under overheads between 36"-66"W  
 7284 fits under overheads between 72-84"W

**Notes:**

7284 consists of two 30" lights  
 Hardware includes screws for wood overhead and magnets for metal overheads

**Options:**

Available in Silver only

Code	Price
Tasklight	
V-ELU-3666	398
V-ELU-7284	738

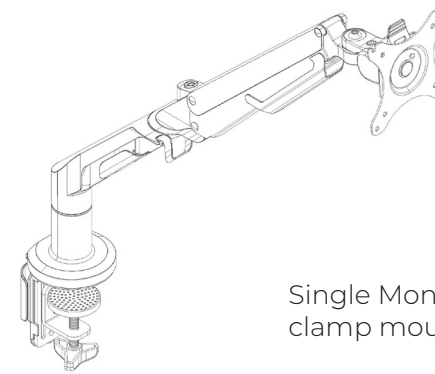

Single Monitor Arm - clamp mount

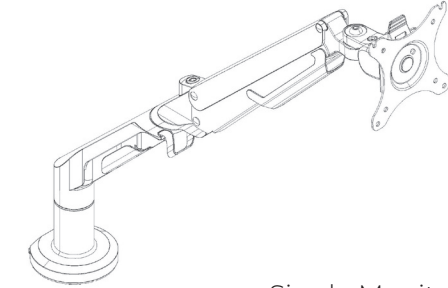

Single Monitor Arm - grommet mount

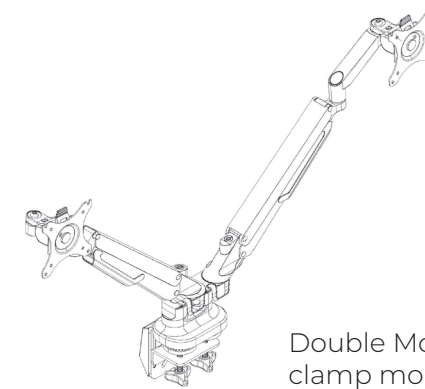

Double Monitor Arm - clamp mount

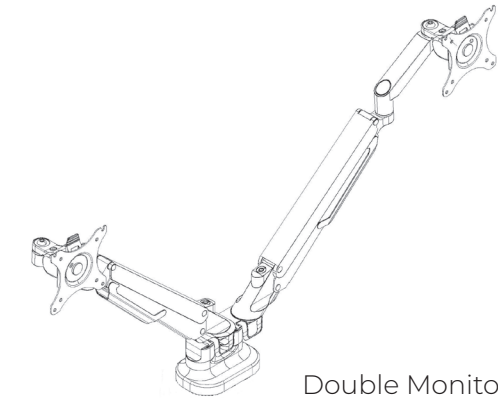

Double Monitor Arm - grommet mount

**What's Included:**

One monitor arm and installation hardware for both clamp and grommet mount

**How to Specify:**

- Specify type

**Notes:**

Available in silver and black  
 Single Monitor Arm  
 • Screen Size - 17"-36"  
 • Load Capacity - 6.6-26.4lbs/3-12kg  
 • Tilt Range - -90 degrees - -15 degrees  
 Dual Monitor Arm  
 • Screen Size - 17"-32"  
 • Load Capacity - 4.4-19.8lbs/2-9kg  
 • Tilt Range - -90 degrees - -15 degrees

**Dimensions:**

Vesa: 75x75 and 100x100

Code	Price
Monitor Arm - Single Mount	
V-AFMA-01	353
Monitor Arm - Double Mount	
V-AFMA-02	589