



# Switch USA Pricebook May 2023

Contract# - MA220000002843

# Contents

Statement of Line	vi
Space Division	vi
Worksurface & Supports	viii
Connections & Trims	x
Storage	xi
Electrics	xii
Accessories	xii
Segment Types	xiii
Cautions	xiv
Application Guidelines	xv
Types of Surfaces	xv
Gallery Panel Planning	xvi
Connection Types - Panel Doors	xvii
Connection Types - Sliding Doors	xviii
Connection Types - Fillers	xix
Wire Play Planning	xxi
Panels	3
Standard Panel - Monolithic	4
Non Powered Capable	4
Powered Capable	8
Standard - Integrated	12
Non Powered	12
Powered	28
Elevated - Monolithic	44
Elevated - Integrated	48
Gallery - Woodgrain	64
Horizontal Grain	64
Vertical Grain	76
Gallery - Solid	88
Frameless Blade	100
Standard & Elevated Panel Mounted Glass	100
Standard & Elevated Panel Mounted Acrylic	102
Gallery Panel Mounted Glass	104
Gallery Panel Mounted Acrylic	106

Panel Mounted Add Ons	108
Whiteboard	108
Tackboard	109
Doors	110
Hinged	110
Sliding	112
Connections & Trims	116
2-Way Connection	118
3-Way T Connection	119
4-Way X Connection	120
Top Cap	121
Full Height End Trim	122
Partial Height End Trim	123
Full Height T Filler	124
Partial Height T Filler	125
90 Degree Filler-Full Height	126
90 Degree Filler- Partial Height	127
Connections and Trims	128
Connections and Trims	129
Adjustable Connections and Trims	130
Worksurfaces	132
Straight w grommet	134
Straight Worksurface w/o Grommet	136
Straight Worksurface w/ Wire Play	140
5-sided w Grommet	144
Straight Worksurface with Wire Play	146
Unitized w/ Grommet	148
Unitized w/ Wire Play	150
Transaction Top	152

<b>Supports</b>	<b>154</b>
Ladder Gable	156
Standard Panel	156
Gallery Panel	158
Freestanding Panel	160
Laminate Gable	161
Standard Panel	161
Gallery Panel	162
Freestanding	163
Wrap Gable	164
Standard Panel	164
Gallery Panel	165
Tech Drop	166
Cantilever	167
Standard Panel	167
Gallery Panel	168
Standard Panel Mount Corner Bracket	169
Flush Plates	170
Storage Support Bracket	171
Fixed Credenza Support Bracket	172
90 Degree Storage Bracket	173
<b>Electrics</b>	<b>175</b>
Power Module	176
Power & Data	177
Connector Harness	178
Male to Female Extension Harness	180
New York Junction Box	181
Chicago Electrical Box	182
Wire Manager	183
Communication Kit	184
Conversion Kit	185

<b>Storage</b>	<b>187</b>
Pedestals	188
Underdesk Pedestal	188
Mobile	189
Upholstered Seat Pad	190
Lateral File	191
Underdesk	191
Freestanding	192
Credenza	193
Open Lateral	193
Storage Tower	194
Wardrobe Tower	195
Combo Tower	196
w/ Front Access	196
w/ Side Access	198
Panel Mounted Overheads - Cabinet	200
Flipper	200
Hinged Door	201
Shared	202
Cubby	204
Metal Shelf	205
<b>Accessories</b>	<b>206</b>
Cable manager	208
Desktop Power ModulePower & Data	209
Tasklight	210
Monitor Arm	211
Keyboard Tray	212
Accessories	213
Accessory Rail	214
Pencil Tray	215

# Statement of Line

## Space Division

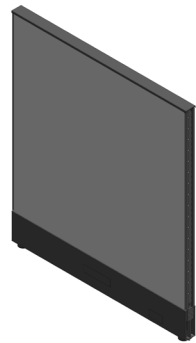

L-PPFO  
Standard Fabric Panel  
H: 34", 42", 50", 66", 82"  
W: 24" - 72"  
\*66"H available up to 60"W  
\*82"H available up to 48"W

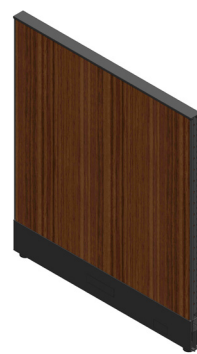

L-PPLO  
Standard Laminate Panel  
H: 34", 42", 50", 66", 82"  
W: 24" - 48"  
\*82"H available up to 36"W



L-PPFCA/LPPFCG  
L-PPFFA/L-PPFFG  
Standard Segmented Laminate Panel  
H: 34", 42", 50", 66", 82"  
W: 24" - 60"  
\*82"H available up to 48"W



L-PPLCA/LPPLCG  
L-PPLFA/L-PPLFG  
Standard Segmented Laminate Panel  
H: 34", 42", 50", 66", 82"  
W: 24" - 60"  
\*82"H available up to 36"W



L-PYSE-S1/ L-PYSM-S1  
Solid Single Gallery Panel  
H: 34", 42", 50"  
W: 26" - 74"



L-PYGE-S1/L-PYSM-S1  
Woodgrain Single Gallery Panel  
H: 34", 42", 50"  
W: 26" - 56"



L-PD00  
Hinge Door  
H: 82"  
W: 36", 42"



L-PDS  
Sliding Door  
H: 66"  
W: 30", 36", 42"

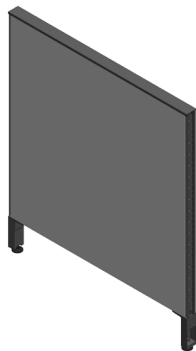

L-PEFO  
Elevated Fabric Panel  
H: 34", 42", 50", 66", 82"  
W: 24" - 72"  
\*66"H available up to 60"W  
\*82"H available up to 48"W



L-PELO  
Elevated Laminate Panel  
H: 34", 42", 50", 66", 82"  
W: 24" - 48"  
\*82"H available up to 36"W

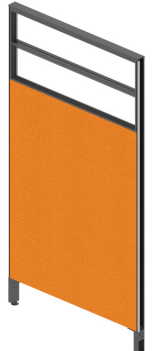

L-PEFCA/LPEFCG  
L-PEFFA/L-PEFFG  
Elevated Integrated Fabric Panel  
H: 34", 42", 50", 66", 82"  
W: 24" - 60"  
\*82"H available up to 48"W



L-PELCA/LPELCG  
L-PELFA/L-PELFG  
Elevated Integrated Laminate Panel  
H: 34", 42", 50", 66", 82"  
W: 24" - 60"  
\*82"H available up to 36"W

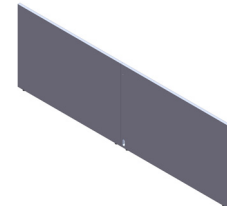

L-PYSE-D1/D2/ L-PYSM-D1/D2  
Solid Double Gallery Panel  
H: 34", 42", 50"  
W: 42" - 146"



L-PYGE-01/02/ L-PYGM-D1/D2  
Woodgrain Double Gallery Panel  
H: 34", 42", 50"  
W: 42" - 110"

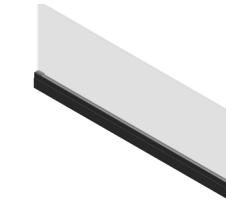

L-VG-P/ L-VA-P  
Frameless Glass Standard Panel Mount  
H: 8", 16", 20"  
W: 24" - 72"

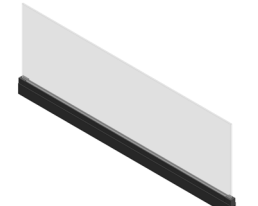

L-VG-Y/ L-VA-Y  
Frameless Glass Gallery Panel Mount  
H: 8", 16"  
W: 24" - 60"

## Worksurface & Supports

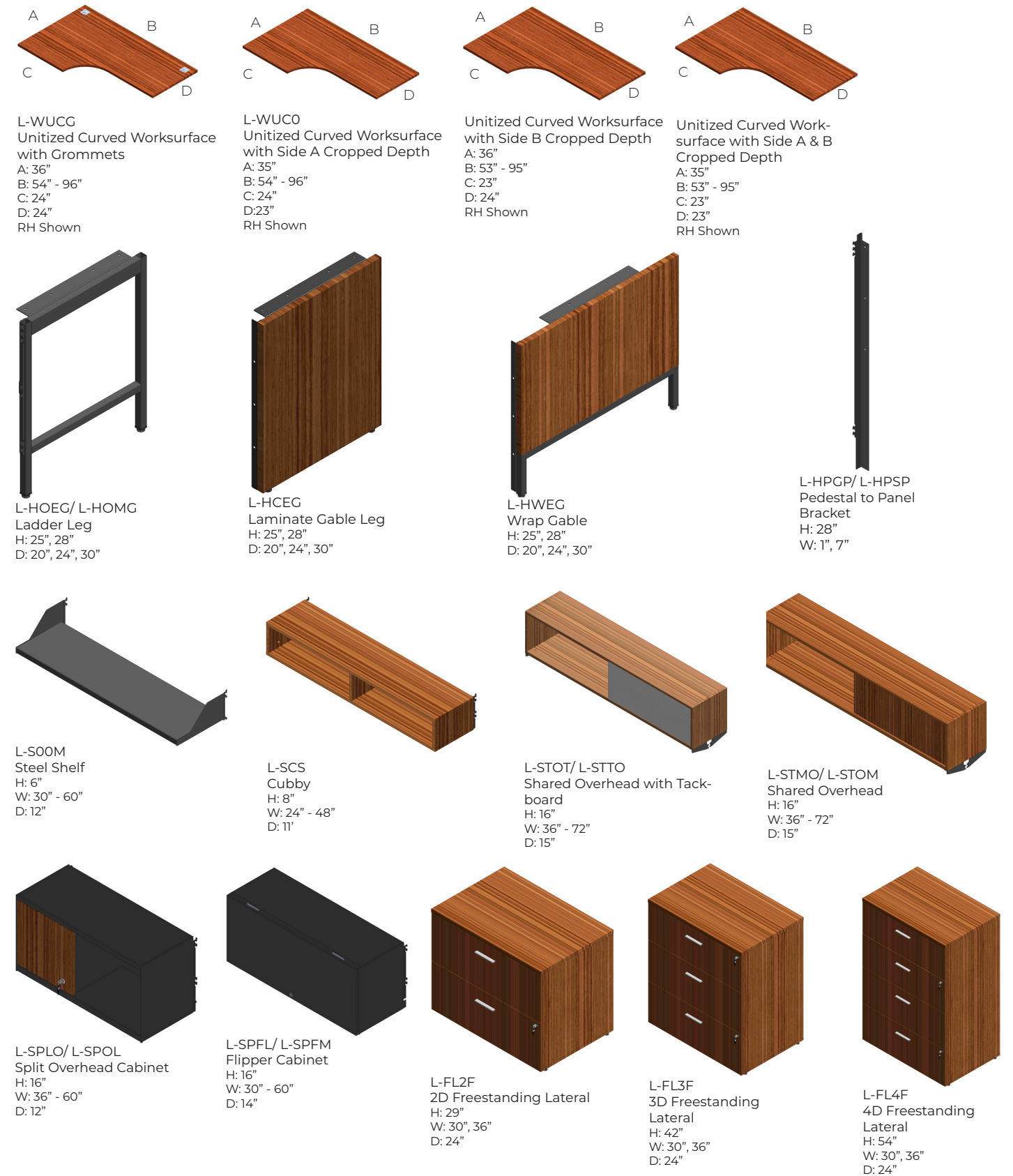

## Connections & Trims

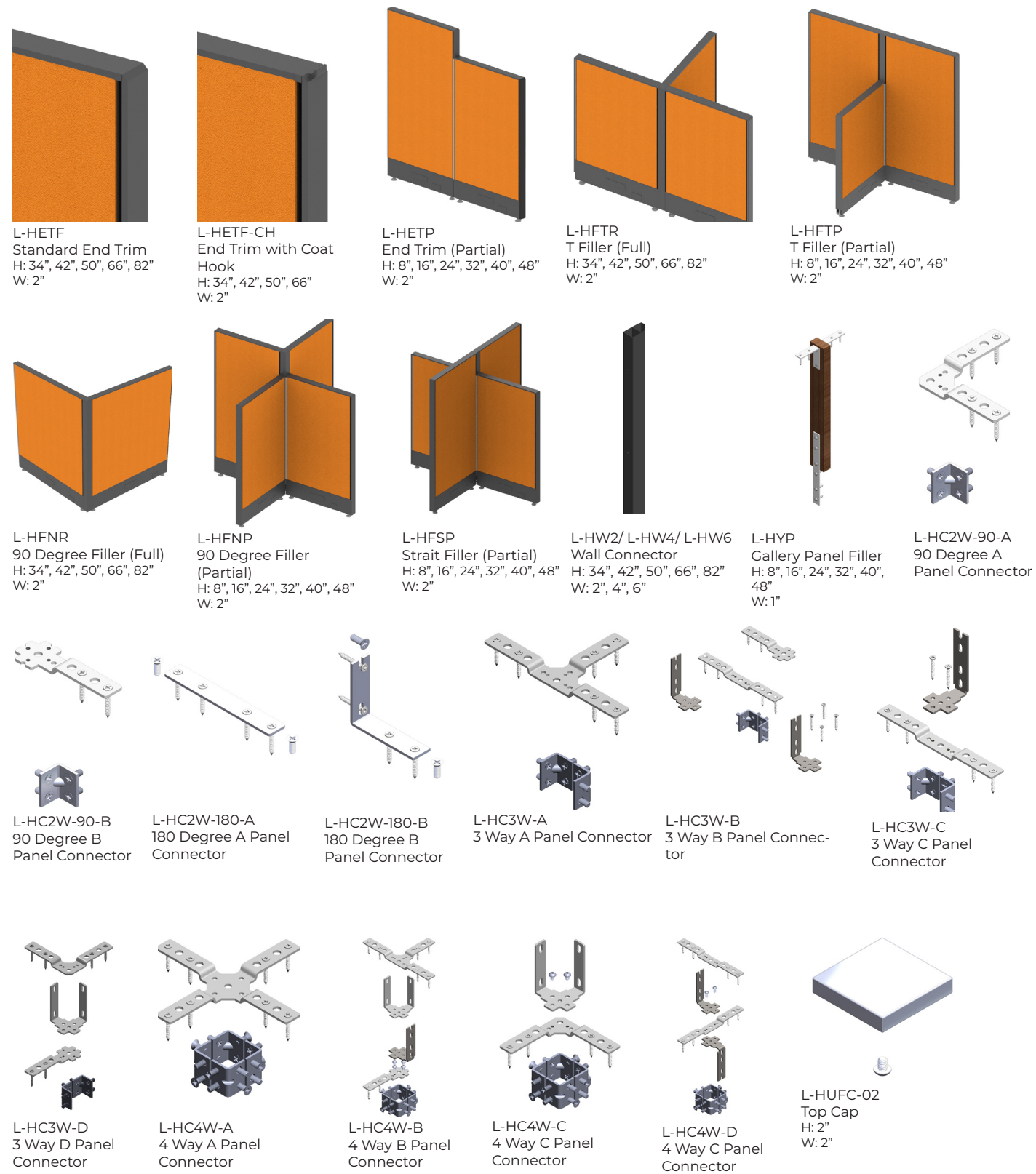

## Storage

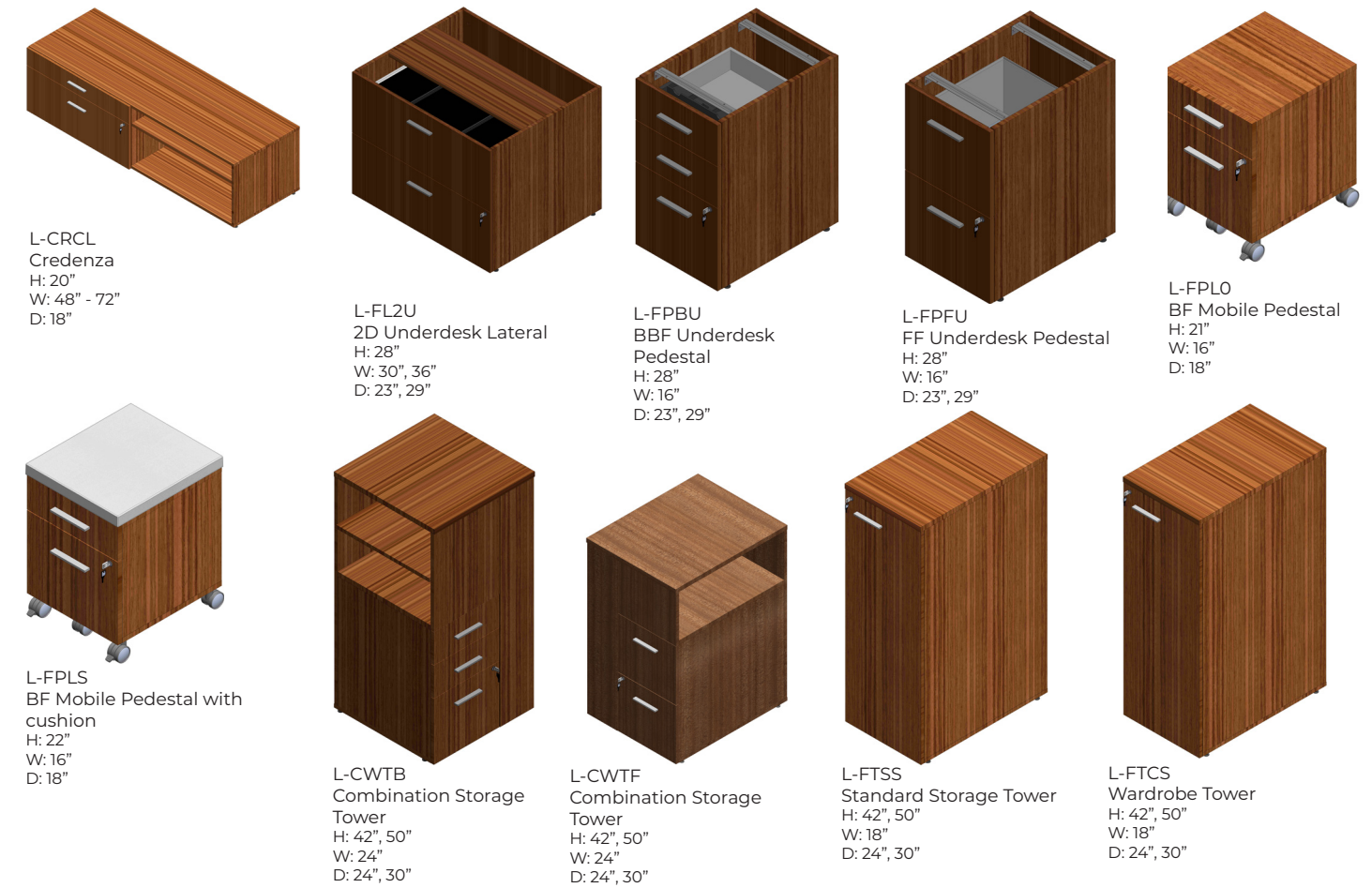

## Electrics



## Accessories

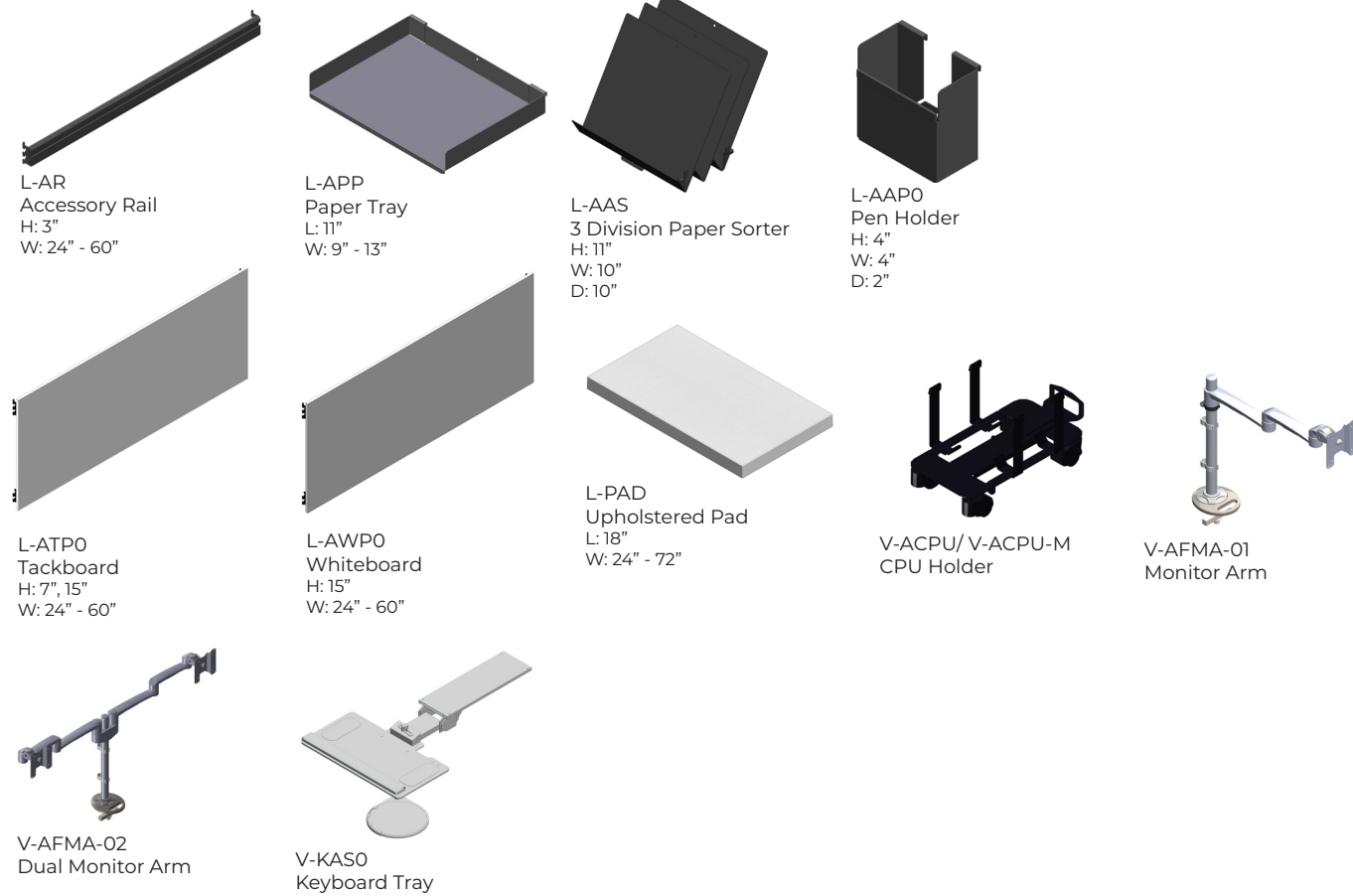

## Segment Types

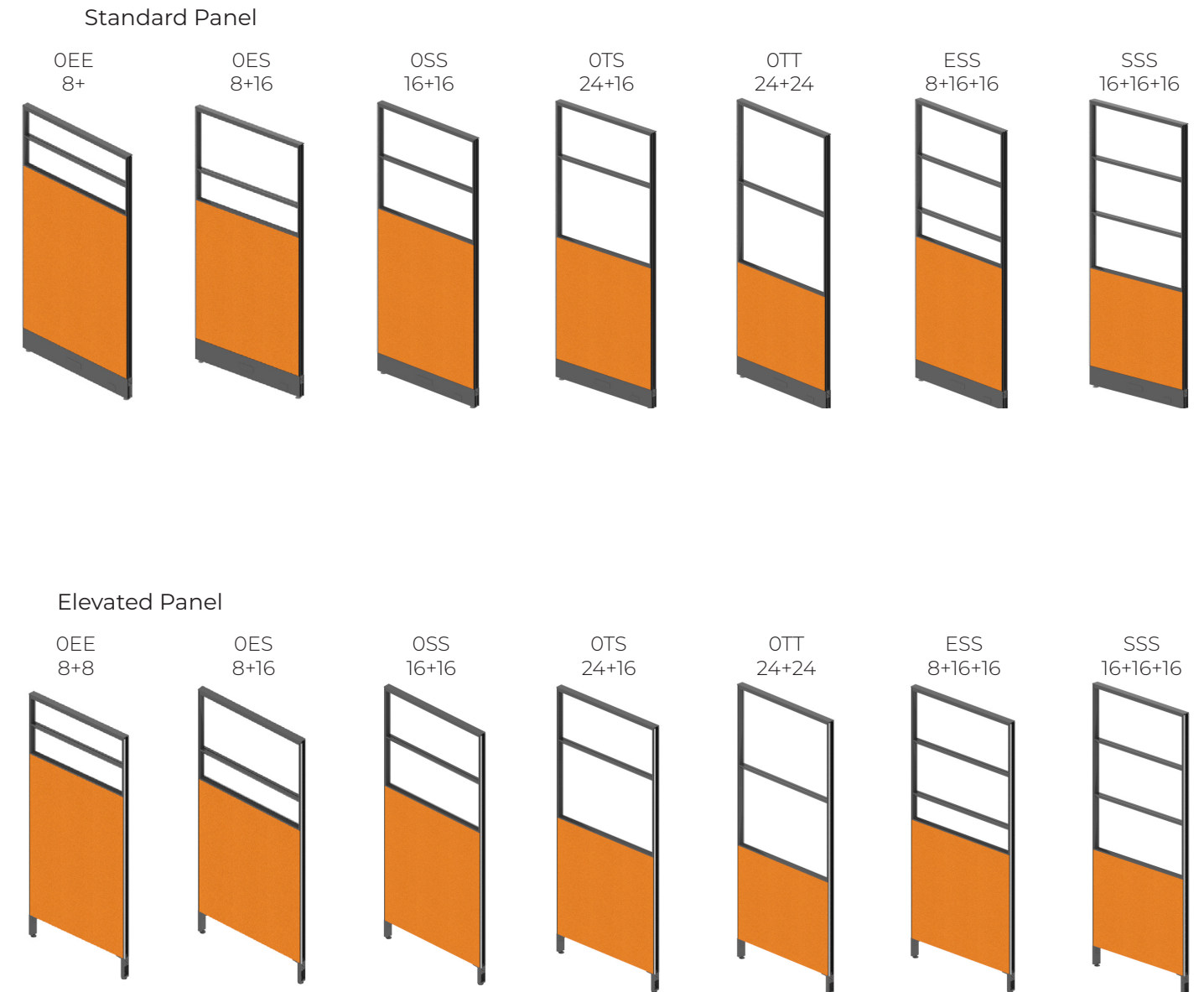

## Caution

### Load Bottom Drawer First

- Operate one drawer at a time
- Units may tip if loaded incorrectly
- Units should be attached to a wall or other furniture to reduce tipping hazard
- Always load the heaviest files in the bottom drawer

### Heavy Load

- Some products must be anchored to wall to ensure stability & safety.
- It is the owner and installers responsibility to ensure that the wall type and construction is of sufficient strength to carry the loads of any wall mounted products and their contents.
- Failure of the wall and anchors to support all imposed loads may result in property damage and/or personal injury.
- Tayco can provide size and empty weight of its products only. As wall blocking is considered a building construction process, Tayco cannot provide recommendations in this respect and cannot be responsible for damage or injury that may occur as a result of improper installation and/or blocking.

### Instability Hazard

Mobile items on casters such as flip top, personal and movable tables of any type and storage items of any type may present an instability hazard if not secured correctly while in use or in storage. Flip top tables or training tables of any type, are inherently more unstable when folded. Tayco provides the following guidelines & warnings when using mobile products:

- Lock casters immediately after moving. Do not leave the casters unlocked when in use or in storage.
- Motion may increase the instability of any item with casters. If the wheels hit an obstruction the table's forward momentum often causes overturn, especially if the item is not equipped with wheel extensions. Exercise strong caution while moving these items.
- Use caution when abrupt level changes in the floor are present (such as a doorway or room threshold) as caster failure or tipping may result.
- Do not stand, sit or lean on mobile items for support. They are not intended for this use and personal injury or property damage may result.
- Mobile units that feature height adjustable elements must be lowered to the minimum compressed height when moving to prevent instability. It is also recommended the user remove all computer equipment or other accessories to prevent possible weight imbalance or damage to equipment.
- Failure to follow the guidelines above may result in property damage or personal injury.

## Application Guidelines

### Types of Surfaces

no grommet

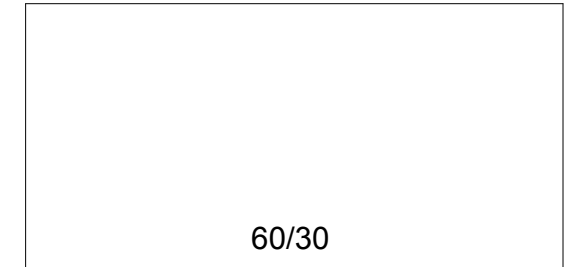
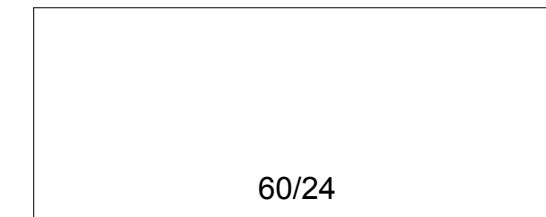

with grommet

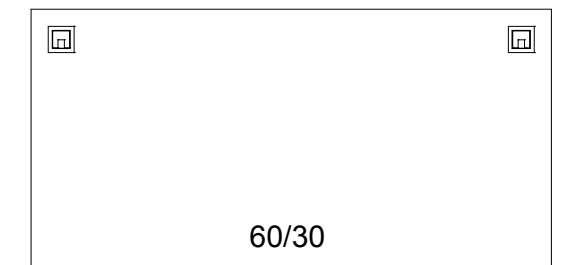
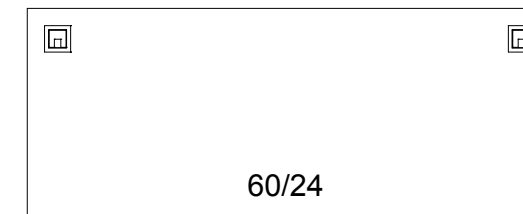

wireplay

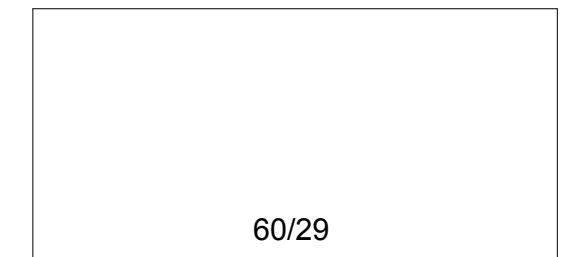
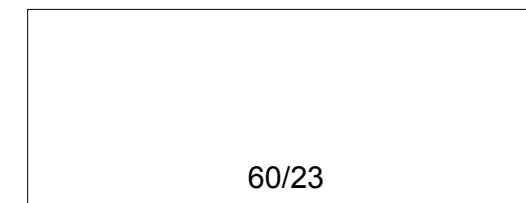



## Gallery Panel Planning

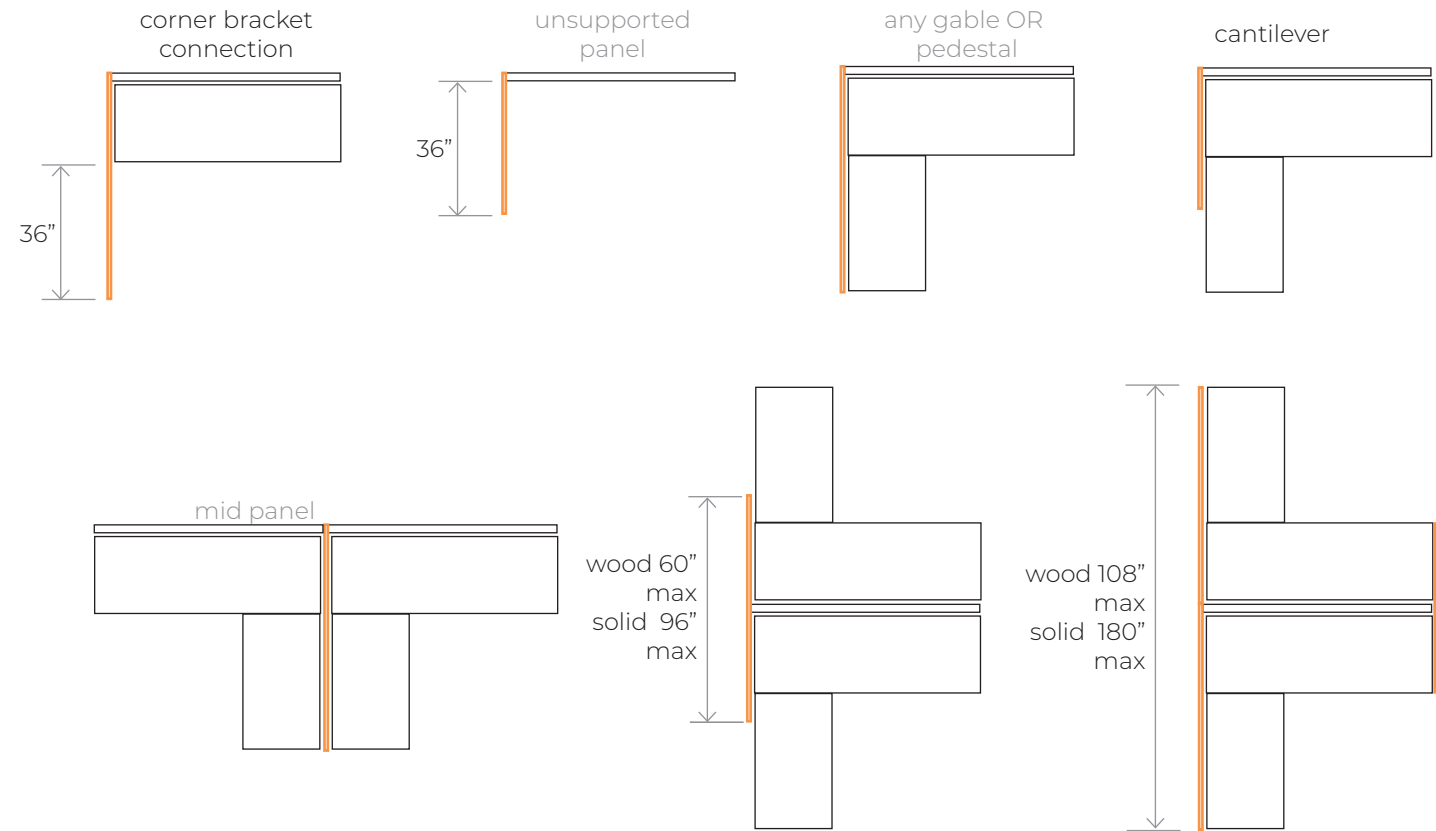

## Connection Types - Panel Doors

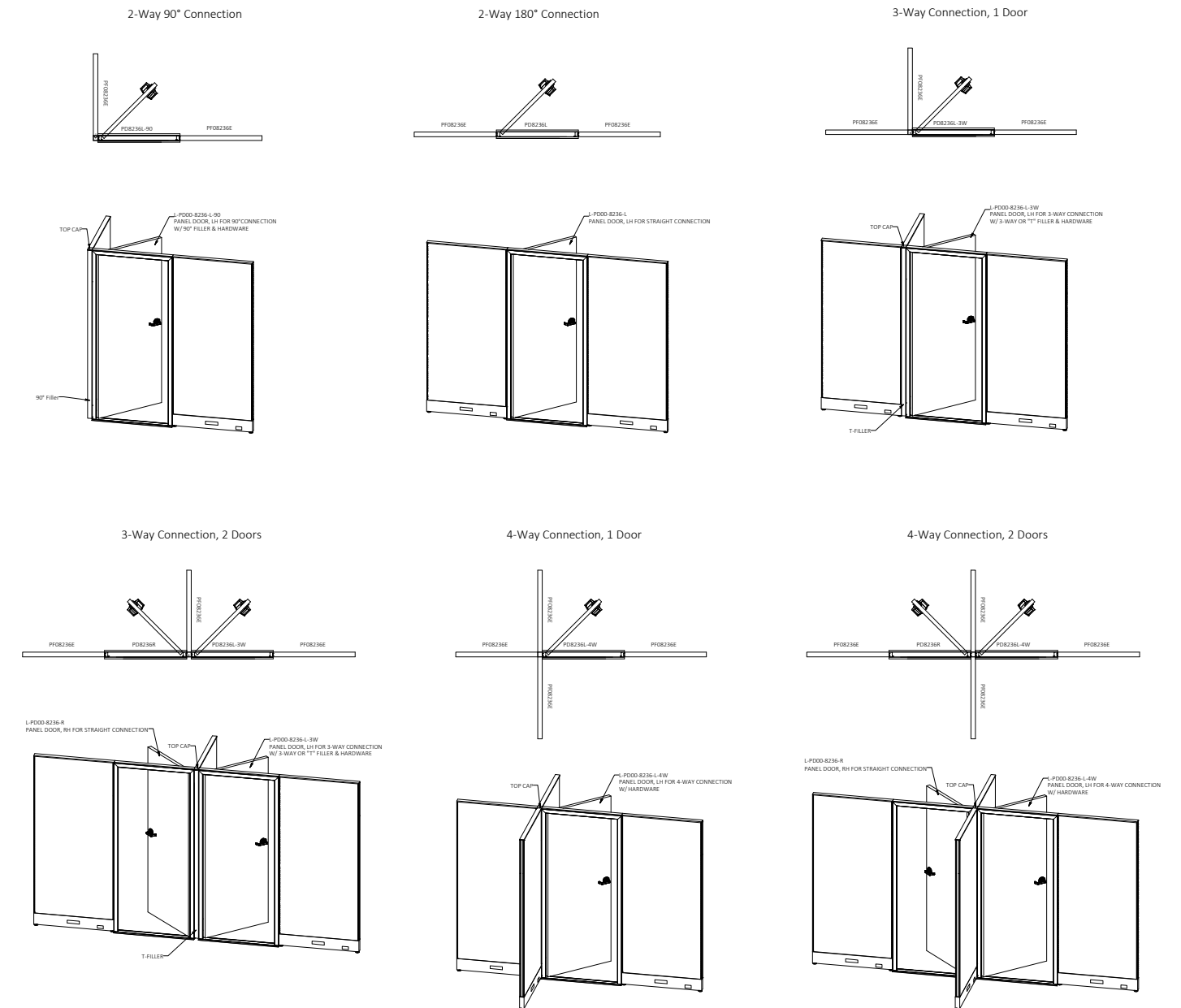

## Connection Types - Sliding Doors

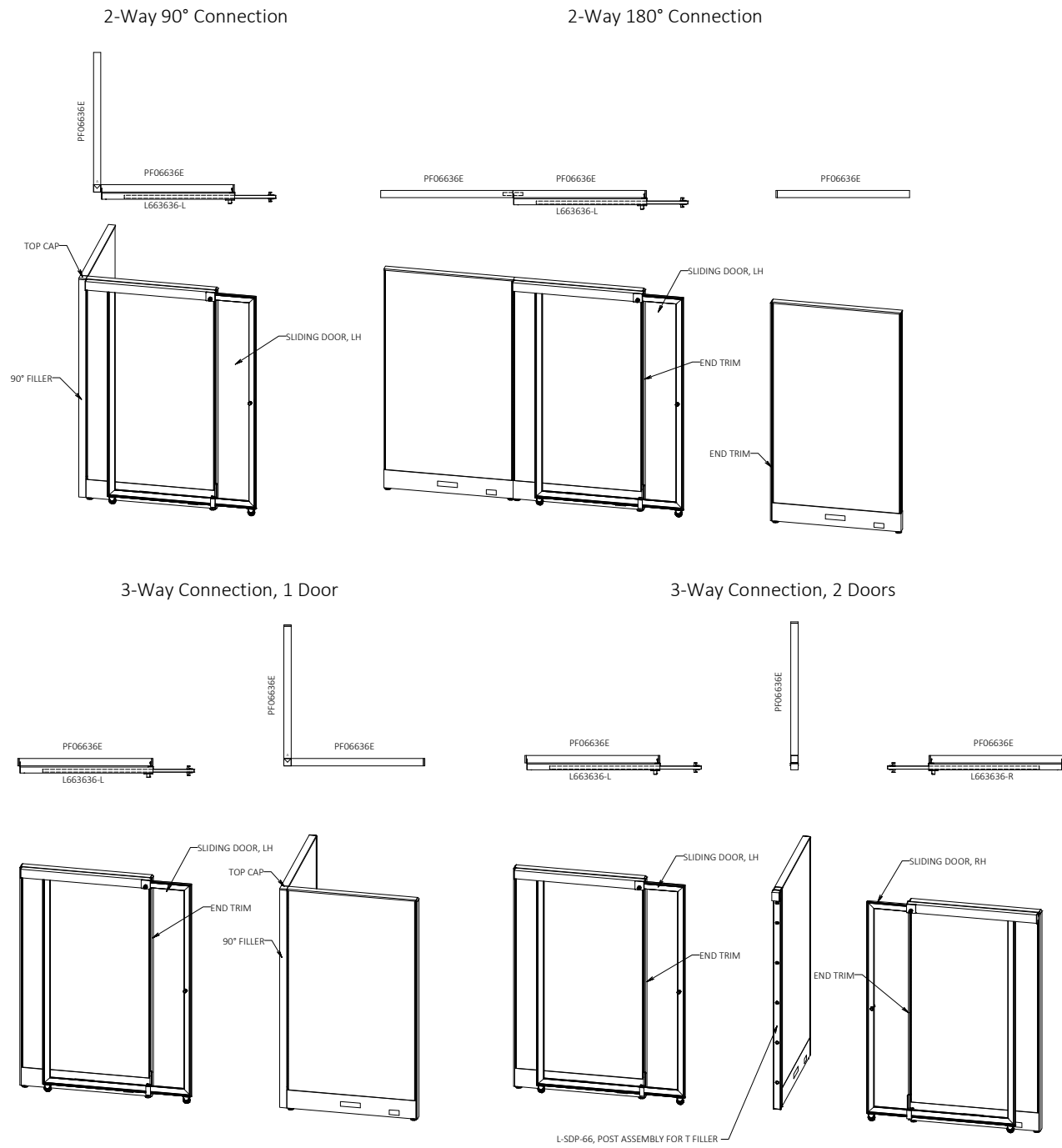

## Connection Types - Fillers

### 2-Way 90° Connection

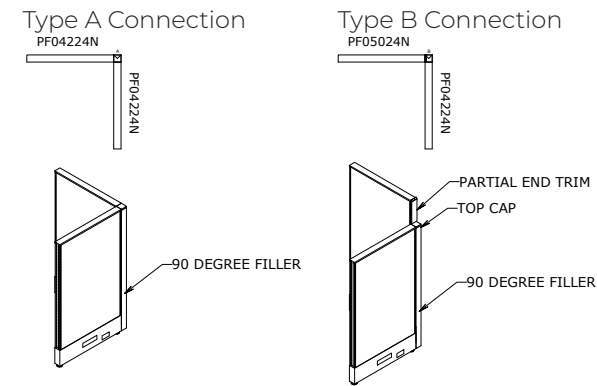

### 2-Way 180° Connection

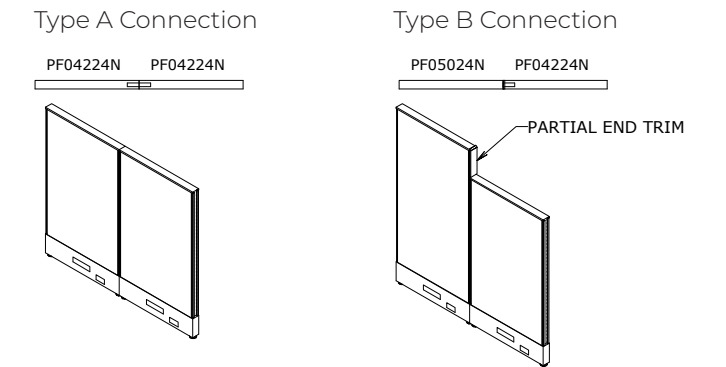

### 3-Way Connection

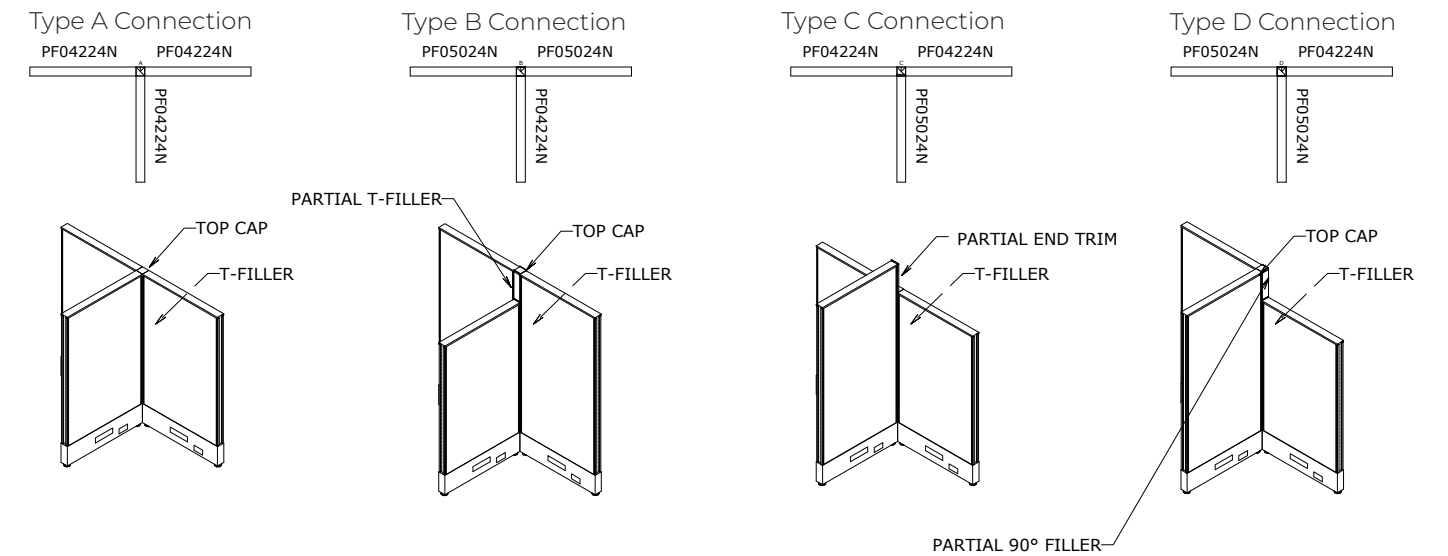

4-Way Connection

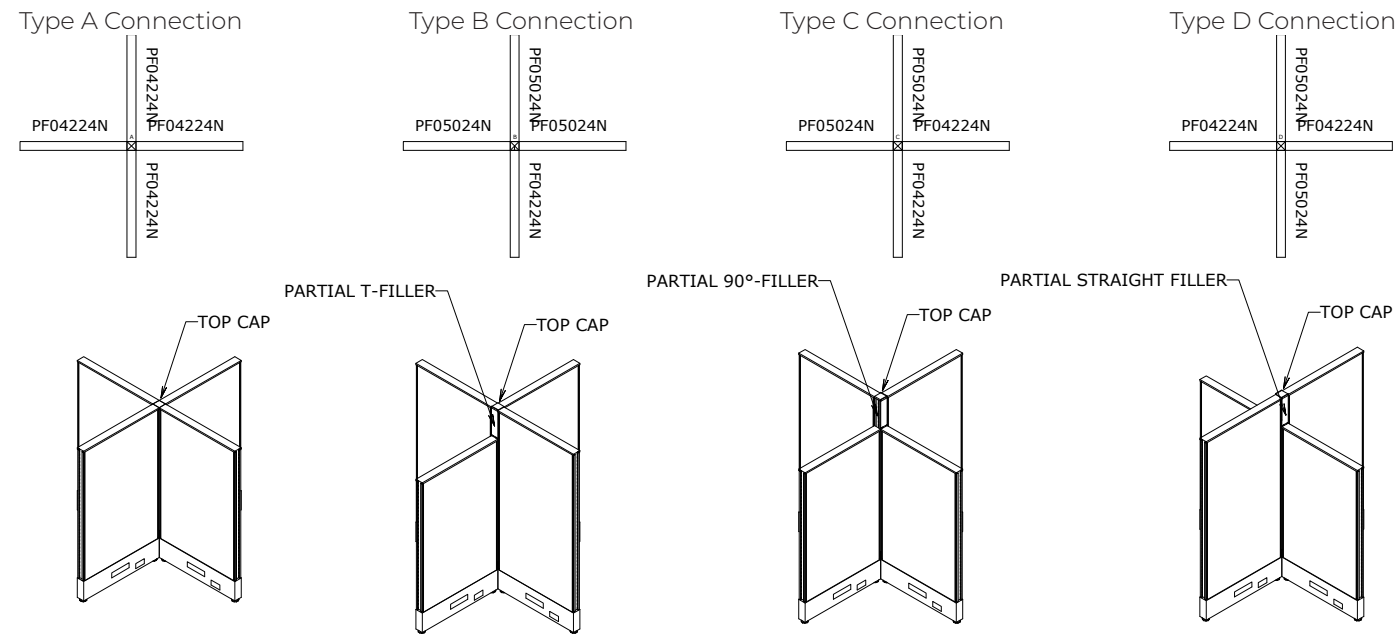

Wire Play Planning

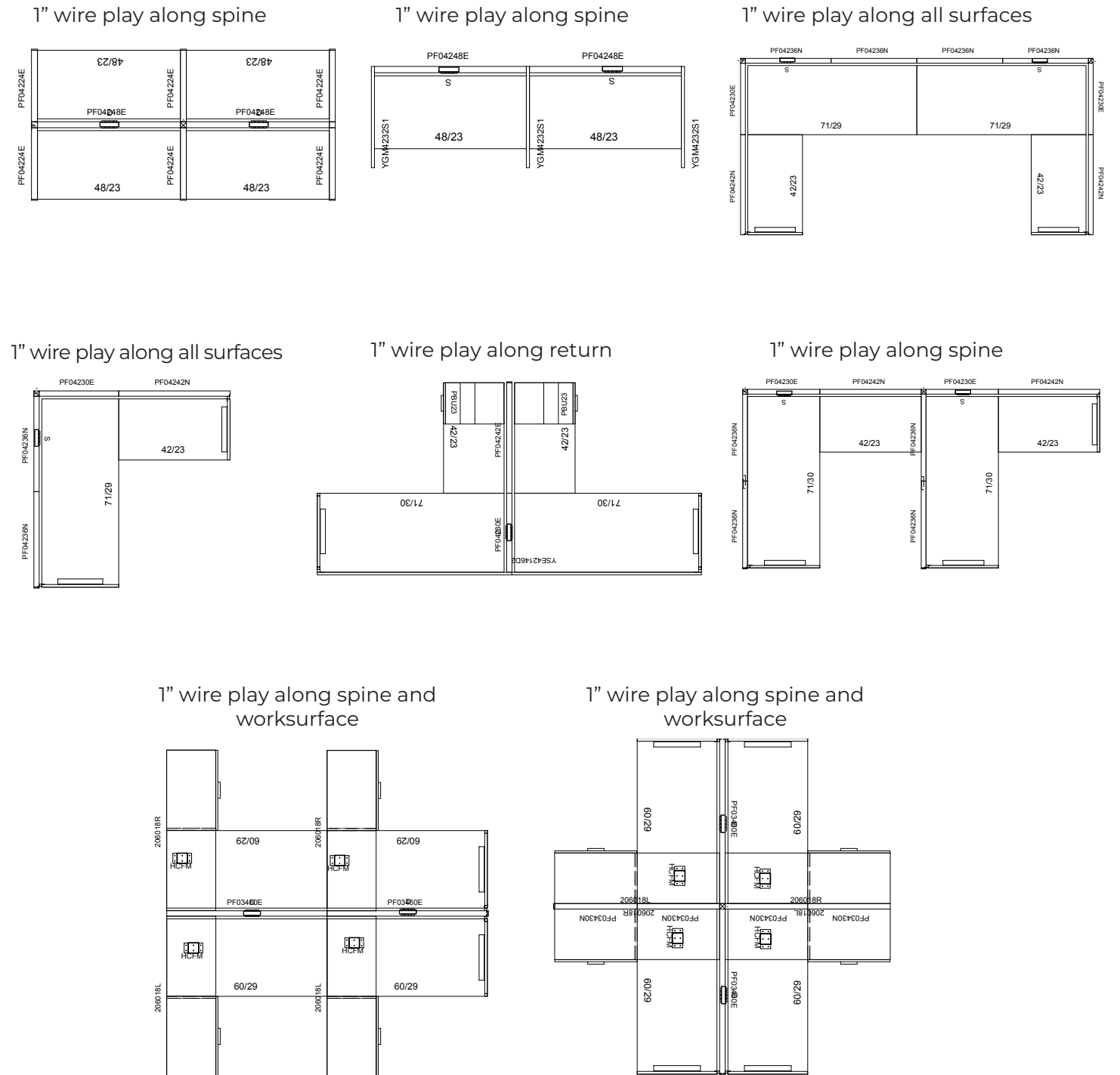



Switch USA Pricebook  
 May 2023  
**Panels**

Panels

<b>Standard Panel - Monolithic</b>	<b>4</b>	<b>Gallery - Woodgrain</b>	<b>64</b>
Non Powered Capable	4	Horizontal Grain	64
Fabric	4	Single Span Middle	64
Laminate	6	Double Span Middle	66
Powered Capable	8	Single Span End /No Cutout	68
Fabric	8	Single Span End/w Cutout	70
Laminate	10	Double Span End /No Cutout	72
<b>Standard - Integrated</b>	<b>12</b>	Double Span End/w Cutout	74
Non Powered	12	Vertical Grain	76
Fabric/Clear Acrylic	12	Single Span Middle	76
Fabric/Frosted Acrylic	14	Double Span Middle	78
Fabric/Clear Glass	16	Single Span End /No Cutout	80
Fabric/Frosted Glass	18	Single Span End /w Cutout	82
Laminate/Clear Acrylic	20	Double Span End/No Cutout	84
Laminate/Frosted Acrylic	22	Double Span End /w Cutout	86
Laminate/Clear Glass	24	<b>Gallery - Solid</b>	<b>88</b>
Laminate/Frosted Glass	26	Single Span Middle	88
Powered	28	Double Span Middle	90
Fabric/Clear Acrylic	28	Single Span End /No Cutout	92
Fabric/Frosted Acrylic	30	Single Span End /w Cutout	94
Fabric/Clear Glass	32	Double Span End/No Cutout	96
Fabric/Frosted Glass	34	Double Span End /w Cutout	98
Laminate/Clear Acrylic	36	<b>Frameless Blade</b>	<b>100</b>
Laminate/Frosted Acrylic	38	Standard & Elevated	
Laminate/Clear Glass	40	Panel Mounted Glass	100
Laminate/Frosted Glass	42	Standard & Elevated	
<b>Elevated - Monolithic</b>	<b>44</b>	Panel Mounted Acrylic	102
Fabric	44	Gallery Panel Mounted Glass	104
Laminate	46	Gallery Panel Mounted Acrylic	106
<b>Elevated - Integrated</b>	<b>48</b>	<b>Panel Mounted Add Ons</b>	<b>108</b>
Fabric/Clear Acrylic	48	Whiteboard	108
Fabric/Frosted Acrylic	50	Tackboard	109
Fabric/Clear Glass	52	<b>Doors</b>	<b>110</b>
Fabric/Frosted Glass	54	Hinged	110
Laminate/Clear Acrylic	56	Sliding	112
Laminate/Frosted Acrylic	58	Clear Acrylic	113
Laminate/Clear Glass	60	Frosted Acrylic	114
Laminate/Frosted Glass	62	Fluted Acrylic	115

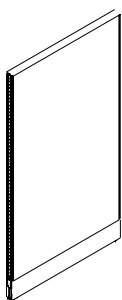

Standard Monolithic  
Non-Powered Fabric Panel

**What's Included:**

One (1) 2" thick fabric panel with 1" incremented slotted channels,  
Two (2) raceway covers,  
One (1) top trim

**How to Specify:**

Refer to panel fabric cards for fabric selections  
Choose White, Black, Silver, Charcoal for Panel Frame colour

**Notes:**

Non-power capable panel.  
Can be used in run with power-capable panels and allows wires to pass through.  
Panels are non tackable. For tackable option see Panel Add-On section.  
Fabric Upcharge  
Grade 2 - \$204 per panel,  
Grade 3 - \$251 per panel

**Options:**

Height\*: 34", 42", 50", 66", 82"

Width: 24", 30", 36", 42", 48", 54", 60", 66", 72"

Fabric

Metal Powder Coat Paint: White, Black, Silver, Charcoal

\*34" high - 50" high available up to 72" wide, 66" high available up to 60" wide, 82" high available up to 48" wide

Code	Price	H	W	D	Weight (lb.)	Volume (ft <sup>3</sup> )
L-PPF0-3424-N	389	34	24	2	16.3	0.94
L-PPF0-3430-N	420	34	30	2	20.4	1.18
L-PPF0-3436-N	451	34	36	2	24.5	1.42
L-PPF0-3442-N	483	34	42	2	28.6	1.65
L-PPF0-3448-N	512	34	48	2	32.6	1.89
L-PPF0-3454-N	543	34	54	2	36.7	2.13
L-PPF0-3460-N	573	34	60	2	40.8	2.36
L-PPF0-3466-N	826	34	66	2		
L-PPF0-3472-N	854	34	72	2		

Code	Price	H	W	D	Weight (lb.)	Volume (ft <sup>3</sup> )
L-PPF0-4224-N	389	42	24	2	20.2	1.17
L-PPF0-4230-N	420	42	30	2	25.2	1.46
L-PPF0-4236-N	451	42	36	2	30.2	1.75
L-PPF0-4242-N	483	42	42	2	35.3	2.04
L-PPF0-4248-N	512	42	48	2	40.3	2.33
L-PPF0-4254-N	543	42	54	2	45.4	2.63
L-PPF0-4260-N	573	42	60	2	50.4	2.92
L-PPF0-4266-N	826	42	66	2		
L-PPF0-4272-N	854	42	72	2		
L-PPF0-5024-N	420	50	24	2	24.0	1.39
L-PPF0-5030-N	466	50	30	2	30.0	1.74
L-PPF0-5036-N	512	50	36	2	36.0	2.08
L-PPF0-5042-N	558	50	42	2	42.0	2.43
L-PPF0-5048-N	605	50	48	2	48.0	2.78
L-PPF0-5054-N	651	50	54	2	54.0	3.13
L-PPF0-5060-N	694	50	60	2	60.0	3.47
L-PPF0-5066-N	923	50	66	2		
L-PPF0-5072-N	965	50	72	2		
L-PPF0-6624-N	483	66	24	2	31.7	1.83
L-PPF0-6630-N	536	66	30	2	39.6	2.29
L-PPF0-6636-N	583	66	36	2	47.5	2.75
L-PPF0-6642-N	628	66	42	2	55.4	3.21
L-PPF0-6648-N	674	66	48	2	63.4	3.67
L-PPF0-6654-N	735	66	54	2	71.3	4.13
L-PPF0-6660-N	795	66	60	2	79.2	4.58
L-PPF0-8224-N	914	82	24	2		
L-PPF0-8230-N	980	82	30	2		
L-PPF0-8236-N	1186	82	36	2		
L-PPF0-8242-N	1249	82	42	2		
L-PPF0-8248-N	1313	82	48	2		



Standard Monolithic  
Non-Powered Laminate  
Panel

**What's Included:**

One (1) 2" thick laminate panel with  
1" incremented slotted channels,  
Two (2) raceway covers,  
One (1) top trim

**How to Specify:**

Refer to laminate cards for laminate  
selections Choose White, Black, Silver, Charcoal  
for Panel Frame colour

**Notes:**

Non-power capable panel.  
Can be used in run with power-capable  
panels and allows wires to pass through.  
Panels are non tackable. For tackable  
option see Panel Add-On section.

**Options:**

Height*	34", 42", 50", 66", 82"
Width:	24", 30", 36", 42", 48
Fabric	
Metal Powder Coat Paint:	White, Black, Silver, Charcoal

\*82" high available up to 36" wide

Code	Price	H	W	D	Weight (lb.)	Volume (ft <sup>3</sup> )
L-PPL0-3424-N	492	34	24	2	16.3	0.94
L-PPL0-3430-N	537	34	30	2	20.4	1.18
L-PPL0-3436-N	613	34	36	2	24.5	1.42
L-PPL0-3442-N	658	34	42	2	28.6	1.65
L-PPL0-3448-N	722	34	48	2	32.6	1.89
L-PPL0-4224-N	537	42	24	2	20.2	1.17
L-PPL0-4230-N	584	42	30	2	25.2	1.46
L-PPL0-4236-N	658	42	36	2	30.2	1.75
L-PPL0-4242-N	705	42	42	2	35.3	2.04
L-PPL0-4248-N	766	42	48	2	40.3	2.33
L-PPL0-5024-N	584	50	24	2	24.0	1.39
L-PPL0-5030-N	630	50	30	2	30.0	1.74
L-PPL0-5036-N	722	50	36	2	36.0	2.08
L-PPL0-5042-N	766	50	42	2	42.0	2.43
L-PPL0-5048-N	829	50	48	2	48.0	2.78
L-PPL0-6624-N	722	66	24	2	31.7	1.83
L-PPL0-6630-N	766	66	30	2	39.6	2.29
L-PPL0-6636-N	905	66	36	2	47.5	2.75
L-PPL0-6642-N	952	66	42	2	55.4	3.21
L-PPL0-6648-N	1012	66	48	2	63.4	3.67
L-PPL0-8224-N	978	82	24	2		
L-PPL0-8230-N	992	82	30	2		
L-PPL0-8236-N	1297	82	36	2		

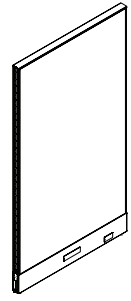

Standard Monolithic Powered Fabric Panel

**What's Included:**

One (1) 2" thick fabric panel with 1" incremented slotted channels, Two (2) raceway covers, One (1) top trim

**How to Specify:**

Refer to panel fabric cards for fabric selections  
Choose White, Black, Silver, Charcoal for Panel Frame colour

**Notes:**

Power capable panel with bracket for power module.  
Power module must be specified seperately.  
Panels are non tackable. For tackable option see Panel Add-On section.  
Fabric Upcharge  
Grade 2 - \$204 per panel,  
Grade 3 - \$251 per panel

**Options:**

Height\*: 34", 42", 50", 66", 82"

Width: 24", 30", 36", 42", 48", 54", 60", 66", 72"

Fabric

Metal Powder Coat Paint: White, Black, Silver, Charcoal

\*34" high - 50" high available up to 72" wide, 66" high available up to 60" wide, 82" high available up to 48" wide

Code	Price	H	W	D	Weight (lb.)	Volume (ft <sup>3</sup> )
L-PPF0-3424-E	435	34	24	2	16.3	0.94
L-PPF0-3430-E	466	34	30	2	20.4	1.18
L-PPF0-3436-E	496	34	36	2	24.5	1.42
L-PPF0-3442-E	529	34	42	2	28.6	1.65
L-PPF0-3448-E	558	34	48	2	32.6	1.89
L-PPF0-3454-E	590	34	54	2	36.7	2.13
L-PPF0-3460-E	617	34	60	2	40.8	2.36
L-PPF0-3466-E	867	34	66	2		
L-PPF0-3472-E	893	34	72	2		

Code	Price	H	W	D	Weight (lb.)	Volume (ft <sup>3</sup> )
L-PPF0-4224-E	435	42	24	2	20.2	1.17
L-PPF0-4230-E	466	42	30	2	25.2	1.46
L-PPF0-4236-E	496	42	36	2	30.2	1.75
L-PPF0-4242-E	529	42	42	2	35.3	2.04
L-PPF0-4248-E	558	42	48	2	40.3	2.33
L-PPF0-4254-E	590	42	54	2	45.4	2.63
L-PPF0-4260-E	617	42	60	2	50.4	2.92
L-PPF0-4266-E	867	42	66	2		
L-PPF0-4272-E	893	42	72	2		
L-PPF0-5024-E	466	50	24	2	24.0	1.39
L-PPF0-5030-E	512	50	30	2	30.0	1.74
L-PPF0-5036-E	558	50	36	2	36.0	2.08
L-PPF0-5042-E	605	50	42	2	42.0	2.43
L-PPF0-5048-E	651	50	48	2	48.0	2.78
L-PPF0-5054-E	694	50	54	2	54.0	3.13
L-PPF0-5060-E	740	50	60	2	60.0	3.47
L-PPF0-5066-E	964	50	66	2		
L-PPF0-5072-E	1004	50	72	2		
L-PPF0-6624-E	529	66	24	2	31.7	1.83
L-PPF0-6630-E	583	66	30	2	39.6	2.29
L-PPF0-6636-E	628	66	36	2	47.5	2.75
L-PPF0-6642-E	674	66	42	2	55.4	3.21
L-PPF0-6648-E	721	66	48	2	63.4	3.67
L-PPF0-6654-E	781	66	54	2	71.3	4.13
L-PPF0-6660-E	839	66	60	2	79.2	4.58
L-PPF0-8224-E	954	82	24	2		
L-PPF0-8230-E	1020	82	30	2		
L-PPF0-8236-E	1225	82	36	2		
L-PPF0-8242-E	1289	82	42	2		
L-PPF0-8248-E	1353	82	48	2		

Standard Monolithic  
Powered Laminate  
Panel

**What's Included:**

One (1) 2" thick flaminite panel with  
1" incremented slotted channels,  
Two (2) raceway covers,  
One (1) top trim

**How to Specify:**

Refer to laminate cards for laminate selections  
Choose White, Black, Silver, Charcoal for Panel  
Frame colour

**Options:**

Height\*: 34", 42", 50", 66", 82"

Width: 24", 30", 36", 42", 48",

Laminate

Metal Powder Coat Paint: White, Black, Silver, Charcoal

\*82"H available up to 36"W

**Notes:**

Power capable panel with bracket for  
power module.

Power module must be specified  
seperately.

Panels are non tackable. For tackable  
option see Panel Add-On section.

Code	Price	H	W	D	Weight (lb.)	Volume (ft <sup>3</sup> )
L-PPL0-3424-E	536	34	24	2	16.3	0.94
L-PPL0-3430-E	583	34	30	2	20.4	1.18
L-PPL0-3436-E	657	34	36	2	24.5	1.42
L-PPL0-3442-E	703	34	42	2	28.6	1.65
L-PPL0-3448-E	765	34	48	2	32.6	1.89
L-PPL0-4224-E	583	42	24	2	20.2	1.17
L-PPL0-4230-E	628	42	30	2	25.2	1.46
L-PPL0-4236-E	703	42	36	2	30.2	1.75
L-PPL0-4242-E	750	42	42	2	35.3	2.04
L-PPL0-4248-E	811	42	48	2	40.3	2.33
L-PPL0-5024-E	628	50	24	2	24.0	1.39
L-PPL0-5030-E	674	50	30	2	30.0	1.74
L-PPL0-5036-E	765	50	36	2	36.0	2.08
L-PPL0-5042-E	811	50	42	2	42.0	2.43
L-PPL0-5048-E	873	50	48	2	48.0	2.78
L-PPL0-6624-E	765	66	24	2	31.7	1.83
L-PPL0-6630-E	811	66	30	2	39.6	2.29
L-PPL0-6636-E	950	66	36	2	47.5	2.75
L-PPL0-6642-E	996	66	42	2	55.4	3.21
L-PPL0-6648-E	1056	66	48	2	63.4	3.67
L-PPL0-8224-E	991	82	24	2		
L-PPL0-8230-E	1004	82	30	2		
L-PPL0-8236-E	1338	82	36	2		



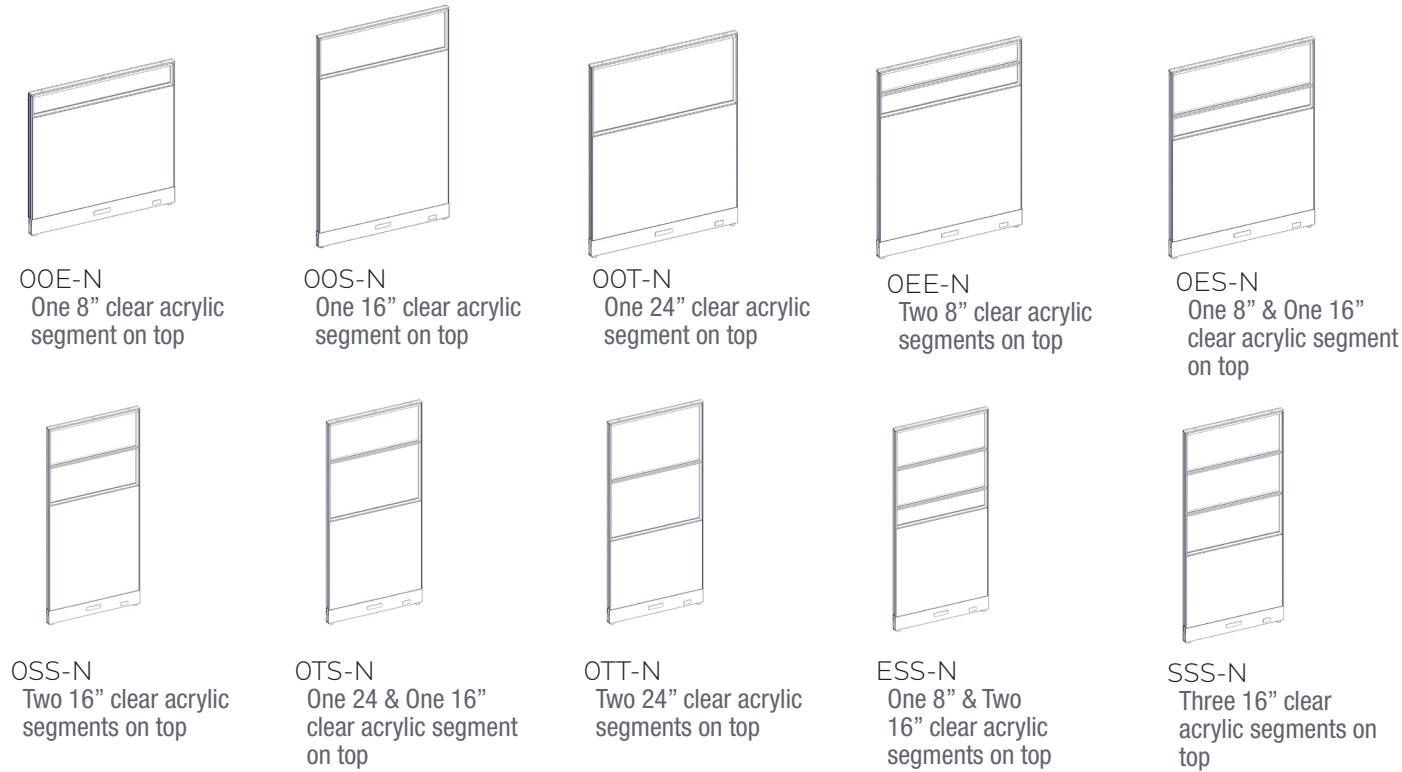

**How to order and read your code**

**L - P P F C A - 42 24 - 00E - N**

product standard P= integrated F=Fabric C=Clear A=Acrylic height width O = No segment N=Non powered  
 line E = Elevated L=Laminate F=Frosted G=Glass E = 8 inch segment E=Powered  
 S = 16 inch segment  
 T = 24 inch segment

**What's Included:**

One (1) 2" thick fabric panel with 1" incremented slotted channels, Two (2) raceway covers, One (1) top trim

**How to Specify:**

Refer to panel fabric cards for fabric selections  
 Choose White, Black, Silver, Charcoal for Panel Frame colour

**Options:**

Height\*: 34", 42", 50", 66", 82"

Width: 24", 30", 36", 42", 48", 54", 60", 66", 72"

Fabric

Metal Powder Coat Paint: White, Black, Silver, Charcoal

\*34" high - 50" high available up to 72" wide, 66" high available up to 60" wide, 82" high available up to 48" wide

Code	Price	H	W	D
One 8" clear acrylic segment on top				
L-PPFCA-4224-00E-N	757	42	24	2
L-PPFCA-4230-00E-N	835	42	30	2
L-PPFCA-4236-00E-N	914	42	36	2
L-PPFCA-4242-00E-N	991	42	42	2
L-PPFCA-4248-00E-N	1071	42	48	2
L-PPFCA-4254-00E-N	1147	42	54	2
L-PPFCA-4260-00E-N	1224	42	60	2
L-PPFCA-5024-00E-N	757	50	24	2
L-PPFCA-5030-00E-N	835	50	30	2
L-PPFCA-5036-00E-N	914	50	36	2
L-PPFCA-5042-00E-N	991	50	42	2
L-PPFCA-5048-00E-N	1071	50	48	2
L-PPFCA-5054-00E-N	1147	50	54	2
L-PPFCA-5060-00E-N	1224	50	60	2
One 16" clear acrylic segment on top				
L-PPFCA-5024-00S-N	757	50	24	2
L-PPFCA-5030-00S-N	835	50	30	2
L-PPFCA-5036-00S-N	914	50	36	2
L-PPFCA-5042-00S-N	991	50	42	2
L-PPFCA-5048-00S-N	1071	50	48	2
L-PPFCA-5054-00S-N	1147	50	54	2
L-PPFCA-5060-00S-N	1224	50	60	2
L-PPFCA-6624-00S-N	881	66	24	2
L-PPFCA-6630-00S-N	980	66	30	2
L-PPFCA-6636-00S-N	1077	66	36	2
L-PPFCA-6642-00S-N	1175	66	42	2
L-PPFCA-6648-00S-N	1274	66	48	2
L-PPFCA-6654-00S-N	1371	66	54	2
L-PPFCA-6660-00S-N	1469	66	60	2
L-PPFCA-8224-00S-N	1431	82	24	2
L-PPFCA-8230-00S-N	1660	82	30	2
L-PPFCA-8236-00S-N	1746	82	36	2
L-PPFCA-8242-00S-N	1789	82	42	2
L-PPFCA-8248-00S-N	1870	82	48	2
One 24" clear acrylic segment on top				
L-PPFCA-6624-00T-N	881	66	24	2
L-PPFCA-6630-00T-N	980	66	30	2
L-PPFCA-6636-00T-N	1077	66	36	2
L-PPFCA-6642-00T-N	1175	66	42	2
L-PPFCA-6648-00T-N	1274	66	48	2
L-PPFCA-6654-00T-N	1371	66	54	2
L-PPFCA-6660-00T-N	1469	66	60	2
Two 8" clear acrylic segments on top				
L-PPFCA-6624-0EE-N	1415	66	24	2
L-PPFCA-6630-0EE-N	1601	66	30	2
L-PPFCA-6636-0EE-N	1669	66	36	2
L-PPFCA-6642-0EE-N	1725	66	42	2
L-PPFCA-6648-0EE-N	1797	66	48	2
L-PPFCA-6654-0EE-N	1913	66	54	2
L-PPFCA-6660-0EE-N	1965	66	60	2
One 8" & One 16" clear acrylic segment on top				
L-PPFCA-6624-0ES-N	1381	66	24	2
L-PPFCA-6630-0ES-N	1561	66	30	2
L-PPFCA-6636-0ES-N	1641	66	36	2
L-PPFCA-6642-0ES-N	1720	66	42	2
L-PPFCA-6648-0ES-N	1803	66	48	2
L-PPFCA-6654-0ES-N	1890	66	54	2
L-PPFCA-6660-0ES-N	1932	66	60	2
Two 16" clear acrylic segments on top				
L-PPFCA-8224-0SS-N	1471	82	24	2
L-PPFCA-8230-0SS-N	1709	82	30	2
L-PPFCA-8236-0SS-N	1832	82	36	2
L-PPFCA-8242-0SS-N	1887	82	42	2
L-PPFCA-8248-0SS-N	1962	82	48	2
One 24" & One 16" clear acrylic segment on top				
L-PPFCA-8224-0TS-N	1462	82	24	2
L-PPFCA-8230-0TS-N	1680	82	30	2
L-PPFCA-8236-0TS-N	1746	82	36	2
L-PPFCA-8242-0TS-N	1800	82	42	2
L-PPFCA-8248-0TS-N	1983	82	48	2
Two 24" clear acrylic segments on top				
L-PPFCA-8224-0TT-N	1459	82	24	2
L-PPFCA-8230-0TT-N	1653	82	30	2
L-PPFCA-8236-0TT-N	1742	82	36	2
L-PPFCA-8242-0TT-N	1855	82	42	2
L-PPFCA-8248-0TT-N	1931	82	48	2
One 8" & Two 16" clear acrylic segments on top				
L-PPFCA-8224-ESS-N	1524	82	24	2
L-PPFCA-8230-ESS-N	1807	82	30	2
L-PPFCA-8236-ESS-N	1887	82	36	2
L-PPFCA-8242-ESS-N	1889	82	42	2
L-PPFCA-8248-ESS-N	2070	82	48	2
Three 16" clear acrylic segments on top				
L-PPFCA-8224-SSS-N	1549	82	24	2
L-PPFCA-8230-SSS-N	1752	82	30	2
L-PPFCA-8236-SSS-N	1915	82	36	2
L-PPFCA-8242-SSS-N	1979	82	42	2
L-PPFCA-8248-SSS-N	2065	82	48	2

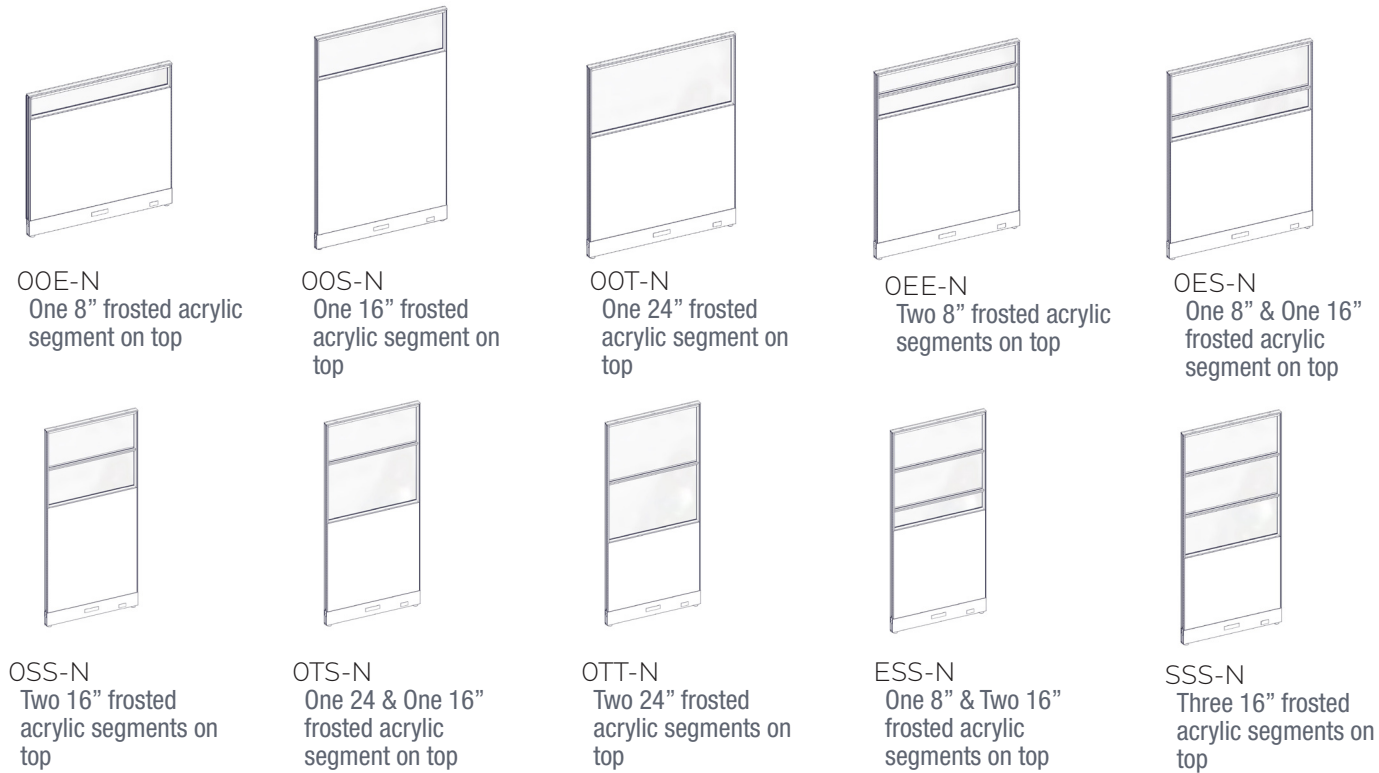

**How to order and read your code**

**L - P P F F A - 42 24 - 00E - N**

product standard P= integrated F=Fabric C=Clear A=Acrylic height width 0= No segment N=Non powered  
 line E= Elevated L=Laminate F=Frosted G=Glass E = 8 inch segment E=Powered  
 S = 16 inch segment  
 T = 24 inch segment

**What's Included:**

One (1) 2" thick fabric panel with 1" incremented slotted channels, Two (2) raceway covers, One (1) top trim

**How to Specify:**

Refer to panel fabric cards for fabric selections  
 Choose White, Black, Silver, Charcoal for Panel Frame colour

**Options:**

Height*:	34", 42", 50", 66", 82"
Width:	24", 30", 36", 42", 48", 54", 60", 66", 72"
Fabric	
Metal Powder Coat Paint:	White, Black, Silver, Charcoal

\*34" high - 50" high available up to 72" wide, 66" high available up to 60" wide, 82" high available up to 48" wide

Code	Price	H	W	D
One 8" frosted acrylic segment on top				
L-PPFFA-4224-00E-N	856	42	24	2
L-PPFFA-4230-00E-N	934	42	30	2
L-PPFFA-4236-00E-N	1013	42	36	2
L-PPFFA-4242-00E-N	1090	42	42	2
L-PPFFA-4248-00E-N	1170	42	48	2
L-PPFFA-4254-00E-N	1246	42	54	2
L-PPFFA-4260-00E-N	1323	42	60	2
L-PPFFA-5024-00E-N	856	50	24	2
L-PPFFA-5030-00E-N	934	50	30	2
L-PPFFA-5036-00E-N	1013	50	36	2
L-PPFFA-5042-00E-N	1090	50	42	2
L-PPFFA-5048-00E-N	1170	50	48	2
L-PPFFA-5054-00E-N	1246	50	54	2
L-PPFFA-5060-00E-N	1323	50	60	2
One 16" frosted acrylic segment on top				
L-PPFFA-5024-00S-N	856	50	24	2
L-PPFFA-5030-00S-N	934	50	30	2
L-PPFFA-5036-00S-N	1013	50	36	2
L-PPFFA-5042-00S-N	1090	50	42	2
L-PPFFA-5048-00S-N	1170	50	48	2
L-PPFFA-5054-00S-N	1246	50	54	2
L-PPFFA-5060-00S-N	1323	50	60	2
L-PPFFA-6624-00S-N	980	50	24	2
L-PPFFA-6630-00S-N	1079	50	30	2
L-PPFFA-6636-00S-N	1176	50	36	2
L-PPFFA-6642-00S-N	1274	50	42	2
L-PPFFA-6648-00S-N	1374	50	48	2
L-PPFFA-6654-00S-N	1471	50	54	2
L-PPFFA-6660-00S-N	1569	50	60	2
L-PPFFA-8224-00S-N	1465	82	24	2
L-PPFFA-8230-00S-N	1705	82	30	2
L-PPFFA-8236-00S-N	1804	82	36	2
L-PPFFA-8242-00S-N	1855	82	42	2
L-PPFFA-8248-00S-N	1936	82	48	2
One 24" frosted acrylic segment on top				
L-PPFFA-6624-00T-N	980	66	24	2
L-PPFFA-6630-00T-N	1079	66	30	2
L-PPFFA-6636-00T-N	1176	66	36	2
L-PPFFA-6642-00T-N	1260	66	42	2
L-PPFFA-6648-00T-N	1359	66	48	2
L-PPFFA-6654-00T-N	1471	66	54	2
L-PPFFA-6660-00T-N	1569	66	60	2

Code	Price	H	W	D
Two 8" frosted acrylic segments on top				
L-PPFFA-6624-0EE-N	1473	66	24	2
L-PPFFA-6630-0EE-N	1681	66	30	2
L-PPFFA-6636-0EE-N	1773	66	36	2
L-PPFFA-6642-0EE-N	1827	66	42	2
L-PPFFA-6648-0EE-N	1916	66	48	2
L-PPFFA-6654-0EE-N	1997	66	54	2
L-PPFFA-6660-0EE-N	2047	66	60	2
One 8" & One 16" frosted acrylic segment on top				
L-PPFFA-6624-0ES-N	1430	66	24	2
L-PPFFA-6630-0ES-N	1629	66	30	2
L-PPFFA-6636-0ES-N	1722	66	36	2
L-PPFFA-6642-0ES-N	1822	66	42	2
L-PPFFA-6648-0ES-N	1903	66	48	2
L-PPFFA-6654-0ES-N	2000	66	54	2
L-PPFFA-6660-0ES-N	2061	66	60	2
Two 16" frosted acrylic segments on top				
L-PPFFA-8224-0SS-N	1377	82	24	2
L-PPFFA-8230-0SS-N	1576	82	30	2
L-PPFFA-8236-0SS-N	1652	82	36	2
L-PPFFA-8242-0SS-N	1714	82	42	2
L-PPFFA-8248-0SS-N	1778	82	48	2
One 24" & One 16" frosted acrylic segment on top				
L-PPFFA-8224-0TS-N	1563	82	24	2
L-PPFFA-8230-0TS-N	1813	82	30	2
L-PPFFA-8236-0TS-N	1879	82	36	2
L-PPFFA-8242-0TS-N	1968	82	42	2
L-PPFFA-8248-0TS-N	2182	82	48	2
Two 24" frosted acrylic segments on top				
L-PPFFA-8224-0TT-N	1559	82	24	2
L-PPFFA-8230-0TT-N	1789	82	30	2
L-PPFFA-8236-0TT-N	1903	82	36	2
L-PPFFA-8242-0TT-N	2056	82	42	2
L-PPFFA-8248-0TT-N	2131	82	48	2
One 8" & Two 16" frosted acrylic segments on top				
L-PPFFA-8224-ESS-N	1624	82	24	2
L-PPFFA-8230-ESS-N	1943	82	30	2
L-PPFFA-8236-ESS-N	2020	82	36	2
L-PPFFA-8242-ESS-N	2085	82	42	2
L-PPFFA-8248-ESS-N	2201	82	48	2
Three 16" frosted acrylic segments on top				
L-PPFFA-8224-SSS-N	1649	82	24	2
L-PPFFA-8230-SSS-N	1887	82	30	2
L-PPFFA-8236-SSS-N	2116	82	36	2
L-PPFFA-8242-SSS-N	2179	82	42	2
L-PPFFA-8248-SSS-N	2264	82	48	2

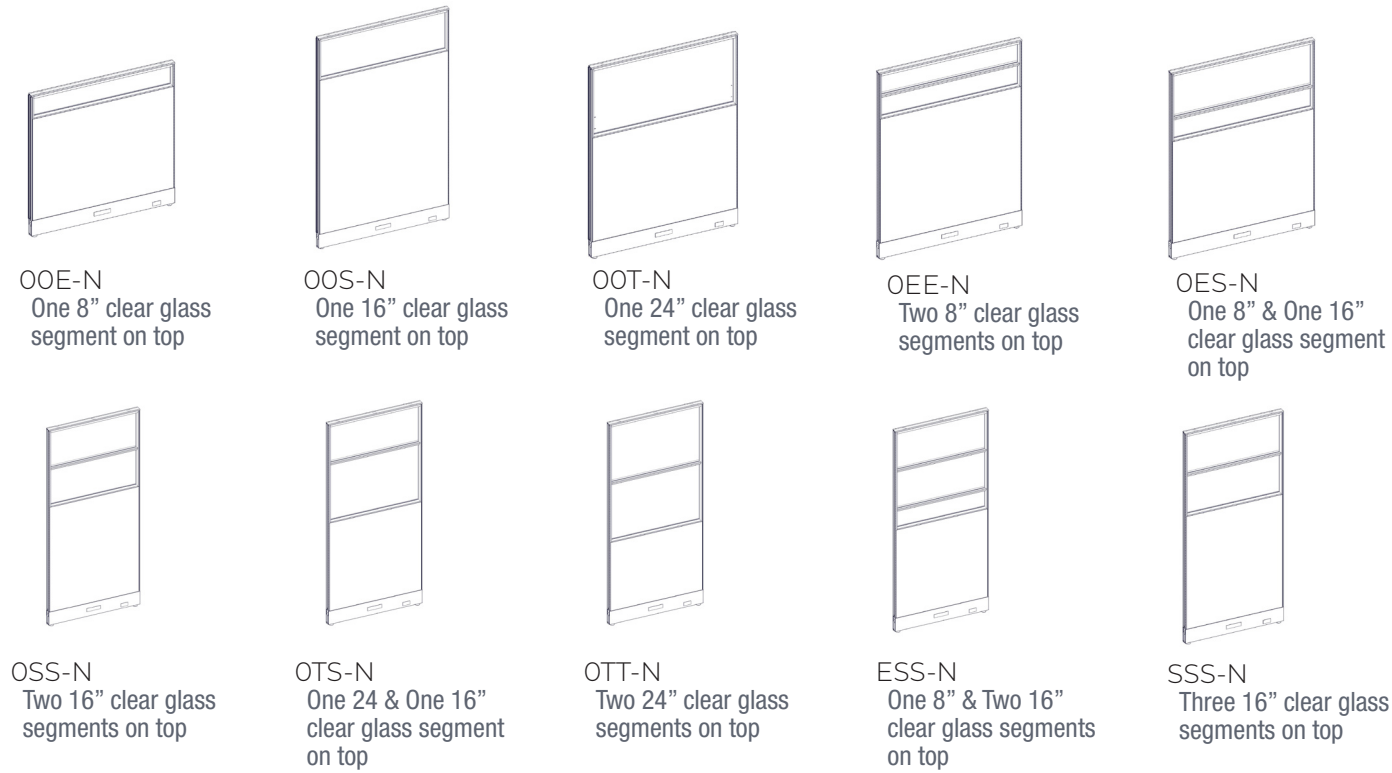

**How to order and read your code**

**L - P P F C G - 42 24 - 00E - N**

product standard line P= integrated E = Elevated F=Fabric L=Laminate C=Clear F=Frosted A=Acrylic height G=Glass width 0 = No segment E = 8 inch segment S = 16 inch segment T = 24 inch segment N=Non powered E=Powered

**What's Included:**

One (1) 2" thick fabric panel with 1" incremented slotted channels, Two (2) raceway covers, One (1) top trim

**How to Specify:**

Refer to panel fabric cards for fabric selections  
Choose White, Black, Silver, Charcoal for Panel Frame colour

**Notes:**

Power capable panel with bracket for power module.  
Power module must be specified seperately.  
Panels are non tackable. For tackable option see Panel Add-On section.  
Fabric Upcharge  
Grade 2 - \$204 per panel,  
Grade 3 - \$251 per panel

**Options:**

Height*:	34", 42", 50", 66", 82"
Width:	24", 30", 36", 42", 48", 54", 60", 66", 72"
Fabric	
Metal Powder Coat Paint:	White, Black, Silver, Charcoal

\*34" high - 50" high available up to 72" wide, 66" high available up to 60" wide, 82" high available up to 48" wide

Code	Price	H	W	D
<b>One 8" clear glass segment on top</b>				
L-PPFCG-4224-00E-N	890	42	24	2
L-PPFCG-4230-00E-N	968	42	30	2
L-PPFCG-4236-00E-N	1048	42	36	2
L-PPFCG-4242-00E-N	1124	42	42	2
L-PPFCG-4248-00E-N	1201	42	48	2
L-PPFCG-4254-00E-N	1280	42	54	2
L-PPFCG-4260-00E-N	1356	42	60	2
L-PPFCG-5024-00E-N	890	50	24	2
L-PPFCG-5030-00E-N	968	50	30	2
L-PPFCG-5036-00E-N	1048	50	36	2
L-PPFCG-5042-00E-N	1124	50	42	2
L-PPFCG-5048-00E-N	1201	50	48	2
L-PPFCG-5054-00E-N	1280	50	54	2
L-PPFCG-5060-00E-N	1356	50	60	2
<b>One 16" clear glass segment on top</b>				
L-PPFCG-5024-00S-N	890	50	24	2
L-PPFCG-5030-00S-N	968	50	30	2
L-PPFCG-5036-00S-N	1048	50	36	2
L-PPFCG-5042-00S-N	1124	50	42	2
L-PPFCG-5048-00S-N	1201	50	48	2
L-PPFCG-5054-00S-N	1280	50	54	2
L-PPFCG-5060-00S-N	1356	50	60	2
L-PPFCG-6624-00S-N	1023	66	24	2
L-PPFCG-6630-00S-N	1122	66	30	2
L-PPFCG-6636-00S-N	1220	66	36	2
L-PPFCG-6642-00S-N	1320	66	42	2
L-PPFCG-6648-00S-N	1418	66	48	2
L-PPFCG-6654-00S-N	1517	66	54	2
L-PPFCG-6660-00S-N	1614	66	60	2
L-PPFCG-8224-00S-N	1393	82	24	2
L-PPFCG-8230-00S-N	1646	82	30	2
L-PPFCG-8236-00S-N	1751	82	36	2
L-PPFCG-8242-00S-N	1810	82	42	2
L-PPFCG-8248-00S-N	1912	82	48	2
<b>One 24" clear glass segment on top</b>				
L-PPFCG-6624-00T-N	1023	66	24	2
L-PPFCG-6630-00T-N	1122	66	30	2
L-PPFCG-6636-00T-N	1220	66	36	2
L-PPFCG-6642-00T-N	1320	66	42	2
L-PPFCG-6648-00T-N	1418	66	48	2
L-PPFCG-6654-00T-N	1517	66	54	2
L-PPFCG-6660-00T-N	1614	66	60	2
<b>Two 8" clear glass segments on top</b>				
L-PPFCG-6624-0EE-N	1505	66	24	2
L-PPFCG-6630-0EE-N	1727	66	30	2
L-PPFCG-6636-0EE-N	1819	66	36	2
L-PPFCG-6642-0EE-N	1885	66	42	2
L-PPFCG-6648-0EE-N	1975	66	48	2
L-PPFCG-6654-0EE-N	2090	66	54	2
L-PPFCG-6660-0EE-N	2151	66	60	2
<b>One 8" &amp; One 16" clear glass segment on top</b>				
L-PPFCG-6624-0ES-N	1467	66	24	2
L-PPFCG-6630-0ES-N	1662	66	30	2
L-PPFCG-6636-0ES-N	1756	66	36	2
L-PPFCG-6642-0ES-N	1843	66	42	2
L-PPFCG-6648-0ES-N	1953	66	48	2
L-PPFCG-6654-0ES-N	2077	66	54	2
L-PPFCG-6660-0ES-N	2145	66	60	2
<b>Two 16" clear glass segments on top</b>				
L-PPFCG-8224-0SS-N	1559	82	24	2
L-PPFCG-8230-0SS-N	1793	82	30	2
L-PPFCG-8236-0SS-N	1915	82	36	2
L-PPFCG-8242-0SS-N	2012	82	42	2
L-PPFCG-8248-0SS-N	2131	82	48	2
<b>One 24" &amp; One 16" clear glass segment on top</b>				
L-PPFCG-8224-0TS-N	1548	82	24	2
L-PPFCG-8230-0TS-N	1766	82	30	2
L-PPFCG-8236-0TS-N	1883	82	36	2
L-PPFCG-8242-0TS-N	1991	82	42	2
L-PPFCG-8248-0TS-N	2125	82	48	2
<b>Two 24" clear glass segments on top</b>				
L-PPFCG-8224-0TT-N	1576	82	24	2
L-PPFCG-8230-0TT-N	1786	82	30	2
L-PPFCG-8236-0TT-N	1895	82	36	2
L-PPFCG-8242-0TT-N	2008	82	42	2
L-PPFCG-8248-0TT-N	2140	82	48	2
<b>One 8" &amp; Two 16" clear glass segments on top</b>				
L-PPFCG-8224-ESS-N	1692	82	24	2
L-PPFCG-8230-ESS-N	1970	82	30	2
L-PPFCG-8236-ESS-N	2097	82	36	2
L-PPFCG-8242-ESS-N	2118	82	42	2
L-PPFCG-8248-ESS-N	2285	82	48	2
<b>Three 16" clear glass segments on top</b>				
L-PPFCG-8224-SSS-N	1728	82	24	2
L-PPFCG-8230-SSS-N	1932	82	30	2
L-PPFCG-8236-SSS-N	2065	82	36	2
L-PPFCG-8242-SSS-N	2190	82	42	2
L-PPFCG-8248-SSS-N	2339	82	48	2

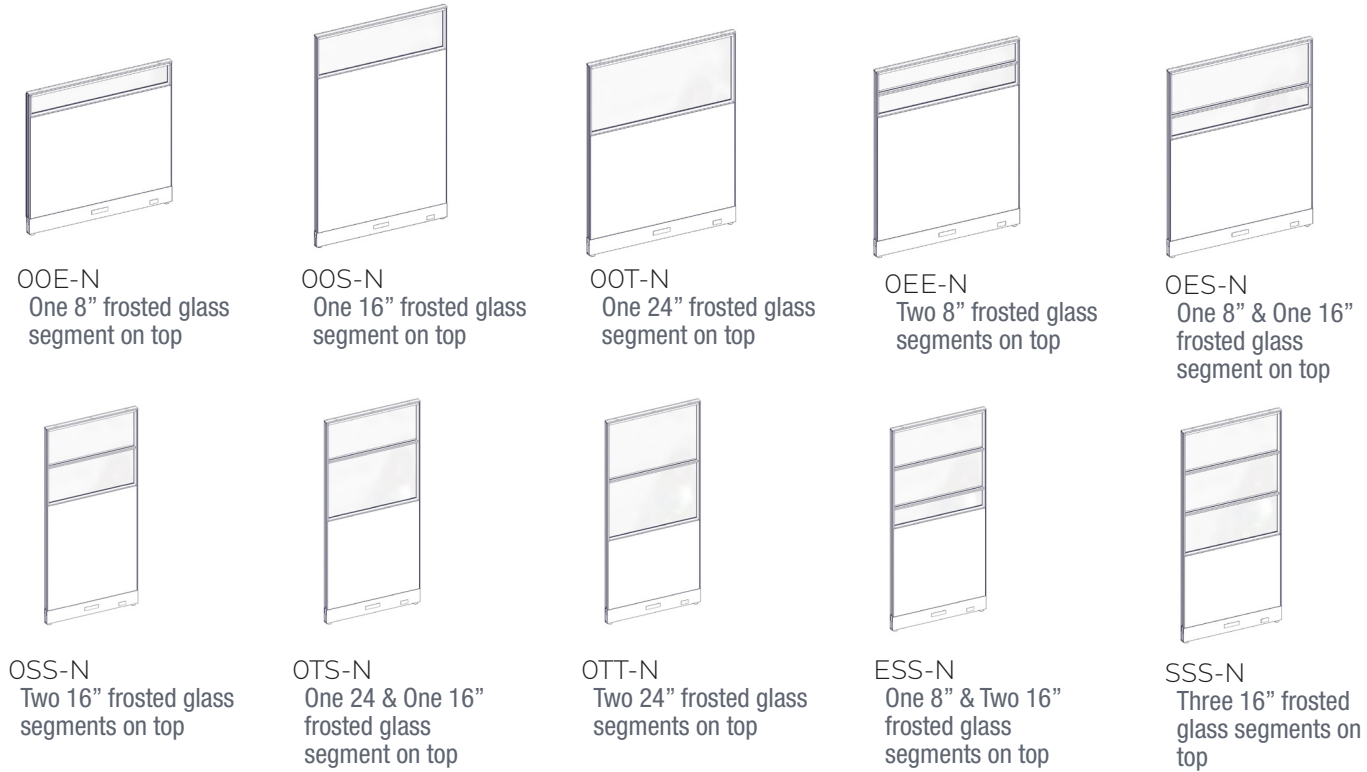

**How to order and read your code**

**L - P P F F G - 42 24 - 00E - N**

product standard line P= integrated E = Elevated F=Fabric L=Laminate C=Clear F=Frosted A=Acrylic height G=Glass width O = No segment E = 8 inch segment S = 16 inch segment T = 24 inch segment N=Non powered E=Powered

**What's Included:**

One (1) 2" thick fabric panel with 1" incremented slotted channels, Two (2) raceway covers, One (1) top trim

**How to Specify:**

Refer to panel fabric cards for fabric selections  
Choose White, Black, Silver, Charcoal for Panel Frame colour

**Options:**

Height*:	34", 42", 50", 66", 82"
Width:	24", 30", 36", 42", 48", 54", 60", 66", 72"
Fabric	
Metal Powder Coat Paint:	White, Black, Silver, Charcoal

\*34" high - 50" high available up to 72" wide, 66" high available up to 60" wide, 82" high available up to 48" wide

Code	Price	H	W	D
<b>One 8" frosted glass segment on top</b>				
L-PPFFG-4224-00E-N	976	42	24	2
L-PPFFG-4230-00E-N	1065	42	30	2
L-PPFFG-4236-00E-N	1146	42	36	2
L-PPFFG-4242-00E-N	1223	42	42	2
L-PPFFG-4248-00E-N	1301	42	48	2
L-PPFFG-4254-00E-N	1379	42	54	2
L-PPFFG-4260-00E-N	1455	42	60	2
L-PPFFG-5024-00E-N	989	50	24	2
L-PPFFG-5030-00E-N	1065	50	30	2
L-PPFFG-5036-00E-N	1146	50	36	2
L-PPFFG-5042-00E-N	1223	50	42	2
L-PPFFG-5048-00E-N	1301	50	48	2
L-PPFFG-5054-00E-N	1379	50	54	2
L-PPFFG-5060-00E-N	1455	50	60	2
<b>One 16" frosted glass segment on top</b>				
L-PPFFG-5024-00S-N	989	50	24	2
L-PPFFG-5030-00S-N	1065	50	30	2
L-PPFFG-5036-00S-N	1146	50	36	2
L-PPFFG-5042-00S-N	1223	50	42	2
L-PPFFG-5048-00S-N	1301	50	48	2
L-PPFFG-5054-00S-N	1379	50	54	2
L-PPFFG-5060-00S-N	1455	50	60	2
L-PPFFG-6624-00S-N	1122	66	24	2
L-PPFFG-6630-00S-N	1221	66	30	2
L-PPFFG-6636-00S-N	1319	66	36	2
L-PPFFG-6642-00S-N	1419	66	42	2
L-PPFFG-6648-00S-N	1517	66	48	2
L-PPFFG-6654-00S-N	1616	66	54	2
L-PPFFG-6660-00S-N	1714	66	60	2
L-PPFFG-8224-00S-N	1473	82	24	2
L-PPFFG-8230-00S-N	1735	82	30	2
L-PPFFG-8236-00S-N	1861	82	36	2
L-PPFFG-8242-00S-N	1936	82	42	2
L-PPFFG-8248-00S-N	2055	82	48	2
<b>One 24" frosted glass segment on top</b>				
L-PPFFG-6624-00T-N	1122	66	24	2
L-PPFFG-6630-00T-N	1221	66	30	2
L-PPFFG-6636-00T-N	1319	66	36	2
L-PPFFG-6642-00T-N	1419	66	42	2
L-PPFFG-6648-00T-N	1517	66	48	2
L-PPFFG-6654-00T-N	1616	66	54	2
L-PPFFG-6660-00T-N	1714	66	60	2
<b>Two 8" frosted glass segments on top</b>				
L-PPFFG-6624-0EE-N	1669	66	24	2
L-PPFFG-6630-0EE-N	1889	66	30	2
L-PPFFG-6636-0EE-N	1982	66	36	2
L-PPFFG-6642-0EE-N	2047	66	42	2
L-PPFFG-6648-0EE-N	2136	66	48	2
L-PPFFG-6654-0EE-N	2252	66	54	2
L-PPFFG-6660-0EE-N	2331	66	60	2
<b>One 8" &amp; One 16" frosted glass segment on top</b>				
L-PPFFG-6624-0ES-N	1630	66	24	2
L-PPFFG-6630-0ES-N	1832	66	30	2
L-PPFFG-6636-0ES-N	1947	66	36	2
L-PPFFG-6642-0ES-N	2049	66	42	2
L-PPFFG-6648-0ES-N	2179	66	48	2
L-PPFFG-6654-0ES-N	2321	66	54	2
L-PPFFG-6660-0ES-N	2417	66	60	2
<b>Two 16" frosted glass segments on top</b>				
L-PPFFG-8224-0SS-N	1722	82	24	2
L-PPFFG-8230-0SS-N	1973	82	30	2
L-PPFFG-8236-0SS-N	2132	82	36	2
L-PPFFG-8242-0SS-N	2264	82	42	2
L-PPFFG-8248-0SS-N	2419	82	48	2
<b>One 24" &amp; One 16" frosted glass segment on top</b>				
L-PPFFG-8224-0TS-N	1737	82	24	2
L-PPFFG-8230-0TS-N	1989	82	30	2
L-PPFFG-8236-0TS-N	2153	82	36	2
L-PPFFG-8242-0TS-N	2306	82	42	2
L-PPFFG-8248-0TS-N	2484	82	48	2
<b>Two 24" frosted glass segments on top</b>				
L-PPFFG-8224-0TT-N	1792	82	24	2
L-PPFFG-8230-0TT-N	2056	82	30	2
L-PPFFG-8236-0TT-N	2219	82	36	2
L-PPFFG-8242-0TT-N	2385	82	42	2
L-PPFFG-8248-0TT-N	2574	82	48	2
<b>One 8" &amp; Two 16" frosted glass segments on top</b>				
L-PPFFG-8224-ESS-N	1936	82	24	2
L-PPFFG-8230-ESS-N	2231	82	30	2
L-PPFFG-8236-ESS-N	2395	82	36	2
L-PPFFG-8242-ESS-N	2452	82	42	2
L-PPFFG-8248-ESS-N	2657	82	48	2
<b>Three 16" frosted glass segments on top</b>				
L-PPFFG-8224-SSS-N	1971	82	24	2
L-PPFFG-8230-SSS-N	2200	82	30	2
L-PPFFG-8236-SSS-N	2386	82	36	2
L-PPFFG-8242-SSS-N	2569	82	42	2
L-PPFFG-8248-SSS-N	2771	82	48	2

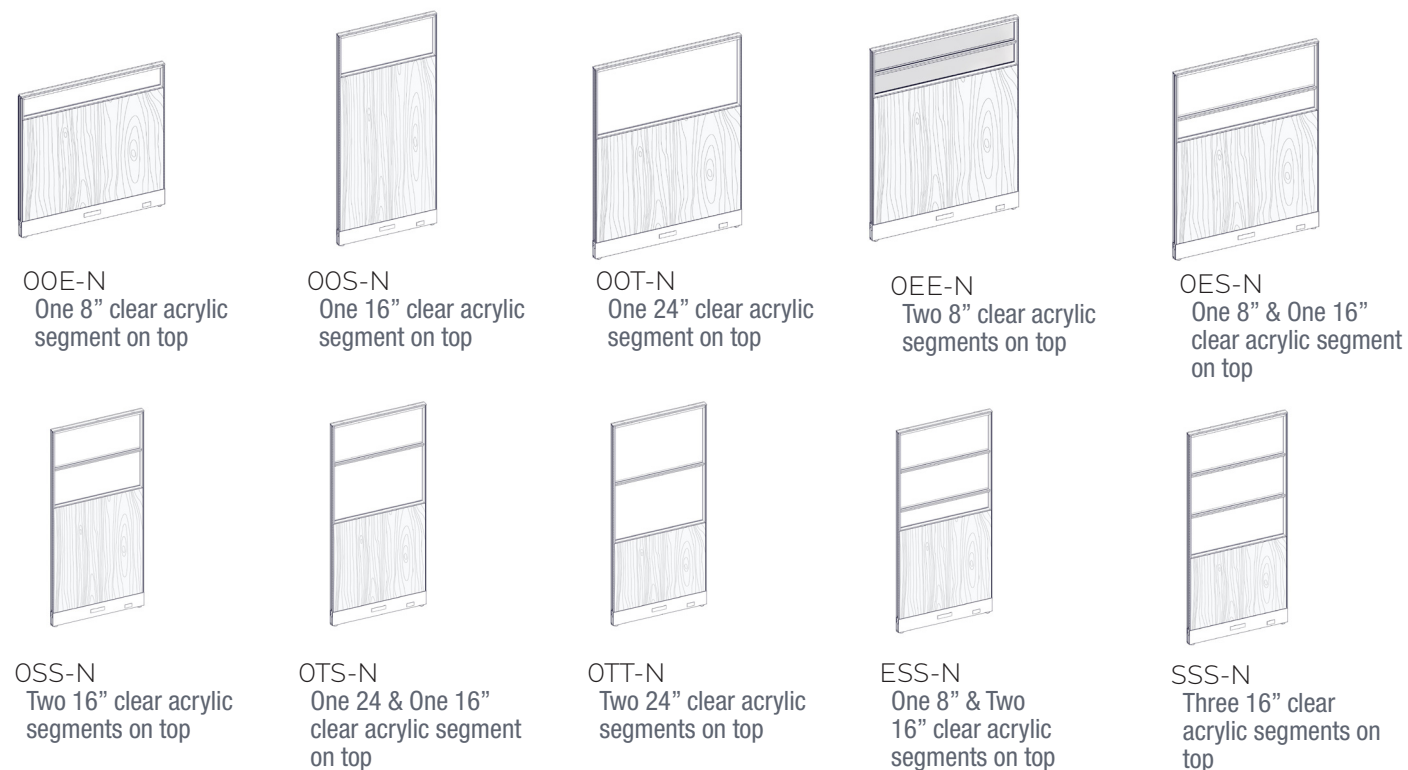

**How to order and read your code**

**L - P P L C A - 42 24 - 00E - N**

product standard P= integrated F=Fabric C=Clear A=Acrylic height width 0= No segment N=Non powered  
 line E = Elevated L=Laminate F=Frosted G=Glass E = 8 inch segment E=Powered  
 S = 16 inch segment  
 T = 24 inch segment

**What's Included:**

One (1) 2" thick laminate panel with 1" incremented slotted channels,  
 Two (2) raceway covers,  
 One (1) top trim

**How to Specify:**

Refer to laminate cards for laminate selections  
 Choose White, Black, Silver, Charcoal for Panel Frame colour

**Options:**

Height\*: 34", 42", 50", 66", 82"

Width: 24", 30", 36", 42", 48",

Laminate

Metal Powder Coat Paint: White, Black, Silver, Charcoal

\*82"H available up to 36"W

Code	Price	H	W	D
One 8" clear acrylic segment on top				
L-PPLCA-4224-00E-N	1117	42	24	2
L-PPLCA-4230-00E-N	1168	42	30	2
L-PPLCA-4236-00E-N	1221	42	36	2
L-PPLCA-4242-00E-N	1327	42	42	2
L-PPLCA-4248-00E-N	1355	42	48	2
L-PPLCA-5024-00E-N	1020	50	24	2
L-PPLCA-5030-00E-N	1049	50	30	2
L-PPLCA-5036-00E-N	1102	50	36	2
L-PPLCA-5042-00E-N	1251	50	42	2
L-PPLCA-5048-00E-N	1280	50	48	2
One 16" clear acrylic segment on top				
L-PPLCA-5024-00S-N	1035	50	24	2
L-PPLCA-5030-00S-N	1073	50	30	2
L-PPLCA-5036-00S-N	1133	50	36	2
L-PPLCA-5042-00S-N	1267	50	42	2
L-PPLCA-5048-00S-N	1302	50	48	2
L-PPLCA-6624-00S-N	1133	66	24	2
L-PPLCA-6630-00S-N	1168	66	30	2
L-PPLCA-6636-00S-N	1243	66	36	2
L-PPLCA-6642-00S-N	1439	66	42	2
L-PPLCA-6648-00S-N	1477	66	48	2
L-PPLCA-8224-00S-N	1496	82	24	2
L-PPLCA-8230-00S-N	1511	82	30	2
L-PPLCA-8236-00S-N	2016	82	36	2
One 24" clear acrylic segment on top				
L-PPLCA-6624-00T-N	1122	66	24	2
L-PPLCA-6630-00T-N	1166	66	30	2
L-PPLCA-6636-00T-N	1241	66	36	2
L-PPLCA-6642-00T-N	1403	66	42	2
L-PPLCA-6648-00T-N	1449	66	48	2
Two 8" clear acrylic segments on top				
L-PPLCA-6624-0EE-N	1305	66	24	2
L-PPLCA-6630-0EE-N	1322	66	30	2
L-PPLCA-6636-0EE-N	1596	66	36	2
L-PPLCA-6642-0EE-N	1631	66	42	2
L-PPLCA-6648-0EE-N	1685	66	48	2
One 8" & One 16" clear acrylic segment on top				
L-PPLCA-6624-0ES-N	1311	66	24	2
L-PPLCA-6630-0ES-N	1366	66	30	2
L-PPLCA-6636-0ES-N	1662	66	36	2
L-PPLCA-6642-0ES-N	1718	66	42	2
L-PPLCA-6648-0ES-N	1774	66	48	2
Two 16" clear acrylic segments on top				
L-PPLCA-8224-0SS-N	1363	82	24	2
L-PPLCA-8230-0SS-N	1431	82	30	2
L-PPLCA-8236-0SS-N	1759	82	36	2
One 24" & One 16" clear acrylic segment on top				
L-PPLCA-8224-0TS-N	1394	82	24	2
L-PPLCA-8230-0TS-N	1484	82	30	2
L-PPLCA-8236-0TS-N	1768	82	36	2
Two 24" clear acrylic segments on top				
L-PPLCA-8224-0TT-N	1333	82	24	2
L-PPLCA-8230-0TT-N	1411	82	30	2
L-PPLCA-8236-0TT-N	1657	82	36	2
One 8" & Two 16" clear acrylic segments on top				
L-PPLCA-8224-ESS-N	1454	82	24	2
L-PPLCA-8230-ESS-N	1613	82	30	2
L-PPLCA-8236-ESS-N	1907	82	36	2
Three 16" clear acrylic segments on top				
L-PPLCA-8224-SSS-N	1425	82	24	2
L-PPLCA-8230-SSS-N	1510	82	30	2
L-PPLCA-8236-SSS-N	1829	82	36	2

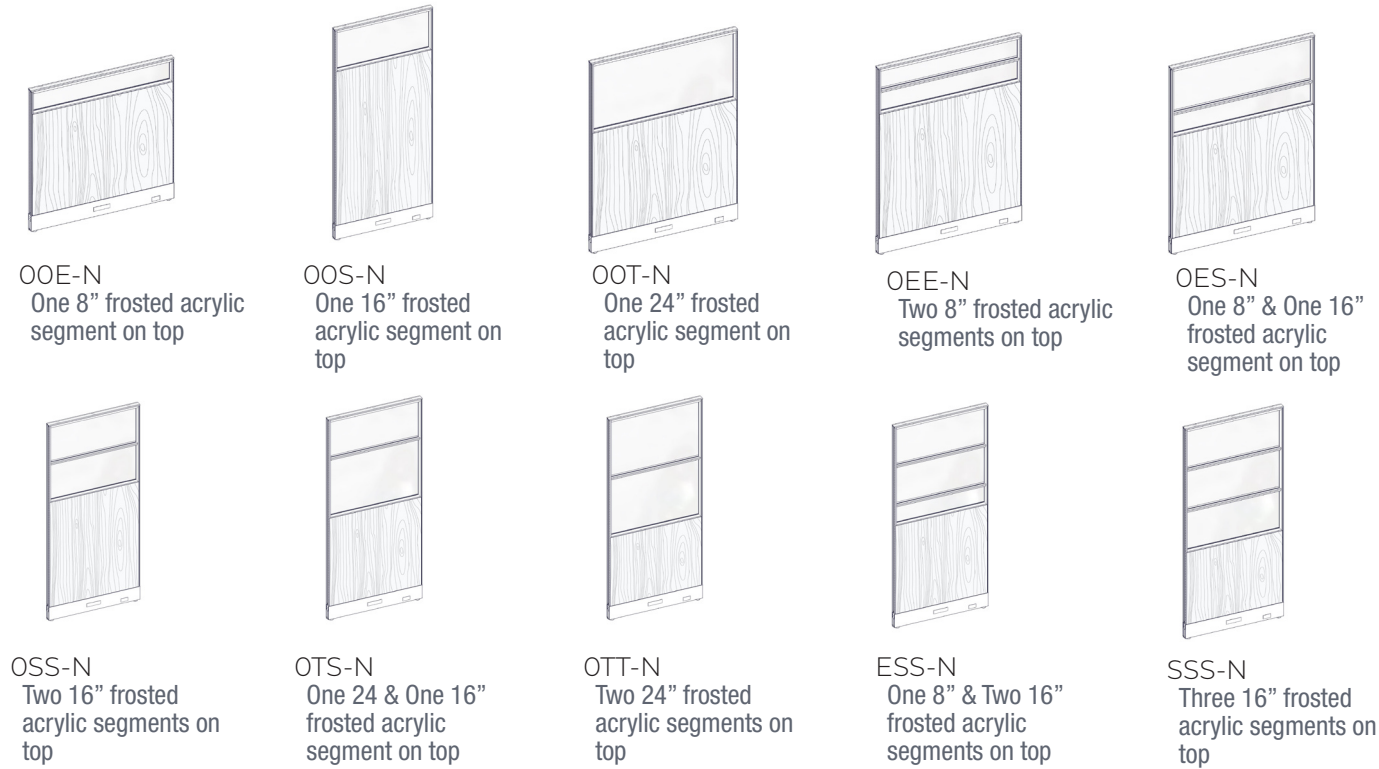

**How to order and read your code**

**L - P P L F A - 42 24 - 00E - N**

product line	standard	P= integrated E = Elevated	F=Fabric L=Laminate	C=Clear F=Frosted	A=Acrylic G=Glass	height width	0 = No segment E = 8 inch segment S = 16 inch segment T = 24 inch segment	N=Non powered E=Powered
--------------	----------	-------------------------------	------------------------	----------------------	----------------------	-----------------	--	----------------------------

**What's Included:**

One (1) 2" thick laminate panel with 1" incremented slotted channels,  
Two (2) raceway covers,  
One (1) top trim

**How to Specify:**

Refer to laminate cards for laminate selections  
Choose White, Black, Silver, Charcoal for Panel Frame colour

**Options:**

Height*:	34", 42", 50", 66", 82"
Width:	24", 30", 36", 42", 48",
Laminate	
Metal Powder Coat Paint:	White, Black, Silver, Charcoal

\*82"H available up to 36"W

Code	Price	H	W	D
One 8" frosted acrylic segment on top				
L-PPLFA-4224-00E-N	1084	42	24	2
L-PPLFA-4230-00E-N	1111	42	30	2
L-PPLFA-4236-00E-N	1162	42	36	2
L-PPLFA-4242-00E-N	1291	42	42	2
L-PPLFA-4248-00E-N	1319	42	48	2
L-PPLFA-5024-00E-N	1120	50	24	2
L-PPLFA-5030-00E-N	1147	50	30	2
L-PPLFA-5036-00E-N	1201	50	36	2
L-PPLFA-5042-00E-N	1350	50	42	2
L-PPLFA-5048-00E-N	1379	50	48	2
One 16" frosted acrylic segment on top				
L-PPLFA-5024-00S-N	1134	50	24	2
L-PPLFA-5030-00S-N	1172	50	30	2
L-PPLFA-5036-00S-N	1232	50	36	2
L-PPLFA-5042-00S-N	1366	50	42	2
L-PPLFA-5048-00S-N	1401	50	48	2
L-PPLFA-6624-00S-N	1232	66	24	2
L-PPLFA-6630-00S-N	1267	66	30	2
L-PPLFA-6636-00S-N	1342	66	36	2
L-PPLFA-6642-00S-N	1538	66	42	2
L-PPLFA-6648-00S-N	1576	66	48	2
L-PPLFA-8224-00S-N	1529	82	24	2
L-PPLFA-8230-00S-N	1558	82	30	2
L-PPLFA-8236-00S-N	2072	82	36	2
One 24" frosted acrylic segment on top				
L-PPLFA-6624-00T-N	1221	66	24	2
L-PPLFA-6630-00T-N	1266	66	30	2
L-PPLFA-6636-00T-N	1329	66	36	2
L-PPLFA-6642-00T-N	1502	66	42	2
L-PPLFA-6648-00T-N	1548	66	48	2
Two 8" frosted acrylic segments on top				
L-PPLFA-6624-0EE-N	1365	66	24	2
L-PPLFA-6630-0EE-N	1401	66	30	2
L-PPLFA-6636-0EE-N	1701	66	36	2
L-PPLFA-6642-0EE-N	1733	66	42	2
L-PPLFA-6648-0EE-N	1804	66	48	2
One 8" & One 16" frosted acrylic segment on top				
L-PPLFA-6624-0ES-N	1362	66	24	2
L-PPLFA-6630-0ES-N	1434	66	30	2
L-PPLFA-6636-0ES-N	1742	66	36	2
L-PPLFA-6642-0ES-N	1817	66	42	2
L-PPLFA-6648-0ES-N	1874	66	48	2
Two 16" frosted acrylic segments on top				
L-PPLFA-8224-0SS-N	1268	82	24	2
L-PPLFA-8230-0SS-N	1297	82	30	2
L-PPLFA-8236-0SS-N	1581	82	36	2
One 24" & One 16" frosted acrylic segment on top				
L-PPLFA-8224-0TS-N	1495	82	24	2
L-PPLFA-8230-0TS-N	1618	82	30	2
L-PPLFA-8236-0TS-N	1902	82	36	2
Two 24" frosted acrylic segments on top				
L-PPLFA-8224-0TT-N	1434	82	24	2
L-PPLFA-8230-0TT-N	1546	82	30	2
L-PPLFA-8236-0TT-N	1817	82	36	2
One 8" & Two 16" frosted acrylic segments on top				
L-PPLFA-8224-ESS-N	1555	82	24	2
L-PPLFA-8230-ESS-N	1746	82	30	2
L-PPLFA-8236-ESS-N	2041	82	36	2
Three 16" frosted acrylic segments on top				
L-PPLFA-8224-SSS-N	1525	82	24	2
L-PPLFA-8230-SSS-N	1645	82	30	2
L-PPLFA-8236-SSS-N	2031	82	36	2

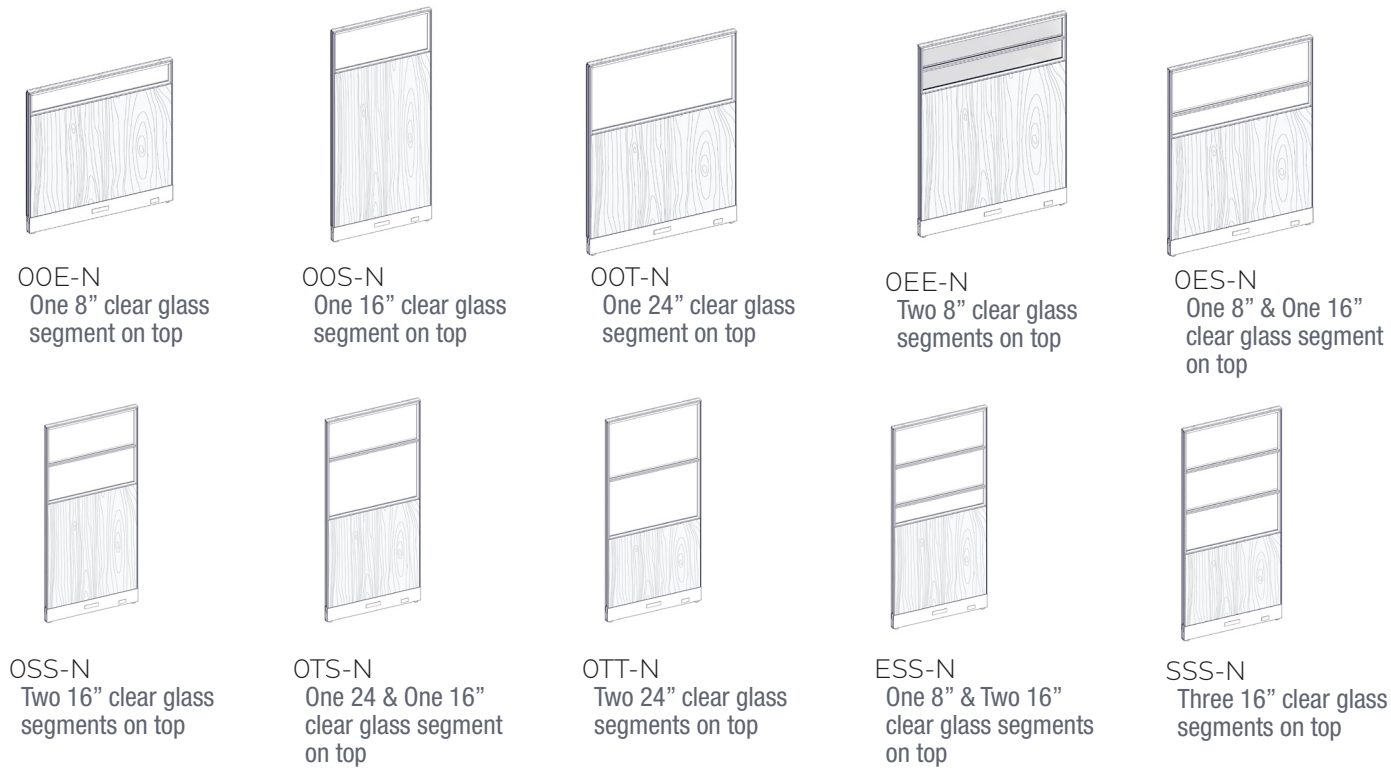

**How to order and read your code**

**L - P P L C G - 42 24 - 00E - N**

product standard P= Integrated F=Fabric C=Clear A=Acrylic height width 0= No segment N=Non powered  
 line E = Elevated L=Laminate F=Frosted G=Glass E = Powered  
 S = 16 inch segment  
 T = 24 inch segment

**What's Included:**

One (1) 2" thick laminate panel with 1" incremented slotted channels,  
 Two (2) raceway covers,  
 One (1) top trim

**How to Specify:**

Refer to laminate cards for laminate selections  
 Choose White, Black, Silver, Charcoal for Panel Frame colour

**Options:**

Height\*: 34", 42", 50", 66", 82"

Width: 24", 30", 36", 42", 48",

Laminate

Metal Powder Coat Paint: White, Black, Silver, Charcoal

\*82"H available up to 36"W

Code	Price	H	W	D
One 8" clear glass segment on top				
L-PPLCG-4224-00E-N	1213	42	24	2
L-PPLCG-4230-00E-N	1274	42	30	2
L-PPLCG-4236-00E-N	1333	42	36	2
L-PPLCG-4242-00E-N	1401	42	42	2
L-PPLCG-4248-00E-N	1367	42	48	2
L-PPLCG-5024-00E-N	1101	50	24	2
L-PPLCG-5030-00E-N	1145	50	30	2
L-PPLCG-5036-00E-N	1219	50	36	2
L-PPLCG-5042-00E-N	1379	50	42	2
L-PPLCG-5048-00E-N	1426	50	48	2
One 16" clear glass segment on top				
L-PPLCG-5024-00S-N	1168	50	24	2
L-PPLCG-5030-00S-N	1231	50	30	2
L-PPLCG-5036-00S-N	1321	50	36	2
L-PPLCG-5042-00S-N	1481	50	42	2
L-PPLCG-5048-00S-N	1546	50	48	2
L-PPLCG-6624-00S-N	1263	66	24	2
L-PPLCG-6630-00S-N	1328	66	30	2
L-PPLCG-6636-00S-N	1429	66	36	2
L-PPLCG-6642-00S-N	1650	66	42	2
L-PPLCG-6648-00S-N	1716	66	48	2
L-PPLCG-8224-00S-N	1455	82	24	2
L-PPLCG-8230-00S-N	1498	82	30	2
L-PPLCG-8236-00S-N	2021	82	36	2
One 24" clear glass segment on top				
L-PPLCG-6624-00T-N	1304	66	24	2
L-PPLCG-6630-00T-N	1388	66	30	2
L-PPLCG-6636-00T-N	1498	66	36	2
L-PPLCG-6642-00T-N	1701	66	42	2
L-PPLCG-6648-00T-N	1788	66	48	2
Two 8" clear glass segments on top				
L-PPLCG-6624-0EE-N	1399	66	24	2
L-PPLCG-6630-0EE-N	1448	66	30	2
L-PPLCG-6636-0EE-N	1746	66	36	2
L-PPLCG-6642-0EE-N	1792	66	42	2
L-PPLCG-6648-0EE-N	1863	66	48	2
One 8" & One 16" clear glass segment on top				
L-PPLCG-6624-0ES-N	1399	66	24	2
L-PPLCG-6630-0ES-N	1466	66	30	2
L-PPLCG-6636-0ES-N	1780	66	36	2
L-PPLCG-6642-0ES-N	1840	66	42	2
L-PPLCG-6648-0ES-N	1925	66	48	2
Two 16" clear glass segments on top				
L-PPLCG-8224-0SS-N	1450	82	24	2
L-PPLCG-8230-0SS-N	1516	82	30	2
L-PPLCG-8236-0SS-N	1843	82	36	2
One 24" & One 16" clear glass segment on top				
L-PPLCG-8224-0TS-N	1480	82	24	2
L-PPLCG-8230-0TS-N	1570	82	30	2
L-PPLCG-8236-0TS-N	1903	82	36	2
Two 24" clear glass segments on top				
L-PPLCG-8224-0TT-N	1450	82	24	2
L-PPLCG-8230-0TT-N	1544	82	30	2
L-PPLCG-8236-0TT-N	1807	82	36	2
One 8" & Two 16" clear glass segments on top				
L-PPLCG-8224-ESS-N	1624	82	24	2
L-PPLCG-8230-ESS-N	1774	82	30	2
L-PPLCG-8236-ESS-N	2119	82	36	2
Three 16" clear glass segments on top				
L-PPLCG-8224-SSS-N	1602	82	24	2
L-PPLCG-8230-SSS-N	1689	82	30	2
L-PPLCG-8236-SSS-N	1976	82	36	2

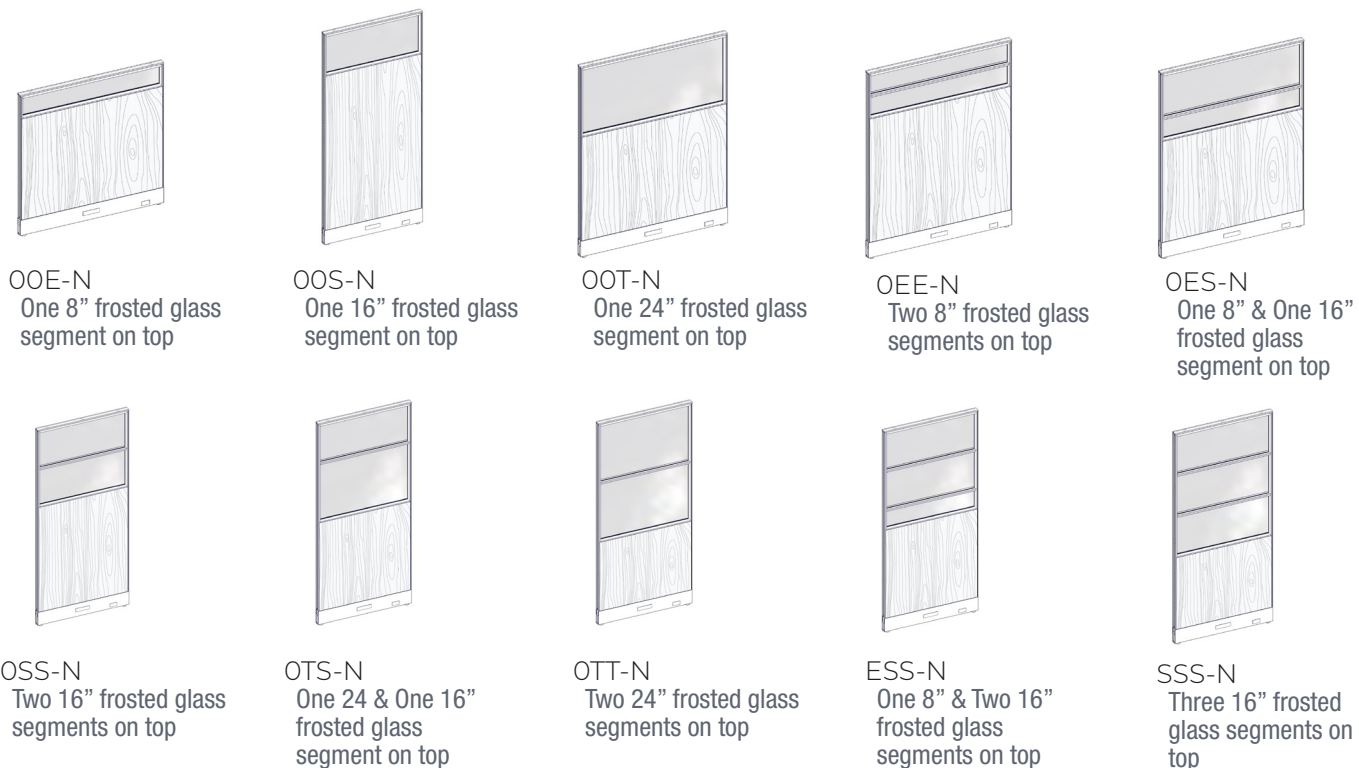

**How to order and read your code**

**L - P P L F G - 42 24 - 00E - N**

product standard P= Integrated F=Fabric C=Clear A=Acrylic height width 0= No segment N=Non powered  
 line E = Elevated L=Laminate F=Frosted G=Glass E = Powered  
 S = 16 inch segment  
 T = 24 inch segment

**What's Included:**

One (1) 2" thick laminate panel with 1" incremented slotted channels,  
 Two (2) raceway covers,  
 One (1) top trim

**How to Specify:**

Refer to laminate cards for laminate selections  
 Choose White, Black, Silver, Charcoal for Panel Frame colour

**Options:**

Height\*: 34", 42", 50", 66", 82"

Width: 24", 30", 36", 42", 48",

Laminate

Metal Powder Coat Paint: White, Black, Silver, Charcoal

\*82"H available up to 36"W

**Notes:**

Power capable panel with bracket for power module.  
 Power module must be specified seperately.  
 Panels are non tackable. For tackable option see Panel Add-On section.

Code	Price	H	W	D
One 8" frosted glass segment on top				
L-PPLFG-4224-00E-N	1166	42	24	2
L-PPLFG-4230-00E-N	1207	42	30	2
L-PPLFG-4236-00E-N	1277	42	36	2
L-PPLFG-4242-00E-N	1422	42	42	2
L-PPLFG-4248-00E-N	1466	42	48	2
L-PPLFG-5024-00E-N	1200	50	24	2
L-PPLFG-5030-00E-N	1244	50	30	2
L-PPLFG-5036-00E-N	1318	50	36	2
L-PPLFG-5042-00E-N	1478	50	42	2
L-PPLFG-5048-00E-N	1525	50	48	2
One 16" frosted glass segment on top				
L-PPLFG-5024-00S-N	1267	50	24	2
L-PPLFG-5030-00S-N	1329	50	30	2
L-PPLFG-5036-00S-N	1420	50	36	2
L-PPLFG-5042-00S-N	1581	50	42	2
L-PPLFG-5048-00S-N	1645	50	48	2
L-PPLFG-6624-00S-N	1363	66	24	2
L-PPLFG-6630-00S-N	1427	66	30	2
L-PPLFG-6636-00S-N	1528	66	36	2
L-PPLFG-6642-00S-N	1750	66	42	2
L-PPLFG-6648-00S-N	1815	66	48	2
L-PPLFG-8224-00S-N	1538	82	24	2
L-PPLFG-8230-00S-N	1587	82	30	2
L-PPLFG-8236-00S-N	2129	82	36	2
One 24" frosted glass segment on top				
L-PPLFG-6624-00T-N	1403	66	24	2
L-PPLFG-6630-00T-N	1487	66	30	2
L-PPLFG-6636-00T-N	1597	66	36	2
L-PPLFG-6642-00T-N	1800	66	42	2
L-PPLFG-6648-00T-N	1887	66	48	2
Two 8" frosted glass segments on top				
L-PPLFG-6624-0EE-N	1561	66	24	2
L-PPLFG-6630-0EE-N	1609	66	30	2
L-PPLFG-6636-0EE-N	1907	66	36	2
L-PPLFG-6642-0EE-N	1955	66	42	2
L-PPLFG-6648-0EE-N	2024	66	48	2
One 8" & One 16" frosted glass segment on top				
L-PPLFG-6624-0ES-N	1561	66	24	2
L-PPLFG-6630-0ES-N	1637	66	30	2
L-PPLFG-6636-0ES-N	1969	66	36	2
L-PPLFG-6642-0ES-N	2047	66	42	2
L-PPLFG-6648-0ES-N	2151	66	48	2
Two 16" frosted glass segments on top				
L-PPLFG-8224-0SS-N	1613	82	24	2
L-PPLFG-8230-0SS-N	1694	82	30	2
L-PPLFG-8236-0SS-N	2059	82	36	2
One 24" & One 16" frosted glass segment on top				
L-PPLFG-8224-0TS-N	1669	82	24	2
L-PPLFG-8230-0TS-N	1793	82	30	2
L-PPLFG-8236-0TS-N	2175	82	36	2
Two 24" frosted glass segments on top				
L-PPLFG-8224-0TT-N	1668	82	24	2
L-PPLFG-8230-0TT-N	1814	82	30	2
L-PPLFG-8236-0TT-N	2133	82	36	2
One 8" & Two 16" frosted glass segments on top				
L-PPLFG-8224-ESS-N	1868	82	24	2
L-PPLFG-8230-ESS-N	2035	82	30	2
L-PPLFG-8236-ESS-N	2417	82	36	2
Three 16" frosted glass segments on top				
L-PPLFG-8224-SSS-N	1846	82	24	2
L-PPLFG-8230-SSS-N	1958	82	30	2
L-PPLFG-8236-SSS-N	2300	82	36	2



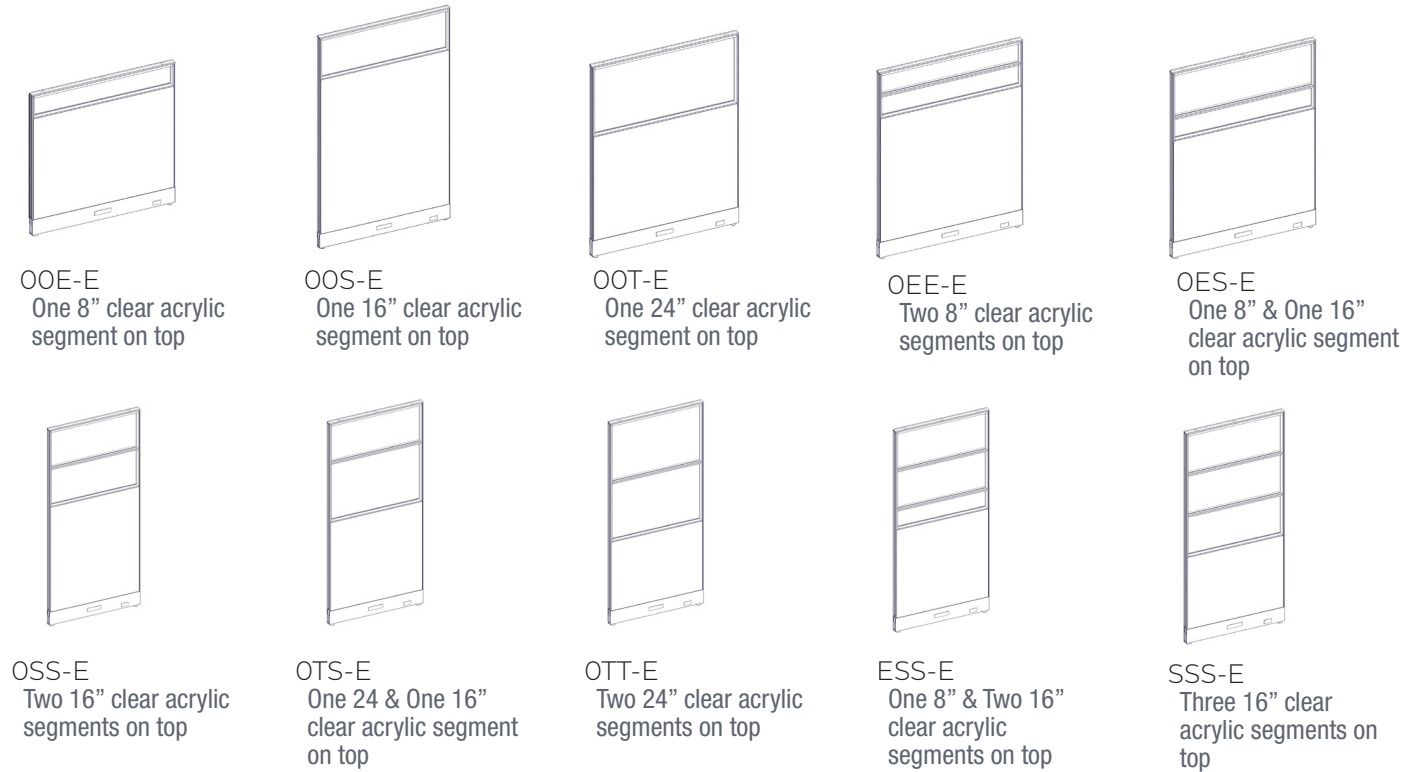

**How to order and read your code**

**L - P P F C A - 42 24 - 00E - E**

product standard P= integrated F=Fabric C=Clear A=Acrylic height width 0 = No segment N=Non powered  
 line E = Elevated L=Laminate F=Frosted G=Glass E = 8 inch segment E=Powered  
 S = 16 inch segment  
 T = 24 inch segment

**What's Included:**

One (1) 2" thick laminate panel with 1" incremented slotted channels,  
 Two (2) raceway covers,  
 One (1) top trim

**How to Specify:**

Refer to laminate cards for laminate selections  
 Choose White, Black, Silver, Charcoal for Panel Frame colour

**Options:**

Height\*: 34", 42", 50", 66", 82"

Width: 24", 30", 36", 42", 48",

Laminate

Metal Powder Coat Paint: White, Black, Silver, Charcoal

\*82"H available up to 36"W

Code	Price	H	W	D
<b>One 8" clear acrylic segment on top</b>				
L-PPFCA-4224-00E-E	803	42	24	2
L-PPFCA-4230-00E-E	881	42	30	2
L-PPFCA-4236-00E-E	958	42	36	2
L-PPFCA-4242-00E-E	1036	42	42	2
L-PPFCA-4248-00E-E	1114	42	48	2
L-PPFCA-4254-00E-E	1195	42	54	2
L-PPFCA-4260-00E-E	1272	42	60	2
L-PPFCA-5024-00E-E	803	50	24	2
L-PPFCA-5030-00E-E	881	50	30	2
L-PPFCA-5036-00E-E	958	50	36	2
L-PPFCA-5042-00E-E	1036	50	42	2
L-PPFCA-5048-00E-E	1114	50	48	2
L-PPFCA-5054-00E-E	1195	50	54	2
L-PPFCA-5060-00E-E	1272	50	60	2
<b>One 16" clear acrylic segment on top</b>				
L-PPFCA-5024-00S-E	803	50	24	2
L-PPFCA-5030-00S-E	881	50	30	2
L-PPFCA-5036-00S-E	958	50	36	2
L-PPFCA-5042-00S-E	1036	50	42	2
L-PPFCA-5048-00S-E	1114	50	48	2
L-PPFCA-5054-00S-E	1195	50	54	2
L-PPFCA-5060-00S-E	1272	50	60	2
L-PPFCA-6624-00S-E	928	66	24	2
L-PPFCA-6630-00S-E	1025	66	30	2
L-PPFCA-6636-00S-E	1123	66	36	2
L-PPFCA-6642-00S-E	1221	66	42	2
L-PPFCA-6648-00S-E	1320	66	48	2
L-PPFCA-6654-00S-E	1418	66	54	2
L-PPFCA-6660-00S-E	1517	66	60	2
L-PPFCA-8224-00S-E	1444	82	24	2
L-PPFCA-8230-00S-E	1673	82	30	2
L-PPFCA-8236-00S-E	1759	82	36	2
L-PPFCA-8242-00S-E	1802	82	42	2
L-PPFCA-8248-00S-E	1883	82	48	2
<b>One 24" clear acrylic segment on top</b>				
L-PPFCA-6624-00T-E	928	66	24	2
L-PPFCA-6630-00T-E	1025	66	30	2
L-PPFCA-6636-00T-E	1123	66	36	2
L-PPFCA-6642-00T-E	1221	66	42	2
L-PPFCA-6648-00T-E	1320	66	48	2
L-PPFCA-6654-00T-E	1418	66	54	2
L-PPFCA-6660-00T-E	1517	66	60	2
<b>Two 8" clear acrylic segments on top</b>				
L-PPFCA-6624-0EE-E	1427	66	24	2
L-PPFCA-6630-0EE-E	1614	66	30	2
L-PPFCA-6636-0EE-E	1682	66	36	2
L-PPFCA-6642-0EE-E	1737	66	42	2
L-PPFCA-6648-0EE-E	1812	66	48	2
L-PPFCA-6654-0EE-E	1926	66	54	2
L-PPFCA-6660-0EE-E	1977	66	60	2
<b>One 8" &amp; One 16" clear acrylic segment on top</b>				
L-PPFCA-6624-0ES-E	1394	66	24	2
L-PPFCA-6630-0ES-E	1574	66	30	2
L-PPFCA-6636-0ES-E	1653	66	36	2
L-PPFCA-6642-0ES-E	1733	66	42	2
L-PPFCA-6648-0ES-E	1816	66	48	2
L-PPFCA-6654-0ES-E	1903	66	54	2
L-PPFCA-6660-0ES-E	1945	66	60	2
<b>Two 16" clear acrylic segments on top</b>				
L-PPFCA-8224-0SS-E	1484	82	24	2
L-PPFCA-8230-0SS-E	1725	82	30	2
L-PPFCA-8236-0SS-E	1846	82	36	2
L-PPFCA-8242-0SS-E	1899	82	42	2
L-PPFCA-8248-0SS-E	1975	82	48	2
<b>One 24" &amp; One 16" clear acrylic segment on top</b>				
L-PPFCA-8224-0TS-E	1476	82	24	2
L-PPFCA-8230-0TS-E	1692	82	30	2
L-PPFCA-8236-0TS-E	1759	82	36	2
L-PPFCA-8242-0TS-E	1813	82	42	2
L-PPFCA-8248-0TS-E	1995	82	48	2
<b>Two 24" clear acrylic segments on top</b>				
L-PPFCA-8224-0TT-E	1472	82	24	2
L-PPFCA-8230-0TT-E	1668	82	30	2
L-PPFCA-8236-0TT-E	1755	82	36	2
L-PPFCA-8242-0TT-E	1870	82	42	2
L-PPFCA-8248-0TT-E	1944	82	48	2
<b>One 8" &amp; Two 16" clear acrylic segments on top</b>				
L-PPFCA-8224-ESS-E	1537	82	24	2
L-PPFCA-8230-ESS-E	1823	82	30	2
L-PPFCA-8236-ESS-E	1899	82	36	2
L-PPFCA-8242-ESS-E	1902	82	42	2
L-PPFCA-8248-ESS-E	2083	82	48	2
<b>Three 16" clear acrylic segments on top</b>				
L-PPFCA-8224-SSS-E	1563	82	24	2
L-PPFCA-8230-SSS-E	1767	82	30	2
L-PPFCA-8236-SSS-E	1928	82	36	2
L-PPFCA-8242-SSS-E	1992	82	42	2
L-PPFCA-8248-SSS-E	2077	82	48	2

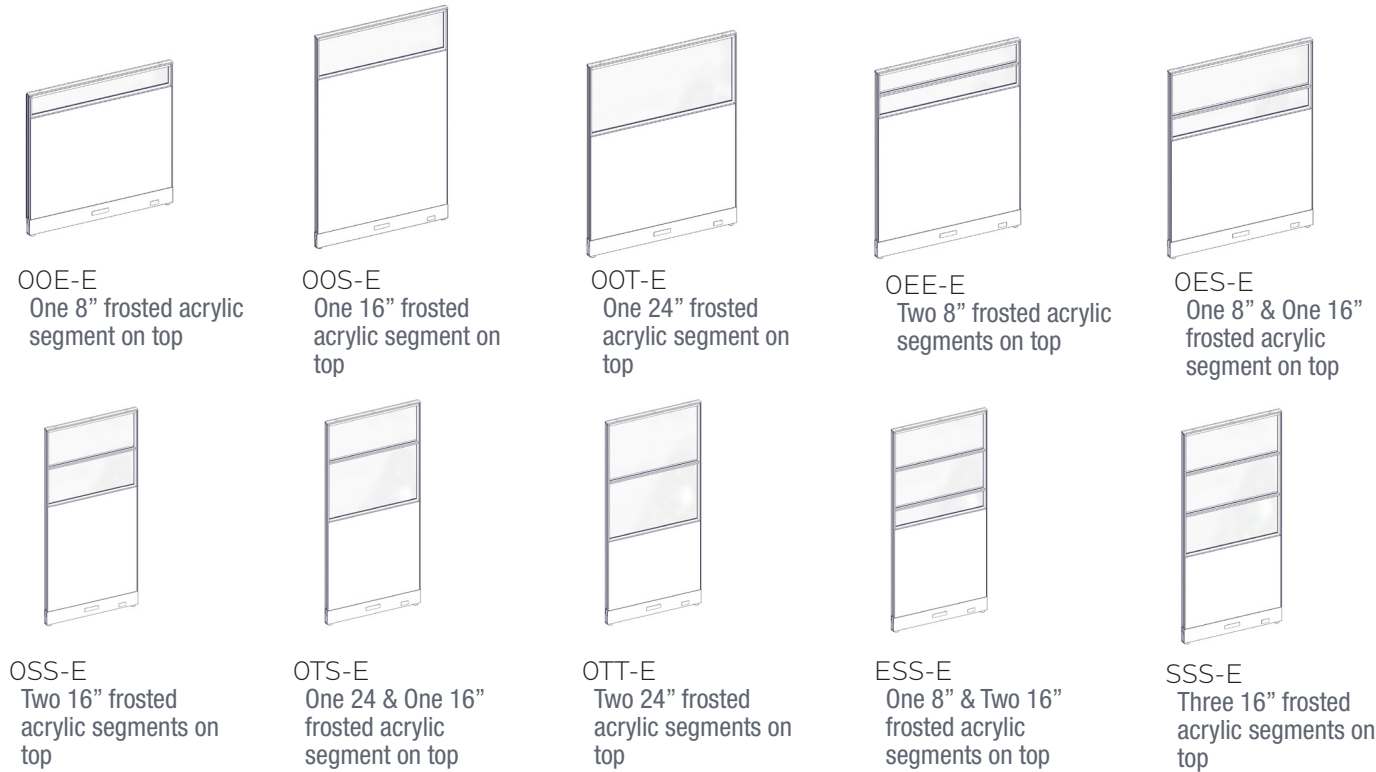

**How to order and read your code**

**L - P P F F A - 42 24 - 00E - E**

product standard line P= Integrated E= Elevated F=Fabric L=Laminate C=Clear F=Frosted A=Acrylic height G=Glass width 0= No segment E= 8 inch segment S= 16 inch segment T= 24 inch segment N=Non powered E=Powered

**What's Included:**

One (1) 2" thick laminate panel with 1" incremented slotted channels,  
Two (2) raceway covers,  
One (1) top trim

**How to Specify:**

Refer to laminate cards for laminate selections  
Choose White, Black, Silver, Charcoal for Panel Frame colour

**Options:**

Height*:	34", 42", 50", 66", 82"
Width:	24", 30", 36", 42", 48",
Laminate	
Metal Powder Coat Paint:	White, Black, Silver, Charcoal

\*82"H available up to 36"W

Code	Price	H	W	D
<b>One 8" frosted acrylic segment on top</b>				
L-PPFFA-4224-00E-E	902	42	24	2
L-PPFFA-4230-00E-E	980	42	30	2
L-PPFFA-4236-00E-E	1057	42	36	2
L-PPFFA-4242-00E-E	1135	42	42	2
L-PPFFA-4248-00E-E	1213	42	48	2
L-PPFFA-4254-00E-E	1294	42	54	2
L-PPFFA-4260-00E-E	1370	42	60	2
L-PPFFA-5024-00E-E	902	50	24	2
L-PPFFA-5030-00E-E	980	50	30	2
L-PPFFA-5036-00E-E	1057	50	36	2
L-PPFFA-5042-00E-E	1135	50	42	2
L-PPFFA-5048-00E-E	1213	50	48	2
L-PPFFA-5054-00E-E	1294	50	54	2
L-PPFFA-5060-00E-E	1370	50	60	2
<b>One 16" frosted acrylic segment on top</b>				
L-PPFFA-5024-00S-E	902	50	24	2
L-PPFFA-5030-00S-E	980	50	30	2
L-PPFFA-5036-00S-E	1057	50	36	2
L-PPFFA-5042-00S-E	1135	50	42	2
L-PPFFA-5048-00S-E	1213	50	48	2
L-PPFFA-5054-00S-E	1294	50	54	2
L-PPFFA-5060-00S-E	1370	50	60	2
L-PPFFA-6624-00S-E	1027	50	24	2
L-PPFFA-6630-00S-E	1124	50	30	2
L-PPFFA-6636-00S-E	1222	50	36	2
L-PPFFA-6642-00S-E	1320	50	42	2
L-PPFFA-6648-00S-E	1419	50	48	2
L-PPFFA-6654-00S-E	1517	50	54	2
L-PPFFA-6660-00S-E	1616	50	60	2
L-PPFFA-8224-00S-E	1478	82	24	2
L-PPFFA-8230-00S-E	1719	82	30	2
L-PPFFA-8236-00S-E	1817	82	36	2
L-PPFFA-8242-00S-E	1870	82	42	2
L-PPFFA-8248-00S-E	1949	82	48	2
<b>One 24" frosted acrylic segment on top</b>				
L-PPFFA-6624-00T-E	1027	66	24	2
L-PPFFA-6630-00T-E	1124	66	30	2
L-PPFFA-6636-00T-E	1222	66	36	2
L-PPFFA-6642-00T-E	1274	66	42	2
L-PPFFA-6648-00T-E	1374	66	48	2
L-PPFFA-6654-00T-E	1517	66	54	2
L-PPFFA-6660-00T-E	1616	66	60	2
<b>Two 8" frosted acrylic segments on top</b>				
L-PPFFA-6624-0EE-E	1486	66	24	2
L-PPFFA-6630-0EE-E	1693	66	30	2
L-PPFFA-6636-0EE-E	1786	66	36	2
L-PPFFA-6642-0EE-E	1840	66	42	2
L-PPFFA-6648-0EE-E	1931	66	48	2
L-PPFFA-6654-0EE-E	2011	66	54	2
L-PPFFA-6660-0EE-E	2060	66	60	2
<b>One 8" &amp; One 16" frosted acrylic segment on top</b>				
L-PPFFA-6624-0ES-E	1443	66	24	2
L-PPFFA-6630-0ES-E	1642	66	30	2
L-PPFFA-6636-0ES-E	1734	66	36	2
L-PPFFA-6642-0ES-E	1834	66	42	2
L-PPFFA-6648-0ES-E	1916	66	48	2
L-PPFFA-6654-0ES-E	2015	66	54	2
L-PPFFA-6660-0ES-E	2076	66	60	2
<b>Two 16" frosted acrylic segments on top</b>				
L-PPFFA-8224-0SS-E	1389	82	24	2
L-PPFFA-8230-0SS-E	1588	82	30	2
L-PPFFA-8236-0SS-E	1667	82	36	2
L-PPFFA-8242-0SS-E	1727	82	42	2
L-PPFFA-8248-0SS-E	1791	82	48	2
<b>One 24" &amp; One 16" frosted acrylic segment on top</b>				
L-PPFFA-8224-0TS-E	1576	82	24	2
L-PPFFA-8230-0TS-E	1826	82	30	2
L-PPFFA-8236-0TS-E	1892	82	36	2
L-PPFFA-8242-0TS-E	1980	82	42	2
L-PPFFA-8248-0TS-E	2197	82	48	2
<b>Two 24" frosted acrylic segments on top</b>				
L-PPFFA-8224-0TT-E	1572	82	24	2
L-PPFFA-8230-0TT-E	1802	82	30	2
L-PPFFA-8236-0TT-E	1916	82	36	2
L-PPFFA-8242-0TT-E	2070	82	42	2
L-PPFFA-8248-0TT-E	2143	82	48	2
<b>One 8" &amp; Two 16" frosted acrylic segments on top</b>				
L-PPFFA-8224-ESS-E	1637	82	24	2
L-PPFFA-8230-ESS-E	1955	82	30	2
L-PPFFA-8236-ESS-E	2033	82	36	2
L-PPFFA-8242-ESS-E	2097	82	42	2
L-PPFFA-8248-ESS-E	2215	82	48	2
<b>Three 16" frosted acrylic segments on top</b>				
L-PPFFA-8224-SSS-E	1664	82	24	2
L-PPFFA-8230-SSS-E	1899	82	30	2
L-PPFFA-8236-SSS-E	2130	82	36	2
L-PPFFA-8242-SSS-E	2192	82	42	2
L-PPFFA-8248-SSS-E	2277	82	48	2

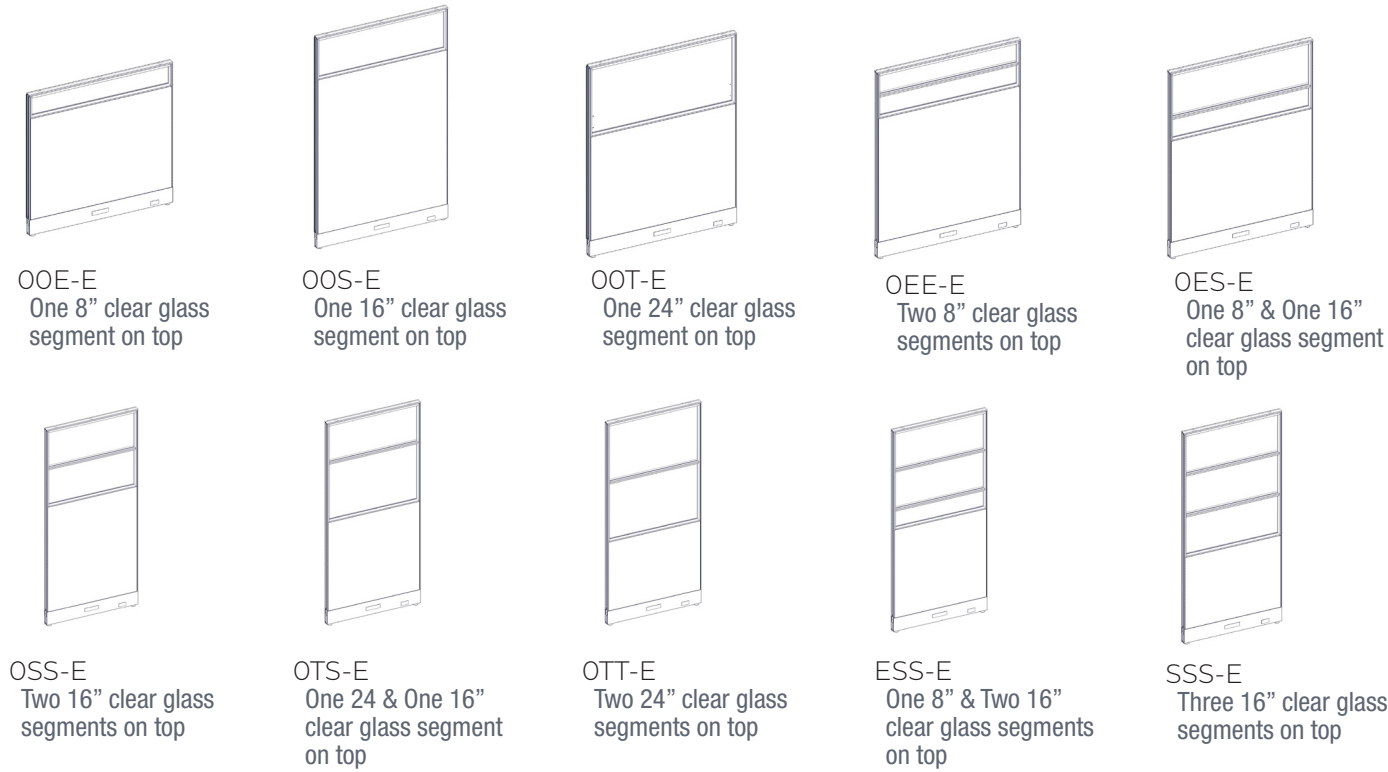

**How to order and read your code**

**L - P P F C G - 42 24 - 00E - E**

product standard P= integrated F=Fabric C=Clear A=Acrylic height width 0= No segment N=Non powered  
 line E = Elevated L=Laminate F=Frosted G=Glass E = 8 inch segment E=Powered  
 S = 16 inch segment  
 T = 24 inch segment

**What's Included:**

One (1) 2" thick laminate panel with 1" incremented slotted channels,  
 Two (2) raceway covers,  
 One (1) top trim

**How to Specify:**

Refer to laminate cards for laminate selections  
 Choose White, Black, Silver, Charcoal for Panel Frame colour

**Options:**

Height\*: 34", 42", 50", 66", 82"

Width: 24", 30", 36", 42", 48",

Laminate

Metal Powder Coat Paint: White, Black, Silver, Charcoal

\*82"H available up to 36"W

**Notes:**

Power capable panel with bracket for power module.  
 Power module must be specified separately.  
 Panels are non tackable. For tackable option see Panel Add-On section.  
 Fabric Upcharge  
 Grade 2 - \$204 per panel,  
 Grade 3 - \$251 per panel

Code	Price	H	W	D
<b>One 8" clear glass segment on top</b>				
L-PPFCG-4224-00E-E	934	42	24	2
L-PPFCG-4230-00E-E	1012	42	30	2
L-PPFCG-4236-00E-E	1090	42	36	2
L-PPFCG-4242-00E-E	1168	42	42	2
L-PPFCG-4248-00E-E	1246	42	48	2
L-PPFCG-4254-00E-E	1326	42	54	2
L-PPFCG-4260-00E-E	1401	42	60	2
L-PPFCG-5024-00E-E	934	50	24	2
L-PPFCG-5030-00E-E	1012	50	30	2
L-PPFCG-5036-00E-E	1090	50	36	2
L-PPFCG-5042-00E-E	1168	50	42	2
L-PPFCG-5048-00E-E	1246	50	48	2
L-PPFCG-5054-00E-E	1326	50	54	2
L-PPFCG-5060-00E-E	1401	50	60	2
<b>One 16" clear glass segment on top</b>				
L-PPFCG-5024-00S-E	934	50	24	2
L-PPFCG-5030-00S-E	1012	50	30	2
L-PPFCG-5036-00S-E	1090	50	36	2
L-PPFCG-5042-00S-E	1168	50	42	2
L-PPFCG-5048-00S-E	1246	50	48	2
L-PPFCG-5054-00S-E	1326	50	54	2
L-PPFCG-5060-00S-E	1401	50	60	2
L-PPFCG-6624-00S-E	1068	66	24	2
L-PPFCG-6630-00S-E	1164	66	30	2
L-PPFCG-6636-00S-E	1263	66	36	2
L-PPFCG-6642-00S-E	1362	66	42	2
L-PPFCG-6648-00S-E	1462	66	48	2
L-PPFCG-6654-00S-E	1560	66	54	2
L-PPFCG-6660-00S-E	1659	66	60	2
L-PPFCG-8224-00S-E	1405	82	24	2
L-PPFCG-8230-00S-E	1659	82	30	2
L-PPFCG-8236-00S-E	1766	82	36	2
L-PPFCG-8242-00S-E	1824	82	42	2
L-PPFCG-8248-00S-E	1925	82	48	2
<b>One 24" clear glass segment on top</b>				
L-PPFCG-6624-00T-E	1068	66	24	2
L-PPFCG-6630-00T-E	1164	66	30	2
L-PPFCG-6636-00T-E	1263	66	36	2
L-PPFCG-6642-00T-E	1362	66	42	2
L-PPFCG-6648-00T-E	1462	66	48	2
L-PPFCG-6654-00T-E	1560	66	54	2
L-PPFCG-6660-00T-E	1659	66	60	2
<b>Two 8" clear glass segments on top</b>				
L-PPFCG-6624-0EE-E	1520	66	24	2
L-PPFCG-6630-0EE-E	1740	66	30	2
L-PPFCG-6636-0EE-E	1832	66	36	2
L-PPFCG-6642-0EE-E	1898	66	42	2
L-PPFCG-6648-0EE-E	1988	66	48	2
L-PPFCG-6654-0EE-E	2102	66	54	2
L-PPFCG-6660-0EE-E	2164	66	60	2
<b>One 8" &amp; One 16" clear glass segment on top</b>				
L-PPFCG-6624-0ES-E	1481	66	24	2
L-PPFCG-6630-0ES-E	1674	66	30	2
L-PPFCG-6636-0ES-E	1770	66	36	2
L-PPFCG-6642-0ES-E	1855	66	42	2
L-PPFCG-6648-0ES-E	1968	66	48	2
L-PPFCG-6654-0ES-E	2090	66	54	2
L-PPFCG-6660-0ES-E	2158	66	60	2
<b>Two 16" clear glass segments on top</b>				
L-PPFCG-8224-0SS-E	1572	82	24	2
L-PPFCG-8230-0SS-E	1806	82	30	2
L-PPFCG-8236-0SS-E	1928	82	36	2
L-PPFCG-8242-0SS-E	2025	82	42	2
L-PPFCG-8248-0SS-E	2143	82	48	2
<b>One 24" &amp; One 16" clear glass segment on top</b>				
L-PPFCG-8224-0TS-E	1561	82	24	2
L-PPFCG-8230-0TS-E	1778	82	30	2
L-PPFCG-8236-0TS-E	1895	82	36	2
L-PPFCG-8242-0TS-E	2004	82	42	2
L-PPFCG-8248-0TS-E	2137	82	48	2
<b>Two 24" clear glass segments on top</b>				
L-PPFCG-8224-0TT-E	1588	82	24	2
L-PPFCG-8230-0TT-E	1800	82	30	2
L-PPFCG-8236-0TT-E	1909	82	36	2
L-PPFCG-8242-0TT-E	2021	82	42	2
L-PPFCG-8248-0TT-E	2153	82	48	2
<b>One 8" &amp; Two 16" clear glass segments on top</b>				
L-PPFCG-8224-0SS-E	1705	82	24	2
L-PPFCG-8230-0SS-E	1983	82	30	2
L-PPFCG-8236-0SS-E	2112	82	36	2
L-PPFCG-8242-0SS-E	2131	82	42	2
L-PPFCG-8248-0SS-E	2298	82	48	2
<b>Three 16" clear glass segments on top</b>				
L-PPFCG-8224-0SS-E	1741	82	24	2
L-PPFCG-8230-0SS-E	1945	82	30	2
L-PPFCG-8236-0SS-E	2077	82	36	2
L-PPFCG-8242-0SS-E	2202	82	42	2
L-PPFCG-8248-0SS-E	2352	82	48	2

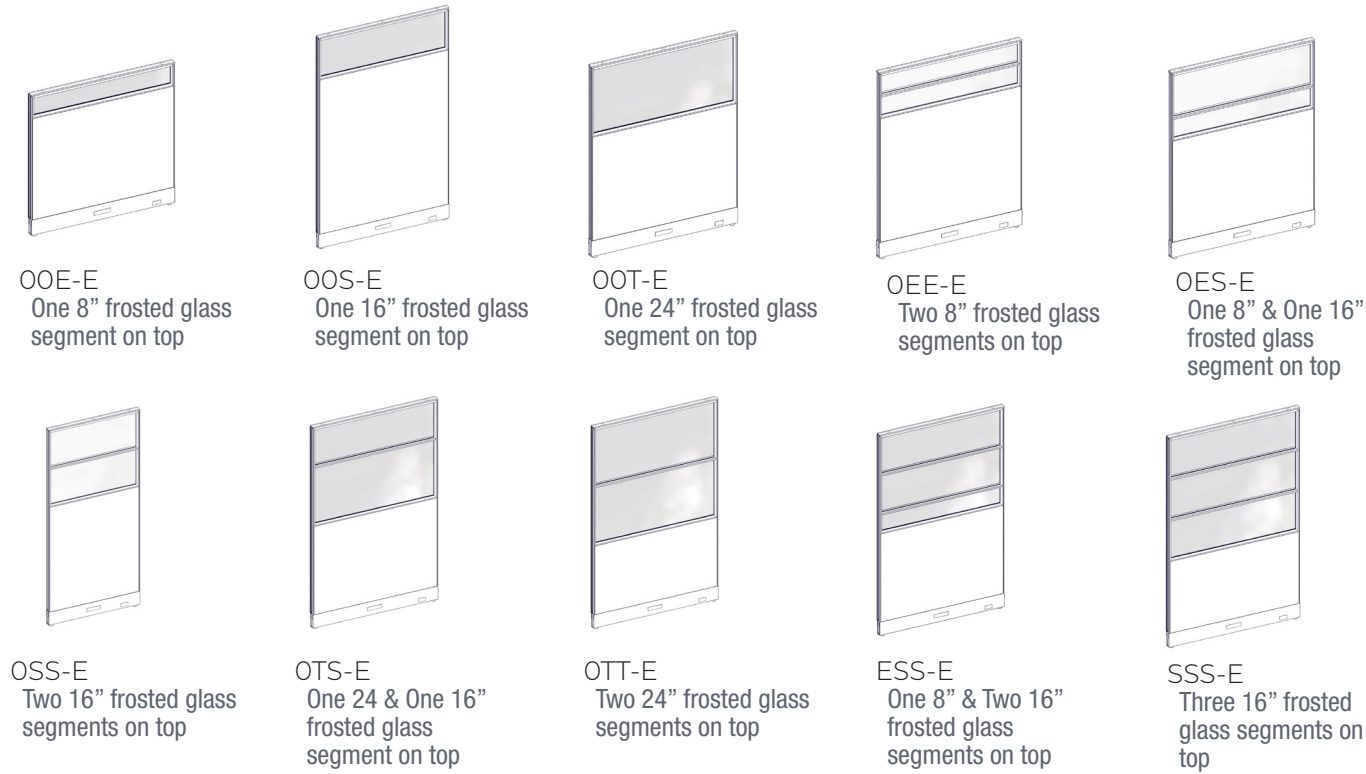

**How to order and read your code**

**L - P P F F G - 42 24 - 00E - E**

product standard P= integrated F=Fabric C= Clear A=Acrylic height width 0= No segment N=Non powered  
line E = Elevated L=Laminate F=Frosted G=Glass E = 8 inch segment E=Powered  
S = 16 inch segment  
T = 24 inch segment

**What's Included:**

One (1) 2" thick laminate panel with 1" incremented slotted channels,  
Two (2) raceway covers,  
One (1) top trim

**How to Specify:**

Refer to laminate cards for laminate selections  
Choose White, Black, Silver, Charcoal for Panel Frame colour

**Options:**

Height*:	34", 42", 50", 66", 82"
Width:	24", 30", 36", 42", 48",
Laminate	
Metal Powder Coat Paint:	White, Black, Silver, Charcoal

\*82"H available up to 36"W

**Notes:**

Power capable panel with bracket for power module.  
Power module must be specified seperately.  
Panels are non tackable. For tackable option see Panel Add-On section.  
Fabric Upcharge  
Grade 2 - \$204 per panel,  
Grade 3 - \$251 per panel

Code	Price	H	W	D
One 8" frosted glass segment on top				
L-PPFFG-4224-00E-E	1033	42	24	2
L-PPFFG-4230-00E-E	1111	42	30	2
L-PPFFG-4236-00E-E	1189	42	36	2
L-PPFFG-4242-00E-E	1267	42	42	2
L-PPFFG-4248-00E-E	1345	42	48	2
L-PPFFG-4254-00E-E	1425	42	54	2
L-PPFFG-4260-00E-E	1500	42	60	2
L-PPFFG-5024-00E-E	1033	50	24	2
L-PPFFG-5030-00E-E	1111	50	30	2
L-PPFFG-5036-00E-E	1189	50	36	2
L-PPFFG-5042-00E-E	1267	50	42	2
L-PPFFG-5048-00E-E	1345	50	48	2
L-PPFFG-5054-00E-E	1425	50	54	2
L-PPFFG-5060-00E-E	1500	50	60	2
One 16" frosted glass segment on top				
L-PPFFG-5024-00S-E	1033	50	24	2
L-PPFFG-5030-00S-E	1111	50	30	2
L-PPFFG-5036-00S-E	1189	50	36	2
L-PPFFG-5042-00S-E	1267	50	42	2
L-PPFFG-5048-00S-E	1345	50	48	2
L-PPFFG-5054-00S-E	1425	50	54	2
L-PPFFG-5060-00S-E	1500	50	60	2
One 24" frosted glass segment on top				
L-PPFFG-6624-00T-E	1166	66	24	2
L-PPFFG-6630-00T-E	1263	66	30	2
L-PPFFG-6636-00T-E	1363	66	36	2
L-PPFFG-6642-00T-E	1461	66	42	2
L-PPFFG-6648-00T-E	1561	66	48	2
L-PPFFG-6654-00T-E	1659	66	54	2
L-PPFFG-6660-00T-E	1758	66	60	2
Two 8" frosted glass segments on top				
L-PPFFG-6624-0EE-E	1682	66	24	2
L-PPFFG-6630-0EE-E	1902	66	30	2
L-PPFFG-6636-0EE-E	1994	66	36	2
L-PPFFG-6642-0EE-E	2060	66	42	2
L-PPFFG-6648-0EE-E	2149	66	48	2
L-PPFFG-6654-0EE-E	2265	66	54	2
L-PPFFG-6660-0EE-E	2343	66	60	2
One 8" & One 16" frosted glass segment on top				
L-PPFFG-6624-0ES-E	1643	66	24	2
L-PPFFG-6630-0ES-E	1846	66	30	2
L-PPFFG-6636-0ES-E	1960	66	36	2
L-PPFFG-6642-0ES-E	2065	66	42	2
L-PPFFG-6648-0ES-E	2192	66	48	2
L-PPFFG-6654-0ES-E	2334	66	54	2
L-PPFFG-6660-0ES-E	2430	66	60	2
Two 16" frosted glass segments on top				
L-PPFFG-8224-0SS-E	1734	82	24	2
L-PPFFG-8230-0SS-E	1987	82	30	2
L-PPFFG-8236-0SS-E	2145	82	36	2
L-PPFFG-8242-0SS-E	2277	82	42	2
L-PPFFG-8248-0SS-E	2432	82	48	2
One 24" & One 16" frosted glass segment on top				
L-PPFFG-8224-0TS-E	1750	82	24	2
L-PPFFG-8230-0TS-E	2003	82	30	2
L-PPFFG-8236-0TS-E	2167	82	36	2
L-PPFFG-8242-0TS-E	2320	82	42	2
L-PPFFG-8248-0TS-E	2497	82	48	2
Two 24" frosted glass segments on top				
L-PPFFG-8224-0TT-E	1805	82	24	2
L-PPFFG-8230-0TT-E	2070	82	30	2
L-PPFFG-8236-0TT-E	2233	82	36	2
L-PPFFG-8242-0TT-E	2398	82	42	2
L-PPFFG-8248-0TT-E	2586	82	48	2
One 8" & Two 16" frosted glass segments on top				
L-PPFFG-8224-0SS-E	1949	82	24	2
L-PPFFG-8230-0SS-E	2243	82	30	2
L-PPFFG-8236-0SS-E	2408	82	36	2
L-PPFFG-8242-0SS-E	2465	82	42	2
L-PPFFG-8248-0SS-E	2669	82	48	2
Three 16" frosted glass segments on top				
L-PPFFG-8224-0SS-E	1984	82	24	2
L-PPFFG-8230-0SS-E	2214	82	30	2
L-PPFFG-8236-0SS-E	2399	82	36	2
L-PPFFG-8242-0SS-E	2582	82	42	2
L-PPFFG-8248-0SS-E	2784	82	48	2

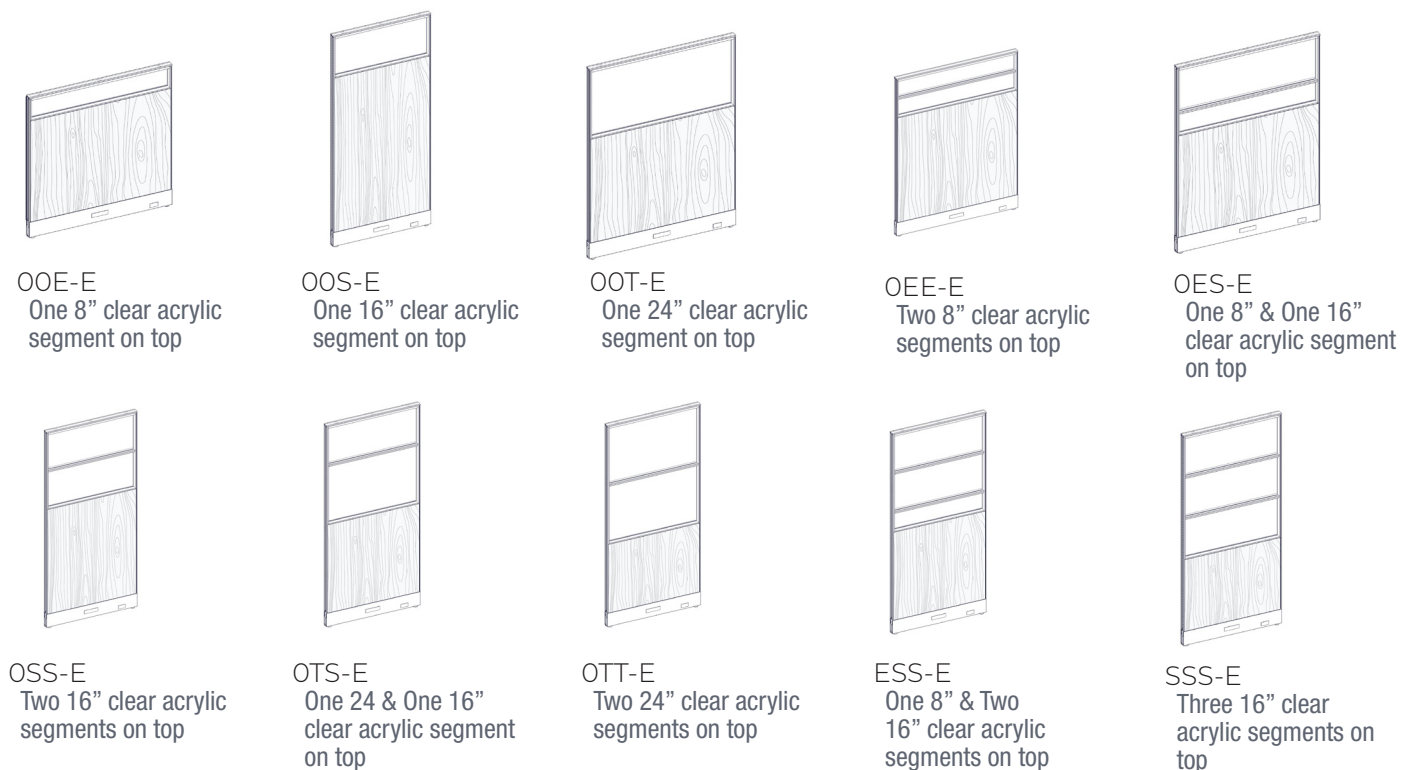

**How to order and read your code**

**L - P P L C A - 42 24 - 00E - E**

product standard P= integrated F=Fabric C=Clear A=Acrylic height width 0= No segment N=Non powered  
 line E = Elevated L=Laminate F=Frosted G=Glass E = 8 inch segment E=Powered  
 S = 16 inch segment  
 T = 24 inch segment

**What's Included:**

One (1) 2" thick laminate panel with 1" incremented slotted channels,  
 Two (2) raceway covers,  
 One (1) top trim

**How to Specify:**

Refer to laminate cards for laminate selections  
 Choose White, Black, Silver, Charcoal for Panel Frame colour

**Options:**

Height\*: 34", 42", 50", 66", 82"  
 Width: 24", 30", 36", 42", 48",  
 Laminate  
 Metal Powder Coat Paint: White, Black, Silver, Charcoal

\*82"H available up to 36"W

Code	Price	H	W	D
One 8" clear acrylic segment on top				
L-PPLCA-4224-00E-E	1139	42	24	2
L-PPLCA-4230-00E-E	1192	42	30	2
L-PPLCA-4236-00E-E	1243	42	36	2
L-PPLCA-4242-00E-E	1350	42	42	2
L-PPLCA-4248-00E-E	1363	42	48	2
L-PPLCA-5024-00E-E	1175	50	24	2
L-PPLCA-5030-00E-E	1092	50	30	2
L-PPLCA-5036-00E-E	1147	50	36	2
L-PPLCA-5042-00E-E	1295	50	42	2
L-PPLCA-5048-00E-E	1326	50	48	2
One 16" clear acrylic segment on top				
L-PPLCA-5024-00S-E	1079	50	24	2
L-PPLCA-5030-00S-E	1114	50	30	2
L-PPLCA-5036-00S-E	1176	50	36	2
L-PPLCA-5042-00S-E	1308	50	42	2
L-PPLCA-5048-00S-E	1346	50	48	2
L-PPLCA-6624-00S-E	1176	66	24	2
L-PPLCA-6630-00S-E	1211	66	30	2
L-PPLCA-6636-00S-E	1287	66	36	2
L-PPLCA-6642-00S-E	1483	66	42	2
L-PPLCA-6648-00S-E	1522	66	48	2
L-PPLCA-8224-00S-E	1508	82	24	2
L-PPLCA-8230-00S-E	1526	82	30	2
L-PPLCA-8236-00S-E	2030	82	36	2
One 24" clear acrylic segment on top				
L-PPLCA-6624-00T-E	1164	66	24	2
L-PPLCA-6630-00T-E	1210	66	30	2
L-PPLCA-6636-00T-E	1284	66	36	2
L-PPLCA-6642-00T-E	1447	66	42	2
L-PPLCA-6648-00T-E	1492	66	48	2

Code	Price	H	W	D
Two 8" clear acrylic segments on top				
L-PPLCA-6624-0EE-E	1319	66	24	2
L-PPLCA-6630-0EE-E	1335	66	30	2
L-PPLCA-6636-0EE-E	1608	66	36	2
L-PPLCA-6642-0EE-E	1645	66	42	2
L-PPLCA-6648-0EE-E	1698	66	48	2
One 8" & One 16" clear acrylic segment on top				
L-PPLCA-6624-0ES-E	1326	66	24	2
L-PPLCA-6630-0ES-E	1379	66	30	2
L-PPLCA-6636-0ES-E	1674	66	36	2
L-PPLCA-6642-0ES-E	1730	66	42	2
L-PPLCA-6648-0ES-E	1788	66	48	2
Two 16" clear acrylic segments on top				
L-PPLCA-8224-0SS-E	1377	82	24	2
L-PPLCA-8230-0SS-E	1444	82	30	2
L-PPLCA-8236-0SS-E	1773	82	36	2
One 24" & One 16" clear acrylic segment on top				
L-PPLCA-8224-0TS-E	1406	82	24	2
L-PPLCA-8230-0TS-E	1497	82	30	2
L-PPLCA-8236-0TS-E	1781	82	36	2
Two 24" clear acrylic segments on top				
L-PPLCA-8224-0TT-E	1345	82	24	2
L-PPLCA-8230-0TT-E	1426	82	30	2
L-PPLCA-8236-0TT-E	1670	82	36	2
One 8" & Two 16" clear acrylic segments on top				
L-PPLCA-8224-ESS-E	1467	82	24	2
L-PPLCA-8230-ESS-E	1626	82	30	2
L-PPLCA-8236-ESS-E	1922	82	36	2
Three 16" clear acrylic segments on top				
L-PPLCA-8224-SSS-E	1438	82	24	2
L-PPLCA-8230-SSS-E	1525	82	30	2
L-PPLCA-8236-SSS-E	1843	82	36	2

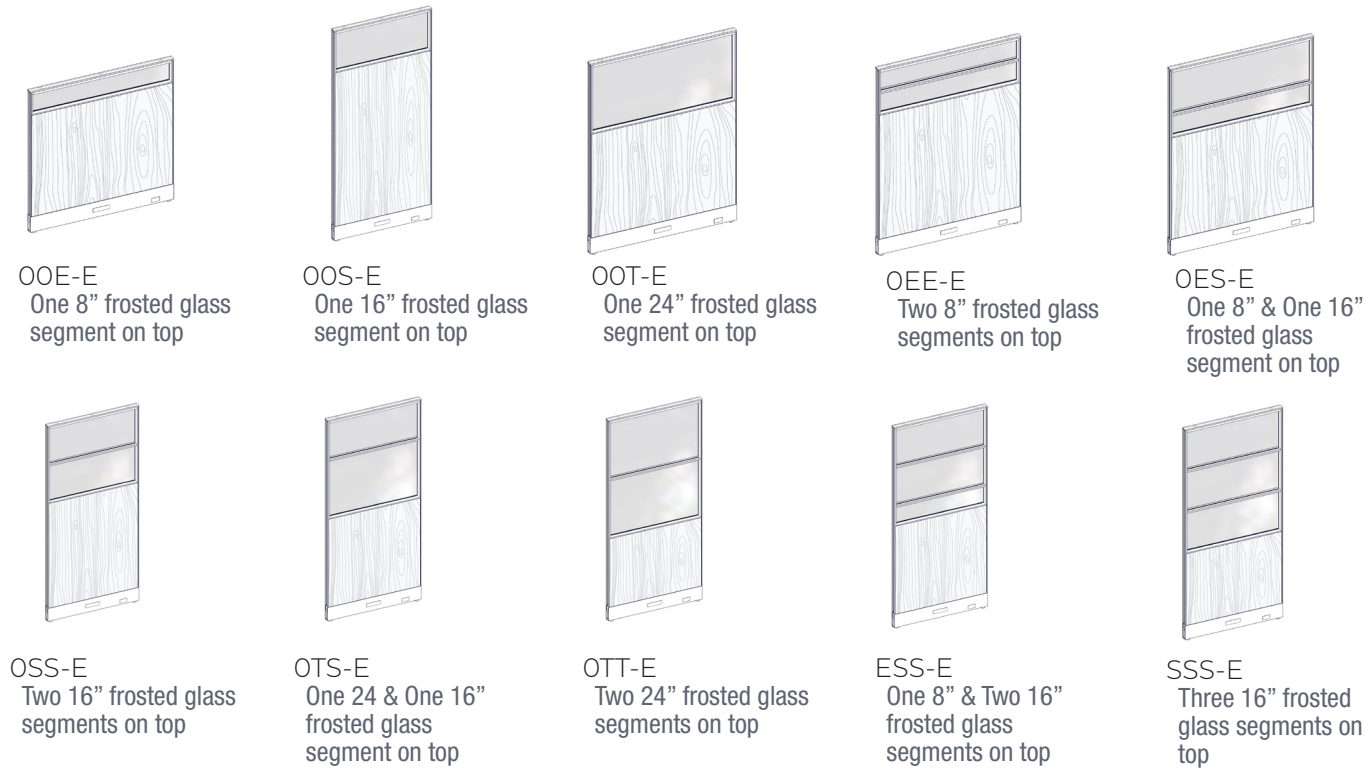

**How to order and read your code**

**L - P P L F A - 42 24 - 00E - E**

product standard P= integrated F=Fabric C= Clear A=Acrylic height width 0 = No segment N=Non powered  
 line E = Elevated L=Laminate F=Frosted G=Glass E = 8 inch segment E=Powered  
 S = 16 inch segment  
 T = 24 inch segment

**What's Included:**

One (1) 2" thick laminate panel with 1" incremented slotted channels,  
 Two (2) raceway covers,  
 One (1) top trim

**How to Specify:**

Refer to laminate cards for laminate selections  
 Choose White, Black, Silver, Charcoal for Panel Frame colour

**Options:**

Height\*: 34", 42", 50", 66", 82"

Width: 24", 30", 36", 42", 48",

Laminate

Metal Powder Coat Paint: White, Black, Silver, Charcoal

\*82"H available up to 36"W

Code	Price	H	W	D
One 8" frosted acrylic segment on top				
L-PPLFA-4224-00E-E	1126	42	24	2
L-PPLFA-4230-00E-E	1156	42	30	2
L-PPLFA-4236-00E-E	1206	42	36	2
L-PPLFA-4242-00E-E	1333	42	42	2
L-PPLFA-4248-00E-E	1363	42	48	2
L-PPLFA-5024-00E-E	1162	50	24	2
L-PPLFA-5030-00E-E	1192	50	30	2
L-PPLFA-5036-00E-E	1246	50	36	2
L-PPLFA-5042-00E-E	1394	50	42	2
L-PPLFA-5048-00E-E	1425	50	48	2
One 16" frosted acrylic segment on top				
L-PPLFA-5024-00S-E	1178	50	24	2
L-PPLFA-5030-00S-E	1213	50	30	2
L-PPLFA-5036-00S-E	1275	50	36	2
L-PPLFA-5042-00S-E	1407	50	42	2
L-PPLFA-5048-00S-E	1447	50	48	2
L-PPLFA-6624-00S-E	1275	66	24	2
L-PPLFA-6630-00S-E	1309	66	30	2
L-PPLFA-6636-00S-E	1387	66	36	2
L-PPLFA-6642-00S-E	1582	66	42	2
L-PPLFA-6648-00S-E	1621	66	48	2
L-PPLFA-8224-00S-E	1543	82	24	2
L-PPLFA-8230-00S-E	1571	82	30	2
L-PPLFA-8236-00S-E	2086	82	36	2
One 24" frosted acrylic segment on top				
L-PPLFA-6624-00T-E	1263	66	24	2
L-PPLFA-6630-00T-E	1308	66	30	2
L-PPLFA-6636-00T-E	1342	66	36	2
L-PPLFA-6642-00T-E	1546	66	42	2
L-PPLFA-6648-00T-E	1592	66	48	2
Two 8" frosted acrylic segments on top				
L-PPLFA-6624-0EE-E	1378	66	24	2
L-PPLFA-6630-0EE-E	1416	66	30	2
L-PPLFA-6636-0EE-E	1714	66	36	2
L-PPLFA-6642-0EE-E	1746	66	42	2
L-PPLFA-6648-0EE-E	1817	66	48	2
One 8" & One 16" frosted acrylic segment on top				
L-PPLFA-6624-0ES-E	1376	66	24	2
L-PPLFA-6630-0ES-E	1447	66	30	2
L-PPLFA-6636-0ES-E	1755	66	36	2
L-PPLFA-6642-0ES-E	1830	66	42	2
L-PPLFA-6648-0ES-E	1888	66	48	2
Two 16" frosted acrylic segments on top				
L-PPLFA-8224-0SS-E	1282	82	24	2
L-PPLFA-8230-0SS-E	1309	82	30	2
L-PPLFA-8236-0SS-E	1593	82	36	2
One 24" & One 16" frosted acrylic segment on top				
L-PPLFA-8224-0TS-E	1507	82	24	2
L-PPLFA-8230-0TS-E	1630	82	30	2
L-PPLFA-8236-0TS-E	1915	82	36	2
Two 24" frosted acrylic segments on top				
L-PPLFA-8224-0TT-E	1447	82	24	2
L-PPLFA-8230-0TT-E	1559	82	30	2
L-PPLFA-8236-0TT-E	1830	82	36	2
One 8" & Two 16" frosted acrylic segments on top				
L-PPLFA-8224-ESS-E	1569	82	24	2
L-PPLFA-8230-ESS-E	1759	82	30	2
L-PPLFA-8236-ESS-E	2054	82	36	2
Three 16" frosted acrylic segments on top				
L-PPLFA-8224-SSS-E	1538	82	24	2
L-PPLFA-8230-SSS-E	1658	82	30	2
L-PPLFA-8236-SSS-E	2044	82	36	2

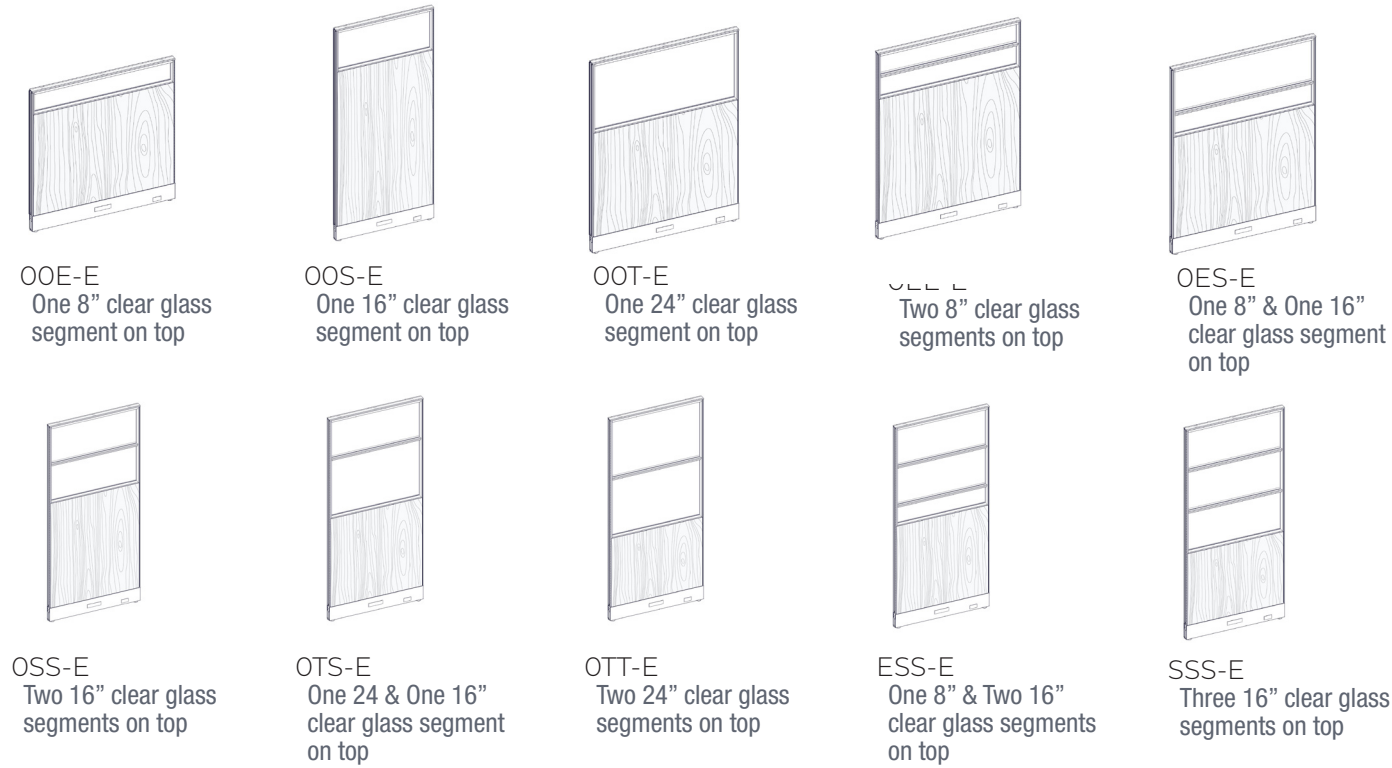

**How to order and read your code**

**L - P P L C G - 42 24 - 00E - E**

product standard P= integrated F=Fabric C=Clear A=Acrylic height width 0= No segment N=Non powered  
 line line E = Elevated L=Laminate F=Frosted G=Glass E = 8 inch segment E=Powered  
 S = 16 inch segment  
 T = 24 inch segment

**What's Included:**

One (1) 2" thick laminate panel with 1" incremented slotted channels,  
 Two (2) raceway covers,  
 One (1) top trim

**How to Specify:**

Refer to laminate cards for laminate selections  
 Choose White, Black, Silver, Charcoal for Panel Frame colour

**Options:**

Height\*: 34", 42", 50", 66", 82"  
 Width: 24", 30", 36", 42", 48",  
 Laminate  
 Metal Powder Coat Paint: White, Black, Silver, Charcoal

\*82"H available up to 36"W

Code	Price	H	W	D
One 8" clear glass segment on top				
L-PPLCG-4224-00E-E	1650	42	24	2
L-PPLCG-4230-00E-E	1296	42	30	2
L-PPLCG-4236-00E-E	1355	42	36	2
L-PPLCG-4242-00E-E	1423	42	42	2
L-PPLCG-4248-00E-E	1491	42	48	2
L-PPLCG-5024-00E-E	1146	50	24	2
L-PPLCG-5030-00E-E	1189	50	30	2
L-PPLCG-5036-00E-E	1261	50	36	2
L-PPLCG-5042-00E-E	1425	50	42	2
L-PPLCG-5048-00E-E	1471	50	48	2
One 16" clear glass segment on top				
L-PPLCG-5024-00S-E	1211	50	24	2
L-PPLCG-5030-00S-E	1275	50	30	2
L-PPLCG-5036-00S-E	1363	50	36	2
L-PPLCG-5042-00S-E	1526	50	42	2
L-PPLCG-5048-00S-E	1590	50	48	2
L-PPLCG-6624-00S-E	1306	66	24	2
L-PPLCG-6630-00S-E	1371	66	30	2
L-PPLCG-6636-00S-E	1475	66	36	2
L-PPLCG-6642-00S-E	1694	66	42	2
L-PPLCG-6648-00S-E	1762	66	48	2
L-PPLCG-8224-00S-E	1469	82	24	2
L-PPLCG-8230-00S-E	1510	82	30	2
L-PPLCG-8236-00S-E	2034	82	36	2
One 24" clear glass segment on top				
L-PPLCG-6624-00T-E	1348	66	24	2
L-PPLCG-6630-00T-E	1430	66	30	2
L-PPLCG-6636-00T-E	1543	66	36	2
L-PPLCG-6642-00T-E	1745	66	42	2
L-PPLCG-6648-00T-E	1830	66	48	2

Code	Price	H	W	D
Two 8" clear glass segments on top				
L-PPLCG-6624-0EE-E	1411	66	24	2
L-PPLCG-6630-0EE-E	1461	66	30	2
L-PPLCG-6636-0EE-E	1759	66	36	2
L-PPLCG-6642-0EE-E	1805	66	42	2
L-PPLCG-6648-0EE-E	1876	66	48	2
One 8" & One 16" clear glass segment on top				
L-PPLCG-6624-0ES-E	1411	66	24	2
L-PPLCG-6630-0ES-E	1480	66	30	2
L-PPLCG-6636-0ES-E	1792	66	36	2
L-PPLCG-6642-0ES-E	1852	66	42	2
L-PPLCG-6648-0ES-E	1937	66	48	2
Two 16" clear glass segments on top				
L-PPLCG-8224-0SS-E	1464	82	24	2
L-PPLCG-8230-0SS-E	1528	82	30	2
L-PPLCG-8236-0SS-E	1855	82	36	2
One 24" & One 16" clear glass segment on top				
L-PPLCG-8224-0TS-E	1492	82	24	2
L-PPLCG-8230-0TS-E	1583	82	30	2
L-PPLCG-8236-0TS-E	1916	82	36	2
Two 24" clear glass segments on top				
L-PPLCG-8224-0TT-E	1464	82	24	2
L-PPLCG-8230-0TT-E	1558	82	30	2
L-PPLCG-8236-0TT-E	1823	82	36	2
One 8" & Two 16" clear glass segments on top				
L-PPLCG-8224-ESS-E	1637	82	24	2
L-PPLCG-8230-ESS-E	1788	82	30	2
L-PPLCG-8236-ESS-E	2132	82	36	2
Three 16" clear glass segments on top				
L-PPLCG-8224-SSS-E	1616	82	24	2
L-PPLCG-8230-SSS-E	1702	82	30	2
L-PPLCG-8236-SSS-E	1989	82	36	2

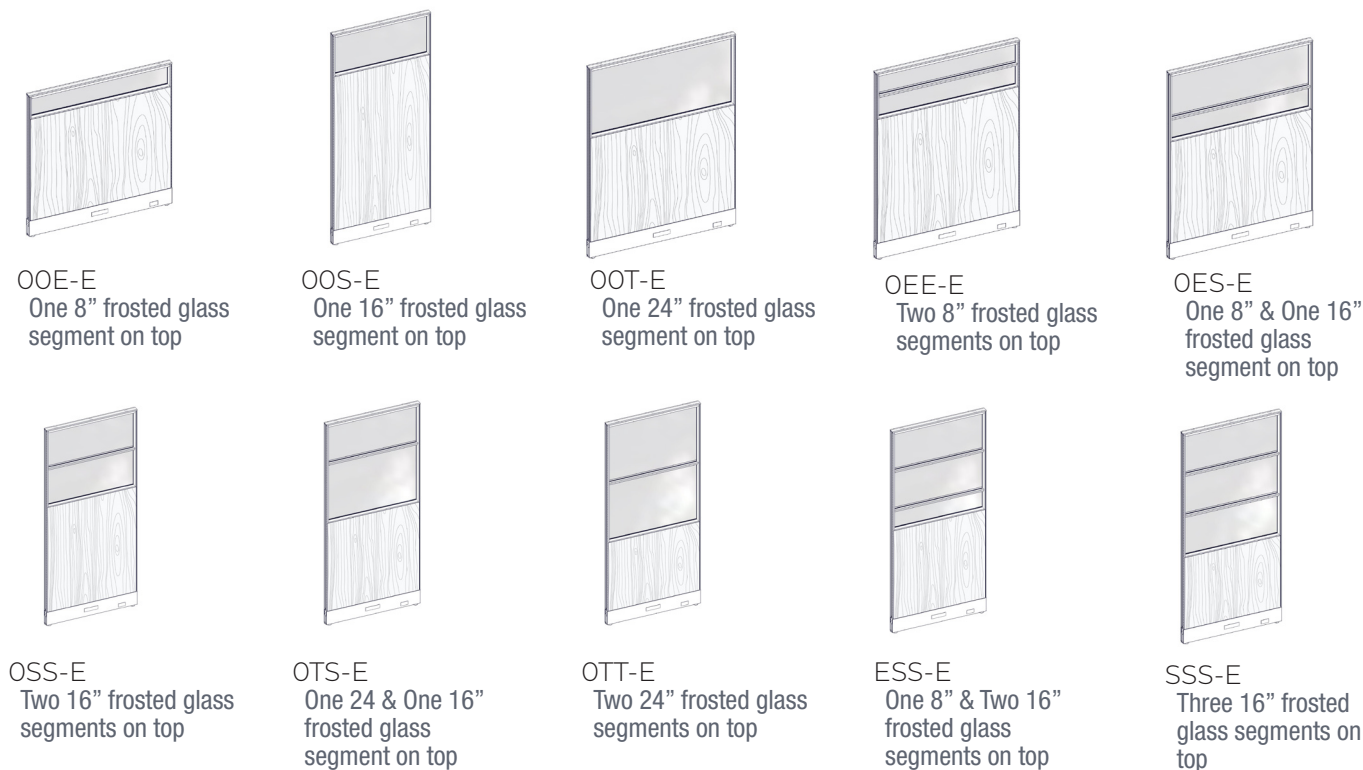

**How to order and read your code**

**L - P P L F G - 42 24 - 00E - E**

product standard P= integrated F=Fabric C=Clear A=Acrylic height width 0= No segment N=Non powered  
 line line E = Elevated L=Laminate F=Frosted G=Glass E = 8 inch segment E=Powered  
 S = 16 inch segment  
 T = 24 inch segment

**What's Included:**

One (1) 2" thick laminate panel with 1" incremented slotted channels,  
 Two (2) raceway covers,  
 One (1) top trim

**How to Specify:**

Refer to laminate cards for laminate selections  
 Choose White, Black, Silver, Charcoal for Panel Frame colour

**Options:**

Height\*: 34", 42", 50", 66", 82"  
 Width: 24", 30", 36", 42", 48",  
 Laminate  
 Metal Powder Coat Paint: White, Black, Silver, Charcoal

\*82"H available up to 36"W

Code	Price	H	W	D
One 8" frosted glass segment on top				
L-PPLFG-4224-00E-E	1548	42	24	2
L-PPLFG-4230-00E-E	1253	42	30	2
L-PPLFG-4236-00E-E	1321	42	36	2
L-PPLFG-4242-00E-E	1465	42	42	2
L-PPLFG-4248-00E-E	1510	42	48	2
L-PPLFG-5024-00E-E	1245	50	24	2
L-PPLFG-5030-00E-E	1287	50	30	2
L-PPLFG-5036-00E-E	1360	50	36	2
L-PPLFG-5042-00E-E	1524	50	42	2
L-PPLFG-5048-00E-E	1570	50	48	2
One 16" frosted glass segment on top				
L-PPLFG-5024-00S-E	1309	50	24	2
L-PPLFG-5030-00S-E	1375	50	30	2
L-PPLFG-5036-00S-E	1462	50	36	2
L-PPLFG-5042-00S-E	1625	50	42	2
L-PPLFG-5048-00S-E	1690	50	48	2
L-PPLFG-6624-00S-E	1405	66	24	2
L-PPLFG-6630-00S-E	1471	66	30	2
L-PPLFG-6636-00S-E	1573	66	36	2
L-PPLFG-6642-00S-E	1793	66	42	2
L-PPLFG-6648-00S-E	1861	66	48	2
L-PPLFG-8224-00S-E	1550	82	24	2
L-PPLFG-8230-00S-E	1601	82	30	2
L-PPLFG-8236-00S-E	2141	82	36	2
One 24" frosted glass segment on top				
L-PPLFG-6624-00T-E	1448	66	24	2
L-PPLFG-6630-00T-E	1529	66	30	2
L-PPLFG-6636-00T-E	1642	66	36	2
L-PPLFG-6642-00T-E	1844	66	42	2
L-PPLFG-6648-00T-E	1931	66	48	2
Two 8" frosted glass segments on top				
L-PPLFG-6624-0EE-E	1574	66	24	2
L-PPLFG-6630-0EE-E	1624	66	30	2
L-PPLFG-6636-0EE-E	1922	66	36	2
L-PPLFG-6642-0EE-E	1969	66	42	2
L-PPLFG-6648-0EE-E	2036	66	48	2
One 8" & One 16" frosted glass segment on top				
L-PPLFG-6624-0ES-E	1574	66	24	2
L-PPLFG-6630-0ES-E	1649	66	30	2
L-PPLFG-6636-0ES-E	1982	66	36	2
L-PPLFG-6642-0ES-E	2060	66	42	2
L-PPLFG-6648-0ES-E	2164	66	48	2
Two 16" frosted glass segments on top				
L-PPLFG-8224-0SS-E	1626	82	24	2
L-PPLFG-8230-0SS-E	1707	82	30	2
L-PPLFG-8236-0SS-E	2072	82	36	2
One 24" & One 16" frosted glass segment on top				
L-PPLFG-8224-0TS-E	1682	82	24	2
L-PPLFG-8230-0TS-E	1806	82	30	2
L-PPLFG-8236-0TS-E	2188	82	36	2
Two 24" frosted glass segments on top				
L-PPLFG-8224-0TT-E	1681	82	24	2
L-PPLFG-8230-0TT-E	1827	82	30	2
L-PPLFG-8236-0TT-E	2146	82	36	2
One 8" & Two 16" frosted glass segments on top				
L-PPLFG-8224-ESS-E	1882	82	24	2
L-PPLFG-8230-ESS-E	2048	82	30	2
L-PPLFG-8236-ESS-E	2430	82	36	2
Three 16" frosted glass segments on top				
L-PPLFG-8224-SSS-E	1858	82	24	2
L-PPLFG-8230-SSS-E	1972	82	30	2
L-PPLFG-8236-SSS-E	2314	82	36	2



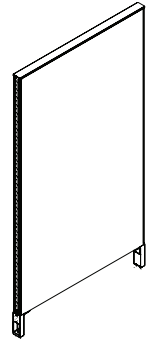

Elevated Non-Powered Fabric Panel

**What's Included:**

One (1) 2" thick fabric panel with 1" incremented slotted channels, One (1) top trim

**How to Specify:**

Refer to panel fabric cards for fabric selections

Choose White, Black, Silver, Charcoal for Panel Frame colour

**Notes:**

Non-power capable panel.

Can be used in run with power-capable panels and allows wires to pass through.

Panels are non tackable. For tackable option see Panel Add-On section.

Fabric Upcharge  
Grade 2 - \$204 per panel,  
Grade 3 - \$251 per panel

**Options:**

Height\*: 34", 42", 50", 66", 82"

Width: 24", 30", 36", 42", 48", 54", 60", 66", 72"

Fabric

Metal Powder Coat Paint: White, Black, Silver, Charcoal

\*34" high - 50" high available up to 72" wide, 66" high available up to 60" wide, 82" high available up to 48" wide

Code	Price	H	W	D	Weight (lb.)	Volume (ft <sup>3</sup> )
L-PEF0-3424	389	34	24	2	14.8	0.94
L-PEF0-3430	420	34	30	2	18.5	1.18
L-PEF0-3436	451	34	36	2	22.3	1.42
L-PEF0-3442	483	34	42	2	26.0	1.65
L-PEF0-3448	512	34	48	2	29.7	1.89
L-PEF0-3454	543	34	54	2	33.4	2.13
L-PEF0-3460	573	34	60	2	37.1	2.36
L-PEF0-4224	389	42	24	2	18.3	1.17
L-PEF0-4230	420	42	30	2	22.9	1.46
L-PEF0-4236	451	42	36	2	27.5	1.75
L-PEF0-4242	483	42	42	2	32.1	2.04
L-PEF0-4248	512	42	48	2	36.7	2.33
L-PEF0-4254	543	42	54	2	41.2	2.63
L-PEF0-4260	573	42	60	2	45.8	2.92
L-PEF0-5024	420	50	24	2	21.8	1.39
L-PEF0-5030	466	50	30	2	27.3	1.74
L-PEF0-5036	512	50	36	2	32.7	2.08
L-PEF0-5042	558	50	42	2	38.2	2.43
L-PEF0-5048	605	50	48	2	43.6	2.78
L-PEF0-5054	651	50	54	2	49.1	3.13
L-PEF0-5060	694	50	60	2	54.5	3.47
L-PEF0-6624	483	66	24	2	28.8	1.83
L-PEF0-6630	536	66	30	2	36.0	2.29
L-PEF0-6636	583	66	36	2	43.2	2.75
L-PEF0-6642	628	66	42	2	50.4	3.21
L-PEF0-6648	674	66	48	2	57.6	3.67
L-PEF0-6654	735	66	54	2	64.8	4.13
L-PEF0-6660	795	66	60	2	72.0	4.58
L-PEF0-8224	914	82	24	2		
L-PEF0-8230	980	82	30	2		
L-PEF0-8236	1186	82	36	2		
L-PEF0-8242	1249	82	42	2		
L-PEF0-8248	1313	82	48	2		

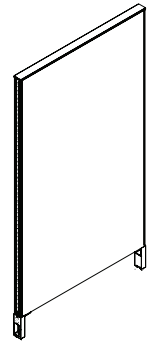

Elevated Monolithic  
Non-powered  
Laminate Panel

**What's Included:**

One (1) 2" thick laminate panel with  
1" incremented slotted channels,  
One (1) top trim

**How to Specify:**

Refer to laminate cards for laminate selections  
Choose White, Black, Silver, Charcoal for Panel  
Frame colour

**Notes:**

Non-power capable panel.  
Can be used in run with power-capable  
panels and allows wires to pass through.  
Panels are non tackable. For tackable  
option see Panel Add-On section.

**Options:**

Height\*: 34", 42", 50", 66", 82"

Width: 24", 30", 36", 42", 48",

Laminate

Metal Powder Coat Paint: White, Black, Silver, Charcoal

\*82"H available up to 36"W

Code	Price	H	W	D	Weight (lb.)	Volume (ft <sup>3</sup> )
L-PELO-3424	492	34	24	2	14.8	0.94
L-PELO-3430	537	34	30	2	18.5	1.18
L-PELO-3436	613	34	36	2	22.3	1.42
L-PELO-3442	658	34	42	2	26.0	1.65
L-PELO-3448	722	34	48	2	29.7	1.89
L-PELO-4224	537	42	24	2	18.3	1.17
L-PELO-4230	584	42	30	2	22.9	1.46
L-PELO-4236	658	42	36	2	27.5	1.75
L-PELO-4242	705	42	42	2	32.1	2.04
L-PELO-4248	766	42	48	2	36.7	2.33
L-PELO-5024	584	50	24	2	21.8	1.39
L-PELO-5030	630	50	30	2	27.3	1.74
L-PELO-5036	722	50	36	2	32.7	2.08
L-PELO-5042	766	50	42	2	38.2	2.43
L-PELO-5048	829	50	48	2	43.6	2.78
L-PELO-6624	722	66	24	2	28.8	1.83
L-PELO-6630	766	66	30	2	36.0	2.29
L-PELO-6636	905	66	36	2	43.2	2.75
L-PELO-6642	952	66	42	2	50.4	3.21
L-PELO-6648	1012	66	48	2	57.6	3.67
L-PELO-8224	971	82	24	2		
L-PELO-8230	977	82	30	2		
L-PELO-8236	1297	82	36	2		

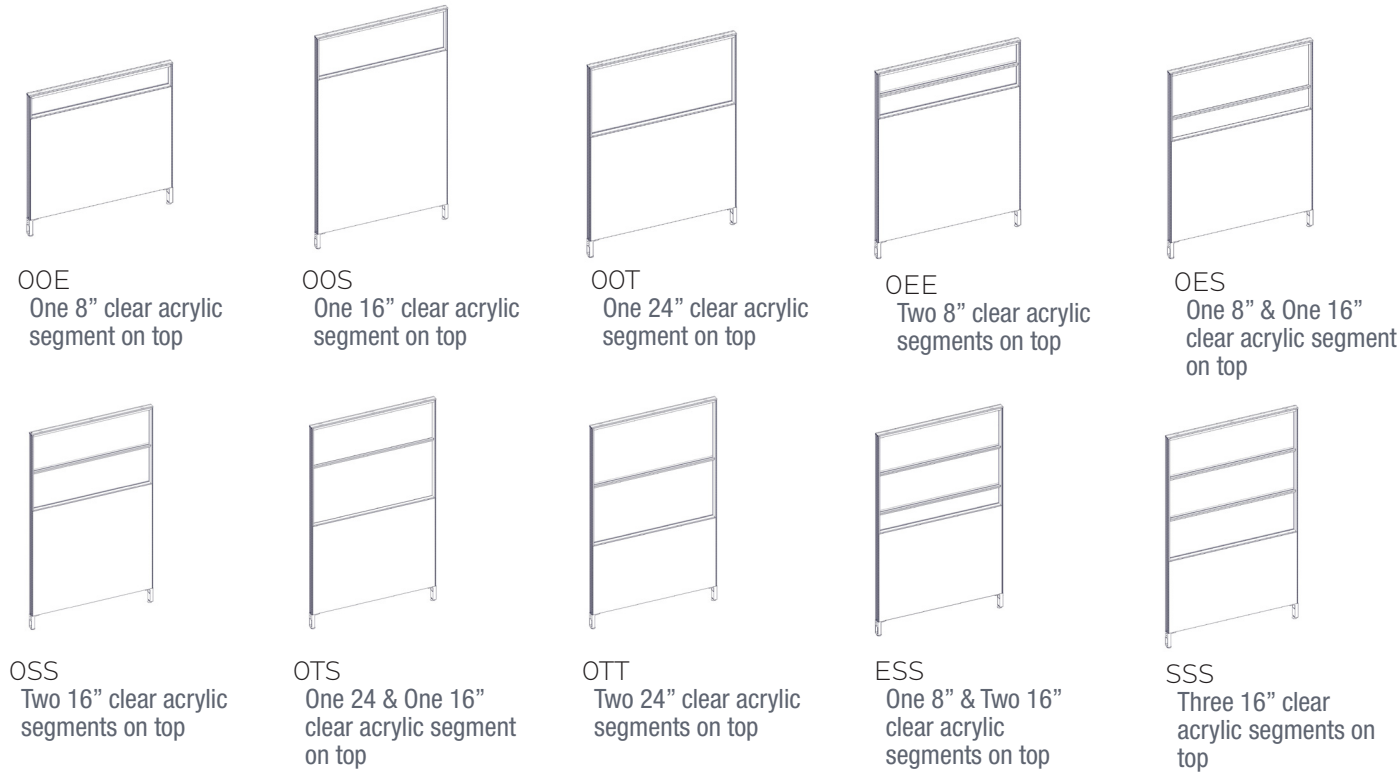

**How to order and read your code**

**L - P E F C A - 42 24 - 0 0 E**

product standard line P= integrated E = Elevated F=Fabric L=Laminate C=Clear F=Frosted A=Acrylic height G=Glass width 0 = No segment E = 8 inch segment S = 16 inch segment T = 24 inch segment

**What's Included:**

One (1) 2" thick fabric panel with integrated glass top and laminate bottom, also with 1" incremented slotted channels, One (1) top trim

**How to Specify:**

Refer to panel fabric cards for fabric selections  
Choose White, Black, Silver, Charcoal for Panel Frame colour

**Options:**

Height*	34", 42", 50", 66", 82"
Width:	24", 30", 36", 42", 48", 54", 60", 66", 72"
Fabric	
Glass/Acrylic	
Metal Powder Coat Paint:	White, Black, Silver, Charcoal

\*34" high - 50" high available up to 72" wide, 66" high available up to 60" wide, 82" high available up to 48" wide

Code	Price	H	W	D
One 8" clear acrylic segment on top				
L-PEFCA-4224-00E	757	42	24	2
L-PEFCA-4230-00E	835	42	30	2
L-PEFCA-4236-00E	914	42	36	2
L-PEFCA-4242-00E	991	42	42	2
L-PEFCA-4248-00E	1071	42	48	2
L-PEFCA-4254-00E	1147	42	54	2
L-PEFCA-4260-00E	1224	42	60	2
L-PEFCA-5024-00E	757	50	24	2
L-PEFCA-5030-00E	835	50	30	2
L-PEFCA-5036-00E	914	50	36	2
L-PEFCA-5042-00E	991	50	42	2
L-PEFCA-5048-00E	1071	50	48	2
L-PEFCA-5054-00E	1147	50	54	2
L-PEFCA-5060-00E	1224	50	60	2
One 16" clear acrylic segment on top				
L-PEFCA-5024-00S	757	50	24	2
L-PEFCA-5030-00S	835	50	30	2
L-PEFCA-5036-00S	914	50	36	2
L-PEFCA-5042-00S	991	50	42	2
L-PEFCA-5048-00S	1071	50	48	2
L-PEFCA-5054-00S	1147	50	54	2
L-PEFCA-5060-00S	1224	50	60	2
L-PEFCA-6624-00S	881	66	24	2
L-PEFCA-6630-00S	980	66	30	2
L-PEFCA-6636-00S	1077	66	36	2
L-PEFCA-6642-00S	1175	66	42	2
L-PEFCA-6648-00S	1274	66	48	2
L-PEFCA-6654-00S	1371	66	54	2
L-PEFCA-6660-00S	1469	66	60	2
L-PEFCA-8224-00S	1426	82	24	2
L-PEFCA-8230-00S	1645	82	30	2
L-PEFCA-8236-00S	1722	82	36	2
L-PEFCA-8242-00S	1753	82	42	2
L-PEFCA-8248-00S	1825	82	48	2
One 24" clear acrylic segment on top				
L-PEFCA-6624-00T	881	66	24	2
L-PEFCA-6630-00T	980	66	30	2
L-PEFCA-6636-00T	1077	66	36	2
L-PEFCA-6642-00T	1175	66	42	2
L-PEFCA-6648-00T	1274	66	48	2
L-PEFCA-6654-00T	1371	66	54	2
L-PEFCA-6660-00T	1469	66	60	2

Code	Price	H	W	D
Two 8" clear acrylic segments on top				
L-PEFCA-6624-0EE	1406	66	24	2
L-PEFCA-6630-0EE	1585	66	30	2
L-PEFCA-6636-0EE	1643	66	36	2
L-PEFCA-6642-0EE	1690	66	42	2
L-PEFCA-6648-0EE	1753	66	48	2
L-PEFCA-6654-0EE	1858	66	54	2
L-PEFCA-6660-0EE	1901	66	60	2
One 8" & One 16" clear acrylic segment on top				
L-PEFCA-6624-0ES	1375	66	24	2
L-PEFCA-6630-0ES	1546	66	30	2
L-PEFCA-6636-0ES	1616	66	36	2
L-PEFCA-6642-0ES	1685	66	42	2
L-PEFCA-6648-0ES	1759	66	48	2
L-PEFCA-6654-0ES	1836	66	54	2
L-PEFCA-6660-0ES	1868	66	60	2
Two 16" clear acrylic segments on top				
L-PEFCA-8224-0SS	1464	82	24	2
L-PEFCA-8230-0SS	1694	82	30	2
L-PEFCA-8236-0SS	1806	82	36	2
L-PEFCA-8242-0SS	1851	82	42	2
L-PEFCA-8248-0SS	1916	82	48	2
One 24" & One 16" clear acrylic segment on top				
L-PEFCA-8224-0TS	1455	82	24	2
L-PEFCA-8230-0TS	1664	82	30	2
L-PEFCA-8236-0TS	1722	82	36	2
L-PEFCA-8242-0TS	1766	82	42	2
L-PEFCA-8248-0TS	1937	82	48	2
Two 24" clear acrylic segments on top				
L-PEFCA-8224-0TT	1453	82	24	2
L-PEFCA-8230-0TT	1638	82	30	2
L-PEFCA-8236-0TT	1718	82	36	2
L-PEFCA-8242-0TT	1822	82	42	2
L-PEFCA-8248-0TT	1885	82	48	2
One 8" & Two 16" clear acrylic segments on top				
L-PEFCA-8224-ESS	1517	82	24	2
L-PEFCA-8230-ESS	1792	82	30	2
L-PEFCA-8236-ESS	1861	82	36	2
L-PEFCA-8242-ESS	1854	82	42	2
L-PEFCA-8248-ESS	2025	82	48	2
Three 16" clear acrylic segments on top				
L-PEFCA-8224-SSS	1543	82	24	2
L-PEFCA-8230-SSS	1737	82	30	2
L-PEFCA-8236-SSS	1890	82	36	2
L-PEFCA-8242-SSS	1944	82	42	2
L-PEFCA-8248-SSS	2019	82	48	2

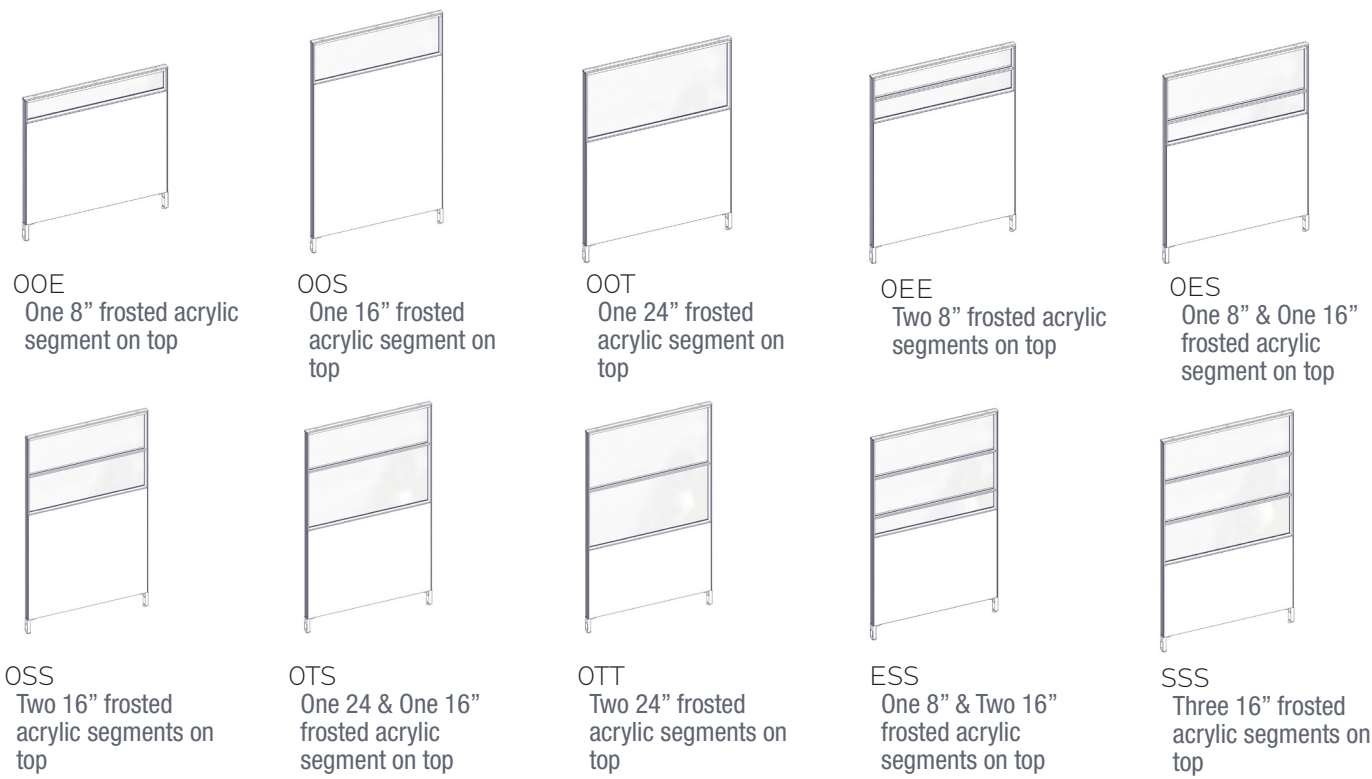

How to order and read your code

**L - P E F F A - 42 24 - 0 0 E**

product standard line P= integrated E = Elevated F=Fabric L=Laminate C=Clear F=Frosted A=Acrylic height G=Glass width 0 = No segment E = 8 inch segment S = 16 inch segment T = 24 inch segment

What's Included:

One (1) 2" thick fabric panel with integrated glass top and laminate bottom, also with 1" incremented slotted channels, One (1) top trim

How to Specify:

Refer to panel fabric cards for fabric selections  
Choose White, Black, Silver, Charcoal for Panel Frame colour

Options:

Height*:	34", 42", 50", 66", 82"
Width:	24", 30", 36", 42", 48", 54", 60", 66" 72"
Fabric	
Glass/Acrylic	
Metal Powder Coat Paint:	White, Black, Silver, Charcoal

\*34" high - 50" high available up to 72" wide, 66" high available up to 60" wide, 82" high available up to 48" wide

Code	Price	H	W	D
One 8" frosted acrylic segment on top				
L-PEFFA-4224-00E	856	42	24	2
L-PEFFA-4230-00E	934	42	30	2
L-PEFFA-4236-00E	1013	42	36	2
L-PEFFA-4242-00E	1090	42	42	2
L-PEFFA-4248-00E	1170	42	48	2
L-PEFFA-4254-00E	1246	42	54	2
L-PEFFA-4260-00E	1323	42	60	2
L-PEFFA-5024-00E	856	50	24	2
L-PEFFA-5030-00E	934	50	30	2
L-PEFFA-5036-00E	1013	50	36	2
L-PEFFA-5042-00E	1090	50	42	2
L-PEFFA-5048-00E	1170	50	48	2
L-PEFFA-5054-00E	1246	50	54	2
L-PEFFA-5060-00E	1323	50	60	2
One 16" frosted acrylic segment on top				
L-PEFFA-5024-00S	856	50	24	2
L-PEFFA-5030-00S	934	50	30	2
L-PEFFA-5036-00S	1013	50	36	2
L-PEFFA-5042-00S	1090	50	42	2
L-PEFFA-5048-00S	1170	50	48	2
L-PEFFA-5054-00S	1246	50	54	2
L-PEFFA-5060-00S	1323	50	60	2
L-PEFFA-6624-00S	980	66	24	2
L-PEFFA-6630-00S	1079	66	30	2
L-PEFFA-6636-00S	1176	66	36	2
L-PEFFA-6642-00S	1274	66	42	2
L-PEFFA-6648-00S	1374	66	48	2
L-PEFFA-6654-00S	1471	66	54	2
L-PEFFA-6660-00S	1569	66	60	2
L-PEFFA-8224-00S	1460	82	24	2
L-PEFFA-8230-00S	1690	82	30	2
L-PEFFA-8236-00S	1778	82	36	2
L-PEFFA-8242-00S	1822	82	42	2
L-PEFFA-8248-00S	1891	82	48	2
One 24" frosted acrylic segment on top				
L-PEFFA-6624-00T	980	66	24	2
L-PEFFA-6630-00T	1079	66	30	2
L-PEFFA-6636-00T	1176	66	36	2
L-PEFFA-6642-00T	1274	66	42	2
L-PEFFA-6648-00T	1374	66	48	2
L-PEFFA-6654-00T	1471	66	54	2
L-PEFFA-6660-00T	1569	66	60	2

Code	Price	H	W	D
Two 8" frosted acrylic segments on top				
L-PEFFA-6624-0EE	1466	66	24	2
L-PEFFA-6630-0EE	1665	66	30	2
L-PEFFA-6636-0EE	1747	66	36	2
L-PEFFA-6642-0EE	1791	66	42	2
L-PEFFA-6648-0EE	1873	66	48	2
L-PEFFA-6654-0EE	1944	66	54	2
L-PEFFA-6660-0EE	1984	66	60	2
One 8" & One 16" frosted acrylic segment on top				
L-PEFFA-6624-0ES	1425	66	24	2
L-PEFFA-6630-0ES	1613	66	30	2
L-PEFFA-6636-0ES	1695	66	36	2
L-PEFFA-6642-0ES	1786	66	42	2
L-PEFFA-6648-0ES	1861	66	48	2
L-PEFFA-6654-0ES	1947	66	54	2
L-PEFFA-6660-0ES	1998	66	60	2
Two 16" frosted acrylic segments on top				
L-PEFFA-8224-0SS	1370	82	24	2
L-PEFFA-8230-0SS	1560	82	30	2
L-PEFFA-8236-0SS	1628	82	36	2
L-PEFFA-8242-0SS	1679	82	48	2
L-PEFFA-8248-0SS	1734	82	48	2
One 24" & One 16" frosted acrylic segment on top				
L-PEFFA-8224-0TS	1557	82	24	2
L-PEFFA-8230-0TS	1795	82	30	2
L-PEFFA-8236-0TS	1854	82	36	2
L-PEFFA-8242-0TS	1933	82	42	2
L-PEFFA-8248-0TS	2138	82	48	2
Two 24" frosted acrylic segments on top				
L-PEFFA-8224-0TT	1552	82	24	2
L-PEFFA-8230-0TT	1773	82	30	2
L-PEFFA-8236-0TT	1878	82	36	2
L-PEFFA-8242-0TT	2021	82	42	2
L-PEFFA-8248-0TT	2086	82	48	2
One 8" & Two 16" frosted acrylic segments on top				
L-PEFFA-8224-ESS	1618	82	24	2
L-PEFFA-8230-ESS	1926	82	30	2
L-PEFFA-8236-ESS	1994	82	36	2
L-PEFFA-8242-ESS	2048	82	42	2
L-PEFFA-8248-ESS	2156	82	48	2
Three 16" frosted acrylic segments on top				
L-PEFFA-8224-SSS	1643	82	24	2
L-PEFFA-8230-SSS	1871	82	30	2
L-PEFFA-8236-SSS	2091	82	36	2
L-PEFFA-8242-SSS	2143	82	36	2
L-PEFFA-8248-SSS	2219	82	48	2

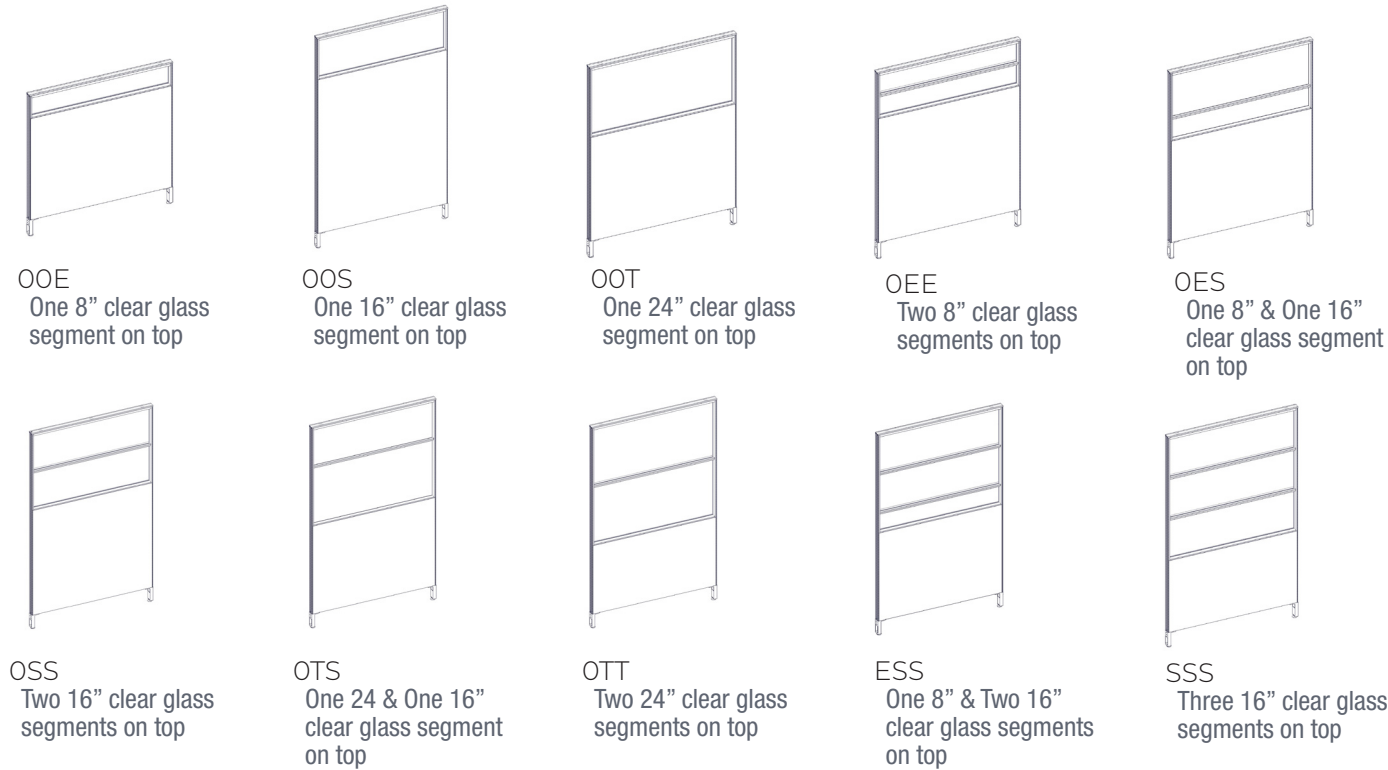

How to order and read your code

**L - P E F C G - 42 24 - 0 0 E**

product standard line P= Integrated E = Elevated F= Fabric L=Laminate C= Clear F= Frosted A= Acrylic G= Glass height width 0 = No segment E = 8 inch segment S = 16 inch segment T = 24 inch segment

What's Included:

One (1) 2" thick fabric panel with integrated glass top and laminate bottom, also with 1" incremented slotted channels, One (1) top trim

How to Specify:

Refer to panel fabric cards for fabric selections  
Choose White, Black, Silver, Charcoal for Panel Frame colour

Options:

Height*:	34", 42", 50", 66", 82"
Width:	24", 30", 36", 42", 48", 54", 60", 66", 72"
Fabric	
Glass/Acrylic	
Metal Powder Coat Paint:	White, Black, Silver, Charcoal

\*34" high - 50" high available up to 72" wide, 66" high available up to 60" wide, 82" high available up to 48" wide

Code	Price	H	W	D
One 8" clear glass segment on top				
L-PEFCG-4224-00E	890	42	24	2
L-PEFCG-4230-00E	968	42	30	2
L-PEFCG-4236-00E	1048	42	36	2
L-PEFCG-4242-00E	1124	42	42	2
L-PEFCG-4248-00E	1201	42	48	2
L-PEFCG-4254-00E	1280	42	54	2
L-PEFCG-4260-00E	1356	42	60	2
L-PEFCG-5024-00E	890	50	24	2
L-PEFCG-5030-00E	968	50	30	2
L-PEFCG-5036-00E	1048	50	36	2
L-PEFCG-5042-00E	1124	50	42	2
L-PEFCG-5048-00E	1201	50	48	2
L-PEFCG-5054-00E	1280	50	54	2
L-PEFCG-5060-00E	1356	50	60	2
One 16" clear glass segment on top				
L-PEFCG-5024-00S	890	50	24	2
L-PEFCG-5030-00S	968	50	30	2
L-PEFCG-5036-00S	1048	50	36	2
L-PEFCG-5042-00S	1124	50	42	2
L-PEFCG-5048-00S	1201	50	48	2
L-PEFCG-5054-00S	1280	50	54	2
L-PEFCG-5060-00S	1356	50	60	2
One 24" clear glass segment on top				
L-PEFCG-6624-00T	1023	66	24	2
L-PEFCG-6630-00T	1122	66	30	2
L-PEFCG-6636-00T	1220	66	36	2
L-PEFCG-6642-00T	1320	66	42	2
L-PEFCG-6648-00T	1418	66	48	2
L-PEFCG-6654-00T	1517	66	54	2
L-PEFCG-6660-00T	1614	66	60	2

Code	Price	H	W	D
Two 8" clear glass segments on top				
L-PEFCG-6624-0EE	1499	66	24	2
L-PEFCG-6630-0EE	1709	66	30	2
L-PEFCG-6636-0EE	1793	66	36	2
L-PEFCG-6642-0EE	1850	66	42	2
L-PEFCG-6648-0EE	1931	66	48	2
L-PEFCG-6654-0EE	2035	66	54	2
L-PEFCG-6660-0EE	2088	66	60	2
One 8" & One 16" clear glass segment on top				
L-PEFCG-6624-0ES	1461	66	24	2
L-PEFCG-6630-0ES	1646	66	30	2
L-PEFCG-6636-0ES	1731	66	36	2
L-PEFCG-6642-0ES	1807	66	42	2
L-PEFCG-6648-0ES	1911	66	48	2
L-PEFCG-6654-0ES	2024	66	54	2
L-PEFCG-6660-0ES	2081	66	60	2
Two 16" clear glass segments on top				
L-PEFCG-8224-0SS	1551	82	24	2
L-PEFCG-8230-0SS	1778	82	30	2
L-PEFCG-8236-0SS	1890	82	36	2
L-PEFCG-8242-0SS	1977	82	42	2
L-PEFCG-8248-0SS	2086	82	48	2
One 24" & One 16" clear glass segment on top				
L-PEFCG-8224-0TS	1541	82	24	2
L-PEFCG-8230-0TS	1749	82	30	2
L-PEFCG-8236-0TS	1856	82	36	2
L-PEFCG-8242-0TS	1956	82	42	2
L-PEFCG-8248-0TS	2079	82	48	2
Two 24" clear glass segments on top				
L-PEFCG-8224-0TT	1570	82	24	2
L-PEFCG-8230-0TT	1770	82	30	2
L-PEFCG-8236-0TT	1870	82	36	2
L-PEFCG-8242-0TT	1972	82	42	2
L-PEFCG-8248-0TT	2094	82	48	2
One 8" & Two 16" clear glass segments on top				
L-PEFCG-8224-ESS	1686	82	24	2
L-PEFCG-8230-ESS	1953	82	30	2
L-PEFCG-8236-ESS	2071	82	36	2
L-PEFCG-8242-ESS	2083	82	42	2
L-PEFCG-8248-ESS	2240	82	48	2
Three 16" clear glass segments on top				
L-PEFCG-8224-SSS	1722	82	24	2
L-PEFCG-8230-SSS	1915	82	30	2
L-PEFCG-8236-SSS	2037	82	36	2
L-PEFCG-8242-SSS	2155	82	42	2
L-PEFCG-8248-SSS	2295	82	48	2

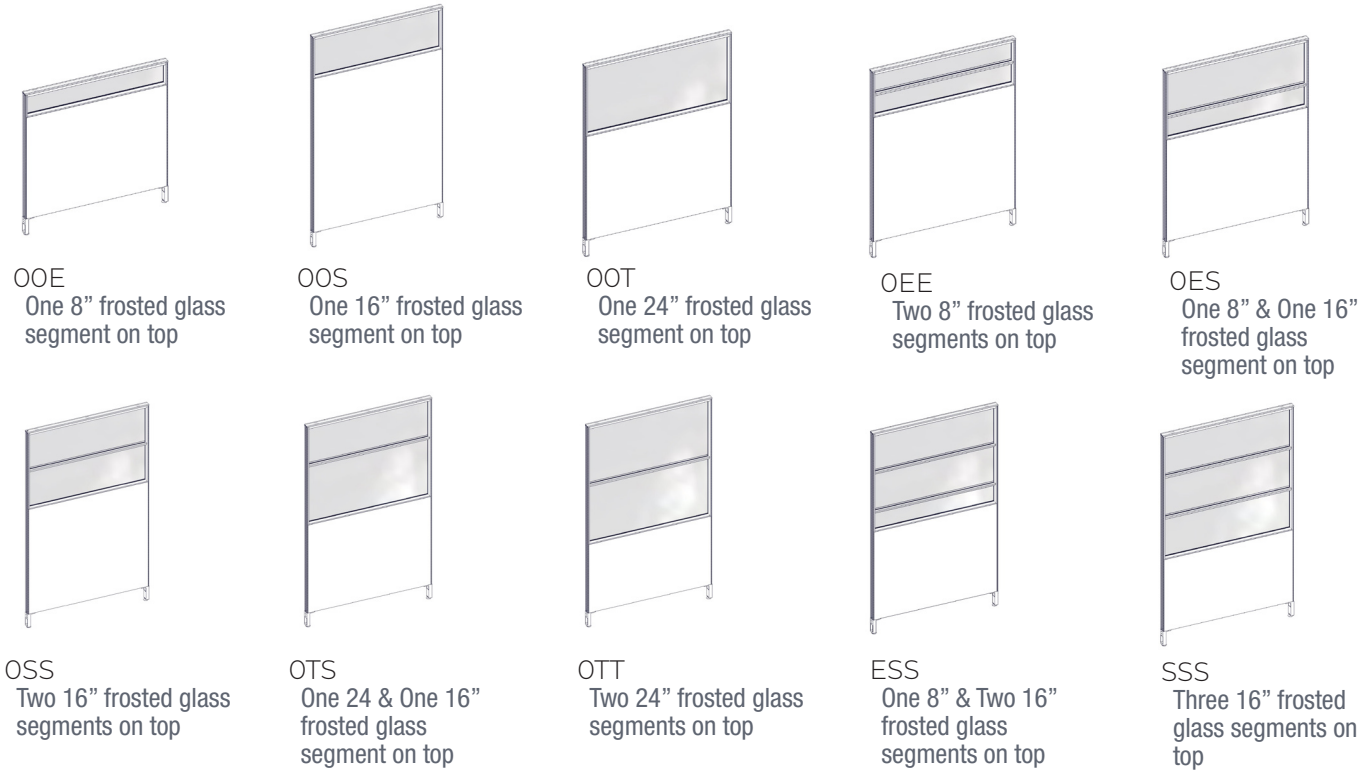

**How to order and read your code**

**L - P E F F G - 42 24 - 00E**

product standard line P= integrated E = Elevated F=Fabric L=Laminate C=Clear F=Frosted A=Acrylic G=Glass height width O = No segment E = 8 inch segment S = 16 inch segment T = 24 inch segment

**What's Included:**

One (1) 2" thick fabric panel with integrated glass top and laminate bottom, also with 1" incremented slotted channels, One (1) top trim

**How to Specify:**

Refer to panel fabric cards for fabric selections  
Choose White, Black, Silver, Charcoal for Panel Frame colour

**Options:**

Height*	34", 42", 50", 66", 82"
Width:	24", 30", 36", 42", 48", 54", 60", 66", 72"
Fabric	
Glass/Acrylic	
Metal Powder Coat Paint:	White, Black, Silver, Charcoal

\*34" high - 50" high available up to 72" wide, 66" high available up to 60" wide, 82" high available up to 48" wide

Code	Price	H	W	D
<b>One 8" frosted glass segment on top</b>				
L-PEFFG-4224-00E	989	42	24	2
L-PEFFG-4230-00E	1065	42	30	2
L-PEFFG-4236-00E	1146	42	36	2
L-PEFFG-4242-00E	1223	42	42	2
L-PEFFG-4248-00E	1301	42	48	2
L-PEFFG-4254-00E	1379	42	54	2
L-PEFFG-4260-00E	1455	42	60	2
<b>One 16" frosted glass segment on top</b>				
L-PEFFG-5024-00E	989	50	24	2
L-PEFFG-5030-00E	1065	50	30	2
L-PEFFG-5036-00E	1146	50	36	2
L-PEFFG-5042-00E	1223	50	42	2
L-PEFFG-5048-00E	1301	50	48	2
L-PEFFG-5054-00E	1379	50	54	2
L-PEFFG-5060-00E	1455	50	60	2
<b>One 8" &amp; One 16" frosted glass segment on top</b>				
L-PEFFG-6624-00E	1662	66	24	2
L-PEFFG-6630-00E	1873	66	30	2
L-PEFFG-6636-00E	1955	66	36	2
L-PEFFG-6642-00E	2013	66	42	2
L-PEFFG-6648-00E	2092	66	48	2
L-PEFFG-6654-00E	2198	66	54	2
L-PEFFG-6660-00E	2267	66	60	2
<b>One 8" &amp; Two 16" frosted glass segments on top</b>				
L-PEFFG-8224-00E	1715	82	24	2
L-PEFFG-8230-00E	1957	82	30	2
L-PEFFG-8236-00E	2107	82	36	2
L-PEFFG-8242-00E	2230	82	42	2
L-PEFFG-8248-00E	2374	82	48	2
<b>One 24" &amp; One 16" frosted glass segment on top</b>				
L-PEFFG-8224-00S	1730	82	24	2
L-PEFFG-8230-00S	1973	82	30	2
L-PEFFG-8236-00S	2129	82	36	2
L-PEFFG-8242-00S	2273	82	42	2
L-PEFFG-8248-00S	2440	82	48	2
<b>Two 16" frosted glass segments on top</b>				
L-PEFFG-6624-00S	1122	66	24	2
L-PEFFG-6630-00S	1221	66	30	2
L-PEFFG-6636-00S	1319	66	36	2
L-PEFFG-6642-00S	1419	66	42	2
L-PEFFG-6648-00S	1517	66	48	2
L-PEFFG-6654-00S	1616	66	54	2
L-PEFFG-6660-00S	1714	66	60	2
<b>Two 24" frosted glass segments on top</b>				
L-PEFFG-8224-00T	1786	82	24	2
L-PEFFG-8230-00T	2041	82	30	2
L-PEFFG-8236-00T	2193	82	36	2
L-PEFFG-8242-00T	2351	82	42	2
L-PEFFG-8248-00T	2528	82	48	2
<b>One 8" &amp; Two 16" frosted glass segments on top</b>				
L-PEFFG-8224-00ESS	1931	82	24	2
L-PEFFG-8230-00ESS	2215	82	30	2
L-PEFFG-8236-00ESS	2371	82	36	2
L-PEFFG-8242-00ESS	2418	82	42	2
L-PEFFG-8248-00ESS	2610	82	48	2
<b>Three 16" frosted glass segments on top</b>				
L-PEFFG-8224-00SSS	1967	82	24	2
L-PEFFG-8230-00SSS	2186	82	30	2
L-PEFFG-8236-00SSS	2362	82	36	2
L-PEFFG-8242-00SSS	2536	82	42	2
L-PEFFG-8248-00SSS	2727	82	48	2
<b>One 24" frosted glass segment on top</b>				
L-PEFFG-6624-00T	1122	66	24	2
L-PEFFG-6630-00T	1221	66	30	2
L-PEFFG-6636-00T	1319	66	36	2
L-PEFFG-6642-00T	1419	66	42	2
L-PEFFG-6648-00T	1517	66	48	2
L-PEFFG-6654-00T	1616	66	54	2
L-PEFFG-6660-00T	1714	66	60	2

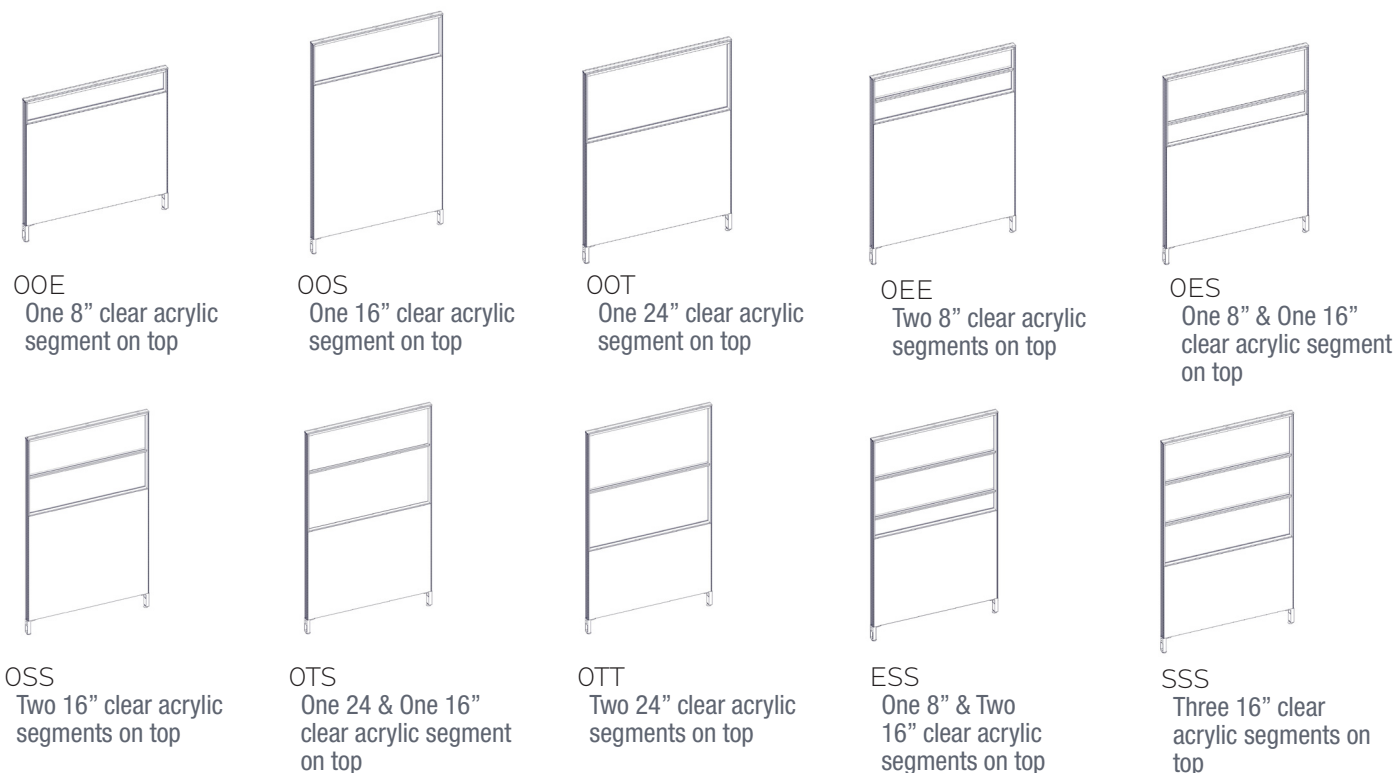

**How to order and read your code**

**L - P E L C A - 42 24 - 0 0 E**

product standard line P= integrated E = Elevated F=Fabric L=Laminate C=Clear L=Laminate F=Frosted G=Glass A=Acrylic height width 0 = No segment E = 8 inch segment S = 16 inch segment T = 24 inch segment

**What's Included:**

One (1) 2" thick panel with integrated glass top and laminate bottom, also 1" incremented slotted channels, One (1) top trim

**How to Specify:**

Refer to laminate cards for laminate selections  
 Choose glass or acrylic  
 Choose White, Black, Silver, Charcoal for Panel Frame colour

**Options:**

Height*	34", 42", 50", 66", 82"
Width:	24", 30", 36", 42", 48",
Laminate	
Glass/Acrylic	
Metal Powder Coat Paint:	White, Black, Silver, Charcoal

\*82"H available up to 36"W

Code	Price	H	W	D
One 8" clear acrylic segment on top				
L-PELCA-4224-00E	983	42	24	2
L-PELCA-4230-00E	1012	42	30	2
L-PELCA-4236-00E	1063	42	36	2
L-PELCA-4242-00E	1192	42	42	2
L-PELCA-4248-00E	1220	42	48	2
L-PELCA-5024-00E	1020	50	24	2
L-PELCA-5030-00E	1049	50	30	2
L-PELCA-5036-00E	1102	50	36	2
L-PELCA-5042-00E	1251	50	42	2
L-PELCA-5048-00E	1280	50	48	2
One 16" clear acrylic segment on top				
L-PELCA-5024-00S	1035	50	24	2
L-PELCA-5030-00S	1073	50	30	2
L-PELCA-5036-00S	1133	50	36	2
L-PELCA-5042-00S	1267	50	42	2
L-PELCA-5048-00S	1302	50	48	2
L-PELCA-6624-00S	1133	66	24	2
L-PELCA-6630-00S	1168	66	30	2
L-PELCA-6636-00S	1243	66	36	2
L-PELCA-6642-00S	1439	66	42	2
L-PELCA-6648-00S	1477	66	48	2
L-PELCA-8224-00S	1489	82	24	2
L-PELCA-8230-00S	1497	82	30	2
L-PELCA-8236-00S	1989	82	36	2
One 24" clear acrylic segment on top				
L-PELCA-6624-00T	1122	66	24	2
L-PELCA-6630-00T	1166	66	30	2
L-PELCA-6636-00T	1241	66	36	2
L-PELCA-6642-00T	1403	66	42	2
L-PELCA-6648-00T	1449	66	48	2
Two 8" clear acrylic segments on top				
L-PELCA-6624-0EE	1298	66	24	2
L-PELCA-6630-0EE	1306	66	30	2
L-PELCA-6636-0EE	1570	66	36	2
L-PELCA-6642-0EE	1597	66	42	2
L-PELCA-6648-0EE	1642	66	48	2
One 8" & One 16" clear acrylic segment on top				
L-PELCA-6624-0ES	1305	66	24	2
L-PELCA-6630-0ES	1350	66	30	2
L-PELCA-6636-0ES	1637	66	36	2
L-PELCA-6642-0ES	1683	66	42	2
L-PELCA-6648-0ES	1729	66	48	2
Two 16" clear acrylic segments on top				
L-PELCA-8224-0SS	1356	82	24	2
L-PELCA-8230-0SS	1417	82	30	2
L-PELCA-8236-0SS	1734	82	36	2
One 24" & One 16" clear acrylic segment on top				
L-PELCA-8224-0TS	1387	82	24	2
L-PELCA-8230-0TS	1467	82	30	2
L-PELCA-8236-0TS	1742	82	36	2
Two 24" clear acrylic segments on top				
L-PELCA-8224-0TT	1328	82	24	2
L-PELCA-8230-0TT	1396	82	30	2
L-PELCA-8236-0TT	1631	82	36	2
One 8" & Two 16" clear acrylic segments on top				
L-PELCA-8224-0SS	1448	82	24	2
L-PELCA-8230-0SS	1597	82	30	2
L-PELCA-8236-0SS	1883	82	36	2
Three 16" clear acrylic segments on top				
L-PELCA-8224-0SS	1418	82	24	2
L-PELCA-8230-0SS	1496	82	30	2
L-PELCA-8236-0SS	1804	82	36	2

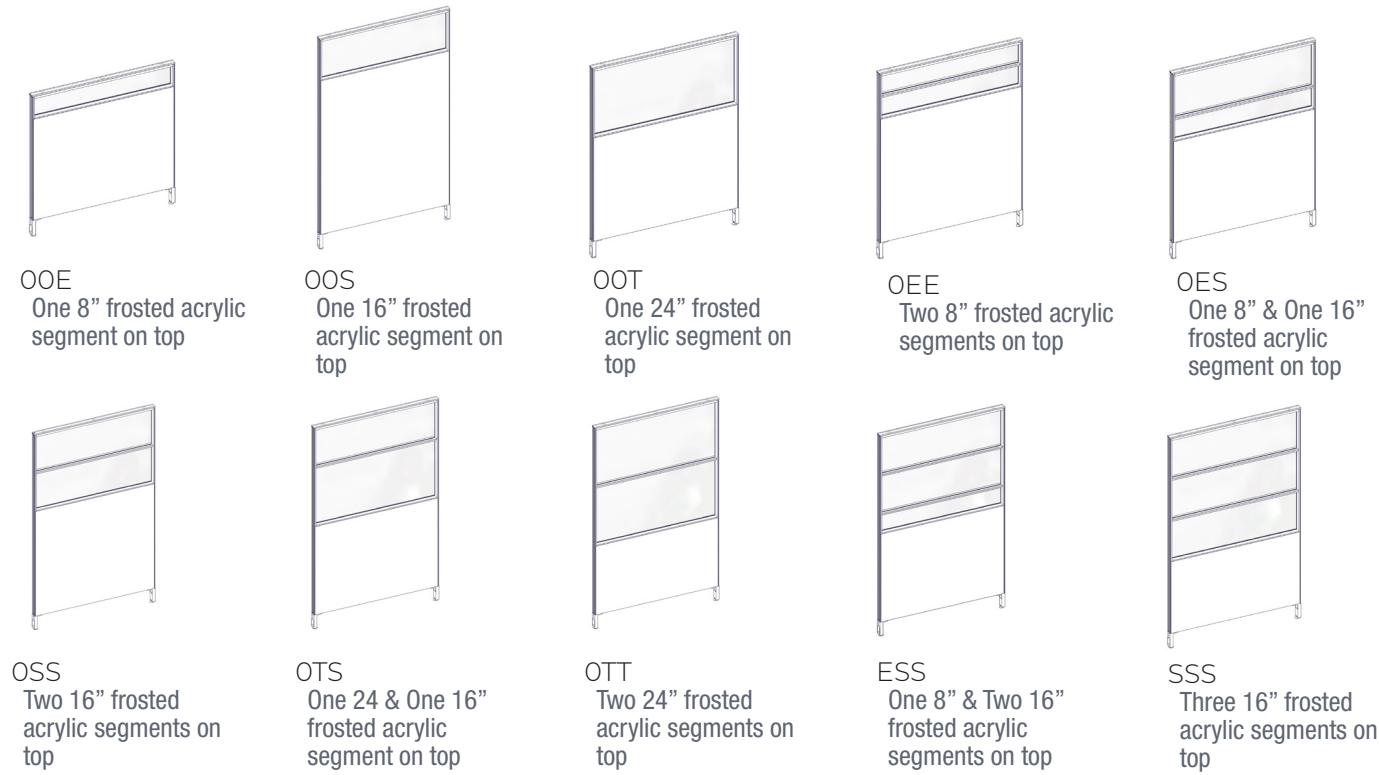

**How to order and read your code**

**L - P E L F A - 4 2 2 4 - 0 0 E**

product standard line P= integrated E = Elevated F=Fabric L=Laminate C=Clear F=Frosted A=Acrylic height G=Glass width 0 = No segment E = 8 inch segment S = 16 inch segment T = 24 inch segment

**What's Included:**

One (1) 2" thick panel with integrated glass top and laminate bottom, also 1" incremented slotted channels, One (1) top trim

**How to Specify:**

Refer to laminate cards for laminate selections  
 Choose glass or acrylic  
 Choose White, Black, Silver, Charcoal for Panel Frame colour

**Options:**

Height*	34", 42", 50", 66", 82"
Width:	24", 30", 36", 42", 48",
Laminate	
Glass/Acrylic	
Metal Powder Coat Paint:	White, Black, Silver, Charcoal

\*82"H available up to 36"W

**Notes:**

Non-power capable panel.  
 Can be used in run with power-capable panels and allows wires to pass through.  
 Panels are non tackable. For tackable option see Panel Add-On section.

Code	Price	H	W	D
One 8" frosted acrylic segment on top				
L-PELFA-4224-00E	1084	24	42	2
L-PELFA-4230-00E	1111	30	42	2
L-PELFA-4236-00E	1162	36	42	2
L-PELFA-4242-00E	1291	42	42	2
L-PELFA-4248-00E	1319	48	42	2
L-PELFA-5024-00E	1120	24	50	2
L-PELFA-5030-00E	1147	30	50	2
L-PELFA-5036-00E	1201	36	50	2
L-PELFA-5042-00E	1350	42	50	2
L-PELFA-5048-00E	1379	48	50	2
One 16" frosted acrylic segment on top				
L-PELFA-5024-00S	1134	24	50	2
L-PELFA-5030-00S	1172	30	50	2
L-PELFA-5036-00S	1232	36	50	2
L-PELFA-5042-00S	1366	42	50	2
L-PELFA-5048-00S	1401	48	50	2
L-PELFA-6624-00S	1232	24	66	2
L-PELFA-6630-00S	1267	30	66	2
L-PELFA-6636-00S	1342	36	66	2
L-PELFA-6642-00S	1538	42	66	2
L-PELFA-6648-00S	1576	48	66	2
L-PELFA-8224-00S	1524	24	82	2
L-PELFA-8230-00S	1541	30	82	2
L-PELFA-8236-00S	2047	36	82	2
One 24" frosted acrylic segment on top				
L-PELFA-6624-00T	1221	24	66	2
L-PELFA-6630-00T	1266	30	66	2
L-PELFA-6636-00T	1340	36	66	2
L-PELFA-6642-00T	1502	42	66	2
L-PELFA-6648-00T	1548	48	66	2

Code	Price	H	W	D
Two 8" frosted acrylic segments on top				
L-PELFA-6624-0EE	1359	24	66	2
L-PELFA-6630-0EE	1386	30	66	2
L-PELFA-6636-0EE	1674	36	66	2
L-PELFA-6642-0EE	1698	42	66	2
L-PELFA-6648-0EE	1762	48	66	2
One 8" & One 16" frosted acrylic segment on top				
L-PELFA-6624-0ES	1355	24	66	2
L-PELFA-6630-0ES	1418	30	66	2
L-PELFA-6636-0ES	1718	36	66	2
L-PELFA-6642-0ES	1783	42	66	2
L-PELFA-6648-0ES	1829	48	66	2
Two 16" frosted acrylic segments on top				
L-PELFA-8224-0SS	1262	24	82	2
L-PELFA-8230-0SS	1282	30	82	2
L-PELFA-8236-0SS	1555	36	82	2
One 24" & One 16" frosted acrylic segment on top				
L-PELFA-8224-0TS	1487	24	82	2
L-PELFA-8230-0TS	1601	30	82	2
L-PELFA-8236-0TS	1877	36	82	2
Two 24" frosted acrylic segments on top				
L-PELFA-8224-0TT	1428	24	82	2
L-PELFA-8230-0TT	1529	30	82	2
L-PELFA-8236-0TT	1791	36	82	2
One 8" & Two 16" frosted acrylic segments on top				
L-PELFA-8224-ESS	1548	24	82	2
L-PELFA-8230-ESS	1730	30	82	2
L-PELFA-8236-ESS	2016	36	82	2
Three 16" frosted acrylic segments on top				
L-PELFA-8224-SSS	1519	24	82	2
L-PELFA-8230-SSS	1629	30	82	2
L-PELFA-8236-SSS	2005	36	82	2



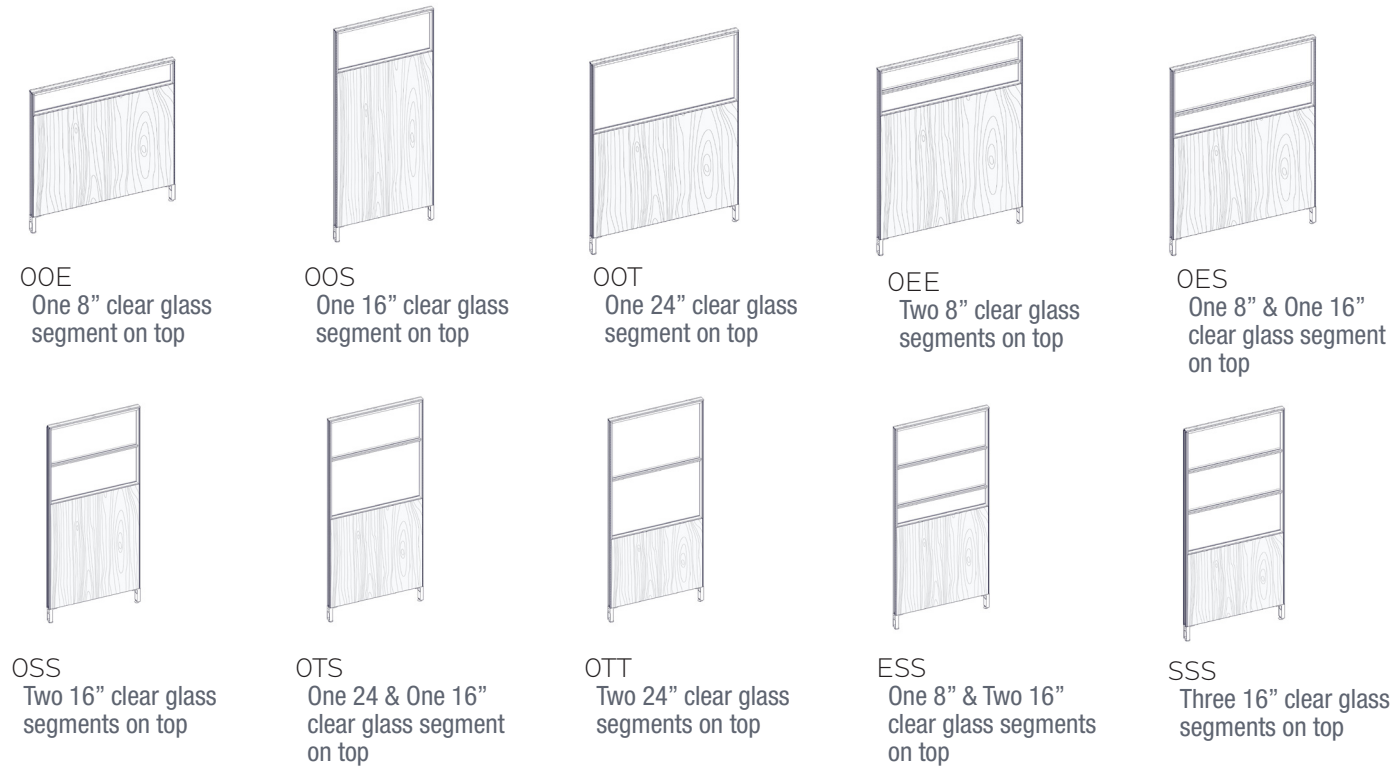

How to order and read your code

**L - P E L C G - 4 2 2 4 - 0 0 E**

product standard line P= integrated E = Elevated F=Fabric L=Laminate C=Clear F=Frosted A=Acrylic G=Glass height width 0 = No segment E = 8 inch segment S = 16 inch segment T = 24 inch segment

What's Included:

One (1) 2" thick panel with integrated glass top and laminate bottom, also 1" incremented slotted channels, One (1) top trim

How to Specify:

Refer to laminate cards for laminate selections  
 Choose glass or acrylic  
 Choose White, Black, Silver, Charcoal for Panel Frame color

Options:

Height*:	34", 42", 50", 66", 82"
Width:	24", 30", 36", 42", 48",
Laminate	
Glass/Acrylic	
Metal Powder Coat Paint:	White, Black, Silver, Charcoal

\*82"H available up to 36"W

Code	Price	H	W	D
One 8" clear glass segment on top				
L-PELCG-4224-00E	1064	42	24	2
L-PELCG-4230-00E	1106	42	30	2
L-PELCG-4236-00E	1176	42	36	2
L-PELCG-4242-00E	1320	42	42	2
L-PELCG-4248-00E	1366	42	48	2
L-PELCG-5024-00E	1100	50	24	2
L-PELCG-5030-00E	1144	50	30	2
L-PELCG-5036-00E	1218	50	36	2
L-PELCG-5042-00E	1378	50	42	2
L-PELCG-5048-00E	1425	50	48	2
One 16" clear glass segment on top				
L-PELCG-5024-00S	1164	50	24	2
L-PELCG-5030-00S	1229	50	30	2
L-PELCG-5036-00S	1318	50	36	2
L-PELCG-5042-00S	1480	50	42	2
L-PELCG-5048-00S	1543	50	48	2
L-PELCG-6624-00S	1261	66	24	2
L-PELCG-6630-00S	1327	66	30	2
L-PELCG-6636-00S	1427	66	36	2
L-PELCG-6642-00S	1648	66	42	2
L-PELCG-6648-00S	1715	66	48	2
L-PELCG-8224-00S	1450	82	24	2
L-PELCG-8230-00S	1483	82	30	2
L-PELCG-8236-00S	1994	82	36	2
One 24" clear glass segment on top				
L-PELCG-6624-00T	1302	66	24	2
L-PELCG-6630-00T	1387	66	30	2
L-PELCG-6636-00T	1497	66	36	2
L-PELCG-6642-00T	1697	66	42	2
L-PELCG-6648-00T	1786	66	48	2
Two 8" clear glass segments on top				
L-PELCG-6624-0EE	1393	66	24	2
L-PELCG-6630-0EE	1431	66	30	2
L-PELCG-6636-0EE	1720	66	36	2
L-PELCG-6642-0EE	1758	66	42	2
L-PELCG-6648-0EE	1817	66	48	2
One 8" & One 16" clear glass segment on top				
L-PELCG-6624-0ES	1393	66	24	2
L-PELCG-6630-0ES	1450	66	30	2
L-PELCG-6636-0ES	1753	66	36	2
L-PELCG-6642-0ES	1805	66	42	2
L-PELCG-6648-0ES	1879	66	48	2
Two 16" clear glass segments on top				
L-PELCG-8224-0SS	1444	82	24	2
L-PELCG-8230-0SS	1499	82	30	2
L-PELCG-8236-0SS	1817	82	36	2
One 24" & One 16" clear glass segment on top				
L-PELCG-8224-0TS	1473	82	24	2
L-PELCG-8230-0TS	1552	82	30	2
L-PELCG-8236-0TS	1878	82	36	2
Two 24" clear glass segments on top				
L-PELCG-8224-0TT	1443	82	24	2
L-PELCG-8230-0TT	1528	82	30	2
L-PELCG-8236-0TT	1783	82	36	2
One 8" & Two 16" clear glass segments on top				
L-PELCG-8224-ESS	1619	82	24	2
L-PELCG-8230-ESS	1758	82	30	2
L-PELCG-8236-ESS	2093	82	36	2
Three 16" clear glass segments on top				
L-PELCG-8224-SSS	1596	82	24	2
L-PELCG-8230-SSS	1673	82	30	2
L-PELCG-8236-SSS	1950	82	36	2

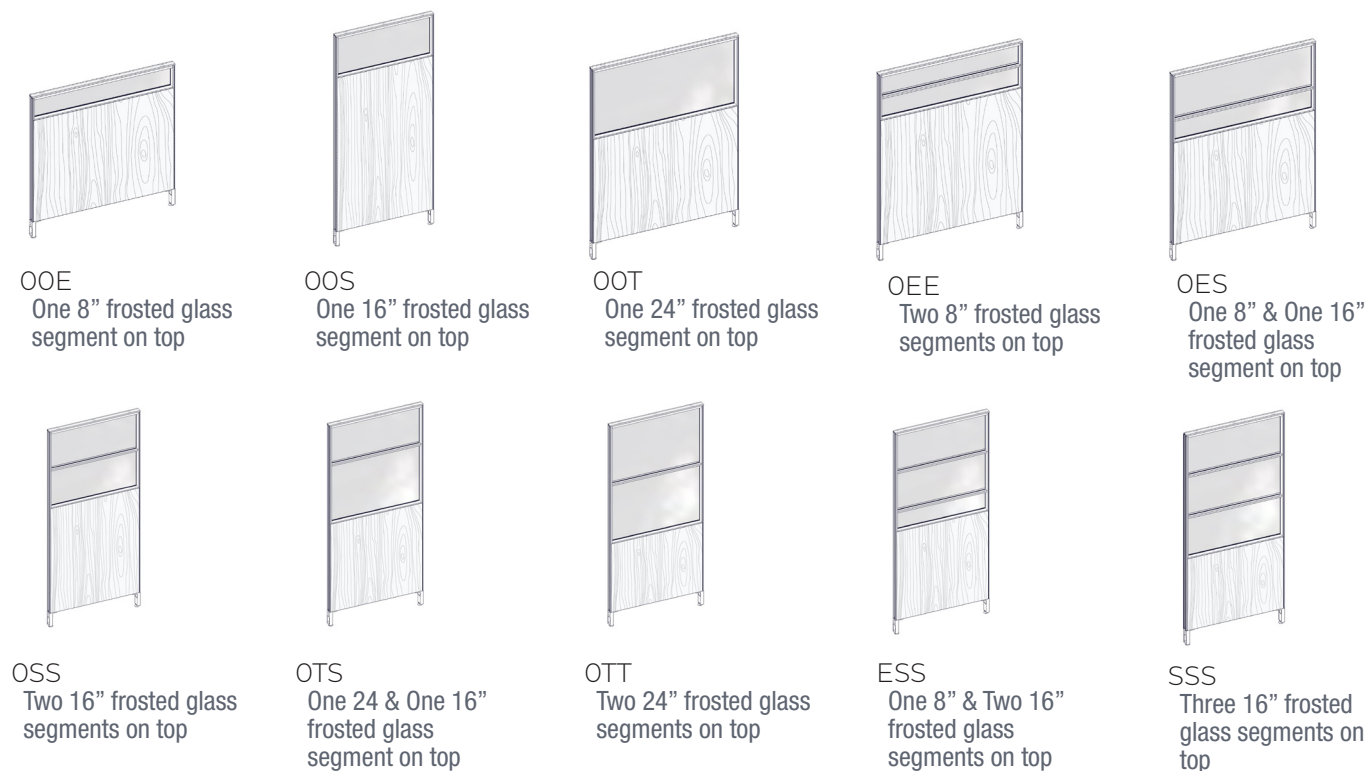

**How to order and read your code**

**L - P E L F G - 42 24 - 00 E**

product standard line P= integrated E = Elevated F=Fabric L=Laminate C= Clear F=Frosted A=Acrylic G=Glass height width 0 = No segment E = 8 inch segment S = 16 inch segment T = 24 inch segment

**What's Included:**

One (1) 2" thick panel with integrated glass top and laminate bottom, also 1" incremented slotted channels, One (1) top trim

**How to Specify:**

Refer to laminate cards for laminate selections  
Choose glass or acrylic  
Choose White, Black, Silver, Charcoal for Panel Frame colour

**Options:**

Height*:	34", 42", 50", 66", 82"
Width:	24", 30", 36", 42", 48",
Laminate	
Glass/Acrylic	
Metal Powder Coat Paint:	White, Black, Silver, Charcoal

\*82"H available up to 36"W

Code	Price	H	W	D
<b>One 8" frosted glass segment on top</b>				
L-PELFG-4224-00E	1163	24	42	2
L-PELFG-4230-00E	1206	30	42	2
L-PELFG-4236-00E	1275	36	42	2
L-PELFG-4242-00E	1419	42	42	2
L-PELFG-4248-00E	1465	48	42	2
L-PELFG-5024-00E	1199	24	50	2
L-PELFG-5030-00E	1243	30	50	2
L-PELFG-5036-00E	1317	36	50	2
L-PELFG-5042-00E	1477	42	50	2
L-PELFG-5048-00E	1524	48	50	2
<b>One 16" frosted glass segment on top</b>				
L-PELFG-5024-00S	1263	24	50	2
L-PELFG-5030-00S	1328	30	50	2
L-PELFG-5036-00S	1417	36	50	2
L-PELFG-5042-00S	1580	42	50	2
L-PELFG-5048-00S	1642	48	50	2
L-PELFG-6624-00S	1360	24	66	2
L-PELFG-6630-00S	1426	30	66	2
L-PELFG-6636-00S	1526	36	66	2
L-PELFG-6642-00S	1747	42	66	2
L-PELFG-6648-00S	1814	48	66	2
L-PELFG-8224-00S	1630	24	82	2
L-PELFG-8230-00S	1671	30	82	2
L-PELFG-8236-00S	2201	36	82	2
<b>One 24" frosted glass segment on top</b>				
L-PELFG-6624-00T	1401	24	66	2
L-PELFG-6630-00T	1486	30	66	2
L-PELFG-6636-00T	1596	36	66	2
L-PELFG-6642-00T	1795	42	66	2
L-PELFG-6648-00T	1885	48	66	2
<b>Two 8" frosted glass segments on top</b>				
L-PELFG-6624-0EE	1555	24	66	2
L-PELFG-6630-0EE	1594	30	66	2
L-PELFG-6636-0EE	1883	36	66	2
L-PELFG-6642-0EE	1920	42	66	2
L-PELFG-6648-0EE	1980	48	66	2
<b>One 8" &amp; One 16" frosted glass segment on top</b>				
L-PELFG-6624-0ES	1555	24	66	2
L-PELFG-6630-0ES	1621	30	66	2
L-PELFG-6636-0ES	1944	36	66	2
L-PELFG-6642-0ES	2013	42	66	2
L-PELFG-6648-0ES	2105	48	66	2
<b>Two 16" frosted glass segments on top</b>				
L-PELFG-8224-0SS	1606	24	82	2
L-PELFG-8230-0SS	1680	30	82	2
L-PELFG-8236-0SS	2034	36	82	2
<b>One 24" &amp; One 16" frosted glass segment on top</b>				
L-PELFG-8224-0TS	1662	24	82	2
L-PELFG-8230-0TS	1778	30	82	2
L-PELFG-8236-0TS	2149	36	82	2
<b>Two 24" frosted glass segments on top</b>				
L-PELFG-8224-0TT	1660	24	82	2
L-PELFG-8230-0TT	1797	30	82	2
L-PELFG-8236-0TT	2109	36	82	2
<b>One 8" &amp; Two 16" frosted glass segments on top</b>				
L-PELFG-8224-ESS	1862	24	82	2
L-PELFG-8230-ESS	2020	30	82	2
L-PELFG-8236-ESS	2391	36	82	2
<b>Three 16" frosted glass segments on top</b>				
L-PELFG-8224-SSS	1840	24	82	2
L-PELFG-8230-SSS	1944	30	82	2
L-PELFG-8236-SSS	2276	36	82	2

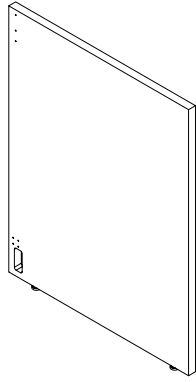

Single Span Middle  
Horizontal Woodgrain  
Gallery Panel

**What's Included:**

One (1) 1" thick laminate gallery panel, two (2) gallery panel top brackets

**How to Specify:**

Refer to laminate cards for laminate selections

**Notes:**

Gallery panels come with pre-drilled holes on each side and bottom notch for wire routing

Gallery panels must be used between two standard fabric or laminate panels

Gallery panels must be the same height or lower than the connecting standard fabric or laminate panel

**Options:**

Height: 34", 42", 50"

Width: 26", 32", 38", 44", 50", 56", 62", 68", 74"

Laminate color

Code	Price	H	W	D	Weight (lb.)	Volume (ft <sup>3</sup> )
L-PYHM-3426-S1	276	34	26	2		
L-PYHM-3432-S1	305	34	32	2		
L-PYHM-3438-S1	333	34	38	2		
L-PYHM-3444-S1	360	34	44	2		
L-PYHM-3450-S1	388	34	50	2		
L-PYHM-3456-S1	415	34	50	2		
L-PYHM-3462-S1	446	34	62	2		
L-PYHM-3468-S1	472	34	68	2		
L-PYHM-3474-S1	499	34	74	2		
L-PYHM-4226-S1	305	42	26	2		
L-PYHM-4232-S1	340	42	32	2		
L-PYHM-4238-S1	374	42	38	2		
L-PYHM-4244-S1	409	42	44	2		
L-PYHM-4250-S1	444	42	50	2		
L-PYHM-4256-S1	474	42	50	2		
L-PYHM-4262-S1	510	42	62	2		
L-PYHM-4268-S1	545	42	68	2		
L-PYHM-4274-S1	582	42	74	2		
L-PYHM-5026-S1	337	50	26	2		
L-PYHM-5032-S1	375	50	32	2		
L-PYHM-5038-S1	414	50	38	2		
L-PYHM-5044-S1	457	50	44	2		
L-PYHM-5050-S1	495	50	50	2		
L-PYHM-5056-S1	537	50	50	2		
L-PYHM-5062-S1	578	50	62	2		
L-PYHM-5068-S1	615	50	68	2		
L-PYHM-5074-S1	657	50	74	2		

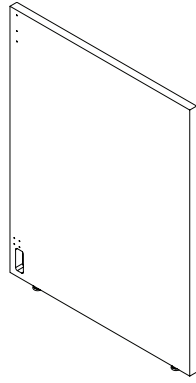

Double Span Middle  
Horizontal Woodgrain  
Gallery Panel

**What's Included:**

- X"-X": One (1) 1"thick laminate gallery panel, two (2) gallery panel top brackets
- X"-X": Two (2) 1"thick laminate gallery panel, four (4) gallery panel top brackets

**How to Specify:**

Refer to laminate cards for laminate selections

**Notes:**

- Gallery panels come with pre-drilled holes on each side and bottom notch for wire routing
- Gallery panels must be used between two standard fabric or laminate panels
- Gallery panels must be the same height or lower than the connecting standard fabric or laminate panel

**Options:**

Height:	34", 42", 50"
Width:	26", 32", 38", 44", 50", 56", 62", 68", 74"
Laminate color	

Code	Price	H	W	D	Weight (lb.)	Volume (ft <sup>3</sup> )
<b>1 Piece</b>						
L-PYHM-3442-D1	350	34	42	2		
L-PYHM-3450-D1	388	34	50	2		
L-PYHM-3462-D1	446	34	62	2		
L-PYHM-3474-D1	499	34	74	2		
L-PYHM-3486-D1	557	34	86	2		
L-PYHM-4242-D1	397	42	42	2		
L-PYHM-4250-D1	444	42	50	2		
L-PYHM-4262-D1	510	42	62	2		
L-PYHM-4274-D1	582	42	74	2		
L-PYHM-4286-D1	649	42	86	2		
L-PYHM-5042-D1	444	50	42	2		
L-PYHM-5050-D1	495	50	50	2		
L-PYHM-5062-D1	578	50	62	2		
L-PYHM-5074-D1	657	50	74	2		
L-PYHM-5086-D1	738	50	86	2		
<b>2 Pieces</b>						
L-PYHM-3498-D2	715	34	98	2		
L-PYHM-4298-D2	821	42	98	2		
L-PYHM-5098-D2	928	50	98	2		
L-PYHM-34110-D2	773	34	110	2		
L-PYHM-34122-D2	829	34	122	2		
L-PYHM-34134-D2	883	34	134	2		
L-PYHM-34146-D2	941	34	146	2		
L-PYHM-42110-D2	890	42	110	2		
L-PYHM-42122-D2	957	42	122	2		
L-PYHM-42134-D2	1027	42	134	2		
L-PYHM-42146-D2	1097	42	146	2		
L-PYHM-50110-D2	1008	50	110	2		
L-PYHM-50122-D2	1089	50	122	2		
L-PYHM-50134-D2	1172	50	134	2		
L-PYHM-50146-D2	1251	50	146	2		



Single Span End Horizontal Woodgrain Gallery Panel No Power Cutout

**What's Included:**

One (1) 1"thick laminate gallery panel, two (2) gallery panel top brackets

**How to Specify:**

Refer to laminate cards for laminate selections

Choose option for power cut out or no power cut out

**Options:**

Height: 34", 42", 50"

Width: 26", 32", 38", 44", 50", 56", 62", 68", 74"

Laminate color

Power cut out

Code	Price	H	W	D	Weight (lb.)	Volume (ft <sup>3</sup> )
left hand						
L-PYHE-3426-S1L	238	34	26	2		
L-PYHE-3432-S1L	265	34	32	2		
L-PYHE-3438-S1L	292	34	38	2		
L-PYHE-3444-S1L	319	34	44	2		
L-PYHE-3450-S1L	349	34	50	2		
L-PYHE-3456-S1L	377	34	56	2		
L-PYHE-3462-S1L	406	34	62	2		
L-PYHE-3468-S1L	432	34	68	2		
L-PYHE-3474-S1L	461	34	74	2		
L-PYHE-4226-S1L	265	42	26	2		
L-PYHE-4232-S1L	299	42	32	2		
L-PYHE-4238-S1L	334	42	38	2		
L-PYHE-4244-S1L	367	42	44	2		
L-PYHE-4250-S1L	403	42	50	2		
L-PYHE-4256-S1L	435	42	56	2		

Code	Price	H	W	D	Weight (lb.)	Volume (ft <sup>3</sup> )
L-PYHE-4262-S1L	470	42	62	2		
L-PYHE-4268-S1L	506	42	68	2		
L-PYHE-4274-S1L	541	42	74	2		
L-PYHE-5026-S1L	294	50	26	2		
L-PYHE-5032-S1L	337	50	32	2		
L-PYHE-5038-S1L	375	50	38	2		
L-PYHE-5044-S1L	415	50	44	2		
L-PYHE-5050-S1L	457	50	50	2		
L-PYHE-5056-S1L	496	50	56	2		
L-PYHE-5062-S1L	537	50	62	2		
L-PYHE-5068-S1L	578	50	68	2		
L-PYHE-5074-S1L	616	50	74	2		
right hand						
L-PYHE-3426-S1R	238	34	26	2		
L-PYHE-3432-S1R	265	34	32	2		
L-PYHE-3438-S1R	292	34	38	2		
L-PYHE-3444-S1R	319	34	44	2		
L-PYHE-3450-S1R	349	34	50	2		
L-PYHE-3456-S1R	377	34	56	2		
L-PYHE-3462-S1R	406	34	62	2		
L-PYHE-3468-S1R	432	34	68	2		
L-PYHE-3474-S1R	461	34	74	2		
L-PYHE-4226-S1R	265	42	26	2		
L-PYHE-4232-S1R	299	42	32	2		
L-PYHE-4238-S1R	334	42	38	2		
L-PYHE-4244-S1R	367	42	44	2		
L-PYHE-4250-S1R	403	42	50	2		
L-PYHE-4256-S1R	435	42	56	2		
L-PYHE-4262-S1R	470	42	62	2		
L-PYHE-4268-S1R	506	42	68	2		
L-PYHE-4274-S1R	541	42	74	2		
L-PYHE-5026-S1R	294	50	26	2		
L-PYHE-5032-S1R	337	50	32	2		
L-PYHE-5038-S1R	375	50	38	2		
L-PYHE-5044-S1R	415	50	44	2		
L-PYHE-5050-S1R	457	50	50	2		
L-PYHE-5056-S1R	496	50	56	2		
L-PYHE-5062-S1R	537	50	62	2		
L-PYHE-5068-S1R	578	50	68	2		
L-PYHE-5074-S1R	616	50	74	2		



Single Span End Horizontal Woodgrain Gallery Panel with Power Cutout

**What's Included:**

One (1) 1" thick laminate gallery panel, two (2) gallery panel top brackets

**How to Specify:**

Refer to laminate cards for laminate selections

Choose option for power cut out or no power cut out

**Options:**

Height: 34", 42", 50"

Width: 26", 32", 38", 44", 50", 56", 62", 68", 74"

Laminate color

No power cut out

Code	Price	H	W	D	Weight (lb.)	Volume (ft <sup>3</sup> )
left hand						
L-PCHE-3426-S1L	238	34	26	1		
L-PCHE-3432-S1L	265	34	32	1		
L-PCHE-3438-S1L	292	34	38	1		
L-PCHE-3444-S1L	319	34	44	1		
L-PCHE-3450-S1L	349	34	50	1		
L-PCHE-3456-S1L	377	34	56	1		
L-PCHE-3462-S1L	406	34	62	1		
L-PCHE-3468-S1L	432	34	68	1		
L-PCHE-3474-S1L	461	34	74	1		
L-PCHE-4226-S1L	265	42	26	1		
L-PCHE-4232-S1L	299	42	32	1		
L-PCHE-4238-S1L	334	42	38	1		
L-PCHE-4244-S1L	367	42	44	1		
L-PCHE-4250-S1L	403	42	50	1		
L-PCHE-4256-S1L	435	42	56	1		

Code	Price	H	W	D	Weight (lb.)	Volume (ft <sup>3</sup> )
L-PCHE-4262-S1L	470	42	62	1		
L-PCHE-4268-S1L	506	42	68	1		
L-PCHE-4274-S1L	541	42	74	1		
L-PCHE-5026-S1L	294	50	26	1		
L-PCHE-5032-S1L	337	50	32	1		
L-PCHE-5038-S1L	375	50	38	1		
L-PCHE-5044-S1L	415	50	44	1		
L-PCHE-5050-S1L	457	50	50	1		
L-PCHE-5056-S1L	496	50	56	1		
L-PCHE-5062-S1L	537	50	62	1		
L-PCHE-5068-S1L	578	50	68	1		
L-PCHE-5074-S1L	616	50	74	1		
right hand						
L-PCHE-3426-S1R	238	34	26	1		
L-PCHE-3432-S1R	265	34	32	1		
L-PCHE-3438-S1R	292	34	38	1		
L-PCHE-3444-S1R	319	34	44	1		
L-PCHE-3450-S1R	349	34	50	1		
L-PCHE-3456-S1R	377	34	56	1		
L-PCHE-3462-S1R	406	34	62	1		
L-PCHE-3468-S1R	432	34	68	1		
L-PCHE-3474-S1R	461	34	74	1		
L-PCHE-4226-S1R	265	42	26	1		
L-PCHE-4232-S1R	299	42	32	1		
L-PCHE-4238-S1R	334	42	38	1		
L-PCHE-4244-S1R	367	42	44	1		
L-PCHE-4250-S1R	403	42	50	1		
L-PCHE-4256-S1R	435	42	56	1		
L-PCHE-4262-S1R	470	42	62	1		
L-PCHE-4268-S1R	506	42	68	1		
L-PCHE-4274-S1R	541	42	74	1		
L-PCHE-5026-S1R	294	50	26	1		
L-PCHE-5032-S1R	337	50	32	1		
L-PCHE-5038-S1R	375	50	38	1		
L-PCHE-5044-S1R	415	50	44	1		
L-PCHE-5050-S1R	457	50	50	1		
L-PCHE-5056-S1R	496	50	56	1		
L-PCHE-5062-S1R	537	50	62	1		
L-PCHE-5068-S1R	578	50	68	1		
L-PCHE-5074-S1R	616	50	74	1		



Single piece  
Double Span End  
Horizontal Woodgrain  
Gallery Panel  
No Power Cutout



Two pieces  
Double Span End  
Horizontal Woodgrain  
Gallery Panel  
No Power Cutout

**What's Included:**

- X"-X": One (1) 1"thick laminate gallery panel, two (2) gallery panel top brackets
- X"-X": Two (2) 1"thick laminate gallery panel, four (4) gallery panel top brackets

**How to Specify:**

- Refer to laminate cards for laminate selections
- Choose option for power cut out or no power cut out

**Options:**

Height:

Width:

Laminate color

Power cut out

**Notes:**

- Gallery panels come with pre-drilled holes on each side and bottom notch for wire routing
- Gallery panels must be used between two standard fabric or laminate panels
- Gallery panels must be the same height or lower than the connecting standard fabric or laminate panel

Code	Price	H	W	D	Weight (lb.)	Volume (ft <sup>3</sup> )
single piece						
L-PYHE-3442-D1	311	34	42	2		
L-PYHE-3450-D1	349	34	50	2		
L-PYHE-3462-D1	406	34	62	2		
L-PYHE-3474-D1	461	34	74	2		
L-PYHE-3486-D1	517	34	86	2		
L-PYHE-4242-D1	358	42	42	2		
L-PYHE-4250-D1	403	42	50	2		
L-PYHE-4262-D1	470	42	62	2		
L-PYHE-4274-D1	541	42	74	2		
L-PYHE-4286-D1	608	42	86	2		
L-PYHE-5042-D1	403	50	42	2		
L-PYHE-5050-D1	457	50	50	2		
L-PYHE-5062-D1	537	50	62	2		
L-PYHE-5074-D1	616	50	74	2		
L-PYHE-5086-D1	699	50	86	2		
2 pieces						
L-PYHE-3498-D2	715	34	98	2		
L-PYHE-4298-D2	821	42	98	2		
L-PYHE-5098-D2	928	50	98	2		
L-PYHE-34110-D2	773	34	110	2		
L-PYHE-34122-D2	829	34	122	2		
L-PYHE-34134-D2	883	34	134	2		
L-PYHE-34146-D2	941	34	146	2		
L-PYHE-42110-D2	890	42	110	2		
L-PYHE-42122-D2	957	42	122	2		
L-PYHE-42134-D2	1027	42	134	2		
L-PYHE-42146-D2	1097	42	146	2		
L-PYHE-50110-D2	1008	50	110	2		
L-PYHE-50122-D2	1089	50	122	2		
L-PYHE-50134-D2	1172	50	134	2		
L-PYHE-50146-D2	1251	50	146	2		



Single piece

Double Span End Horizontal Woodgrain Gallery Panel with Power Cutout



2 pieces

**What's Included:**

X"-X": One (1) 1"thick laminate gallery panel, two (2) gallery panel top brackets

X"-X": Two (2) 1"thick laminate gallery panel, four (4) gallery panel top brackets

**How to Specify:**

Refer to laminate cards for laminate selections

Choose option for power cut out or no power cut out

**Notes:**

Gallery panels come with pre-drilled holes on each side and bottom notch for wire routing

Gallery panels must be used between two standard fabric or laminate panels

Gallery panels must be the same height or lower than the connecting standard fabric or laminate panel

**Options:**

Height: 34", 42", 50"

Width: 26", 32", 38", 44", 50", 56", 62", 68", 74"

Laminate color

No power cut out

Code	Price	H	W	D	Weight (lb.)	Volume (ft <sup>3</sup> )
single piece						
L-PCHE-3442-D1	311	34	42	1		
L-PCHE-3450-D1	349	34	50	1		
L-PCHE-3462-D1	406	34	62	1		
L-PCHE-3474-D1	461	34	74	1		
L-PCHE-3486-D1	517	34	86	1		
L-PCHE-4242-D1	358	42	42	1		
L-PCHE-4250-D1	403	42	50	1		
L-PCHE-4262-D1	470	42	62	1		
L-PCHE-4274-D1	541	42	74	1		
L-PCHE-4286-D1	608	42	86	1		
L-PCHE-5042-D1	403	50	42	1		
L-PCHE-5050-D1	457	50	50	1		
L-PCHE-5062-D1	537	50	62	1		
L-PCHE-5074-D1	616	50	74	1		
L-PCHE-5086-D1	699	50	86	1		
2 pieces						
L-PCHE-3498-D2	715	34	98	1		
L-PCHE-34110-D2	773	34	110	1		
L-PCHE-34122-D2	829	34	122	1		
L-PCHE-34134-D2	883	34	134	1		
L-PCHE-34146-D2	941	34	146	1		
L-PCHE-4298-D2	821	42	98	1		
L-PCHE-42110-D2	890	42	110	1		
L-PCHE-42122-D2	957	42	122	1		
L-PCHE-42134-D2	1027	42	134	1		
L-PCHE-42146-D2	1097	42	146	1		
L-PCHE-5098-D2	928	50	98	1		
L-PCHE-50110-D2	1008	50	110	1		
L-PCHE-50122-D2	1089	50	122	1		
L-PCHE-50134-D2	1172	50	134	1		
L-PCHE-50146-D2	1251	50	146	1		



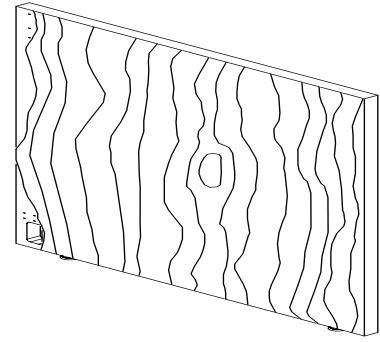

Single Span Middle  
Vertical Woodgrain  
Gallery Panel

**What's Included:**

One (1) 1" thick laminate gallery panel,  
two (2) gallery panel top brackets

**How to Specify:**

Refer to laminate cards for laminate selections

**Notes:**

Gallery panels come with pre-drilled holes on each side and bottom notch for wire routing

Gallery panels must be used between two standard fabric or laminate panels

Gallery panels must be the same height or lower than the connecting standard fabric or laminate panel

**Options:**

Height: 34", 42", 50"

Width: 26", 32", 38", 44", 50", 56", 62", 68", 74"

Laminate color

Code	Price	H	W	D	Weight (lb.)	Volume (ft <sup>3</sup> )
L-PYGM-3426-S1	276	34	26	1	17.7	0.51
L-PYGM-3432-S1	305	34	32	1	21.8	0.63
L-PYGM-3438-S1	333	34	38	1	25.8	0.75
L-PYGM-3444-S1	360	34	44	1	29.9	0.87
L-PYGM-3450-S1	388	34	50	1	34.0	0.98
L-PYGM-3456-S1	415	34	56	1	38.1	1.10
L-PYGM-4226-S1	305	42	26	1	21.8	0.63
L-PYGM-4232-S1	340	42	32	1	26.9	0.78
L-PYGM-4238-S1	374	42	38	1	31.9	0.92
L-PYGM-4244-S1	409	42	44	1	37.0	1.07
L-PYGM-4250-S1	444	42	50	1	42.0	1.22
L-PYGM-4256-S1	474	42	56	1	47.0	1.36
L-PYGM-5026-S1	337	50	26	1	26.0	0.75
L-PYGM-5032-S1	375	50	32	1	32.0	0.93
L-PYGM-5038-S1	414	50	38	1	38.0	1.10
L-PYGM-5044-S1	457	50	44	1	44.0	1.27
L-PYGM-5050-S1	495	50	50	1	50.0	1.45
L-PYGM-5056-S1	537	50	56	1	56.0	1.62

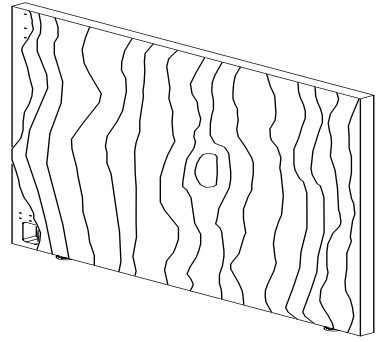

Double Span Middle  
Vertical Woodgrain  
Gallery Panel

**What's Included:**

X"-X": One (1) 1"thick laminate gallery panel, two (2) gallery panel top brackets

X"-X": Two (2) 1"thick laminate gallery panel, four (4) gallery panel top brackets

**How to Specify:**

Refer to laminate cards for laminate selections

**Notes:**

Gallery panels come with pre-drilled holes on each side and bottom notch for wire routing

Gallery panels must be used between two standard fabric or laminate panels

Gallery panels must be the same height or lower than the connecting standard fabric or laminate panel

**Options:**

Height: 34", 42", 50"

Width: 26", 32", 38", 44", 50", 56", 62", 68", 74"

Laminate color

Code	Price	H	W	D	Weight (lb.)	Volume (ft <sup>3</sup> )
single piece						
L-PYGM-3442-D1	350	34	42	1	28.6	0.83
L-PYGM-3450-D1	388	34	50	1	34.0	0.98
L-PYGM-4242-D1	397	42	42	1	28.6	1.02
L-PYGM-4250-D1	444	42	50	1	42.0	1.22
L-PYGM-5042-D1	444	50	42	1	28.6	1.22
L-PYGM-5050-D1	495	50	50	1	50.0	1.45
2 pieces						
L-PYGM-3462-D2	547	34	62	1	42.2	1.22
L-PYGM-3474-D2	604	34	74	1	50.3	1.46
L-PYGM-3486-D2	658	34	86	1	58.5	1.69
L-PYGM-3498-D2	715	34	98	1	66.6	1.93
L-PYGM-4262-D2	615	42	62	1	52.1	1.51
L-PYGM-4274-D2	685	42	74	1	62.2	1.80
L-PYGM-4286-D2	752	42	86	1	72.2	2.09
L-PYGM-4298-D2	821	42	98	1	82.3	2.38
L-PYGM-5062-D2	686	50	62	1	62.0	1.79
L-PYGM-5074-D2	765	50	74	1	74.0	2.14
L-PYGM-5086-D2	847	50	86	1	86.0	2.49
L-PYGM-5098-D2	928	50	98	1	98.0	2.84
L-PYGM-34110-D2	773	34	110	1	74.8	2.16
L-PYGM-42110-D2	890	42	110	1	92.4	2.67
L-PYGM-50110-D2	1008	50	110	1	110.0	3.18

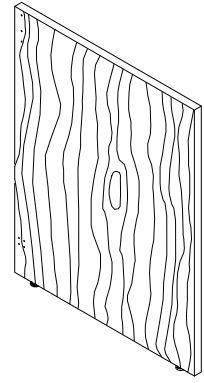

Single Span End  
Vertical Woodgrain  
Gallery Panel  
No Power Cutout

**What's Included:**

One (1) 1"thick laminate gallery panel,  
two (2) gallery panel top brackets

**How to Specify:**

Refer to laminate cards for laminate selections

Choose option for power cut out or no power cut out

**Notes:**

Gallery panels come with pre-drilled holes on each side and bottom notch for wire routing

Gallery panels must be used between two standard fabric or laminate panels

Gallery panels must be the same height or lower than the connecting standard fabric or laminate panel

**Options:**

Height: 34", 42", 50"

Width: 26", 32", 38", 44", 50", 56", 62", 68", 74"

Laminate color

Power cut out, No power cut out

Code	Price	H	W	D	Weight (lb.)	Volume (ft <sup>3</sup> )
left hand						
L-PYGE-3426-S1L	238	34	26	1	17.7	0.51
L-PYGE-3432-S1L	265	34	32	1	21.8	0.63
L-PYGE-3438-S1L	292	34	38	1	25.8	0.75
L-PYGE-3444-S1L	319	34	44	1	29.9	0.87
L-PYGE-3450-S1L	349	34	50	1	34.0	0.98
L-PYGE-3456-S1L	377	34	56	1	38.1	1.10
L-PYGE-4226-S1L	265	42	26	1	21.8	0.63
L-PYGE-4232-S1L	299	42	32	1	26.9	0.78
L-PYGE-4238-S1L	334	42	38	1	31.9	0.92
L-PYGE-4244-S1L	367	42	44	1	37.0	1.07
L-PYGE-4250-S1L	403	42	50	1	42.0	1.22
L-PYGE-4256-S1L	435	42	56	1	47.0	1.36
L-PYGE-5026-S1L	294	50	26	1	26.0	0.75
L-PYGE-5032-S1L	337	50	32	1	32.0	0.93
L-PYGE-5038-S1L	375	50	38	1	38.0	1.10
L-PYGE-5044-S1L	415	50	44	1	44.0	1.27
L-PYGE-5050-S1L	457	50	50	1	50.0	1.45
L-PYGE-5056-S1L	496	50	56	1	56.0	1.62
right hand						
L-PYGE-3426-S1R	238	34	26	1	17.7	0.51
L-PYGE-3432-S1R	265	34	32	1	21.8	0.63
L-PYGE-3438-S1R	292	34	38	1	25.8	0.75
L-PYGE-3444-S1R	319	34	44	1	29.9	0.87
L-PYGE-3450-S1R	349	34	50	1	34.0	0.98
L-PYGE-3456-S1R	377	34	56	1	38.1	1.10
L-PYGE-4226-S1R	265	42	26	1	21.8	0.63
L-PYGE-4232-S1R	299	42	32	1	26.9	0.78
L-PYGE-4238-S1R	334	42	38	1	31.9	0.92
L-PYGE-4244-S1R	367	42	44	1	37.0	1.07
L-PYGE-4250-S1R	403	42	50	1	42.0	1.22
L-PYGE-4256-S1R	435	42	56	1	47.0	1.36
L-PYGE-5026-S1R	294	50	26	1	26.0	0.75
L-PYGE-5032-S1R	337	50	32	1	32.0	0.93
L-PYGE-5038-S1R	375	50	38	1	38.0	1.10
L-PYGE-5044-S1R	415	50	44	1	44.0	1.27
L-PYGE-5050-S1R	457	50	50	1	50.0	1.45
L-PYGE-5056-S1R	496	50	56	1	56.0	1.62

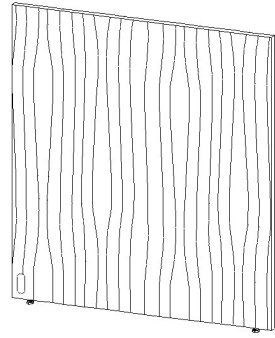

Single Span End  
Vertical Woodgrain  
Gallery Panel  
with Power Cutout

**What's Included:**

One (1) 1"thick laminate gallery panel,  
two (2) gallery panel top brackets

**How to Specify:**

Refer to laminate cards for laminate selections

Choose option for power cut out or no power cut out

**Notes:**

Gallery panels come with pre-drilled holes on each side and bottom notch for wire routing

Gallery panels must be used between two standard fabric or laminate panels

Gallery panels must be the same height or lower than the connecting standard fabric or laminate panel

**Options:**

Height: 34", 42", 50"

Width: 26", 32", 38", 44", 50", 56", 62", 68", 74"

Laminate color

Power cut out, No power cut out

Code	Price	H	W	D	Weight (lb.)	Volume (ft <sup>3</sup> )
left hand						
L-PCGE-3426-S1L	238	34	26	1	17.7	0.51
L-PCGE-3432-S1L	265	34	32	1	21.8	0.63
L-PCGE-3438-S1L	292	34	38	1	25.8	0.75
L-PCGE-3444-S1L	319	34	44	1	29.9	0.87
L-PCGE-3450-S1L	349	34	50	1	34.0	0.98
L-PCGE-3456-S1L	377	34	56	1	38.1	1.10
L-PCGE-4226-S1L	265	42	26	1	21.8	0.63
L-PCGE-4232-S1L	299	42	32	1	26.9	0.78
L-PCGE-4238-S1L	334	42	38	1	31.9	0.92
L-PCGE-4244-S1L	367	42	44	1	37.0	1.07
L-PCGE-4250-S1L	403	42	50	1	42.0	1.22
L-PCGE-4256-S1L	435	42	56	1	47.0	1.36
L-PCGE-5026-S1L	294	50	26	1	26.0	0.75
L-PCGE-5032-S1L	337	50	32	1	32.0	0.93
L-PCGE-5038-S1L	375	50	38	1	38.0	1.10
L-PCGE-5044-S1L	415	50	44	1	44.0	1.27
L-PCGE-5050-S1L	457	50	50	1	50.0	1.45
L-PCGE-5056-S1L	496	50	56	1	56.0	1.62
right hand						
L-PCGE-3426-S1R	238	34	26	1	17.7	0.51
L-PCGE-3432-S1R	265	34	32	1	21.8	0.63
L-PCGE-3438-S1R	292	34	38	1	25.8	0.75
L-PCGE-3444-S1R	319	34	44	1	29.9	0.87
L-PCGE-3450-S1R	349	34	50	1	34.0	0.98
L-PCGE-3456-S1R	377	34	56	1	38.1	1.10
L-PCGE-4226-S1R	265	42	26	1	21.8	0.63
L-PCGE-4232-S1R	299	42	32	1	26.9	0.78
L-PCGE-4238-S1R	334	42	38	1	31.9	0.92
L-PCGE-4244-S1R	367	42	44	1	37.0	1.07
L-PCGE-4250-S1R	403	42	50	1	42.0	1.22
L-PCGE-4256-S1R	435	42	56	1	47.0	1.36
L-PCGE-5026-S1R	294	50	26	1	26.0	0.75
L-PCGE-5032-S1R	337	50	32	1	32.0	0.93
L-PCGE-5038-S1R	375	50	38	1	38.0	1.10
L-PCGE-5044-S1R	415	50	44	1	44.0	1.27
L-PCGE-5050-S1R	457	50	50	1	50.0	1.45
L-PCGE-5056-S1R	496	50	56	1	56.0	1.62

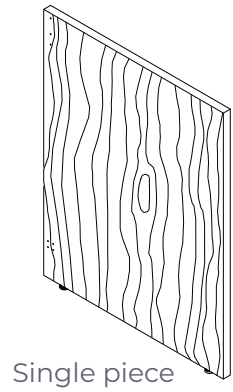

Double Span End  
Vertical Woodgrain  
Gallery Panel  
No Power Cutout

Single piece

**What's Included:**

X"-X": One (1) 1"thick laminate gallery panel, two (2) gallery panel top brackets

X"-X": Two (2) 1"thick laminate gallery panel, four (4) gallery panel top brackets

**How to Specify:**

Refer to laminate cards for laminate selections

Choose option for power cut out or no power cut out

**Notes:**

Gallery panels come with pre-drilled holes on each side and bottom notch for wire routing

Gallery panels must be used between two standard fabric or laminate panels

Gallery panels must be the same height or lower than the connecting standard fabric or laminate panel

**Options:**

Height: 34", 42", 50"

Width: 26", 32", 38", 44", 50", 56", 62", 68", 74"

Laminate color

Power cut out, no power cut out

Code	Price	H	W	D	Weight (lb.)	Volume (ft <sup>3</sup> )
single piece						
L-PYGE-3442-D1	311	34	42	1	28.6	0.83
L-PYGE-3450-D1	349	34	50	1	34.0	0.98
L-PYGE-4242-D1	358	42	42	1	28.6	1.02
L-PYGE-4250-D1	403	42	50	1	42.0	1.22
L-PYGE-5042-D1	403	50	42	1	28.6	1.22
L-PYGE-5050-D1	457	50	50	1	50.0	1.45
2 pieces						
L-PYGE-3462-D2	547	34	62	1	42.2	1.22
L-PYGE-3474-D2	604	34	74	1	50.3	1.46
L-PYGE-3486-D2	658	34	86	1	58.5	1.69
L-PYGE-3498-D2	715	34	98	1	66.6	1.93
L-PYGE-4262-D2	615	42	62	1	52.1	1.51
L-PYGE-4274-D2	685	42	74	1	62.2	1.80
L-PYGE-4286-D2	752	42	86	1	72.2	2.09
L-PYGE-4298-D2	821	42	98	1	82.3	2.38
L-PYGE-5062-D2	686	50	62	1	62.0	1.79
L-PYGE-5074-D2	765	50	74	1	74.0	2.14
L-PYGE-5086-D2	847	50	86	1	86.0	2.49
L-PYGE-5098-D2	928	50	98	1	98.0	2.84
L-PYGE-34110-D2	773	34	110	1	74.8	2.16
L-PYGE-42110-D2	890	42	110	1	92.4	2.67
L-PYGE-50110-D2	1008	50	110	1	110.0	3.18

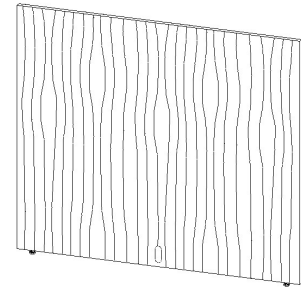

Single piece

Double Span End Vertical Woodgrain Gallery Panel with Power Cutout

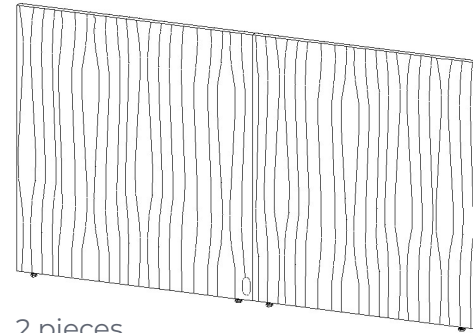

2 pieces

**What's Included:**

X"-X": One (1) 1"thick laminate gallery panel, two (2) gallery panel top brackets

X"-X": Two (2) 1"thick laminate gallery panel, four (4) gallery panel top brackets

**How to Specify:**

Refer to laminate cards for laminate selections

Choose option for power cut out or no power cut out

**Notes:**

Gallery panels come with pre-drilled holes on each side and bottom notch for wire routing

Gallery panels must be used between two standard fabric or laminate panels

Gallery panels must be the same height or lower than the connecting standard fabric or laminate panel

**Options:**

Height: 34", 42", 50"

Width: 26", 32", 38", 44", 50", 56", 62", 68", 74"

Laminate color

Power cut out, no power cut out

Code	Price	H	W	D	Weight (lb.)	Volume (ft <sup>3</sup> )
single piece						
L-PCGE-3442-D1	311	34	42	1	28.6	0.83
L-PCGE-3450-D1	349	34	50	1	34.0	0.98
L-PCGE-4242-D1	358	42	42	1	28.6	1.02
L-PCGE-4250-D1	403	42	50	1	42.0	1.22
L-PCGE-5042-D1	403	50	42	1	28.6	1.22
L-PCGE-5050-D1	457	50	50	1	50.0	1.45
2 pieces						
L-PCGE-3462-D2	547	34	62	1	42.2	1.22
L-PCGE-3474-D2	604	34	74	1	50.3	1.46
L-PCGE-3486-D2	658	34	86	1	58.5	1.69
L-PCGE-3498-D2	715	34	98	1	66.6	1.93
L-PCGE-34110-D2	773	34	110	1	52.1	1.51
L-PCGE-4262-D2	615	42	62	1	62.2	1.80
L-PCGE-4274-D2	685	42	74	1	72.2	2.09
L-PCGE-4286-D2	752	42	86	1	82.3	2.38
L-PCGE-4298-D2	821	42	98	1	62.0	1.79
L-PCGE-42110-D2	890	42	110	1	74.0	2.14
L-PCGE-5062-D2	686	50	62	1	86.0	2.49
L-PCGE-5074-D2	765	50	74	1	98.0	2.84
L-PCGE-5086-D2	847	50	86	1	74.8	2.16
L-PCGE-5098-D2	928	50	98	1	92.4	2.67
L-PCGE-50110-D2	1008	50	110	1	110.0	3.18

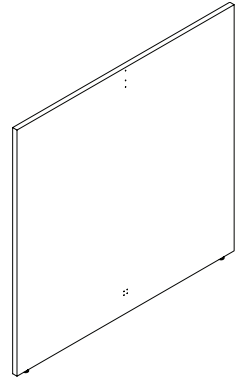

Single Span Middle  
Solid Gallery Panel

**What's Included:**

One (1) 1"thick laminate gallery panel,  
two (2) gallery panel top brackets

**How to Specify:**

Refer to laminate cards for laminate selections

**Options:**

Height: 34", 42", 50"

Width: 26", 32", 38", 44", 50", 56", 62", 68", 74"

Laminate color

**Notes:**

Gallery panels come with pre-drilled holes on each side and bottom notch for wire routing

Gallery panels must be used between two standard fabric or laminate panels

Gallery panels must be the same height or lower than the connecting standard fabric or laminate panel

Code	Price	H	W	D	Weight (lb.)	Volume (ft <sup>3</sup> )
L-PYSM-3426-S1	276	34	26	1	17.7	0.51
L-PYSM-3432-S1	305	34	32	1	21.8	0.63
L-PYSM-3438-S1	333	34	38	1	25.8	0.75
L-PYSM-3444-S1	360	34	44	1	29.9	0.87
L-PYSM-3450-S1	388	34	50	1	34.0	0.98
L-PYSM-3456-S1	415	34	56	1	38.1	1.10
L-PYSM-3462-S1	446	34	62	1	42.2	1.22
L-PYSM-3468-S1	472	34	68	1	46.2	1.34
L-PYSM-3474-S1	499	34	74	1	50.3	1.46
L-PYSM-4226-S1	305	42	26	1	21.8	0.63
L-PYSM-4232-S1	340	42	32	1	26.9	0.78
L-PYSM-4238-S1	374	42	38	1	31.9	0.92
L-PYSM-4244-S1	409	42	44	1	37.0	1.07
L-PYSM-4250-S1	444	42	50	1	42.0	1.22
L-PYSM-4256-S1	474	42	56	1	47.0	1.36
L-PYSM-4262-S1	510	42	62	1	52.1	1.51
L-PYSM-4268-S1	545	42	68	1	57.1	1.65
L-PYSM-4274-S1	582	42	74	1	62.2	1.80
L-PYSM-5026-S1	337	50	26	1	26.0	0.75
L-PYSM-5032-S1	375	50	32	1	32.0	0.93
L-PYSM-5038-S1	414	50	38	1	38.0	1.10
L-PYSM-5044-S1	457	50	44	1	44.0	1.27
L-PYSM-5050-S1	495	50	50	1	50.0	1.45
L-PYSM-5056-S1	537	50	56	1	56.0	1.62
L-PYSM-5062-S1	578	50	62	1	62.0	1.79
L-PYSM-5068-S1	615	50	68	1	68.0	1.97
L-PYSM-5074-S1	657	50	74	1	74.0	2.14

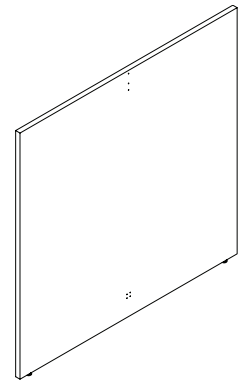

Single piece

Double Span Middle  
Solid Gallery Panel

**What's Included:**

X"-X": One (1) 1"thick laminate gallery panel, two (2) gallery panel top brackets

X"-X": Two (2) 1"thick laminate gallery panel, four (4) gallery panel top brackets

**How to Specify:**

Refer to laminate cards for laminate selections

**Notes:**

Gallery panels come with pre-drilled holes on each side and bottom notch for wire routing

Gallery panels must be used between two standard fabric or laminate panels

Gallery panels must be the same height or lower than the connecting standard fabric or laminate panel

**Options:**

Height: 34", 42", 50"

Width: 26", 32", 38", 44", 50", 56", 62", 68", 74"

Laminate color

Power cut out, no power cut out

Code	Price	H	W	D	Weight (lb.)	Volume (ft <sup>3</sup> )
single piece						
L-PYSM-3442-D1	350	34	42	1	28.6	0.83
L-PYSM-3450-D1	388	34	50	1	34.0	0.98
L-PYSM-3462-D1	446	34	62	1	42.2	1.22
L-PYSM-3474-D1	499	34	74	1	50.3	1.46
L-PYSM-3486-D1	557	34	86	1	58.5	1.69
L-PYSM-4242-D1	397	42	42	1	35.3	1.02
L-PYSM-4250-D1	444	42	50	1	42.0	1.22
L-PYSM-4262-D1	510	42	62	1	52.1	1.51
L-PYSM-4274-D1	582	42	74	1	62.2	1.80
L-PYSM-4286-D1	649	42	86	1	72.2	2.09
L-PYSM-5042-D1	444	50	42	1	42.0	1.22
L-PYSM-5050-D1	495	50	50	1	50.0	1.45
L-PYSM-5062-D1	578	50	62	1	62.0	1.79
L-PYSM-5074-D1	657	50	74	1	74.0	2.14
L-PYSM-5086-D1	738	50	86	1	86.0	2.49
2 pieces						
L-PYSM-3498-D2	715	34	98	1	66.6	1.93
L-PYSM-4298-D2	821	42	98	1	82.3	2.38
L-PYSM-5098-D2	928	50	98	1	98.0	2.84
L-PYSM-34110-D2	773	34	110	1	74.8	2.16
L-PYSM-34122-D2	829	34	122	1	83.0	2.40
L-PYSM-34134-D2	883	34	134	1	91.1	2.64
L-PYSM-34146-D2	941	34	146	1	99.3	2.87
L-PYSM-42110-D2	890	42	110	1	92.4	2.67
L-PYSM-42122-D2	957	42	122	1	102.5	2.97
L-PYSM-42134-D2	1027	42	134	1	112.6	3.26
L-PYSM-42146-D2	1097	42	146	1	122.6	3.55
L-PYSM-50110-D2	1008	50	110	1	110.0	3.18
L-PYSM-50122-D2	1089	50	122	1	122.0	3.53
L-PYSM-50134-D2	1172	50	134	1	134.0	3.88
L-PYSM-50146-D2	1251	50	146	1	146.0	4.22



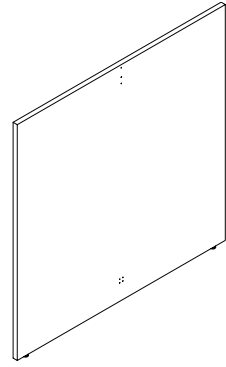

Single Span End Solid Gallery Panel

**What's Included:**

One (1) 1"thick laminate gallery panel, two (2) gallery panel top brackets

**How to Specify:**

Refer to laminate cards for laminate selections

Choose option for power cut out or no power cut out

**Options:**

Height: 34", 42", 50"

Width: 26", 32", 38", 44", 50", 56", 62", 68", 74"

Laminate color

Power cut out, No power cut out

Code	Price	H	W	D	Weight (lb.)	Volume (ft <sup>3</sup> )
left hand						
L-PYSE-3426-S1L	238	34	26	1	17.7	0.51
L-PYSE-3432-S1L	265	34	32	1	21.8	0.63
L-PYSE-3438-S1L	292	34	38	1	25.8	0.75
L-PYSE-3444-S1L	319	34	44	1	29.9	0.87
L-PYSE-3450-S1L	349	34	50	1	34.0	0.98
L-PYSE-3456-S1L	377	34	56	1	38.1	1.10
L-PYSE-3462-S1L	406	34	62	1	42.2	1.22
L-PYSE-3468-S1L	432	34	68	1	46.2	1.34
L-PYSE-3474-S1L	461	34	74	1	50.3	1.46
L-PYSE-4226-S1L	265	42	26	1	21.8	0.63
L-PYSE-4232-S1L	299	42	32	1	26.9	0.78
L-PYSE-4238-S1L	334	42	38	1	31.9	0.92
L-PYSE-4244-S1L	367	42	44	1	37.0	1.07
L-PYSE-4250-S1L	403	42	50	1	42.0	1.22
L-PYSE-4256-S1L	435	42	56	1	47.0	1.36

Code	Price	H	W	D	Weight (lb.)	Volume (ft <sup>3</sup> )
L-PYSE-4262-S1L	470	42	62	1	52.1	1.51
L-PYSE-4268-S1L	506	42	68	1	57.1	1.65
L-PYSE-4274-S1L	541	42	74	1	62.2	1.80
L-PYSE-5026-S1L	294	50	26	1	26.0	0.75
L-PYSE-5032-S1L	337	50	32	1	32.0	0.93
L-PYSE-5038-S1L	375	50	38	1	38.0	1.10
L-PYSE-5044-S1L	415	50	44	1	44.0	1.27
L-PYSE-5050-S1L	457	50	50	1	50.0	1.45
L-PYSE-5056-S1L	496	50	56	1	56.0	1.62
L-PYSE-5062-S1L	537	50	62	1	62.0	1.79
L-PYSE-5068-S1L	578	50	68	1	68.0	1.97
L-PYSE-5074-S1L	616	50	74	1	74.0	2.14
right hand						
L-PYSE-3426-S1R	238	34	26	1	17.7	0.51
L-PYSE-3432-S1R	265	34	32	1	21.8	0.63
L-PYSE-3438-S1R	292	34	38	1	25.8	0.75
L-PYSE-3444-S1R	319	34	44	1	29.9	0.87
L-PYSE-3450-S1R	349	34	50	1	34.0	0.98
L-PYSE-3456-S1R	377	34	56	1	38.1	1.10
L-PYSE-3462-S1R	406	34	62	1	42.2	1.22
L-PYSE-3468-S1R	432	34	68	1	46.2	1.34
L-PYSE-3474-S1R	461	34	74	1	50.3	1.46
L-PYSE-4226-S1R	265	42	26	1	21.8	0.63
L-PYSE-4232-S1R	299	42	32	1	26.9	0.78
L-PYSE-4238-S1R	334	42	38	1	31.9	0.92
L-PYSE-4244-S1R	367	42	44	1	37.0	1.07
L-PYSE-4250-S1R	403	42	50	1	42.0	1.22
L-PYSE-4256-S1R	435	42	56	1	47.0	1.36
L-PYSE-4262-S1R	470	42	62	1	52.1	1.51
L-PYSE-4268-S1R	506	42	68	1	57.1	1.65
L-PYSE-4274-S1R	541	42	74	1	62.2	1.80
L-PYSE-5026-S1R	294	50	26	1	26.0	0.75
L-PYSE-5032-S1R	337	50	32	1	32.0	0.93
L-PYSE-5038-S1R	375	50	38	1	38.0	1.10
L-PYSE-5044-S1R	415	50	44	1	44.0	1.27
L-PYSE-5050-S1R	457	50	50	1	50.0	1.45
L-PYSE-5056-S1R	496	50	56	1	56.0	1.62
L-PYSE-5062-S1R	537	50	62	1	62.0	1.79
L-PYSE-5068-S1R	578	50	68	1	68.0	1.97
L-PYSE-5074-S1R	616	50	74	1	74.0	2.14

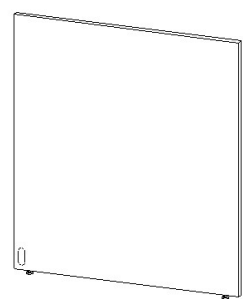

Single Span End Solid Gallery Panel with Power Cutout

**What's Included:**

One (1) 1"thick laminate gallery panel, two (2) gallery panel top brackets

**How to Specify:**

Refer to laminate cards for laminate selections

Choose option for power cut out or no power cut out

**Options:**

Height: 34", 42", 50"

Width: 26", 32", 38", 44", 50", 56", 62", 68", 74"

Laminate color

Power cut out, No power cut out

**Notes:**

Gallery panels come with pre-drilled holes on each side and bottom notch for wire routing

Gallery panels must be used between two standard fabric or laminate panels

Gallery panels must be the same height or lower than the connecting standard fabric or laminate panel

Code	Price	H	W	D	Weight (lb.)	Volume (ft <sup>3</sup> )
left hand						
L-PCSE-3426-S1L	238	34	26	1	17.7	0.51
L-PCSE-3432-S1L	265	34	32	1	21.8	0.63
L-PCSE-3438-S1L	292	34	38	1	25.8	0.75
L-PCSE-3444-S1L	319	34	44	1	29.9	0.87
L-PCSE-3450-S1L	349	34	50	1	34.0	0.98
L-PCSE-3456-S1L	377	34	56	1	38.1	1.10
L-PCSE-3462-S1L	406	34	62	1	42.2	1.22
L-PCSE-3468-S1L	432	34	68	1	46.2	1.34
L-PCSE-3474-S1L	461	34	74	1	50.3	1.46
L-PCSE-4226-S1L	265	42	26	1	21.8	0.63
L-PCSE-4232-S1L	299	42	32	1	26.9	0.78
L-PCSE-4238-S1L	334	42	38	1	31.9	0.92
L-PCSE-4244-S1L	367	42	44	1	37.0	1.07
L-PCSE-4250-S1L	403	42	50	1	42.0	1.22
L-PCSE-4256-S1L	435	42	56	1	47.0	1.36

Code	Price	H	W	D	Weight (lb.)	Volume (ft <sup>3</sup> )
L-PCSE-4262-S1L	470	42	62	1	52.1	1.51
L-PCSE-4268-S1L	506	42	68	1	57.1	1.65
L-PCSE-4274-S1L	541	42	74	1	62.2	1.80
L-PCSE-5026-S1L	294	50	26	1	26.0	0.75
L-PCSE-5032-S1L	337	50	32	1	32.0	0.93
L-PCSE-5038-S1L	375	50	38	1	38.0	1.10
L-PCSE-5044-S1L	415	50	44	1	44.0	1.27
L-PCSE-5050-S1L	457	50	50	1	50.0	1.45
L-PCSE-5056-S1L	496	50	56	1	56.0	1.62
L-PCSE-5062-S1L	537	50	62	1	62.0	1.79
L-PCSE-5068-S1L	578	50	68	1	68.0	1.97
L-PCSE-5074-S1L	616	50	74	1	74.0	2.14
right hand						
L-PCSE-3426-S1R	238	34	26	1	17.7	0.51
L-PCSE-3432-S1R	265	34	32	1	21.8	0.63
L-PCSE-3438-S1R	292	34	38	1	25.8	0.75
L-PCSE-3444-S1R	319	34	44	1	29.9	0.87
L-PCSE-3450-S1R	349	34	50	1	34.0	0.98
L-PCSE-3456-S1R	377	34	56	1	38.1	1.10
L-PCSE-3462-S1R	406	34	62	1	42.2	1.22
L-PCSE-3468-S1R	432	34	68	1	46.2	1.34
L-PCSE-3474-S1R	461	34	74	1	50.3	1.46
L-PCSE-4226-S1R	265	42	26	1	21.8	0.63
L-PCSE-4232-S1R	299	42	32	1	26.9	0.78
L-PCSE-4238-S1R	334	42	38	1	31.9	0.92
L-PCSE-4244-S1R	367	42	44	1	37.0	1.07
L-PCSE-4250-S1R	403	42	50	1	42.0	1.22
L-PCSE-4256-S1R	435	42	56	1	47.0	1.36
L-PCSE-4262-S1R	470	42	62	1	52.1	1.51
L-PCSE-4268-S1R	506	42	68	1	57.1	1.65
L-PCSE-4274-S1R	541	42	74	1	62.2	1.80
L-PCSE-5026-S1R	294	50	26	1	26.0	0.75
L-PCSE-5032-S1R	337	50	32	1	32.0	0.93
L-PCSE-5038-S1R	375	50	38	1	38.0	1.10
L-PCSE-5044-S1R	415	50	44	1	44.0	1.27
L-PCSE-5050-S1R	457	50	50	1	50.0	1.45
L-PCSE-5056-S1R	496	50	56	1	56.0	1.62
L-PCSE-5062-S1R	537	50	62	1	62.0	1.79
L-PCSE-5068-S1R	578	50	68	1	68.0	1.97
L-PCSE-5074-S1R	616	50	74	1	74.0	2.14

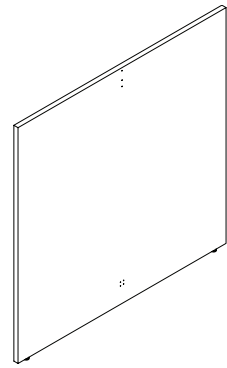

Double Span End  
Solid Gallery Panel  
No Power Cutout

Single piece

**What's Included:**

X"-X": One (1) 1"thick laminate gallery panel, two (2) gallery panel top brackets

X"-X": Two (2) 1"thick laminate gallery panel, four (4) gallery panel top brackets

**How to Specify:**

Refer to laminate cards for laminate selections

Choose option for power cut out or no power cut out

**Notes:**

Gallery panels come with pre-drilled holes on each side and bottom notch for wire routing

Gallery panels must be used between two standard fabric or laminate panels

Gallery panels must be the same height or lower than the connecting standard fabric or laminate panel

**Options:**

Height: 34", 42", 50"

Width: 26", 32", 38", 44", 50", 56", 62", 68", 74"

Laminate color

Power cut out, no power cut out

Code	Price	H	W	D	Weight (lb.)	Volume (ft <sup>3</sup> )
single piece						
L-PYSE-3442-D1	311	34	42	1	28.6	0.83
L-PYSE-3450-D1	349	34	50	1	34.0	0.98
L-PYSE-3462-D1	406	34	62	1	42.2	1.22
L-PYSE-3474-D1	461	34	74	1	50.3	1.46
L-PYSE-3486-D1	517	34	86	1	58.5	1.69
L-PYSE-4242-D1	358	42	42	1	35.3	1.02
L-PYSE-4250-D1	403	42	50	1	42.0	1.22
L-PYSE-4262-D1	470	42	62	1	52.1	1.51
L-PYSE-4274-D1	541	42	74	1	62.2	1.80
L-PYSE-4286-D1	608	42	86	1	72.2	2.09
L-PYSE-5042-D1	403	50	42	1	42.0	1.22
L-PYSE-5050-D1	457	50	50	1	50.0	1.45
L-PYSE-5062-D1	537	50	62	1	62.0	1.79
L-PYSE-5074-D1	616	50	74	1	74.0	2.14
L-PYSE-5086-D1	699	50	86	1	86.0	2.49
2 pieces						
L-PYSE-3498-D2	715	34	98	1	66.6	1.93
L-PYSE-4298-D2	821	42	98	1	82.3	2.38
L-PYSE-5098-D2	928	50	98	1	98.0	2.84
L-PYSE-34110-D2	773	34	110	1	74.8	2.16
L-PYSE-34122-D2	829	34	122	1	83.0	2.40
L-PYSE-34134-D2	883	34	134	1	91.1	2.64
L-PYSE-34146-D2	941	34	146	1	99.3	2.87
L-PYSE-42110-D2	890	42	110	1	92.4	2.67
L-PYSE-42122-D2	957	42	122	1	102.5	2.97
L-PYSE-42134-D2	1027	42	134	1	112.6	3.26
L-PYSE-42146-D2	1097	42	146	1	122.6	3.55
L-PYSE-50110-D2	1008	50	110	1	110.0	3.18
L-PYSE-50122-D2	1089	50	122	1	122.0	3.53
L-PYSE-50134-D2	1172	50	134	1	134.0	3.88
L-PYSE-50146-D2	1251	50	146	1	146.0	4.22

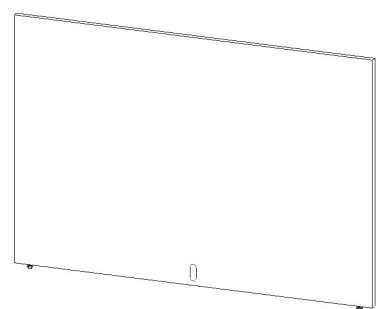

Single piece

Double Span End Solid Gallery Panel with Power Cutout

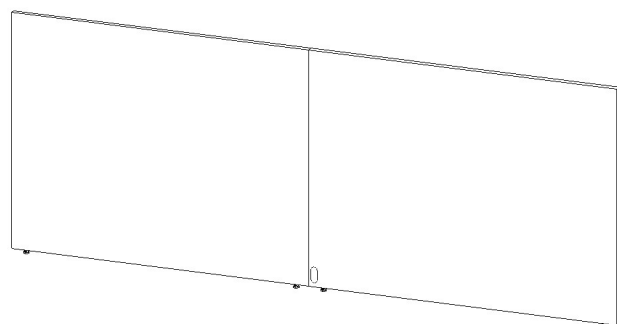

2 pieces

**What's Included:**

X"-X": One (1) 1"thick laminate gallery panel, two (2) gallery panel top brackets

X"-X": Two (2) 1"thick laminate gallery panel, four (4) gallery panel top brackets

**How to Specify:**

Refer to laminate cards for laminate selections

Choose option for power cut out or no power cut out

**Notes:**

Gallery panels come with pre-drilled holes on each side and bottom notch for wire routing

Gallery panels must be used between two standard fabric or laminate panels

Gallery panels must be the same height or lower than the connecting standard fabric or laminate panel

**Options:**

Height: 34", 42", 50"

Width: 26", 32", 38", 44", 50", 56", 62", 68", 74"

Laminate color

Power cut out, no power cut out

Code	Price	H	W	D	Weight (lb.)	Volume (ft <sup>3</sup> )
single piece						
L-PCSE-3442-D1	311	34	42	1	28.6	0.80
L-PCSE-3450-D1	349	34	50	1	34.0	1.00
L-PCSE-3462-D1	406	34	62	1	42.2	1.20
L-PCSE-3474-D1	461	34	74	1	50.3	1.50
L-PCSE-3486-D1	517	34	86	1	58.5	1.70
L-PCSE-4242-D1	358	42	42	1	35.3	1.00
L-PCSE-4250-D1	403	42	50	1	42.0	1.20
L-PCSE-4262-D1	470	42	62	1	52.1	1.50
L-PCSE-4274-D1	541	42	74	1	62.2	1.80
L-PCSE-4286-D1	608	42	86	1	72.2	2.10
L-PCSE-5042-D1	403	50	42	1	42.0	1.20
L-PCSE-5050-D1	457	50	50	1	50.0	1.40
L-PCSE-5062-D1	537	50	62	1	62.0	1.80
L-PCSE-5074-D1	616	50	74	1	74.0	2.10
L-PCSE-5086-D1	699	50	86	1	86.0	2.50
2 pieces						
L-PCSE-3498-D2	715	34	98	1	66.6	1.90
L-PCSE-34110-D2	773	34	110	1	82.3	2.40
L-PCSE-34122-D2	829	34	122	1	98.0	2.80
L-PCSE-34134-D2	883	34	134	1	74.8	2.20
L-PCSE-34146-D2	941	34	146	1	83.0	2.40
L-PCSE-4298-D2	821	42	98	1	91.1	2.60
L-PCSE-42110-D2	890	42	110	1	99.3	2.90
L-PCSE-42122-D2	957	42	122	1	92.4	2.70
L-PCSE-42134-D2	1027	42	134	1	102.5	3.00
L-PCSE-42146-D2	1097	42	146	1	112.6	3.30
L-PCSE-5098-D2	928	50	98	1	122.6	3.50
L-PCSE-50110-D2	1008	50	110	1	110.0	3.20
L-PCSE-50122-D2	1089	50	122	1	122.0	3.50
L-PCSE-50134-D2	1172	50	134	1	134.0	3.90
L-PCSE-50146-D2	1251	50	146	1	146.0	4.20

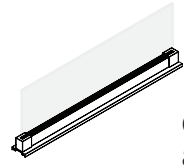

Glass Frameless Blade for Standard and Elevated Panels

Double span panel top mounted privacy screen can be placed across the width of two equal sized panels

**What's Included:**

One (1) tempered glass piece, One (1) channel extrusion, Two (2) end caps, One (1) top trim

**How to Specify:**

Refer to metal finish card for metal finish options

**Notes:**

One (1) glass piece can span the width of one or two panels up to 72"W

Glass is tempered

**Options:**

Height: 8", 16", 20"

Width: 24", 30", 36", 42", 48", 54", 60", 66", 72"

Clear, Frosted

Code	Price	H	W	D	Weight (lb.)	Volume (ft <sup>3</sup> )
Glass screen - Clear						
L-VG-P-0824-C	459	8	24	0.75		
L-VG-P-0830-C	485	8	30	0.75		
L-VG-P-0836-C	531	8	36	0.75		
L-VG-P-0842-C	568	8	42	0.75		
L-VG-P-0848-C	573	8	48	0.75		
L-VG-P-0854-C	618	8	54	0.75		
L-VG-P-0860-C	628	8	60	0.75		
L-VG-P-0866-C	674	8	66	0.75		
L-VG-P-0872-C	680	8	72	0.75		
L-VG-P-1624-C	498	16	24	0.75		
L-VG-P-1630-C	529	16	30	0.75		
L-VG-P-1636-C	578	16	36	0.75		
L-VG-P-1642-C	617	16	42	0.75		
L-VG-P-1648-C	625	16	48	0.75		
L-VG-P-1654-C	674	16	54	0.75		
L-VG-P-1660-C	678	16	60	0.75		

Code	Price	H	W	D	Weight (lb.)	Volume (ft <sup>3</sup> )
L-VG-P-1666-C	711	16	66	0.75		
L-VG-P-1672-C	739	16	72	0.75		
L-VG-P-2024-C	532	20	24	0.75		
L-VG-P-2030-C	571	20	30	0.75		
L-VG-P-2036-C	644	20	36	0.75		
L-VG-P-2042-C	685	20	42	0.75		
L-VG-P-2048-C	689	20	48	0.75		
L-VG-P-2054-C	739	20	54	0.75		
L-VG-P-2060-C	748	20	60	0.75		
L-VG-P-2066-C	787	20	66	0.75		
L-VG-P-2072-C	801	20	72	0.75		

Code	Price	H	W	D	Weight (lb.)	Volume (ft <sup>3</sup> )
Glass screen - Frosted						
L-VG-P-0824-F	595	8	24	0.75		
L-VG-P-0830-F	630	8	30	0.75		
L-VG-P-0836-F	689	8	36	0.75		
L-VG-P-0842-F	739	8	42	0.75		
L-VG-P-0848-F	746	8	48	0.75		
L-VG-P-0854-F	805	8	54	0.75		
L-VG-P-0860-F	811	8	60	0.75		
L-VG-P-0866-F	867	8	66	0.75		
L-VG-P-0872-F	883	8	72	0.75		
L-VG-P-1624-F	649	16	24	0.75		
L-VG-P-1630-F	686	16	30	0.75		
L-VG-P-1636-F	750	16	36	0.75		
L-VG-P-1642-F	803	16	42	0.75		
L-VG-P-1648-F	811	16	48	0.75		
L-VG-P-1654-F	876	16	54	0.75		
L-VG-P-1660-F	881	16	60	0.75		
L-VG-P-1666-F	942	16	66	0.75		
L-VG-P-1672-F	960	16	72	0.75		
L-VG-P-2024-F	690	20	24	0.75		
L-VG-P-2030-F	743	20	30	0.75		
L-VG-P-2036-F	836	20	36	0.75		
L-VG-P-2042-F	890	20	42	0.75		
L-VG-P-2048-F	895	20	48	0.75		
L-VG-P-2054-F	960	20	54	0.75		
L-VG-P-2060-F	972	20	60	0.75		
L-VG-P-2066-F	1024	20	66	0.75		
L-VG-P-2072-F	1042	20	72	0.75		

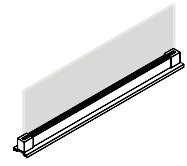

Acrylic Frameless Blade for Standard and Elevated Panels

**What's Included:**

One (1) acrylic piece, One (1) channel extrusion, Two (2) end caps, One (1) top trim

**How to Specify:**

Refer to metal finish card for metal finish options

**Options:**

Height: 8", 16"

Width: 24", 30", 36", 42", 48", 54", 60", 66", 72"

Clear, Frosted

**Notes:**

One (1) acrylic piece can span the width of one or two panels up to 72"W

Code	Price	H	W	D	Weight (lb.)	Volume (ft <sup>3</sup> )
Acrylic screen - Frosted						
L-VA-P-0824-F	595	8	24	0.75		
L-VA-P-0830-F	630	8	30	0.75		
L-VA-P-0836-F	689	8	36	0.75		
L-VA-P-0842-F	739	8	42	0.75		
L-VA-P-0848-F	746	8	48	0.75		
L-VA-P-0854-F	805	8	54	0.75		
L-VA-P-0860-F	811	8	60	0.75		
L-VA-P-0866-F	867	8	66	0.75		
L-VA-P-0872-F	883	8	72	0.75		
L-VA-P-1624-F	649	16	24	0.75		
L-VA-P-1630-F	686	16	30	0.75		
L-VA-P-1636-F	750	16	36	0.75		
L-VA-P-1642-F	803	16	42	0.75		
L-VA-P-1648-F	811	16	48	0.75		
L-VA-P-1654-F	876	16	54	0.75		
L-VA-P-1660-F	881	16	60	0.75		
L-VA-P-1666-F	942	16	66	0.75		
L-VA-P-1672-F	960	16	72	0.75		

Code	Price	H	W	D	Weight (lb.)	Volume (ft <sup>3</sup> )
Acrylic screen - Clear						
L-VA-P-0824-C	459	8	24	0.75		
L-VA-P-0830-C	485	8	30	0.75		
L-VA-P-0836-C	531	8	36	0.75		
L-VA-P-0842-C	568	8	42	0.75		
L-VA-P-0848-C	573	8	48	0.75		
L-VA-P-0854-C	618	8	54	0.75		
L-VA-P-0860-C	625	8	60	0.75		
L-VA-P-0866-C	674	16	66	0.75		
L-VA-P-0872-C	680	16	72	0.75		
L-VA-P-1624-C	498	16	24	0.75		
L-VA-P-1630-C	529	16	30	0.75		
L-VA-P-1636-C	578	16	36	0.75		
L-VA-P-1642-C	617	16	42	0.75		
L-VA-P-1648-C	625	16	48	0.75		
L-VA-P-1654-C	674	16	54	0.75		
L-VA-P-1660-C	678	16	60	0.75		
L-VA-P-1666-C	711	16	66	0.75		
L-VA-P-1672-C	739	16	72	0.75		

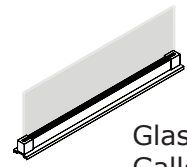

Glass Frameless Blade for Gallery Panels

**What's Included:**

One (1) tempered glass piece, One (1) accessory rail channel extrusion, Two (2) end caps

**How to Specify:**

Refer to metal finish card for metal finish options

**Notes:**

One (1) glass piece can span the width of one or two panels up to 72"W

Glass is tempered

Accessory rail channel extrusion can accommodate all Tayco accessories except for the paper sorter

**Options:**

Height: 8", 16"

Width: 24", 30", 36", 42", 48", 54", 60"

Clear, Frosted

Code	Price	H	W	D	Weight (lb.)	Volume (ft <sup>3</sup> )
Glass screen - Frosted						
L-VG-Y-0824-F	677	8	24	0.75	5.0	0.08
L-VG-Y-0830-F	708	8	30	0.75	6.0	0.10
L-VG-Y-0836-F	767	8	36	0.75	7.0	0.13
L-VG-Y-0842-F	818	8	42	0.75	8.0	0.15
L-VG-Y-0848-F	823	8	48	0.75	10.0	0.17
L-VG-Y-0854-F	881	8	54	0.75	11.0	0.19
L-VG-Y-0860-F	886	8	60	0.75	12.0	0.21
L-VG-Y-1624-F	726	16	24	0.75	10.0	0.17
L-VG-Y-1630-F	765	16	30	0.75	12.0	0.21
L-VG-Y-1636-F	826	16	36	0.75	14.0	0.25
L-VG-Y-1642-F	880	16	42	0.75	17.0	0.29
L-VG-Y-1648-F	886	16	48	0.75	19.0	0.33
L-VG-Y-1654-F	950	16	54	0.75	22.0	0.38
L-VG-Y-1660-F	956	16	60	0.75	24.0	0.42

Code	Price	H	W	D	Weight (lb.)	Volume (ft <sup>3</sup> )
Glass screen - Clear						
L-VG-Y-0824-C	585	8	30	0.75	6.0	0.10
L-VG-Y-0830-C	617	8	36	0.75	7.0	0.13
L-VG-Y-0836-C	677	8	42	0.75	8.0	0.15
L-VG-Y-0842-C	727	8	48	0.75	10.0	0.17
L-VG-Y-0848-C	733	8	54	0.75	11.0	0.19
L-VG-Y-0854-C	790	8	60	0.75	12.0	0.21
L-VG-Y-0860-C	795	16	24	0.75	10.0	0.17
L-VG-Y-1624-C	636	16	30	0.75	12.0	0.21
L-VG-Y-1630-C	674	16	36	0.75	14.0	0.25
L-VG-Y-1636-C	736	16	42	0.75	17.0	0.29
L-VG-Y-1642-C	789	16	48	0.75	19.0	0.33
L-VG-Y-1648-C	795	16	54	0.75	22.0	0.38
L-VG-Y-1654-C	859	16	60	0.75	24.0	0.42
L-VG-Y-1660-C	866	16	60	0.75	24.0	0.42

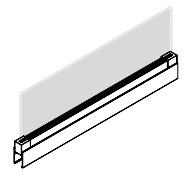

Acrylic Frameless Blade for Gallery Panels

**What's Included:**

One (1) acrylic piece, One (1) accessory rail channel extrusion, Two (2) end caps

**How to Specify:**

Refer to metal finish card for metal finish options

**Notes:**

One (1) acrylic piece can span the width of one or two panels up to 72"W

Accessory rail channel extrusion can accommodate all Tayco accessories except for the paper sorter

**Options:**

Height:	8", 16"
Width:	24", 30", 36", 42", 48", 54", 60"
Clear, Frosted	

Code	Price	H	W	D	Weight (lb.)	Volume (ft <sup>3</sup> )
Acrylic screen - Frosted						
L-VA-Y-0824-F	677	8	24	0.75	4.0	0.08
L-VA-Y-0830-F	708	8	30	0.75	5.0	0.10
L-VA-Y-0836-F	767	8	36	0.75	5.0	0.13
L-VA-Y-0842-F	818	8	42	0.75	6.0	0.15
L-VA-Y-0848-F	823	8	48	0.75	7.0	0.17
L-VA-Y-0854-F	881	8	54	0.75	8.0	0.19
L-VA-Y-0860-F	886	8	60	0.75	9.0	0.21
L-VA-Y-1624-F	726	16	24	0.75	7.0	0.17
L-VA-Y-1630-F	765	16	30	0.75	9.0	0.21
L-VA-Y-1636-F	826	16	36	0.75	11.0	0.25
L-VA-Y-1642-F	880	16	42	0.75	13.0	0.29
L-VA-Y-1648-F	886	16	48	0.75	14.0	0.33
L-VA-Y-1654-F	950	16	54	0.75	16.0	0.38
L-VA-Y-1660-F	956	16	60	0.75	18.0	0.42

Code	Price	H	W	D	Weight (lb.)	Volume (ft <sup>3</sup> )
Acrylic screen - Clear						
L-VA-Y-0824-C	585	8	24	0.75	4.0	0.08
L-VA-Y-0830-C	617	8	30	0.75	5.0	0.10
L-VA-Y-0836-C	677	8	36	0.75	5.0	0.13
L-VA-Y-0842-C	727	8	42	0.75	6.0	0.15
L-VA-Y-0848-C	733	8	48	0.75	7.0	0.17
L-VA-Y-0854-C	790	8	54	0.75	8.0	0.19
L-VA-Y-0860-C	795	8	60	0.75	9.0	0.21
L-VA-Y-1624-C	636	16	24	0.75	7.0	0.17
L-VA-Y-1630-C	674	16	30	0.75	9.0	0.21
L-VA-Y-1636-C	736	16	36	0.75	11.0	0.25
L-VA-Y-1642-C	789	16	42	0.75	13.0	0.29
L-VA-Y-1648-C	795	16	48	0.75	14.0	0.33
L-VA-Y-1654-C	859	16	54	0.75	16.0	0.38
L-VA-Y-1660-C	866	16	60	0.75	18.0	0.42



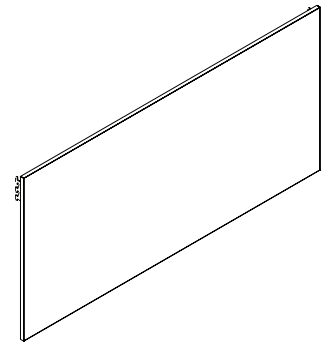

Panel Mounted Whiteboard

**What's Included:**

One (1) whiteboard, Two (2) slotted channel brackets

**How to Specify:**

Specify width of whiteboard to match the width of the panel  
Choose White, Black, Silver, Charcoal for bracket color

**Options:**

Height: 15"

Width: 24", 30", 36", 42", 48", 54", 60"

**Notes:**

Panel Mounted Whiteboard is compatible with fabric and laminate panels only

Code	Price	H	W	D	Weight (lb.)	Volume (ft <sup>3</sup> )
L-AWPO-1524	252	15	24	0.75	3.7	
L-AWPO-1530	283	15	30	0.75	4.9	
L-AWPO-1536	314	15	36	0.75	6.2	
L-AWPO-1542	343	15	42	0.75	7.5	
L-AWPO-1548	375	15	48	0.75	8.7	
L-AWPO-1554	407	15	54	0.75	10.0	
L-AWPO-1560	435	15	60	0.75	11.2	

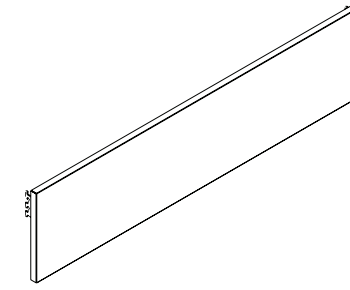

Panel Mounted Tackboard

**What's Included:**

One (1) tackboard, Two (2) slotted channel brackets

**How to Specify:**

Specify width of tackboard to match the width of the panel  
Refer to panel fabric cards for fabric selections  
Choose White, Black, Silver, Charcoal for bracket color

**Options:**

Height: 7", 15"

Width: 24", 30", 36", 42", 48", 54", 60"

**Notes:**

Panel Mounted Tackboard is compatible with fabric and laminate panels only

Code	Price	H	W	D	Weight (lb.)	Volume (ft <sup>3</sup> )
L-ATPO-0724	160	7	24	0.75	1.9	
L-ATPO-0730	168	7	30	0.75	2.4	
L-ATPO-0736	178	7	36	0.75	3.1	
L-ATPO-0742	185	7	42	0.75	3.7	
L-ATPO-0748	191	7	48	0.75	4.4	
L-ATPO-0754	198	7	54	0.75	5.0	
L-ATPO-0760	205	7	60	0.75	5.6	
L-ATPO-1524	198	15	24	0.75	4.0	
L-ATPO-1530	216	15	30	0.75	4.9	
L-ATPO-1536	229	15	36	0.75	6.2	
L-ATPO-1542	244	15	42	0.75	7.5	
L-ATPO-1548	262	15	48	0.75	8.7	
L-ATPO-1554	276	15	54	0.75	10.0	
L-ATPO-1560	290	15	60	0.75	11.2	

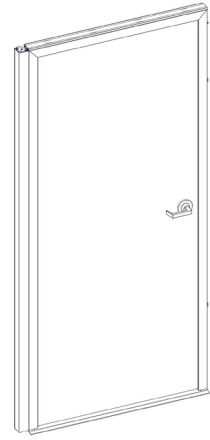

Hinged Door

**What's Included:**

Hinged Door laminate available in white and black

**How to Specify:**

**Options:**

Height: 82"

Width: 36", 42",

Left handed, Right handed

Straight connection, 90 degree connection, 3-way connection and 4-way connection

**Notes:**

Code	Price	H	W	D	Weight (lb.)	Volume (ft <sup>3</sup> )
Straight connection						
L-PD00-8236-L	3128	82	36			
L-PD00-8236-R	3128	82	36			
L-PD00-8242-L	3187	82	42			
L-PD00-8242-R	3187	82	42			
3-way connection						
L-PD00-8236-L-3W	3735	82	36			
L-PD00-8236-R-3W	3735	82	36			
L-PD00-8242-L-3W	3794	82	42			
L-PD00-8242-R-3W	3794	82	42			
4-way connection						
L-PD00-8236-L-4W	3487	82	36			
L-PD00-8236-R-4W	3487	82	36			
L-PD00-8242-L-4W	3548	82	42			
L-PD00-8242-R-4W	3548	82	42			
90 degree connection						
L-PD00-8236-L-90	3555	82	36			
L-PD00-8236-R-90	3555	82	36			
L-PD00-8242-L-90	3615	82	42			
L-PD00-8242-R-90	3615	82	42			

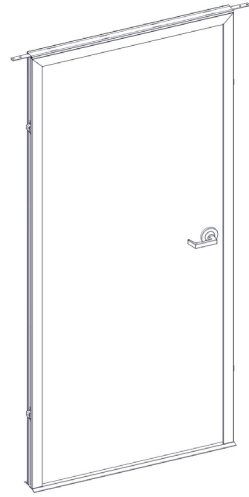

Sliding Door - Acrylic

**What's Included:**

Sliding door acrylic available in white and black

**How to Specify:**

**Notes:**

**Options:**

Height:	66"
Bracket Width:	30", 36", 42",
Door Width:	30", 36", 42", 48", 54", 60"
Left handed, Right handed	
Clear, Frosted, Fluted	

Code	Price	H	W	D	Weight (lb.)	Volume (ft <sup>3</sup> )
Clear Acrylic - left hand						
L-PDSC-663030-L	2100	66	30			
L-PDSC-663036-L	2113	66	36			
L-PDSC-663042-L	2119	66	42			
L-PDSC-663048-L	2125	66	48			
L-PDSC-663054-L	2131	66	54			
L-PDSC-663060-L	2136	66	60			
L-PDSC-663636-L	2109	66	36			
L-PDSC-663642-L	2120	66	42			
L-PDSC-663648-L	2126	66	48			
L-PDSC-663654-L	2132	66	54			
L-PDSC-663660-L	2137	66	60			
L-PDSC-664242-L	2115	66	42			
L-PDSC-664248-L	2127	66	48			
L-PDSC-664254-L	2132	66	54			
L-PDSC-664260-L	2138	66	60			
Clear Acrylic - right hand						
L-PDSC-663030-R	2100	66	30			
L-PDSC-663036-R	2113	66	36			
L-PDSC-663042-R	2119	66	42			
L-PDSC-663048-R	2125	66	48			
L-PDSC-663054-R	2131	66	54			
L-PDSC-663060-R	#N/A	66	60			
L-PDSC-663636-R	2109	66	36			
L-PDSC-663642-R	2120	66	42			
L-PDSC-663648-R	2126	66	48			
L-PDSC-663654-R	2132	66	54			
L-PDSC-663660-R	2137	66	60			
L-PDSC-664242-R	2115	66	42			
L-PDSC-664248-R	2127	66	48			
L-PDSC-664254-R	2132	66	54			
L-PDSC-664260-R	2138	66	60			

Code	Price	H	W	D	Weight (lb.)	Volume (ft <sup>3</sup> )
Frosted Acrylic - left hand						
L-PDSF-663030-L	2313	66	30			
L-PDSF-663036-L	2324	66	36			
L-PDSF-663042-L	2331	66	42			
L-PDSF-663048-L	2336	66	48			
L-PDSF-663054-L	2342	66	54			
L-PDSF-663060-L	2349	66	60			
L-PDSF-663636-L	2320	66	36			
L-PDSF-663642-L	2332	66	42			
L-PDSF-663648-L	2338	66	48			
L-PDSF-663654-L	2343	66	54			
L-PDSF-663660-L	2350	66	60			
L-PDSF-664242-L	2328	66	42			
L-PDSF-664248-L	2339	66	48			
L-PDSF-664254-L	2344	66	54			
L-PDSF-664260-L	2351	66	60			
Frosted Acrylic - right hand						
L-PDSF-663030-R	2313	66	30			
L-PDSF-663036-R	2324	66	36			
L-PDSF-663042-R	2331	66	42			
L-PDSF-663048-R	2336	66	48			
L-PDSF-663054-R	2342	66	54			
L-PDSF-663060-R	2349	66	60			
L-PDSF-663636-R	2320	66	36			
L-PDSF-663642-R	2332	66	42			
L-PDSF-663648-R	2338	66	48			
L-PDSF-663654-R	2343	66	54			
L-PDSF-663660-R	2350	66	60			
L-PDSF-664242-R	2328	66	42			
L-PDSF-664248-R	2339	66	48			
L-PDSF-664254-R	2344	66	54			
L-PDSF-664260-R	2351	66	60			

Code	Price	H	W	D	Weight (lb.)	Volume (ft <sup>3</sup> )
Fluted acrylic - left hand						
L-PDSL-663030-L	2100	66	30			
L-PDSL-663036-L	2113	66	36			
L-PDSL-663042-L	2119	66	42			
L-PDSL-663048-L	2125	66	48			
L-PDSL-663054-L	2131	66	54			
L-PDSL-663060-L	2136	66	60			
L-PDSL-663636-L	2109	66	36			
L-PDSL-663642-L	2120	66	42			
L-PDSL-663648-L	2126	66	48			
L-PDSL-663654-L	2132	66	54			
L-PDSL-663660-L	2137	66	60			
L-PDSL-664242-L	2115	66	42			
L-PDSL-664248-L	2127	66	48			
L-PDSL-664254-L	2132	66	54			
L-PDSL-664260-L	2138	66	60			
Fluted acrylic - right hand						
L-PDSL-663030-R	2100	66	30			
L-PDSL-663036-R	2113	66	36			
L-PDSL-663042-R	2119	66	42			
L-PDSL-663048-R	2125	66	48			
L-PDSL-663054-R	2131	66	54			
L-PDSL-663060-R	2136	66	60			
L-PDSL-663636-R	2109	66	36			
L-PDSL-663642-R	2120	66	42			
L-PDSL-663648-R	2126	66	48			
L-PDSL-663654-R	2132	66	54			
L-PDSL-663660-R	2137	66	60			
L-PDSL-664242-R	2115	66	42			
L-PDSL-664248-R	2127	66	48			
L-PDSL-664254-R	2132	66	54			
L-PDSL-664260-R	2138	66	60			



Switch USA Pricebook  
May 2023

# Connections & Trims

## Connections & Trims

<a href="#">2-Way Connection</a>	118
<a href="#">3-Way T Connection</a>	119
<a href="#">4-Way X Connection</a>	120
<a href="#">Top Cap</a>	121
<a href="#">Full Height End Trim</a>	122
<a href="#">Partial Height End Trim</a>	123
<a href="#">Full Height T Filler</a>	124
<a href="#">Partial Height T Filler</a>	125
<a href="#">90 Degree Filler-Full Height</a>	126
<a href="#">90 Degree Filler- Partial Height</a>	127
<a href="#">Straight Filler</a>	128
<a href="#">Gallery Panel Filler</a>	129
<a href="#">Adjustable Wall Connector</a>	130

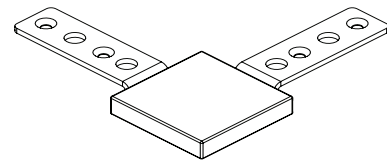

2-Way 90 degree Connection

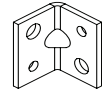

**What's Included:**

One (1) type A or type B straight or 90 degree connection bracket, accompanying screws

**How to Specify:**

Refer to page X for connection type application guide

Code	Price	H	W	D	Weight (lb.)	Volume (ft <sup>3</sup> )
2-Way Straight Connection						
L-HC2W-180-A	20	1	2	3	0.0	0.00
L-HC2W-180-B	17	1	2	3	0.0	0.00
2-Way 90 degree Connection						
L-HC2W-90-A	48	1	2	3	0.0	0.00
L-HC2W-90-B	48	1	2	3	0.0	0.00

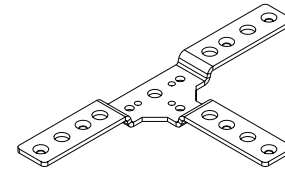

L-HC3W-A

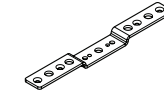

L-HC3W-B

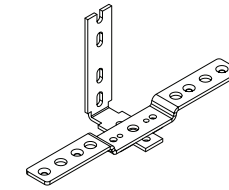

L-HC3W-C

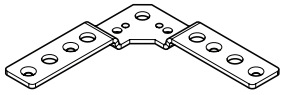

L-HC3W-D

**What's Included:**

One (1) type A or type B straight or 90 degree connection bracket, accompanying screws

**How to Specify:**

Refer to page X for connection type application guide

**Notes:**

Code	Price	H	W	D	Weight (lb.)	Volume (ft <sup>3</sup> )
3 Way T Connectors						
L-HC3W-A	83	1	2	3	0.0	0.00
L-HC3W-B	108	1	2	3	0.0	0.00
L-HC3W-C	79	1	2	3	0.0	0.00
L-HC3W-D	101	1	2	3	0.0	0.00

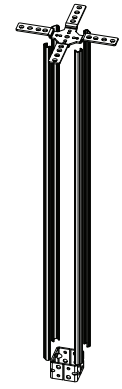

L-HC4W-A

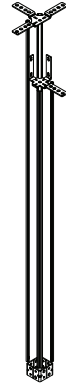

L-HC4W-B

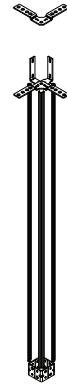

L-HC4W-C

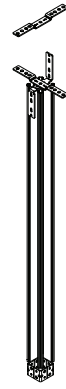

L-HC4W-D

**What's Included:**

One (1) type A, B, C or D 4-Way X connection bracket, accompanying screws

**How to Specify:**

Refer to page X for connection type application guide

**Notes:**

Code	Price	H	W	D	Weight (lb.)	Volume (ft <sup>3</sup> )
4 way connectors						
L-HC4W-A	133	1	2	3	0.0	0.00
L-HC4W-B	168	1	2	3	0.0	0.00
L-HC4W-C	150	1	2	3	0.0	0.00
L-HC4W-D	156	1	2	3	0.0	0.00

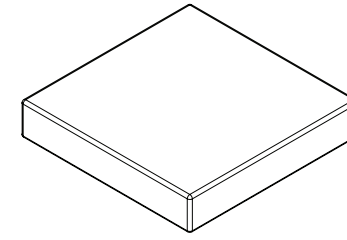

**What's Included:**

One (1) Top Cap

**How to Specify:**

Choose White, Black, Silver, Charcoal for Top Cap

**Options:**

Width: 2"

Depth: 2"

**Notes:**

Code	Price	H	W	D	Weight (lb.)	Volume (ft <sup>3</sup> )
L-HUFC-02	9	1	2	2	0.0	0.00

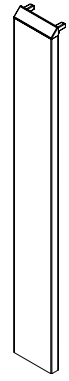

Standard

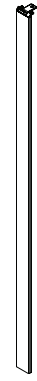

with coat hook

**What's Included:**

One (1) Full Height End Trim

**How to Specify:**

Choose White, Black, Silver, Charcoal for Full Height End Trim Colour

**Options:**

Height: 34", 42", 50", 66", 82"

Width: 2"

Standard, Coat Hook

**Notes:**

Code	Price	H	W	D	Weight (lb.)	Volume (ft <sup>3</sup> )
standard						
L-HETF-34	53	34	2	1	0.7	0.04
L-HETF-42	62	42	2	1	0.8	0.05
L-HETF-50	73	50	2	1	1.0	0.06
L-HETF-66	87	66	2	1	1.3	0.08
L-HETF-82	174	82	2	2	1.3	0.19
with coat hook						
L-HETF-34-CH	69	34	2	1	0.7	0.04
L-HETF-42-CH	80	42	2	1	0.8	0.05
L-HETF-50-CH	95	50	2	1	1.0	0.06
L-HETF-66-CH	116	66	2	1	1.3	0.08

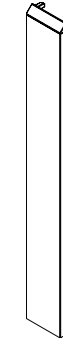

**What's Included:**

One (1) Partial Height End Trim

**How to Specify:**

Choose White, Black, Silver, Charcoal for Partial Height End Trim Colour

**Options:**

Height: 8", 16", 24", 32", 40", 48"

Width: 2"

**Notes:**

Code	Price	H	W	D	Weight (lb.)	Volume (ft <sup>3</sup> )
L-HETP-08	43	8	2	1	0.2	0.01
L-HETP-16	48	16	2	1	0.3	0.02
L-HETP-24	62	24	2	1	0.5	0.03
L-HETP-32	75	32	2	1	0.6	0.04
L-HETP-40	131	40	2	1	0.7	0.05
L-HETP-48	143	48	2	1	0.8	0.06





Full Height T Filler

**What's Included:**

One (1) Full Height T Filler

**How to Specify:**

Choose White, Black, Silver, Charcoal for Full Height T Filler

**Options:**

Height: 34", 42", 50", 66", 82"

Width: 2"

Standard, Coat Hook

**Notes:**

Code	Price	H	W	D	Weight (lb.)	Volume (ft <sup>3</sup> )
L-HFTR-34	190	34	2	1	0.7	0.04
L-HFTR-42	190	42	2	1	0.8	0.05
L-HFTR-50	197	50	2	1	1.0	0.06
L-HFTR-66	197	66	2	1	1.3	0.08
L-HFTR-82	328	82	2	1	1.6	0.09

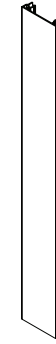

Partial Height T Filler

**What's Included:**

One (1) Partial Height T Filler

**How to Specify:**

Choose White, Black, Silver, Charcoal for Partial Height T Filler

**Options:**

Height: 8", 16", 24", 32", 40", 48"

Width: 2"

**Notes:**

Code	Price	H	W	D	Weight (lb.)	Volume (ft <sup>3</sup> )
L-HFTP-08	145	8	2	1	0.2	0.01
L-HFTP-16	145	16	2	1	0.3	0.02
L-HFTP-24	152	24	2	1	0.5	0.03
L-HFTP-32	152	32	2	1	0.6	0.04
L-HFTP-40	210	40	2	1	0.7	0.05



Full Height 90 Degree Filler

**What's Included:**

One (1) Full Height 90 Degree Filler

**How to Specify:**

Choose White, Black, Silver, Charcoal for Full Height 90 Degree Filler

**Options:**

Height: 34", 42", 50", 66", 82"

Width: 2"

Standard, Coat Hook

**Notes:**

Code	Price	H	W	D	Weight (lb.)	Volume (ft <sup>3</sup> )
L-HFNR-34	155	34	2	1	0.7	0.04
L-HFNR-42	165	42	2	1	0.7	0.05
L-HFNR-50	176	50	2	1	1.0	0.06
L-HFNR-66	188	66	2	1	1.3	0.08
L-HFNR-82	328	82	2	1	1.6	0.09



Partial Height 90 Degree Filler

**What's Included:**

One (1) Partial Height 90 Degree Filler

**How to Specify:**

Choose White, Black, Silver, Charcoal for Partial Height 90 Degree Filler

**Options:**

Height: 8", 16", 24", 32", 40", 48"

Width: 2"

**Notes:**

Code	Price	H	W	D	Weight (lb.)	Volume (ft <sup>3</sup> )
L-HFNP-08	64	8	2	1	0.2	0.01
L-HFNP-16	112	16	2	1	0.3	0.02
L-HFNP-24	121	24	2	1	0.5	0.03
L-HFNP-32	166	32	2	1	0.6	0.04
L-HFNP-40	210	40	2	1	0.7	0.05
L-HFNP-48	227	48	2	1	0.8	0.05

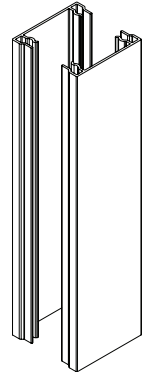

**What's Included:**

Partial Height Straight Filler

**How to Specify:**

Choose White, Black, Silver, Charcoal for Partial Height Straight Filler

**Options:**

Height: 8", 16", 24", 32", 40", 48"

Width: 2"

**Notes:**

Code	Price	H	W	D	Weight (lb.)	Volume (ft <sup>3</sup> )
L-HFSP-08	48	8	2	1	0.2	0.01
L-HFSP-16	81	16	2	1	0.3	0.02
L-HFSP-24	88	24	2	1	0.5	0.03
L-HFSP-32	91	32	2	1	0.6	0.04
L-HFSP-40	210	40	2	1	0.8	0.05
L-HFSP-48	227	48	2	1	1.0	0.06

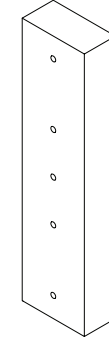

Partial Height Gallery Panel Filler

**What's Included:**

One (1) Partial Height Gallery Panel Filler

**How to Specify:**

Gallery Panel Filler matches laminate finish chosen on Gallery Panel

**Options:**

Height: 8", 16", 24", 32", 40", 48"

Width: 2"

Thickness: 1"

**Notes:**

Code	Price	H	W	D	Weight (lb.)	Volume (ft <sup>3</sup> )
L-HYP-08	75	8	1	1	0.1	0.00
L-HYP-16	79	16	1	1	0.2	0.01
L-HYP-24	99	24	1	1	0.2	0.01
L-HYP-32	121	32	1	1	0.3	0.02
L-HYP-40	210	40	1	1	0.4	0.03
L-HYP-48	227	48	1	1	0.6	0.04



138



mount 4



mount 6

Code	Price	H	W	D	Weight (lb.)	Volume (ft <sup>3</sup> )
mount 2						
L-HW2-34	138	34	2	2	1.4	0.08
L-HW2-42	160	42	2	2	1.7	0.10
L-HW2-50	186	50	2	2	2.0	0.12
L-HW2-66	230	66	2	2	2.6	0.15
L-HW2-82	281	82	2	2	3.2	0.18
mount 4						
L-HW4-34	154	34	2	4	2.7	0.16
L-HW4-42	180	42	2	4	3.4	0.19
L-HW4-50	202	50	2	4	4.0	0.23
L-HW4-66	250	66	2	4	5.3	0.31
L-HW4-82	306	82	2	4	6.6	0.40
mount 6						
L-HW6-34	176	34	2	6	4.1	0.24
L-HW6-42	197	42	2	6	5.0	0.29
L-HW6-50	221	50	2	6	6.0	0.35
L-HW6-66	267	66	2	6	7.9	0.46
L-HW6-82	328	82	2	6	9.8	0.57



Switch USA Pricebook  
May 2023

# Worksurfaces

## Worksurfaces

<u>Straight /w grommet</u>	134
<u>Straight Worksurface w/o Grommet</u>	136
<u>Straight Worksurface w/ Wire Play</u>	140
<u>5-Sided w Grommet</u>	144
<u>Straight Worksurface with Wire Play</u>	146
<u>Unitized w/ Grommet</u>	148
<u>Unitized w/ Wire Play</u>	150
<u>Transaction Top</u>	152

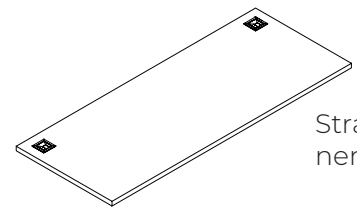

Straight Worksurface with Grommet5-Sided Corner

**What's Included:**

- One (1) worksurface
- 24"-48" - One (1) grommet cover for centre grommet
- 54"-96" - Two (2) grommet covers for grommet on each end

**Notes:**

- 24"-48" - One (1) grommet hole in the centre of the worksurface
- 54"-96" - Two (2) grommet holes on each end of the worksurface

**How to Specify:**

Refer to laminate card for laminate options

**Options:**

Width:	24", 30", 36", 42", 48", 54", 60", 66", 72", 78", 84", 90", 96"
Depth:	20", 24", 30"
Thickness:	1"

Code	Price	H	W	D	Weight (lb.)	Volume (ft³)
L-WS0G-2420	252	24	20	1	9.6	0.28
L-WS0G-3020	290	30	20	1	12.0	0.35
L-WS0G-3620	299	36	20	1	14.4	0.42
L-WS0G-4220	338	42	20	1	16.8	0.49
L-WS0G-4820	360	48	20	1	19.2	0.56
L-WS0G-5420	457	54	20	1	21.6	0.62
L-WS0G-6020	475	60	20	1	24.0	0.69
L-WS0G-6620	531	66	20	1	26.4	0.76
L-WS0G-7220	556	72	20	1	28.8	0.83
L-WS0G-7820	604	78	20	1	31.2	0.90
L-WS0G-8420	644	84	20	1	33.6	0.97
L-WS0G-9020	740	90	20	1	36.0	1.04
L-WS0G-9620	773	96	20	1	38.4	1.11
L-WS0G-2424	252	24	24	1	11.5	0.33

Code	Price	H	W	D	Weight (lb.)	Volume (ft³)
L-WS0G-3024	290	30	24	1	14.4	0.42
L-WS0G-3624	299	36	24	1	17.3	0.50
L-WS0G-4224	338	42	24	1	20.2	0.58
L-WS0G-4824	360	48	24	1	23.0	0.67
L-WS0G-5424	457	54	24	1	25.9	0.75
L-WS0G-6024	475	60	24	1	28.8	0.83
L-WS0G-6624	531	66	24	1	31.7	0.92
L-WS0G-7224	556	72	24	1	34.6	1.00
L-WS0G-7824	604	78	24	1	37.4	1.08
L-WS0G-8424	644	84	24	1	40.3	1.17
L-WS0G-9024	740	90	24	1	43.2	1.25
L-WS0G-9624	773	96	24	1	46.1	1.33
L-WS0G-2430	290	24	30	1	14.4	0.42
L-WS0G-3030	338	30	30	1	18.0	0.52
L-WS0G-3630	362	36	30	1	21.6	0.62
L-WS0G-4230	395	42	30	1	25.2	0.73
L-WS0G-4830	426	48	30	1	28.8	0.83
L-WS0G-5430	475	54	30	1	32.4	0.94
L-WS0G-6030	504	60	30	1	36.0	1.04
L-WS0G-6630	573	66	30	1	39.6	1.15
L-WS0G-7230	590	72	30	1	43.2	1.25
L-WS0G-7830	642	78	30	1	46.8	1.35
L-WS0G-8430	691	84	30	1	50.4	1.46
L-WS0G-9030	820	90	30	1	54.0	1.56
L-WS0G-9630	850	96	30	1	57.6	1.67

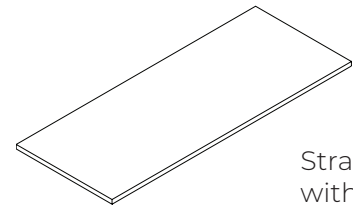

Straight Worksurface without Full Depth without Grommet

**What's Included:**

One (1) worksurface

**How to Specify:**

Refer to laminate card for laminate options

**Notes:**

Worksurface is full depth to sit flush against panel with no grommet

**Options:**

Width:	24", 30", 36", 42", 48", 54", 60", 66", 72", 78", 84", 90", 96"
Depth:	20", 24", 30"
Thickness:	1"

Code	Price	Height	Depth	Thickness	Weight (lb.)	Volume (ft <sup>3</sup> )
Straight Worksurface without Full Depth without Grommet						
L-WS00-2320	216	23	20	1	9.2	0.27
L-WS00-2420	216	24	20	1	9.6	0.28
L-WS00-2920	262	29	20	1	11.6	0.34
L-WS00-3020	262	30	20	1	12.0	0.35
L-WS00-3520	277	35	20	1	14.0	0.41
L-WS00-3620	277	36	20	1	14.4	0.42
L-WS00-4120	306	41	20	1	16.4	0.47
L-WS00-4220	306	42	20	1	16.8	0.49
L-WS00-4720	338	47	20	1	18.8	0.54
L-WS00-4820	338	48	20	1	19.2	0.56
L-WS00-5320	413	53	20	1	21.2	0.61

Code	Price	Height	Depth	Thickness	Weight (lb.)	Volume (ft <sup>3</sup> )
L-WS00-5420	413	54	20	1	21.6	0.62
L-WS00-5920	413	59	20	1	23.6	0.68
L-WS00-6020	413	60	20	1	24.0	0.69
L-WS00-6520	466	65	20	1	26.0	0.75
L-WS00-6620	466	66	20	1	26.4	0.76
L-WS00-7120	506	71	20	1	28.4	0.82
L-WS00-7220	506	72	20	1	28.8	0.83
L-WS00-7620	536	76	20	1	30.4	0.88
L-WS00-7720	536	77	20	1	30.8	0.89
L-WS00-7820	536	78	20	1	31.2	0.90
L-WS00-8220	583	82	20	1	32.8	0.95
L-WS00-8320	583	83	20	1	33.2	0.96
L-WS00-8420	583	84	20	1	33.6	0.97
L-WS00-8820	612	88	20	1	35.2	1.02
L-WS00-8920	612	89	20	1	35.6	1.03
L-WS00-9020	612	90	20	1	36.0	1.04
L-WS00-9420	674	94	20	1	37.6	1.09
L-WS00-9520	674	95	20	1	38.0	1.10
L-WS00-9620	674	96	20	1	38.4	1.11
L-WS00-2324	216	23	24	1	11.0	0.32
L-WS00-2424	216	24	24	1	11.5	0.33
L-WS00-2924	262	29	24	1	13.9	0.40
L-WS00-3024	262	30	24	1	14.4	0.42
L-WS00-3524	277	35	24	1	16.8	0.49
L-WS00-3624	277	36	24	1	17.3	0.50
L-WS00-4124	306	41	24	1	19.7	0.57

[2 of 4] continued on next page

Worksurface continued [3 of 4]

Code	Price	Height	Depth	Thickness	Weight (lb.)	Volume (ft <sup>3</sup> )
L-WS00-4224	306	42	24	1	20.2	0.58
L-WS00-4724	338	47	24	1	22.6	0.65
L-WS00-4824	338	48	24	1	23.0	0.67
L-WS00-5324	413	53	24	1	25.4	0.74
L-WS00-5424	413	54	24	1	25.9	0.75
L-WS00-5924	413	59	24	1	28.3	0.82
L-WS00-6024	413	60	24	1	28.8	0.83
L-WS00-6524	466	65	24	1	31.2	0.90
L-WS00-6624	466	66	24	1	31.7	0.92
L-WS00-7124	506	71	24	1	34.1	0.99
L-WS00-7224	506	72	24	1	34.6	1.00
L-WS00-7624	536	76	24	1	36.5	1.06
L-WS00-7724	536	77	24	1	37.0	1.07
L-WS00-7824	536	78	24	1	37.4	1.08
L-WS00-8224	583	82	24	1	39.4	1.14
L-WS00-8324	583	83	24	1	39.8	1.15
L-WS00-8424	583	84	24	1	40.3	1.17
L-WS00-8824	612	88	24	1	42.2	1.22
L-WS00-8924	612	89	24	1	42.7	1.24
L-WS00-9024	612	90	24	1	43.2	1.25
L-WS00-9424	674	94	24	1	45.1	1.31
L-WS00-9524	674	95	24	1	45.6	1.32
L-WS00-9624	674	96	24	1	46.1	1.33
L-WS00-2330	262	23	30	1	13.8	0.40
L-WS00-2430	262	24	30	1	14.4	0.42
L-WS00-2930	306	29	30	1	17.4	0.50

Worksurface continued [4 of 4]

Code	Price	Height	Depth	Thickness	Weight (lb.)	Volume (ft <sup>3</sup> )
L-WS00-3030	306	30	30	1	18.0	0.52
L-WS00-3530	342	35	30	1	21.0	0.61
L-WS00-3630	342	36	30	1	21.6	0.62
L-WS00-4130	373	41	30	1	24.6	0.71
L-WS00-4230	373	42	30	1	25.2	0.73
L-WS00-4730	403	47	30	1	28.2	0.82
L-WS00-4830	403	48	30	1	28.8	0.83
L-WS00-5330	457	53	30	1	31.8	0.92
L-WS00-5430	457	54	30	1	32.4	0.94
L-WS00-5930	482	59	30	1	35.4	1.02
L-WS00-6030	482	60	30	1	36.0	1.04
L-WS00-6530	553	65	30	1	39.0	1.13
L-WS00-6630	553	66	30	1	39.6	1.15
L-WS00-7130	567	71	30	1	42.6	1.23
L-WS00-7230	567	72	30	1	43.2	1.25
L-WS00-7630	618	76	30	1	45.6	1.32
L-WS00-7730	618	77	30	1	46.2	1.34
L-WS00-7830	618	78	30	1	46.8	1.35
L-WS00-8230	673	82	30	1	49.2	1.42
L-WS00-8330	673	83	30	1	49.8	1.44
L-WS00-8430	673	84	30	1	50.4	1.46
L-WS00-8830	767	88	30	1	52.8	1.53
L-WS00-8930	767	89	30	1	53.4	1.55
L-WS00-9030	767	90	30	1	54.0	1.56
L-WS00-9430	832	94	30	1	56.4	1.63
L-WS00-9530	832	95	30	1	57.0	1.65
L-WS00-9630	832	96	30	1	57.6	1.67



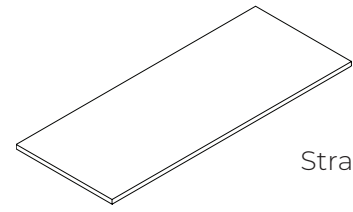

Straight Worksurface with 1" Wire Play

**What's Included:**

One (1) worksurface

**How to Specify:**

Refer to laminate card for laminate options

**Notes:**

Worksurface sits 1" from the panel to allow for wire routing. No grommet is included with this worksurface

**Options:**

Width: 23", 24", 29", 30", 35", 36", 41", 42", 47", 48", 53", 54", 59", 60", 65", 66", 71", 72", 77", 78", 83", 84", 89", 90", 95", 96"

Depth: 19", 20", 23", 24", 29", 30"

Thickness: 1"

Code	Price	Height	Depth	Thickness	Weight (lb.)	Volume (ft <sup>3</sup> )
Straight Worksurface with 1" Wire Play						
L-WS00-2319	216	23	19	1	8.7	0.25
L-WS00-2419	216	24	19	1	9.1	0.26
L-WS00-2919	262	29	19	1	11.0	0.32
L-WS00-3019	262	30	19	1	11.4	0.33
L-WS00-3519	277	35	19	1	13.3	0.38
L-WS00-3619	277	36	19	1	13.7	0.40
L-WS00-4119	306	41	19	1	15.6	0.45
L-WS00-4219	306	42	19	1	16.0	0.46
L-WS00-4719	338	47	19	1	17.9	0.52
L-WS00-4819	338	48	19	1	18.2	0.53
L-WS00-5319	413	53	19	1	20.1	0.58
L-WS00-5419	413	54	19	1	20.5	0.59

Code	Price	Height	Depth	Thickness	Weight (lb.)	Volume (ft <sup>3</sup> )
L-WS00-5919	413	59	19	1	22.4	0.65
L-WS00-6019	413	60	19	1	22.8	0.66
L-WS00-6519	466	65	19	1	24.7	0.71
L-WS00-6619	466	66	19	1	25.1	0.73
L-WS00-7119	506	71	19	1	27.0	0.78
L-WS00-7219	506	72	19	1	27.4	0.79
L-WS00-7619	536	76	19	1	28.9	0.84
L-WS00-7719	536	77	19	1	29.3	0.85
L-WS00-7819	536	78	19	1	29.6	0.86
L-WS00-8219	583	82	19	1	31.2	0.90
L-WS00-8319	583	83	19	1	31.5	0.91
L-WS00-8419	583	84	19	1	31.9	0.92
L-WS00-8819	612	88	19	1	33.4	0.97
L-WS00-8919	612	89	19	1	33.8	0.98
L-WS00-9019	612	90	19	1	34.2	0.99
L-WS00-9419	674	94	19	1	35.7	1.03
L-WS00-9519	674	95	19	1	36.1	1.04
L-WS00-9619	674	96	19	1	36.5	1.06
L-WS00-2323	216	23	23	1	10.6	0.31
L-WS00-2423	216	24	23	1	11.0	0.32
L-WS00-2923	262	29	23	1	13.3	0.39
L-WS00-3023	262	30	23	1	13.8	0.40
L-WS00-3523	277	35	23	1	16.1	0.47
L-WS00-3623	277	36	23	1	16.6	0.48
L-WS00-4123	306	41	23	1	18.9	0.55
L-WS00-4223	306	42	23	1	19.3	0.56
L-WS00-4723	338	47	23	1	21.6	0.63

[2 of 4] continued on next page

Worksurface continued [3 of 4]

Code	Price	Height	Depth	Thickness	Weight (lb.)	Volume (ft <sup>3</sup> )
L-WS00-4823	338	48	23	1	22.1	0.64
L-WS00-5323	413	53	23	1	24.4	0.71
L-WS00-5423	413	54	23	1	24.8	0.72
L-WS00-5923	413	59	23	1	27.1	0.79
L-WS00-6023	413	60	23	1	27.6	0.80
L-WS00-6523	466	65	23	1	29.9	0.87
L-WS00-6623	466	66	23	1	30.4	0.88
L-WS00-7123	506	71	23	1	32.7	0.95
L-WS00-7223	506	72	23	1	33.1	0.96
L-WS00-7623	536	76	23	1	35.0	1.01
L-WS00-7723	536	77	23	1	35.4	1.02
L-WS00-7823	536	78	23	1	35.9	1.04
L-WS00-8223	583	82	23	1	37.7	1.09
L-WS00-8323	583	83	23	1	38.2	1.10
L-WS00-8423	583	84	23	1	38.6	1.12
L-WS00-8823	612	88	23	1	40.5	1.17
L-WS00-8923	612	89	23	1	40.9	1.18
L-WS00-9023	612	90	23	1	41.4	1.20
L-WS00-9423	674	94	23	1	43.2	1.25
L-WS00-9523	674	95	23	1	43.7	1.26
L-WS00-9623	674	96	23	1	44.2	1.28
L-WS00-2329	262	23	29	1	13.3	0.39
L-WS00-2429	262	24	29	1	13.9	0.40
L-WS00-2929	306	29	29	1	16.8	0.49
L-WS00-3029	306	30	29	1	17.4	0.50
L-WS00-3529	342	35	29	1	20.3	0.59
L-WS00-3629	342	36	29	1	20.9	0.60
L-WS00-4129	373	41	29	1	23.8	0.69

Worksurface continued [4 of 4]

Code	Price	Height	Depth	Thickness	Weight (lb.)	Volume (ft <sup>3</sup> )
L-WS00-4229	373	42	29	1	24.4	0.70
L-WS00-4729	403	47	29	1	27.3	0.79
L-WS00-4829	403	48	29	1	27.8	0.81
L-WS00-5329	457	53	29	1	30.7	0.89
L-WS00-5429	457	54	29	1	31.3	0.91
L-WS00-5929	482	59	29	1	34.2	0.99
L-WS00-6029	482	60	29	1	34.8	1.01
L-WS00-6529	553	65	29	1	37.7	1.09
L-WS00-6629	553	66	29	1	38.3	1.11
L-WS00-7129	567	71	29	1	41.2	1.19
L-WS00-7229	567	72	29	1	41.8	1.21
L-WS00-7629	618	76	29	1	44.1	1.28
L-WS00-7729	618	77	29	1	44.7	1.29
L-WS00-7829	618	78	29	1	45.2	1.31
L-WS00-8229	673	82	29	1	47.6	1.38
L-WS00-8329	673	83	29	1	48.1	1.39
L-WS00-8429	673	84	29	1	48.7	1.41
L-WS00-8829	767	88	29	1	51.0	1.48
L-WS00-8929	767	89	29	1	51.6	1.49
L-WS00-9029	767	90	29	1	52.2	1.51
L-WS00-9429	832	94	29	1	54.5	1.58
L-WS00-9529	832	95	29	1	55.1	1.59
L-WS00-9629	832	96	29	1	55.7	1.61

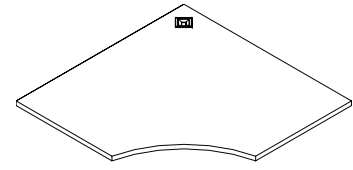

Curved 5-Sided Worksurface with Grommet

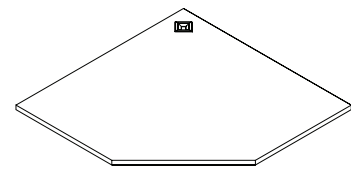

Straight 5-Sided Worksurface with Grommet

**What's Included:**

One (1) worksurface, One (1) grommet

**How to Specify:**

Refer to laminate card for laminate options

**Notes:**

Worksurface sits 1" from the panel to allow for wire routing. No grommet is included with this worksurface

Surface has a curved front

**Options:**

Side A*:	36", 42", 48"
Side B:	24", 30"
Thickness:	1"
Straight, Curved Front	
Grommet Type & Colour: Square (Silver, Black, White), Oval (Silver, Black)	

\*36" on side A only available in 24" on side B

Code	Price	Height	Depth	Thickness	Weight (lb.)	Volume (ft <sup>3</sup> )
curved front with grommet						
L-W5CG-3624	443	36	24	1	30.0	0.50
L-W5CG-4224	535	42	24	1	33.0	0.58
L-W5CG-4824	642	48	24	1	36.0	0.67
L-W5CG-4230	535	42	30	1	35.0	0.73
L-W5CG-4830	642	48	30	1	38.0	0.83
straight front with grommet						
L-W5SG-3624	443	36	24	1	30.0	0.50
L-W5SG-4224	535	42	24	1	33.0	0.58
L-W5SG-4824	642	48	24	1	36.0	0.67
L-W5SG-4230	535	42	30	1	35.0	0.73
L-W5SG-4830	642	48	30	1	38.0	0.83

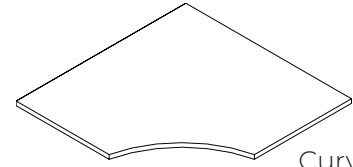

Curved 5-Sided Workspace with 1" Wire Play

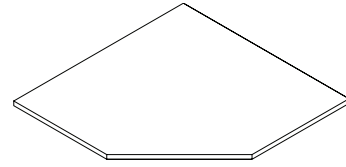

Straight 5-Sided Workspace with 1" Wire Play

**What's Included:**

One (1) workspace

**How to Specify:**

Refer to laminate card for laminate options

**Options:**

Side A & C\*: 35", 36", 41", 42", 47", 48"

Side B & D: 23", 24", 29", 30"

Thickness: 1"

Straight, Curved Front

\*35" & 36" on side A & C only available in 23" & 24" on side B & D

**Notes:**

Workspace sits 1" from the panel to allow for wire routing. No grommet is included with this workspace

Code	Price	Height	Depth	Thickness	Weight (lb.)	Volume (ft <sup>3</sup> )
<b>Left hand curved front</b>						
L-W5C0-3624-L	443	36	24	1	30.0	0.50
L-W5C0-4224-L	535	42	24	1	33.0	0.58
L-W5C0-4824-L	642	48	24	1	36.0	0.67
L-W5C0-4230-L	535	42	30	1	35.0	0.73
L-W5C0-4830-L	642	48	30	1	38.0	0.83
<b>Right hand curved front</b>						
L-W5C0-3624-R	443	36	24	1	30.0	0.50
L-W5C0-4224-R	535	42	24	1	33.0	0.58
L-W5C0-4824-R	642	48	24	1	36.0	0.67
L-W5C0-4230-R	535	42	30	1	35.0	0.73
L-W5C0-4830-R	642	48	30	1	38.0	0.83
<b>Double curved front</b>						
L-W5C0-3523-D	443	35	23	1	30.0	0.47
L-W5C0-4123-D	535	41	23	1	33.0	0.55
L-W5C0-4723-D	642	47	23	1	36.0	0.63
L-W5C0-4129-D	535	41	29	1	35.0	0.69
L-W5C0-4729-D	642	47	29	1	38.0	0.79

Code	Price	Height	Depth	Thickness	Weight (lb.)	Volume (ft <sup>3</sup> )
<b>Left hand straight front</b>						
L-W5S0-3624-L	443	36	24	1	30.0	0.50
L-W5S0-4224-L	535	42	24	1	33.0	0.58
L-W5S0-4824-L	642	48	24	1	36.0	0.67
L-W5S0-4230-L	535	42	30	1	35.0	0.73
L-W5S0-4830-L	642	48	30	1	38.0	0.83
<b>Right hand straight front</b>						
L-W5S0-3624-R	443	36	24	1	30.0	0.50
L-W5S0-4224-R	535	42	24	1	33.0	0.58
L-W5S0-4824-R	642	48	24	1	36.0	0.67
L-W5S0-4230-R	535	42	30	1	35.0	0.73
L-W5S0-4830-R	642	48	30	1	38.0	0.83
<b>Double straight front</b>						
L-W5S0-3523-D	443	35	23	1	30.0	0.47
L-W5S0-4123-D	535	41	23	1	33.0	0.55
L-W5S0-4723-D	642	47	23	1	36.0	0.63
L-W5S0-4129-D	535	41	29	1	35.0	0.69
L-W5S0-4729-D	642	47	29	1	38.0	0.79

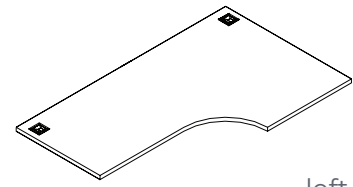

left hand shown with grommet

**What's Included:**

One (1) workspace, Two(2) grommets

**How to Specify:**

Refer to laminate card for laminate options

**Notes:**

Surface has a curved front

**Options:**

Side A:	36"
Side B:	24"
Side C:	54", 60", 66", 72", 78", 84", 90", 96"
Thickness:	1"
Left Hand, Right Hand	
Grommet Type & Color: Square (Silver, Black, White), Oval (Silver, Black)	

Code	Price	Height	Depth	Thickness	Weight (lb.)	Volume (ft <sup>3</sup> )
Left hand with grommet						
L-WUCG-543624-L	638	54	36	1	24.9	1.12
L-WUCG-603624-L	674	60	36	1	26.9	1.25
L-WUCG-663624-L	747	66	36	1	28.9	1.38
L-WUCG-723624-L	793	72	36	1	30.9	1.50
L-WUCG-783624-L	857	78	36	1	32.9	1.62
L-WUCG-843624-L	916	84	36	1	34.9	1.75
L-WUCG-903624-L	1054	90	36	1	36.9	1.88
L-WUCG-963624-L	1104	96	36	1	38.9	2.00
Right hand with grommet						
L-WUCG-543624-R	638	54	36	1	24.9	1.12
L-WUCG-603624-R	674	60	36	1	26.9	1.25
L-WUCG-663624-R	747	66	36	1	28.9	1.38
L-WUCG-723624-R	793	72	36	1	30.9	1.50
L-WUCG-783624-R	857	78	36	1	32.9	1.62
L-WUCG-843624-R	916	84	36	1	34.9	1.75
L-WUCG-903624-R	1054	90	36	1	36.9	1.88
L-WUCG-963624-R	1104	96	36	1	38.9	2.00

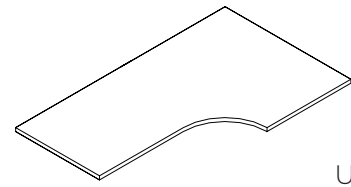

Unitized Workspace with 1" Wire Play

**What's Included:**

One (1) workspace

**How to Specify:**

Refer to laminate card for laminate options

**Notes:**

Workspace sits 1" from the panel to allow for wire routing. No grommet is included with this workspace

Surface has a curved front

**Options:**

Side A:	53", 54", 59", 60", 65", 66", 71", 72", 77", 78", 83", 84", 89", 90", 95", 96"
Side B:	23", 24"
Side C:	35", 36"
Side D:	23", 24"

Code	Price	Height	Depth	Thickness	Weight (lb)	Volume (ft <sup>3</sup> )
Left hand						
L-WUC0-543524-L	638	54	35	1	24.9	1.09
L-WUC0-603524-L	674	60	35	1	26.9	1.22
L-WUC0-663524-L	747	66	35	1	28.9	1.34
L-WUC0-723524-L	793	72	35	1	30.9	1.46
L-WUC0-783524-L	857	78	35	1	32.9	1.58
L-WUC0-843524-L	916	84	35	1	34.9	1.70
L-WUC0-903524-L	1054	90	35	1	36.9	1.82
L-WUC0-963524-L	1104	96	35	1	38.9	1.94
L-WUC0-533624-L	638	53	36	1	24.9	1.10
L-WUC0-593624-L	674	59	36	1	26.9	1.23
L-WUC0-653624-L	747	65	36	1	28.9	1.35
L-WUC0-713624-L	793	71	36	1	30.9	1.48
L-WUC0-773624-L	857	77	36	1	32.9	1.60
L-WUC0-833624-L	916	83	36	1	34.9	1.73
L-WUC0-893624-L	1054	89	36	1	36.9	1.85

Code	Price	Height	Depth	Thickness	Weight (lb)	Volume (ft <sup>3</sup> )
L-WUC0-953624-L	1104	95	36	1	38.9	1.98
L-WUC0-533523-L	638	53	35	1	24.9	1.07
L-WUC0-593523-L	674	59	35	1	26.9	1.20
L-WUC0-653523-L	747	65	35	1	28.9	1.32
L-WUC0-713523-L	793	71	35	1	30.9	1.44
L-WUC0-773523-L	857	77	35	1	32.9	1.56
L-WUC0-833523-L	916	83	35	1	34.9	1.68
L-WUC0-893523-L	1054	89	35	1	36.9	1.80
L-WUC0-953523-L	1104	95	35	1	38.9	1.92
Right hand						
L-WUC0-543524-R	638	54	35	1	24.9	1.09
L-WUC0-603524-R	674	60	35	1	26.9	1.22
L-WUC0-663524-R	747	66	35	1	28.9	1.34
L-WUC0-723524-R	793	72	35	1	30.9	1.46
L-WUC0-783524-R	857	78	35	1	32.9	1.58
L-WUC0-843524-R	916	84	35	1	34.9	1.70
L-WUC0-903524-R	1054	90	35	1	36.9	1.82
L-WUC0-963524-R	1104	96	35	1	38.9	1.94
L-WUC0-533624-R	638	53	36	1	24.9	1.10
L-WUC0-593624-R	674	59	36	1	26.9	1.23
L-WUC0-653624-R	747	65	36	1	28.9	1.35
L-WUC0-713624-R	793	71	36	1	30.9	1.48
L-WUC0-773624-R	857	77	36	1	32.9	1.60
L-WUC0-833624-R	916	83	36	1	34.9	1.73
L-WUC0-893624-R	1054	89	36	1	36.9	1.85
L-WUC0-953624-R	1104	95	36	1	38.9	1.98
L-WUC0-533523-R	638	53	35	1	24.9	1.07
L-WUC0-593523-R	674	59	35	1	26.9	1.20
L-WUC0-653523-R	747	65	35	1	28.9	1.32
L-WUC0-713523-R	793	71	35	1	30.9	1.44
L-WUC0-773523-R	857	77	35	1	32.9	1.56
L-WUC0-833523-R	916	83	35	1	34.9	1.68
L-WUC0-893523-R	1054	89	35	1	36.9	1.80
L-WUC0-953523-R	1104	95	35	1	38.9	1.92

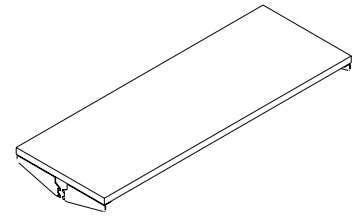

**What's Included:**

One (1) transaction top, Four (4) cantilever brackets

**How to Specify:**

Match the transaction top to the corresponding panel width

Refer to laminate card for laminate options

Choose White, Black, Silver, Charcoal for cantilever color

**Notes:**

**Options:**

Width: 24", 30", 36", 42", 48", 54", 60"

Depth: 15"

Thickness: 1"

Cantilever Paint Colour: Silver, White, Black, Charcoal

Code	Price	H	W	D	Weight (lb.)	Volume (ft <sup>3</sup> )
L-WTT-2415	263	24	15	1	5.8	0.21
L-WTT-3015	281	30	15	1	7.2	0.26
L-WTT-3615	292	36	15	1	8.6	0.31
L-WTT-4215	309	42	15	1	10.1	0.36
L-WTT-4815	319	48	15	1	11.5	0.42
L-WTT-5415	340	54	15	1	13.0	0.47
L-WTT-6015	350	60	15	1	14.4	0.52



Switch USA Pricebook  
May 2023

# Supports

## Supports

<u>Ladder Gable</u>	156
<u>Standard Panel</u>	156
<u>Gallery Panel</u>	158
<u>Freestanding Panel</u>	160
<u>Laminate Gable</u>	161
<u>Standard Panel</u>	161
<u>Gallery Panel</u>	162
<u>Freestanding</u>	163
<u>Wrap Laminate Gable</u>	164
<u>Standard Panel</u>	164
<u>Gallery Panel</u>	165
<u>Tech Drop</u>	166
<u>Cantilever</u>	167
<u>Standard Panel</u>	167
<u>Gallery Panel</u>	168
<u>Standard Panel Mount Corner Bracket</u>	169
<u>Flush Plate</u>	170
<u>Storage Support Bracket</u>	171
<u>Fixed Credenza Support Bracket</u>	172
<u>90 Degree Bracket</u>	173



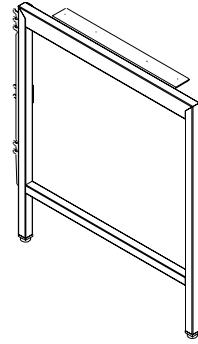

Standard Panel Ladder Gable

**What's Included:**

One (1) ladder gable, one (1) standard panel mount bracket, (1) surface to gable connector

**How to Specify:**

Choose White, Black, Silver, Charcoal for ladder gable colour

**Notes:**

Ladder Gable can be used with worksurface with grommet, worksurface without grommet, worksurface for 1" wire play

Mid gable is used at the surface joint

**Options:**

Heights\*: 25", 28"

Depth: 20", 24", 30"

Ladder Gable Paint Colour:: Silver, White, Black, Charcoal

End gable: (Left hand, right hand) or mid gable

\*25" high to be used to Tech Drop surface

Code	Price	H	W	D	Weight (lb.)	Volume (ft <sup>3</sup> )
Left hand						
L-HOEG-P-2520-L	339	25	20	2	10.0	0.58
L-HOEG-P-2524-L	342	25	24	2	12.0	0.69
L-HOEG-P-2530-L	377	25	30	2	15.0	0.87
L-HOEG-P-2820-L	343	28	20	2	11.2	0.65
L-HOEG-P-2824-L	350	28	24	2	13.4	0.78
L-HOEG-P-2830-L	364	28	30	2	16.8	0.97
Right hand						
L-HOEG-P-2520-R	339	25	20	2	10.0	0.58
L-HOEG-P-2524-R	342	25	24	2	12.0	0.69
L-HOEG-P-2530-R	377	25	30	2	15.0	0.87
L-HOEG-P-2820-R	343	28	20	2	11.2	0.65
L-HOEG-P-2824-R	350	28	24	2	13.4	0.78
Mid						
L-HOMG-P-2520	339	25	20	2	10.0	0.58
L-HOMG-P-2524	342	25	24	2	12.0	0.69
L-HOMG-P-2530	377	25	30	2	15.0	0.87
L-HOMG-P-2820	343	28	20	2	11.2	0.65
L-HOMG-P-2824	350	28	24	2	13.4	0.78
L-HOMG-P-2830	364	28	30	2	16.8	0.97

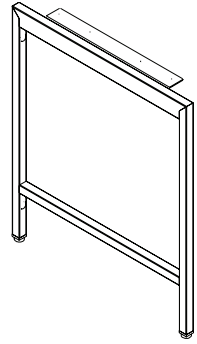

Gallery Panel Ladder Gable

**What's Included:**

One (1) ladder gable, one (1) gallery panel mount bracket, (1) surface to gable connector

**How to Specify:**

Choose White, Black, Silver, Charcoal for ladder gable colour

**Notes:**

Ladder Gable can be used with worksurface with grommet, worksurface without grommet, worksurface for 1" wire play

Mid gable is used at the surface joint

**Options:**

Heights*:	25", 28"
Depth:	20", 24", 30"
Ladder Gable Paint Colour::	Silver, White, Black, Charcoal
End gable:	(Left hand, right hand) or mid gable

\*25" high to be used to Tech Drop surface

Code	Price	H	W	D	Weight (lb.)	Volume (ft <sup>3</sup> )
Left hand						
L-HOEG-Y-2520-L	339	25	20	2	10.0	0.58
L-HOEG-Y-2524-L	342	25	24	2	12.0	0.69
L-HOEG-Y-2530-L	377	25	30	2	15.0	0.87
L-HOEG-Y-2820-L	343	28	20	2	11.2	0.65
L-HOEG-Y-2824-L	350	28	24	2	13.4	0.78
L-HOEG-Y-2830-L	364	28	30	2	16.8	0.97
Right hand						
L-HOEG-Y-2520-R	339	25	20	2	10.0	0.58
L-HOEG-Y-2524-R	342	25	24	2	12.0	0.69
L-HOEG-Y-2530-R	377	25	30	2	15.0	0.87
L-HOEG-Y-2820-R	343	28	20	2	11.2	0.65
L-HOEG-Y-2824-R	350	28	24	2	13.4	0.78
L-HOEG-Y-2830-R	364	28	30	2	16.8	0.97
Mid						
L-HOMG-Y-2520	339	25	20	2	10.0	0.58
L-HOMG-Y-2524	342	25	24	2	12.0	0.69
L-HOMG-Y-2530	377	25	30	2	15.0	0.87
L-HOMG-Y-2820	343	28	20	2	11.2	0.65
L-HOMG-Y-2824	350	28	24	2	13.4	0.78
L-HOMG-Y-2830	364	28	30	2	16.8	0.97

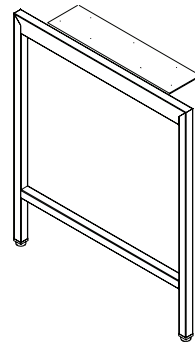

Freestanding

**What's Included:**

One (1) 90 degree bracket

**How to Specify:**

Available in black only

**Notes:**

90 degree bracket is used to connect a worksurface to a gallery panel

**Options:**

Heights\*: 25", 28"

Depth: 20", 24", 30"

Ladder Gable Paint Colour:: Silver, White, Black, Charcoal

End gable: (Left hand, right hand)

\*25" high to be used to Tech Drop surface

Code	Price	H	W	D	Weight (lb.)	Volume (ft <sup>3</sup> )
Freestanding						
L-HOEG-S-2520	339	25	20	2	10.0	0.58
L-HOEG-S-2524	342	25	24	2	12.0	0.69
L-HOEG-S-2530	377	25	30	2	15.0	0.87
L-HOEG-S-2820	343	28	20	2	11.2	0.65
L-HOEG-S-2824	350	28	24	2	13.4	0.78
L-HOEG-S-2830	364	28	30	2	16.8	0.97

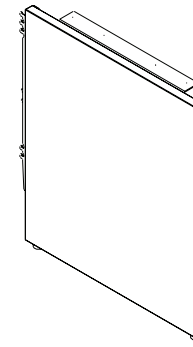

Standard Panel Laminate Gable

**What's Included:**

One (1) ladder gable, one (1) standard panel mount bracket, (1) surface to gable connector

**How to Specify:**

Laminate Gable Paint Colour: Silver, White, Black, Charcoal

Laminate Gable Laminate Colour: Refer to laminate card for laminate options

End gable (Left hand, right hand)

**Options:**

Heights\*: 25", 28"

Depth: 20", 24", 30"

\*25" high to be used to Tech Drop surface

**Notes:**

Ladder Gable can be used with worksurface with grommet, worksurface without grommet, worksurface for 1" wire play

Code	Price	H	W	D	Weight (lb.)	Volume (ft <sup>3</sup> )
Left hand						
L-HCEG-P-2520-L	221	25	20	2	10.0	0.58
L-HCEG-P-2524-L	240	25	24	2	12.0	0.69
L-HCEG-P-2530-L	262	25	30	2	15.0	0.87
L-HCEG-P-2812-L	205	28	12	2	10.0	0.39
L-HCEG-P-2820-L	231	28	20	2	11.2	0.65
L-HCEG-P-2824-L	250	28	24	2	13.4	0.78
L-HCEG-P-2830-L	274	28	30	2	16.8	0.97
Right hand						
L-HCEG-P-2520-R	221	25	20	2	10.0	0.58
L-HCEG-P-2524-R	240	25	24	2	12.0	0.69
L-HCEG-P-2530-R	262	25	30	2	15.0	0.87
L-HCEG-P-2812-R	205	28	12	2	10.0	0.39
L-HCEG-P-2820-R	231	28	20	2	11.2	0.65
L-HCEG-P-2824-R	250	28	24	2	13.4	0.78
L-HCEG-P-2830-R	274	28	30	2	16.8	0.97

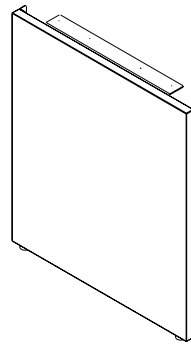

Gallery Panel  
Laminate Gable

**What's Included:**

One (1) ladder gable, one (1) gallery panel mount bracket, (1) surface to gable connector

**How to Specify:**

Laminate Gable Paint Colour: Silver, White, Black, Charcoal

Laminate Gable Laminate Colour: Refer to laminate card for laminate options

End gable (Left hand, right hand)

**Options:**

Heights\*: 25", 28"

Depth: 20", 24", 30"

\*25" high to be used to Tech Drop surface

**Notes:**

Ladder Gable can be used with worksurface with grommet, worksurface without grommet, worksurface for 1" wire play

Code	Price	H	W	D	Weight (lb.)	Volume (ft <sup>3</sup> )
Left hand						
L-HCEG-Y-2520-L	217	25	20	2	10.0	0.58
L-HCEG-Y-2524-L	230	25	24	2	12.0	0.69
L-HCEG-Y-2530-L	253	25	30	2	15.0	0.87
L-HCEG-Y-2812-L	197	28	12	2	11.2	0.39
L-HCEG-Y-2820-L	226	28	20	2	11.2	0.65
L-HCEG-Y-2824-L	242	28	24	2	13.4	0.78
L-HCEG-Y-2830-L	266	28	30	2	16.8	0.97
Right hand						
L-HCEG-Y-2520-R	217	25	20	2	10.0	0.58
L-HCEG-Y-2524-R	230	25	24	2	12.0	0.69
L-HCEG-Y-2530-R	253	25	30	2	15.0	0.87
L-HCEG-Y-2812-R	197	28	12	2	11.2	0.39
L-HCEG-Y-2820-R	226	28	20	2	11.2	0.65
L-HCEG-Y-2824-R	242	28	24	2	13.4	0.78
L-HCEG-Y-2830-R	266	28	30	2	16.8	0.97

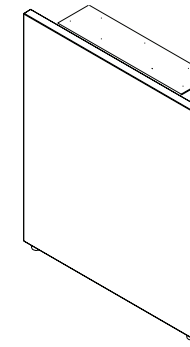

Freestanding Laminate Gable

**What's Included:**

One (1) ladder gable, (1) surface to gable connector

**How to Specify:**

Laminate Gable Paint Colour: Silver, White, Black, Charcoal

Laminate Gable Laminate Colour: Refer to laminate card for laminate options

**Options:**

Heights\*: 25", 28"

Depth: 20", 24", 30"

\*25" is used with the 20" deep surface

**Notes:**

Laminate Gable can be used with worksurface with grommet, worksurface without grommet, worksurface for 1" wire play

Freestanding gable is used when one side of the surface is connected to a panel and the other is open

Code	Price	H	W	D	Weight (lb.)	Volume (ft <sup>3</sup> )
L-HCEG-S-2520	231	25	20	2	10.0	0.58
L-HCEG-S-2524	246	25	24	2	12.0	0.69
L-HCEG-S-2530	270	25	30	2	15.0	0.87
L-HCEG-S-2820	242	28	20	2	11.2	0.65
L-HCEG-S-2824	262	28	24	2	13.4	0.78
L-HCEG-S-2830	285	28	30	2	16.8	0.97

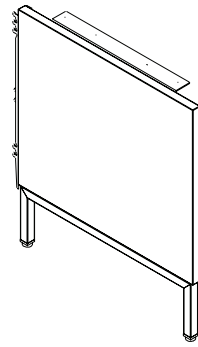

Standard Panel  
Wrap Laminate Gable

**What's Included:**

One (1) wrap gable, one (1) standard panel mount bracket, (1) surface to gable connector

**How to Specify:**

Laminate Gable Paint Colour: Silver, White, Black, Charcoal

Laminate Gable Laminate Colour: Refer to laminate card for laminate options

End gable (Left hand, right hand)

**Options:**

Heights\*: 25", 28"

Depth: 20", 24", 30"

\*25" high to be used to Tech Drop surface

**Notes:**

Laminate Gable can be used with worksurface with grommet, worksurface without grommet, worksurface for 1" wire play

Freestanding gable is used when one side of the surface is connected to a panel and the other is open

Code	Price	H	W	D	Weight (lb.)	Volume (ft <sup>3</sup> )
Left hand						
L-HWEG-P-2520-L	380	25	20	2	10.0	0.58
L-HWEG-P-2524-L	391	25	24	2	12.0	0.69
L-HWEG-P-2530-L	432	25	30	2	15.0	0.87
L-HWEG-P-2820-L	389	28	20	2	11.2	0.65
L-HWEG-P-2824-L	403	28	24	2	13.4	0.78
L-HWEG-P-2830-L	447	28	30	2	16.8	0.97
Right hand						
L-HWEG-P-2520-R	380	25	20	2	10.0	0.58
L-HWEG-P-2524-R	391	25	24	2	12.0	0.69
L-HWEG-P-2530-R	432	25	30	2	15.0	0.87
L-HWEG-P-2820-R	389	28	20	2	11.2	0.65
L-HWEG-P-2824-R	403	28	24	2	13.4	0.78
L-HWEG-P-2830-R	447	28	30	2	16.8	0.97

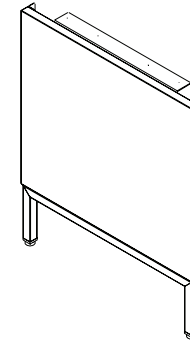

Gallery Panel  
Wrap Laminate Gable

**What's Included:**

One (1) wrap gable, one (1) gallery panel mount bracket, (1) surface to gable connector

**How to Specify:**

Laminate Gable Paint Colour: Silver, White, Black, Charcoal

Laminate Gable Laminate Colour: Refer to laminate card for laminate options

End gable (Left hand, right hand)

**Options:**

Heights\*: 25", 28"

Depth: 20", 24", 30"

\*25" high to be used to Tech Drop surface

**Notes:**

Laminate Gable can be used with worksurface with grommet, worksurface without grommet, worksurface for 1" wire play

Freestanding gable is used when one side of the surface is connected to a panel and the other is open

Code	Price	H	W	D	Weight (lb.)	Volume (ft <sup>3</sup> )
Left hand						
L-HWEG-Y-2520-L	383	25	20	2	10.0	0.58
L-HWEG-Y-2524-L	391	25	24	2	12.0	0.69
L-HWEG-Y-2530-L	432	25	30	2	15.0	0.87
L-HWEG-Y-2820-L	389	28	20	2	11.2	0.65
L-HWEG-Y-2824-L	403	28	24	2	13.4	0.78
L-HWEG-Y-2830-L	448	28	30	2	16.8	0.97
Right hand						
L-HWEG-Y-2520-R	383	25	20	2	10.0	0.58
L-HWEG-Y-2524-R	391	25	24	2	12.0	0.69
L-HWEG-Y-2530-R	432	25	30	2	15.0	0.87
L-HWEG-Y-2820-R	389	28	20	2	11.2	0.65
L-HWEG-Y-2824-R	403	28	24	2	13.4	0.78
L-HWEG-Y-2830-R	448	28	30	2	16.8	0.97

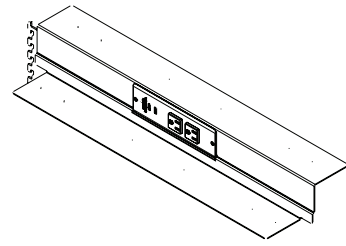

Standard Panel Tech Drop

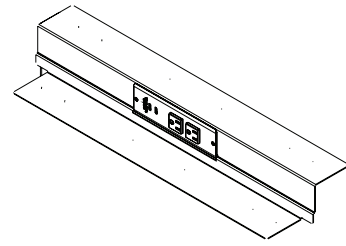

Gallery Panel Tech Drop

**What's Included:**

One (1) tech drop, one (1) power module with two (2) AC outlets and two (2) USB-A outlets, one (1) panel connector hardware

**How to Specify:**

Choose White, Black, Silver, Charcoal for Tech Drop

Left, right

**Options:**

Heights: 3"

Depth\*: 19", 23"

\*19" is used with the 20" deep surface

**Notes:**

Tech drop offers a 3" drop between main surface and return surface

Tech drop must be mounted to the panel

Code	Price	H	W	D	Weight (lb.)	Volume (ft <sup>3</sup> )
Standard Panel Tech Drop - left hand						
L-HSSE-P-19-L	321	3	19.875	4	6.3	0.14
L-HSSE-P-23-L	329	3	23.875	4	7.7	0.17
Standard Panel Tech Drop - right hand						
L-HSSE-P-19-R	321	3	19.875	4	6.3	0.14
L-HSSE-P-23-R	329	3	23.875	4	7.7	0.17
Gallery Panel Tech Drop - left hand						
L-HSSE-Y-19-L	325	3	19.875	4	6.3	0.14
L-HSSE-Y-23-L	333	3	23.875	4	7.7	0.17
Gallery Panel Tech Drop - right hand						
L-HSSE-Y-19-R	325	3	19.875	4	6.3	0.14
L-HSSE-Y-23-R	333	3	23.875	4	7.7	0.17

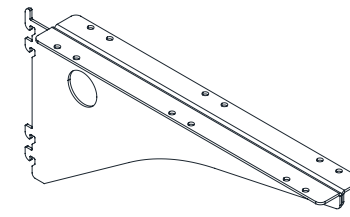

Standard Panel Mounted Cantilever Arm

**What's Included:**

One (1) standard panel mounted cantilever arm

**How to Specify:**

Left, right, mid

**Options:**

Depth: 16", 22"

**Notes:**

Cantilever available in black only

Code	Price	H	W	D	Weight (lb.)	Volume (ft <sup>3</sup> )
intermediate						
L-CCAB-P-16	58	8	16	2	2.6	0.15
L-CCAB-P-22	65	8	22	2	3.5	0.21
left hand						
L-CCAB-P-16-L	58	8	16	1.5	1.9	0.11
L-CCAB-P-22-L	65	8	22	1.5	2.6	0.15
right hand						
L-CCAB-P-16-R	58	8	16	1.5	1.9	0.11
L-CCAB-P-22-R	65	8	22	1.5	2.6	0.15

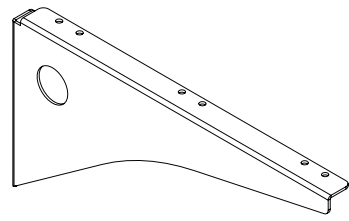

Gallery Panel Mounted Cantilever Arm

**What's Included:**

One (1) gallery panel mounted cantilever arm

**How to Specify:**

Left, right, mid

**Options:**

Depth: 16", 22"

**Notes:**

Cantilever available in black only

Code	Price	H	W	D	Weight (lb.)	Volume (ft <sup>3</sup> )
intermediate						
L-CCAB-Y-16	58	8	16	2	2.6	0.15
L-CCAB-Y-22	65	8	22	2	3.5	0.21
left hand						
L-CCAB-Y-16-L	58	8	16	1.5	1.9	0.11
L-CCAB-Y-22-L	65	8	22	1.5	2.6	0.15
right hand						
L-CCAB-Y-16-R	58	8	16	1.5	1.9	0.11
L-CCAB-Y-22-R	65	8	22	1.5	2.6	0.15

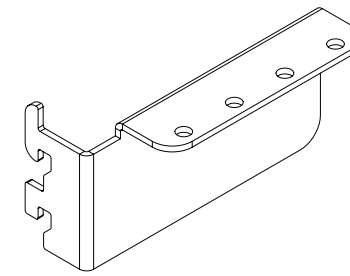

L-HCB  
left hand shown

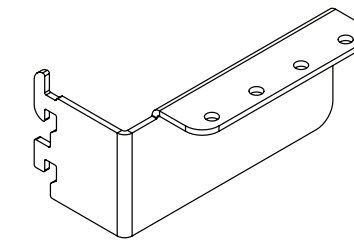

L-HCB1  
left hand shown

**What's Included:**

One (1) standard panel mounted corner bracket

**How to Specify:**

Left, right

Full depth surface, surface with 1" wire play

**Notes:**

Worksurface with 1" wire play requires 1" offset bracket

Corner bracket available in black only

**Options:**

Code	Price	H	W	D	Weight (lb.)	Volume (ft <sup>3</sup> )
L-HCB-P-L	8	3	4	2	0.1	0.01
L-HCB1-P-L	15	3	4	2	0.1	0.01
L-HCB-P-R	8	3	4	2	0.1	0.01
L-HCB1-P-R	15	3	4	2	0.1	0.01

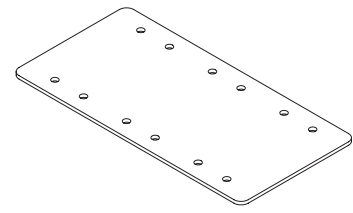

**What's Included:**

One (1) flush plate

**How to Specify:**

Flush Plate Paint Colour: Silver, White, Black, Charcoal

**Notes:**

Flush plate is used at surface joint to connect two surfaces together

**Options:**

Width: 5.5"

Depth: 3"

Code	Price	H	W	D	Weight (lb.)	Volume (ft <sup>3</sup> )
L-PWW	41	3	5.5	0.125	1.0	0.00

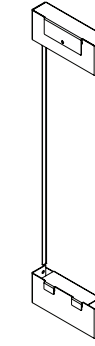
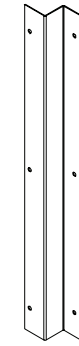

**What's Included:**

24" deep surface: two (2) brackets  
 30" deep surface: three (3) brackets

**How to Specify:**

Available in black only

**Options:**

Width: 3"

**Notes:**

Storage support bracket is used to connect off-modular storage to a surface

Code	Price	H	W	D	Weight (lb.)	Volume (ft <sup>3</sup> )
for standard panel - left hand						
L-HPSP-24-L	47	25	2	24	8.6	0.69
L-HPSP-30-L	86	25	2	30	10.7	0.87
for standard panel -right hand						
L-HPSP-24-R	47	25	2	24	8.6	0.69
L-HPSP-30-R	86	25	2	30	10.7	0.87
for gallery panel						
L-HPGP-24	58	25	2	24	8.6	0.69
L-HPGP-30	121	25	2	30	10.7	0.87



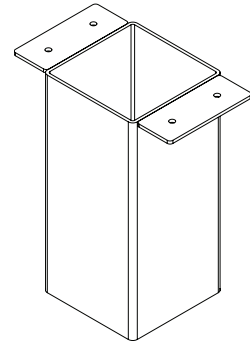

**What's Included:**

One (1) 90 degree bracket

**How to Specify:**

Flush Plate Paint Colour: Silver, White, Black, Charcoal

**Options:**

Height: 8.5"

Width: 4"

Depth: 4"

**Notes:**

Code	Price	H	W	D	Weight (lb.)	Volume (ft <sup>3</sup> )
L-HCFM	168	8.375	7	4	6.0	0.14

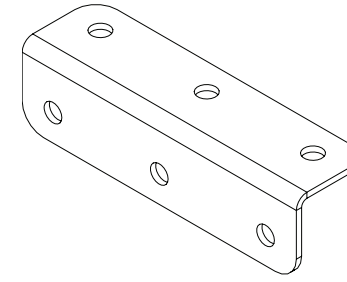

**What's Included:**

One (1) 90 degree bracket

**How to Specify:**

Available in black only

**Options:**

Depth: 3"

**Notes:**

90 degree bracket is used to connect a worksurface to a gallery panel

Code	Price	Specifications	Weight (lb.)	Volume (ft <sup>3</sup> )
L-HSSB	3	3", 6 Holes	0.5	0.09
L-HSSB-24	8	For 24"Deep	2.2	0.09
L-HSSB-30	13	For 30"Deep	3.0	0.09



Switch USA Pricebook  
May 2023  
**Electrics**

Electrics

Power Module	176
Starter Harness	177
Connector Harness	178
Male to Female Extension Harness	180
New York Junction Box	181
Chicago Electrical Box	182
Power Pole	183
Communication Kit	184
Conversion Kit	185

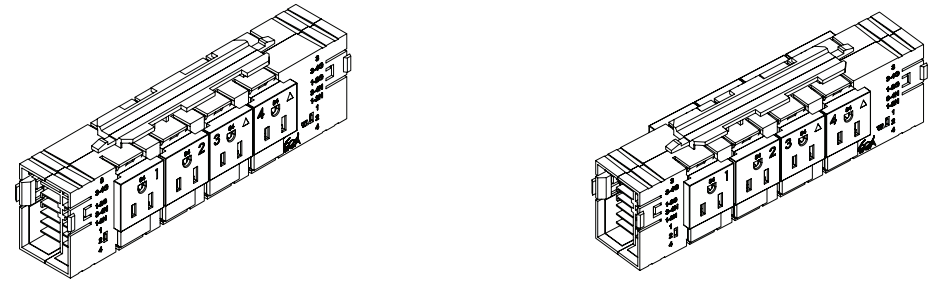

**What's Included:**

One (1) single power module with four (4) ac outlets or one (1) double sided power module with eight (8) ac outlets (four on each side)

**How to Specify:**

Available in grey only  
Single sided, double sided

**Options:**

Width: 8"

**Notes:**

Power modules are installed in the center cut out power capable panels only

Double sided power module has four (4) ac outlets on each side

Refer to Switch electrical specification guide for more information

Code	Price	H	W	D	Weight (lb.)	Volume (ft <sup>3</sup> )
single sided						
L-EM84-S	206	3	6	3	1.7	0.03
double sided						
L-EM84-D	329	3	6	3	2.0	0.03

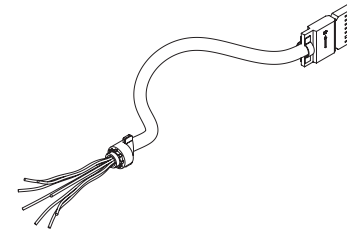

**What's Included:**

One (1) open wire starter harness

**How to Specify:**

Available in grey only  
Single sided, double sided

**Options:**

Length: 72", 168"

**Notes:**

Switch electrical system is rated for 20 amps

Tayco recommends up to 8 workstations hardwired to one power source

Code	Price	L	D	Weight (lb.)	Volume (ft <sup>3</sup> )
L-ES84-072-0	306	72	0.75	2.6	0.40
L-ES84-168-0	384	168	0.75	5.1	0.50

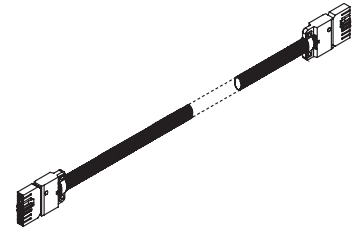

**What's Included:**

One (1) connector harness

**How to Specify:**

Available in grey only

Single sided, double sided

**Options:**

Length: 22"-181" in 3" increments

**Notes:**

Connector harness is used to connect two power modules together

Refer to installation guide for connector harness length calculation

Code	Price	Length	D	Weight (lb.)	Volume (ft <sup>3</sup> )
L-EH84-22	155	22	0.75	0.6	0.20
L-EH84-25	160	25	0.75	0.7	0.20
L-EH84-28	165	28	0.75	0.8	0.20
L-EH84-31	171	31	0.75	0.8	0.20
L-EH84-34	178	34	0.75	0.9	0.20
L-EH84-37	183	37	0.75	1.0	0.20
L-EH84-40	190	40	0.75	1.1	0.20
L-EH84-43	195	43	0.75	1.2	0.20
L-EH84-46	198	46	0.75	1.3	0.20
L-EH84-49	204	49	0.75	1.5	0.20
L-EH84-52	209	52	0.75	1.5	0.20
L-EH84-55	218	55	0.75	1.6	0.20
L-EH84-58	221	58	0.75	1.7	0.20
L-EH84-61	227	61	0.75	1.8	0.20
L-EH84-64	231	64	0.75	1.9	0.20
L-EH84-67	240	67	0.75	1.9	0.20
L-EH84-70	243	70	0.75	2.0	0.20
L-EH84-73	251	73	0.75	2.0	0.20
L-EH84-76	256	76	0.75	2.0	0.20
L-EH84-79	262	79	0.75	2.1	0.20
L-EH84-82	266	82	0.75	2.1	0.20
L-EH84-85	270	85	0.75	2.4	0.20
L-EH84-88	277	88	0.75	2.4	0.20
L-EH84-91	283	91	0.75	2.4	0.20

**Power & Data continued**

Code	Price	Length	D	Weight (lb.)	Volume (ft <sup>3</sup> )
L-EH84-94	288	94	0.75	2.5	0.20
L-EH84-97	294	97	0.75	2.5	0.20
L-EH84-100	299	100	0.75	2.7	0.20
L-EH84-103	305	103	0.75	2.7	0.20
L-EH84-106	311	106	0.75	2.9	0.20
L-EH84-109	317	109	0.75	2.9	0.20
L-EH84-112	321	112	0.75	3.0	0.20
L-EH84-115	328	115	0.75	3.0	0.20
L-EH84-118	334	118	0.75	3.2	0.20
L-EH84-121	339	121	0.75	3.4	0.20
L-EH84-124	343	124	0.75	3.4	0.20
L-EH84-127	351	127	0.75	3.5	0.20
L-EH84-130	358	130	0.75	3.5	0.20
L-EH84-133	361	133	0.75	3.4	0.20
L-EH84-136	366	136	0.75	3.7	0.20
L-EH84-139	373	139	0.75	3.9	0.20
L-EH84-142	377	142	0.75	3.9	0.20
L-EH84-145	385	145	0.75	3.9	0.20
L-EH84-148	513	148	0.75	3.9	0.20
L-EH84-151	519	151	0.75	4.2	0.20
L-EH84-154	525	154	0.75	4.3	0.20
L-EH84-157	531	157	0.75	4.4	0.20
L-EH84-160	536	160	0.75	4.4	0.20
L-EH84-163	541	163	0.75	4.5	0.20
L-EH84-166	547	166	0.75	4.6	0.20
L-EH84-169	553	169	0.75	4.7	0.20
L-EH84-172	558	172	0.75	4.8	0.20
L-EH84-175	564	175	0.75	4.8	0.20
L-EH84-178	568	178	0.75	4.9	0.20
L-EH84-181	575	181	0.75	5.0	0.20

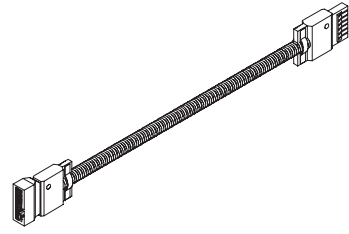

**What's Included:**

One (1) male to female extension harness

**How to Specify:**

Available in grey only  
Single sided, double sided

**Options:**

Length: 44",122"

**Notes:**

Male to female extension harness is used to extend length of the starter harness

Code	Price	Length	D	Weight (lb.)
L-E8FM-044	198	44	0.75	0.3
L-E8FM-122	343	122	0.75	0.6

**What's Included:**

Panels 24", 30", 36" wide: One (1) New York junction box

Panels 42" or wider: One (1) New York junction box with single or double power module

**How to Specify:**

Panels 24", 30", 36" wide: Specify junction box without power module. Power module and starter harness must be specified speratley

Panels 42" or wider: Specify single or double power module with junction box

**Options:**

Junction Box width: 9"

Junction Box with power module width: 18"

**Notes:**

Male to female extension harness is used to extend length of the starter harness

Code	Price	Length	D	Weight (lb.)
L-NY84-004-D	691			
L-NY84-004-S	564			
L-NYEJ-84	196			

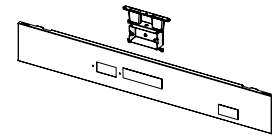

Single sided

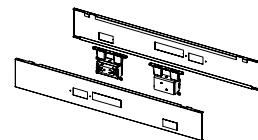

Double sided

**What's Included:**

Single Sided: One (1) electrical box with two (2) ac outlets and one (1) panel raceway

Double Sided: Two (2) single sided electrical boxes each with two (2) ac outlets and two (2) panel raceways

**How to Specify:**

Select corresponding size to match the panel width

**Options:**

Width: 30", 36", 42", 48", 54", 60", 72"

**Notes:**

Junction box is located on the left hand side of the panel

Code	Price	Length	D	Weight (lb.)
<b>Single Sided</b>				
L-JB0X-30-S	325			
L-JB0X-36-S	325			
L-JB0X-42-S	325			
L-JB0X-48-S	325			
L-JB0X-54-S	325			
L-JB0X-60-S	325			
<b>Double Sided</b>				
L-JB0X-30-D	648			
L-JB0X-36-D	648			
L-JB0X-42-D	648			
L-JB0X-48-D	648			
L-JB0X-54-D	648			
L-JB0X-60-D	648			

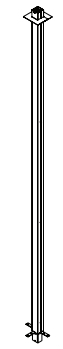

for 3 way connection(3W)

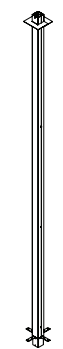

for 4 way connection(4W)

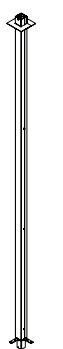

For 90 Degree Connection (N)

**What's Included:**

One (1) power pole, chosen mounting hardware

**How to Specify:**

Specify type based on panel connection: 90 degree, 3-way T, 4 way X and gallery panel mount

90 degree, 3-way T and 4-way X must be used with same height connecting panels

Use gallery panel mount type at the end of a run

**Notes:**

**Options:**

Connector type height: 96", 120"

Gallery panel height: 144"

Code	Price	H	W	D	Weight (lb.)	Volume (ft <sup>3</sup> )
<b>standard panel</b>						
L-EP-P-120-3W	457	120	2	2	2.0	0.28
L-EP-P-120-4W	457	120	2	2	2.0	0.28
L-EP-P-120-N	457	120	2	2	2.0	0.28
L-EP-P-96-3W	411	96	2	2	1.5	0.22
L-EP-P-96-4W	411	96	2	2	1.5	0.22
L-EP-P-96-N	411	96	2	2	2.0	0.22
<b>gallery panel</b>						
L-EP-Y-144	565	144	2	2	2.0	0.33

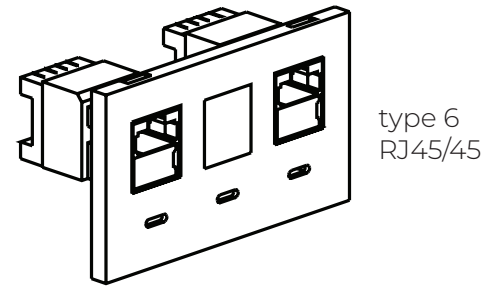
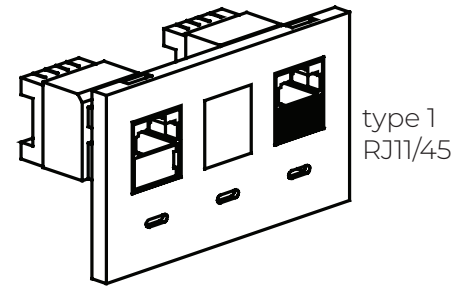

**What's Included:**

One (1) data plate with three (3) openings and chosen combination of RJ11/RJ45

**How to Specify:**

Specify RJ11 for phone connection  
Specify RJ45 for data connection

**Notes:**

Data is placed on the right hand side of the cutout in the panel raceway

**Options:**

Panel cutout width: 2 3/4"

Panel cutout height: 1 3/8"

Code	Price	H	W	D	Weight (lb.)	Volume (ft <sup>3</sup> )
type 1						
L-ECK1	149	2	4	1	0.2	0.00
type 6						
L-ECK6	149	2	4	1	0.2	0.00

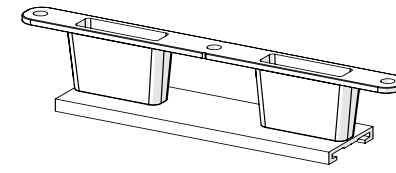

Non-Power Capable to Power Capable Panel Conversion Kit

**What's Included:**

One (1) power module mounting bracket

**How to Specify:**

Specify RJ11 for phone connection  
Specify RJ45 for data connection

**Notes:**

Used to convert a non-power capable panel to a power capable panel

To be placed in the of the non-power capable panel raceway to convert to a power capable

Power module to be specified seperately

**Options:**

Code	Price	Weight (lb.)	Volume (ft <sup>3</sup> )
RI-0300	23		



Switch USA Pricebook  
May 2023  
**Storage**

Storage

Pedestals	188
Underdesk Pedestal	188
Mobile	189
Upholstered Seat Pad	190
Lateral File	191
Underdesk	191
Freestanding	192
Credenza	193
Open Lateral	193
Storage Tower	194
Wardrobe Tower	195
Combo Tower	196
w/ Front Access	196
w/ Side Access	198
Panel Mounted Overheads - Cabinet	200
Flipper	200
Hinged Door	201
Shared	202
Cubby	204
Metal Shelf	205



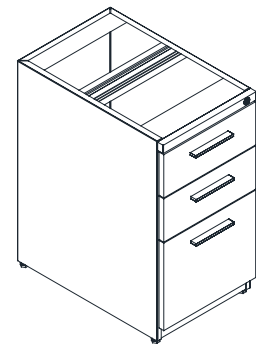

box/box/file

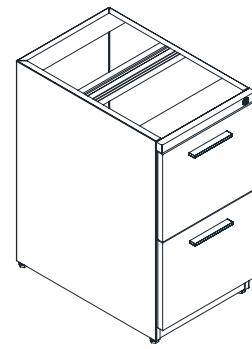

file/file

**What's Included:**

One (1) box/box/file or one (1) file/file underdesk pedestal

**How to Specify:**

Pedestal type: box/box/file, file/file

**Notes:**

Pedestal brackets must be ordered seperately

Locks can be keyed alike or random

**Options:**

Height: 28"

Width: 16"

Depth: 23", 29"

Code	Price	H	W	D	Weight (lb.)	Volume (ft <sup>3</sup> )
box/box/file						
L-FPBU-281623	864	28	16	23	64.4	5.96
L-FPBU-281629	893	28	16	29	81.2	7.52
file/file						
L-FPFU-281623	800	28	16	23	64.4	5.96
L-FPFU-281629	833	28	16	29	81.2	7.52

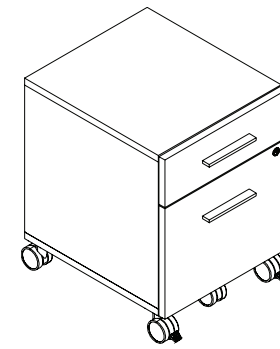

box/ file/no cushion

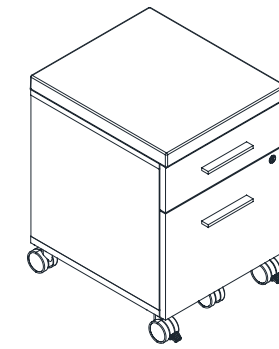

box/file w/ cushion

**What's Included:**

One (1) box/file mobile pedestal or one (1) box/file mobile pedestal with cushion, five (5) lockable casters

**How to Specify:**

With or without cushion

Refer to seating fabric card for cushion fabric selection

Choose handle type and finish

Choose depth

Choose silver or white for caster finish

**Notes:**

Locks can be keyed alike or random

**Options:**

Height: 21" without cushion, 22" with cushion

Width: 16"

Depth: 18"

Code	Price	H	W	D	Weight (lb.)	Volume (ft <sup>3</sup> )
box/file/no cushion						
L-FPLO-211618	881	21	16	18	43.2	3.50
box/file w/ cushion						
L-FPLS-221618	1014	22	16	18	45.3	3.67

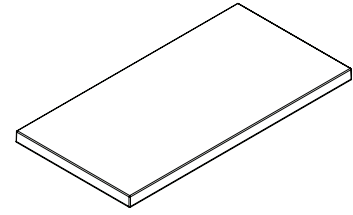

**What's Included:**

One (1) upholstered seat pad

**How to Specify:**

Refer to seating fabric card for fabric selection

**Notes:**

**Options:**

Height:	1"
Width:	24", 30", 36", 48", 60", 72"
Depth:	18"

Code	Price	H	W	D	Weight (lb.)	Volume (ft <sup>3</sup> )
L-PAD-1824	294	24	24	2	2.4	0.67
L-PAD-1830	334	24	30	2	3.0	0.83
L-PAD-1836	374	24	36	2	3.6	1.00
L-PAD-1848	460	24	48	2	4.8	1.33
L-PAD-1860	542	24	60	2	6.0	1.67
L-PAD-1872	628	24	72	2	7.2	2.00

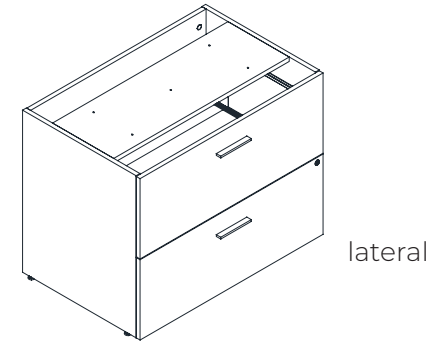

**What's Included:**

One (1) two drawer underdesk lateral filing cabinet, each drawer is equipped with (2) bars for front to back filing

**How to Specify:**

Refer to laminate card for laminate selection  
 Choose handle type and finish  
 Choose depth

**Notes:**

Lateral brackets must be ordered separately  
 Locks can be keyed alike or random

**Options:**

Height:	28"
Width:	30", 36"
Depth:	23", 29"

Code	Price	H	W	D	Weight (lb.)	Volume (ft <sup>3</sup> )
underdesk 2 Drawer						
L-FL2U-283023	1099	28	30	23	107.3	11.18
L-FL2U-283029	1132	28	30	29	135.3	14.10
L-FL2U-283623	1186	28	36	23	128.8	13.42
L-FL2U-283629	1219	28	36	29	162.4	16.92

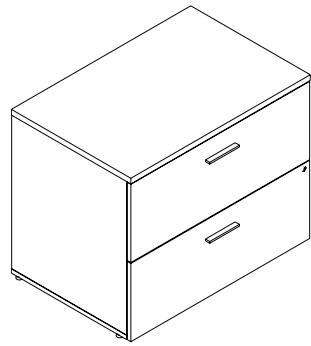

2 Drawer

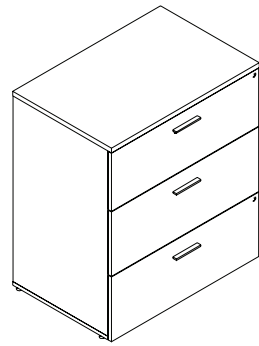

3 drawer

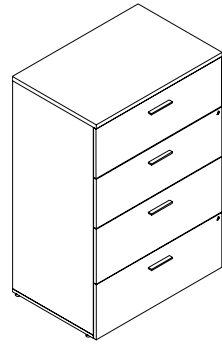

4 drawer

**What's Included:**

One (1) two drawer, three drawer or four drawer freestanding lateral filing cabinet with finished top, each drawer is equipped with (2) bars for front to back filing

**How to Specify:**

- Refer to laminate card for laminate selection
- Choose two drawer, three drawer or four drawers
- Choose handle type and finish
- Choose silver or white for caster finish

**Options:**

- Height: 29" for 2 drawer, 42" for 3 drawer, 54" for 4 drawer
- Width: 30", 36"
- Depth: 24"

**Notes:**

Locks can be keyed alike or random

Code	Price	H	W	D	Weight (lb.)	Volume (ft <sup>3</sup> )
<b>2 Drawer</b>						
L-FL2F-293024	1355	29	30	24	116.0	12.08
L-FL2F-293624	1472	29	36	24	139.2	14.50
<b>3 drawer</b>						
L-FL3F-423024	1746	42	30	24	168.0	17.50
L-FL3F-423624	1885	42	36	24	201.6	21.00
<b>4 drawer</b>						
L-FL4F-543024	2116	54	30	24	216.0	22.50
L-FL4F-543624	2284	54	36	24	259.2	27.00

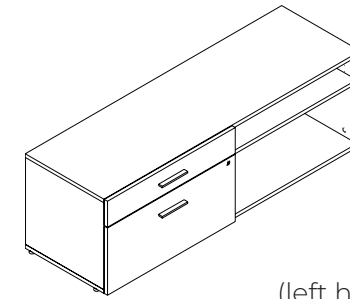

(left hand shown)

**What's Included:**

One (1) open lateral credenza, one (1) adjustable shelf for open cabinet

**How to Specify:**

- Choose right hand or left hand
- Refer to laminate card for laminate selection
- Choose handle type and finish

**Notes:**

- Locks can be keyed alike or random
- Right handed has lateral on right side
- Left handed has lateral on left side
- Can be used as a surface support credenza, with credenza fixed support specified separately

**Options:**

- Height: 20"
- Width: 48", 60", 72"
- Depth: 19"

Code	Price	H	W	D	Weight (lb.)	Volume (ft <sup>3</sup> )
<b>Left hand</b>						
L-CRCL-204818-L	1084	20	48	18	115.2	10.00
L-CRCL-206018-L	1197	20	60	18	144.0	12.50
L-CRCL-207218-L	1308	20	72	18	172.8	15.00
<b>Right hand</b>						
L-CRCL-206018-R	1197	20	60	18	144.0	12.50
L-CRCL-204818-R	1084	20	48	18	115.2	10.00
L-CRCL-207218-R	1308	20	72	18	172.8	15.00

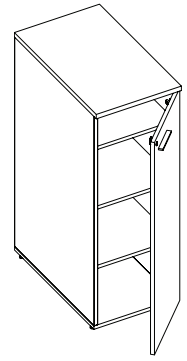

left hand shown

**What's Included:**

One (1) storage tower with one (1) adjustable shelf and (1) fixed shelf for 42" high or two (2) adjustable shelves and (1) fixed shelf for 50" high

**How to Specify:**

- Choose right hand or left hand
- Refer to laminate card for laminate selection
- Choose handle type and finish

**Options:**

Height:	42", 50"
Width:	18"
Depth:	24", 30"

**Notes:**

- Locks can be keyed alike or random
- Right handed has hinge on right side
- Left handed has hinge on left side

Code	Price	H	W	D	Weight (lb.)	Volume (ft <sup>3</sup> )
Left hand						
L-FTSS-421824-L	1357	42	18	24	86.4	10.50
L-FTSS-421830-L	1383	42	18	30	108.0	13.13
L-FTSS-501824-L	1383	50	18	24	102.9	12.50
L-FTSS-501830-L	1399	50	18	30	128.6	15.63
Right hand						
L-FTSS-421824-R	1357	42	18	24	86.4	10.50
L-FTSS-421830-R	1383	42	18	30	108.0	13.13
L-FTSS-501824-R	1383	50	18	24	102.9	12.50
L-FTSS-501830-R	1399	50	18	30	128.6	15.63

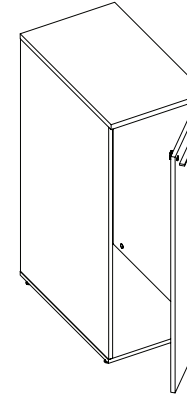

left hand shown

**What's Included:**

One (1) wardrobe tower, one (1) coat bar

**How to Specify:**

- Choose right hand or left hand
- Refer to laminate card for laminate selection
- Choose handle type and finish

**Options:**

Height:	42", 50"
Width:	18"
Depth:	24", 30"

**Notes:**

- Locks can be keyed alike or random
- Right handed has hinge on right side
- Left handed has hinge on left side

Code	Price	H	W	D	Weight (lb.)	Volume (ft <sup>3</sup> )
Left hand						
L-FTCS-421824-L	1071	42	18	24	86.4	10.50
L-FTCS-421830-L	1141	42	18	30	108.0	13.13
L-FTCS-501824-L	1183	50	18	24	102.9	12.50
L-FTCS-501830-L	1260	50	18	30	128.6	15.63
Right hand						
L-FTCS-421824-R	1071	42	18	24	86.4	10.50
L-FTCS-421830-R	1141	42	18	30	108.0	13.13
L-FTCS-501824-R	1183	50	18	24	102.9	12.50
L-FTCS-501830-R	1260	50	18	30	128.6	15.63

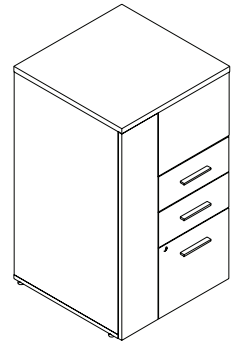

(left hand shown)

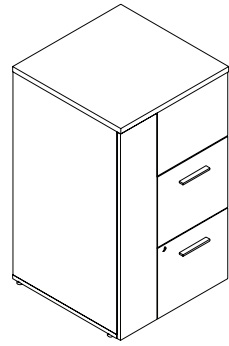

(left hand shown)

**What's Included:**

One (1) combo tower with front access, one (1) coat bar, one (1) adjustable shelf and (1) fixed shelf for 42" high or two (2) adjustable shelves and (1) fixed shelf for 50" high

**How to Specify:**

- Choose right hand or left hand
- Refer to laminate card for laminate selection
- Choose handle type and finish
- Choose box/box/file, file/file drawers

**Notes:**

- Locks can be keyed alike or random
- Right handed has door on right side
- Left handed has door on left side

**Options:**

Height:	42", 50"
Width:	24"
Depth:	24", 30"

Code	Price	H	W	D	Weight (lb.)	Volume (ft <sup>3</sup> )
box/box/file pedestal -left hand						
L-CWTB-422424-L	2275	42	24	24	127.0	14.00
L-CWTB-422430-L	2306	42	24	30	159.0	18.00
L-CWTB-502424-L	2306	50	24	24	152.0	17.00
L-CWTB-502430-L	2334	50	24	30	189.0	21.00
box/box/file pedestal - right hand						
L-CWTB-422424-R	2275	42	24	24	127.0	14.00
L-CWTB-422430-R	2306	42	24	30	159.0	18.00
L-CWTB-502424-R	2306	50	24	24	152.0	17.00
L-CWTB-502430-R	2334	50	24	30	189.0	21.00
file/file pedestal - left hand						
L-CWTF-422424-L	2254	42	24	24	127.0	14.00
L-CWTF-422430-L	2254	42	24	30	159.0	18.00
L-CWTF-502424-L	2254	50	24	24	152.0	17.00
L-CWTF-422430-L	2254	42	24	30	159.0	18.00
file/file pedestal - right hand						
L-CWTF-422424-R	2254	42	24	24	127.0	14.00
L-CWTF-422430-R	2254	42	24	30	159.0	18.00
L-CWTF-502424-R	2254	50	24	24	152.0	17.00
L-CWTF-502430-R	2254	50	24	30	189.0	21.00

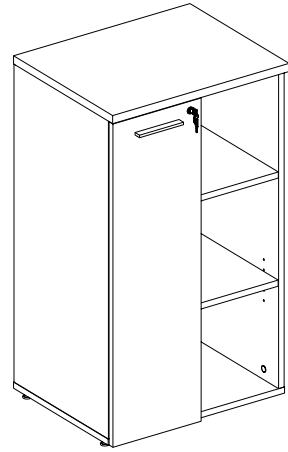

left hand shown

**What's Included:**

One (1) combo tower with side access, one (1) coat bar, (1) box/box/file or (1) file/file drawers, (1) cubby for 42" high or two (2) cubbies for 50" high

**How to Specify:**

- Choose right hand or left hand
- Refer to laminate card for laminate selection
- Choose handle type and finish
- Choose box/box/file, file/file drawers

**Notes:**

- Locks can be keyed alike or random
- Right handed has door on right side
- Left handed has door on left side

**Options:**

Height:	42", 50"
Width:	24"
Depth:	18.75", 24", 30"

Code	Price	H	W	D	Weight (lb.)	Volume (ft <sup>3</sup> )
Left Hand						
L-FTCO-422418-L	1106	41	24	18.75	85.0	11.00
L-FTCO-422424-L	1229	41	24	24	101.0	14.00
L-FTCO-422430-L	1379	41	24	30	121.0	17.00
L-FTCO-502418-L	1275	49	24	18.75	97.0	13.00
L-FTCO-502424-L	1416	49	24	24	115.0	16.00
L-FTCO-502430-L	1588	49	24	30	138.0	21.00
Right hand						
L-FTCO-422418-R	1106	41	24	18.75	85.0	11.00
L-FTCO-422424-R	1229	41	24	24	101.0	14.00
L-FTCO-422430-R	1379	41	24	30	121.0	17.00
L-FTCO-502418-R	1275	49	24	18.75	97.0	13.00
L-FTCO-502424-R	1416	49	24	24	115.0	16.00

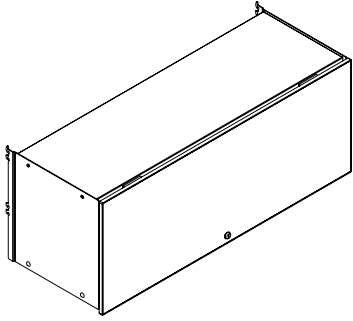

**What's Included:**

One (1) flipper cabinet

**How to Specify:**

Choose metal or laminate face

Choose white, black, silver, charcoal for metal face and body

Refer to laminate card for laminate face options

**Notes:**

Locks can be keyed alike or random

Flipper cabinet slides are easy-down pneumatic

**Options:**

Height\*: 16"

Width: 30", 36", 42", 48", 54", 60"

Depth\*\*: 15"

\* Internal cabinet height is 13"

\*\* Internal cabinet depth is 13"

Code	Price	H	W	D	Weight (lb.)	Volume (ft <sup>3</sup> )
laminate face w/pneumatic slides						
L-SPFL-1530-P	582	16	30	15	32.7	4.17
L-SPFL-1536-P	585	16	36	15	39.3	5.00
L-SPFL-1542-P	607	16	42	15	45.8	5.83
L-SPFL-1548-P	613	16	48	15	52.4	6.67
L-SPFL-1554-P	636	16	54	15	58.9	7.50
L-SPFL-1560-P	642	16	60	15	65.5	8.33
metal face w/pneumatic slides						
L-SPFM-1530-P	592	16	30	15	32.7	4.17
L-SPFM-1536-P	609	16	36	15	39.3	5.00
L-SPFM-1542-P	628	16	42	15	45.8	5.83
L-SPFM-1548-P	649	16	48	15	52.4	6.67
L-SPFM-1554-P	663	16	54	15	58.9	7.50
L-SPFM-1560-P	684	16	60	15	65.5	8.33

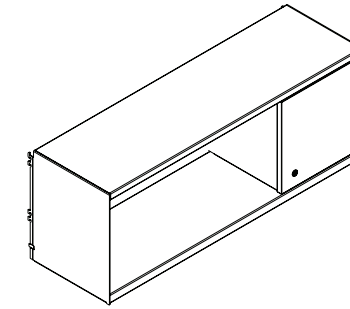
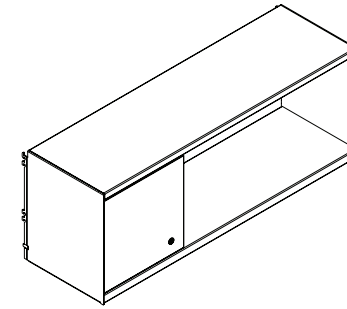

**What's Included:**

One (1) hinged cabinet, one (1) 12" wide hinged door

**How to Specify:**

Choose white, black, silver, charcoal for metal body

Refer to laminate card for laminate face options

Door on right or left side

**Notes:**

Locks can be keyed alike or random

OL refers to open on left side

LO refers to open on right side

**Options:**

Height\*: 16"

Width: 36", 42", 48", 54", 60"

Depth\*\*: 12"

\* Internal cabinet height is 13"

\*\* Internal cabinet depth is 12"

Code	Price	H	W	D	Weight (lb.)	Volume (ft <sup>3</sup> )
closed/open						
L-SPLO-1536	836	16	36	15	43.2	5.00
L-SPLO-1542	893	16	42	15	50.4	5.83
L-SPLO-1548	914	16	48	15	57.6	6.67
L-SPLO-1554	979	16	54	15	64.8	7.50
L-SPLO-1560	993	16	60	15	72.0	8.33
open/closed						
L-SPOL-1536	836	16	36	15	43.2	5.00
L-SPOL-1542	893	16	42	15	50.4	5.83
L-SPOL-1548	914	16	48	15	57.6	6.67
L-SPOL-1554	979	16	54	15	64.8	7.50
L-SPOL-1560	993	16	60	15	72.0	8.33

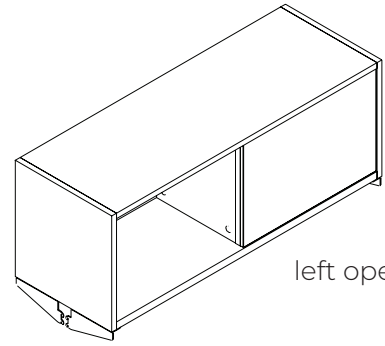

left open/right tackboard

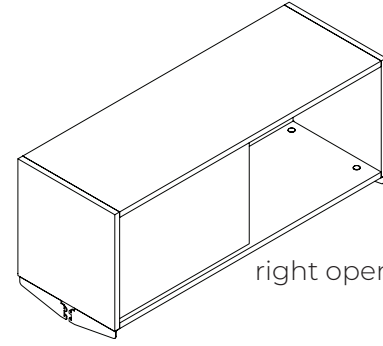

right open/ left melamine

**What's Included:**

One (1) shared cabinet, (1) tackboard if tackboard option is selected, four (4) panel mount cantilevers for up to 60"W or six (6) panel mount cantilevers for 66", 72"W

**How to Specify:**

- Choose white, black, silver, charcoal for cantilever
- Refer to laminate card for laminate face options
- Refer to panel fabric card for tackboard fabric options

**Notes:**

- OM refers to open on left side
- MO refers to open on right side
- OT refers to open on left side with tackboard on right side
- TO refers to open on right side with tackboard on left side

**Options:**

Height*:	16"
Width:	36", 42", 48", 54", 60", 66", 72
Depth**:	15"

\* Internal cabinet height is 13"      \*\* Internal cabinet depth is 13.5"

Code	Price	H	W	D	Weight (lb.)	Volume (ft <sup>3</sup> )
left open/right tackboard						
L-STOT-161536	717	16	36	15	43.2	5.00
L-STOT-161542	763	16	42	15	50.4	5.83
L-STOT-161548	807	16	48	15	57.6	6.67
L-STOT-161554	851	16	54	15	64.8	7.50
L-STOT-161560	895	16	60	15	72.0	8.33
L-STOT-161566	942	16	66	15	79.2	9.17
L-STOT-161572	988	16	72	15	86.4	10.00
right open/ left tackboard						
L-STTO-161536	717	16	36	15	43.2	5.00
L-STTO-161542	763	16	42	15	50.4	5.83
L-STTO-161548	807	16	48	15	57.6	6.67
L-STTO-161554	851	16	54	15	64.8	7.50
L-STTO-161560	895	16	60	15	72.0	8.33
L-STTO-161566	942	16	66	15	79.2	9.17
L-STTO-161572	988	16	72	15	86.4	10.00

Code	Price	H	W	D	Weight (lb.)	Volume (ft <sup>3</sup> )
right open/left melamine						
L-STMO-161536	540	16	36	15	43.2	5.00
L-STMO-161542	582	16	42	15	50.4	5.83
L-STMO-161548	618	16	48	15	57.6	6.67
L-STMO-161554	662	16	54	15	64.8	7.50
L-STMO-161560	703	16	60	15	72.0	8.33
L-STMO-161566	745	16	66	15	79.2	9.17
L-STMO-161572	788	16	72	15	86.4	10.00
left open/right melamine						
L-STOM-161536	540	16	36	15	43.2	5.00
L-STOM-161542	582	16	42	15	50.4	5.83
L-STOM-161548	618	16	48	15	57.6	6.67
L-STOM-161554	662	16	54	15	64.8	7.50
L-STOM-161560	703	16	60	15	72.0	8.33
L-STOM-161566	745	16	66	15	79.2	9.17
L-STOM-161572	788	16	72	15	86.4	10.00



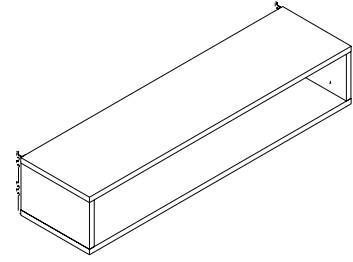

**What's Included:**

One (1) open cubby, two (2) mounting brackets

**How to Specify:**

Refer to laminate card for laminate face options

**Notes:**

**Options:**

Height*:	8"
Width:	24", 30", 36", 42", 48"
Depth**:	11"

\* Internal cabinet height is 6.5"

\*\* Internal cabinet depth is 11"

Code	Price	H	W	D	Weight (lb.)	Volume (ft <sup>3</sup> )
L-SCS-081124	318	8	24	15	24.0	1.67
L-SCS-081130	333	8	30	15	27.0	2.08
L-SCS-081136	348	8	36	15	30.0	2.50
L-SCS-081142	362	8	42	15	33.0	2.92
L-SCS-081148	378	8	48	15	36.0	3.33

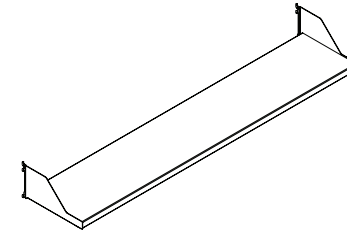

**What's Included:**

One (1) metal shelf

**How to Specify:**

Choose white, black, silver, charcoal for metal shelf

**Notes:**

**Options:**

Height:	6"
Width:	30", 36", 42", 48", 54", 60"
Depth:	12"

Code	Price	H	W	D	Weight (lb.)	Volume (ft <sup>3</sup> )
L-SOOM-1230	312	2	30	12	14.4	0.42
L-SOOM-1236	328	2	36	12	17.3	0.50
L-SOOM-1242	341	2	42	12	20.2	0.58
L-SOOM-1248	352	2	48	12	23.0	0.67
L-SOOM-1254	366	2	54	12	25.9	0.75
L-SOOM-1260	380	2	60	12	28.8	0.83



Switch USA Pricebook  
May 2023  
**Accessories**

Accessories

Cable manager	208
Desktop Power Module	209
Tasklight	210
Monitor Arm	211
Keyboard Tray	212
Accessories	213
Accessory Rail	214
Pencil Tray	215

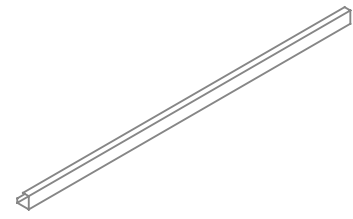

**What's Included:**

One (1) cable manager

**How to Specify:**

Available in black only

**Dimensions:**

length 12", 18", 24", 30", 36", 42", 48", 54", 60", 66", 72"

Code	Price	H	W	D	Weight (lb.)	Volume (ft <sup>3</sup> )
L-EWHB-12	8	1.5	12	1.5	0.2	0.02
L-EWHB-18	11	1.5	18	1.5	0.3	0.02
L-EWHB-24	14	1.5	24	1.5	0.4	0.03
L-EWHB-30	17	1.5	30	1.5	0.5	0.04
L-EWHB-36	21	1.5	36	1.5	0.6	0.05
L-EWHB-42	25	1.5	42	1.5	0.7	0.05
L-EWHB-48	28	1.5	48	1.5	0.8	0.06
L-EWHB-54	31	1.5	54	1.5	0.9	0.07
L-EWHB-60	35	1.5	60	1.5	1.0	0.08
L-EWHB-66	39	1.5	66	1.5	1.1	0.09
L-EWHB-72	41	1.5	72	1.5	1.2	0.09

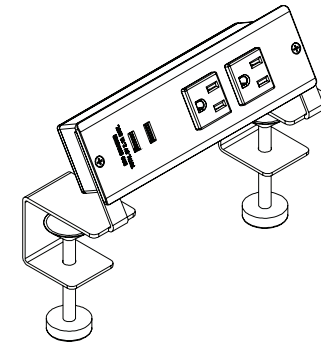

V-EMW-2

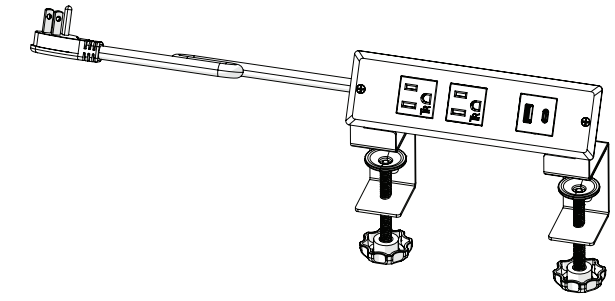

V-EMW-2AC

**What's Included:**

One (1) clamp mount desktop power module equipped with 2 ac outlets and 2 USB charging ports and one (1) three prong cord

**How to Specify:**

Can be used on freestanding surface or surface with 1" wireplay if connected to a panel

Available in black only

**Dimensions:**

Cord length: 120"

Power Module Width: 8"

**Notes:**

Clamp requires 1 3/4" x 8 1/8" undersurface clearance

Code	Price	H	W	D	Volume	Weight
clamp mount desktop power module (2 AC outlets and 1 ea USB A & C ports)						
V-EMW-2AC	173	6	4	3	1	0.04
clamp mount desktop power module (2 AC outlets and 2 USB A ports)						
V-EMW-2	173	6	4	3	1	0.04

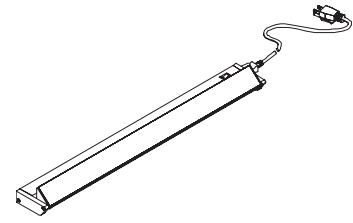

**What's Included:**

One (1) fluorescent task light

**How to Specify:**

One size smaller than the width of the overhead

Available in silver only

**Dimensions:**

Length: 24", 36", 48"

**Notes:**

Task light can be mounted to metal or laminate overheads

Task light mounts to metal overheads using supplied magnets

Code	Price	H	W	D	Weight (lb.)	Volume (ft <sup>3</sup> )
V-ELU-24	285	3	24	1	9.5	0.04
V-ELU-36	321	3	36	1	13.7	0.06
V-ELU-48	403	3	48	1	17.9	0.08

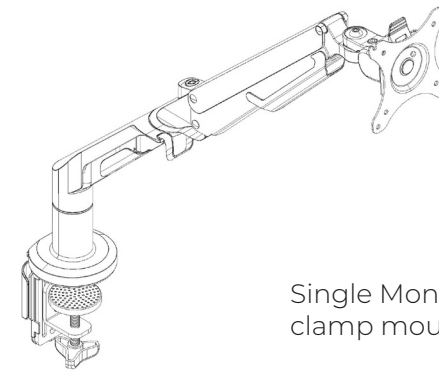

Single Monitor Arm - clamp mount

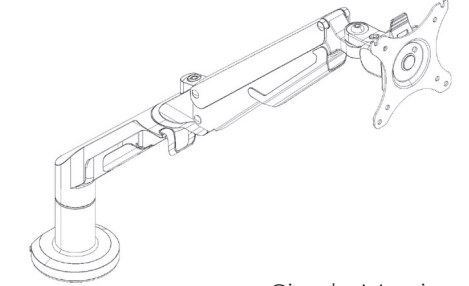

Single Monitor Arm - grommet mount

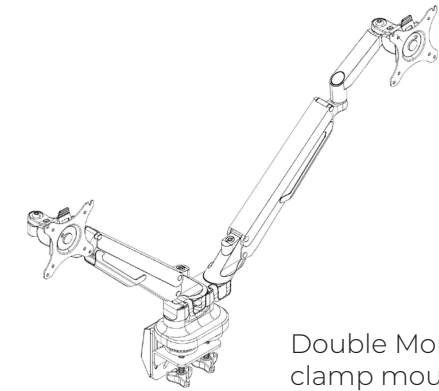

Double Monitor Arm - clamp mount

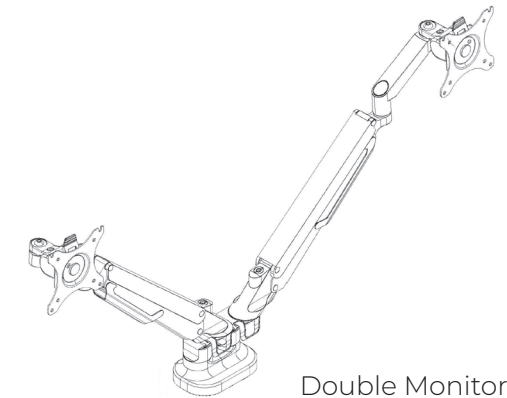

Double Monitor Arm - grommet mount

**What's Included:**

One monitor arm and installation hardware for both clamp and grommet mount

**How to Specify:**

- Specify type

**Notes:**

Available in silver and black

Single Monitor Arm

- Screen Size - 17"-36"
- Load Capacity - 6.6-26.4lbs/3-12kg
- Tilt Range - -90 degrees - -15 degrees

Dual Monitor Arm

- Screen Size - 17"-32"
- Load Capacity - 4.4-19.8lbs/2-9kg
- Tilt Range - -90 degrees - -15 degrees

**Dimensions:**

Vesa: 75x75 and 100x100

Code	Price
Monitor Arm - Single Mount	
V-AFMA-01	353
Monitor Arm - Double Mount	
V-AFMA-02	589

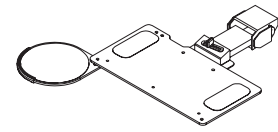

left hand shown

**What's Included:**

One (1) adjustable keyboard tray

**How to Specify:**

Left hand, right hand  
Available in black only

**Notes:**

Can not be used with tables with reinforcement bars

**Dimensions:**

Width: 20"  
Depth: 11"

Code	Price	H	W	D	Weight (lb.)	Volume (ft <sup>3</sup> )
V-KAS0-2011-L	593	12	12	12	3	1
V-KAS0-2011-R	593	12	12	12	3	1

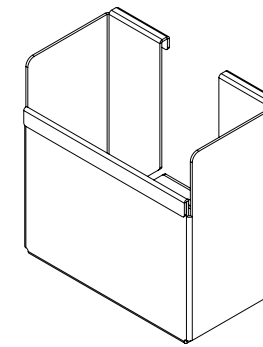

pencil holder

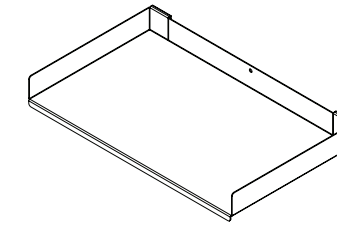

paper tray - legal

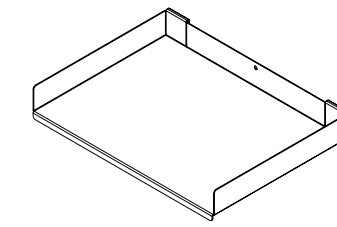

paper tray - letter

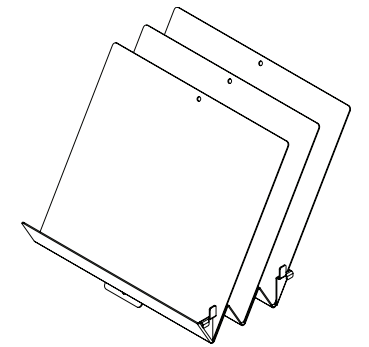

document sorter

**What's Included:**

One (1) paper tray or one (1) paper holder or one (1) paper sorter

**How to Specify:**

Refer to metal paint card for metal paint colors

**Notes:**

**Dimensions:**

Code	Price	H	W	D	Weight (lb.)	Volume (ft <sup>3</sup> )
pen holder						
L-AAP0	129	6	4	2	0.3	
paper tray - legal						
L-AAP-13	152	11	13	1	3.2	
paper tray - letter						
L-AAP-9	134	11	9	1	2.1	
paper sorter						
L-AAS	229	10	10	10	3.2	

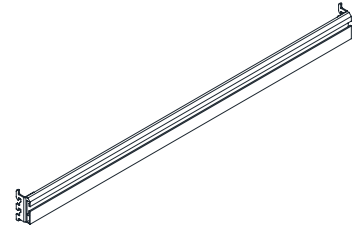

**What's Included:**

One (1) panel mount or wall mount accessory rail

**How to Specify:**

Panel mount, wall mount

Choose black, silver, white or charcoal for accessory rail color

**Notes:**

**Dimensions:**

Width: 24", 30", 36", 42", 48", 54", 60"

Code	Price	H	W	D	Weight (lb.)	Volume (ft <sup>3</sup> )
<b>Panel Mounted</b>						
L-AR-24	189	3	24	0.75	0.8	
L-AR-30	196	3	30	0.75	0.9	
L-AR-36	202	3	36	0.75	1.0	
L-AR-42	212	3	42	0.75	1.0	
L-AR-48	220	3	48	0.75	1.1	
L-AR-54	228	3	54	0.75	1.2	
L-AR-60	238	3	60	0.75	1.3	
<b>Wall Mounted</b>						
L-AR-24-W	189	3	24	0.75	0.8	
L-AR-30-W	196	3	30	0.75	0.9	
L-AR-36-W	202	3	36	0.75	1.0	
L-AR-42-W	212	3	42	0.75	1.0	
L-AR-48-W	220	3	48	0.75	1.1	
L-AR-54-W	228	3	54	0.75	1.2	
L-AR-60-W	238	3	60	0.75	1.3	

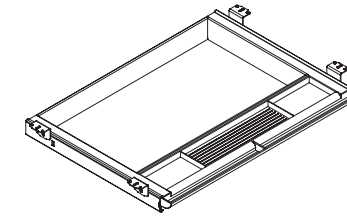

**What's Included:**

One (1) pencil tray

**How to Specify:**

Available in black only

**Notes:**

Available in black only

**Dimensions:**

Width: 24"

Depth: 16"

Code	Price	H	W	D	Weight (lb.)	Volume (ft <sup>3</sup> )
V-ADPP	83	14	21	2	1.8	0.34