



Metro Pricebook

February 2023

Contract# - 99999-001-SPD0000198-0081
Bidder ID - 0000660069



contents

Caution	7
Overview	8
Statement of Line	13
Step-by-step order placement	31
Straight Desk	32
straight executive	34
straight professional	36
straight partial modesty executive	38
straight partial modesty professional	40
straight full recessed modesty executive	42
straight full recessed modesty professional	44
arc full recessed modesty executive	46
arc full recessed modesty professional	47
Tables	48
D-table executive	50
D-table professional	51
J-table executive	52
J-table professional	53
P-table executive	54
P-table professional	55
F-table executive	56
F-table professional	57
U-table executive	58
U-table professional	59
C-table executive	60
C-table professional	61
Corners	62
straight front corner full modesty executive	64
straight front corner full modesty professional	65
straight front corner partial modesty executive	66
straight front corner partial modesty professional	67
straight front corner full modesty no gables executive	68

straight front corner full modesty no gables professional	69
curved front corner full modesty executive	70
curved front corner full modesty professional	71
curved front corner partial modesty executive	72
curved front corner partial modesty professional	73
curved front corner full modesty no gables executive	74
curved front corner full modesty no gables professional	75
Unitized Desks	76
curved front w/full modesties, full and partial gables executive	78
curved front w/full modesties, full and partial gables professional	79
curved front w/full modesties, no gables executive	80
curved front w/full modesties, no gables professional	81
curved front w/partial modesty executive	82
curved front w/ partial modesties professional	83
Bridges	84
bowed bridge full modesty executive	86
bowed bridge full modesty professional	87
bowed bridge partial modesty executive	88
bowed bridge partial modesty professional	89
Returns	90
straight return full modesty executive	92
straight return full modesty professional	94
straight return partial modesty executive	96
straight return partial modesty professional	98
double lateral file executive	102
double lateral file professional	103
double storage cabinet executive	104
double storage cabinet professional	105
lateral file and storage cabinet executive	106
lateral file and storage cabinet professional	107
lateral file and storage cabinet executive	108
lateral file and storage cabinet professional	109
tops executive	110
tops professional	111
open w door executive	112
open w door professional	112

Supports	114
intermediate support	116
cantilever	117
reinforcement bar	118
Filing & Storage	120
pedestals	122
pedestals w/ seat cushion	124
underdesk storage cabinet	125
underdesk combo pedestal BBF & FF	126
underdesk 2-drawer lateral file	127
freestanding storage cabinet executive	128
freestanding storage cabinet professional	129
freestanding combo pedestal BBF & FF executive	130
freestanding combo pedestal BBF & FF professional	131
freestanding 2-drawer lateral file executive	132
freestanding 2-drawer lateral file professional	133
freestanding 3-drawer lateral file executive	134
freestanding 3-drawer lateral file professional	135
freestanding 4-drawer lateral file executive	136
freestanding 4-drawer lateral file professional	137
freestanding storage tower executive	138
freestanding storage tower professional	139
freestanding combo storage tower BBF executive	140
freestanding combo storage tower BBF professional	141
freestanding combo storage tower FF executive	142
freestanding combo storage tower FF professional	143
freestanding wardrobe storage tower executive	144
freestanding wardrobe storage tower professional	145
freestanding storage tower double door executive	146
freestanding storage tower double door professional	147
freestanding combo lateral storage double door executive	148
freestanding combo lateral storage double door professional	149
freestanding combo lateral storage glazed double door executive	150
freestanding combo lateral storage glazed double door professional	151
bookcase executive	152
bookcase professional	154

Overhead Storage	156
open hutch executive	158
open hutch professional	159
hinged door hutch executive	160
hinged door hutch professional	161
glazed door hutch executive	162
glazed door hutch professional	163
open hutch w/ pidgeon holes executive	164
open hutch w/ pidgeon holes professional	165
hinged door hutch w/ pidgeon holes executive	166
hinged door hutch w/ pidgeon holes professional	167
wall mounted hinged door hutch executive	168
wall mounted hinged door hutch professional	169
wall mounted glazed door hutch executive	170
wall mounted glazed door hutch professional	171
Tabletops	172
1.5" Straight Tabletop w/ Grommet executive	174
1" Straight Tabletop w/ Grommet professional	176
1.5" Straight Tabletop - no grommets executive	178
1" Straight Tabletop - no grommets professional	180
1.5" D-Tabletop executive	182
1" D-Tabletop professional	183
1.5" O-Tabletop executive	184
1" O-Tabletop professional	185
Bases	186
cross base	188
post support base	189
open metal gable	190
Reception Unit	192
executive	194
professional	195
Service Write Up Desk	196
w/ Straight Front Countertop executive	198
w/ Straight Front Countertop professional	199
w/ Arc Countertop executive	200
w/ Arc Countertop professional	201

Coffee & End Tables	202
coffee and end table executive	204
coffee and end table professional	205
Conference	206
table top	208
straight tabletop	208
straight tabletop w/power and data	210
boat-shaped tabletop	212
boat-shaped tabletop w/power and data	214
racetrack tabletop	216
racetrack tabletop w/power and data	218
tapered tabletop	220
tapered tabletop w/ power and data	221
table base	222
gable & modesty base	222
elliptical base	226
table base configuration	230
options	231
Ellora Grommet add-ons	231
filing and storage	232
serving cabinet	232
storage cabinet w/shelves	233
combo cabinet w/storage & lateral files	234
double door cabinet w/shelves	235
combo cabinet	236
storage cabinet w/coat bar and shelves	237
presentation tools	238
whiteboard cabinet	238
computer desk	239
Accessories	240
keyboard tray	242
tackboard for hutch	243
pencil drawer	244
task light	245
monitor arm	246
wire manager	247

Caution

Load Bottom Drawer First

- Operate one drawer at a time
- Units may tip if loaded incorrectly
- Units should be attached to a wall or other furniture to reduce tipping hazard
- Always load the heaviest files in the bottom drawer

Heavy Load

- Some products must be anchored to wall to ensure stability & safety.
- It is the owner and installers responsibility to ensure that the wall type and construction is of sufficient strength to carry the loads of any wall mounted products and their contents.
- Failure of the wall and anchors to support all imposed loads may result in property damage and/or personal injury.
- Tayco can provide size and empty weight of its products only. As wall blocking is considered a building construction process, Tayco cannot provide recommendations in this respect and cannot be responsible for damage or injury that may occur as a result of improper installation and/or blocking.

Instability Hazard

Mobile items on casters such as flip top, personal and movable tables of any type and storage items of any type may present an instability hazard if not secured correctly while in use or in storage. Flip top tables or training tables of any type, are inherently more unstable when folded. Tayco provides the following guidelines & warnings when using mobile products:

- Lock casters immediately after moving. Do not leave the casters unlocked when in use or in storage.
- Motion may increase the instability of any item with casters. If the wheels hit an obstruction the table's forward momentum often causes overturn, especially if the item is not equipped with wheel extensions. Exercise strong caution while moving these items.
- Use caution when abrupt level changes in the floor are present (such as a doorway or room threshold) as caster failure or tipping may result.
- Do not stand, sit or lean on mobile items for support. They are not intended for this use and personal injury or property damage may result.
- Mobile units that feature height adjustable elements must be lowered to the minimum compressed height when moving to prevent instability. It is also recommended the user remove all computer equipment or other accessories to prevent possible weight imbalance or damage to equipment.
- Failure to follow the guidelines above may result in property damage or personal injury.

Overview

Tayco introduces Metro, a full line of case goods and conference furniture.

Metro is divided into three distinct product groups for ease of specifying: Executive, Professional and Conference. The prefix of the product code indicates the product group.

- T – Metro Executive
- TL – Metro Professional
- TB – Metro Conference

Metro Executive and Professional series contain the building blocks for the CEO's office, a flexible team environment or a welcoming reception area. An abundance of freestanding storage towers are available for places to hang your coat, file important papers or store personal items. Whether you need to create an impression, save space or encourage collaboration, Metro does it all.

Metro Conference can be formal or casual, a place for working meetings, video-conferencing or large presentations. It customizes to your needs through a wide selection of sizes and mix-and-match table shapes and base styles. Cabinetry has been made larger to match the proportions of the conference room. Accessory items such as audiovisual cabinets, mobile media centers, lecterns, whiteboards and serving cabinets round out the line.

Metro Executive and Conference feature 1.5"-thick worksurfaces, hutch and freestanding storage tops. These items also have a choice of Straight or Gothic trim styles. Metro Professional has 1"-thick worksurfaces, hutch tops, filing and storage tops with a straight 2-mm vinyl edge.

desks, returns, bridges and credenzas

Desks are available with a choice of recessed or flush modesties. Metro desks, end gables and modesties are made with 45 lb./cubic foot density industrial-grade composite wood core, finished on both sides. Many pieces are available with partial or full modesties. Partial modesties (12"H) should be ordered only for pieces located next to a wall. Otherwise, full modesties should be used.

pedestals

All pedestal drawers are outfitted with full extension slides. Drawers can be easily removed by releasing the small catches on either side of the slide. Pedestals come standard with locks. One lock will lock both file drawers in a file/file pedestal and one box drawer and the file drawer in the box/box/file pedestal. File drawers will accommodate legal- or letter-size documents.

freestanding storage and combo cabinets

Various combination filing and storage units provide a place to hang a coat, store personal items and documents to suit any individual's needs.

intermediate gable supports

Some configurations require the use of an intermediate gable support. This support must be ordered separately. The situations requiring an intermediate gable support are:

- > For use under surfaces 60" wide or greater where there is no filing or storage to support the worksurface (see picture 1). This applies to Metro Professional only. The intermediate support is not necessary for Metro Executive configurations, unless a hutch is placed over a bridge or return surface (see picture 2).

surfaces 60" wide or greater

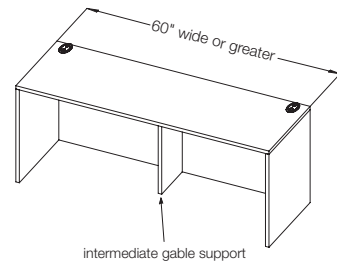

picture 1

under surfaces with a hutch

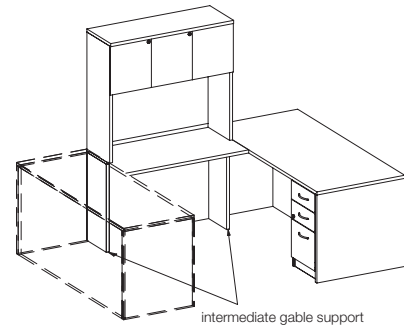

picture 2

- > Under return surfaces where the return meets the primary desk or Peninsula table. This applies to Metro Professional only.

The 12" wide intermediary gable is for 21"- and 24"-deep surfaces and the 18"-wide intermediate gable is used with 30"- and 36"-deep worksurfaces.

universal gable support

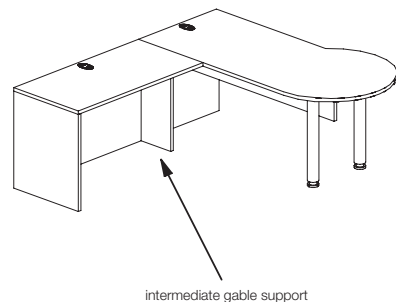

picture 3

accessories

Computer accessories include flat-screen monitor arms, articulating keyboard trays and CPU holders.

Heavy-duty flat-screen monitor arms adjust to the user while storing wires within the arm. The monitor mounting plate meets VESA standards to accommodate most monitors. Monitor arms can be grommet- or clamp-mounted to the worksurface. Articulating and retractable keyboard trays and mobile or underdesk-mounted CPU holders complete the workstation.

Hutch-mounted tackboards can be finished in any Tayco standard fabric to match the office decor. The conference room whiteboard comes standard with a dry erase board and two fabric-wrapped tackboards.

Standard task lights are available in two sizes and come with vertical wire management. An optional task light is available.

hutches and cabinets

Hutch and cabinet doors come in a choice of classic laminate or aluminum-framed frosted acrylic. Hutches with laminate doors always come standard with locking doors.

Hutches come open or closed, with or without pigeonholes and a flexible apron for wire management. Optional hutch mounted tackboards finished in any of Tayco fabrics can be ordered to complete the look.

coffee and end tables

Metro coffee and end tables coordinate with reception units and are available with or without a fixed shelf.

bookcases

Straight and radius bookcases have height-adjustable shelves with the exception of any desk-height shelves. They are fixed to add structural stability to the bookcase.

handle details

Six handle options are available in choice of colors. Melbourne is the standard handle option unless otherwise specified on your Purchase Order. All Executive and Professional handles are 5" long.

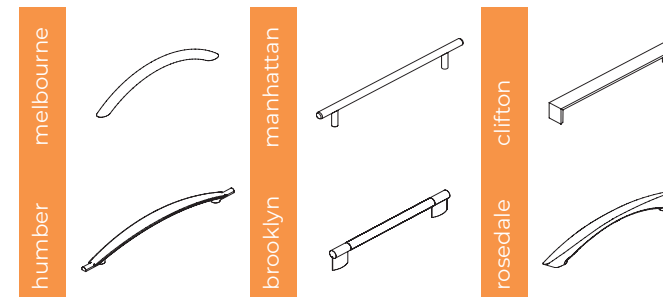

default vinyl color selections

Each laminate comes with matching vinyl trim color unless otherwise specified on your purchase order. Refer to the laminate finish card for details.

edge profile

Metro Executive, Professional and Conference is available in a straight edge profile.



Straight profile is available in:

- > Executive
- > Professional
- > Conference

decorative trim placement

Generally the decorative trim is placed on the exposed surface edge.
 Straight trim is applied to surface edges that are placed next to a wall or another surface.

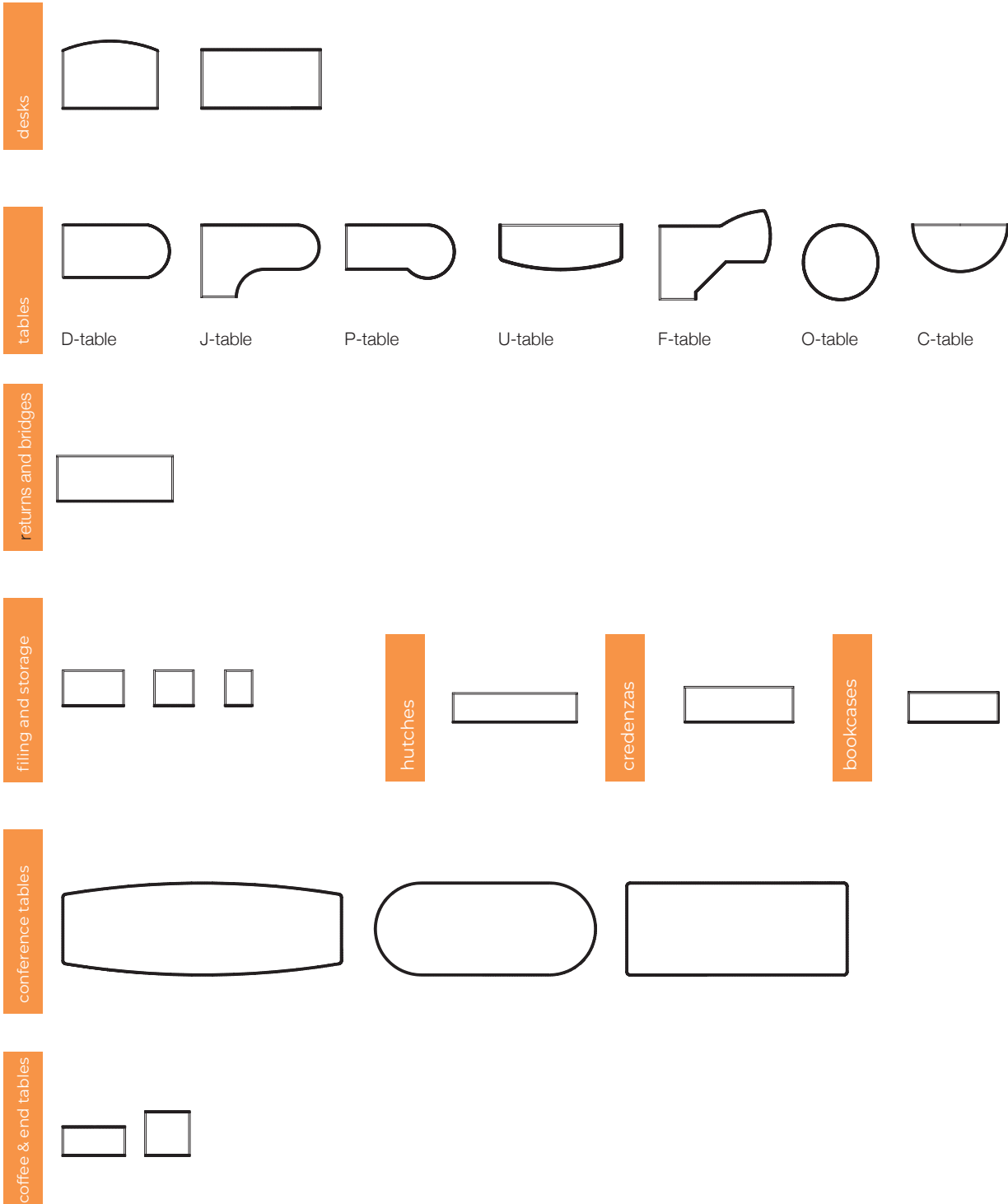

grain direction

Horizontal Surfaces

When ordering a directional laminate, the grain will run the direction of the width of the worksurface (excluding bridge surfaces), hutch or storage top. Grain on bridge modesty runs vertically so the grain will run the same direction on the entire suite.

Vertical Surfaces

Directional laminates run vertically on vertical surfaces such as cabinet doors, pedestal drawer fronts and gables, as well as all cabinet, lateral file and pedestal kick-plates. The grain runs horizontally across the width of modesty panels.

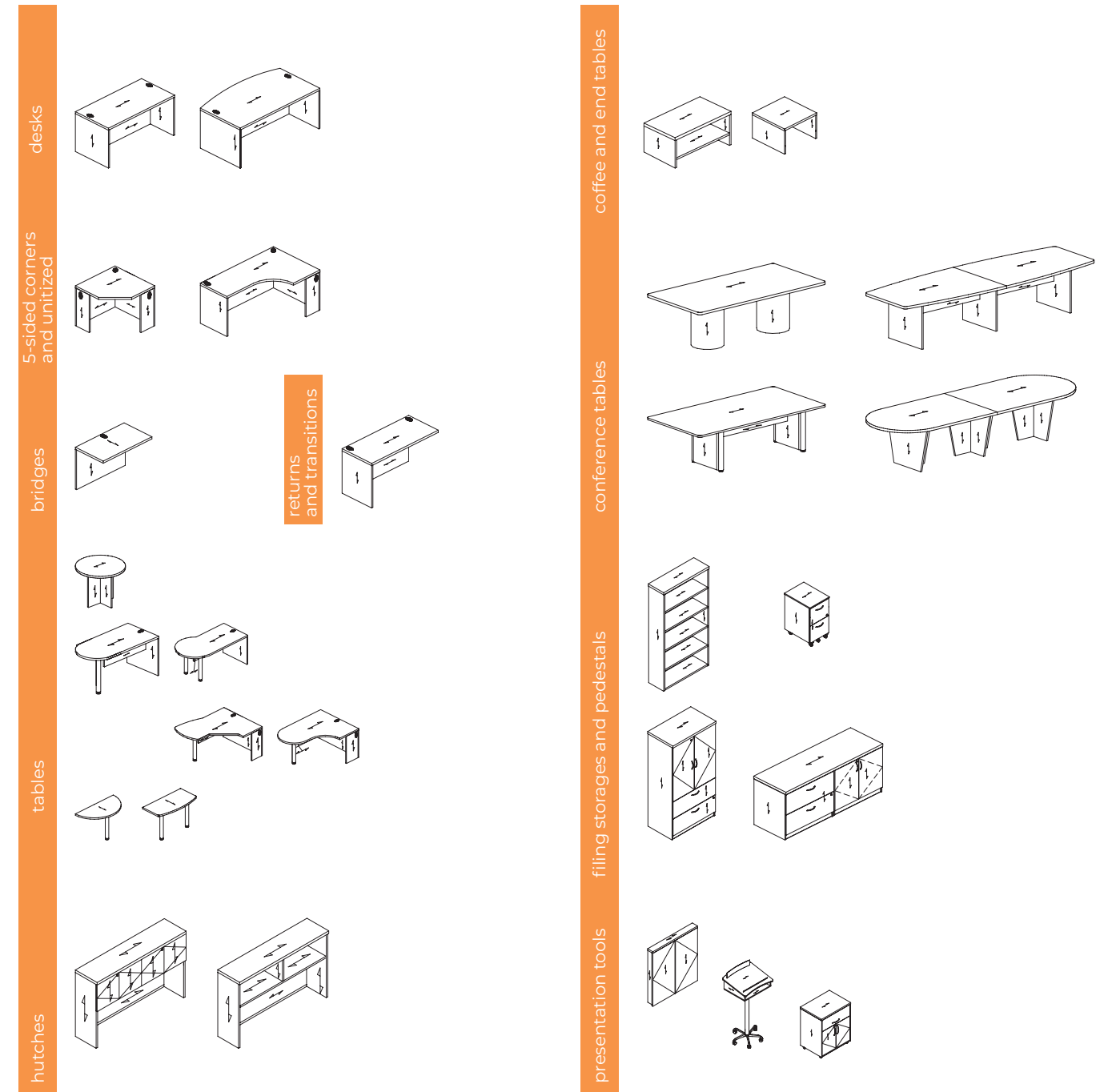

Note: Boardroom tables with tops comprised of 2 or more pieces will not have a consistent grain pattern.

filing options

Pedestal file drawers can accommodate letter- or legal-size documents. Letter-size papers can be filed either front to back or side to side. Lateral drawers can accommodate front to back or side to side filing of legal- or letter-size documents.

Disclaimer: Please note that lateral file drawers are intended for filing letter and legal size paper front to back or side to side only. For details and weight restrictions please contact customer service.

lateral file drawers

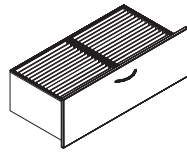

Lateral File Drawer (36W & 42W)
Legal filing – front to back
Underdesk: 15"
Freestanding: 15"

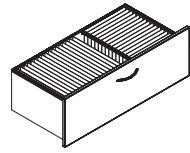

Lateral File Drawer (36W & 42W)
Legal filing – side to side
Letter filing – front to back
Underdesk: 15"
Freestanding: 15"

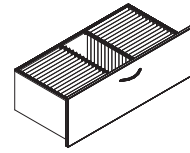

Lateral File Drawer (30W, 36W & 42W)
Letter filing – front to back
Underdesk: 15"
Freestanding: 15"

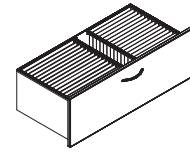

Lateral File Drawer (36W & 42W)
Letter & legal filing – front to back
Underdesk: 15"
Freestanding: 15"

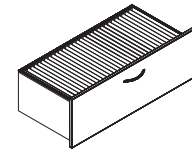

Lateral File Drawer (30W, 36W & 42W)
Legal filing – side to side
Underdesk:
30W-25½"
36W-31½"
42W-37½"

Freestanding:
30W-25½"
36W-31½"
42W-37½"

box drawer



Box Drawer
Box Height: 3"
Box Depth: 15"
Box Width: 12"

file drawers

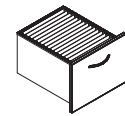

File Drawer
Letter filing – front to back
Underdesk: 15"
Freestanding: 15"

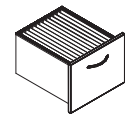

File Drawer
Legal filing – side to side
Underdesk: 12"
Freestanding: 12"

grommets

Grommets are available in black or silver to coordinate with furniture.

Black is the standard grommet option unless otherwise specified on your Purchase Order.

Components Including Grommets

- > Peninsula tables
- > Arc desks with pedestals
- > Straight desks with recessed modesties and pedestals

Straight desks with flush modesties and without pedestals

- > Returns without pedestals
- > 24" deep returns with pedestal
- > 30" deep returns with pedestal
- > 24" deep desks with flush modesties and pedestals
- > 30" deep desks with flush modesties and pedestals
- > 36" deep desks with flush modesties and pedestals
- > Bridges
- > Straight transition worksurfaces
- > 5-sided corner worksurfaces
- > Unitized desks
- > Reception units

Components Available With or Without Grommets

- > Arc desks without pedestals
- > Straight desks with recessed modesties and without pedestals

Components Without Grommets

- > Credenzas
- > 21" deep desks with pedestal
- > 21" deep returns with pedestal
- > "U" and "C" Tables

Grommet Placement

Surfaces up to and including 48" wide have one grommet located at back center of the surface. Surfaces 54" wide and wider have two grommets at either side of the back of the surface.

Statement of Line

Professional Desks

1" Thick Desks

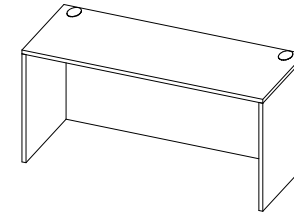

TL-TSOG
Straight w/ Full Modesty
W: 30"- 96"
D: 21"- 30"
H: 29"

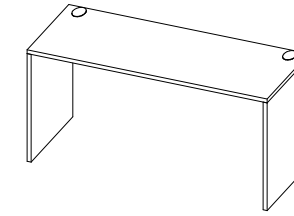

TL-TSOZ
Straight w/ Partial Modesty
W: 30"- 96"
D: 21"- 30"
H: 29"

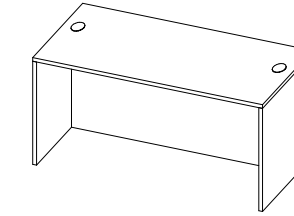

TL-TSRG
Straight w/ Full Recessed Modesty
W: 60"- 96"
D: 30"- 36"
H: 29"

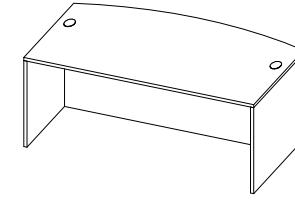

TL-TARG
Arc w/ Full Recessed Modesty
W: 72"- 96"
D: 36"
H: 29"

Professional Tables

1" Thick

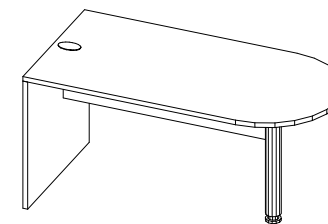

TL-TD0G
D-Table
W: 60"- 84"
D: 30"-36"
H: 29"

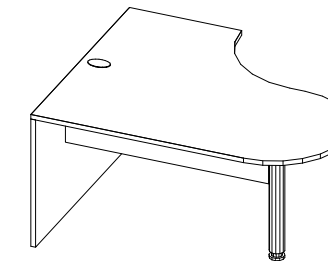

TL-TJ0G-L / TL-TJ0G-R
J-Table (Left Hand shown)
W: 60"- 84"
D: 24"
H: 29"

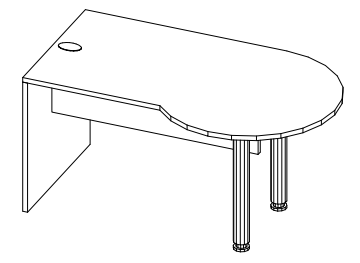

TL-TP0G-L / TL-TP0G-R
P-Table (Left Hand shown)
W: 60"- 84"
D: 30"
H: 29"

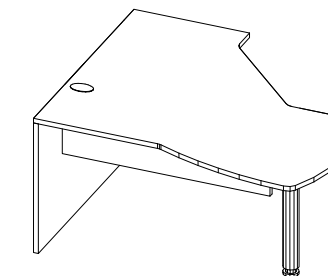

TL-TFSG-L / TL-TFSG-R
F-Table (Left Hand shown)
W: 60"- 84"
D: 24"
H: 29"

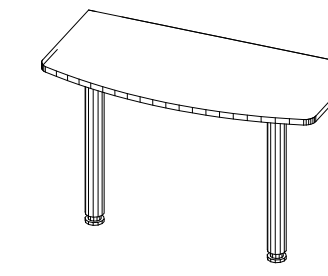

TL-WEU0
U-Table
W: 42"- 60"
D: 24"
H: 29"

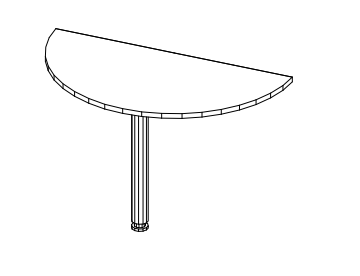

TL-TC00
C-Table
W: 42"- 60"
D: 21"-30"
H: 29"

Executive Desks

1.5" Thick Desks

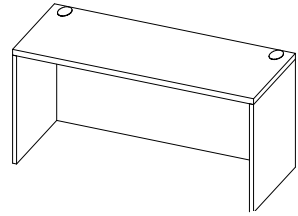

T-TSOG
Straight w/ Full Modesty
W: 30"- 96"
D: 21"- 30"
H: 29.5"

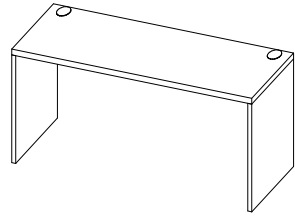

T-TSOZ
Straight w/ Partial Modesty
W: 30"- 96"
D: 21"-30"
H: 29.5"

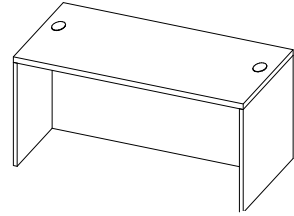

T-TSRG
Straight w/ Full Recessed Modesty
W: 60"- 96"
D: 30"-36"
H: 29.5"

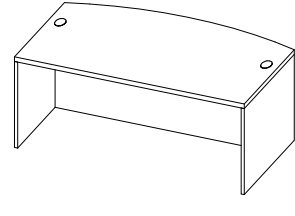

T-TARG
Arc w/ Full Recessed Modesty
W: 72"- 96"
D: 36"
H: 29.5"

Executive Tables

1.5" Thick

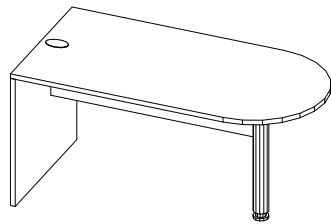

T-TD0G
D-Table
W: 60"- 84"
D: 30"- 36"
H: 29.5"

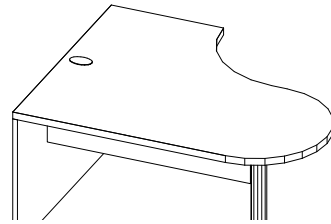

T-TJ0G-L / T-TJ0G-R
J-Table (Left Hand shown)
W: 60"- 84"
D: 24"
H: 29.5"

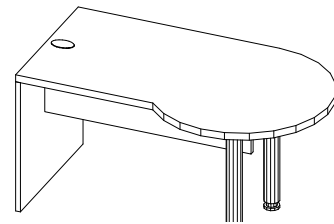

T-TP0G-L / T-TP0G-R
P-Table (Left Hand shown)
W: 60"- 84"
D: 30"
H: 29.5"

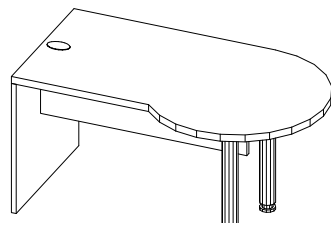

T-TFSG-L / T-TFSG-R
F-Table (Left Hand shown)
W: 60"- 84"
D: 24"
H: 29.5"

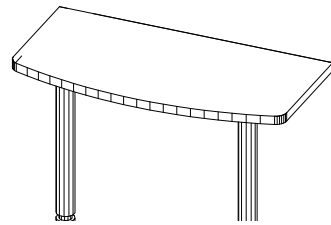

T-WEU0
U-Table
W: 42"- 60"
D: 24"
H: 29.5"

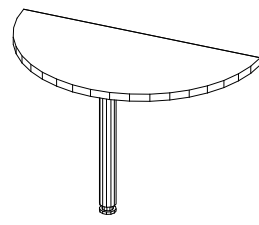

T-TC00
C-Table
W: 42"- 60"
D: 21"-30"
H: 29.5"

Professional Corners

1" Thick

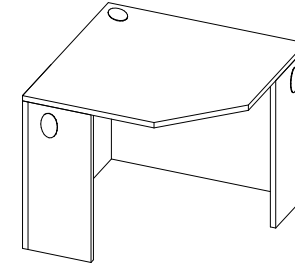

TL-W5S0
Straight Front
Full Modesty w/ Intermediate Gable
W: 36"- 42"
D: 21"- 24"
H: 29"

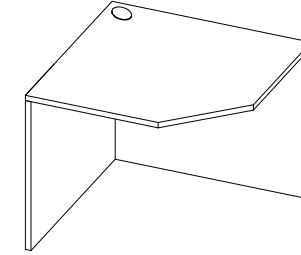

TL-W5S0-N
Straight Front
Full Modesty/ No Intermediate Gable
W: 36"- 42"
D: 21"- 24"
H: 29"

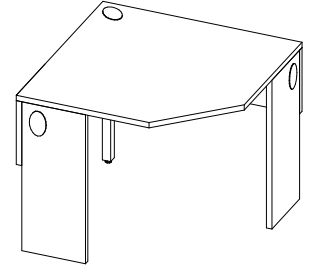

TL-W5S0-P
Straight Front
Partial Modesty w/ Intermediate Gable
W: 36"- 42"
D: 21"- 24"
H: 29"

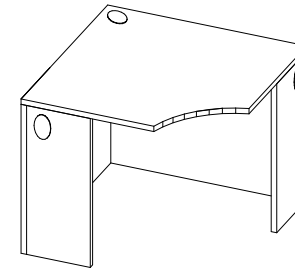

TL-W5C0
Curve Front
Full Modesty w/ Intermediate Gable
W: 36"- 42"
D: 21"- 24"
H: 29"

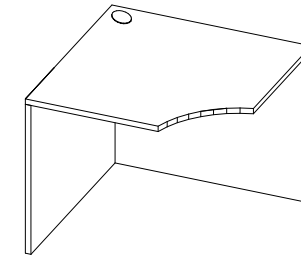

TL-W5C0-N
Curve Front
Full Modesty/ No Intermediate Gable
W: 36"- 42"
D: 21"- 24"
H: 29"

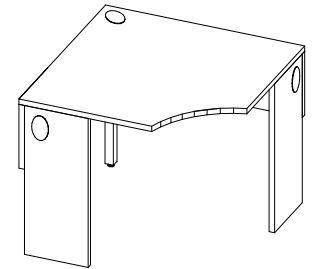

TL-W5C0-P
Curve Front
Partial Modesty w/ Intermediate Gable
W: 36"- 42"
D: 21"- 24"
H: 29"

Professional Unitized Desks

1" Thick

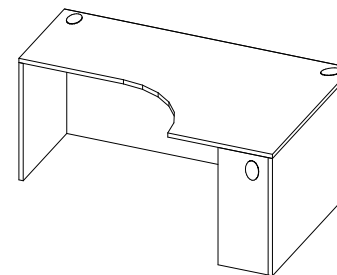

TL-UC4G-L / TL-UC4G-R
Unitized Desk (Left Hand shown)
Full Modesty w/ Intermediate Gable
W: 66"- 72"
D: 39"- 42"
Other D: 21" - 24"
H: 29"

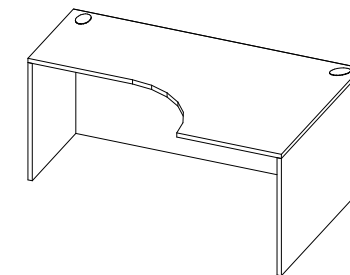

TL-UC4G-L-N / TL-UC4G-R-N
Unitized Desk - (Left Hand shown)
Full Modesty/ No Intermediate Gable
W: 66"- 72"
D: 39"- 42"
Other D: 21" - 24"
H: 29"

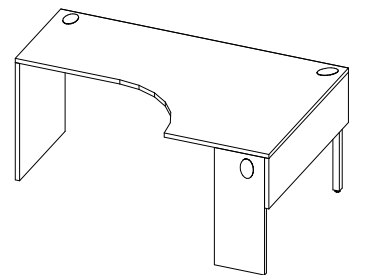

TL-UC4Z-L / TL-UC4G-R
Unitized Desk (Left Hand shown)
Partial Modesty w/ Intermediate Gable
W: 66"- 72"
D: 39"- 42"
Other D: 21" - 24"
H: 29"

Executive Corners

1.5" Thick

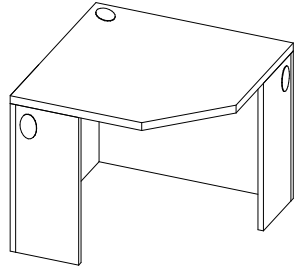

T-W5S0
Straight Front
Full Modesty w/ Intermediate Gable
W: 36" - 42"
D: 21" - 24"
H: 29.5"

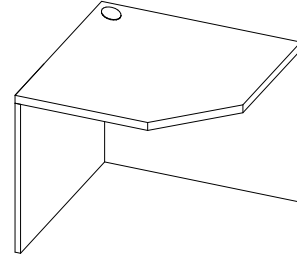

T-W5S0-N
Straight Front
Full Modesty/ No Intermediate Gable
W: 36" - 42"
D: 21" - 24"
H: 29.5"

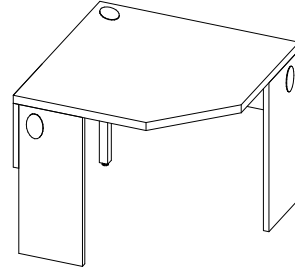

T-W5S0-P
Straight Front
Partial Modesty w/ Intermediate Gable
W: 36" - 42"
D: 21" - 24"
H: 29.5"

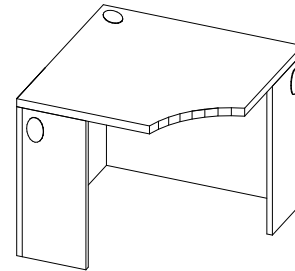

T-W5C0
Curve Front
Full Modesty w/ Intermediate Gable
W: 36" - 42"
D: 21" - 24"
H: 29.5"

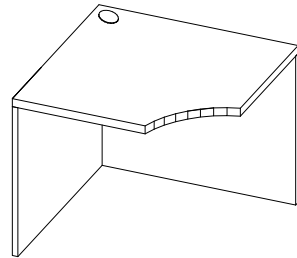

T-W5C0-N
Curve Front
Full Modesty/ No Intermediate Gable
W: 36" - 42"
D: 21" - 24"
H: 29.5"

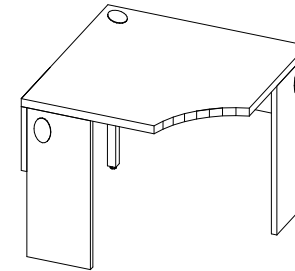

T-W5C0-P
Curve Front
Partial Modesty w/ Intermediate Gable
W: 36" - 42"
D: 21" - 24"
H: 29.5"

Executive Unitized Desks

1.5" Thick

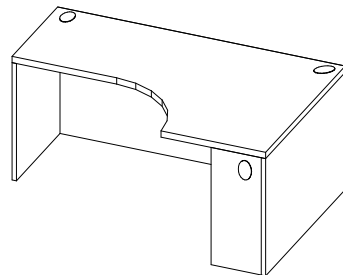

T-UC4G-L / T-UC4G-R
Unitized Desk (Left Hand shown)
Full Modesty w/ Intermediate Gable
W: 66" - 72"
D: 39" - 42"
Other D: 21" - 24"
H: 29.5"

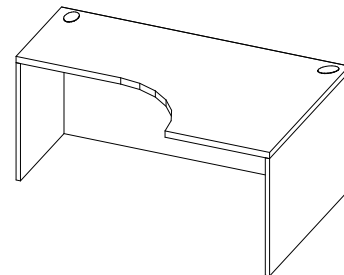

T-UC4G-L-N / T-UC4G-R-N
Unitized Desk (Left Hand shown)
Full Modesty/ No Intermediate Gable
W: 66" - 72"
D: 39" - 42"
Other D: 21" - 24"
H: 29.5"

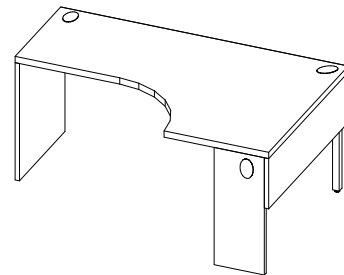

T-UC4Z-L / T-UC4G-R
Unitized Desk (Left Hand shown)
Partial Modesty w/ Intermediate Gable
W: 66" - 72"
D: 39" - 42"
Other D: 21" - 24"
H: 29.5"

Professional Bridges

1" Thick

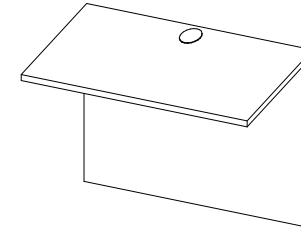

TL-BS0G
Straight w/ Full Modesty
W: 30" - 48"
D: 21" - 24"
H: 29"

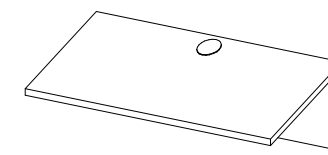

TL-BS0Z
Straight w/ Partial Modesty
W: 30" - 48"
D: 21" - 24"
H: 29"

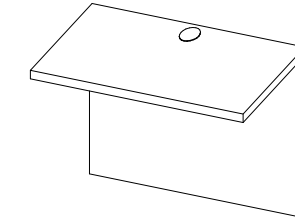

T-BS0G
Straight w/ Full Modesty
W: 30" - 48"
D: 21" - 24"
H: 29.5"

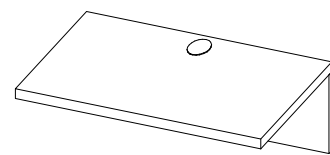

T-BS0Z
Straight w/ Partial Modesty
W: 30" - 48"
D: 21" - 24"
H: 29.5"

Professional Returns

1" Thick

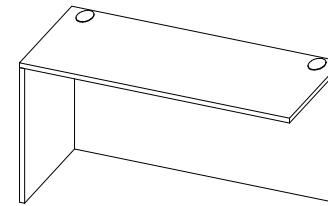

TL-WS1G-L / TL-WS1G-R
Straight w/ Full Modesty
(Left Hand shown)
W: 24" - 60"
D: 21" - 30"
H: 29"

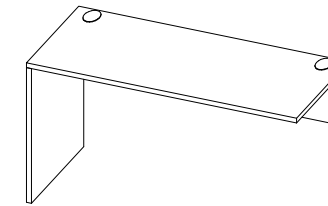

TL-WS1Z-L / TL-WS1Z-R
Straight w/ Partial Modesty
(Left Hand shown)
W: 24" - 60"
D: 21" - 30"
H: 29"

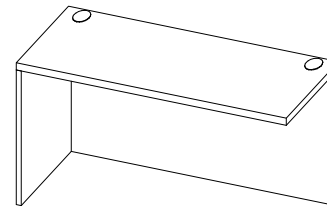

T-WS1G-L / T-WS1G-R
Straight w/ Full Modesty
(Left Hand shown)
W: 24" - 60"
D: 21" - 30"
H: 29.5"

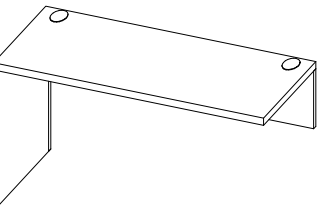

T-WS1Z-L / T-WS1Z-R
Straight w/ Partial Modesty
(Left Hand shown)
W: 24" - 60"
D: 21" - 30"
H: 29.5"

Executive Returns

1.5" Thick

Credenza Top

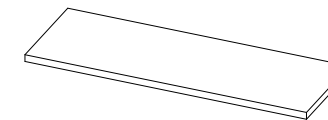

T-WSS0
1.5" Thick Credenza Top
W: 60" - 84"
D: 21"

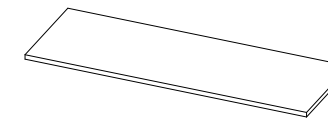

TL-WSS0
1" Thick Credenza Top
W: 60" - 84"
D: 21"

Professional Credenzas

1" Thick

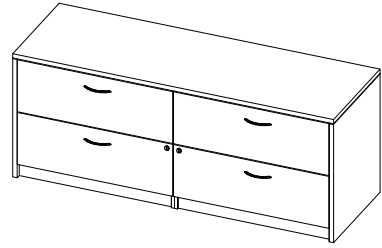

TL-CRLL
Credenza w/ Double Lateral
Files
W: 72"
D: 21" - 24"
H: 29"

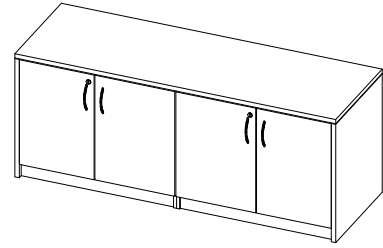

TL-CRSS
Credenza w/ Double Stor-
age Files
W: 72"
D: 21" - 24"
H: 29"

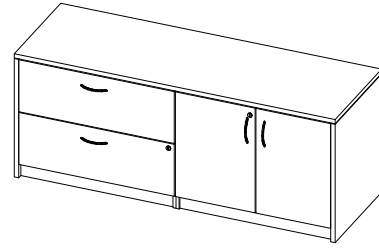

TL-CRLS
Credenza w/ Lateral File LH,
Storage Cabinet RH
W: 72"
D: 21" - 24"
H: 29"

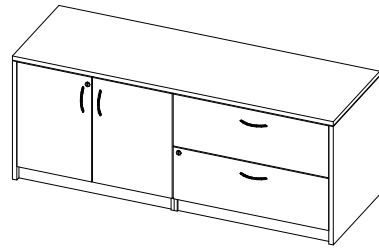

TL-CRSL
Credenza w/ Storage Cabi-
net LH,
Lateral File RH
W: 72"
D: 21" - 24"
H: 29"

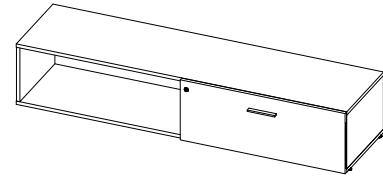

U-CRCL-L / U-CRCL-R
Open Credenza w/ Door
W: 72"
D: 18"
H: 15"

Executive Credenzas

1.5" Thick Top

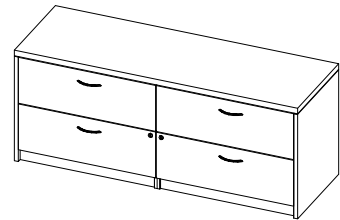

T-CRLL
Credenza w/ Double Lateral
Files
W: 72"
D: 21" - 24"
H: 29.5"

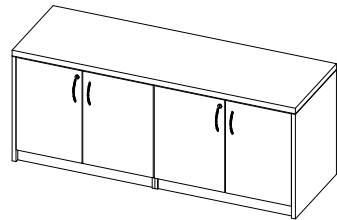

T-CRSS
Credenza w/ Double Stor-
age Files
W: 72"
D: 21" - 24"
H: 29.5"

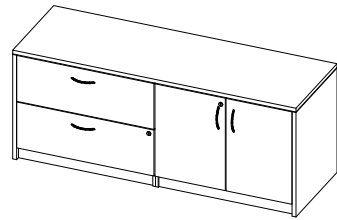

T-CRLS
Credenza w/ Lateral
File LH,
Storage Cabinet RH
W: 72"
D: 21" - 24"
H: 29.5"

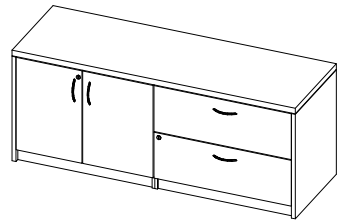

T-CRSL
Credenza w/ Storage Cabi-
net LH,
Lateral File RH
W: 72"
D: 21" - 24"
H: 29.5"

Supports

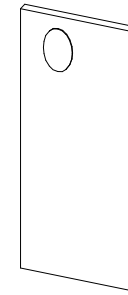

T-CGUO
Intermediate Gable Support
W: 12" - 18"
D: 1"
H: 28"

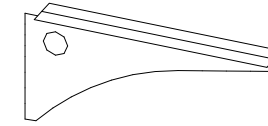

K-CCAB
Center Cantilever Support
W: 16" - 22"

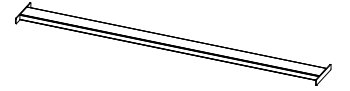

U-HRBO
Reinforcement Bar
W: 27" - 90"

Pedestals

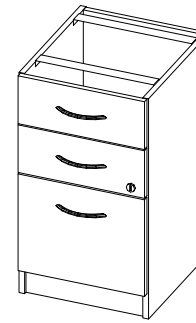

T-FPBU
Underdesk Box/Box/File
W: 16"
D: 18" - 24"
H: 28"

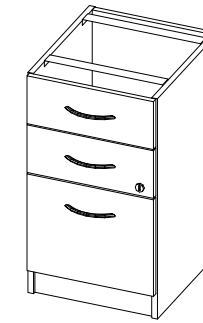

T-FPBU-X
Underdesk Box/Box/File
Full Back
W: 16"
D: 18" - 24"
H: 28"

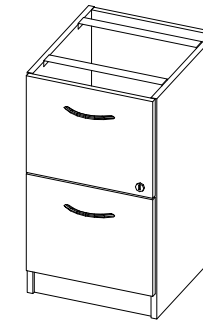

T-FPFU
Underdesk File/File
W: 16"
D: 18" - 24"
H: 28"

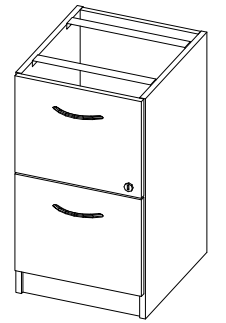

T-FPFU-X
Underdesk File/File
Full Back
W: 16"
D: 18" - 24"
H: 28"

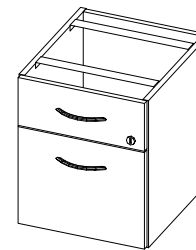

T-FPSU
Suspended Box/File
W: 16"
D: 18"
H: 16"

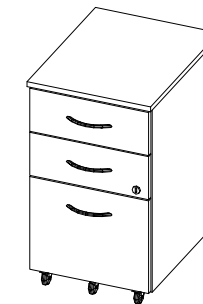

T-FPBM
Mobile Box/Box/File
W: 16"
D: 21"
H: 28"

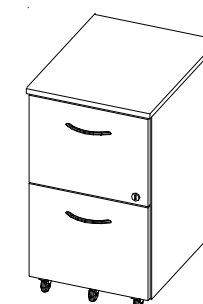

T-FPFM
Mobile File/File
W: 16"
D: 21"
H: 28"

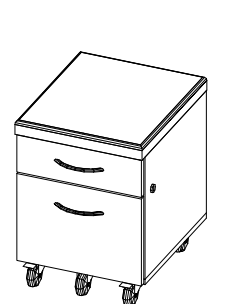

T-1030
Mobile Box/File w/ Seat
Cushion
W: 16"
D: 18"
H: 23"

Filing & Storage
Professional & Executive

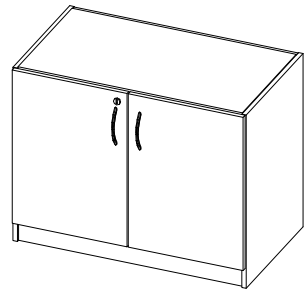

T-FSUO
Underdesk Storage Cabinet
W: 30" - 42"
D: 20" - 21"
H: 28"

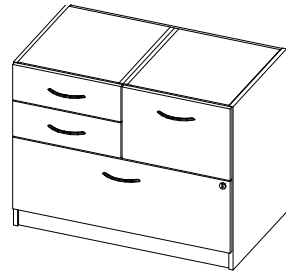

T-FPJU-L / T-FPJU-R
Underdesk Combo Pedestal
w/Box/Box/File and File/File
LH/ RH (LH shown)
W: 36"
D: 20" - 21"
H: 28"

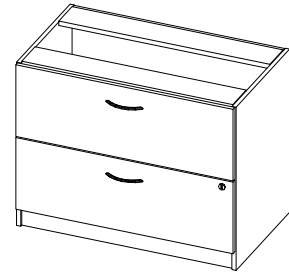

T-FL2U
Underdesk 2-Drawer Lat-
eral File
W: 30" - 42"
D: 20" - 21"
H: 28"

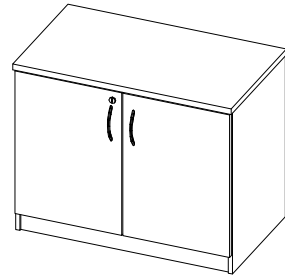

T-FSFO
1.5" Freestanding Storage
Cabinet
W: 30" - 42"
D: 21"
H: 29.5"

Professional Filing & Storage
1" Thick



TL-FL2F
Freestanding 2-Drawer Lateral File
W: 30" - 42"
D: 21"
H: 29"

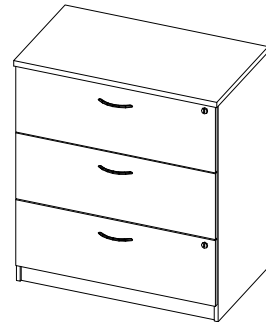

TL-FL3F
Freestanding 3-Drawer Lateral File
W: 30" - 36"
D: 21"
H: 40"

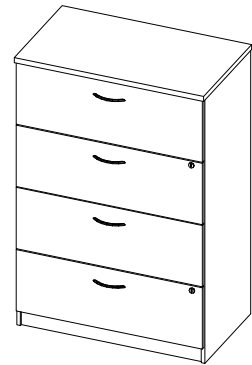

TL-FL4F
Freestanding 4-Drawer Lateral File
W: 30" - 36"
D: 21"
H: 52"

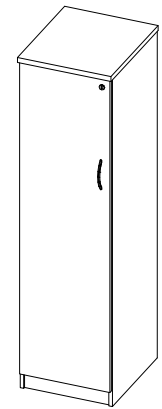

TL-FSDS-L / TL-FSDS-R
Storage Cabinet w/
Shelves
(Left Hand shown)
W: 18"
D: 21"
H: 67"

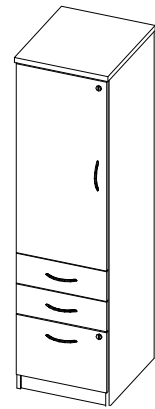

TL-FCSB-L / TL-FCSB-R
Combo Cabinet w/Storage
and Box/Box/File
(Left Hand shown)
W: 18"
D: 21"
H: 67"

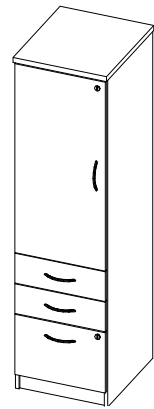

TL-FCSF-L / TL-FCSF-R
Combo Cabinet w/
Storage and File/File
(Left Hand shown)
W: 18"
D: 21"
H: 67"

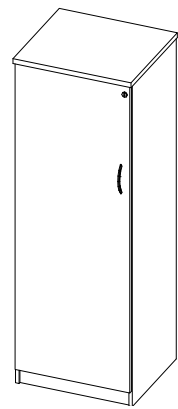

TL-FSDC-L / TL-FSDC-R
Storage Cabinet w/ Coat
Bar and Shelves
(Left Hand shown)
W: 24"
D: 21"
H: 67"

Professional Filing & Storage
1" Thick

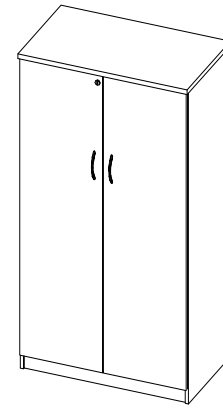

TL-FSDS
Double Door Storage
Cabinet
w/ Shelves
W: 36"
D: 21"
H: 67"

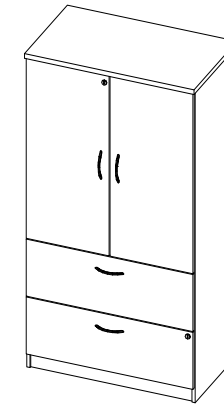

TL-FCSL
Combo Cabinet w/Storage
and Lateral File
W: 36"
D: 21"
H: 67"

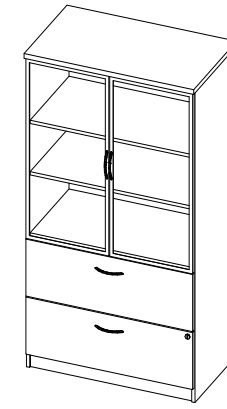

TL-FCSL-G
Combo Cabinet w/Storage,
Lateral File, Glazed Double
Doors
W: 36"
D: 21"
H: 67"

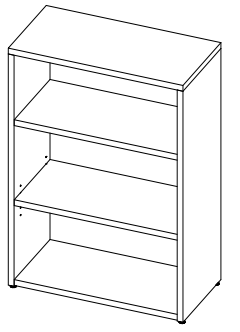

TL-SBOX
Bookcase
W: 24" - 42"
D: 12"/ 15"/ 21"
H: 29"/ 42"/ 54"/ 67"/ 77"

Executive Filing & Storage
1.5" Thick

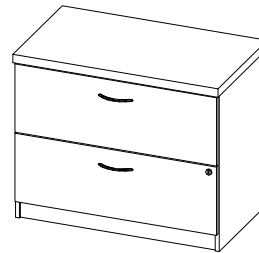

T-FL2F
Freestanding 2-Drawer Lateral File
W: 30" - 42"
D: 21"
H: 29.5"

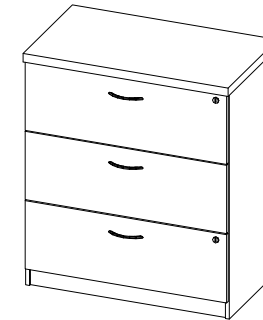

T-FL3F
Freestanding 3-Drawer Lateral File
W: 30" - 36"
D: 21"
H: 40.5"

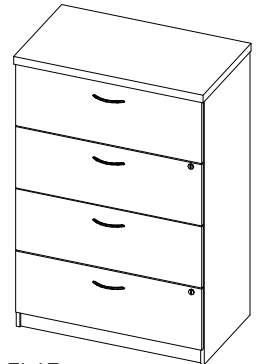

T-FL4F
Freestanding 4-Drawer Lateral File
W: 30" - 36"
D: 21"
H: 52.5"

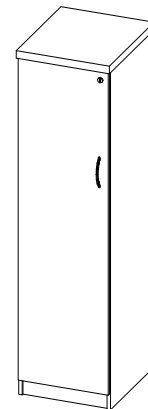

T-FSDS-L / T-FSDS-R
Storage Cabinet w/ Shelves
(Left Hand shown)
W: 18"
D: 21"
H: 68"

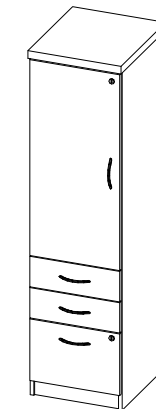

T-FCSB-L / T-FCSB-R
Combo Cabinet w/Storage
and Box/Box/File
(Left Hand shown)
W: 18"
D: 21"
H: 68"

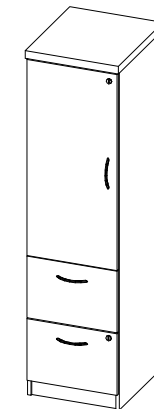

T-FCSF-L / T-FCSF-R
Combo Cabinet w/Storage
and File/File
(Left Hand shown)
W: 18"
D: 21"
H: 68"

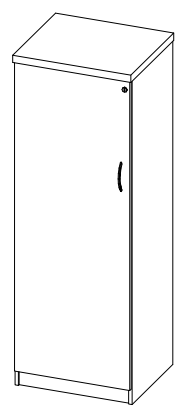

T-FSDC-L / T-FSDC-R
Storage Cabinet w/ Coat Bar
and Shelves
(Left Hand shown)
W: 24"
D: 21"
H: 68"

Executive Filing & Storage

1.5" Thick

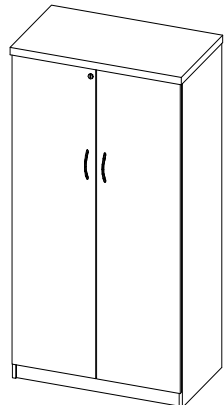

T-FSDS
Double Door Storage Cabinet
w/ Shelves
W: 36"
D: 21"
H: 68"

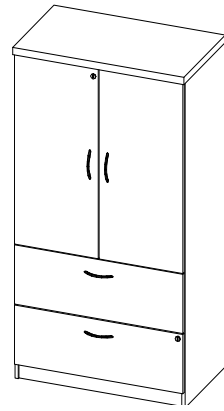

T-FCSL
Combo Cabinet w/Storage
and Lateral File
W: 36"
D: 21"
H: 68"

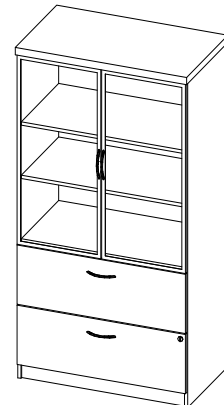

T-FCSL-G
Combo Cabinet w/Storage,
Lateral File. Glazed Double
Doors
W: 36"
D: 21"
H: 68"

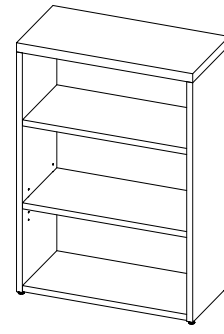

T-SBOX
Bookcase
W: 24" - 42"
D: 12"/15"/21"
H: 29"/42"/54"/68"/78"

Professional Overhead Storage

1" Thick

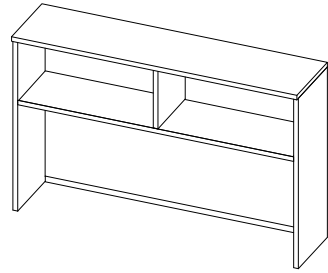

TL-SH00
Open Hutch
W: 30" - 84"
D: 15"
H: 38.5"

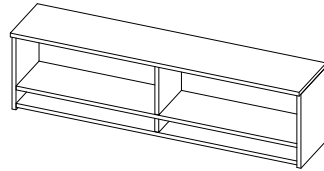

TL-SHOS
Wall Mounted Open Hutch
W: 72"
D: 15.5"
H: 20.19"

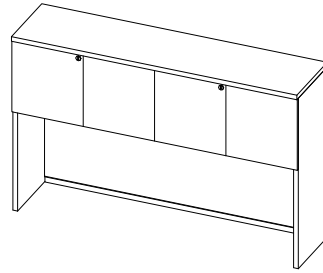

TL-SHH0
Hinged Door Hutch
W: 30" - 84"
D: 15"
H: 38.5"

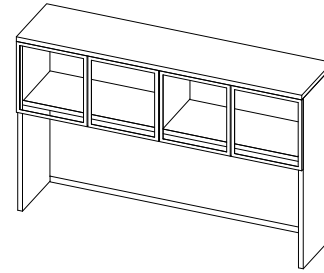

TL-SHH0-G
Hinged Door Hutch w/ Acrylic
Doors
W: 30" - 84"
D: 15"
H: 38.5"

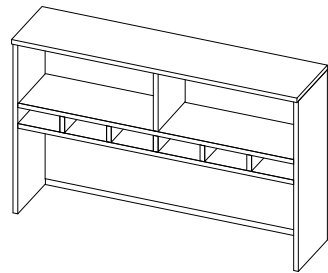

TL-SHOP
Open Hutch w/ Pigeon Holes
W: 30" - 84"
D: 15"
H: 38.5"

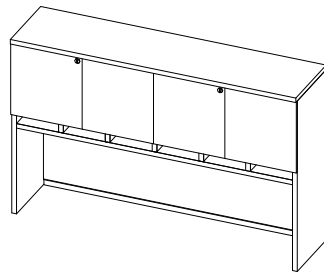

TL-SHHP-L
Hinged Door Hutch w/ Pigeon
Holes
W: 30" - 84"
D: 15"
H: 38.5"

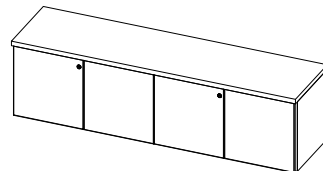

TL-SHHW-L
Wall Mounted Hinged Door
Hutch
W: 30" - 72"
D: 15"
H: 16.5"

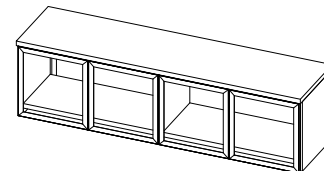

TL-SHHW-G
Wall Mounted Hinged Door
Hutch w/ Acrylic Doors
W: 30" - 72"
D: 15"
H: 16.5"

Executive Overhead Storage

1.5" Thick

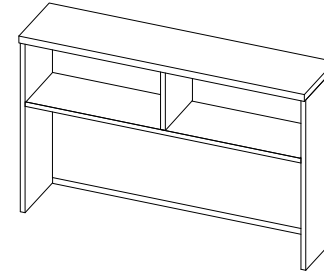

T-SH00
Open Hutch
W: 30" - 84"
D: 15"
H: 38.5"

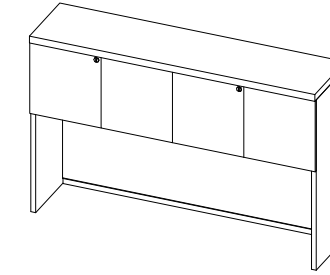

T-SHH0
Hinged Door Hutch
W: 30" - 84"
D: 15"
H: 38.5"

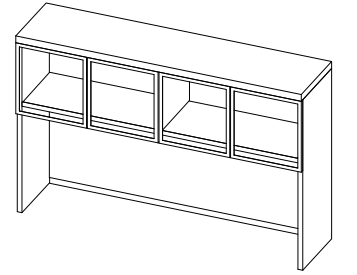

T-SHH0-G
Hinged Door Hutch w/ Acrylic
Doors
W: 30" - 84"
D: 15"
H: 38.5"

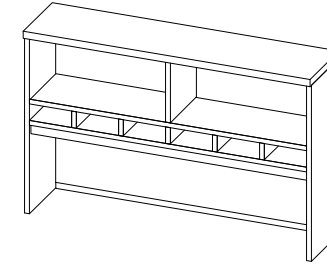

T-SHOP
Open Hutch w/ Pigeon Holes
W: 30" - 84"
D: 15"
H: 38.5"

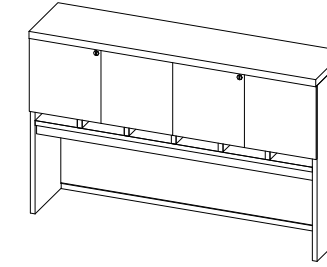

T-SHHP-L
Hinged Door Hutch w/ Pigeon
Holes
W: 30" - 84"
D: 15"
H: 38.5"

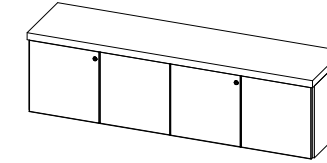

T-SHHW-L
Wall Mounted Hinged Door
Hutch
W: 30" - 72"
D: 15"
H: 16.5"

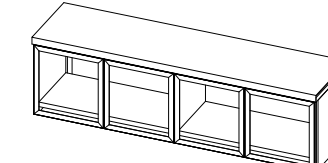

T-SHHW-G
Wall Mounted Hinged Door
Hutch w/ Acrylic Doors
W: 30" - 72"
D: 15"
H: 16.5"

Professional Table Tops

1" Thick

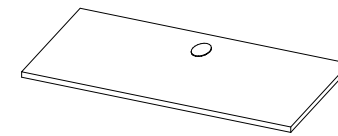

U-WS0G
Straight Tabletop w/ Grom-
met
W: 18" - 96"
D: 18" - 36"

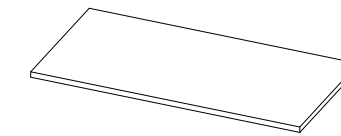

U-WS0N
Straight Tabletop - No Grom-
met
W: 18" - 96"
D: 18" - 36"

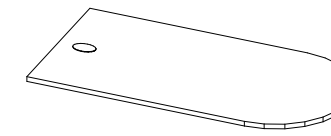

U-WDTG
D-Tabletop
W: 60" - 84"
D: 24" - 36"

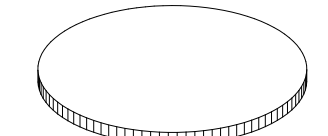

TL-WOXX
O-Tabletop
W: 24" - 60"
D: 24" - 60"

Executive Table Tops

1.5" Thick

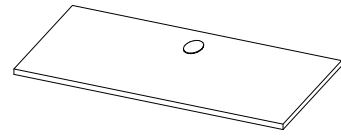

U-WS0G
Straight Tabletop w/ Grom-
met
W: 18" - 96"
D: 18" - 36"

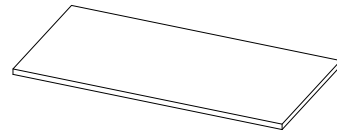

U-WS0N
Straight Tabletop - No Grom-
met
W: 18" - 96"
D: 18" - 36"

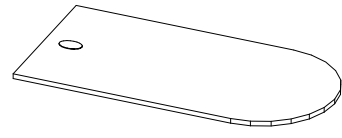

U-WDTG
D-Tabletop
W: 60" - 84"
D: 24" - 36"

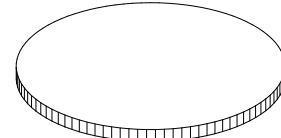

TL-WOXX
O-Tabletop
W: 24" - 60"
D: 24" - 60"

Bases

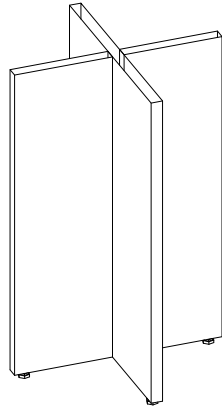

T-B6
Cross Base
W: 18" - 48"
D: 18" - 48"
H: 28"



TB-BASE-1
Post Support Base
W: 3"
D: 3"
H: 28"

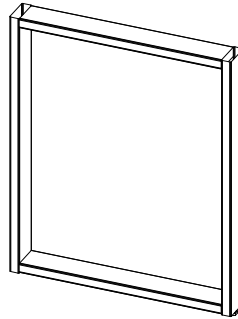

U-CG0M
Open Metal Gable
W: 12" - 36"
D: 3"
H: 28"/13.81"

Professional Reception Unit

1" Thick

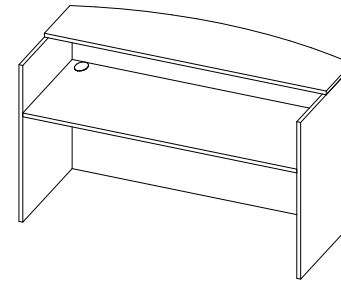

TL-RCOG
Reception Unit w/ Countertop
W: 72"
D: 30"
H: 43"

Executive Reception Unit

1.5" Thick

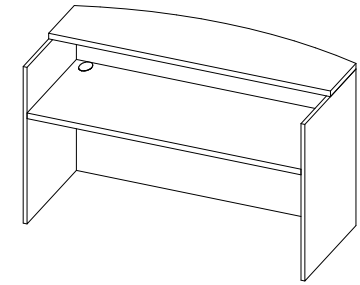

T-RCOG
Reception Unit w/ Countertop
W: 72"
D: 30"
H: 43"

Professional Service Write Up Desk

1" Thick

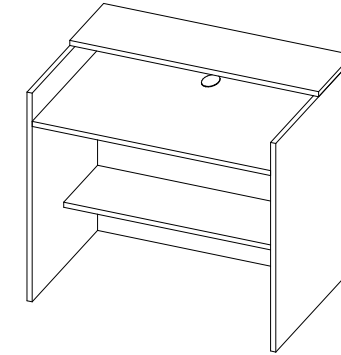

TL-RCWG-S
Service Write Up Desk w/ Straight
Countertop
W: 30 - 84"
D: 30"
H: 43"

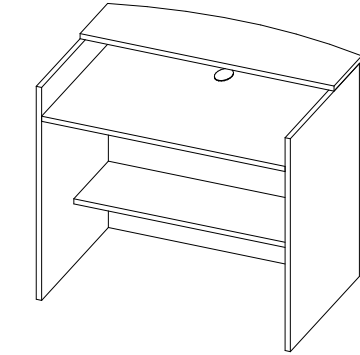

TL-RCWG-A
Service Write Up Desk w/ Arc Counter-
top
W: 30 - 84"
D: 30"
H: 43"

Executive Service Write Up Desk

1.5" Thick

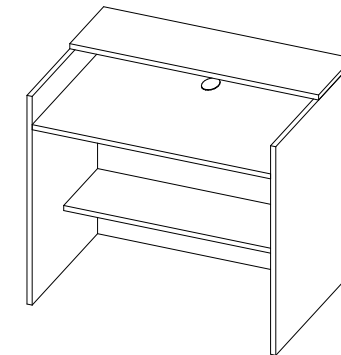

T-RCWG-S
Service Write Up Desk w/ Straight
Countertop
W: 30 - 84"
D: 30"
H: 43"

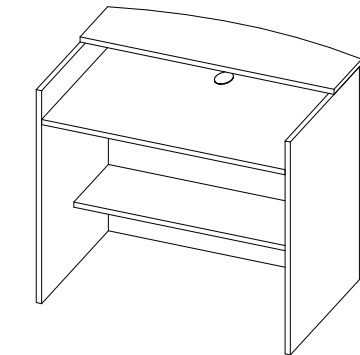

T-RCWG-A
Service Write Up Desk w/ Arc Counter-
top
W: 30 - 84"
D: 30"
H: 43"

Professional Coffee & End Table

1" Thick

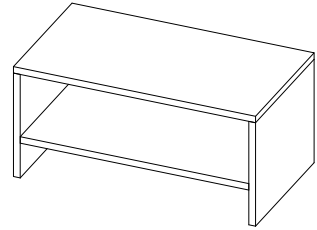

TL-TCTO
Coffee Table
W: 36" - 48"
D: 20"
H: 17"

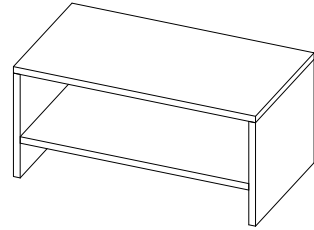

TL-TCTS
Coffee Table with Fixed
Shelf
W: 36"
D: 20"
H: 17"

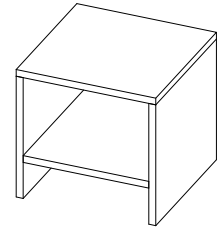

TL-TCTO
End Table
W: 20" - 30"
D: 20" - 30"
H: 19"

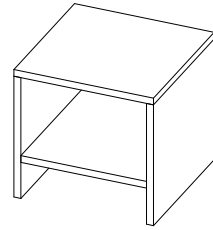

TL-TCTS
End Table with Fixed
Shelf
W: 20" - 30"
D: 20" - 30"
H: 19"

Executive Coffee & End Table

1.5" Thick

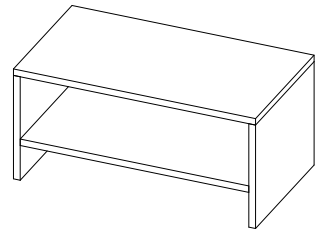

T-TCTO
Coffee Table
W: 36" - 48"
D: 20"
H: 17.5"

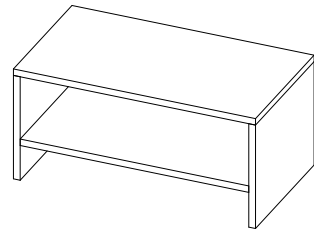

T-TCTS
Coffee Table with Fixed
Shelf
W: 36"
D: 20"
H: 17.5"

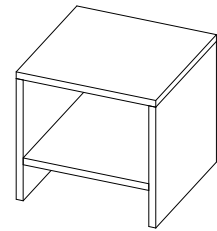

T-TCTO
End Table
W: 20" - 30"
D: 20" - 30"
H: 19.5"

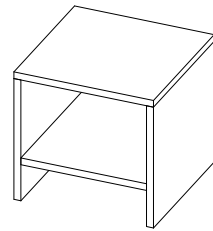

T-TCTS
End Table with Fixed
Shelf
W: 20" - 30"
D: 20" - 30"
H: 19.5"

Conference Table Tops

1.5" Thick

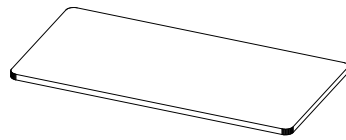

TB-MSSX
Straight Tabletop
W: 72" - 240"
D: 36" - 60"

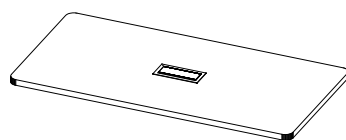

TB-MSSP
Straight Tabletop with
Power
W: 72" - 240"
D: 36" - 60"

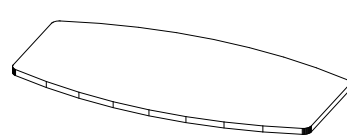

TB-MBBX
Boat-Shaped Tabletop
W: 72" - 240"
D: 36" - 60"

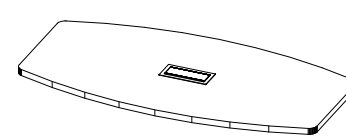

TB-MBBP
Boat-Shaped Tabletop with
Power
W: 72" - 240"
D: 36" - 60"

Conference Table Tops

1.5" Thick

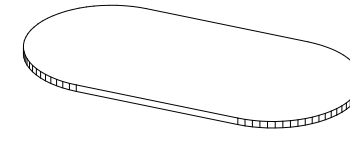

TB-MRRX
Racetrack Tabletop
W: 72" - 240"
D: 36" - 60"

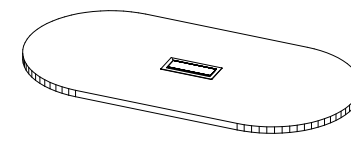

TB-MRRP
Racetrack Tabletop with
Power
W: 72" - 240"
D: 36" - 60"

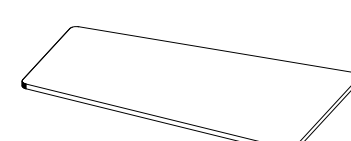

TB-MTTX
Tapered Tabletop
W: 84" - 240"
D: 48" - 78"

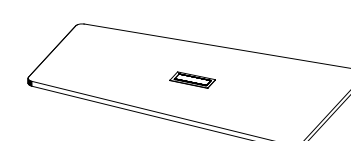

TB-MTTP
Tapered Tabletop with
Power
W: 84" - 240"
D: 48" - 78"

Conference Gable & Modesty Base

1.5" Thick

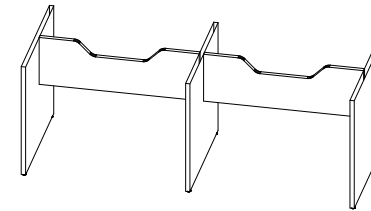

TB-B4
Gable Base for Straight/Boat
Tabletop
W: 42" - 60"
D: 21" - 240"
H: 28"

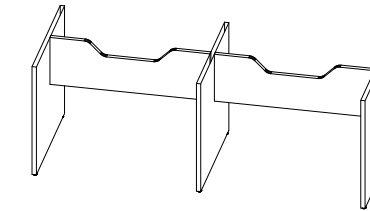

TB-B4-R
Gable Base for Racetrack
Tabletop
W: 48" - 60"
D: 84" - 240"
H: 28"

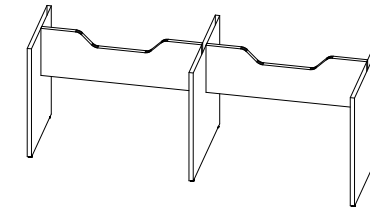

TB-B4-T
Gable Base for Tapered
Tabletop
W: 48" - 78"
D: 84" - 240"
H: 28"

Conference Elliptical Base

1.5" Thick

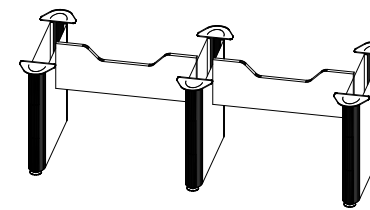

TB-B5
Elliptical Base for
Straight/Boat Tabletop
W: 36" - 60"
D: 72" - 204"
H: 28"

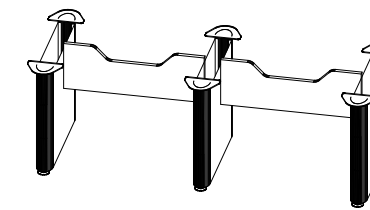

TB-B5-R
Elliptical Base for Race-
track Tabletop
W: 48" - 60"
D: 84" - 204"
H: 28"

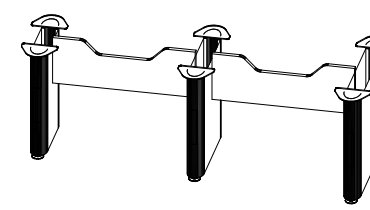

TB-B5-T
Elliptical Base for Tapered
Tabletop
W: 48" - 60"
D: 84" - 204"
H: 28"

Ellora Grommet Add-ons

Options



T-RJ45



T-RJ11



T-HDMI



T-VGA

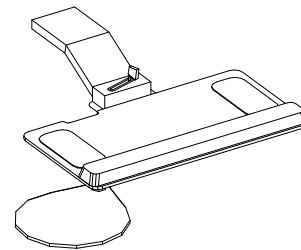

V-KASO-L / V-KASO-R
Articulating Keyboard
Tray with Mouse Tray
W: 20"
D: 11"

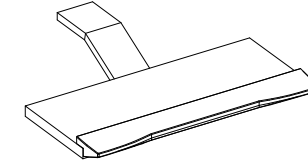

V-KASO
Articulating Laminate
Keyboard Tray
W: 25"
D: 10"

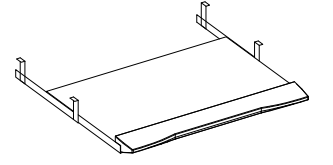

V-KRSO
Retractable Laminate
Keyboard Tray
W: 25"
D: 16"

Conference Filing and Storage

1.5" Thick

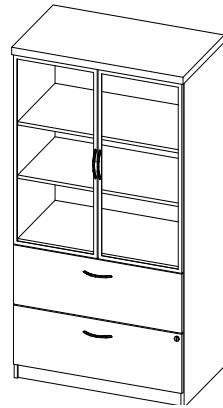

TB-FCSL-G
Combo Cabinet with
Storage, Lateral Files
and Acrylic Doors
W: 36"
D: 21"
H: 78"

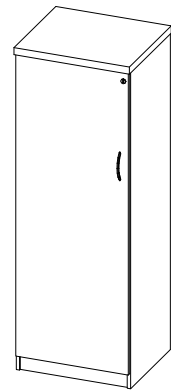

TB-FSDC-L / TB-FSDC-R
Storage Cabinet with
Coat Bar and Shelves
(Left Hand shown)
W: 24"
D: 21"
H: 78"

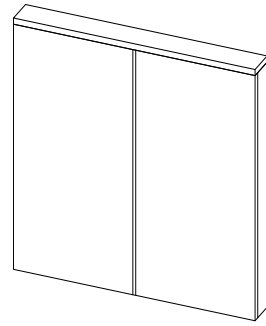

TB-VB00
Whiteboard Cabinet
W: 48"
D: 5.6"
H: 51"

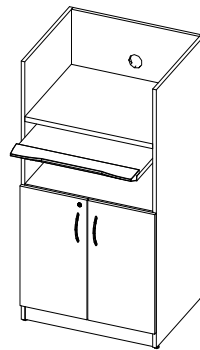

U-TCDS
1" Computer Desk
with 1.5" Top
W: 28"
D: 24"
H: 54"

Tackboard for Hutch

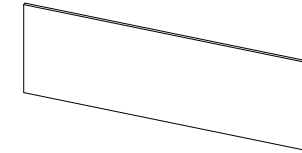

V-ATH0
14"H Tackboard for Hutch
with Pigeon Holes
W: 27" - 81"
D: 0.5"
H: 14"

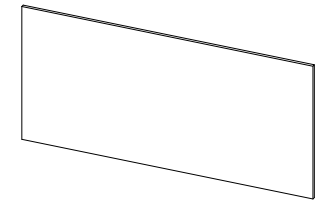

V-ATH0
21"H Tackboard for Hutch
without Pigeon Holes
W: 27" - 81"
D: 0.5"
H: 21"

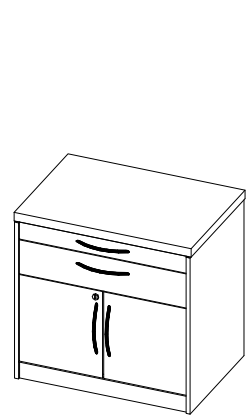

TB-FCS0
Serving Cabinet
W: 30" - 36"
D: 21"
H: 29.5"

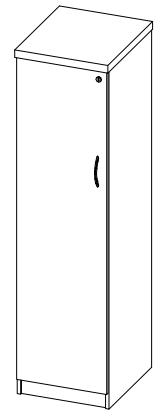

TB-FSDS-L / TB-FSDS-R
Storage Cabinet with
Shelves
(Left Hand shown)
W: 18"
D: 21"
H: 78"

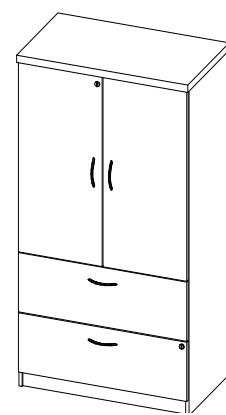

TB-FCSL
Combo Cabinet
with Storage and
Lateral Files
W: 36"
D: 21"
H: 78"

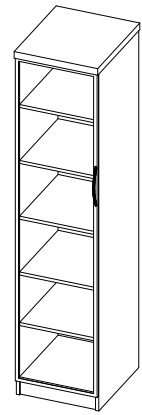

TB-FSDS-LG / TB-FSDS-RG
Storage Cabinet with
Shelves and Acrylic Doors
(Left Hand shown)
W: 18"
D: 21"
H: 78"

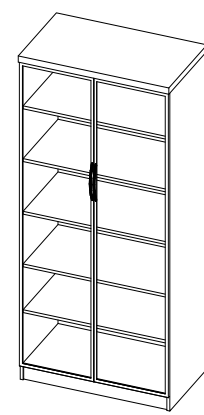

TB-FSDS-G
Double Door Storage
Cabinet with Shelves
and Acrylic Doors
W: 36"
D: 21"
H: 78"

Pencil Drawer

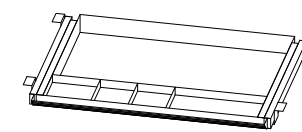

V-ADPP
Plastic Pencil Drawer
W: 21"
D: 16"
H: 2.8"

Tasklight



V-ELU
Task Light
W: 24"/36"

Accessories

Keyboard

Tackboard for Hutch

Pencil Drawer

Tasklight

Monitor Arm

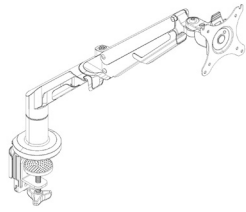

V-AFMA-01
Monitor Arm -
Single Mount

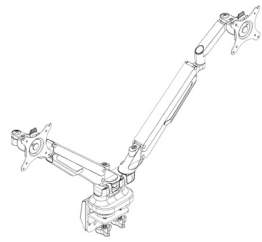

V-AFMA-02
Monitor Arm -
Double Mount

CPU Holder

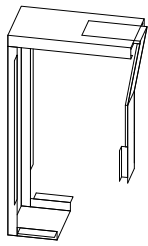

V-ACPU
CPU Holder - Fixed Mount
W: 8.5"
D: 11.5"
H: 18"

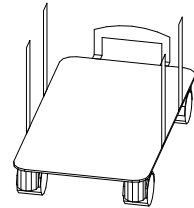

V-ACPU-M
CPU Holder - Mobile
W: 15.5"
D: 9"
H: 4.3"

Wire Manager



V-EE00
Vertical Wire Manager
W: 4"
D: 4"
H: 28"

step-by-step order placement

1. purchase order number
2. quantity
3. product codes and descriptions
4. finishes
5. options
6. provide a drawing or Tayco quotation number
7. shipping address, on-site contact name and phone number
8. shipping instructions
9. confirm access to elevators, loading dock, etc.
10. requested ship date/installation date
11. submit a completed Tayco installation checklist if Tayco is installing the furniture
12. discount, net price and freight charges
13. keep Tayco order numbers on file for reference when placing additional orders



Metro Pricebook
February 2023
Straight Desk

straight

Executive

<u>straight</u>	34
<u>straight partial modesty</u>	38
<u>straight full recessed modesty</u>	42
<u>arc full recessed modesty</u>	46

Professional

<u>straight</u>	36
<u>straight partial modesty</u>	40
<u>straight full recessed modesty</u>	44
<u>arc full recessed modesty</u>	47

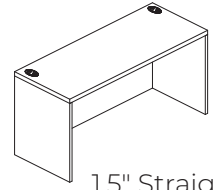

1.5" Straight Desk/Full Modesty

How to Specify:

Each laminate comes with matching vinyl trim color unless otherwise specified on your purchase order. Refer to the laminate finish card for details.

Notes:

Options:

laminate color

edge profile

grommet color

How to Order and Read your Code:

T or TL **TSOG** **60** **21**
 product line item width depth

Code	Price	H	W	D	Volume (ft ³)	Weight (lb)
T-TS0G-6021	892	29.5	60	21	21.51	122.55
T-TS0G-6621	941	29.5	66	21	23.66	131.97
T-TS0G-7221	978	29.5	72	21	25.81	141.39
T-TS0G-7821	1021	29.5	78	21	27.96	150.81
T-TS0G-8421	1079	29.5	84	21	30.11	160.23
T-TS0G-9021	1241	29.5	90	21	32.27	169.65
T-TS0G-9621	1241	29.5	96	21	34.42	179.07
T-TS0G-3024	711	29.5	30	24	12.29	92.02
T-TS0G-3624	755	29.5	36	24	14.75	111.14
T-TS0G-4224	787	29.5	42	24	17.21	130.26
T-TS0G-4824	833	29.5	48	24	19.67	149.38
T-TS0G-5424	881	29.5	54	24	22.13	168.5
T-TS0G-6024	930	29.5	60	24	24.58	187.62
T-TS0G-6624	978	29.5	66	24	27.04	206.74
T-TS0G-7224	1014	29.5	72	24	29.5	225.86
T-TS0G-7824	1064	29.5	78	24	31.96	244.98
T-TS0G-8424	1121	29.5	84	24	34.42	264.1
T-TS0G-9024	1427	29.5	90	24	36.88	283.22
T-TS0G-9624	1427	29.5	96	24	39.33	302.34
T-TS0G-3030	748	29.5	30	30	15.36	99.05
T-TS0G-3630	807	29.5	36	30	18.44	110.58
T-TS0G-4230	854	29.5	42	30	21.51	122.11
T-TS0G-4830	910	29.5	48	30	24.58	133.64
T-TS0G-5430	978	29.5	54	30	27.66	145.17
T-TS0G-6030	1021	29.5	60	30	30.73	156.7
T-TS0G-6630	1064	29.5	66	30	33.8	168.23
T-TS0G-7230	1106	29.5	72	30	36.88	179.76
T-TS0G-7830	1175	29.5	78	30	39.95	191.29
T-TS0G-8430	1233	29.5	84	30	43.02	202.82
T-TS0G-9030	1467	29.5	90	30	46.09	214.35
T-TS0G-9630	1507	29.5	96	30	49.17	225.88

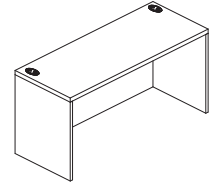

1" Straight Desk w/Full Modesty

How to Specify:

Each laminate comes with matching vinyl trim color unless otherwise specified on your purchase order. Refer to the laminate finish card for details.

Notes:

Options:

laminate color

grommet color

Code	Price	H	W	D	Volume (ft ³)	Weight (lb)
TL-TS0G-6021	823	29	60	21	21.15	107.7
TL-TS0G-6621	870	29	66	21	23.26	117.12
TL-TS0G-7221	903	29	72	21	25.38	126.54
TL-TS0G-7821	948	29	78	21	27.49	135.96
TL-TS0G-8421	1001	29	84	21	29.6	145.38
TL-TS0G-9021	1087	29	90	21	31.72	154.8
TL-TS0G-9621	1087	29	96	21	33.83	164.22
TL-TS0G-3024	658	29	30	24	12.08	77.17
TL-TS0G-3624	703	29	36	24	14.5	96.29
TL-TS0G-4224	729	29	42	24	16.92	115.41
TL-TS0G-4824	771	29	48	24	19.33	134.53
TL-TS0G-5424	814	29	54	24	21.75	153.65
TL-TS0G-6024	859	29	60	24	24.17	172.77
TL-TS0G-6624	903	29	66	24	26.58	191.89
TL-TS0G-7224	941	29	72	24	29	211.01
TL-TS0G-7824	982	29	78	24	31.42	230.13
TL-TS0G-8424	1036	29	84	24	33.83	249.25
TL-TS0G-9024	1304	29	90	24	36.25	268.37
TL-TS0G-9624	1363	29	96	24	38.67	287.49
TL-TS0G-3030	694	29	30	30	15.1	84.2
TL-TS0G-3630	747	29	36	30	18.13	95.73
TL-TS0G-4230	791	29	42	30	21.15	107.26
TL-TS0G-4830	845	29	48	30	24.17	118.79
TL-TS0G-5430	902	29	54	30	27.19	130.32
TL-TS0G-6030	948	29	60	30	30.21	141.85
TL-TS0G-6630	982	29	66	30	33.23	153.38
TL-TS0G-7230	1024	29	72	30	36.25	164.91
TL-TS0G-7830	1085	29	78	30	39.27	176.44
TL-TS0G-8430	1142	29	84	30	42.29	187.97
TL-TS0G-9030	1344	29	90	30	45.31	199.5
TL-TS0G-9630	1416	29	96	30	48.33	211.03

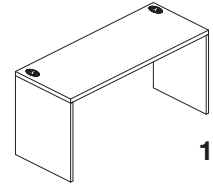

1.5" Straight Desk w/Partial Modesty

How to Specify:

Each laminate comes with matching vinyl trim color unless otherwise specified on your purchase order. Refer to the laminate finish card for details.

Notes:

Partial modesties are 12"H.

Options:

laminate color

edge profile

grommet color

Code	Price	H	W	D	Volume (ft ³)	Weight (lb)
T-TS0Z-6021	892	29.5	60	21	21.51	97.81
T-TS0Z-6621	941	29.5	66	21	23.66	104.54
T-TS0Z-7221	978	29.5	72	21	25.81	111.27
T-TS0Z-7821	1021	29.5	78	21	27.96	118
T-TS0Z-8421	1079	29.5	84	21	30.11	124.73
T-TS0Z-9021	1241	29.5	90	21	32.27	131.46
T-TS0Z-9621	1502	29.5	96	21	34.42	138.19
T-TS0Z-3024	711	29.5	30	24	12.29	71.33
T-TS0Z-3624	755	29.5	36	24	14.75	78.75
T-TS0Z-4224	787	29.5	42	24	17.21	86.17
T-TS0Z-4824	833	29.5	48	24	19.67	93.59
T-TS0Z-5424	881	29.5	54	24	22.13	101.01
T-TS0Z-6024	930	29.5	60	24	24.58	108.43
T-TS0Z-6624	978	29.5	66	24	27.04	115.85
T-TS0Z-7224	1014	29.5	72	24	29.5	123.27
T-TS0Z-7824	1064	29.5	78	24	31.96	130.69
T-TS0Z-8424	1121	29.5	84	24	34.42	138.11
T-TS0Z-9024	1304	29.5	90	24	36.88	145.53
T-TS0Z-9624	1576	29.5	96	24	39.33	152.95
T-TS0Z-3030	748	29.5	30	30	15.36	75.35
T-TS0Z-3630	807	29.5	36	30	18.44	83.98
T-TS0Z-4230	854	29.5	42	30	21.51	92.6
T-TS0Z-4830	910	29.5	48	30	24.58	101.23
T-TS0Z-5430	978	29.5	54	30	27.66	109.85
T-TS0Z-6030	1021	29.5	60	30	30.73	118.48
T-TS0Z-6630	1064	29.5	66	30	33.8	127.1
T-TS0Z-7230	1106	29.5	72	30	36.88	135.73
T-TS0Z-7830	1175	29.5	78	30	39.95	144.35
T-TS0Z-8430	1233	29.5	84	30	43.02	152.98
T-TS0Z-9030	1483	29.5	90	30	46.09	161.6
T-TS0Z-9630	1576	29.5	96	30	49.17	170.23

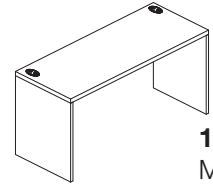

1" Straight Desk w/Partial Modesty

How to Specify:

Each laminate comes with matching vinyl trim color unless otherwise specified on your purchase order. Refer to the laminate finish card for details.

Notes:

Partial modesties are 12"H.

Options:

laminate color

grommet color

Code	Price	H	W	D	Volume (ft ³)	Weight (lb)
TL-TS0Z-6021	823	29	60	21	21.15	81.41
TL-TS0Z-6621	870	29	66	21	23.26	86.6
TL-TS0Z-7221	903	29	72	21	25.38	91.79
TL-TS0Z-7821	948	29	78	21	27.49	96.98
TL-TS0Z-8421	1001	29	84	21	29.6	102.17
TL-TS0Z-9021	1087	29	90	21	31.72	107.36
TL-TS0Z-9621	1166	29	96	21	33.83	112.55
TL-TS0Z-3024	658	29	30	24	12.08	61.95
TL-TS0Z-3624	703	29	36	24	14.5	67.5
TL-TS0Z-4224	729	29	42	24	16.92	73.05
TL-TS0Z-4824	771	29	48	24	19.33	78.6
TL-TS0Z-5424	814	29	54	24	21.75	84.15
TL-TS0Z-6024	859	29	60	24	24.17	89.7
TL-TS0Z-6624	903	29	66	24	26.58	95.25
TL-TS0Z-7224	941	29	72	24	29	100.8
TL-TS0Z-7824	982	29	78	24	31.42	106.35
TL-TS0Z-8424	1036	29	84	24	33.83	111.9
TL-TS0Z-9024	1304	29	90	24	36.25	117.45
TL-TS0Z-9624	1363	29	96	24	38.67	123
TL-TS0Z-3030	694	29	30	30	15.1	63.48
TL-TS0Z-3630	747	29	36	30	18.13	69.97
TL-TS0Z-4230	791	29	42	30	21.15	76.46
TL-TS0Z-4830	845	29	48	30	24.17	82.95
TL-TS0Z-5430	902	29	54	30	27.19	89.44
TL-TS0Z-6030	948	29	60	30	30.21	95.93
TL-TS0Z-6630	982	29	66	30	33.23	102.42
TL-TS0Z-7230	1024	29	72	30	36.25	108.91
TL-TS0Z-7830	1085	29	78	30	39.27	115.4
TL-TS0Z-8430	1142	29	84	30	42.29	121.89
TL-TS0Z-9030	1323	29	90	30	45.31	128.38
TL-TS0Z-9630	1416	29	96	30	48.33	134.87

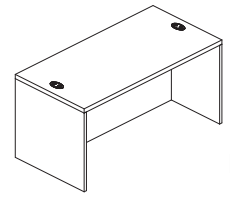

1.5" Straight Desk w/Recessed Full Modesty and Grommets

How to Specify:

Each laminate comes with matching vinyl trim color unless otherwise specified on your purchase order. Refer to the laminate finish card for details.

Options:

laminate color

edge profile

grommet color

Notes:

Recessed modesty:

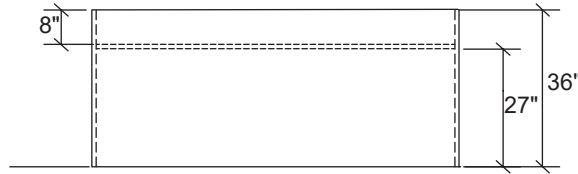

Code	Price	H	W	D	Volume (ft ³)	Weight (lb)
T-TSRG-6030	1041	29.5	60	30	30.73	156.7
T-TSRG-6630	1079	29.5	66	30	33.8	168.23
T-TSRG-7230	1129	29.5	72	30	36.88	179.76
T-TSRG-7830	1194	29.5	78	30	39.95	191.29
T-TSRG-8430	1251	29.5	84	30	43.02	202.82
T-TSRG-9030	1528	29.5	90	30	46.09	214.35
T-TSRG-9630	1592	29.5	96	30	49.17	225.88
T-TSRG-6036	1206	29.5	60	36	36.88	178.2
T-TSRG-6636	1251	29.5	66	36	40.56	190.8
T-TSRG-7236	1299	29.5	72	36	44.25	203.4
T-TSRG-7836	1356	29.5	78	36	47.94	216
T-TSRG-8436	1405	29.5	84	36	51.63	228.6
T-TSRG-9036	1608	29.5	90	36	55.31	241.2
T-TSRG-9636	1676	29.5	96	36	59	253.8

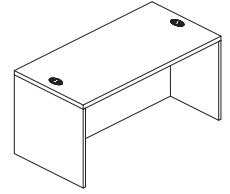

1" Straight Desk w/Recessed Full Modesty and Grommets

How to Specify:

Each laminate comes with matching vinyl trim color unless otherwise specified on your purchase order. Refer to the laminate finish card for details.

Notes:

Recessed modesty:

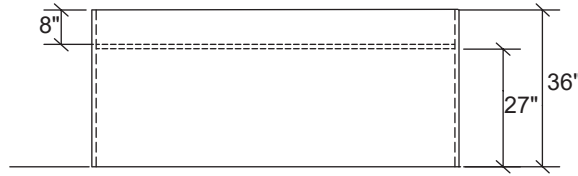

Options:

laminate color

grommet color

Code	Price	H	W	D	Volume (ft ³)	Weight (lb)
TL-TSRG-6030	964	29	60	30	30.21	137.93
TL-TSRG-6630	1001	29	66	30	33.23	149.46
TL-TSRG-7230	1045	29	72	30	36.25	160.99
TL-TSRG-7830	1103	29	78	30	39.27	172.52
TL-TSRG-8430	1158	29	84	30	42.29	184.05
TL-TSRG-9030	1365	29	90	30	45.31	195.58
TL-TSRG-9630	1476	29	96	30	48.33	207.11
TL-TSRG-6036	1117	29	60	36	36.25	150.3
TL-TSRG-6636	1158	29	66	36	39.88	160.2
TL-TSRG-7236	1202	29	72	36	43.5	170.1
TL-TSRG-7836	1255	29	78	36	47.13	180
TL-TSRG-8436	1301	29	84	36	50.75	189.9
TL-TSRG-9036	1436	29	90	36	54.38	199.8
TL-TSRG-9636	1558	29	96	36	58	209.7

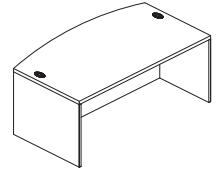

1.5" Arc Desk w/Recessed Full Modesty and Grommets

How to Specify:

Each laminate comes with matching vinyl trim color unless otherwise specified on your purchase order. Refer to the laminate finish card for details.

Options:

laminate color

edge profile

grommet color

Notes:

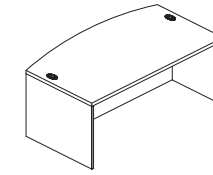
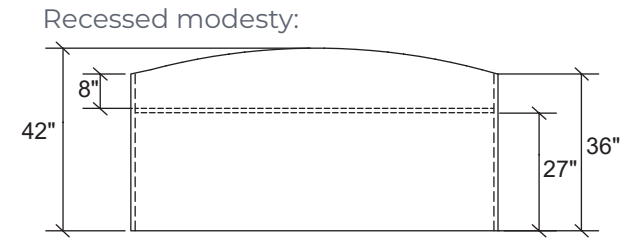

1" Arc Desk w/Recessed Full Modesty and Grommets

How to Specify:

Each laminate comes with matching vinyl trim color unless otherwise specified on your purchase order. Refer to the laminate finish card for details.

Options:

laminate color

grommet color

Notes:

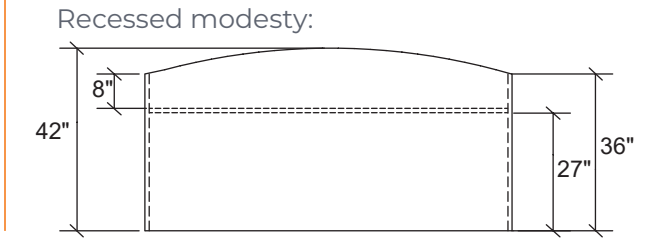

Code	Price	H	W	D	Volume (ft ³)	Weight (lb)
T-TARG-7236	1507	29.5	72	36	44.25	216.17
T-TARG-7836	1576	29.5	78	36	47.94	230.43
T-TARG-8436	1646	29.5	84	36	51.63	244.69
T-TARG-9036	1741	29.5	90	36	55.31	258.95
T-TARG-9636	1826	29.5	96	36	59	273.21

Code	Price	H	W	D	Volume (ft ³)	Weight (lb)
TL-TARG-7236	1401	29	72	36	43.5	178.09
TL-TARG-7836	1471	29	78	36	47.13	188.84
TL-TARG-8436	1543	29	84	36	50.75	199.59
TL-TARG-9036	1608	29	90	36	54.38	210.34
TL-TARG-9636	1676	29	96	36	58	221.09



Metro Pricebook
February 2023
Tables

Executive

D-table	50
J-table	52
P-table	54
F-table	56
U-table	58
C-table	60

Professional

D-table	51
J-table	53
P-table	55
F-table	57
U-table	59
C-table	61

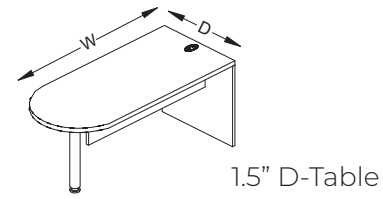

How to Specify:

Each laminate comes with matching vinyl trim color unless otherwise specified on your purchase order. Refer to the laminate finish card for details.

Options:

- laminate color

- edge profile

- grommet color

- metal color (for post support)

Notes:

36\"/>

How to Order and Read your Code:

T or TL **TD0G** **60** **30**
 product line item width depth

Code	Price	H	W	D	Volume (ft ³)	Weight (lb)
T-TD0G-6030	1244	29.5	60	30	30.73	108.29
T-TD0G-6630	1284	29.5	66	30	33.8	117.27
T-TD0G-7230	1328	29.5	72	30	36.88	126.25
T-TD0G-7830	1368	29.5	78	30	39.95	135.23
T-TD0G-8430	1408	29.5	84	30	43.02	144.21
T-TD0G-6036	1335	29.5	60	36	36.88	131.34
T-TD0G-6636	1388	29.5	66	36	40.56	141.76
T-TD0G-7236	1417	29.5	72	36	44.25	152.18
T-TD0G-7836	1455	29.5	78	36	47.94	162.6
T-TD0G-8436	1497	29.5	84	36	51.63	173.02

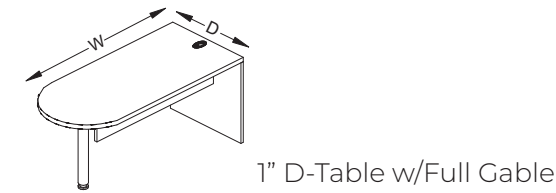

How to Specify:

Each laminate comes with matching vinyl trim color unless otherwise specified on your purchase order. Refer to the laminate finish card for details.

Options:

- laminate color

- grommet color

- metal color (for post support)

Notes:

36\"/>

Code	Price	H	W	D	Volume (ft ³)	Weight (lb)
TL-TD0G-6030	1020	29	60	30	30.21	86.48
TL-TD0G-6630	1064	29	66	30	33.23	92.95
TL-TD0G-7230	1102	29	72	30	36.25	99.42
TL-TD0G-7830	1142	29	78	30	39.27	105.9
TL-TD0G-8430	1186	29	84	30	42.29	112.38
TL-TD0G-6036	1113	29	60	36	36.25	107.18
TL-TD0G-6636	1162	29	66	36	39.88	115.76
TL-TD0G-7236	1194	29	72	36	43.5	124.34
TL-TD0G-7836	1234	29	78	36	47.13	132.92
TL-TD0G-8436	1277	29	84	36	50.75	141.5

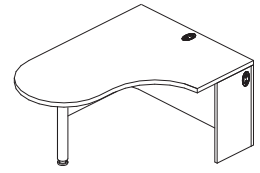

1.5" J-Table, LH Shown

How to Specify:

Each laminate comes with matching vinyl trim color unless otherwise specified on your purchase order. Refer to the laminate finish card for details.

Notes:

Options:

- laminate color

- edge profile

- grommet color

- metal color (for post support)

Code	Price	H	W	D	Volume (ft ³)	Weight (lb)
Left Hand						
T-TJ0G-604824-L	1640	29.5	60	24	24.58	149.48
T-TJ0G-664824-L	1749	29.5	66	24	27.04	158.56
T-TJ0G-724824-L	1838	29.5	72	24	29.5	167.64
T-TJ0G-784824-L	1934	29.5	78	24	31.96	176.72
T-TJ0G-844824-L	2025	29.5	84	24	34.42	185.8
Right Hand						
T-TJ0G-604824-R	1640	29.5	60	24	24.58	149.48
T-TJ0G-664824-R	1749	29.5	66	24	27.04	158.56
T-TJ0G-724824-R	1838	29.5	72	24	29.5	167.64
T-TJ0G-784824-R	1934	29.5	78	24	31.96	176.72
T-TJ0G-844824-R	2025	29.5	84	24	34.42	185.8

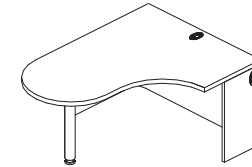

1" J-Table, LH Shown

How to Specify:

Each laminate comes with matching vinyl trim color unless otherwise specified on your purchase order. Refer to the laminate finish card for details.

Notes:

36"D D-tables include two post supports.

Options:

- laminate color

- grommet color

- metal color (for post support)

Code	Price	H	W	D	Volume (ft ³)	Weight (lb)
Left Hand						
TL-TJ0G-604824L	1529	29	60	24	24.17	120.67
TL-TJ0G-664824L	1641	29	66	24	26.58	127.15
TL-TJ0G-724824L	1729	29	72	24	29	133.63
TL-TJ0G-784824L	1827	29	78	24	31.42	140.11
TL-TJ0G-844824L	1916	29	84	24	33.83	146.59
Right Hand						
TL-TJ0G-604824R	1529	29	60	24	24.17	120.67
TL-TJ0G-664824R	1641	29	66	24	26.58	127.15
TL-TJ0G-724824R	1729	29	72	24	29	133.63
TL-TJ0G-784824R	1827	29	78	24	31.42	140.11
TL-TJ0G-844824R	1916	29	84	24	33.83	146.59

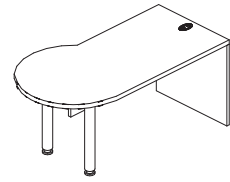

1.5" P-Table, LH Shown

How to Specify:

Each laminate comes with matching vinyl trim color unless otherwise specified on your purchase order. Refer to the laminate finish card for details.

Notes:

Options:

- laminate color

- edge profile

- grommet color

- metal color (for post support)

Code	Price	H	W	D	Volume (ft ³)	Weight (lb)
Left Hand						
T-TP0G-6030-L	1507	29.5	60	30	30.73	119.92
T-TP0G-6630-L	1576	29.5	66	30	33.8	128.78
T-TP0G-7230-L	1629	29.5	72	30	36.88	137.64
T-TP0G-7830-L	1694	29.5	78	30	39.95	146.5
T-TP0G-8430-L	1755	29.5	84	30	43.02	155.36
Right Hand						
T-TP0G-6030-R	1507	29.5	60	30	30.73	119.92
T-TP0G-6630-R	1576	29.5	66	30	33.8	128.78
T-TP0G-7230-R	1629	29.5	72	30	36.88	137.64
T-TP0G-7830-R	1694	29.5	78	30	39.95	146.5
T-TP0G-8430-R	1755	29.5	84	30	43.02	155.36

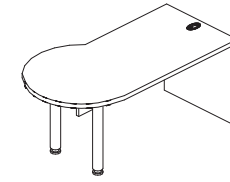

1" P-Table, LH Shown

How to Specify:

Each laminate comes with matching vinyl trim color unless otherwise specified on your purchase order. Refer to the laminate finish card for details.

Notes:

36"D D-tables include two post supports.

Options:

- laminate color

- grommet color

- metal color (for post support)

Code	Price	H	W	D	Volume (ft ³)	Weight (lb)
Left Hand						
TL-TP0G-6030-L	1401	29	60	30	30.21	96.51
TL-TP0G-6630-L	1471	29	66	30	33.23	103.34
TL-TP0G-7230-L	1522	29	72	30	36.25	110.17
TL-TP0G-7830-L	1588	29	78	30	39.27	117
TL-TP0G-8430-L	1647	29	84	30	42.29	123.83
Right Hand						
TL-TP0G-6030-R	1401	29	60	30	30.21	96.51
TL-TP0G-6630-R	1471	29	66	30	33.23	103.34
TL-TP0G-7230-R	1522	29	72	30	36.25	110.17
TL-TP0G-7830-R	1588	29	78	30	39.27	117
TL-TP0G-8430-R	1647	29	84	30	42.29	123.83

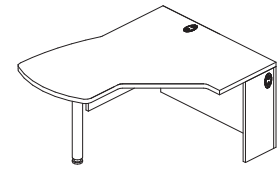

1.5" F-Table, LH Shown

How to Specify:

Each laminate comes with matching vinyl trim color unless otherwise specified on your purchase order. Refer to the laminate finish card for details.

Notes:

Options:

- laminate color

- edge profile

- grommet color

- metal color (for post support)

Code	Price	H	W	D	Volume (ft ³)	Weight (lb)
Left Hand						
T-TFSG-604824-L	1928	29.5	60	24	24.58	152.9
T-TFSG-664824-L	1969	29.5	66	24	27.04	161.05
T-TFSG-724824-L	2010	29.5	72	24	29.5	169.2
T-TFSG-784824-L	2048	29.5	78	24	31.96	177.35
T-TFSG-844824-L	2090	29.5	84	24	34.42	185.5
Right Hand						
T-TFSG-604824-R	1928	29.5	60	24	24.58	152.9
T-TFSG-664824-R	1969	29.5	66	24	27.04	161.05
T-TFSG-724824-R	2010	29.5	72	24	29.5	169.2
T-TFSG-784824-R	2048	29.5	78	24	31.96	177.35
T-TFSG-844824-R	2090	29.5	84	24	34.42	185.5

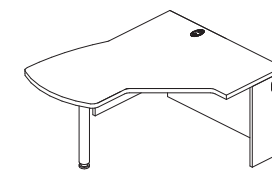

1" F-Table, LH Shown

How to Specify:

Each laminate comes with matching vinyl trim color unless otherwise specified on your purchase order. Refer to the laminate finish card for details.

Notes:

Options:

- laminate color

- grommet color

- metal color (for post support)

Code	Price	H	W	D	Volume (ft ³)	Weight (lb)
Left Hand						
TL-TFSG-604824L	1867	29	60	24	24.17	123.35
TL-TFSG-664824L	1898	29	66	24	26.58	129.35
TL-TFSG-724824L	1932	29	72	24	29	135.35
TL-TFSG-784824L	1965	29	78	24	31.42	141.35
TL-TFSG-844824L	1998	29	84	24	33.83	147.35
Right Hand						
TL-TFSG-604824R	1867	29	60	24	24.17	123.35
TL-TFSG-664824R	1898	29	66	24	26.58	129.35
TL-TFSG-724824R	1932	29	72	24	29	135.35
TL-TFSG-784824R	1965	29	78	24	31.42	141.35
TL-TFSG-844824R	1998	29	84	24	33.83	147.35

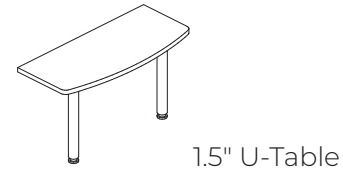

How to Specify:

Each laminate comes with matching vinyl trim color unless otherwise specified on your purchase order. Refer to the laminate finish card for details.

Notes:

Options:

- laminate color

- edge profile

- metal color (for post support)

Code	Price	H	W	D	Volume (ft ³)	Weight (lb)
T-WEU0-4224	921	29.5	42	24	17.21	51.19
T-WEU0-4824	952	29.5	48	24	19.67	56.54
T-WEU0-6024	1123	29.5	60	24	24.58	61.88

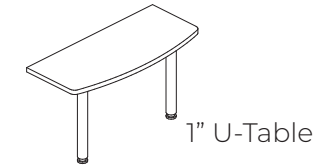

How to Specify:

Each laminate comes with matching vinyl trim color unless otherwise specified on your purchase order. Refer to the laminate finish card for details.

Notes:

Options:

- laminate color

- metal color (for post support)

Code	Price	H	W	D	Volume (ft ³)	Weight (lb)
TL-WEU0-4224	795	29	42	24	16.92	38.79
TL-WEU0-4824	826	29	48	24	19.33	42.36
TL-WEU0-6024	997	29	60	24	24.17	45.92

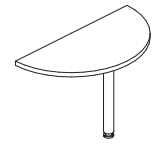

1.5" C-Table

How to Specify:

Each laminate comes with matching vinyl trim color unless otherwise specified on your purchase order. Refer to the laminate finish card for details.

Notes:

Options:

laminate color

edge profile

metal color (for post support)

Code	Price	H	W	D	Volume (ft ³)	Weight (lb)
T-TC00-4221	663	29.5	42	21	15.06	34
T-TC00-4824	763	29.5	48	24	19.67	42.1
T-TC00-6030	859	29.5	60	30	30.73	50

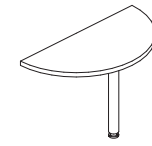

1" C-Table

How to Specify:

Each laminate comes with matching vinyl trim color unless otherwise specified on your purchase order. Refer to the laminate finish card for details.

Notes:

Options:

laminate color

metal color (for post support)

Code	Price	H	W	D	Volume (ft ³)	Weight (lb)
TL-TC00-4221	617	29	42	21	14.8	25
TL-TC00-4824	714	29	48	24	19.33	30.56
TL-TC00-6030	813	29	60	30	30.21	36.12



Metro Pricebook
February 2023
Corners

corners

Executive

straight front corner

<u>full modesty</u>	64
<u>partial modesty</u>	66
<u>full modesty no gables</u>	68

curved front corner

<u>full modesty</u>	70
<u>partial modesty</u>	72
<u>full modesty no gables</u>	74

Professional

straight front corner

<u>full modesty</u>	65
<u>partial modesty</u>	67
<u>full modesty no gables</u>	69

curved front corner

<u>full modesty</u>	71
<u>partial modesty</u>	73
<u>full modesty no gables</u>	75

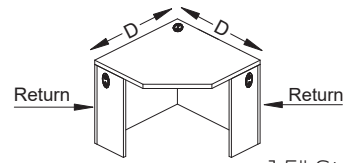

1.5" Straight Front Corner Worksurface
w/Full Modesties

How to Specify:

Each laminate comes with matching vinyl trim color unless otherwise specified on your purchase order. Refer to the laminate finish card for details.

Options:

laminate color

edge profile

grommet color

How to Order and Read your Code:

T or TL **W5S0** **36** **21**
 product line item depth return size

Code	Price	H	D	Return	Volume (ft ³)	Weight (lb)
T-W5S0-3621	1021	29.5	36	21	12.91	114.3
T-W5S0-3624	1021	29.5	36	24	14.75	116.21
T-W5S0-4221	1202	29.5	42	21	15.06	137.24
T-W5S0-4224	1202	29.5	42	24	17.21	139.52

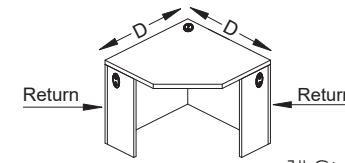

1" Straight Front Corner Worksurface
w/Full Modesties

How to Specify:

Each laminate comes with matching vinyl trim color unless otherwise specified on your purchase order. Refer to the laminate finish card for details.

Options:

laminate color

grommet color

Code	Price	H	D	Return	Volume (ft ³)	Weight (lb)
TL-W5S0-3621	948	29	36	21	12.69	99.2
TL-W5S0-3624	948	29	36	24	14.5	100.27
TL-W5S0-4221	1114	29	42	21	14.8	117.14
TL-W5S0-4224	1114	29	42	24	16.92	118.66

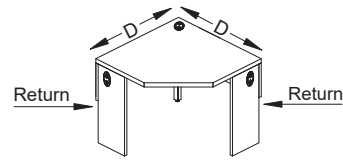

1.5" Straight Front Corner Worksurface w/Partial Modesties and Post

How to Specify:

Each laminate comes with matching vinyl trim color unless otherwise specified on your purchase order. Refer to the laminate finish card for details.

Notes:

Partial modesties are 12"H.

Options:

- laminate color

- edge profile

- grommet color

- metal color (for post support)

Code	Price	H	D	Return	Volume (ft ³)	Weight (lb)
T-W5S0-3621-P	1021	29.5	36	21	12.91	84.74
T-W5S0-3624-P	1021	29.5	36	24	14.75	86.65
T-W5S0-4221-P	1202	29.5	42	21	15.06	102.88
T-W5S0-4224-P	1202	29.5	42	24	17.21	105.16

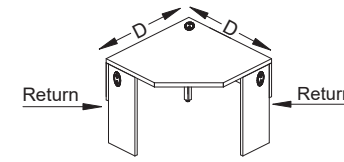

1" Straight Front Corner Worksurface w/Partial Modesties and Post

How to Specify:

Each laminate comes with matching vinyl trim color unless otherwise specified on your purchase order. Refer to the laminate finish card for details.

Notes:

Partial modesties are 12"H.

Options:

- laminate color

- grommet color

- metal color (for post support)

Code	Price	H	D	Return	Volume (ft ³)	Weight (lb)
TL-W5S0-3621-P	948	29	36	21	12.69	69.94
TL-W5S0-3624-P	948	29	36	24	14.5	70.71
TL-W5S0-4221-P	1114	29	42	21	14.8	82.78
TL-W5S0-4224-P	1114	29	42	24	16.92	84.3

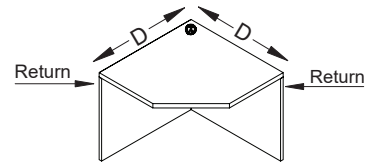

1.5" Straight Front Corner Worksurface
w/Full Modesties, No Gables

How to Specify:

Each laminate comes with matching vinyl trim color unless otherwise specified on your purchase order. Refer to the laminate finish card for details.

Options:

laminate color

edge profile

grommet color

Code	Price	H	D	Return	Volume (ft ³)	Weight (lb)
T-W5S0-3621-N	748	29.5	36	21	12.91	114.3
T-W5S0-3624-N	748	29.5	36	24	14.75	116.21
T-W5S0-4221-N	931	29.5	42	21	15.06	137.24
T-W5S0-4224-N	931	29.5	42	24	17.21	139.52

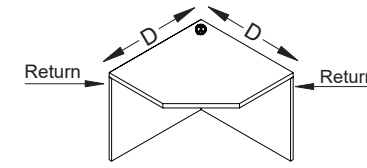

1" Straight Front Corner Worksurface
w/Full Modesties, No Gables

How to Specify:

Each laminate comes with matching vinyl trim color unless otherwise specified on your purchase order. Refer to the laminate finish card for details.

Options:

laminate color

grommet color

Code	Price	H	D	Return	Volume (ft ³)	Weight (lb)
TL-W5S0-3621-N	675	29.5	36	21	12.91	99.2
TL-W5S0-3624-N	675	29.5	36	24	14.75	100.27
TL-W5S0-4221-N	843	29.5	42	21	15.06	117.14
TL-W5S0-4224-N	843	29.5	42	24	17.21	118.66

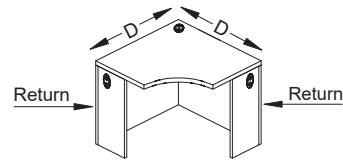

1.5" Curved Front Corner Worksurface
w/Full Modesties

How to Specify:

Each laminate comes with matching vinyl trim color unless otherwise specified on your purchase order. Refer to the laminate finish card for details.

Options:

laminates color

edge profile

grommet color

Code	Price	H	D	Return	Volume (ft ³)	Weight (lb)
T-W5C0-3621	1021	29.5	36	21	12.91	112.21
T-W5C0-3624	1021	29.5	36	24	14.75	114.6
T-W5C0-4221	1202	29.5	42	21	15.06	132.52
T-W5C0-4224	1202	29.5	42	24	17.21	136.12

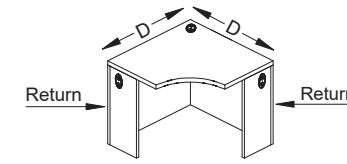

1" Curved Front Corner Worksurface
w/Full Modesties

How to Specify:

Each laminate comes with matching vinyl trim color unless otherwise specified on your purchase order. Refer to the laminate finish card for details.

Options:

laminates color

grommet color

Code	Price	H	D	Return	Volume (ft ³)	Weight (lb)
TL-W5C0-3621	948	29	36	21	12.69	97.54
TL-W5C0-3624	948	29	36	24	14.5	98.3
TL-W5C0-4221	1114	29	42	21	14.8	113.86
TL-W5C0-4224	1114	29	42	24	16.92	116.26

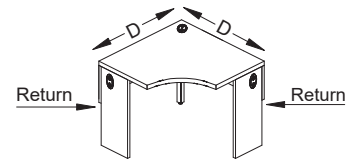

1.5" Curved Front Corner Worksurface
w/Partial Modesties and Post

How to Specify:

Each laminate comes with matching vinyl trim color unless otherwise specified on your purchase order. Refer to the laminate finish card for details.

Notes:

Partial modesties are 12"H.

Options:

- laminate color

- edge profile

- grommet color

- metal color (for post support)

Code	Price	H	D	Return	Volume (ft ³)	Weight (lb)
T-W5C0-3621-P	1021	29.5	36	21	12.91	82.62
T-W5C0-3624-P	1021	29.5	36	24	14.75	85.1
T-W5C0-4221-P	1202	29.5	42	21	15.06	94.27
T-W5C0-4224-P	1202	29.5	42	24	17.21	97.87

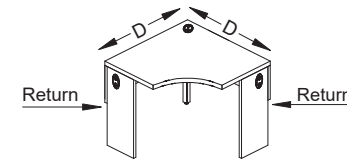

1" Curved Front Corner Worksurface
w/Partial Modesties and Post

How to Specify:

Each laminate comes with matching vinyl trim color unless otherwise specified on your purchase order. Refer to the laminate finish card for details.

Notes:

Partial modesties are 12"H.

Options:

- laminate color

- grommet color

- metal color (for post support)

Code	Price	H	D	Return	Volume (ft ³)	Weight (lb)
TL-W5C0-3621-P	948	29	36	21	12.69	67.98
TL-W5C0-3624-P	948	29	36	24	14.5	68.74
TL-W5C0-4221-P	1114	29	42	21	14.8	75.61
TL-W5C0-4224-P	1114	29	42	24	16.92	78.01

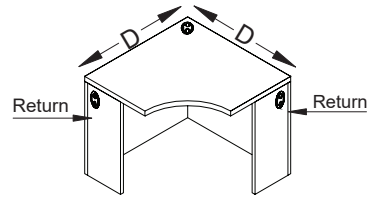

1.5" Curved Front Corner Worksurface
w/Full Modesties, No Gables

How to Specify:

Each laminate comes with matching vinyl trim color unless otherwise specified on your purchase order. Refer to the laminate finish card for details.

Options:

- laminate color _____
- edge profile _____
- grommet color _____

Code	Price	H	D	Return	Volume (ft ³)	Weight (lb)
T-W5C0-3621-N	748	29.5	36	21	12.91	112.21
T-W5C0-3624-N	748	29.5	36	24	14.75	114.6
T-W5C0-4221-N	931	29.5	42	21	15.06	132.52
T-W5C0-4224-N	931	29.5	42	24	17.21	136.12

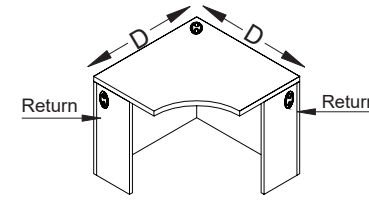

1" Curved Corner Worksurface
w/Full Modesties, No Gables

How to Specify:

Each laminate comes with matching vinyl trim color unless otherwise specified on your purchase order. Refer to the laminate finish card for details.

Options:

- laminate color _____
- grommet color _____

Code	Price	H	D	Return	Volume (ft ³)	Weight (lb)
TL-W5C0-3621-N	675	29.5	36	21	12.91	97.54
TL-W5C0-3624-N	675	29.5	36	24	14.75	98.3
TL-W5C0-4221-N	843	29.5	42	21	15.06	113.66
TL-W5C0-4224-N	843	29.5	42	24	17.21	116.26



Metro Pricebook
February 2023
Unitized Desks

unitized desks

Executive

<u>w/full modesties, full and partial gables</u>	78
<u>w/full modesties, no gables</u>	80
<u>w/partial modesty</u>	82

Professional

<u>w/full modesties, full and partial gables</u>	79
<u>w/full modesties, no gables</u>	81
<u>w/ partial modesties</u>	83

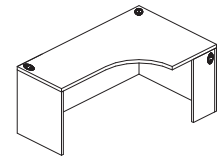

1.5" Curved Front Unitized Desk w/Full Modesties, Full and Partial Gables, LH Shown

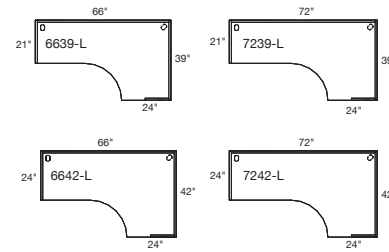

How to Specify:

Each laminate comes with matching vinyl trim color unless otherwise specified on your purchase order. Refer to the laminate finish card for details.

Notes:

Options:

- laminate color

- edge profile

- grommet color

Code	Price	H	W	D	Volume (ft ³)	Weight (lb)
T-UC4G-6639-L	1574	29.5	66	39	43.94	146.65
T-UC4G-7239-L	1676	29.5	72	39	47.94	181.17
T-UC4G-6639-R	1574	29.5	66	39	43.94	146.65
T-UC4G-7239-R	1676	29.5	72	39	47.94	181.17
T-UC4G-6642-L	1640	29.5	66	42	47.32	184.39
T-UC4G-7242-L	1965	29.5	72	42	51.63	194.16
T-UC4G-6642-R	1640	29.5	66	42	47.32	184.39
T-UC4G-7242-R	1965	29.5	72	42	51.63	194.16

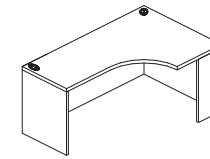

1" Curved Front Unitized Desk w/Full Modesties, Full and Partial Gables, LH Shown

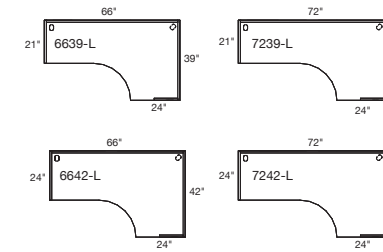

How to Specify:

Each laminate comes with matching vinyl trim color unless otherwise specified on your purchase order. Refer to the laminate finish card for details.

Notes:

Options:

- laminate color

- grommet color

Code	Price	H	W	D	Volume (ft ³)	Weight (lb)
TL-UC4G-6639-L	1459	29	66	39	43.2	120.6
TL-UC4G-7239-L	1552	29	72	39	47.13	153.9
TL-UC4G-6639-R	1459	29	66	39	43.2	120.6
TL-UC4G-7239-R	1552	29	72	39	47.13	153.9
TL-UC4G-6642-L	1519	29	66	42	46.52	161.1
TL-UC4G-7242-L	1822	29	72	42	50.75	170.55
TL-UC4G-6642-R	1519	29	66	42	46.52	161.1
TL-UC4G-7242-R	1822	29	72	42	50.75	170.55

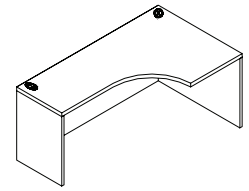

1.5" Curved Front Unitized Desk
w/Full Modesties, No Gables
LH Shown

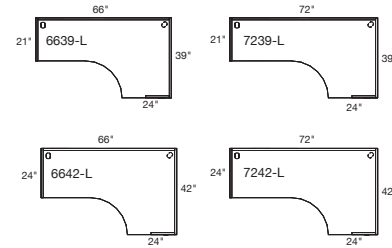

How to Specify:

Each laminate comes with matching vinyl trim color unless otherwise specified on your purchase order. Refer to the laminate finish card for details.

Notes:

Options:

- laminate color

- edge profile

- grommet color

Code	Price	H	W	D	Volume (ft ³)	Weight (lb)
T-UC4G-6639-L-N	1440	29.5	66	39	43.94	146.65
T-UC4G-7239-L-N	1543	29.5	72	39	47.94	181.17
T-UC4G-6639-R-N	1440	29.5	66	39	43.94	146.65
T-UC4G-7239-R-N	1543	29.5	72	39	47.94	181.17
T-UC4G-6642-L-N	1502	29.5	66	42	47.32	184.39
T-UC4G-7242-L-N	1828	29.5	72	42	51.63	194.16
T-UC4G-6642-R-N	1502	29.5	66	42	47.32	184.39
T-UC4G-7242-R-N	1828	29.5	72	42	51.63	194.16

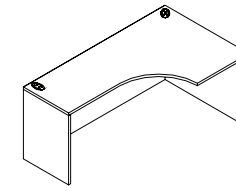

1" Curved Front Unitized Desk
w/Full Modesties, No Gables
LH Shown

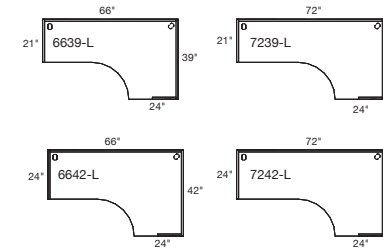

How to Specify:

Each laminate comes with matching vinyl trim color unless otherwise specified on your purchase order. Refer to the laminate finish card for details.

Notes:

Options:

- laminate color

- grommet color

Code	Price	H	W	D	Volume (ft ³)	Weight (lb)
TL-UC4G-6639-L-N	1323	29.5	66	39	43.94	120.6
TL-UC4G-7239-L-N	1417	29.5	72	39	47.94	153.9
TL-UC4G-6639-R-N	1323	29.5	66	39	43.94	120.6
TL-UC4G-7239-R-N	1417	29.5	72	39	47.94	153.9
TL-UC4G-6642-L-N	1379	29.5	66	42	47.32	161.1
TL-UC4G-7242-L-N	1682	29.5	72	42	51.63	170.55
TL-UC4G-6642-R-N	1379	29.5	66	42	47.32	161.1
TL-UC4G-7242-R-N	1682	29.5	72	42	51.63	170.55

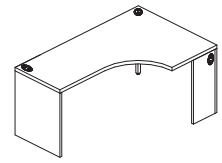

1.5" Curved Front Unitized Desk w/Partial Modesties, Full and Partial Gables, LH Shown

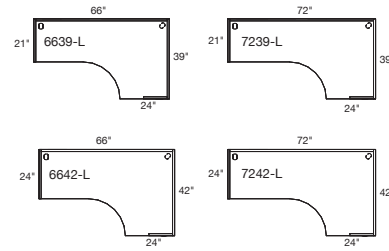

How to Specify:

Each laminate comes with matching vinyl trim color unless otherwise specified on your purchase order. Refer to the laminate finish card for details.

Notes:

Partial modesties are 12"H.

Options:

- laminate color

- edge profile

- grommet color

- metal color (for post support)

Code	Price	H	W	D	Volume (ft ³)	Weight (lb)
T-UC4Z-6639-L	1574	29.5	66	39	43.94	104.04
T-UC4Z-7239-L	1676	29.5	72	39	47.94	110.22
T-UC4Z-6639-R	1574	29.5	66	39	43.94	104.04
T-UC4Z-7239-R	1676	29.5	72	39	47.94	110.22
T-UC4Z-6642-L	1640	29.5	66	42	47.32	137.95
T-UC4Z-7242-L	1965	29.5	72	42	51.63	149.72
T-UC4Z-6642-R	1640	29.5	66	42	47.32	137.95
T-UC4Z-7242-R	1965	29.5	72	42	51.63	149.72

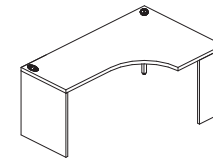

1" Curved Front Unitized Desk w/Partial Modesties, Full and Partial Gables, LH Shown

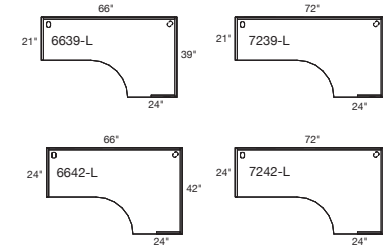

How to Specify:

Each laminate comes with matching vinyl trim color unless otherwise specified on your purchase order. Refer to the laminate finish card for details.

Notes:

Partial modesties are 12"H.

Options:

- laminate color

- grommet color

- metal color (for post support)

Code	Price	H	W	D	Volume (ft ³)	Weight (lb)
TL-UC4Z-6639-L	1459	29	66	39	43.2	99.79
TL-UC4Z-7239-L	1552	29	72	39	47.13	108.77
TL-UC4Z-6639-R	1459	29	66	39	43.2	99.79
TL-UC4Z-7239-R	1552	29	72	39	47.13	108.77
TL-UC4Z-6642-L	1519	29	66	42	46.52	114.66
TL-UC4Z-7242-L	1822	29	72	42	50.75	126.11
TL-UC4Z-6642-R	1519	29	66	42	46.52	114.66
TL-UC4Z-7242-R	1822	29	72	42	50.75	126.11



Metro Pricebook
February 2023
Bridges

bridges

Executive

bowed bridge

full modesty 86

partial modesty 88

Professional

bowed bridge

full modesty 87

partial modesty 89

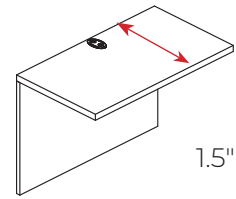

1.5" Straight Bridge w/Full Modesty

How to Specify:

Each laminate comes with matching vinyl trim color unless otherwise specified on your purchase order. Refer to the laminate finish card for details.

Notes:

Options:

- laminate color

- edge profile

- grommet color

Code	Price	H	W	D	Volume (ft ³)	Weight (lb)
T-BS0G-3021	474	29.5	30	21	10.76	46.17
T-BS0G-3621	510	29.5	36	21	12.91	55.5
T-BS0G-4221	569	29.5	42	21	15.06	64.83
T-BS0G-4821	605	29.5	48	21	17.21	74.16
T-BS0G-3024	495	29.5	30	24	12.29	49.5
T-BS0G-3624	532	29.5	36	24	14.75	60
T-BS0G-4224	590	29.5	42	24	17.21	70.5
T-BS0G-4824	663	29.5	48	24	19.67	81

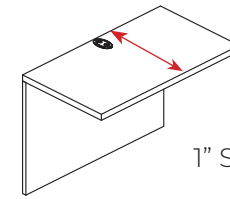

1" Straight Bridge w/Full Modesty

How to Specify:

Each laminate comes with matching vinyl trim color unless otherwise specified on your purchase order. Refer to the laminate finish card for details.

Notes:

Options:

- laminate color

- grommet color

Code	Price	H	W	D	Volume (ft ³)	Weight (lb)
TL-BS0G-3021	447	29	30	21	10.57	38
TL-BS0G-3621	482	29	36	21	12.69	45.78
TL-BS0G-4221	536	29	42	21	14.8	53.56
TL-BS0G-4821	573	29	48	21	16.92	61.34
TL-BS0G-3024	468	29	30	24	12.08	40.35
TL-BS0G-3624	501	29	36	24	14.5	48.6
TL-BS0G-4224	553	29	42	24	16.92	56.85
TL-BS0G-4824	627	29	48	24	19.33	65.1

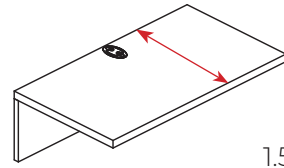

1.5" Straight Bridge w/Partial Modesty

How to Specify:

Each laminate comes with matching vinyl trim color unless otherwise specified on your purchase order. Refer to the laminate finish card for details.

Notes:

Partial modesties are 12"H.

Options:

laminate color

edge profile

grommet color

Code	Price	H	W	D	Volume (ft ³)	Weight (lb)
T-BS0Z-3021	474	29.5	30	21	10.76	33.67
T-BS0Z-3621	510	29.5	36	21	12.91	43
T-BS0Z-4221	569	29.5	42	21	15.06	52.33
T-BS0Z-4821	605	29.5	48	21	17.21	61.66
T-BS0Z-3024	495	29.5	30	24	12.29	33.3
T-BS0Z-3624	532	29.5	36	24	14.75	43.8
T-BS0Z-4224	590	29.5	42	24	17.21	54.3
T-BS0Z-4824	663	29.5	48	24	19.67	64.8

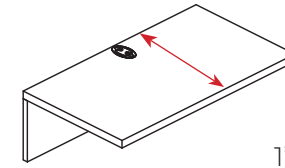

1" Straight Bridge w/Partial Modesty

How to Specify:

Each laminate comes with matching vinyl trim color unless otherwise specified on your purchase order. Refer to the laminate finish card for details.

Notes:

Partial modesties are 12"H.

Options:

laminate color

grommet color

Code	Price	H	W	D	Volume (ft ³)	Weight (lb)
TL-BS0Z-3021	447	29	30	21	10.57	25.4
TL-BS0Z-3621	482	29	36	21	12.69	33.18
TL-BS0Z-4221	536	29	42	21	14.8	40.96
TL-BS0Z-4821	573	29	48	21	16.92	48.74
TL-BS0Z-3024	468	29	30	24	12.08	27.75
TL-BS0Z-3624	501	29	36	24	14.5	36
TL-BS0Z-4224	553	29	42	24	16.92	44.25
TL-BS0Z-4824	627	29	48	24	19.33	52.5



Metro Pricebook
February 2023
Returns

returns

Executive

straight return full modesty 92

straight return partial modesty 96

Professional

straight return full modesty 94

straight return partial modesty 98

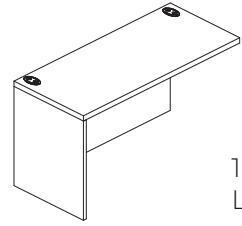

1.5" Straight Return w/Full Modesty, LH Shown

How to Specify:

Each laminate comes with matching vinyl trim color unless otherwise specified on your purchase order. Refer to the laminate finish card for details.

Notes:

1 grommet for width 48" or less
2 grommets for width 54" and wider

Options:

laminate color

edge profile

grommet color

Code	Price	H	W	D	Volume (ft ³)	Weight (lb)
T-WS1G-2421-L	694	29.5	24	21	8.6	51.3
T-WS1G-3021-L	703	29.5	30	21	10.76	60.74
T-WS1G-3621-L	713	29.5	36	21	12.91	70.18
T-WS1G-4221-L	726	29.5	42	21	15.06	79.62
T-WS1G-4821-L	765	29.5	48	21	17.21	89.06
T-WS1G-5421-L	803	29.5	54	21	19.36	98.5
T-WS1G-6021-L	846	29.5	60	21	21.51	107.94
T-WS1G-2421-R	694	29.5	24	21	8.6	51.3
T-WS1G-3021-R	703	29.5	30	21	10.76	60.74
T-WS1G-3621-R	713	29.5	36	21	12.91	70.18
T-WS1G-4221-R	726	29.5	42	21	15.06	79.62
T-WS1G-4821-R	765	29.5	48	21	17.21	89.06
T-WS1G-5421-R	803	29.5	54	21	19.36	98.5
T-WS1G-6021-R	846	29.5	60	21	21.51	107.94
T-WS1G-2424-L	703	29.5	24	24	9.83	56.65
T-WS1G-3024-L	713	29.5	30	24	12.29	65.92
T-WS1G-3624-L	726	29.5	36	24	14.75	75.19
T-WS1G-4224-L	745	29.5	42	24	17.21	84.46
T-WS1G-4824-L	784	29.5	48	24	19.67	93.73
T-WS1G-5424-L	823	29.5	54	24	22.13	103
T-WS1G-6024-L	866	29.5	60	24	24.58	112.27
T-WS1G-2424-R	703	29.5	24	24	9.83	56.65
T-WS1G-3024-R	713	29.5	30	24	12.29	65.92
T-WS1G-3624-R	726	29.5	36	24	14.75	75.19
T-WS1G-4224-R	745	29.5	42	24	17.21	84.46
T-WS1G-4824-R	784	29.5	48	24	19.67	93.73
T-WS1G-5424-R	823	29.5	54	24	22.13	103
T-WS1G-6024-R	866	29.5	60	24	24.58	112.27
T-WS1G-2430-L	765	29.5	24	30	12.29	66.42
T-WS1G-3030-L	784	29.5	30	30	15.36	77.42
T-WS1G-3630-L	813	29.5	36	30	18.44	88.42
T-WS1G-4230-L	846	29.5	42	30	21.51	99.42
T-WS1G-4830-L	873	29.5	48	30	24.58	110.42
T-WS1G-5430-L	903	29.5	54	30	27.66	121.42
T-WS1G-6030-L	954	29.5	60	30	30.73	132.42
T-WS1G-2430-R	765	29.5	24	30	12.29	66.42
T-WS1G-3030-R	784	29.5	30	30	15.36	77.42
T-WS1G-3630-R	813	29.5	36	30	18.44	88.42
T-WS1G-4230-R	846	29.5	42	30	21.51	99.42
T-WS1G-4830-R	873	29.5	48	30	24.58	110.42
T-WS1G-5430-R	903	29.5	54	30	27.66	121.42
T-WS1G-6030-R	954	29.5	60	30	30.73	132.42

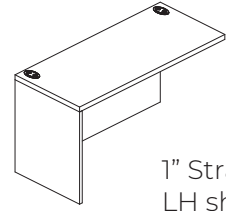

1" Straight return w/Full Modesty
LH shown

How to Specify:

Each laminate comes with matching vinyl trim color unless otherwise specified on your purchase order. Refer to the laminate finish card for details.

Notes:

1 grommet for width 48" or less
2 grommets for width 54" and wider

Options:

laminate color

grommet color

Code	Price	H	W	D	Volume (ft ³)	Weight (lb)
TL-WS1G-2421-L	569	29	24	21	8.46	45
TL-WS1G-3021-L	578	29	30	21	10.57	52.4
TL-WS1G-3621-L	590	29	36	21	12.69	59.8
TL-WS1G-4221-L	597	29	42	21	14.8	67.2
TL-WS1G-4821-L	638	29	48	21	16.92	74.6
TL-WS1G-5421-L	678	29	54	21	19.03	82
TL-WS1G-6021-L	716	29	60	21	21.15	89.4
TL-WS1G-2421-R	569	29	24	21	8.46	45
TL-WS1G-3021-R	578	29	30	21	10.57	52.4
TL-WS1G-3621-R	590	29	36	21	12.69	59.8
TL-WS1G-4221-R	597	29	42	21	14.8	67.2
TL-WS1G-4821-R	638	29	48	21	16.92	74.6
TL-WS1G-5421-R	678	29	54	21	19.03	82
TL-WS1G-6021-R	716	29	60	21	21.15	89.4
TL-WS1G-2424-L	578	29	24	24	9.67	48.75
TL-WS1G-3024-L	590	29	30	24	12.08	56.55
TL-WS1G-3624-L	597	29	36	24	14.5	64.35
TL-WS1G-4224-L	618	29	42	24	16.92	72.15
TL-WS1G-4824-L	657	29	48	24	19.33	79.95
TL-WS1G-5424-L	699	29	54	24	21.75	87.75
TL-WS1G-6024-L	739	29	60	24	24.17	95.55
TL-WS1G-2424-R	578	29	24	24	9.67	48.75
TL-WS1G-3024-R	590	29	30	24	12.08	56.55
TL-WS1G-3624-R	597	29	36	24	14.5	64.35
TL-WS1G-4224-R	618	29	42	24	16.92	72.15
TL-WS1G-4824-R	657	29	48	24	19.33	79.95
TL-WS1G-5424-R	699	29	54	24	21.75	87.75
TL-WS1G-6024-R	739	29	60	24	24.17	95.55
TL-WS1G-2430-L	638	29	24	30	12.08	56.7
TL-WS1G-3030-L	657	29	30	30	15.1	65.73
TL-WS1G-3630-L	689	29	36	30	18.13	74.76
TL-WS1G-4230-L	716	29	42	30	21.15	83.79
TL-WS1G-4830-L	748	29	48	30	24.17	92.82
TL-WS1G-5430-L	781	29	54	30	27.19	101.85
TL-WS1G-6030-L	831	29	60	30	30.21	110.88
TL-WS1G-2430-R	638	29	24	30	12.08	56.7
TL-WS1G-3030-R	657	29	30	30	15.1	65.73
TL-WS1G-3630-R	689	29	36	30	18.13	74.76
TL-WS1G-4230-R	716	29	42	30	21.15	83.79
TL-WS1G-4830-R	748	29	48	30	24.17	92.82
TL-WS1G-5430-R	781	29	54	30	27.19	101.85
TL-WS1G-6030-R	831	29	60	30	30.21	110.88

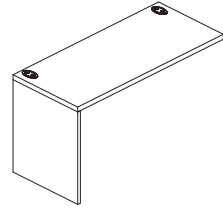

1.5" Straight Return w/Partial Modesty, LH Shown

How to Specify:

Each laminate comes with matching vinyl trim color unless otherwise specified on your purchase order. Refer to the laminate finish card for details.

Notes:

Partial modesties are 12"H
 1 grommet for width 48" or less
 2 grommets for width 54" and wider

Options:

laminate color

edge profile

grommet color

Code	Price	H	W	D	Volume (ft ³)	Weight (lb)
T-WS1Z-2421-L	694	29.5	24	21	8.6	41.4
T-WS1Z-3021-L	703	29.5	30	21	10.76	48.66
T-WS1Z-3621-L	713	29.5	36	21	12.91	58.1
T-WS1Z-4221-L	726	29.5	42	21	15.06	67.54
T-WS1Z-4821-L	765	29.5	48	21	17.21	76.98
T-WS1Z-5421-L	803	29.5	54	21	19.36	86.42
T-WS1Z-6021-L	846	29.5	60	21	21.51	95.86
T-WS1Z-2421-R	694	29.5	24	21	8.6	41.4
T-WS1Z-3021-R	703	29.5	30	21	10.76	48.66
T-WS1Z-3621-R	713	29.5	36	21	12.91	58.1
T-WS1Z-4221-R	726	29.5	42	21	15.06	67.54
T-WS1Z-4821-R	765	29.5	48	21	17.21	76.98
T-WS1Z-5421-R	803	29.5	54	21	19.36	86.42
T-WS1Z-6021-R	846	29.5	60	21	21.51	95.86
T-WS1Z-2424-L	703	29.5	24	24	9.83	46.35
T-WS1Z-3024-L	713	29.5	30	24	12.29	55.62
T-WS1Z-3624-L	726	29.5	36	24	14.75	64.89
T-WS1Z-4224-L	745	29.5	42	24	17.21	74.16
T-WS1Z-4824-L	784	29.5	48	24	19.67	83.43
T-WS1Z-5424-L	823	29.5	54	24	22.13	92.7
T-WS1Z-6024-L	866	29.5	60	24	24.58	101.97
T-WS1Z-2424-R	703	29.5	24	24	9.83	46.35
T-WS1Z-3024-R	713	29.5	30	24	12.29	55.62
T-WS1Z-3624-R	726	29.5	36	24	14.75	64.89
T-WS1Z-4224-R	745	29.5	42	24	17.21	74.16
T-WS1Z-4824-R	784	29.5	48	24	19.67	83.43
T-WS1Z-5424-R	823	29.5	54	24	22.13	92.7
T-WS1Z-6024-R	866	29.5	60	24	24.58	101.97
T-WS1Z-2430-L	765	29.5	24	30	12.29	58.5
T-WS1Z-3030-L	784	29.5	30	30	15.36	69.5
T-WS1Z-3630-L	813	29.5	36	30	18.44	80.5
T-WS1Z-4230-L	846	29.5	42	30	21.51	91.5
T-WS1Z-4830-L	873	29.5	48	30	24.58	102.5
T-WS1Z-5430-L	903	29.5	54	30	27.66	113.5
T-WS1Z-6030-L	954	29.5	60	30	30.73	124.5
T-WS1Z-2430-R	765	29.5	24	30	12.29	58.5
T-WS1Z-3030-R	784	29.5	30	30	15.36	69.5
T-WS1Z-3630-R	813	29.5	36	30	18.44	80.5
T-WS1Z-4230-R	846	29.5	42	30	21.51	91.5
T-WS1Z-4830-R	873	29.5	48	30	24.58	102.5
T-WS1Z-5430-R	903	29.5	54	30	27.66	113.5
T-WS1Z-6030-R	954	29.5	60	30	30.73	124.5

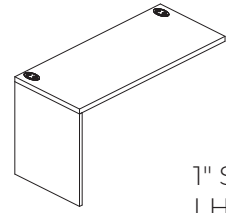

1" Straight Return w/partial Modesty, LH Shown

How to Specify:

Each laminate comes with matching vinyl trim color unless otherwise specified on your purchase order. Refer to the laminate finish card for details.

Notes:

Partial modesties are 12"H
 1 grommet for width 48" or less
 2 grommets for width 54" and wider

Options:

laminate color

grommet color

Code	Price	H	W	D	Volume (ft ³)	Weight (lb)
TL-WS1Z-2421-L	569	29	24	21	8.46	35.1
TL-WS1Z-3021-L	578	29	30	21	10.57	42.5
TL-WS1Z-3621-L	590	29	36	21	12.69	49.9
TL-WS1Z-4221-L	597	29	42	21	14.8	57.3
TL-WS1Z-4821-L	638	29	48	21	16.92	64.7
TL-WS1Z-5421-L	678	29	54	21	19.03	72.1
TL-WS1Z-6021-L	716	29	60	21	21.15	79.5
TL-WS1Z-2421-R	569	29	24	21	8.46	35.1
TL-WS1Z-3021-R	578	29	30	21	10.57	42.5
TL-WS1Z-3621-R	590	29	36	21	12.69	49.9
TL-WS1Z-4221-R	597	29	42	21	14.8	57.3
TL-WS1Z-4821-R	638	29	48	21	16.92	64.7
TL-WS1Z-5421-R	678	29	54	21	19.03	72.1
TL-WS1Z-6021-R	716	29	60	21	21.15	79.5
TL-WS1Z-2424-L	578	29	24	24	9.67	36.9
TL-WS1Z-3024-L	590	29	30	24	12.08	44.7
TL-WS1Z-3624-L	597	29	36	24	14.5	52.5
TL-WS1Z-4224-L	618	29	42	24	16.92	60.3
TL-WS1Z-4824-L	657	29	48	24	19.33	68.1
TL-WS1Z-5424-L	699	29	54	24	21.75	75.9
TL-WS1Z-6024-L	739	29	60	24	24.17	83.7
TL-WS1Z-2424-R	578	29	24	24	9.67	36.9
TL-WS1Z-3024-R	590	29	30	24	12.08	44.7
TL-WS1Z-3624-R	597	29	36	24	14.5	52.5
TL-WS1Z-4224-R	618	29	42	24	16.92	60.3
TL-WS1Z-4824-R	657	29	48	24	19.33	68.1
TL-WS1Z-5424-R	699	29	54	24	21.75	75.9
TL-WS1Z-6024-R	739	29	60	24	24.17	83.7
TL-WS1Z-2430-L	638	29	24	30	12.08	49.35
TL-WS1Z-3030-L	657	29	30	30	15.1	58.38
TL-WS1Z-3630-L	689	29	36	30	18.13	67.41
TL-WS1Z-4230-L	716	29	42	30	21.15	76.44
TL-WS1Z-4830-L	748	29	48	30	24.17	85.47
TL-WS1Z-5430-L	781	29	54	30	27.19	94.5
TL-WS1Z-6030-L	831	29	60	30	30.21	103.53
TL-WS1Z-2430-R	638	29	24	30	12.08	49.35
TL-WS1Z-3030-R	657	29	30	30	15.1	58.38
TL-WS1Z-3630-R	689	29	36	30	18.13	67.41
TL-WS1Z-4230-R	716	29	42	30	21.15	76.44
TL-WS1Z-4830-R	748	29	48	30	24.17	85.47
TL-WS1Z-5430-R	781	29	54	30	27.19	94.5
TL-WS1Z-6030-R	831	29	60	30	30.21	103.53



Metro Pricebook
February 2023
Credenzas

credenzas

Executive

<u>double lateral file</u>	102
<u>double storage cabinet</u>	104
<u>lateral file and storage cabinet</u>	106
<u>lateral file and storage cabinet</u>	108
<u>tops</u>	110

Professional

<u>double lateral file</u>	103
<u>double storage cabinet</u>	105
<u>lateral file and storage cabinet</u>	107
<u>lateral file and storage cabinet</u>	109
<u>tops</u>	111
<u>open w door</u>	112

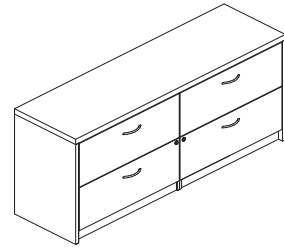

1.5" Credenza w/Double Lateral Files

How to Specify:

Each laminate comes with matching vinyl trim color unless otherwise specified on your purchase order. Refer to the laminate finish card for details.

Notes:

Options:

laminate color

edge profile

handle color

handle style

Code	Price	H	W	D	Volume (ft ³)	Weight (lb)
T-CRLL-7221	2500	29.5	72	21	25.81	232.65
T-CRLL-7224	2654	29.5	72	24	29.5	250.64

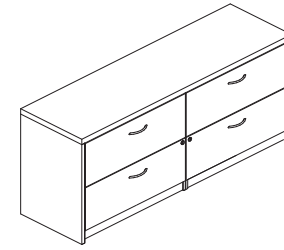

1" Credenza w/Double Lateral Files

How to Specify:

Each laminate comes with matching vinyl trim color unless otherwise specified on your purchase order. Refer to the laminate finish card for details.

Notes:

Options:

laminate color

handle color

handle style

Code	Price	H	W	D	Volume (ft ³)	Weight (lb)
TL-CRLL-7221	2360	29	72	21	25.38	205.87
TL-CRLL-7224	2501	29	72	24	29	220

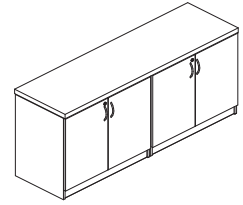

1.5" Credenza w/Double Storage Cabinets

How to Specify:

Each laminate comes with matching vinyl trim color unless otherwise specified on your purchase order. Refer to the laminate finish card for details.

Notes:

Cabinets and laterals include locks and keys.

Options:

laminate color

edge profile

handle color

handle style

Code	Price	H	W	D	Volume (ft ³)	Weight (lb)
T-CRSS-7221	1951	29.5	72	21	25.81	267
T-CRSS-7224	2085	29.5	72	24	29.5	272

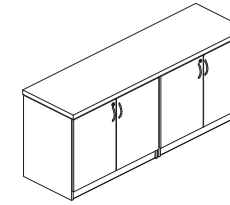

1" Credenza w/Double Storage Cabinets

How to Specify:

Each laminate comes with matching vinyl trim color unless otherwise specified on your purchase order. Refer to the laminate finish card for details.

Notes:

Cabinets and laterals include locks and keys.

Options:

laminate color

handle color

handle style

Code	Price	H	W	D	Volume (ft ³)	Weight (lb)
TL-CRSS-7221	1841	29	72	21	25.38	225.45
TL-CRSS-7224	1968	29	72	24	29	236.26

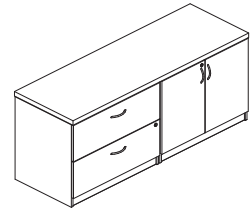

1.5" Credenza w/Lateral File on Left-Hand Side, Storage Cabinet on Right-Hand Side

How to Specify:

Each laminate comes with matching vinyl trim color unless otherwise specified on your purchase order. Refer to the laminate finish card for details.

Notes:

Cabinets and laterals include locks and keys.

Options:

laminate color

edge profile

handle color

handle style

Code	Price	H	W	D	Volume (ft ³)	Weight (lb)
T-CRLS-7221	2254	29.5	72	21	25.81	229.05
T-CRLS-7224	2443	29.5	72	24	29.5	247.04

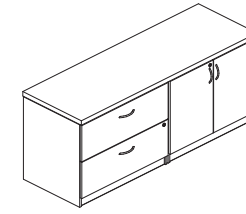

1" Credenza w/Lateral File on Left-Hand Side, Storage Cabinet on Right-Hand Side

How to Specify:

Each laminate comes with matching vinyl trim color unless otherwise specified on your purchase order. Refer to the laminate finish card for details.

Notes:

Cabinets and laterals include locks and keys.

Options:

laminate color

handle color

handle style

Code	Price	H	W	D	Volume (ft ³)	Weight (lb)
TL-CRLS-7221	2129	29	72	21	25.38	211.03
TL-CRLS-7224	2302	29	72	24	29	222.74

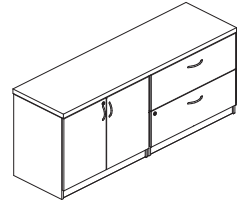

1.5" Credenza w/Storage Cabinet on Left-Hand Side, Lateral File on Right-Hand Side

How to Specify:

Each laminate comes with matching vinyl trim color unless otherwise specified on your purchase order. Refer to the laminate finish card for details.

Notes:

Cabinets and laterals include locks and keys.

Options:

laminate color

edge profile

handle color

handle style

Code	Price	H	W	D	Volume (ft ³)	Weight (lb)
T-CRSL-7221	2254	29.5	72	21	25.81	229.05
T-CRSL-7224	2443	29.5	72	24	29.5	247.04

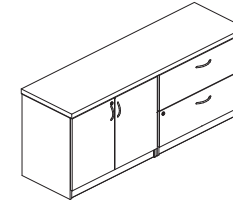

1" Credenza w/Storage Cabinet on Left-Hand Side, Lateral File on Right-Hand Side

How to Specify:

Each laminate comes with matching vinyl trim color unless otherwise specified on your purchase order. Refer to the laminate finish card for details.

Notes:

Cabinets and laterals include locks and keys.

Options:

laminate color

handle color

handle style

Code	Price	H	W	D	Volume (ft ³)	Weight (lb)
TL-CRSL-7221	2129	29	72	21	25.38	211.03
TL-CRSL-7224	2302	29	72	24	29	222.74

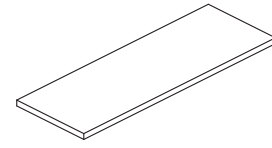

1.5" Credenza Top

How to Specify:

Each laminate comes with matching vinyl trim color unless otherwise specified on your purchase order. Refer to the laminate finish card for details.

Notes:

Options:

laminate color

edge profile

handle color

handle style

Code	Price	H	W	D	Volume (ft ³)	Weight (lb)
T-WSS0-6021	403	1.5	60	21	1.09	49.21
T-WSS0-6621	443	1.5	66	21	1.2	54.14
T-WSS0-7221	464	1.5	72	21	1.31	59.07
T-WSS0-7821	503	1.5	78	21	1.42	64
T-WSS0-8421	542	1.5	84	21	1.53	68.93

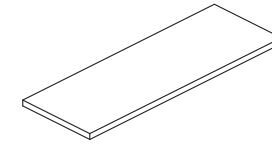

1" Credenza Top

How to Specify:

Each laminate comes with matching vinyl trim color unless otherwise specified on your purchase order. Refer to the laminate finish card for details.

Notes:

Options:

laminate color

handle color

handle style

Code	Price	H	W	D	Volume (ft ³)	Weight (lb)
TL-WSS0-6021	360	1	60	21	0.73	32.81
TL-WSS0-6621	395	1	66	21	0.8	36.09
TL-WSS0-7221	414	1	72	21	0.88	39.37
TL-WSS0-7821	448	1	78	21	0.95	42.65
TL-WSS0-8421	483	1	84	21	1.02	45.93

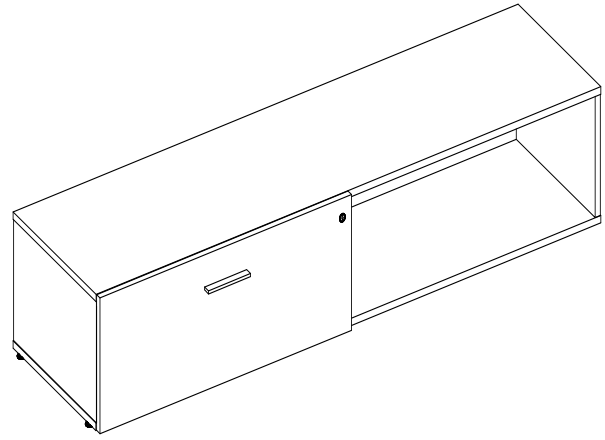

How to Specify:

Each laminate comes with matching vinyl trim color unless otherwise specified on your purchase order. Refer to the laminate finish card for details.

Notes:

Cabinets and laterals include locks and keys.

Options:

laminate color

edge profile

handle color

handle style

Code	Price	H	W	D	Volume (ft ³)	Weight (lb)
U-CRCL-157218-L	1863	14.19	72	19.13	93.91	11.31
U-CRCL-157218-R	1863	14.19	72	19.13	93.91	11.31



Metro Pricebook
February 2023
Supports

supports

Executive & Professional

<u>intermediate support</u>	116
<u>cantilever</u>	117
<u>reinforcement bar</u>	118



Intermediate Gable Support

How to Specify:

Each laminate comes with matching vinyl trim color unless otherwise specified on your purchase order. Refer to the laminate finish card for details.

Notes:

Options:

- laminate color
- grommet color

Code	Price	H	W	D	Volume (ft ³)	Weight (lb)
T-CGU0-12	190	28	12	1	0.19	8.75
T-CGU0-18	202	28	18	1	0.29	13.12

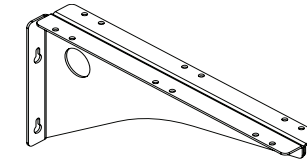

Center Cantilever Support

How to Specify:

Cantilevers are used to join 2 desks w/full modesty. Intermediate gable is required instead of cantilever when hatch sits on top of a desk.

Notes:

Options:

- cantilever available in black only

Code	Price	H	W	D	Volume (ft ³)	Weight (lb)
K-CCAB-16	99	0	16	0	3	0.1
K-CCAB-22	107	0	22	0	3	0.1

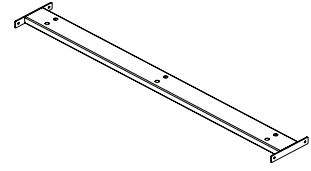

Reinforcement Bar

How to Specify:

Options:

metal support color

Code	Price	H	W	D	Volume (ft ³)	Weight (lb)
U-HRB0-27	180	1	27	6	0.2	2.5
U-HRB0-30	185	1	30	6	0.24	2.25
U-HRB0-33	190	1	33	6	0.28	2.5
U-HRB0-36	195	1	36	6	0.32	2.75
U-HRB0-39	198	1	39	6	0.36	3
U-HRB0-42	202	1	42	6	0.4	3.25
U-HRB0-45	206	1	45	6	0.44	3.5
U-HRB0-48	209	1	48	6	0.48	3.75
U-HRB0-51	218	1	51	6	0.52	4
U-HRB0-54	221	1	54	6	0.56	4.25
U-HRB0-57	227	1	57	6	0.6	4.5
U-HRB0-60	230	1	60	6	0.64	4.75
U-HRB0-63	234	1	63	6	0.68	5
U-HRB0-66	251	1	66	6	0.72	5.25
U-HRB0-69	256	1	69	6	0.76	5.5
U-HRB0-72	274	1	72	6	0.8	5.75
U-HRB0-75	283	1	75	6	0.84	6
U-HRB0-78	294	1	78	6	0.88	6.25
U-HRB0-81	307	1	81	6	0.92	6.5
U-HRB0-84	321	1	84	6	0.96	6.75
U-HRB0-87	334	1	87	6	1	7
U-HRB0-90	347	1	90	6	1.04	7.25



Metro Pricebook
February 2023

Filing & Storage

filing and storage

Executive & Professional

pedestals	122
pedestals w/ seat cushion	124
underdesk storage cabinet	125
underdesk combo pedestal BBF & FF	126
underdesk 2-drawer lateral file	127

Executive

freestanding storage cabinet	128
freestanding combo pedestal BBF & FF	130
freestanding 2-drawer lateral file	132
freestanding 3-drawer lateral file	134
freestanding 4-drawer lateral file	136
freestanding storage tower	138
freestanding combo storage tower BBF	140
freestanding combo storage tower FF	142
freestanding wardrobe storage tower	144
freestanding storage tower double door	146
freestanding combo lateral storage double door	148
freestanding combo lateral storage glazed double door	150
bookcase	152

Professional

freestanding storage cabinet	129
freestanding combo pedestal BBF & FF	131
freestanding 2-drawer lateral file	133
freestanding 3-drawer lateral file	135
freestanding 4-drawer lateral file	137
freestanding storage tower	139
freestanding combo storage tower BBF	141
freestanding combo storage tower FF	143
freestanding wardrobe storage tower	145
freestanding storage tower double door	147
freestanding combo lateral storage double door	149
freestanding combo lateral storage glazed double door	151
bookcase	154



Underdesk
Box/Box/File
Pedestal



Underdesk
File/File
Pedestal

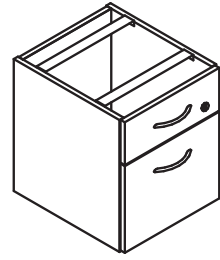

Suspended
Box/File
Pedestal

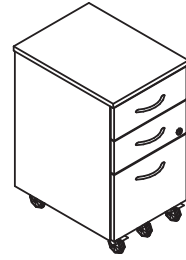

Mobile
Box/Box/File
Pedestal



Mobile
File/File
Pedestal

How to Specify:

Each laminate comes with matching vinyl trim color unless otherwise specified on your purchase order. Refer to the laminate finish card for details.

Notes:

Pedestals include lock and keys.

Options:

laminate color

handle color

handle style

back full back

Code	Price	H	W	D	Volume (ft ³)	Weight (lb)
Underdesk Box/Box/File Pedestal						
T-FPBU-1618	871	28	16	18	4.67	55
T-FPBU-1624	931	28	16	24	6.22	55
T-FPBU-1618-X	954	28	16	18	4.67	55
T-FPBU-1624-X	1080	28	16	24	6.22	55
Underdesk File/File Pedestal						
T-FPFU-1618	871	28	16	18	4.67	55
T-FPFU-1624	931	28	16	24	6.22	55
T-FPFU-1618-X	954	28	16	18	4.67	55
T-FPFU-1624-X	1080	28	16	24	6.22	55
Suspended Box/File Pedestal						
T-FPSU-1618	618	16	16	18	2.67	44
Mobile Box/Box/File Pedestal						
T-FPBM-1621	1144	28	16	21	5.44	74
Mobile File/File Pedestal						
T-FPFM-1621	1144	28	16	21	5.44	68

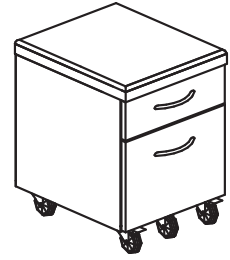

Mobile Box/File Pedestal w/
Upholstered Seat Cushion

How to Specify:

Each laminate comes with matching vinyl trim color unless otherwise specified on your purchase order. Refer to the laminate finish card for details.

Notes:

Pedestals include lock and keys.

Options:

- laminate color

- handle color

- handle style

- fabric color (for upholstered seat cushion, refer to seating fabric cards)

CODE	PRICE	H	W	D	VOLUME (FT ³)	WEIGHT (LB)
Mobile Box/File Pedestal w/Upholstered Seat Cushion						
T-1030-1618	1396	21	23	16	6.88	55

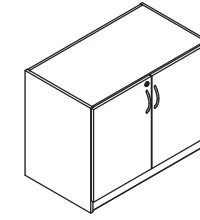

Underdesk Storage
Cabinet

How to Specify:

Each laminate comes with matching vinyl trim color unless otherwise specified on your purchase order. Refer to the laminate finish card for details.

Notes:

Cabinets and lateral files include lock and keys.

Options:

- laminate color

- handle color

- handle style

Code	Price	H	W	D	Volume (ft ³)	Weight (lb)
T-FSU0-3020	1068	28	30	20	9.72	88
T-FSU0-3620	1157	28	36	20	11.67	102
T-FSU0-4220	1244	28	42	20	13.61	117
T-FSU0-3021	1068	28	30	21	10.21	92
T-FSU0-3621	1157	28	36	21	12.25	107
T-FSU0-4221	1244	28	42	21	14.29	122

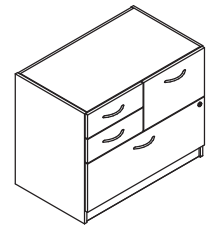

Underdesk Combo Pedestal
w/Box/Box/File and File/File,
LH Shown

How to Specify:

Each laminate comes with matching vinyl trim color unless otherwise specified on your purchase order. Refer to the laminate finish card for details.

Notes:

Cabinets and lateral files include lock and keys.

Options:

laminate color

handle color

handle style

Code	Price	H	W	D	Volume (ft ³)	Weight (lb)
T-FPJU-3620-L	1684	28	36	20	11.67	121
T-FPJU-3621-L	1684	28	36	21	12.25	122
T-FPJU-3620-R	1684	28	36	20	11.67	121
T-FPJU-3621-R	1684	28	36	21	12.25	122

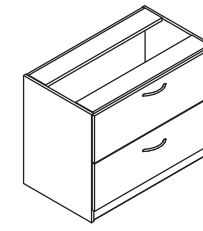

Underdesk 2-Drawer
Lateral File

How to Specify:

Each laminate comes with matching vinyl trim color unless otherwise specified on your purchase order. Refer to the laminate finish card for details.

Notes:

Cabinets and lateral files include lock and keys.

Options:

laminate color

handle color

handle style

Code	Price	H	W	D	Volume (ft ³)	Weight (lb)
T-FL2U-3020	1377	28	30	20	9.72	82.06
T-FL2U-3620	1427	28	36	20	11.67	86.64
T-FL2U-4220	1507	28	42	20	13.61	89.35
T-FL2U-3021	1377	28	30	21	10.21	84.6
T-FL2U-3621	1427	28	36	21	12.25	88.02
T-FL2U-4221	1507	28	42	21	14.29	91.44

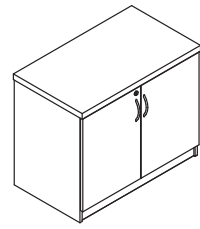

1.5" Freestanding Storage Cabinet

How to Specify:

Each laminate comes with matching vinyl trim color unless otherwise specified on your purchase order. Refer to the laminate finish card for details.

Notes:

Cabinets and lateral files include lock and keys.

Options:

laminate color

edge profile (for freestanding cabinet)

handle color

handle style

Code	Price	H	W	D	Volume (ft ³)	Weight (lb)
T-FSF0-3021	1175	29.5	30	21	10.76	98
T-FSF0-3621	1260	29.5	36	21	12.91	111
T-FSF0-4221	1346	29.5	42	21	15.06	124

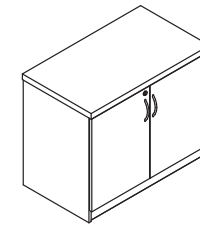

1" Freestanding Storage Cabinet

How to Specify:

Each laminate comes with matching vinyl trim color unless otherwise specified on your purchase order. Refer to the laminate finish card for details.

Notes:

Cabinets and lateral files include lock and keys.

Options:

laminate color

edge profile (for freestanding cabinet)

handle color

handle style

Code	Price	H	W	D	Volume (ft ³)	Weight (lb)
TL-FSF0-3021	1123	29	30	21	10.57	88
TL-FSF0-3621	1210	29	36	21	12.69	97
TL-FSF0-4221	1296	29	42	21	14.8	106

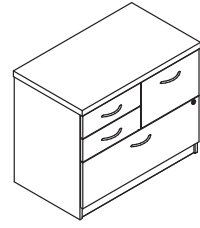

1.5" Freestanding Combo Pedestal w/Box/Box/File and File/File, LH Shown

How to Specify:

Each laminate comes with matching vinyl trim color unless otherwise specified on your purchase order. Refer to the laminate finish card for details.

Notes:

Cabinets and lateral files include lock and keys.

Options:

laminate color

edge profile (for freestanding cabinet)

handle color

handle style

Code	Price	H	W	D	Volume (ft ³)	Weight (lb)
T-FPJF-3621-L	1763	29.5	36	21	12.91	130
T-FPJF-3621-R	1763	29.5	36	21	12.91	130

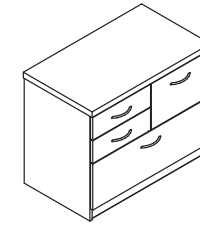

1" Freestanding Combo Pedestal w/Box/Box/File and File/File, LH Shown

How to Specify:

Each laminate comes with matching vinyl trim color unless otherwise specified on your purchase order. Refer to the laminate finish card for details.

Notes:

Cabinets and lateral files include lock and keys.

Options:

laminate color

handle color

handle style

Code	Price	H	W	D	Volume (ft ³)	Weight (lb)
TL-FPJF-3621-L	1726	29	36	21	12.69	130
TL-FPJF-3621-R	1726	29	36	21	12.69	130

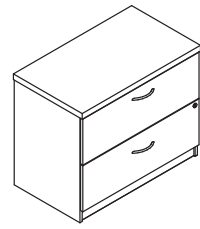

1.5" Freestanding 2-Drawer Lateral File

How to Specify:

Each laminate comes with matching vinyl trim color unless otherwise specified on your purchase order. Refer to the laminate finish card for details.

Notes:

Cabinets and lateral files include lock and keys.

Options:

- laminate color

- edge profile (for freestanding cabinet)

- handle color

- handle style

Code	Price	H	W	D	Volume (ft ³)	Weight (lb)
T-FL2F-3021	1471	29.5	30	21	10.76	108.9
T-FL2F-3621	1519	29.5	36	21	12.91	117.27
T-FL2F-4221	1592	29.5	42	21	15.06	125.64

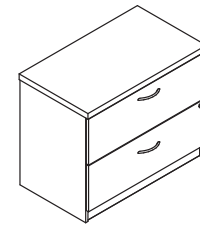

1" Freestanding 2-Drawer Lateral File

How to Specify:

Each laminate comes with matching vinyl trim color unless otherwise specified on your purchase order. Refer to the laminate finish card for details.

Notes:

Cabinets and lateral files include lock and keys.

Options:

- laminate color

- handle color

- handle style

Code	Price	H	W	D	Volume (ft ³)	Weight (lb)
TL-FL2F-3021	1425	29	30	21	10.57	92.7
TL-FL2F-3621	1472	29	36	21	12.69	107.1
TL-FL2F-4221	1550	29	42	21	14.8	121.5

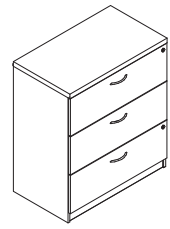

1.5" Freestanding 3-Drawer Lateral File

How to Specify:

Each laminate comes with matching vinyl trim color unless otherwise specified on your purchase order. Refer to the laminate finish card for details.

Notes:

Cabinets and lateral files include lock and keys.

Options:

laminate color

edge profile (for freestanding cabinet)

handle color

handle style

Code	Price	H	W	D	Volume (ft ³)	Weight (lb)
T-FL3F-3021	1828	40.5	30	21	14.77	145
T-FL3F-3621	1907	40.5	36	21	17.72	154.96

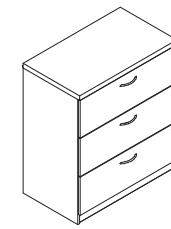

1" Freestanding 3-Drawer Lateral File

How to Specify:

Each laminate comes with matching vinyl trim color unless otherwise specified on your purchase order. Refer to the laminate finish card for details.

Notes:

Cabinets and lateral files include lock and keys.

Options:

laminate color

handle color

handle style

Code	Price	H	W	D	Volume (ft ³)	Weight (lb)
TL-FL3F-3021	1606	40	30	21	14.58	136.5
TL-FL3F-3621	1684	40	36	21	17.5	144.25

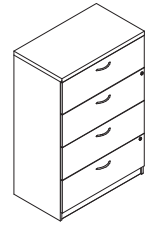

1.5" Freestanding 4-Drawer Lateral File

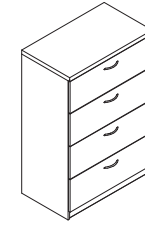

1" Freestanding 4-Drawer Lateral File

How to Specify:

Notes:

Each laminate comes with matching vinyl trim color unless otherwise specified on your purchase order. Refer to the laminate finish card for details.

Cabinets and lateral files include lock and keys.

Options:

laminate color

edge profile (for freestanding cabinet)

handle color

handle style

How to Specify:

Notes:

Each laminate comes with matching vinyl trim color unless otherwise specified on your purchase order. Refer to the laminate finish card for details.

Cabinets and lateral files include lock and keys.

Options:

laminate color

handle color

handle style

Code	Price	H	W	D	Volume (ft ³)	Weight (lb)
T-FL4F-3021	2393	52.5	30	21	19.14	171.3
T-FL4F-3621	2471	52.5	36	21	22.97	183.24

Code	Price	H	W	D	Volume (ft ³)	Weight (lb)
TL-FL4F-3021	2168	52	30	21	18.96	153.1
TL-FL4F-3621	2247	52	36	21	22.75	162.98

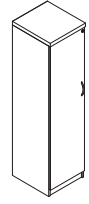

1.5" Storage Cabinet w/Shelves,
LH Shown

How to Specify:

Each laminate comes with matching vinyl trim color unless otherwise specified on your purchase order. Refer to the laminate finish card for details.

Notes:

Cabinets and lateral files include lock and keys.

Options:

laminate color

edge profile

handle color

handle style

Code	Price	H	W	D	Volume (ft ³)	Weight (lb)
T-FSDS-1821-L	1304	68	18	21	14.88	133.65
T-FSDS-1821-R	1304	68	18	21	14.88	133.65

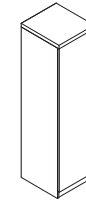

1" Storage Cabinet w/Shelves,
LH Shown

How to Specify:

Each laminate comes with matching vinyl trim color unless otherwise specified on your purchase order. Refer to the laminate finish card for details.

Notes:

Cabinets and lateral files include lock and keys.

Options:

laminate color

handle color

handle style

Code	Price	H	W	D	Volume (ft ³)	Weight (lb)
TL-FSDS-1821-L	1251	67	18	21	14.66	128.7
TL-FSDS-1821-R	1251	67	18	21	14.66	128.7

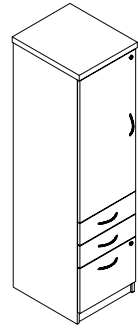

1.5" Combo Cabinet w/Storage and Box/Box/File,

How to Specify:

Each laminate comes with matching vinyl trim color unless otherwise specified on your purchase order. Refer to the laminate finish card for details.

Notes:

Cabinets and lateral files include lock and keys.

Options:

laminate color

edge profile

handle color

handle style

Code	Price	H	W	D	Volume (ft ³)	Weight (lb)
T-FCSB-1821-L	2048	68	18	21	14.88	168
T-FCSB-1821-R	2048	68	18	21	14.88	168

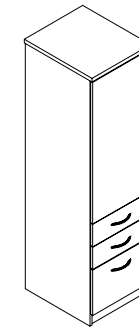

1" Combo Cabinet w/Storage and Box/Box/File,

How to Specify:

Each laminate comes with matching vinyl trim color unless otherwise specified on your purchase order. Refer to the laminate finish card for details.

Notes:

Cabinets and lateral files include lock and keys.

Options:

laminate color

handle color

handle style

Code	Price	H	W	D	Volume (ft ³)	Weight (lb)
TL-FCSB-1821-L	1826	67	18	21	14.66	163
TL-FCSB-1821-R	1826	67	18	21	14.66	163



1.5" Combo Cabinet w/Storage and File/File, LH Shown

How to Specify:

Each laminate comes with matching vinyl trim color unless otherwise specified on your purchase order. Refer to the laminate finish card for details.

Notes:

Cabinets and lateral files include lock and keys.

Options:

laminate color

edge profile

handle color

handle style

Code	Price	H	W	D	Volume (ft ³)	Weight (lb)
T-FCSF-1821-L	2048	68	18	21	14.88	162
T-FCSF-1821-R	2048	68	18	21	14.88	162



1" Combo Cabinet w/Storage and File/File, LH Shown

How to Specify:

Each laminate comes with matching vinyl trim color unless otherwise specified on your purchase order. Refer to the laminate finish card for details.

Notes:

Cabinets and lateral files include lock and keys.

Options:

laminate color

handle color

handle style

Code	Price	H	W	D	Volume (ft ³)	Weight (lb)
TL-FCSF-1821-L	1826	67	18	21	14.66	129
TL-FCSF-1821-R	1826	67	18	21	14.66	129

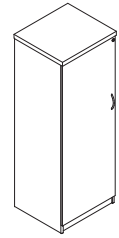

1.5" Storage Cabinet w/Coat Bar and Shelves,

How to Specify:

Each laminate comes with matching vinyl trim color unless otherwise specified on your purchase order. Refer to the laminate finish card for details.

Notes:

Cabinets and lateral files include lock and keys.

Options:

laminate color

edge profile

handle color

handle style

Code	Price	H	W	D	Volume (ft ³)	Weight (lb)
T-FSDC-2421-L	1406	68	24	21	19.83	179.64
T-FSDC-2421-R	1406	68	24	21	19.83	179.64

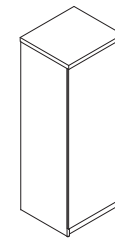

1" Storage Cabinet w/Coat Bar and Shelves,

How to Specify:

Each laminate comes with matching vinyl trim color unless otherwise specified on your purchase order. Refer to the laminate finish card for details.

Notes:

Cabinets and lateral files include lock and keys.

Options:

laminate color

handle color

handle style

Code	Price	H	W	D	Volume (ft ³)	Weight (lb)
TL-FSDC-2421-L	1353	67	24	21	19.54	169.95
TL-FSDC-2421-R	1353	67	24	21	19.54	169.95

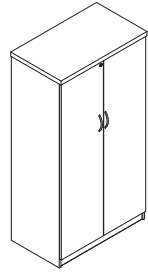

1.5" Double Door Storage Cabinet w/Shelves

How to Specify:

Each laminate comes with matching vinyl trim color unless otherwise specified on your purchase order. Refer to the laminate finish card for details.

Notes:

Cabinets and lateral files include lock and keys.

Options:

laminate color

edge profile

handle color

handle style

Code	Price	H	W	D	Volume (ft ³)	Weight (lb)
T-FSDS-3021	1979	68	30	21	25	196
T-FSDS-3621	2048	68	36	21	29.75	204.96

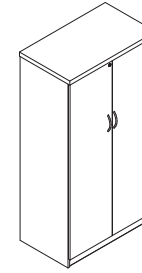

1" Double Door Storage Cabinet w/Shelves

How to Specify:

Each laminate comes with matching vinyl trim color unless otherwise specified on your purchase order. Refer to the laminate finish card for details.

Notes:

Cabinets and lateral files include lock and keys.

Options:

laminate color

handle color

handle style

Code	Price	H	W	D	Volume (ft ³)	Weight (lb)
TL-FSDS-3021	1836	67	30	21	24	180
TL-FSDS-3621	1906	67	36	21	29.31	195.39

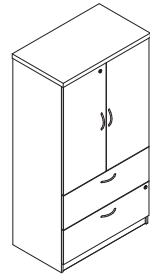

1.5" Combo Cabinet w/Storage and Lateral File

How to Specify:

Each laminate comes with matching vinyl trim color unless otherwise specified on your purchase order. Refer to the laminate finish card for details.

Notes:

Cabinets and lateral files include lock and keys.

Options:

- laminate color _____
- edge profile _____
- handle color _____
- handle style _____

Code	Price	H	W	D	Volume (ft ³)	Weight (lb)
T-FCSL-3621	2431	68	36	21	29.75	260.82

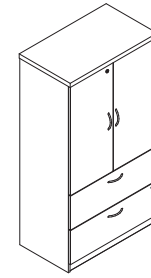

1" Combo Cabinet w/Storage and Lateral File

How to Specify:

Each laminate comes with matching vinyl trim color unless otherwise specified on your purchase order. Refer to the laminate finish card for details.

Notes:

Cabinets and lateral files include lock and keys.

Options:

- laminate color _____
- handle color _____
- handle style _____

Code	Price	H	W	D	Volume (ft ³)	Weight (lb)
TL-FCSL-3621	2209	67	36	21	29.31	251.25

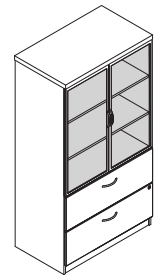

1.5" Combo Cabinet w/Storage, Lateral File

How to Specify:

Each laminate comes with matching vinyl trim color unless otherwise specified on your purchase order. Refer to the laminate finish card for details.

Notes:

Only laminate drawers include lock and keys.

Options:

- _____ laminate color
- _____ edge profile
- _____ metal color (for acrylic door frame)
- _____ handle color
- _____ handle style

Code	Price	H	W	D	Volume (ft ³)	Weight (lb)
T-FCSL-3621-G	3916	68	36	21	29.75	222.62

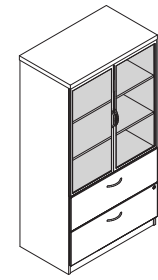

1" Combo Cabinet w/Storage, Lateral File

How to Specify:

Each laminate comes with matching vinyl trim color unless otherwise specified on your purchase order. Refer to the laminate finish card for details.

Notes:

Only laminate drawers include lock and keys.

Options:

- _____ laminate color
- _____ metal color (for acrylic door frame)
- _____ handle color
- _____ handle style

Code	Price	H	W	D	Volume (ft ³)	Weight (lb)
TL-FCSL-3621-G	3706	67	36	21	29.31	213.05

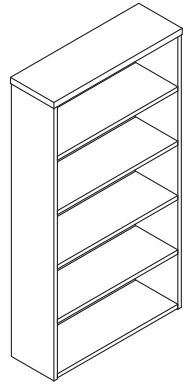

1.5" bookcase

How to Specify:

Each laminate comes with matching vinyl trim color unless otherwise specified on your purchase order. Refer to the laminate finish card for details.

Notes:

Book cases have adjustable shelves and one fixed shelf at desk height.

All bookcases come with a solid laminate back in matching color.

Number of shelves includes shelf on bottom of bookcase.

Options:

laminate color

Code	Price	H	W	D	Volume (ft ³)	Weight (lb)	# of Shelves
12" Deep							
T-SB0X-292412	631	29	24	12	4.8	51.61	2H
T-SB0X-293012	694	29	30	12	6	60.72	2H
T-SB0X-293612	755	29	36	12	7.3	69.83	2H
T-SB0X-294212	817	29	42	12	8.5	78.93	2H
T-SB0X-422412	789	42	24	12	7	70.73	3H
T-SB0X-423012	859	42	30	12	8.8	82.94	3H
T-SB0X-423612	934	42	36	12	10.5	95.14	3H
T-SB0X-424212	1008	42	42	12	12.3	107.35	3H
T-SB0X-542412	927	54	24	12	9	88.85	4H
T-SB0X-543012	1011	54	30	12	11.3	104.04	4H
T-SB0X-543612	1100	54	36	12	13.5	119.23	4H
T-SB0X-544212	1186	54	42	12	15.8	134.42	4H
T-SB0X-682412	1076	68	24	12	11.3	108.38	5H
T-SB0X-683012	1180	68	30	12	14.2	126.79	5H
T-SB0X-683612	1285	68	36	12	17	145.19	5H
T-SB0X-684212	1390	68	42	12	19.8	163.59	5H
T-SB0X-782412	1213	78	24	12	13	124.48	6H
T-SB0X-783012	1332	78	30	12	16.3	145.65	6H
T-SB0X-783612	1454	78	36	12	19.5	166.81	6H
T-SB0X-784212	1573	78	42	12	22.8	187.98	6H
15" Deep							
T-SB0X-292415	713	29	24	15	6	61.91	2H
T-SB0X-293015	782	29	30	15	7.6	72.59	2H
T-SB0X-293615	850	29	36	15	9.1	83.26	2H
T-SB0X-294215	921	29	42	15	10.6	93.94	2H
T-SB0X-422415	886	42	24	15	8.8	84.62	3H
T-SB0X-423015	969	42	30	15	10.9	98.84	3H
T-SB0X-423615	1052	42	36	15	13.1	113.06	3H
T-SB0X-424215	1134	42	42	15	15.3	127.28	3H
T-SB0X-542415	1041	54	24	15	11.3	106.17	4H
T-SB0X-543015	1136	54	30	15	14.1	123.82	4H
T-SB0X-543615	1239	54	36	15	16.9	141.48	4H
T-SB0X-544215	1334	54	42	15	19.7	159.13	4H
T-SB0X-682415	1210	68	24	15	14.2	129.29	5H
T-SB0X-683015	1327	68	30	15	17.7	150.6	5H
T-SB0X-683615	1447	68	36	15	21.3	171.91	5H
T-SB0X-684215	1564	68	42	15	24.8	193.23	5H
T-SB0X-782415	1365	78	24	15	16.3	149.27	6H
T-SB0X-783015	1498	78	30	15	20.3	173.79	6H
T-SB0X-783615	1635	78	36	15	24.4	198.32	6H
T-SB0X-784215	1770	78	42	15	28.4	222.84	6H

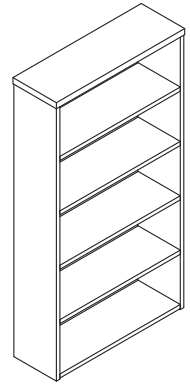

1" bookcase

12" or 15" Deep

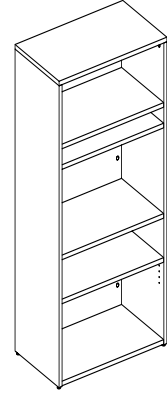

21" Deep

How to Specify:

Each laminate comes with matching vinyl trim color unless otherwise specified on your purchase order. Refer to the laminate finish card for details.

Notes:

Book cases have adjustable shelves and one fixed shelf at desk height.

All bookcases come with a solid laminate back in matching color.

Number of shelves includes shelf on bottom of bookcase.

Options:

laminate color

edge profile

Code	Price	H	W	D	Volume (ft ³)	Weight (lb)	# of Shelves
12" Deep							
TL-SB0X-292412	583	29	24	12	4.8	48.03	2H
TL-SB0X-293012	645	29	30	12	6	56.24	2H
TL-SB0X-293612	704	29	36	12	7.3	64.45	2H
TL-SB0X-294212	766	29	42	12	8.5	72.66	2H
TL-SB0X-422412	745	42	24	12	7	67.15	3H
TL-SB0X-423012	817	42	30	12	8.8	78.46	3H
TL-SB0X-423612	892	42	36	12	10.5	89.77	3H
TL-SB0X-424212	964	42	42	12	12.3	101.08	3H
TL-SB0X-542412	875	54	24	12	9	85.27	4H
TL-SB0X-543012	966	54	30	12	11.3	99.56	4H
TL-SB0X-543612	1056	54	36	12	13.5	113.86	4H
TL-SB0X-544212	1150	54	42	12	15.8	128.15	4H
TL-SB0X-672412	1024	67	24	12	11.2	104.8	5H
TL-SB0X-673012	1135	67	30	12	14	122.31	5H
TL-SB0X-673612	1246	67	36	12	16.8	139.81	5H
TL-SB0X-674212	1356	67	42	12	19.5	157.32	5H
TL-SB0X-772412	1162	77	24	12	12.8	120.9	6H
TL-SB0X-773012	1284	77	30	12	16	141.17	6H
TL-SB0X-773612	1407	77	36	12	19.3	161.44	6H
TL-SB0X-774212	1531	77	42	12	22.5	181.7	6H
15" Deep							
TL-SB0X-292415	655	29	24	15	6	57.43	2H
TL-SB0X-293015	726	29	30	15	7.6	66.99	2H
TL-SB0X-293615	794	29	36	15	9.1	76.54	2H
TL-SB0X-294215	864	29	42	15	10.6	86.1	2H
TL-SB0X-422415	836	42	24	15	8.8	80.14	3H
TL-SB0X-423015	921	42	30	15	10.9	93.24	3H
TL-SB0X-423615	1001	42	36	15	13.1	106.34	3H
TL-SB0X-424215	1084	42	42	15	15.3	119.44	3H
TL-SB0X-542415	983	54	24	15	11.3	101.69	4H
TL-SB0X-543015	1087	54	30	15	14.1	118.23	4H
TL-SB0X-543615	1190	54	36	15	16.9	134.76	4H
TL-SB0X-544215	1294	54	42	15	19.7	151.3	4H
TL-SB0X-672415	1152	67	24	15	14	124.81	5H
TL-SB0X-673015	1278	67	30	15	17.4	145	5H
TL-SB0X-673615	1403	67	36	15	20.9	165.19	5H
TL-SB0X-674215	1527	67	42	15	24.4	185.39	5H
TL-SB0X-772415	1306	77	24	15	16	144.04	6H
TL-SB0X-773015	1444	77	30	15	20.1	167.45	6H
TL-SB0X-773615	1584	77	36	15	24.1	190.85	6H
TL-SB0X-774215	1725	77	42	15	28.1	214.25	6H
21" Deep							
TL-SB0S-673621	2222	67.38	36	21	29.48	151.94	4H



Metro Pricebook
February 2023

Overhead Storage

overhead storage

Executive

<u>open hutch</u>	156
<u>hinged door hutch</u>	158
<u>glazed door hutch</u>	160
<u>open hutch w/ pidgeon holes</u>	162
<u>hinged door hutch w/ pidgeon holes</u>	164
<u>wall mounted hinged door hutch</u>	166
<u>wall mounted glazed door hutch</u>	168

Professional

<u>open hutch</u>	157
<u>hinged door hutch</u>	159
<u>glazed door hutch</u>	161
<u>open hutch w/ pidgeon holes</u>	163
<u>hinged door hutch w/ pidgeon holes</u>	165
<u>wall mounted hinged door hutch</u>	167
<u>wall mounted glazed door hutch</u>	169

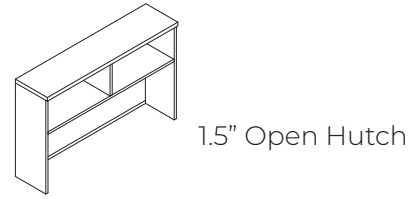

How to Specify:

Each laminate comes with matching vinyl trim color unless otherwise specified on your purchase order. Refer to the laminate finish card for details.

Notes:

Number of Openings and Doors per Hutch										
width(in)	30	36	42	48	54	60	66	72	78	84
openings	1	1	2	2	2	2	2	2	2	2

Options:

- laminate color

- edge profile

- metal color (for acrylic door frames)

- acrylic color (for doors)

Code	Price	H	W	D	Volume (ft ³)	Weight (lb)
T-SH00-1530	703	39	30	15	10.16	75.62
T-SH00-1536	813	39	36	15	12.19	84.86
T-SH00-1542	846	39	42	15	14.22	94.1
T-SH00-1548	934	39	48	15	16.25	103.34
T-SH00-1554	1014	39	54	15	18.28	112.58
T-SH00-1560	1097	39	60	15	20.31	121.82
T-SH00-1566	1166	39	66	15	22.34	131.06
T-SH00-1572	1255	39	72	15	24.38	140.3
T-SH00-1578	1328	39	78	15	26.41	149.54
T-SH00-1584	1406	39	84	15	28.44	158.78

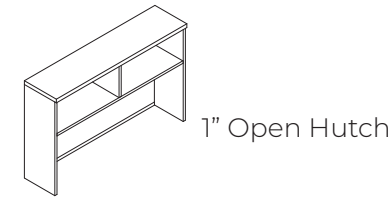

How to Specify:

Each laminate comes with matching vinyl trim color unless otherwise specified on your purchase order. Refer to the laminate finish card for details.

Notes:

Number of Openings and Doors per Hutch										
width(in)	30	36	42	48	54	60	66	72	78	84
openings	1	1	2	2	2	2	2	2	2	2

Options:

- laminate color

- metal color (for acrylic door frames)

- acrylic color (for doors)

Code	Price	H	W	D	Volume (ft ³)	Weight (lb)
TL-SH00-1530	578	38.5	30	15	16.08	69.79
TL-SH00-1536	689	38.5	36	15	18.91	79.03
TL-SH00-1542	716	38.5	42	15	21.75	88.27
TL-SH00-1548	810	38.5	48	15	24.59	97.51
TL-SH00-1554	890	38.5	54	15	27.42	106.75
TL-SH00-1560	971	38.5	60	15	30.26	115.99
TL-SH00-1566	1041	38.5	66	15	33.1	125.23
TL-SH00-1572	1133	38.5	72	15	35.93	134.47
TL-SH00-1578	1200	38.5	78	15	38.77	143.71
TL-SH00-1584	1282	38.5	84	15	41.61	152.95

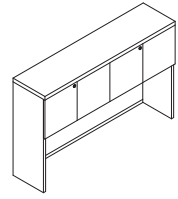

1.5" Hinged-Door Hutch

How to Specify:

Each laminate comes with matching vinyl trim color unless otherwise specified on your purchase order. Refer to the laminate finish card for details.

Notes:

Number of Openings and Doors per Hutch										
width(in)	30	36	42	48	54	60	66	72	78	84
openings	1	1	2	2	2	2	2	2	2	2
doors	2	2	3	3	3	4	4	4	4	4

Laminate doors include locks and keys.

Options:

laminate color

edge profile

Code	Price	H	W	D	Volume (ft ³)	Weight (lb)
T-SHH0-1530-L	1081	39	30	15	10.16	85.07
T-SHH0-1536-L	1142	39	36	15	12.19	94.31
T-SHH0-1542-L	1304	39	42	15	14.22	103.55
T-SHH0-1548-L	1417	39	48	15	16.25	117.51
T-SHH0-1554-L	1539	39	54	15	18.28	126.75
T-SHH0-1560-L	1640	39	60	15	20.31	140.72
T-SHH0-1566-L	1739	39	66	15	22.34	149.96
T-SHH0-1572-L	1828	39	72	15	24.38	159.2
T-SHH0-1578-L	1918	39	78	15	26.41	168.44
T-SHH0-1584-L	1989	39	84	15	28.44	177.68

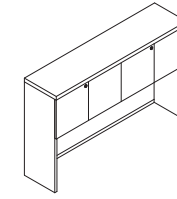

1" Hinged-Door Hutch

How to Specify:

Each laminate comes with matching vinyl trim color unless otherwise specified on your purchase order. Refer to the laminate finish card for details.

Notes:

Number of Openings and Doors per Hutch										
width(in)	30	36	42	48	54	60	66	72	78	84
openings	1	1	2	2	2	2	2	2	2	2
doors	2	2	3	3	3	4	4	4	4	4

Laminate doors include locks and keys.

Options:

laminate color

metal color (for acrylic door frames)

Code	Price	H	W	D	Volume (ft ³)	Weight (lb)
TL-SHH0-1530-L	968	38.5	30	15	16.08	79.24
TL-SHH0-1536-L	1020	38.5	36	15	18.91	88.48
TL-SHH0-1542-L	1166	38.5	42	15	21.75	102.44
TL-SHH0-1548-L	1263	38.5	48	15	24.59	111.68
TL-SHH0-1554-L	1375	38.5	54	15	27.42	120.92
TL-SHH0-1560-L	1461	38.5	60	15	30.26	134.89
TL-SHH0-1566-L	1551	38.5	66	15	33.1	144.13
TL-SHH0-1572-L	1631	38.5	72	15	35.93	153.37
TL-SHH0-1578-L	1714	38.5	78	15	38.77	162.61
TL-SHH0-1584-L	1777	38.5	84	15	41.61	171.85

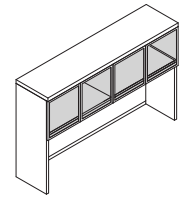

1.5" Hinged-Door Hutch w/Acrylic Doors

How to Specify:

Each laminate comes with matching vinyl trim color unless otherwise specified on your purchase order. Refer to the laminate finish card for details.

Notes:

Number of Openings and Doors per Hutch										
width(in)	30	36	42	48	54	60	66	72	78	84
openings	1	1	2	2	2	2	2	2	2	2
doors	2	2	3	3	3	4	4	4	4	4

Acrylic doors do not have locks

Options:

laminate color

edge profile

metal color (for acrylic door frames)

acrylic color (for doors)

Code	Price	H	W	D	Volume (ft ³)	Weight (lb)
T-SHH0-1530-G	1739	39	30	15	10.16	88.22
T-SHH0-1536-G	1877	39	36	15	12.19	96.56
T-SHH0-1542-G	2011	39	42	15	14.22	105.8
T-SHH0-1548-G	2493	39	48	15	16.25	122.24
T-SHH0-1554-G	2641	39	54	15	18.28	131.48
T-SHH0-1560-G	3105	39	60	15	20.31	147.92
T-SHH0-1566-G	3166	39	66	15	22.34	157.16
T-SHH0-1572-G	3307	39	72	15	24.38	166.4
T-SHH0-1578-G	3407	39	78	15	26.41	175.64
T-SHH0-1584-G	3496	39	84	15	28.44	184.88

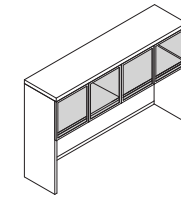

1" Hinged-Door Hutch w/Acrylic Doors

How to Specify:

Each laminate comes with matching vinyl trim color unless otherwise specified on your purchase order. Refer to the laminate finish card for details.

Notes:

Number of Openings and Doors per Hutch										
width(in)	30	36	42	48	54	60	66	72	78	84
openings	1	1	2	2	2	2	2	2	2	2
doors	2	2	3	3	3	4	4	4	4	4

Acrylic doors do not have locks and keys.

Options:

laminate color

metal color (for acrylic door frames)

acrylic color (for doors)

Code	Price	H	W	D	Volume (ft ³)	Weight (lb)
TL-SHH0-1530-G	1517	38.5	30	15	16.08	82.39
TL-SHH0-1536-G	1653	38.5	36	15	18.91	91.63
TL-SHH0-1542-G	1786	38.5	42	15	21.75	107.17
TL-SHH0-1548-G	2267	38.5	48	15	24.59	116.41
TL-SHH0-1554-G	2420	38.5	54	15	27.42	125.65
TL-SHH0-1560-G	2881	38.5	60	15	30.26	142.09
TL-SHH0-1566-G	2941	38.5	66	15	33.1	151.33
TL-SHH0-1572-G	3082	38.5	72	15	35.93	160.57
TL-SHH0-1578-G	3181	38.5	78	15	38.77	169.81
TL-SHH0-1584-G	3274	38.5	84	15	41.61	179.05

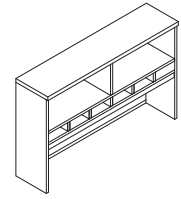

1.5" Open Hutch w/Pigeonholes

How to Specify:

Each laminate comes with matching vinyl trim color unless otherwise specified on your purchase order. Refer to the laminate finish card for details.

Notes:

Number of Openings and Doors per Hutch										
width(in)	30	36	42	48	54	60	66	72	78	84
openings	1	1	2	2	2	2	2	2	2	2
# of pigeon holes	3	3	4	4	5	6	6	7	8	8

Options:

laminate color

edge profile

Code	Price	H	W	D	Volume (ft ³)	Weight (lb)
T-SHOP-1530	982	39	30	15	10.16	87.77
T-SHOP-1536	1135	39	36	15	12.19	97.01
T-SHOP-1542	1175	39	42	15	14.22	111.69
T-SHOP-1548	1304	39	48	15	16.25	120.93
T-SHOP-1554	1417	39	54	15	18.28	135.58
T-SHOP-1560	1527	39	60	15	20.31	148.2
T-SHOP-1566	1629	39	66	15	22.34	157.44
T-SHOP-1572	1758	39	72	15	24.38	170.74
T-SHOP-1578	1848	39	78	15	26.41	183.36
T-SHOP-1584	1969	39	84	15	28.44	195.99

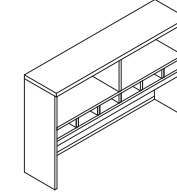

1" Open Hutch w/Pigeonholes

How to Specify:

Each laminate comes with matching vinyl trim color unless otherwise specified on your purchase order. Refer to the laminate finish card for details.

Notes:

Number of Openings and Doors per Hutch										
width(in)	30	36	42	48	54	60	66	72	78	84
openings	1	1	2	2	2	2	2	2	2	2
# of pigeon holes	3	3	4	4	5	6	6	7	8	8

Options:

laminate color

Code	Price	H	W	D	Volume (ft ³)	Weight (lb)
TL-SHOP-1530	760	38.5	30	15	16.08	81.94
TL-SHOP-1536	911	38.5	36	15	18.91	91.18
TL-SHOP-1542	952	38.5	42	15	21.75	105.86
TL-SHOP-1548	1080	38.5	48	15	24.59	115.1
TL-SHOP-1554	1194	38.5	54	15	27.42	129.75
TL-SHOP-1560	1302	38.5	60	15	30.26	142.37
TL-SHOP-1566	1405	38.5	66	15	33.1	151.61
TL-SHOP-1572	1538	38.5	72	15	35.93	164.91
TL-SHOP-1578	1625	38.5	78	15	38.77	177.53
TL-SHOP-1584	1747	38.5	84	15	41.61	190.16

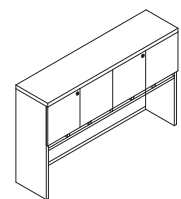

1.5" Hinged-Door Hutch w/Pigeonholes

How to Specify:

Each laminate comes with matching vinyl trim color unless otherwise specified on your purchase order. Refer to the laminate finish card for details.

Notes:

Number of Openings and Doors per Hutch										
width(in)	30	36	42	48	54	60	66	72	78	84
openings	1	1	2	2	2	2	2	2	2	2
# of pigeon holes	3	3	4	4	5	6	6	7	8	8

Options:

laminate color

edge profile

Code	Price	H	W	D	Volume (ft ³)	Weight (lb)
T-SHHP-1530-L	1335	39	30	15	10.16	97.22
T-SHHP-1536-L	1422	39	36	15	12.19	106.46
T-SHHP-1542-L	1609	39	42	15	14.22	121.14
T-SHHP-1548-L	1763	39	48	15	16.25	135.1
T-SHHP-1554-L	1915	39	54	15	18.28	149.75
T-SHHP-1560-L	2035	39	60	15	20.31	167.1
T-SHHP-1566-L	2102	39	66	15	22.34	176.34
T-SHHP-1572-L	2235	39	72	15	24.38	189.64
T-SHHP-1578-L	2332	39	78	15	26.41	202.26
T-SHHP-1584-L	2424	39	84	15	28.44	214.89

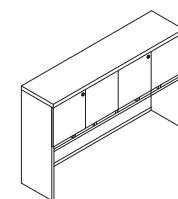

1" Hinged-Door Hutch w/Pigeonholes

How to Specify:

Each laminate comes with matching vinyl trim color unless otherwise specified on your purchase order. Refer to the laminate finish card for details.

Notes:

Number of Openings and Doors per Hutch										
width(in)	30	36	42	48	54	60	66	72	78	84
openings	1	1	2	2	2	2	2	2	2	2
# of pigeon holes	3	3	4	4	5	6	6	7	8	8

Options:

laminate color

metal color (for acrylic door frame)

Code	Price	H	W	D	Volume (ft ³)	Weight (lb)
TL-SHHP-1530-L	1113	38.5	30	15	16.08	91.39
TL-SHHP-1536-L	1198	38.5	36	15	18.91	100.63
TL-SHHP-1542-L	1389	38.5	42	15	21.75	120.03
TL-SHHP-1548-L	1543	38.5	48	15	24.59	129.27
TL-SHHP-1554-L	1692	38.5	54	15	27.42	143.92
TL-SHHP-1560-L	1816	38.5	60	15	30.26	161.27
TL-SHHP-1566-L	1879	38.5	66	15	33.1	170.51
TL-SHHP-1572-L	2016	38.5	72	15	35.93	183.81
TL-SHHP-1578-L	2109	38.5	78	15	38.77	196.43
TL-SHHP-1584-L	2201	38.5	84	15	41.61	209.06

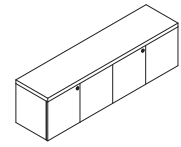

1.5" Wall-Mounted Hinged-Door Hutch

How to Specify:

Each laminate comes with matching vinyl trim color unless otherwise specified on your purchase order. Refer to the laminate finish card for details.

Notes:

Number of Openings and Doors per Hutch										
width(in)	30	36	42	48	54	60	66	72	78	84
openings	1	1	2	2	2	2	2	2	2	2
doors	2	2	3	3	3	4	4	4	4	4

Laminate doors include locks and keys.

Install wall-mounted overheads directly onto permanent studs. Please refer to installation instructions.

Options:

laminate color

edge profile

Code	Price	H	W	D	Volume (ft ³)	Weight (lb)
T-SHHW-1530-L	773	17	30	15	4.43	46.9
T-SHHW-1536-L	820	17	36	15	5.31	52.99
T-SHHW-1542-L	915	17	42	15	6.2	59.08
T-SHHW-1548-L	964	17	48	15	7.08	65.17
T-SHHW-1554-L	1009	17	54	15	7.97	71.26
T-SHHW-1560-L	1103	17	60	15	8.85	77.35
T-SHHW-1566-L	1150	17	66	15	9.74	83.44
T-SHHW-1572-L	1198	17	72	15	10.63	89.53

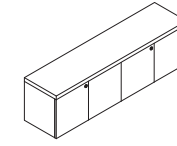

1" Wall-Mounted Hinged-Door Hutch

How to Specify:

Each laminate comes with matching vinyl trim color unless otherwise specified on your purchase order. Refer to the laminate finish card for details.

Notes:

Number of Openings and Doors per Hutch										
width(in)	30	36	42	48	54	60	66	72	78	84
openings	1	1	2	2	2	2	2	2	2	2
doors	2	2	3	3	3	4	4	4	4	4

Laminate doors include locks and keys.

Install wall-mounted overheads directly onto permanent studs. Please refer to installation instructions.

Options:

laminate color

Code	Price	H	W	D	Volume (ft ³)	Weight (lb)
TL-SHHW-1530-L	740	16.5	30	15	7.67	42.05
TL-SHHW-1536-L	782	16.5	36	15	9.02	46.84
TL-SHHW-1542-L	870	16.5	42	15	10.37	51.63
TL-SHHW-1548-L	908	16.5	48	15	11.72	56.42
TL-SHHW-1554-L	950	16.5	54	15	13.07	61.21
TL-SHHW-1560-L	1038	16.5	60	15	14.43	66
TL-SHHW-1566-L	1078	16.5	66	15	15.78	70.79
TL-SHHW-1572-L	1121	16.5	72	15	17.13	75.58

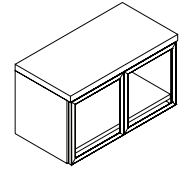

1.5" Wall-Mounted Hinged-Door Hutch w/Acrylic Doors

How to Specify:

Each laminate comes with matching vinyl trim color unless otherwise specified on your purchase order. Refer to the laminate finish card for details.

Notes:

Number of Openings and Doors per Hutch										
width(in)	30	36	42	48	54	60	66	72	78	84
openings	1	1	2	2	2	2	2	2	2	2
doors	2	2	3	3	3	4	4	4	4	4

Acrylic doors do not have locks and keys.

Install wall-mounted overheads directly onto permanent studs. Please refer to installation instructions.

Options:

laminate color

edge profile

metal color (for acrylic door frame)

acrylic color (door)

Code	Price	H	W	D	Volume (ft ³)	Weight (lb)
T-SHHW-1530-G	1483	17	30	15	4.43	46.9
T-SHHW-1536-G	1604	17	36	15	5.31	52.99
T-SHHW-1542-G	1855	17	42	15	6.2	59.08
T-SHHW-1548-G	1975	17	48	15	7.08	65.17
T-SHHW-1554-G	2145	17	54	15	7.97	71.26
T-SHHW-1560-G	2410	17	60	15	8.85	77.35
T-SHHW-1566-G	2529	17	66	15	9.74	83.44
T-SHHW-1572-G	2652	17	72	15	10.63	89.53

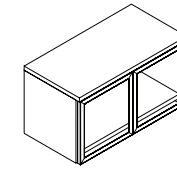

1" Wall-Mounted Hinged-Door Hutch w/Acrylic Doors

How to Specify:

Each laminate comes with matching vinyl trim color unless otherwise specified on your purchase order. Refer to the laminate finish card for details.

Notes:

Number of Openings and Doors per Hutch										
width(in)	30	36	42	48	54	60	66	72	78	84
openings	1	1	2	2	2	2	2	2	2	2
doors	2	2	3	3	3	4	4	4	4	4

Acrylic doors do not have locks and keys.

Install wall-mounted overheads directly onto permanent studs. Please refer to installation instructions.

Options:

laminate color

metal color (for acrylic door frame)

acrylic color (door)

Code	Price	H	W	D	Volume (ft ³)	Weight (lb)
TL-SHHW-1530-G	1447	16.5	30	15	7.67	42.05
TL-SHHW-1536-G	1563	16.5	36	15	9.02	46.84
TL-SHHW-1542-G	1805	16.5	42	15	10.37	51.63
TL-SHHW-1548-G	1923	16.5	48	15	11.72	56.42
TL-SHHW-1554-G	2085	16.5	54	15	13.07	61.21
TL-SHHW-1560-G	2343	16.5	60	15	14.43	66
TL-SHHW-1566-G	2457	16.5	66	15	15.78	70.79
TL-SHHW-1572-G	2573	16.5	72	15	17.13	75.58



Metro Pricebook
February 2023
Tabletops

tabletops

Executive

<u>1.5" Straight Tabletop w/ Grommet</u>	172
<u>1.5" Straight Tabletop - no grommets</u>	176
<u>1.5" D-Tabletop</u>	180
<u>1.5" O-Tabletop</u>	182

Professional

<u>1" Straight Tabletop w/ Grommet</u>	174
<u>1" Straight Tabletop - no grommets</u>	178
<u>1" D-Tabletop</u>	181
<u>1" O-Tabletop</u>	183

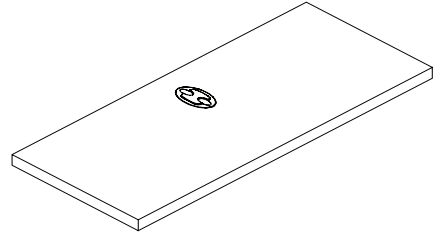

1.5" Straight Tabletop w/ Grommet

How to Specify:

Each laminate comes with matching vinyl trim color unless otherwise specified on your purchase order. Refer to the laminate finish card for details.

Notes:

1 grommet for width 48" or less
2 grommets for width 54" and wider

Options:

laminate color

edge profile

grommet color

Code	Price	H	W	D	Volume (ft ³)	Weight (lb)
UT-WS0G-1818	330	1.5	18	18	0.28	9.96
UT-WS0G-2418	349	1.5	24	18	0.38	14.28
UT-WS0G-3018	373	1.5	30	18	0.47	18.6
UT-WS0G-3618	391	1.5	36	18	0.56	22.92
UT-WS0G-4218	443	1.5	42	18	0.66	27.24
UT-WS0G-4818	468	1.5	48	18	0.75	31.56
UT-WS0G-5418	552	1.5	54	18	0.84	35.88
UT-WS0G-6018	602	1.5	60	18	0.94	40.2
UT-WS0G-6618	689	1.5	66	18	1.03	44.52
UT-WS0G-7218	728	1.5	72	18	1.13	48.84
UT-WS0G-7818	790	1.5	78	18	1.22	53.16
UT-WS0G-8418	854	1.5	84	18	1.31	57.48
UT-WS0G-9018	975	1.5	90	18	1.41	61.8
UT-WS0G-9618	1051	1.5	96	18	1.5	66.12
UT-WS0G-1824	359	1.5	18	24	0.38	12.96
UT-WS0G-2424	378	1.5	24	24	0.5	17.28
UT-WS0G-3024	402	1.5	30	24	0.63	21.6
UT-WS0G-3624	413	1.5	36	24	0.75	25.92
UT-WS0G-4224	483	1.5	42	24	0.88	30.24
UT-WS0G-4824	519	1.5	48	24	1	34.56
UT-WS0G-5424	628	1.5	54	24	1.13	38.88

Code	Price	H	W	D	Volume (ft ³)	Weight (lb)
UT-WS0G-6024	658	1.5	60	24	1.25	43.2
UT-WS0G-6624	733	1.5	66	24	1.38	47.52
UT-WS0G-7224	765	1.5	72	24	1.5	51.84
UT-WS0G-7824	832	1.5	78	24	1.63	56.16
UT-WS0G-8424	898	1.5	84	24	1.75	60.48
UT-WS0G-9024	1023	1.5	90	24	1.88	64.8
UT-WS0G-9624	1104	1.5	96	24	2	69.12
UT-WS0G-1830	373	1.5	18	30	0.47	16.2
UT-WS0G-2430	402	1.5	24	30	0.63	21.6
UT-WS0G-3030	472	1.5	30	30	0.78	27
UT-WS0G-3630	501	1.5	36	30	0.94	32.4
UT-WS0G-4230	541	1.5	42	30	1.09	37.8
UT-WS0G-4830	585	1.5	48	30	1.25	43.2
UT-WS0G-5430	655	1.5	54	30	1.41	48.6
UT-WS0G-6030	694	1.5	60	30	1.56	54
UT-WS0G-6630	791	1.5	66	30	1.72	59.4
UT-WS0G-7230	810	1.5	72	30	1.88	64.8
UT-WS0G-7830	883	1.5	78	30	2.03	70.2
UT-WS0G-8430	954	1.5	84	30	2.19	75.6
UT-WS0G-9030	1084	1.5	90	30	2.34	81
UT-WS0G-9630	1175	1.5	96	30	2.5	86.4
UT-WS0G-1836	391	1.5	18	36	0.56	19.44
UT-WS0G-2436	452	1.5	24	36	0.75	25.92
UT-WS0G-3036	501	1.5	30	36	0.94	32.4
UT-WS0G-3636	519	1.5	36	36	1.13	38.88
UT-WS0G-4236	564	1.5	42	36	1.31	45.36
UT-WS0G-4836	609	1.5	48	36	1.5	51.84
UT-WS0G-5436	680	1.5	54	36	1.69	58.32
UT-WS0G-6036	726	1.5	60	36	1.88	64.8
UT-WS0G-6636	826	1.5	66	36	2.06	71.28
UT-WS0G-7236	849	1.5	72	36	2.25	77.76
UT-WS0G-7836	923	1.5	78	36	2.44	84.24
UT-WS0G-8436	997	1.5	84	36	2.63	90.72
UT-WS0G-9036	1134	1.5	90	36	2.81	97.2
UT-WS0G-9636	1221	1.5	96	36	3	103.68

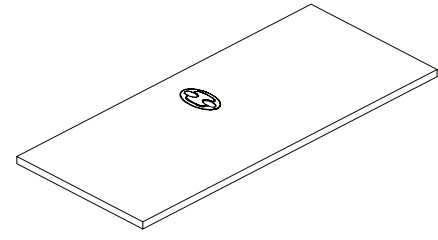

1" Straight Tabletop w/ Grommet

How to Specify:

Each laminate comes with matching vinyl trim color unless otherwise specified on your purchase order. Refer to the laminate finish card for details.

Notes:

1 grommet for width 48" or less
2 grommets for width 54" and wider

Options:

laminate color

grommet color

Code	Price	H	W	D	Volume (ft ³)	Weight (lb)
U-WS0G-1818	246	1	18	18	0.19	6.64
U-WS0G-2418	259	1	24	18	0.25	9.52
U-WS0G-3018	278	1	30	18	0.31	12.4
U-WS0G-3618	288	1	36	18	0.38	15.28
U-WS0G-4218	328	1	42	18	0.44	18.16
U-WS0G-4818	343	1	48	18	0.5	21.04
U-WS0G-5418	410	1	54	18	0.57	23.92
U-WS0G-6018	446	1	60	18	0.63	26.8
U-WS0G-6618	507	1	66	18	0.69	29.68
U-WS0G-7218	540	1	72	18	0.75	32.56
U-WS0G-7818	584	1	78	18	0.82	35.44
U-WS0G-8418	631	1	84	18	0.88	38.32
U-WS0G-9018	717	1	90	18	0.94	41.2
U-WS0G-9618	779	1	96	18	1	44.08
U-WS0G-1824	264	1	18	24	0.25	8.64
U-WS0G-2424	279	1	24	24	0.33	11.52
U-WS0G-3024	298	1	30	24	0.41	14.4
U-WS0G-3624	306	1	36	24	0.5	17.28
U-WS0G-4224	359	1	42	24	0.59	20.16
U-WS0G-4824	386	1	48	24	0.67	23.04
U-WS0G-5424	464	1	54	24	0.75	25.92
U-WS0G-6024	485	1	60	24	0.83	28.8

Code	Price	H	W	D	Volume (ft ³)	Weight (lb)
U-WS0G-6624	542	1	66	24	0.92	31.68
U-WS0G-7224	567	1	72	24	1	34.56
U-WS0G-7824	615	1	78	24	1.09	37.44
U-WS0G-8424	666	1	84	24	1.17	40.32
U-WS0G-9024	755	1	90	24	1.25	43.2
U-WS0G-9624	820	1	96	24	1.33	46.08
U-WS0G-1830	278	1	18	30	0.31	10.8
U-WS0G-2430	298	1	24	30	0.42	14.4
U-WS0G-3030	349	1	30	30	0.52	18
U-WS0G-3630	367	1	36	30	0.63	21.6
U-WS0G-4230	402	1	42	30	0.73	25.2
U-WS0G-4830	433	1	48	30	0.83	28.8
U-WS0G-5430	484	1	54	30	0.94	32.4
U-WS0G-6030	513	1	60	30	1.04	36
U-WS0G-6630	585	1	66	30	1.15	39.6
U-WS0G-7230	601	1	72	30	1.25	43.2
U-WS0G-7830	653	1	78	30	1.36	46.8
U-WS0G-8430	704	1	84	30	1.46	50.4
U-WS0G-9030	803	1	90	30	1.57	54
U-WS0G-9630	869	1	96	30	1.67	57.6
U-WS0G-1836	288	1	18	36	0.37	12.96
U-WS0G-2436	339	1	24	36	0.5	17.28
U-WS0G-3036	367	1	30	36	0.62	21.6
U-WS0G-3636	386	1	36	36	0.75	25.92
U-WS0G-4236	418	1	42	36	0.88	30.24
U-WS0G-4836	452	1	48	36	1	34.56
U-WS0G-5436	506	1	54	36	1.13	38.88
U-WS0G-6036	536	1	60	36	1.25	43.2
U-WS0G-6636	609	1	66	36	1.38	47.52
U-WS0G-7236	628	1	72	36	1.5	51.84
U-WS0G-7836	680	1	78	36	1.63	56.16
U-WS0G-8436	739	1	84	36	1.75	60.48
U-WS0G-9036	843	1	90	36	1.88	64.8
U-WS0G-9636	903	1	96	36	2	69.12

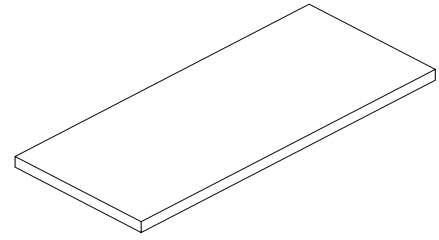

1.5" Straight Tabletop

How to Specify:

Each laminate comes with matching vinyl trim color unless otherwise specified on your purchase order. Refer to the laminate finish card for details.

Notes:

Options:

laminate color

edge profile

Code	Price	H	W	D	Volume (ft ³)	Weight (lb)
UT-WS0N-1818	301	1.5	18	18	0.28	9.96
UT-WS0N-2418	317	1.5	24	18	0.38	14.28
UT-WS0N-3018	342	1.5	30	18	0.47	18.6
UT-WS0N-3618	360	1.5	36	18	0.56	22.92
UT-WS0N-4218	413	1.5	42	18	0.66	27.24
UT-WS0N-4818	435	1.5	48	18	0.75	31.56
UT-WS0N-5418	529	1.5	54	18	0.84	35.88
UT-WS0N-6018	575	1.5	60	18	0.94	40.2
UT-WS0N-6618	655	1.5	66	18	1.03	44.52
UT-WS0N-7218	696	1.5	72	18	1.13	48.84
UT-WS0N-7818	755	1.5	78	18	1.22	53.16
UT-WS0N-8418	823	1.5	84	18	1.31	57.48
UT-WS0N-9018	944	1.5	90	18	1.41	61.8
UT-WS0N-9618	1018	1.5	96	18	1.5	66.12
UT-WS0N-1824	329	1.5	18	24	0.38	12.96
UT-WS0N-2424	345	1.5	24	24	0.5	17.28
UT-WS0N-3024	367	1.5	30	24	0.63	21.6
UT-WS0N-3624	384	1.5	36	24	0.75	25.92
UT-WS0N-4224	452	1.5	42	24	0.88	30.24
UT-WS0N-4824	492	1.5	48	24	1	34.56
UT-WS0N-5424	596	1.5	54	24	1.13	38.88
UT-WS0N-6024	629	1.5	60	24	1.25	43.2

Code	Price	H	W	D	Volume (ft ³)	Weight (lb)
UT-WS0N-6624	700	1.5	66	24	1.38	47.52
UT-WS0N-7224	735	1.5	72	24	1.5	51.84
UT-WS0N-7824	801	1.5	78	24	1.63	56.16
UT-WS0N-8424	869	1.5	84	24	1.75	60.48
UT-WS0N-9024	993	1.5	90	24	1.88	64.8
UT-WS0N-9624	1078	1.5	96	24	2	69.12
UT-WS0N-1830	341	1.5	18	30	0.47	16.2
UT-WS0N-2430	367	1.5	24	30	0.63	21.6
UT-WS0N-3030	443	1.5	30	30	0.78	27
UT-WS0N-3630	472	1.5	36	30	0.94	32.4
UT-WS0N-4230	509	1.5	42	30	1.09	37.8
UT-WS0N-4830	552	1.5	48	30	1.25	43.2
UT-WS0N-5430	628	1.5	54	30	1.41	48.6
UT-WS0N-6030	663	1.5	60	30	1.56	54
UT-WS0N-6630	758	1.5	66	30	1.72	59.4
UT-WS0N-7230	784	1.5	72	30	1.88	64.8
UT-WS0N-7830	854	1.5	78	30	2.03	70.2
UT-WS0N-8430	927	1.5	84	30	2.19	75.6
UT-WS0N-9030	1054	1.5	90	30	2.34	81
UT-WS0N-9630	1141	1.5	96	30	2.5	86.4
UT-WS0N-1836	359	1.5	18	36	0.56	19.44
UT-WS0N-2436	420	1.5	24	36	0.75	25.92
UT-WS0N-3036	472	1.5	30	36	0.94	32.4
UT-WS0N-3636	491	1.5	36	36	1.13	38.88
UT-WS0N-4236	535	1.5	42	36	1.31	45.36
UT-WS0N-4836	578	1.5	48	36	1.5	51.84
UT-WS0N-5436	655	1.5	54	36	1.69	58.32
UT-WS0N-6036	693	1.5	60	36	1.88	64.8
UT-WS0N-6636	795	1.5	66	36	2.06	71.28
UT-WS0N-7236	822	1.5	72	36	2.25	77.76
UT-WS0N-7836	892	1.5	78	36	2.44	84.24
UT-WS0N-8436	968	1.5	84	36	2.63	90.72
UT-WS0N-9036	1102	1.5	90	36	2.81	97.2
UT-WS0N-9636	1189	1.5	96	36	3	103.68

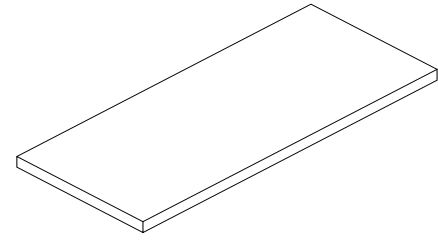

1" Straight Tabletop

How to Specify:

Each laminate comes with matching vinyl trim color unless otherwise specified on your purchase order. Refer to the laminate finish card for details.

Notes:

Options:

laminate color

Code	Price	H	W	D	Volume (ft ³)	Weight (lb)
U-WS0N-1818	224	1	18	18	0.19	6.64
U-WS0N-2418	234	1	24	18	0.25	9.52
U-WS0N-3018	256	1	30	18	0.31	12.4
U-WS0N-3618	265	1	36	18	0.38	15.28
U-WS0N-4218	306	1	42	18	0.44	18.16
U-WS0N-4818	321	1	48	18	0.5	21.04
U-WS0N-5418	389	1	54	18	0.57	23.92
U-WS0N-6018	425	1	60	18	0.63	26.8
U-WS0N-6618	484	1	66	18	0.69	29.68
U-WS0N-7218	515	1	72	18	0.75	32.56
U-WS0N-7818	563	1	78	18	0.82	35.44
U-WS0N-8418	608	1	84	18	0.88	38.32
U-WS0N-9018	699	1	90	18	0.94	41.2
U-WS0N-9618	754	1	96	18	1	44.08
U-WS0N-1824	244	1	18	24	0.25	8.64
U-WS0N-2424	257	1	24	24	0.33	11.52
U-WS0N-3024	277	1	30	24	0.41	14.4
U-WS0N-3624	282	1	36	24	0.5	17.28
U-WS0N-4224	339	1	42	24	0.59	20.16
U-WS0N-4824	363	1	48	24	0.67	23.04
U-WS0N-5424	443	1	54	24	0.75	25.92
U-WS0N-6024	468	1	60	24	0.83	28.8
U-WS0N-6624	517	1	66	24	0.92	31.68
U-WS0N-7224	543	1	72	24	1	34.56
U-WS0N-7824	595	1	78	24	1.09	37.44

Code	Price	H	W	D	Volume (ft ³)	Weight (lb)
U-WS0N-8424	644	1	84	24	1.17	40.32
U-WS0N-9024	738	1	90	24	1.25	43.2
U-WS0N-9624	798	1	96	24	1.33	46.08
U-WS0N-6624	517	1	66	24	0.92	31.68
U-WS0N-7224	543	1	72	24	1	34.56
U-WS0N-7824	595	1	78	24	1.09	37.44
U-WS0N-8424	644	1	84	24	1.17	40.32
U-WS0N-9024	738	1	90	24	1.25	43.2
U-WS0N-9624	798	1	96	24	1.33	46.08
U-WS0N-1830	255	1	18	30	0.31	10.8
U-WS0N-2430	277	1	24	30	0.42	14.4
U-WS0N-3030	328	1	30	30	0.52	18
U-WS0N-3630	349	1	36	30	0.63	21.6
U-WS0N-4230	380	1	42	30	0.73	25.2
U-WS0N-4830	410	1	48	30	0.83	28.8
U-WS0N-5430	464	1	54	30	0.94	32.4
U-WS0N-6030	491	1	60	30	1.04	36
U-WS0N-6630	564	1	66	30	1.15	39.6
U-WS0N-7230	579	1	72	30	1.25	43.2
U-WS0N-7830	631	1	78	30	1.36	46.8
U-WS0N-8430	685	1	84	30	1.46	50.4
U-WS0N-9030	784	1	90	30	1.57	54
U-WS0N-9630	848	1	96	30	1.68	57.6
U-WS0N-1836	268	1	18	36	0.37	12.96
U-WS0N-2436	317	1	24	36	0.5	17.28
U-WS0N-3036	349	1	30	36	0.62	21.6
U-WS0N-3636	364	1	36	36	0.75	25.92
U-WS0N-4236	395	1	42	36	0.88	30.24
U-WS0N-4836	431	1	48	36	1	34.56
U-WS0N-5436	484	1	54	36	1.13	38.88
U-WS0N-6036	516	1	60	36	1.25	43.2
U-WS0N-6636	591	1	66	36	1.38	47.52
U-WS0N-7236	606	1	72	36	1.5	51.84
U-WS0N-7836	658	1	78	36	1.63	56.16
U-WS0N-8436	716	1	84	36	1.75	60.48
U-WS0N-9036	820	1	90	36	1.88	64.8
U-WS0N-9636	883	1	96	36	2	69.12

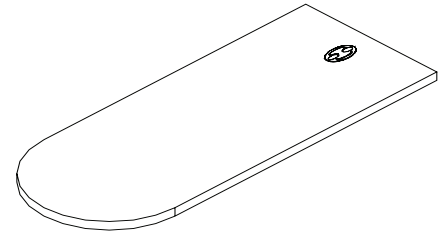

How to Specify:

Each laminate comes with matching vinyl trim color unless otherwise specified on your purchase order. Refer to the laminate finish card for details.

Options:

laminate color

edge profile

grommet color

Code	Price	H	W	D	Volume (ft³)	Weight (lb)
UT-WDTG-6024	820	1.5	60	24	1.25	41.18
UT-WDTG-6624	963	1.5	66	24	1.38	45.35
UT-WDTG-7224	1038	1.5	72	24	1.5	49.51
UT-WDTG-7824	1196	1.5	78	24	1.63	53.67
UT-WDTG-8424	1253	1.5	84	24	1.75	57.83
UT-WDTG-6030	905	1.5	60	30	1.56	47.45
UT-WDTG-6630	1064	1.5	66	30	1.72	52.31
UT-WDTG-7230	1147	1.5	72	30	1.88	57.17
UT-WDTG-7830	1326	1.5	78	30	2.03	62.03
UT-WDTG-8430	1390	1.5	84	30	2.19	66.89
UT-WDTG-6036	997	1.5	60	36	1.88	58.61
UT-WDTG-6636	1168	1.5	66	36	2.06	64.16
UT-WDTG-7236	1256	1.5	72	36	2.25	69.71
UT-WDTG-7836	1449	1.5	78	36	2.44	75.26
UT-WDTG-8436	1525	1.5	84	36	2.63	80.81

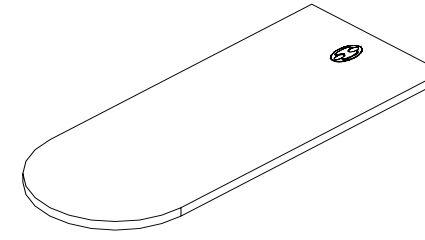

How to Specify:

Each laminate comes with matching vinyl trim color unless otherwise specified on your purchase order. Refer to the laminate finish card for details.

Options:

laminate color

grommet color

Code	Price	H	W	D	Volume (ft³)	Weight (lb)
U-WDTG-6024	680	1	60	24	0.83	27.46
U-WDTG-6624	801	1	66	24	0.92	30.23
U-WDTG-7224	831	1	72	24	1	33.01
U-WDTG-7824	999	1	78	24	1.09	35.78
U-WDTG-8424	1048	1	84	24	1.17	38.56
U-WDTG-6030	754	1	60	30	1.04	31.64
U-WDTG-6630	888	1	66	30	1.15	34.88
U-WDTG-7230	956	1	72	30	1.25	38.11
U-WDTG-7830	1102	1	78	30	1.36	41.35
U-WDTG-8430	1157	1	84	30	1.46	44.59
U-WDTG-6036	827	1	60	36	1.25	39.07
U-WDTG-6636	978	1	66	36	1.38	42.77
U-WDTG-7236	1051	1	72	36	1.5	46.47
U-WDTG-7836	1208	1	78	36	1.63	50.17
U-WDTG-8436	1273	1	84	36	1.75	53.87

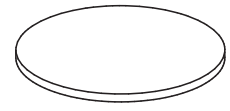

How to Specify:

Each laminate comes with matching vinyl trim color unless otherwise specified on your purchase order. Refer to the laminate finish card for details.

Options:

laminate color

edge profile (for o-tabletop)

Code	Price	H	W	D	Volume (ft ³)	Weight (lb)
T-WOXX-24	447	1.5	24	24	0.5	32.4
T-WOXX-30	447	1.5	30	30	0.78	40.5
T-WOXX-36	447	1.5	36	36	1.13	39.76
T-WOXX-42	573	1.5	42	42	1.53	54.11
T-WOXX-48	646	1.5	48	48	2	70.68
T-WOXX-54	726	1.5	54	54	2.53	72.9
T-WOXX-60	803	1.5	60	60	3.13	81

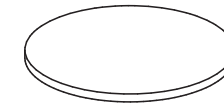

How to Specify:

Each laminate comes with matching vinyl trim color unless otherwise specified on your purchase order. Refer to the laminate finish card for details.

laminate color

Code	Price	H	W	D	Volume (ft ³)	Weight (lb)
TL-WOXX-24	358	1	24	24	1.2	32.4
TL-WOXX-30	386	1	30	30	1.5	40.5
TL-WOXX-36	424	1	36	36	4.63	26.5
TL-WOXX-42	541	1	42	42	6.12	36.07
TL-WOXX-48	606	1	48	48	7.82	47.12
TL-WOXX-54	680	1	54	54	2.7	72.9
TL-WOXX-60	748	1	60	60	3	81



Metro Pricebook
February 2023

Bases

bases

<u>cross base</u>	186
<u>post support base</u>	187
<u>open metal gable</u>	188

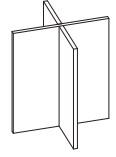

Cross base

Notes:

4 post supports required for each o-tabletop.

Options:

laminat color

Code	Price	H	W	D	Volume (ft ³)	Weight (lb)
T-B6-30	413	28	18	18	7.63	24.99
T-B6-36	413	28	24	24	14.52	33.64
T-B6-42	428	28	30	30	21.41	42.29
T-B6-48	457	28	36	36	29.63	49.23
T-B6-54	470	28	42	42	37.85	56.17
T-B6-60	495	28	48	48	46.07	63.11



Post Support Base

Notes:

4 post supports required for each o-tabletop.

Options:

metal color (for post support)

Code	Price	H	W	D	Volume (ft ³)	Weight (lb)
TB-BASE-1	359	28	3	3	0.85	7

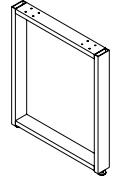

Open Metal Gable

Options:

metal color (for gables)

Code	Price	H	W	D	Volume (ft ³)	Weight (lb)
U-CG0M-12	373	28	12	0.3	0.58	6
U-CG0M-18	424	28	18	0.4	0.88	10
U-CG0M-21	447	28	21	0.45	1.02	12
U-CG0M-24	473	28	24	0.5	1.17	14
U-CG0M-30	525	28	30	0.6	1.46	18
U-CG0M-36	575	28	36	0.7	1.75	22
U-CG0M-1813	270	13	18	0.4		5
U-CG0M-2413	334	13	24	0.4		7
U-CG0M-3013	341	13	30	0.4		9
U-CG0M-3613	377	13	36	0.4		11



Metro Pricebook
February 2023
Reception Unit

reception unit

executive 192

professional 193

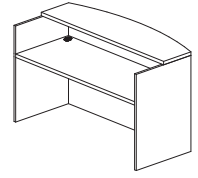

1.5" Reception Unit w/Countertop

How to Specify:

Each laminate comes with matching vinyl trim color unless otherwise specified on your purchase order. Refer to the laminate finish card for details.

Options:

laminate color

edge profile

grommet color

Code	Price	H	W	D	Volume (ft ³)	Weight (lb)
T-RC0G-7230	2110	43.5	72	30	54.38	272.25

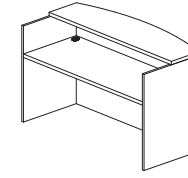

1" Reception Unit w/Countertop

How to Specify:

Each laminate comes with matching vinyl trim color unless otherwise specified on your purchase order. Refer to the laminate finish card for details.

Options:

laminate color

grommet color

Code	Price	H	W	D	Volume (ft ³)	Weight (lb)
TL-RC0G-7230	1884	43	72	30	53.75	228.15



Metro Pricebook
February 2023

Service Write Up Desk

service write up desk

Executive

w/ Straight Front Countertop 196

w/ Arc Countertop 198

Professional

w/ Straight Front Countertop 197

w/ Arc Countertop 199

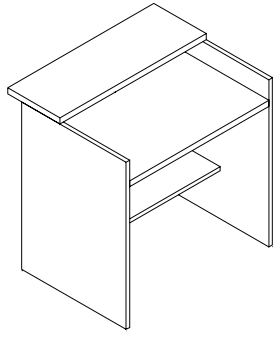

1.5" Service Write Up Desk w/ Straight Countertop

How to Specify:

Each laminate comes with matching vinyl trim color unless otherwise specified on your purchase order. Refer to the laminate finish card for details.

Options:

laminate color

edge profile

Code	Price	H	W	D	Volume (ft ³)	Weight (lb)
T-RCWG-3030-S	1642	43	30	30	25.46	94
T-RCWG-3630-S	1729	43	36	30	30.55	97
T-RCWG-4230-S	1828	43	42	30	35.64	100
T-RCWG-4830-S	1923	43	48	30	40.73	103
T-RCWG-5430-S	1998	43	54	30	45.82	106
T-RCWG-6030-S	2076	43	60	30	50.91	109
T-RCWG-6630-S	2151	43	66	30	56	112
T-RCWG-7230-S	2261	43	72	30	61.09	115
T-RCWG-7830-S	2363	43	78	30	66.18	118
T-RCWG-8430-S	2461	43	84	30	71.28	121

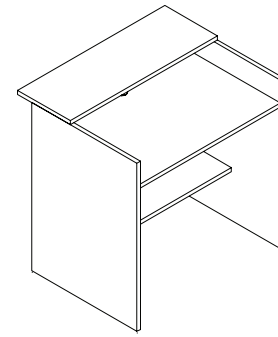

1" Service Write Up Desk w/ Straight Countertop

How to Specify:

Each laminate comes with matching vinyl trim color unless otherwise specified on your purchase order. Refer to the laminate finish card for details.

Options:

laminate color

Code	Price	H	W	D	Volume (ft ³)	Weight (lb)
TL-RCWG-3030-S	1533	43	30	30	22.4	88
TL-RCWG-3630-S	1642	43	36	30	26.88	91
TL-RCWG-4230-S	1719	43	42	30	31.35	94
TL-RCWG-4830-S	1794	43	48	30	35.83	97
TL-RCWG-5430-S	1873	43	54	30	40.31	100
TL-RCWG-6030-S	1948	43	60	30	44.79	103
TL-RCWG-6630-S	2025	43	66	30	49.27	106
TL-RCWG-7230-S	2133	43	72	30	53.75	109
TL-RCWG-7830-S	2274	43	78	30	58.23	112
TL-RCWG-8430-S	2352	43	84	30	62.71	115

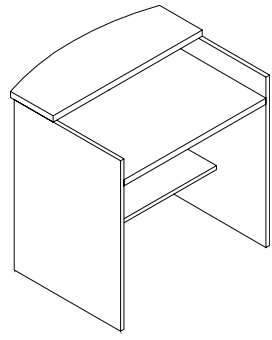

1.5" Service Write Up Desk w/ Arc Countertop

How to Specify:

Each laminate comes with matching vinyl trim color unless otherwise specified on your purchase order. Refer to the laminate finish card for details.

Options:

laminate color

edge profile

Code	Price	H	W	D	Volume (ft ³)	Weight (lb)
T-RCWG-3030-A	1838	43	30	30	25.46	94
T-RCWG-3630-A	1896	43	36	30	30.55	97
T-RCWG-4230-A	1982	43	42	30	35.64	100
T-RCWG-4830-A	2077	43	48	30	40.73	103
T-RCWG-5430-A	2104	43	54	30	45.82	106
T-RCWG-6030-A	2300	43	60	30	50.91	109
T-RCWG-6630-A	2376	43	66	30	56	112
T-RCWG-7230-A	2467	43	72	30	61.09	115
T-RCWG-7830-A	2608	43	78	30	66.18	118
T-RCWG-8430-A	2706	43	84	30	71.28	121

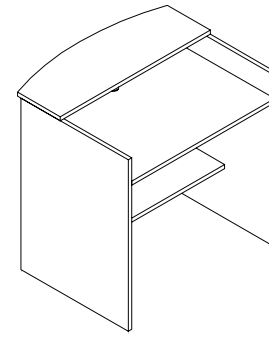

1" Service Write Up Desk w/ Arc Countertop

How to Specify:

Each laminate comes with matching vinyl trim color unless otherwise specified on your purchase order. Refer to the laminate finish card for details.

Options:

laminate color

Code	Price	H	W	D	Volume (ft ³)	Weight (lb)
TL-RCWG-3030-A	1650	43	30	30	22.4	88
TL-RCWG-3630-A	1726	43	36	30	26.88	91
TL-RCWG-4230-A	1802	43	42	30	31.35	94
TL-RCWG-4830-A	1878	43	48	30	35.83	97
TL-RCWG-5430-A	1956	43	54	30	40.31	100
TL-RCWG-6030-A	2048	43	60	30	44.79	103
TL-RCWG-6630-A	2109	43	66	30	49.27	106
TL-RCWG-7230-A	2218	43	72	30	53.75	109
TL-RCWG-7830-A	2352	43	78	30	58.23	112
TL-RCWG-8430-A	2467	43	84	30	62.71	115



Metro Pricebook
February 2023
Coffee & End Tables

coffee and end tables

Executive

coffee and end table 202

Professional

coffee and end table 203

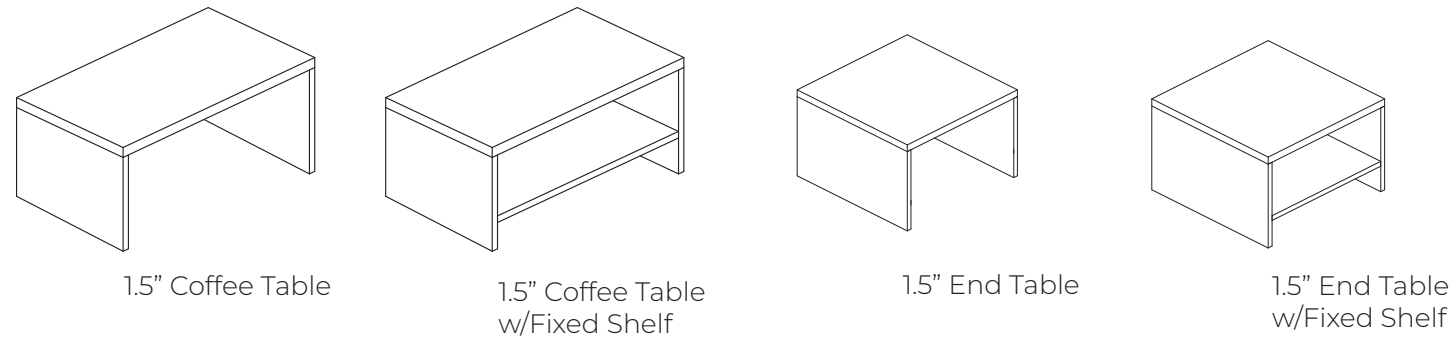

How to Specify:

Each laminate comes with matching vinyl trim color unless otherwise specified on your purchase order. Refer to the laminate finish card for details.

Options:

laminate color

edge profile

Code	Price	H	W	D	Volume (ft ³)	Weight (lb)
Coffee Table						
T-TCT0-362017	443	17.5	36	20	7.29	48.6
T-TCT0-422017	473	17.5	42	20	8.51	53.93
T-TCT0-482017	510	17.5	48	20	9.72	59.26
Coffee Table w/Fixed Shelf						
T-TCTS-362017	542	17.5	36	20	7.29	66.3
T-TCTS-422017	573	17.5	42	20	8.51	74.25
T-TCTS-482017	612	17.5	48	20	9.72	82.2
End Table						
T-TCT0-202019	413	19.5	20	20	4.51	35.7
T-TCT0-242419	464	19.5	24	24	6.5	47.03
T-TCT0-303019	573	19.5	30	30	10.16	58.36
End Table w/Fixed Shelf						
T-TCTS-202019	510	19.5	20	20	4.51	51.36
T-TCTS-242419	564	19.5	24	24	6.5	62.87
T-TCTS-303019	674	19.5	30	30	10.16	78.65

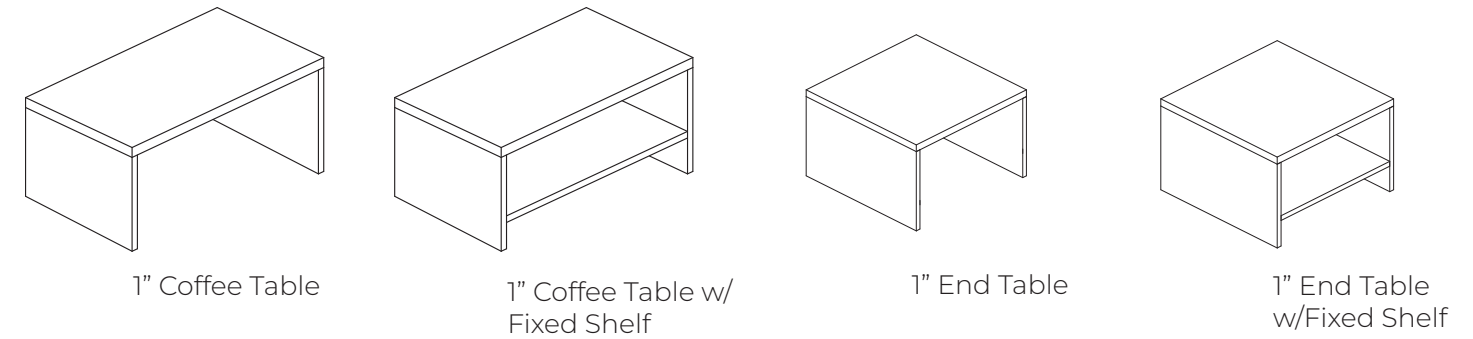

How to Specify:

Each laminate comes with matching vinyl trim color unless otherwise specified on your purchase order. Refer to the laminate finish card for details.

Options:

laminate color

Code	Price	H	W	D	Volume (ft ³)	Weight (lb)
Coffee Table						
TL-TCT0-362017	397	17	36	20	7.08	39.45
TL-TCT0-422017	427	17	42	20	8.26	43.02
TL-TCT0-482017	469	17	48	20	9.44	46.59
Coffee Table w/Fixed Shelf						
TL-TCTS-362017	498	17	36	20	7.08	56.7
TL-TCTS-362017	498	17	36	20	7.08	56.7
TL-TCTS-362017	498	17	36	20	7.08	56.7
End Table						
TL-TCT0-202019	365	19	20	20	4.4	30.66
TL-TCT0-242419	419	19	24	24	6.33	39.3
TL-TCT0-303019	530	19	30	30	9.9	47.94
End Table w/Fixed Shelf						
TL-TCTS-202019	469	19	20	20	4.4	40.03
TL-TCTS-242419	517	19	24	24	6.33	53.05
TL-TCTS-303019	628	19	30	30	9.9	69.81



Metro Pricebook
February 2023
Conference

conference

table top	208
straight tabletop	208
straight tabletop w/power and data	210
boat-shaped tabletop	212
boat-shaped tabletop w/power and data	214
racetrack tabletop	216
racetrack tabletop w/power and data	218
tapered tabletop	220
tapered tabletop w/ power and data	221
table base	222
gable & modesty base	222
elliptical base	226
table base configuration	230
options	231
Ellora Grommet add-ons	231
filing and storage	232
serving cabinet	232
storage cabinet w/shelves	233
combo cabinet w/storage & lateral files	234
double door cabinet w/shelves	235
combo cabinet	236
storage cabinet w/coat bar and shelves	237
presentation tools	238
whiteboard cabinet	238
computer desk	239

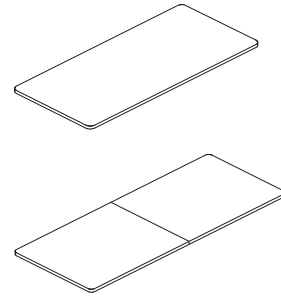

1.5" Straight Tabletop

How to Specify:

Each laminate comes with matching vinyl trim color unless otherwise specified on your purchase order. Refer to the laminate finish card for details.

Notes:

Tabletops 72"-96"W are configured in one-piece top.

Tabletops 108"-192"W are configured in two-piece tops.

Tabletops 204"-240"W are configured in three-piece tops.

Options:

laminate color

edge profile

Code	Price	H	W	D	Volume (ft ³)	Weight (lb)
TB-MSSX-7236	746	1.5	72	36	2.25	89.91
TB-MSSX-7242	934	1.5	72	42	2.62	104.92
TB-MSSX-8436	858	1.5	84	36	2.62	104.92
TB-MSSX-8442	1015	1.5	84	42	3.06	122.43
TB-MSSX-8448	1081	1.5	84	48	3.5	139.93
TB-MSSX-9636	936	1.5	96	36	3	119.93
TB-MSSX-9642	1098	1.5	96	42	3.5	139.93
TB-MSSX-9648	1135	1.5	96	48	4	159.94
TB-MSSX-10848	1359	1.5	108	48	4.49	179.76
TB-MSSX-10854	1608	1.5	108	54	5.05	202.27
TB-MSSX-10860	1635	1.5	108	60	5.62	224.78
TB-MSSX-12048	1486	1.5	120	48	4.99	199.77
TB-MSSX-12054	1756	1.5	120	54	5.62	224.78
TB-MSSX-12060	1783	1.5	120	60	6.24	249.79
TB-MSSX-13248	1609	1.5	132	48	5.49	219.78
TB-MSSX-13254	1906	1.5	132	54	6.18	247.29

Code	Price	H	W	D	Volume (ft ³)	Weight (lb)
TB-MSSX-13260	1934	1.5	132	60	6.87	274.8
TB-MSSX-14448	1735	1.5	144	48	5.99	239.78
TB-MSSX-14454	2057	1.5	144	54	6.74	269.8
TB-MSSX-14460	2085	1.5	144	60	7.49	299.81
TB-MSSX-15648	1863	1.5	156	48	6.49	259.69
TB-MSSX-15654	2209	1.5	156	54	7.3	292.3
TB-MSSX-15660	2235	1.5	156	60	8.12	324.82
TB-MSSX-16848	2181	1.5	168	48	6.99	279.8
TB-MSSX-16854	2357	1.5	168	54	7.87	314.81
TB-MSSX-16860	2384	1.5	168	60	8.74	349.83
TB-MSSX-18048	2212	1.5	180	48	7.49	299.81
TB-MSSX-18054	2507	1.5	180	54	8.43	337.32
TB-MSSX-18060	2537	1.5	180	60	9.37	374.84
TB-MSSX-19248	2237	1.5	192	48	7.99	319.82
TB-MSSX-19254	2659	1.5	192	54	8.99	359.83
TB-MSSX-19260	2685	1.5	192	60	9.99	399.85
TB-MSSX-20448	2482	1.5	204	48	8.49	339.63
TB-MSSX-20454	2940	1.5	204	54	9.55	382.15
TB-MSSX-20460	2980	1.5	204	60	10.61	424.67
TB-MSSX-21648	2606	1.5	216	48	8.99	359.64
TB-MSSX-21654	3089	1.5	216	54	10.11	404.66
TB-MSSX-21660	3131	1.5	216	60	11.24	449.68
TB-MSSX-22848	2732	1.5	228	48	9.49	379.65
TB-MSSX-22854	3240	1.5	228	54	10.67	427.17
TB-MSSX-22860	3280	1.5	228	60	11.86	474.69
TB-MSSX-24048	3054	1.5	240	48	9.99	399.66
TB-MSSX-24054	3389	1.5	240	54	11.24	449.68
TB-MSSX-24060	3431	1.5	240	60	12.49	499.7
TB-MSSX-22860	3280	1.5	228	60	11.86	474.69
TB-MSSX-24048	3054	1.5	240	48	9.99	399.66
TB-MSSX-24054	3389	1.5	240	54	11.24	449.68
TB-MSSX-24060	3431	1.5	240	60	12.49	499.7

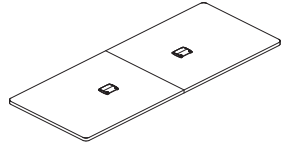

1.5" Straight Tabletop w/Power and Data

How to Specify:

Each laminate comes with matching vinyl trim color unless otherwise specified on your purchase order. Refer to the laminate finish card for details.

Notes:

Tabletops 72"-96"W are configured in one-piece top.
 Tabletops 108"-192"W are configured in two-piece tops.
 Tabletops 204"-240"W are configured in three-piece tops.
 Single-piece tabletops are equipped with one power and data grommet, two-piece tabletops are equipped with two power and data grommets, and three-piece tabletops are equipped with three power and data grommets.
 Two power and dual USB-A receptacles with 3 open slots to accommodate RJ11, RJ45, HDMI, VGA or Stereo. Items for 3 open slots must be specified and purchased separately.
 Boardroom tables with tops comprised of 2 or more pieces will not have a consistent grain pattern.

Options:

laminate color

edge profile

grommet color (for tabletops with power and data)

Code	Price	H	W	D	Volume (ft ³)	Weight (lb)
TB-MSSP-7236	1775	1.5	72	36	2.2	87.99
TB-MSSP-7242	1964	1.5	72	42	2.57	102.99
TB-MSSP-8436	1889	1.5	84	36	2.57	102.99
TB-MSSP-8442	2045	1.5	84	42	3.01	120.5
TB-MSSP-8448	2113	1.5	84	48	3.45	138.01
TB-MSSP-9636	1968	1.5	96	36	2.95	118
TB-MSSP-9642	2129	1.5	96	42	3.45	138.01
TB-MSSP-9648	2166	1.5	96	48	3.95	158.01
TB-MSSP-10848	3420	1.5	108	48	4.43	178.17
TB-MSSP-10854	3669	1.5	108	54	4.49	200.68
TB-MSSP-10860	3697	1.5	108	60	5.56	223.19
TB-MSSP-12048	3544	1.5	120	48	4.93	198.18
TB-MSSP-12054	3818	1.5	120	54	5.56	223.19
TB-MSSP-12060	3843	1.5	120	60	6.18	248.2
TB-MSSP-13248	3670	1.5	132	48	5.43	218.19

Code	Price	H	W	D	Volume (ft ³)	Weight (lb)
TB-MSSP-13254	3967	1.5	132	54	6.12	245.7
TB-MSSP-13260	3992	1.5	132	60	6.81	273.21
TB-MSSP-14448	3796	1.5	144	48	5.93	238.19
TB-MSSP-14454	4117	1.5	144	54	6.68	268.21
TB-MSSP-14460	4145	1.5	144	60	7.43	298.22
TB-MSSP-15648	3922	1.5	156	48	6.43	258.2
TB-MSSP-15654	4267	1.5	156	54	7.24	290.72
TB-MSSP-15660	4296	1.5	156	60	8.06	323.23
TB-MSSP-16848	4244	1.5	168	48	6.93	278.21
TB-MSSP-16854	4417	1.5	168	54	7.81	313.22
TB-MSSP-16860	4445	1.5	168	60	8.68	348.24
TB-MSSP-18048	4270	1.5	180	48	7.43	298.22
TB-MSSP-18054	4566	1.5	180	54	8.37	335.73
TB-MSSP-18060	4595	1.5	180	60	9.31	373.25
TB-MSSP-19248	4299	1.5	192	48	7.93	318.23
TB-MSSP-19254	4718	1.5	192	54	8.93	358.24
TB-MSSP-19260	4744	1.5	192	60	9.93	398.26
TB-MSSP-20448	5570	1.5	204	48	8.4	337.25
TB-MSSP-20454	6030	1.5	204	54	9.46	379.77
TB-MSSP-20460	6071	1.5	204	60	10.52	422.28
TB-MSSP-21648	5696	1.5	216	48	8.9	357.26
TB-MSSP-21654	6180	1.5	216	54	10.02	402.28
TB-MSSP-21660	6219	1.5	216	60	11.15	447.29
TB-MSSP-22848	5820	1.5	228	48	9.4	377.27
TB-MSSP-22854	6329	1.5	228	54	10.58	424.79
TB-MSSP-22860	6369	1.5	228	60	11.77	472.3
TB-MSSP-24048	6144	1.5	240	48	9.9	397.27
TB-MSSP-24054	6480	1.5	240	54	11.15	447.29
TB-MSSP-24060	6520	1.5	240	60	12.4	497.31



1.5" Boat-Shaped Tabletop

How to Specify:

Each laminate comes with matching vinyl trim color unless otherwise specified on your purchase order. Refer to the laminate finish card for details.

Notes:

- Tabletops 72"-96"W are configured in one-piece top.
- Tabletops 108"-192"W are configured in two-piece tops.
- Tabletops 204"-240"W are configured in three-piece tops.

Options:

laminate color

edge profile

Code	Price	H	W	D	Volume (ft ³)	Weight (lb)
TB-MBBX-7236	746	1.5	72	36	2	80.81
TB-MBBX-7242	934	1.5	72	42	2.38	95.09
TB-MBBX-8436	858	1.5	84	36	2.33	93.4
TB-MBBX-8442	1015	1.5	84	42	2.77	110.91
TB-MBBX-8448	1081	1.5	84	48	3.21	128.42
TB-MBBX-9636	936	1.5	96	36	2.67	106.72
TB-MBBX-9642	1098	1.5	96	42	3.17	126.73
TB-MBBX-9648	1135	1.5	96	48	3.67	146.74
TB-MBBX-10848	1359	1.5	108	48	4.12	164.78
TB-MBBX-10854	1608	1.5	108	54	4.68	187.3
TB-MBBX-10860	1635	1.5	108	60	5.24	209.8
TB-MBBX-12048	1486	1.5	120	48	4.58	183.12
TB-MBBX-12054	1756	1.5	120	54	5.2	208.12
TB-MBBX-12060	1783	1.5	120	60	5.82	233.14
TB-MBBX-13248	1609	1.5	132	48	5.04	201.44
TB-MBBX-13254	1906	1.5	132	54	5.72	228.96

Code	Price	H	W	D	Volume (ft ³)	Weight (lb)
TB-MBBX-13260	1934	1.5	132	60	6.4	256.46
TB-MBBX-14448	1735	1.5	144	48	5.5	219.78
TB-MBBX-14454	2057	1.5	144	54	6.24	249.8
TB-MBBX-14460	2085	1.5	144	60	7	279.8
TB-MBBX-15648	1863	1.5	156	48	5.96	238.12
TB-MBBX-15654	2209	1.5	156	54	6.76	270.62
TB-MBBX-15660	2235	1.5	156	60	7.58	303.14
TB-MBBX-16848	2181	1.5	168	48	6.4	256.44
TB-MBBX-16854	2357	1.5	168	54	7.28	291.48
TB-MBBX-16860	2384	1.5	168	60	8.16	326.48
TB-MBBX-18048	2212	1.5	180	48	6.86	274.78
TB-MBBX-18054	2507	1.5	180	54	7.8	313.8
TB-MBBX-18060	2537	1.5	180	60	8.74	349.82
TB-MBBX-19248	2237	1.5	192	48	7.32	293.12
TB-MBBX-19254	2659	1.5	192	54	8.32	333.14
TB-MBBX-19260	2685	1.5	192	60	9.32	373.16
TB-MBBX-20448	2482	1.5	204	48	7.78	344.36
TB-MBBX-20454	2940	1.5	204	54	8.84	353.87
TB-MBBX-20460	2980	1.5	204	60	9.9	396.39
TB-MBBX-21648	2606	1.5	216	48	8.24	329.69
TB-MBBX-21654	3089	1.5	216	54	9.36	374.71
TB-MBBX-21660	3131	1.5	216	60	10.49	419.73
TB-MBBX-22848	2732	1.5	228	48	8.7	348.03
TB-MBBX-22854	3240	1.5	228	54	9.88	395.55
TB-MBBX-22860	3280	1.5	228	60	11.07	443.07
TB-MBBX-24048	3054	1.5	240	48	9.15	366.37
TB-MBBX-24054	3389	1.5	240	54	6.1	416.39
TB-MBBX-24060	3431	1.5	240	60	11.65	466.41



1.5" Boat-Shaped Tabletop w/Power and Data

How to Specify:

Each laminate comes with matching vinyl trim color unless otherwise specified on your purchase order. Refer to the laminate finish card for details.

Notes:

Tabletops 72"-96"W are configured in one-piece top.

Tabletops 108"-192"W are configured in two-piece tops.

Tabletops 204"-240"W are configured in three-piece tops.

Single-piece tabletops are equipped with one power and data grommet, two-piece tabletops are equipped with two power and data grommets, and three-piece tabletops are equipped with three power and data grommets.

Two power and dual USB-A receptacles with 3 open slots to accommodate RJ11, RJ45, HDMI, VGA or Stereo. Items for 3 open slots must be specified and purchased separately.

Boardroom tables with tops comprised of 2 or more pieces will not have a consistent grain pattern.

Options:

laminate color

edge profile

grommet color (for tabletops with power and data)

Code	Price	H	W	D	Volume (ft ³)	Weight (lb)
TB-MBBP-7236	1775	1.5	72	36	1.95	78.15
TB-MBBP-7242	1964	1.5	72	42	2.33	93.16
TB-MBBP-8436	1889	1.5	84	36	2.29	91.47
TB-MBBP-8442	2045	1.5	84	42	2.72	108.98
TB-MBBP-8448	2113	1.5	84	48	3.16	126.49
TB-MBBP-9636	1968	1.5	96	36	2.62	104.8
TB-MBBP-9642	2129	1.5	96	42	3.12	124.8
TB-MBBP-9648	2166	1.5	96	48	3.62	144.81
TB-MBBP-10848	3420	1.5	108	48	4.02	160.92
TB-MBBP-10854	3669	1.5	108	54	4.58	183.44
TB-MBBP-10860	3697	1.5	108	60	5.14	205.94
TB-MBBP-12048	3544	1.5	120	48	4.48	179.26
TB-MBBP-12054	3818	1.5	120	54	5.1	204.26

Code	Price	H	W	D	Volume (ft ³)	Weight (lb)
TB-MBBP-12060	3843	1.5	120	60	5.72	229.28
TB-MBBP-13248	3670	1.5	132	48	4.94	197.6
TB-MBBP-13254	3967	1.5	132	54	5.62	225.1
TB-MBBP-13260	3992	1.5	132	60	6.32	252.62
TB-MBBP-14448	3796	1.5	144	48	5.4	215.92
TB-MBBP-14454	4117	1.5	144	54	6.14	245.94
TB-MBBP-14460	4145	1.5	144	60	6.9	275.94
TB-MBBP-15648	3922	1.5	156	48	5.86	234.26
TB-MBBP-15654	4267	1.5	156	54	6.66	266.78
TB-MBBP-15660	4296	1.5	156	60	7.48	299.28
TB-MBBP-16848	4244	1.5	168	48	6.32	252.6
TB-MBBP-16854	4417	1.5	168	54	7.18	287.6
TB-MBBP-16860	4445	1.5	168	60	8.06	322.62
TB-MBBP-18048	4270	1.5	180	48	6.78	270.92
TB-MBBP-18054	4566	1.5	180	54	7.7	308.44
TB-MBBP-18060	4595	1.5	180	60	8.64	345.96
TB-MBBP-19248	4299	1.5	192	48	7.22	289.26
TB-MBBP-19254	4718	1.5	192	54	8.22	329.28
TB-MBBP-19260	4744	1.5	192	60	9.22	369.3
TB-MBBP-20448	5570	1.5	204	48	7.69	308.97
TB-MBBP-20454	6030	1.5	204	54	8.75	351.49
TB-MBBP-20460	6071	1.5	204	60	9.81	394.01
TB-MBBP-21648	5696	1.5	216	48	8.15	327.31
TB-MBBP-21654	6180	1.5	216	54	9.27	373.33
TB-MBBP-21660	6219	1.5	216	60	10.4	417.35
TB-MBBP-22848	5820	1.5	228	48	8.61	345.65
TB-MBBP-22854	6329	1.5	228	54	9.4	393.17
TB-MBBP-22860	6369	1.5	228	60	10.98	440.69
TB-MBBP-24048	6144	1.5	240	48	9.06	363.99
TB-MBBP-24054	6480	1.5	240	54	10.31	414.01
TB-MBBP-24060	6520	1.5	240	60	11.56	464.03

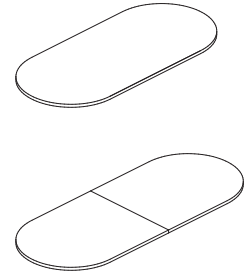

1.5" Racetrack Tabletop

How to Specify:

Each laminate comes with matching vinyl trim color unless otherwise specified on your purchase order. Refer to the laminate finish card for details.

Notes:

- Tabletops 72"-96"W are configured in one-piece top.
- Tabletops 108"-192"W are configured in two-piece tops.
- Tabletops 204"-240"W are configured in three-piece tops.

Options:

- laminate color
- edge profile

Code	Price	H	W	D	Volume (ft ³)	Weight (lb)
TB-MRRX-7236	746	1.5	72	36	2.01	80.37
TB-MRRX-7242	934	1.5	72	42	2.3	91.89
TB-MRRX-8436	858	1.5	84	36	2.38	95.38
TB-MRRX-8442	1015	1.5	84	42	2.73	109.4
TB-MRRX-8448	1081	1.5	84	48	3.07	122.88
TB-MRRX-9636	936	1.5	96	36	2.76	110.38
TB-MRRX-9642	1098	1.5	96	42	3.17	126.9
TB-MRRX-9648	1135	1.5	96	48	3.57	142.89
TB-MRRX-10848	1359	1.5	108	48	4.06	162.62
TB-MRRX-10854	1608	1.5	108	54	4.52	180.56
TB-MRRX-10860	1635	1.5	108	60	4.94	197.96
TB-MRRX-12048	1486	1.5	120	48	4.56	182.6
TB-MRRX-12054	1756	1.5	120	54	5.08	203.06

Code	Price	H	W	D	Volume (ft ³)	Weight (lb)
TB-MRRX-12060	1783	1.5	120	60	5.58	222.98
TB-MRRX-13248	1609	1.5	132	48	5.06	202.62
TB-MRRX-13254	1906	1.5	132	54	5.64	225.58
TB-MRRX-13260	1934	1.5	132	60	6.2	247.98
TB-MRRX-14448	1735	1.5	144	48	5.56	222.64
TB-MRRX-14454	2057	1.5	144	54	6.2	248.08
TB-MRRX-14460	2085	1.5	144	60	6.82	273
TB-MRRX-15648	1863	1.5	156	48	6.06	242.64
TB-MRRX-15654	2209	1.5	156	54	6.76	270.6
TB-MRRX-15660	2235	1.5	156	60	7.44	298.02
TB-MRRX-16848	2181	1.5	168	48	6.56	262.66
TB-MRRX-16854	2357	1.5	168	54	7.32	293.1
TB-MRRX-16860	2384	1.5	168	60	8.08	323.02
TB-MRRX-18048	2212	1.5	180	48	7.06	282.66
TB-MRRX-18054	2507	1.5	180	54	7.88	315.62
TB-MRRX-18060	2537	1.5	180	60	8.7	348.04
TB-MRRX-19248	2237	1.5	192	48	7.56	302.66
TB-MRRX-19254	2659	1.5	192	54	8.44	338.12
TB-MRRX-19260	2685	1.5	192	60	9.32	373.04
TB-MRRX-20448	2482	1.5	204	48	8.06	322.58
TB-MRRX-20454	2940	1.5	204	54	9.01	360.53
TB-MRRX-20460	2980	1.5	204	60	9.94	397.95
TB-MRRX-21648	2606	1.5	216	48	8.56	342.59
TB-MRRX-21654	3089	1.5	216	54	9.57	383.04
TB-MRRX-21660	3131	1.5	216	60	10.56	422.97
TB-MRRX-22848	2732	1.5	228	48	9.06	362.59
TB-MRRX-22854	3240	1.5	228	54	10.13	405.55
TB-MRRX-22860	3280	1.5	228	60	11.19	447.97
TB-MRRX-24048	3054	1.5	240	48	9.56	382.6
TB-MRRX-24054	3389	1.5	240	54	10.7	428.06
TB-MRRX-24060	3431	1.5	240	60	11.82	472.98



1.5" Racetrack Tabletop w/Power and Data

How to Specify:

Each laminate comes with matching vinyl trim color unless otherwise specified on your purchase order. Refer to the laminate finish card for details.

Notes:

Tabletops 72"-96"W are configured in one-piece top.

Tabletops 108"-192"W are configured in two-piece tops.

Tabletops 204"-240"W are configured in three-piece tops.

Single-piece tabletops are equipped with one power and data grommet, two-piece tabletops are equipped with two power and data grommets, and three-piece tabletops are equipped with three power and data grommets.

Two power and dual USB-A receptacles with 3 open slots to accommodate RJ11, RJ45, HDMI, VGA or Stereo. Items for 3 open slots must be specified and purchased separately.

Boardroom tables with tops comprised of 2 or more pieces will not have a consistent grain pattern.

Options:

laminate color

edge profile

grommet color (for tabletops with power and data)

Code	Price	H	W	D	Volume (ft ³)	Weight (lb)
TB-MRRP-7236	1775	1.5	72	36	1.96	78.44
TB-MRRP-7242	1964	1.5	72	42	2.25	89.96
TB-MRRP-8436	1889	1.5	84	36	2.34	93.45
TB-MRRP-8442	2045	1.5	84	42	2.69	107.47
TB-MRRP-8448	2113	1.5	84	48	3.02	120.95
TB-MRRP-9636	1968	1.5	96	36	2.71	108.46
TB-MRRP-9642	2129	1.5	96	42	3.12	124.98
TB-MRRP-9648	2166	1.5	96	48	3.52	140.96
TB-MRRP-10848	3420	1.5	108	48	3.96	158.76
TB-MRRP-10854	3669	1.5	108	54	4.42	176.7
TB-MRRP-10860	3697	1.5	108	60	4.86	194.12
TB-MRRP-12048	3544	1.5	120	48	4.46	178.76
TB-MRRP-12054	3818	1.5	120	54	4.98	199.22

Code	Price	H	W	D	Volume (ft ³)	Weight (lb)
TB-MRRP-12060	3843	1.5	120	60	5.48	219.12
TB-MRRP-13248	3670	1.5	132	48	4.96	198.78
TB-MRRP-13254	3967	1.5	132	54	5.54	221.72
TB-MRRP-13260	3992	1.5	132	60	6.1	244.14
TB-MRRP-14448	3796	1.5	144	48	5.46	218.78
TB-MRRP-14454	4117	1.5	144	54	6.1	244.24
TB-MRRP-14460	4145	1.5	144	60	6.72	269.14
TB-MRRP-15648	3922	1.5	156	48	5.96	238.78
TB-MRRP-15654	4267	1.5	156	54	6.66	266.74
TB-MRRP-15660	4296	1.5	156	60	7.36	294.16
TB-MRRP-16848	4244	1.5	168	48	6.46	258.8
TB-MRRP-16854	4417	1.5	168	54	7.22	289.24
TB-MRRP-16860	4445	1.5	168	60	7.98	319.16
TB-MRRP-18048	4270	1.5	180	48	6.96	278.8
TB-MRRP-18054	4566	1.5	180	54	7.8	311.76
TB-MRRP-18060	4595	1.5	180	60	8.6	344.18
TB-MRRP-19248	4299	1.5	192	48	7.46	298.82
TB-MRRP-19254	4718	1.5	192	54	8.36	334.24
TB-MRRP-19260	4744	1.5	192	60	9.22	369.18
TB-MRRP-20448	5570	1.5	204	48	7.97	320.19
TB-MRRP-20454	6030	1.5	204	54	8.92	358.15
TB-MRRP-20460	6071	1.5	204	60	9.85	395.57
TB-MRRP-21648	5696	1.5	216	48	8.47	340.2
TB-MRRP-21654	6180	1.5	216	54	9.48	380.66
TB-MRRP-21660	6219	1.5	216	60	10.48	420.58
TB-MRRP-22848	5820	1.5	228	48	8.97	360.21
TB-MRRP-22854	6329	1.5	228	54	10.04	403.17
TB-MRRP-22860	6369	1.5	228	60	11.1	445.59
TB-MRRP-24048	6144	1.5	240	48	9.47	380.22
TB-MRRP-24054	6480	1.5	240	54	10.61	425.68
TB-MRRP-24060	6520	1.5	240	60	11.73	470.6

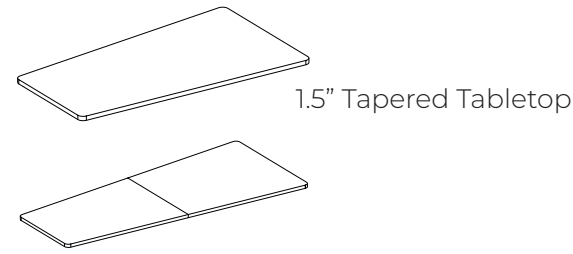

1.5" Tapered Tabletop

How to Specify:

Each laminate comes with matching vinyl trim color unless otherwise specified on your purchase order. Refer to the laminate finish card for details.

Notes:

- Tabletops 72"-96"W are configured in one-piece top.
- Tabletops 108"-192"W are configured in two-piece tops.
- Tabletops 204"-240"W are configured in three-piece tops.

Options:

- laminate color
- edge profile
- grommet color (for tabletops with power and data)

Code	Price	H	W	D	Volume (ft ³)	Weight (lb)
TB-MTTX-844836	1086	1.5	84	48	3.06	122.43
TB-MTTX-964836	1113	1.5	96	48	3.5	139.93
TB-MTTX-1085436	1586	1.5	108	54	4.21	168.5
TB-MTTX-1086042	1613	1.5	108	60	4.77	191.01
TB-MTTX-1205436	1735	1.5	120	54	4.68	187.26
TB-MTTX-1206042	1763	1.5	120	60	5.3	212.27
TB-MTTX-1326042	1913	1.5	132	60	5.84	233.53
TB-MTTX-1446042	2065	1.5	144	60	6.37	254.79
TB-MTTX-1326648	2078	1.5	132	66	6.52	260.85
TB-MTTX-1447254	2417	1.5	144	72	7.86	314.62
TB-MTTX-1687254	2878	1.5	168	72	9.17	367.14
TB-MTTX-1927860	3446	1.5	192	78	11.48	459.49
TB-MTTX-2167860	4082	1.5	216	78	12.92	517.01
TB-MTTX-2406048	3352	1.5	240	60	11.23	449.49



1.5" Tapered Tabletop w/Power and Data

How to Specify:

Each laminate comes with matching vinyl trim color unless otherwise specified on your purchase order. Refer to the laminate finish card for details.

Notes:

- Tabletops 72"-96"W are configured in one-piece top.
- Tabletops 108"-192"W are configured in two-piece tops.
- Tabletops 204"-240"W are configured in three-piece tops.
- Single-piece tabletops are equipped with one power and data grommet, two-piece tabletops are equipped with two power and data grommets, and three-piece tabletops are equipped with three power and data grommets.
- Two power and dual USB-A receptacles with 3 open slots to accommodate RJ11, RJ45, HDMI, VGA or Stereo. Items for 3 open slots must be specified and purchased separately.
- Boardroom tables with tops comprised of 2 or more pieces will not have a consistent grain pattern.

Options:

- laminate color
- edge profile
- grommet color (for tabletops with power and data)

Code	Price	H	W	D	Volume (ft ³)	Weight (lb)
TB-MTTP-1085436	3643	1.5	108	54	4.15	166.91
TB-MTTP-1086042	3673	1.5	108	60	4.71	189.42
TB-MTTP-1205436	3794	1.5	120	54	4.62	185.67
TB-MTTP-1206042	3821	1.5	120	60	5.24	210.68
TB-MTTP-1326042	3982	1.5	132	60	5.78	231.94
TB-MTTP-1446042	4122	1.5	144	60	6.31	253.2
TB-MTTP-844836	2115	1.5	84	48	3.01	120.53
TB-MTTP-964836	2143	1.5	96	48	3.45	138
TB-MTTP-1326648	4137	1.5	132	66	6.46	259.26
TB-MTTP-1447254	4475	1.5	144	72	7.8	313.03
TB-MTTP-1687254	4934	1.5	168	72	9.11	365.55
TB-MTTP-1927860	6535	1.5	192	78	11.39	457.11
TB-MTTP-2167860	7171	1.5	216	78	12.83	514.63
TB-MTTP-2406048	6441	1.5	240	60	11.14	447.1



Notes:

Refer to page 230 for base configuration requirements for selected tabletops

Options:

laminate color

metal color (for post support base)

for Straight/Boat Tabletops

Code	Price	H	W	D	Volume (ft ³)	Weight (lb)
TB-B4-7236	507	28	42	21	14.29	41.45
TB-B4-7242	507	28	42	24	16.33	52.15
TB-B4-8436	507	28	54	21	18.38	44.55
TB-B4-8442	519	28	54	24	21	55.89
TB-B4-8448	567	28	42	84	1.27	51.53
TB-B4-9636	519	28	30	96	1.07	43.54
TB-B4-9642	548	28	36	96	1.16	47.38
TB-B4-9648	614	28	66	30	32.08	63.75
TB-B4-10848	867	28	77	30	37.43	67.75
TB-B4-10854	953	28	54	108	2.18	88.49
TB-B4-10860	1036	28	60	108	2.47	100
TB-B4-12048	902	28	89	30	43.26	71.99
TB-B4-12054	990	28	54	120	2.26	91.82
TB-B4-12060	1074	28	60	120	2.55	103.34
TB-B4-13248	939	28	101	30	49.1	76.23
TB-B4-13254	1025	28	54	132	2.35	95.16
TB-B4-13260	1106	28	60	132	2.63	106.67
TB-B4-14448	981	28	113	30	54.93	80.47

Code	Price	H	W	D	Volume (ft ³)	Weight (lb)
TB-B4-14454	1068	28	54	144	2.43	98.88
TB-B4-14460	1150	28	60	144	2.72	110.4
TB-B4-15648	1018	28	48	156	2.23	90.7
TB-B4-15654	1102	28	54	156	2.51	102.22
TB-B4-15660	1186	28	60	156	2.8	113.73
TB-B4-16848	1054	28	48	168	2.31	94.04
TB-B4-16854	1140	28	54	168	2.6	105.55
TB-B4-16860	1222	28	60	168	2.89	117.07
TB-B4-18048	1090	28	48	180	2.39	97.37
TB-B4-18054	1177	28	54	180	2.59	108.98
TB-B4-18060	1260	28	60	180	2.97	120.4
TB-B4-19248	1126	28	48	192	2.48	100.71
TB-B4-19254	1213	28	54	192	2.76	112.22
TB-B4-19260	1296	28	60	192	3.05	123.74
TB-B4-20448	1379	28	48	204	3	122.06
TB-B4-20454	1496	28	54	204	3.39	137.42
TB-B4-20460	1604	28	60	204	3.77	152.77
TB-B4-21648	1420	28	48	216	3.09	125.79
TB-B4-21654	1537	28	54	216	3.47	141.14
TB-B4-21660	1643	28	60	216	3.85	156.5
TB-B4-22848	1459	28	48	228	3.17	129.13
TB-B4-22854	1573	28	54	228	3.55	144.48
TB-B4-22860	1681	28	60	228	3.98	159.84
TB-B4-24048	1495	28	48	240	3.25	132.46
TB-B4-24054	1609	28	54	240	3.64	147.81
TB-B4-24060	1719	28	60	240	4.02	163.17

for Racetrack Top

Code	Price	H	W	D	Volume (ft ³)	Weight (lb)
TB-B4-8448R	554	28	48	84	1.24	50.41
TB-B4-9648R	594	28	48	96	1.33	53.95
TB-B4-10848R	854	28	48	108	1.86	75.86
TB-B4-10854R	928	28	54	108	2.12	86.26
TB-B4-10860R	999	28	60	108	2.38	96.67
TB-B4-12048R	890	28	48	120	1.95	79.19
TB-B4-12054R	963	28	54	120	2.21	89.6
TB-B4-12060R	1036	28	60	120	2.47	100
TB-B4-13248R	928	28	48	132	2.03	82.53
TB-B4-13254R	1000	28	54	132	2.29	92.93
TB-B4-13260R	1074	28	60	132	2.55	103.34
TB-B4-14448R	968	28	48	144	2.12	86.26
TB-B4-14454R	1041	28	54	144	2.38	96.66
TB-B4-14460R	1110	28	60	144	2.63	106.67
TB-B4-15648R	1002	28	48	156	2.2	89.59
TB-B4-15654R	1078	28	54	156	2.46	99.99
TB-B4-15660R	1150	28	60	156	2.72	110.4
TB-B4-16848R	1041	28	48	168	2.28	92.92
TB-B4-16854R	1114	28	54	168	2.54	103.33
TB-B4-16860R	1186	28	60	168	2.8	113.73
TB-B4-18048R	1078	28	48	180	2.37	96.26
TB-B4-18054R	1152	28	54	180	2.63	106.66
TB-B4-18060R	1222	28	60	180	2.89	117.07
TB-B4-19248R	1113	28	48	192	2.48	99.59
TB-B4-19254R	1187	28	54	192	2.71	110
TB-B4-19260R	1260	28	60	192	2.97	120.4
TB-B4-20448R	1366	28	48	204	2.95	120.97
TB-B4-20454R	1471	28	54	204	3.33	135.19
TB-B4-20460R	1565	28	60	204	3.69	149.44
TB-B4-21648R	1407	28	48	216	3.06	124.68
TB-B4-21654R	1509	28	54	216	3.41	138.92
TB-B4-21660R	1607	28	60	216	3.77	152.77
TB-B4-22848R	1442	28	48	228	3.14	128.01
TB-B4-22854R	1548	28	54	228	3.5	142.26
TB-B4-22860R	1643	28	60	228	3.85	156.5
TB-B4-24048R	1481	28	48	240	3.23	131.35
TB-B4-24054R	1585	28	54	240	3.58	145.59
TB-B4-24060R	1681	28	60	240	3.94	159.83

for Tapered Tabletop

Code	Price	H	W	D	Volume (ft ³)	Weight (lb)
TB-B4-844836T	527	28	48	84	1.13	45.77
TB-B4-964836T	563	28	48	96	1.21	19.3
TB-B4-1085436T	851	28	54	108	1.81	73.77
TB-B4-1205436T	888	28	54	120	1.9	77.11
TB-B4-1086042T	921	28	60	108	2.04	82.73
TB-B4-1206042T	956	28	60	120	2.12	86.06
TB-B4-1326042T	992	28	60	132	2.2	89.4
TB-B4-1326648T	1492	28	66	132	2.47	100.56
TB-B4-1447254T	1637	28	72	144	2.65	108
TB-B4-1687254T	1737	28	72	168	2.83	115.44
TB-B4-1927860T	2048	28	78	192	3.01	122.88
TB-B4-2167860T	2125	28	78	216	5.22	211.32
TB-B4-2406048T	1855	28	60	240	4.19	170.01

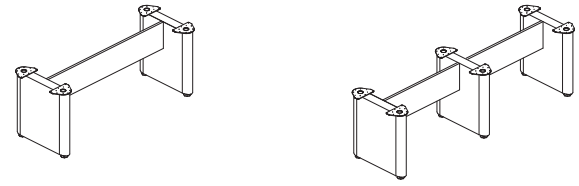

Elliptical Base

Notes:

Refer to page [230](#) for base configuration requirements for selected tabletops

Options:

laminate color

metal color

for Tapered Tabletop

Code	Price	H	W	D	Volume (ft ³)	Weight (lb)
TB-B5-844836T	1467	28	48	84	1.09	66.33
TB-B5-964836T	1503	28	48	96	1.17	69.86
TB-B5-1085436T	2218	28	54	108	1.81	106.9
TB-B5-1086042T	2354	28	60	108	2.21	123.15
TB-B5-1205436T	2252	28	54	120	1.89	110.23
TB-B5-1206042T	2386	28	60	120	2.3	126.49
TB-B5-1326042T	2422	28	60	132	2.38	129.82
TB-B5-1326648T	2542	28	66	132	2.46	133.15
TB-B5-1446042T	2461	28	60	144	2.54	133.5
TB-B5-1447254T	3417	28	72	144	2.7	134.2
TB-B5-1687254T	3658	28	72	168	2.86	134.9
TB-B5-1927860T	4189	28	78	192	3.02	135.6
TB-B5-2167860T	4453	28	78	216	3.97	205.04
TB-B5-2406048T	4232	28	60	240	4.13	212.1

for Racetrack Tabletop

Code	Price	H	W	D	Volume (ft ³)	Weight (lb)
TB-B5-8448R	1486	28	48	84	1.19	70.64
TB-B5-9648R	1522	28	48	96	1.28	74.17
TB-B5-10848R	2242	28	48	108	1.78	105.79
TB-B5-10854R	2314	28	54	108	2.16	120.93
TB-B5-10860R	2437	28	60	108	2.54	136.08
TB-B5-12048R	2278	28	48	120	1.86	109.12
TB-B5-12054R	2349	28	54	120	2.24	124.27
TB-B5-12060R	2473	28	60	120	2.62	139.41
TB-B5-13248R	2312	28	48	132	1.95	112.45
TB-B5-13254R	2382	28	54	132	2.33	127.6
TB-B5-13260R	2507	28	60	132	2.7	142.75
TB-B5-14448R	2261	28	48	144	2.03	116.18
TB-B5-14454R	2343	28	54	144	2.41	130.93
TB-B5-14460R	2541	28	60	144	2.79	146.08
TB-B5-15648R	2383	28	48	156	2.12	119.52
TB-B5-15654R	2454	28	54	156	2.49	134.66
TB-B5-15660R	2578	28	60	156	2.87	149.81
TB-B5-16848R	2418	28	48	168	2.2	122.85
TB-B5-16854R	2488	28	54	168	2.58	138
TB-B5-16860R	2614	28	60	168	2.96	153.14
TB-B5-18048R	2452	28	48	180	2.28	126.19
TB-B5-18054R	2521	28	54	180	2.66	141.33
TB-B5-18060R	2642	28	60	180	3.04	156.48
TB-B5-19248R	2485	28	48	192	2.37	129.52
TB-B5-19254R	2556	28	54	192	2.74	144.67
TB-B5-19260R	2683	28	60	192	3.12	159.81
TB-B5-20448R	3772	28	48	204	2.85	160.58
TB-B5-20454R	3864	28	54	204	3.37	181.14
TB-B5-20460R	4029	28	60	204	3.88	201.71
TB-B5-21648R	3699	28	48	216	2.94	164.31
TB-B5-21654R	3812	28	54	216	3.45	184.48
TB-B5-21660R	4084	28	60	216	3.97	205.04
TB-B5-22848R	3879	28	48	228	3.02	167.64
TB-B5-22854R	3970	28	54	228	3.54	188.2
TB-B5-22860R	4134	28	60	228	4.05	208.77
TB-B5-24048R	3928	28	48	240	3.11	170.97
TB-B5-24054R	4024	28	54	240	3.62	191.54
TB-B5-24060R	4186	28	60	240	4.13	212.1

for Straight/Boat Tabletops

Code	Price	H	W	D	Volume (ft ³)	Weight (lb)
TB-B5-7236	1335	28	36	72	0.87	57.58
TB-B5-7242	1382	28	42	72	1	63
TB-B5-8436	1368	28	36	84	0.95	60.91
TB-B5-8442	1416	28	42	84	1.09	66.33
TB-B5-8448	1497	28	84	48	1.22	71.75
TB-B5-9636	1405	28	36	96	1.03	64.45
TB-B5-9642	1451	28	42	96	1.17	69.86
TB-B5-9648	1532	28	48	96	1.3	75.3
TB-B5-10848	2253	28	48	108	1.81	106.9
TB-B5-10854	2338	28	54	108	2.21	123.15
TB-B5-10860	2473	28	60	108	2.62	139.41
TB-B5-12048	2288	28	48	120	1.89	110.23
TB-B5-12054	2372	28	54	120	2.3	126.49
TB-B5-12060	2507	28	60	120	2.7	142.75
TB-B5-13248	2321	28	48	132	1.97	113.57
TB-B5-13254	2405	28	54	132	2.38	129.82
TB-B5-13260	2541	28	60	132	2.79	146.08
TB-B5-14448	2360	28	48	144	2.06	117.29
TB-B5-14454	2442	28	54	144	2.47	133.55
TB-B5-14460	2578	28	60	144	2.87	149.81
TB-B5-15648	2395	28	48	156	2.14	120.63
TB-B5-15654	2478	28	54	156	2.55	136.88
TB-B5-15660	2614	28	60	156	2.96	153.14
TB-B5-16848	2424	28	48	168	2.23	123.96
TB-B5-16854	2508	28	54	168	2.63	140.22

Code	Price	H	W	D	Volume (ft ³)	Weight (lb)
TB-B5-16860	2642	28	60	168	3.04	156.48
TB-B5-18048	2463	28	48	180	2.31	127.3
TB-B5-18054	2544	28	54	180	2.72	143.55
TB-B5-18060	2683	28	60	180	3.12	159.81
TB-B5-19248	2495	28	48	192	2.39	130.63
TB-B5-19254	2578	28	54	192	2.8	146.89
TB-B5-19260	2717	28	60	192	3.21	163.15
TB-B5-20448	3786	28	48	204	2.88	161.69
TB-B5-20454	3900	28	54	204	3.42	183.37
TB-B5-20460	4081	28	60	204	3.97	205.04

Tabletop Sizes **Post Support**



72" x 36"	4
84" x 36"	4
72" x 42"	4
84" x 42"	4
96" x 48"	4



108" x 48"	6
120" x 48"	6
132" x 48"	6
144" x 48"	6



T-RJ45



T-RJ11



T-VGA



T-STEREO

Code	Price
T-RJ45	191
T-RJ11	73
T-HDMI	185
T-VGA	230
T-STEREO	48

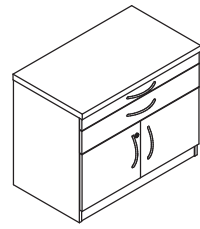

1.5" Serving Cabinet

How to Specify:

Each laminate comes with matching vinyl trim color unless otherwise specified on your purchase order. Refer to the laminate finish card for details.

Notes:

Cabinets and lateral files include lock and keys.

Options:

laminate color

edge profile

handle color

handle style

Code	Price	H	W	D	Volume (ft ³)	Weight (lb)
TB-FCS0-3021	1521	29.5	30	21	16.48	110.08
TB-FCS0-3621	2056	29.5	36	21	19.39	123.75



1.5" Storage Cabinet w/Shelves, LH Shown

How to Specify:

Each laminate comes with matching vinyl trim color unless otherwise specified on your purchase order. Refer to the laminate finish card for details.

Notes:

Cabinets and lateral files include lock and keys.

Options:

laminate color

edge profile

handle color

handle style

Code	Price	H	W	D	Volume (ft ³)	Weight (lb)
TB-FSDS-1821-L	1374	78	18	21	26.1	146.7
TB-FSDS-1821-R	1374	78	18	21	26.1	146.7

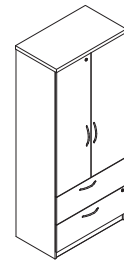

1.5" Combo Cabinet w/Storage and Lateral Files

How to Specify:

Each laminate comes with matching vinyl trim color unless otherwise specified on your purchase order. Refer to the laminate finish card for details.

Notes:

Cabinets and lateral files include lock and keys.

Options:

- laminate color _____
- edge profile _____
- handle color _____
- handle style _____

Code	Price	H	W	D	Volume (ft ³)	Weight (lb)
TB-FCSL-3621	2555	78	36	21	47.45	279.9

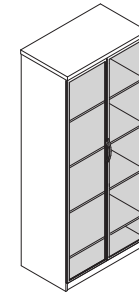

1.5" Double Door Storage Cabinet w/Shelves and Acrylic Doors

How to Specify:

Each laminate comes with matching vinyl trim color unless otherwise specified on your purchase order. Refer to the laminate finish card for details.

Notes:

Options:

- laminate color _____
- edge profile _____
- handle color _____
- handle style _____
- metal color (for doors) _____
- acrylic color (for doors) _____

Code	Price	H	W	D	Volume (ft ³)	Weight (lb)
TB-FSDS-3621-G	3662	78	36	21	47.45	225.45

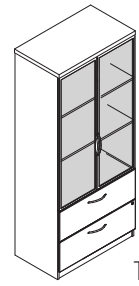

1.5" Combo Cabinet w/Storage, Lateral Files and Acrylic Doors

How to Specify:

Each laminate comes with matching vinyl trim color unless otherwise specified on your purchase order. Refer to the laminate finish card for details.

Notes:

There are no locks for acrylic doors.

Options:

- laminate color _____
- edge profile _____
- handle color _____
- handle style _____
- metal color (for acrylic doors) _____
- acrylic color (for acrylic doors) _____

Code	Price	H	W	D	Volume (ft ³)	Weight (lb)
TB-FCSL-3621-G	4114	78	36	21	47.45	278.1

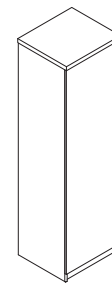

1.5" Storage Cabinet w/Coat Bar and Shelves, LH Shown

How to Specify:

Each laminate comes with matching vinyl trim color unless otherwise specified on your purchase order. Refer to the laminate finish card for details.

Notes:

Cabinets and lateral files include lock and keys.

Options:

- laminate color _____
- edge profile _____
- handle color _____
- handle style _____

Code	Price	H	W	D	Volume (ft ³)	Weight (lb)
TB-FSDC-2421-L	1478	78	24	21	13.22	194.4
TB-FSDC-2421-R	1478	78	24	21	13.22	194.4

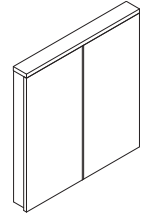

1.5" Whiteboard Cabinet

How to Specify:

Each laminate comes with matching vinyl trim color unless otherwise specified on your purchase order. Refer to the laminate finish card for details.

Options:

- laminate color

- edge profile (for whiteboard cabinet and mobile media center)

- tackboard fabric (for whiteboard cabinet)

Code	Price	H	W	D	Volume (ft ³)	Weight (lb)
TB-VB00-4850	1608	51	48	5.6	7.93	112.95

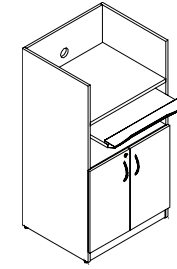

1" Computer Desk with 1.5" top

How to Specify:

Each laminate comes with matching vinyl trim color unless otherwise specified on your purchase order. Refer to the laminate finish card for details.

Options:

- laminate color

- edge profile

- handle color

- handle style

- grommet color

Notes:

Comes with locks for cabinets.

Code	Price	H	W	D	Volume (ft ³)	Weight (lb)
U-TCDS-542824	3787	54	28	24	21	80



Metro Pricebook
February 2023
Accessories

accessories

<u>keyboard tray</u>	242
<u>tackboard for hutch</u>	243
<u>pencil drawer</u>	244
<u>task light</u>	245
<u>monitor arm</u>	246
<u>wire manager</u>	247

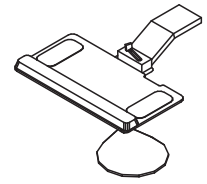

Articulating Keyboard Tray w/Mouse Tray

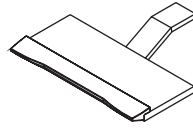

Articulating Laminate Keyboard Tray

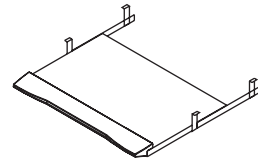

Retractable Laminate Keyboard Tray

How to Specify:

Each laminate comes with matching vinyl trim color unless otherwise specified on your purchase order. Refer to the laminate finish card for details.

Notes:

All keyboard trays include palm rests.

Options:

laminate color (for laminate keyboard trays)

Code	Price	H	W	D	Volume (ft ³)	Weight (lb)
Articulating Keyboard Tray w/Mouse Tray - Available in black only and with built-in mouse tray:						
V-KAS0-2011-L	593	0	20	11	0	3
V-KAS0-2011-R	593	0	20	11	0	3
Articulating Laminate Keyboard Tray						
V-KAS0-2510	593	0	25	10	0	15
Retractable Laminate Keyboard Tray						
V-KRS0-2516	249	0	25	16	0	12

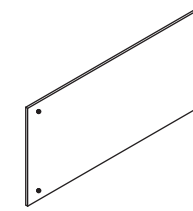

14"H Tackboard for Hutch w/Pigeonholes

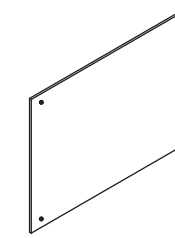

21"H Tackboard for Hutch without Pigeonholes

Options:

fabric color (for tackboard)

Code	Price	H	W	D	Volume (ft ³)	Weight (lb)
14"H Tackboard for Hutch w/Pigeonholes						
V-ATH0-1427	210	14	27	0.5	0.81	1.7
V-ATH0-1433	222	14	33	0.5	0.96	2.1
V-ATH0-1439	230	14	39	0.5	1.12	2.5
V-ATH0-1445	241	14	45	0.5	1.28	2.9
V-ATH0-1451	250	14	51	0.5	1.43	3.3
V-ATH0-1457	255	14	57	0.5	1.59	3.7
V-ATH0-1463	266	14	63	0.5	1.74	4.1
V-ATH0-1469	278	14	69	0.5	1.9	4.5
V-ATH0-1475	305	14	75	0.5	2.06	4.9
V-ATH0-1481	349	14	81	0.5	2.21	5.4
21"H Tackboard for Hutch without Pigeonholes						
V-ATH0-2127	290	21	27	0.5	1.12	2.7
V-ATH0-2133	304	21	33	0.5	1.34	3.1
V-ATH0-2139	333	21	39	0.5	1.56	3.5
V-ATH0-2145	361	21	45	0.5	1.77	3.9
V-ATH0-2151	392	21	51	0.5	1.99	4.3
V-ATH0-2157	432	21	57	0.5	2.21	4.7
V-ATH0-2163	473	21	63	0.5	2.42	5.1
V-ATH0-2169	527	21	69	0.5	2.64	5.5
V-ATH0-2175	542	21	75	0.5	2.86	5.9
V-ATH0-2181	564	21	81	0.5	3.07	6.3

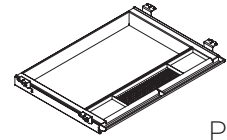

Plastic Pencil Drawer

Notes:

Plastic Pencil Drawers are available in black only.

Code	Price	H	W	D	Volume (ft ³)	Weight (lb)
V-ADPP	83	2.8	21	16	0.62	2

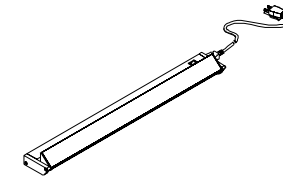

Task Light

Notes:

Task light comes in black finish.

Code	Price	H	W	D	Volume (ft ³)	Weight (lb)
V-ELU-24	285	0	24.53	0	0	9.5
V-ELU-36	321	0	36.39	0	0	13.7
V-ELU-48	403	0	48.15	0.15	0	17.9

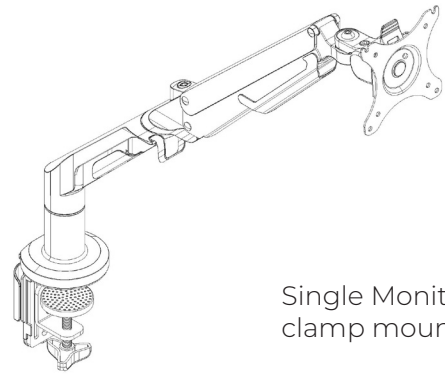

Single Monitor Arm - clamp mount

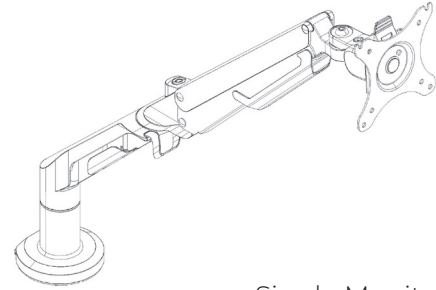

Single Monitor Arm - grommet mount

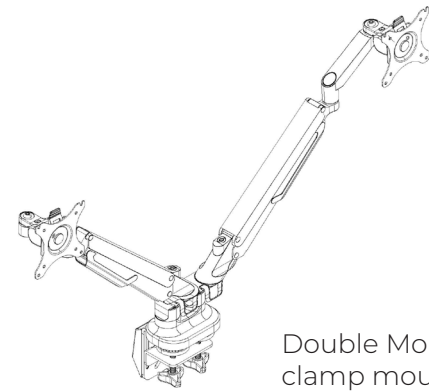

Double Monitor Arm - clamp mount

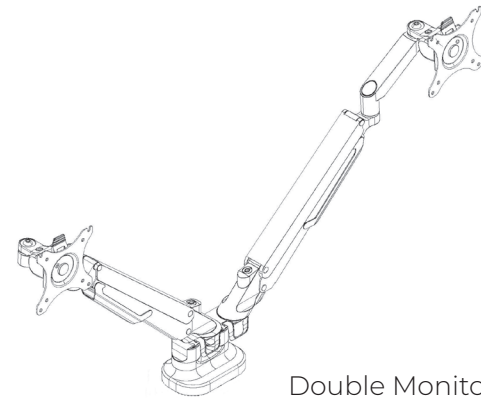

Double Monitor Arm - grommet mount

What's Included:

One monitor arm and installation hardware for both clamp and grommet mount

How to Specify:

- Specify type

Dimensions:

Vesa: 75x75 and 100x100

Code	Price
Monitor Arm - Single Mount	
V-AFMA-01	353
Monitor Arm - Double Mount	
V-AFMA-02	589

Notes:

Available in silver and black

Single Monitor Arm

- Screen Size - 17"-36"
- Load Capacity - 6.6-26.4lbs/3-12kg
- Tilt Range - -90 degrees - -15 degrees

Dual Monitor Arm

- Screen Size - 17"-32"
- Load Capacity - 4.4-19.8lbs/2-9kg
- Tilt Range - -90 degrees - -15 degrees



Vertical Wire Manager

Notes:

Wire manager is available in silver only.

Code	Price	H	W	D	Volume (ft ³)	Weight (lb)
V-EE00	300	28	4	4	0.25	1