

tayco®

Cosmo
pricebook

March 2017

cosmopolitan | table of contents

Overview	4 7
cosmopolitan line-up	4
Introduction	8 14
product overview	9
features and benefits	10
variable height panel combinations	11
maximum span of panels	12
electrical cable length calculation	13
storage capacity	14
handle options	14
Panel Frames and Connectors	15 50
Tiles	51 73
Worksurfaces	74 126
Worksurfaces Supports	127 140
Mounted Storage	141 156
Freestanding Storage	157 200
Accessories	201 237
Electrics, Communication, Lighting	238 255

Cosmopolitan line-up

Panel Frames and Connectors

standard panel frame full acrylic panel frame countertop capability regular stack-on frame door stack-on frame panel door acrylic sliding door lockable acrylic sliding door

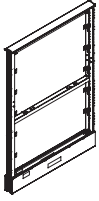

h = 37" - 85"
w = 18" - 60"

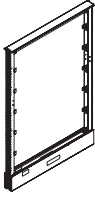

h = 37" - 85"
w = 18" - 60"

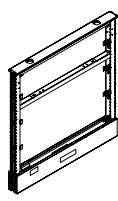

single panel
h = 37" - 45"
w = 24" - 60"

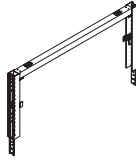

h = 8", 16", 24"
w = 18" - 60"



h = 8", 16", 24"
w = 36" - 42"



h = 85"
w = 36", 42"

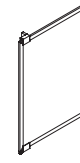

h = 61" - 69"
w = 30" - 42"

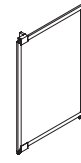

h = 61" - 69"
w = 30" - 42"

full end trim



h = 37" - 109"

partial end trim



h = 8" - 72"

full 90-degree filler



h = 37" - 109"

partial 90-degree filler



h = 8" - 72"

full 180-degree connection filler



h = 37" - 109"

partial 180-degree connector



h = 8" - 72"

full t-connection filler



h = 37" - 109"

partial t-connection filler



h = 8" - 72"

full 135-degree 2-way connector



h = 37" - 109"

full 120-degree 2-way connector



h = 37" - 109"

partial 120-degree 2-way connector



h = 8" - 72"

full 120-degree 3-way connector



h = 37" - 109"

full 4-way connector



h = 37" - 109"

wall to panel connector



h = 37" - 109"
Type 1, 2, 3

floor grippers



floor



carpet

Tiles

acoustic tackable fabric tile

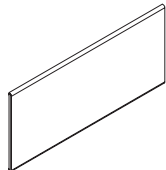

h = 8" - 24"
w = 18" - 60"

monolithic fabric tile

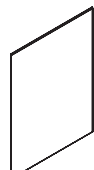

h = 32" - 80"
w = 18" - 60"

acrylic tile

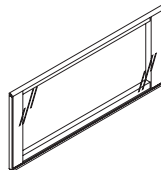

h = 8" - 24"
w = 18" - 60"

lamine tile

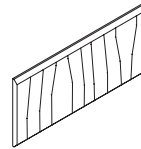

h = 8" - 24"
w = 18" - 60"

monolithic laminate tile



h = 32" - 80"
w = 18" - 60"

perforated metal tile

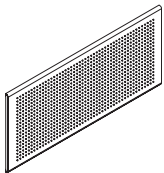

h = 8" - 24"
w = 18" - 60"

whiteboard tile

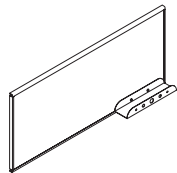

h = 16" - 24"
w = 18" - 60"

magnetic whiteboard tile

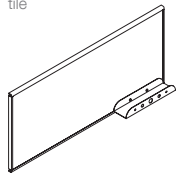

h = 16" - 24"
w = 18" - 60"

accessory tile

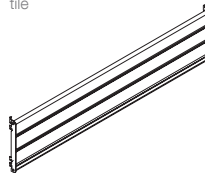

h = 8"
w = 18" - 60"

pass-through tile

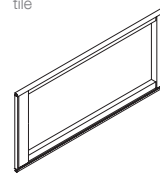

h = 8", 16", 24"
w = 18" - 60"

belt-line access tile

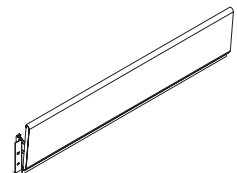

h = 8"
w = 18" - 60"

Cosmopolitan line-up

Worksurfaces

straight worksurface

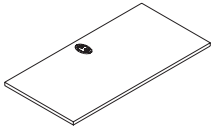

w = 18" - 96"
d = 18" - 36"

straight worksurface

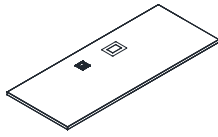

w = 36" - 96"
d = 24" - 30"

wave return worksurface

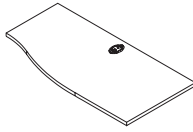

w = 30" - 96"
d = 24" - 36"

extended corner with curved front

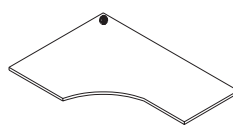

w = 36" - 48"
d = 18" - 30"
l = 42" - 60"

135-degree worksurface with curved front



w = 24" - 36"
d = 18" - 30"

120-degree worksurface with curved front



w = 24" - 36"
d = 18" - 30"

5-sided corner worksurface with curved front

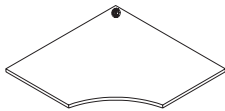

w = 36" - 48"
d = 18" - 30"

6-sided corner worksurface

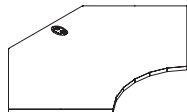

w = 24"
d = 24" - 30"

panel mounted d-table

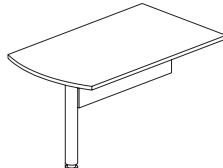

w = 60" - 84"
d = 30" - 36"

j-table

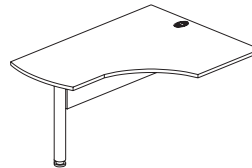

w = 60" - 78"
d = 24" - 30"

p-table

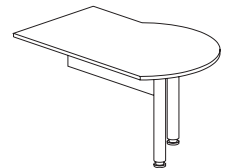

w = 60" - 84"
d = 30" - 36"

y-table

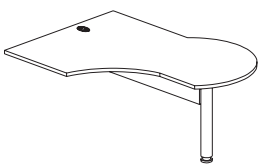

w = 60" - 84"
d = 24" - 30"

studio table worksurface

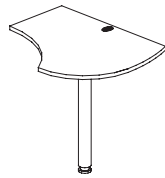

w = 36" - 42"
d = 18" - 30"

swing table worksurface

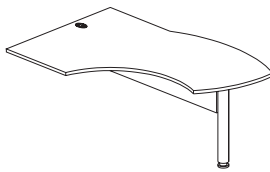

w = 66" - 78"
d = 24"

zoid table worksurface

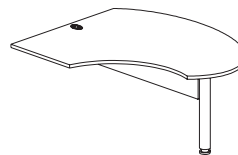

w = 60" - 78"
d = 24"

c-table extension

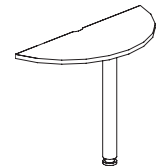

w = 39" - 63"
d = 16" - 26"

u-table extension

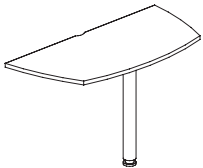

w = 39" - 63"
d = 18" - 28"

radiused straight worksurface

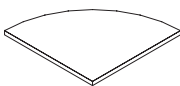

w = 24" - 30"
d = 24" - 30"

bridge worksurface

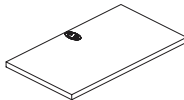

w = 24" - 48"
d = 18" - 30"

straight transition worksurface

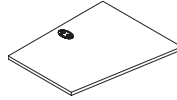

w = 30" - 96"
d1 = 24", d2 = 30"

tempered glass transaction top - straight

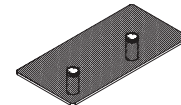

w = 24" - 54"
d = 12"

laminite countertop



w = 24" - 60"
d = 15"

Worksurface Supports
cantilever arm



d = 16" - 22"

laminite gable

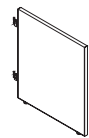

d = 12" - 36"

open metal gable

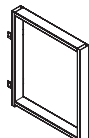

d = 12" - 30"

single post



horizontal surface support



d = 54" - 78"

universal bracket t-kit



Storage

panel-mounted flipper cabinet

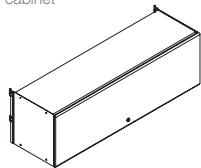

w = 30" - 60"
d = 14"

suspended flipper cabinet

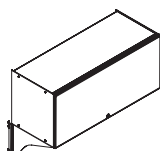

w = 30" - 60"
d = 14"

wall mounted flipper cabinet

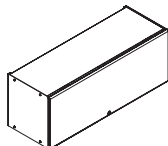

w = 30" - 60"
d = 14"

open metal shelf

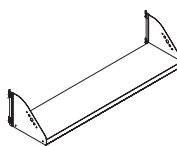

w = 24" - 60"
d = 12"

overhead back bracket



w = 24" - 60"

top mounted shared open shelf

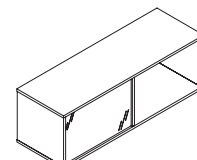

w = 30" - 87"
d = 16"

cubby storage

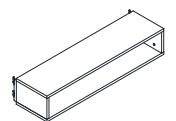

w = 24" - 48"
d = 11"

Cosmopolitan line-up

Storage

Open Storage Tower box/box/file file/file	box/box/file wardrobe	file/file wardrobe	Closed Storage Tower file/file left-hand	box/box/file left-hand	file/file wardrobe	box/box/file wardrobe	Storage Tower file/file/file	Cabinet coat bar	Double Cabinet with shelves	Combination Cabinet joined pedestal left-hand	lateral file
h = 66" w = 18" d = 21"	h = 66" w = 24" d = 21"	h = 66" w = 24" d = 21"	h = 66" w = 24" d = 21"	h = 66" w = 24" d = 21"	h = 66" w = 24" d = 21"	h = 66" w = 24" d = 21"	h = 42" w = 18" d = 21"	h = 66" w = 18" - 24" d = 21"	h = 66" w = 36" d = 21"	h = 66" w = 36" d = 21"	h = 66" w = 30" - 36" d = 21"

Freestanding Lateral File Cabinets	Underdesk Lateral File Cabinets	Freestanding Cabinets single door	double door	Underdesk Cabinets single door	double door	Freestanding Pedestals box/box/file	file/file	joined pedestal
h = 2, 3, 4 drawer w = 30" - 42" d = 21"	h = 2 drawer w = 30" - 42" d = 21"	w = 18" - 36"	w = 30" - 36"	w = 18" - 36"	w = 30" - 36"	w = 16" d = 21"	w = 16" d = 21"	w = 36" d = 21"

Underdesk Open Shelf	Underdesk Pedestals box/box/file	file/file	joined pedestal	Underdesk Metal Pedestals box/box/file	file/file	End Gable Pedestals box/box/file	file/file	Mobile Pedestal box/file	Mobile Pedestal with seat box/file
w = 24" - 96" d = 18"	w = 16" d = 18"	w = 16" d = 18"	w = 36" d = 21"	w = 15" d = 24", 30"	w = 15" d = 24", 30"	w = 16" d = 24", 30"	w = 16" d = 24", 30"	w = 17" d = 23"	w = 17" d = 23"

Accessories

Work Organizers binder bin	clip/pen tray	media holder	pen holder	paper sorter	paper tray	phone tray	paper folder	accessory rail	pencil drawer
					w = 9", 13"	w = 9", 13"		w = 18" - 60"	

Ergonomic Accessories mobile cpu holder	underdesk cpu holder	adjustable keyboard tray	adjustable keyboard tray with mouse	retractable keyboard tray	monitor arm

Enhancements worksurface edge mounted screen	worksurface edge mounted work organizer screen	worksurface edge mounted modesty screen	top trim mounted privacy screen	acrylic and glass screen	magnetic whiteboard strips	coat hook	hang-on nameplate
w = 24" - 90" h = 22"	w = 24" - 72" h = 22"	w = 24" - 90" h = 15"	w = 18" - 60" h = 8", 16"	h = 8" - 16" w = 18" - 60"			

Cosmopolitan line-up

Electrics, Communication & Lighting

Power & Data
single-sided
power base module

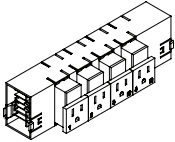

double-sided
power base module

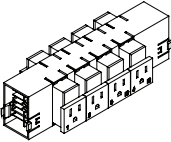

4 outlets
belt-line module

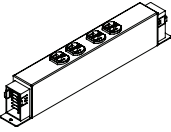

8 outlets
belt-line module

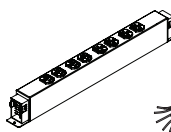

electric starter



l = 72" - 168"

connector harness



l = 22" - 181"

male/female extension

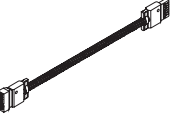

l = 44" - 122"

communications
module configuration 1

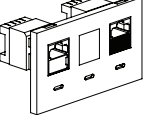

Wire Management
power poles



h = 72" - 144"

wire manager

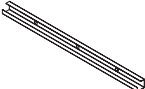

w = 12" - 36"

Lighting
storage mounted
task light



w = 24" - 48"

introduction |

product overview	9
features and benefits	10
variable height panel combinations	11
maximum span of panels	12
electrical cable length calculation	13
storage capacity	14
handle options	14

introduction | product overview

Cosmopolitan is an environment within a workplace. Characterized by a unique upgraded system of segmented and monolithic tiles and streamlined furniture, Cosmopolitan caters to evolving spatial relationships and the modular needs of modern business.

Cosmopolitan's tiles are stackable and are offered in a variety of fabrics and finishes to complement any space.

The hinged access door discreetly conceals electrical wires, opens easily with one hand and stays open while access is required.

Durable laminate worksurfaces in a variety of shapes offer flexibility in space planning and are available in solids, patterns and wood grains with matching vinyl edge trims.

A selection of accessories round out the line, including: whiteboards, pencil drawers, task lighting, paper trays, pencil holders and more.

pedestals

All pedestal drawers are outfitted with full extension slides. Drawers can be easily removed by releasing the small catches on either side of the slide. Pedestals come standard with locks. One lock will lock both file drawers in a file/file pedestal and one box drawer and the file drawer in the box/box/file pedestal. File drawers will accommodate legal or letter sized documents.

freestanding storage and combo cabinets

Various combination filing and storage units provide a place to store personal items and documents to suit any individual's needs.

Cabinets are offered in a variety of solid, pattern and wood grain laminates and are available with or without doors. Cabinets with doors include locks.

accessories

Computer accessories include flat screen monitor arms, articulating keyboard trays and CPU holders.

Heavy duty flat screen monitor arms adjust to the user while storing wire within the arm. The monitor arm mounting plate meets VESA standards to accommodate most monitors. Monitor arms can be grommet or clamp mounted to the worksurface. Articulating and retractable keyboard trays and mobile or underdesk mounted CPU holders complete the workstation.

handle details

Six handle options are available in a brushed nickel finish. Melbourne is the standard handle option unless otherwise specified on your purchase order. Handles are five inches in length.

default vinyl color selections

Each laminate comes with matching vinyl trim color unless otherwise specified on your purchase order. Refer to the laminate finish card for details.

introduction | features and benefits



Features |

- Stackable, load-bearing frames
- Tiles are offered in a variety of fabrics and finishes
- The belt-line hinged electrical access door easily opens with one hand and stays open while access is required
- Complemented by a selection of accessories including whiteboards, keyboard drawers, task lighting, paper trays, pencil holders, etc.
- Durable laminate worksurfaces in a variety of shapes and colors
- 1-inch or 1.5-inch thickness option
- A variety of acrylic options for tiles
- Metal trim and top caps
- Seamlessly integrates with Go mobile and stationary storage and tables
- Tiles are mounted to the frame independently of one another and can be removed without having to remove the tiles above
- Electrics are centrally located at the raceway level
- Tiles are quality engineered from a superior gauge of steel
- Panels are shipped complete with tiles installed

Benefits |

- Flexibility to reconfigure as privacy requirements change, lowering the cost of ownership and reducing inventory levels
- Accommodates mounted storage
- Complements existing furniture or infrastructure
- Finish offering allows for easy customization or personalization of an environment
- Discreetly conceals electrical and data cables at the belt-line
- Provides comfortable access to power and data for the user
- Enhances the functionality of a workspace in a multi-task environment
- Facilitates paper management in a workstation
- Increases space planning possibilities
- Adds distinction to private offices
- Elevates the overall aesthetic of the system
- Controls the degree of privacy required in a workspace
- Allows access to natural light throughout the office, resulting in greater productivity
- Aesthetically more attractive and environmentally friendly than plastic trim
- Ability to create a dynamic, fully functional workspace capable of addressing multiple workplace needs
- Easy to change the functionality of panel frames as the needs of the workspace evolves (i.e. increase or decrease visual and acoustical privacy, add a pass-through, tackable or accessory tiles)
- Access to power and data will not be obstructed by items such as storage towers and pedestal
- Provides maximum strength and durability, which increases the life span of the product, and protects the end user's investment
- Increases accuracy and reduces time of installation

introduction | variable height panel combinations

Cosmopolitan offers the flexibility of 90, 180, 120, and 135 degree connections at varying heights. Illustrated below are a few connection possibilities for Cosmopolitan panel frames.

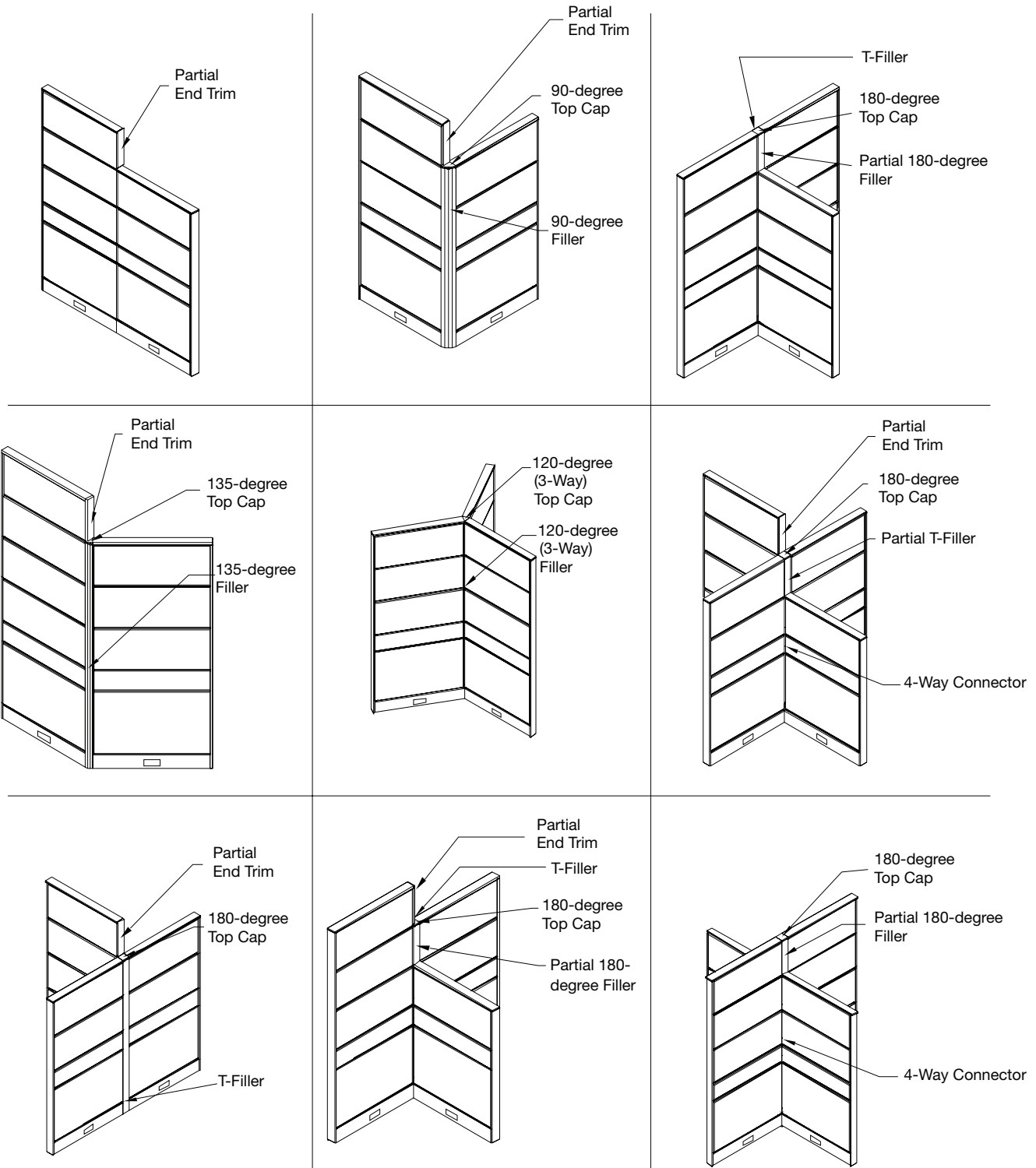

introduction | maximum span of panels

When specifying Cosmopolitan, it is important to be mindful of the width that panels are required to span. The following examples illustrate the maximum width that panels can span before they need to be supported by a return panel or wall.

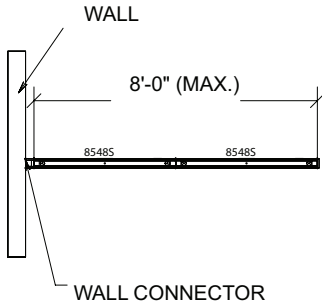

Figure 1

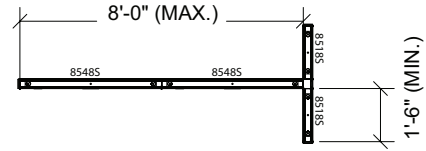

Figure 5

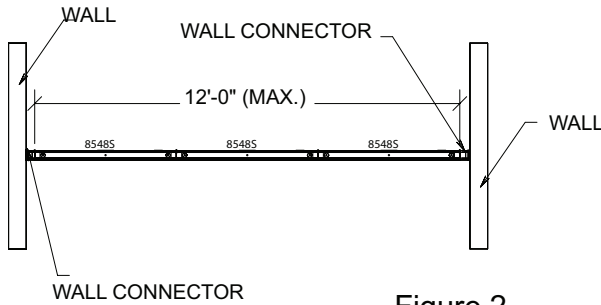

Figure 2

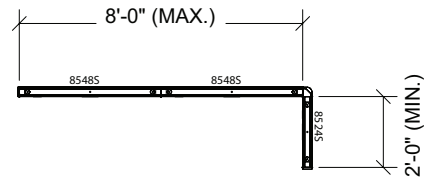

Figure 6

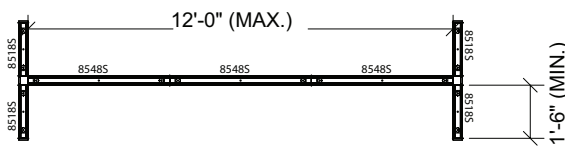

Figure 3

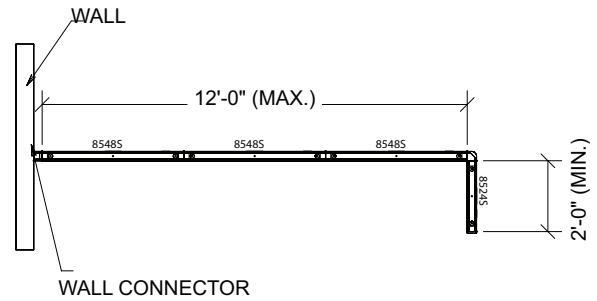

Figure 7

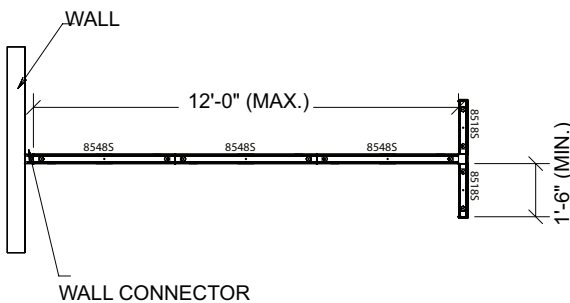

Figure 4

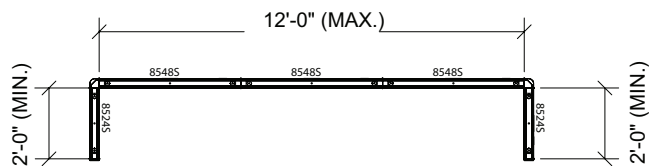
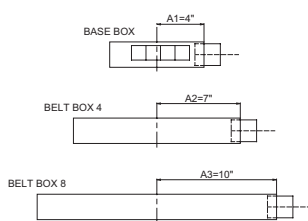
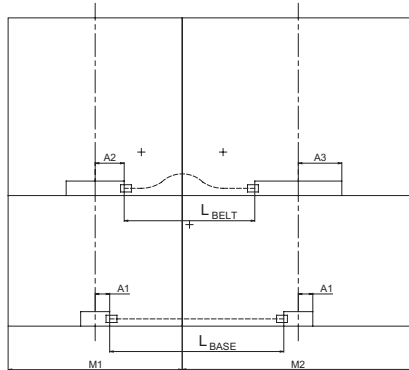

Figure 8

introduction | electrical cable length calculation

Use the following diagrams to calculate baseline and belt-line cabling requirements.

electrical cable length calculation on a straight panel connection



$$L_{BASE} = \frac{M1 + M2}{2} - 8"$$

$$L_{BELT} = \frac{M1 + M2}{2} + 3" - A2 - A2 (A3) (A3)$$

electrical cable length calculation on a corner, T- or X-panel connection

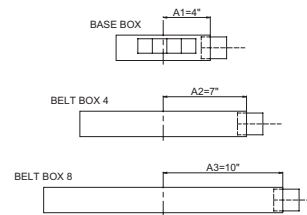
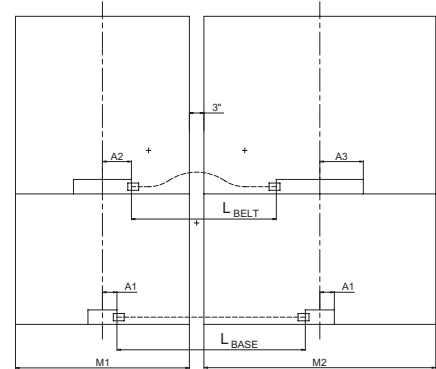

$$L_{BASE} = \frac{M1 + M2}{2} + 3" - 8"$$

$$L_{BELT} = \frac{M1 + M2}{2} + 6" - A2 - A2 (A3) (A3)$$

electrical cable length calculation on a straight panel connection

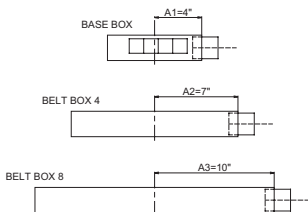
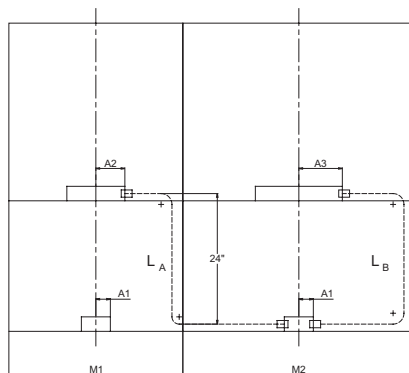

$$L_A = \frac{M1 + M2}{2} + 24" - A1 - A2 (A3)$$

$$L_B = M + 21" - A1 - A2 (A3)$$

electrical cable length calculation on a corner, T- or X-panel connection

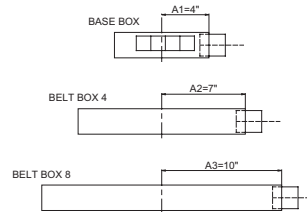
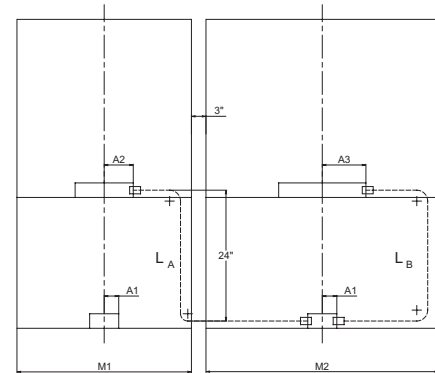

$$L_A = \frac{M1 + M2}{2} + 24" + 3" - A1 - A2 (A3)$$

$$L_B = M + 21" - A1 - A2 (A3)$$

introduction | storage capacity and handle options

storage capacities

lateral file drawers

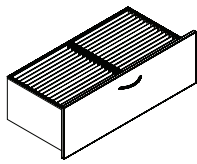

Lateral File Drawer
(36W & 42W)
Legal filing - front to back
Underdesk : 15"
Freestanding: 15"

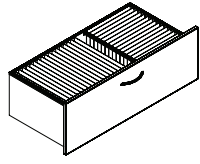

Lateral File Drawer
(36W & 42W)
Legal filing - side to side
Letter filing - front to back
Underdesk : 15"
Freestanding: 15"

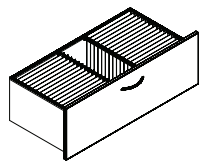

Lateral File Drawer
(30W, 36W, & 42W)
Letter filing - front to back
Underdesk : 15"
Freestanding: 15"

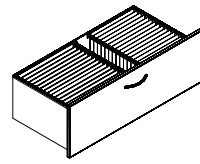

Lateral File Drawer
(36W, & 42W)
Letter & legal filing - front to back
Underdesk : 15"
Freestanding: 15"

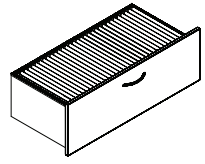

Lateral File Drawer
(30W, 36W, & 42W)
Legal filing - side to side
Underdesk : 30W- 25 1/2"
36W-31 1/2"
42W-37 1/2"
Freestanding: 30W- 25 1/2"
36W-31 1/2"
42W-37 1/2"

box drawer(s)

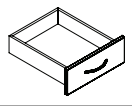

Box Drawer
Box Height: 3 "
Box Depth: 15 "
Box Width: 12 "

file drawers

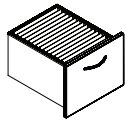

File Drawer
Letter filing - front to back
Underdesk: 15"
Freestanding: 15"

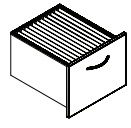

File Drawer
Legal filing - side to side
Underdesk: 12"
Freestanding: 12"

handle options

brooklyn

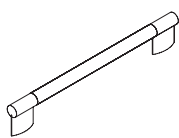

clifton

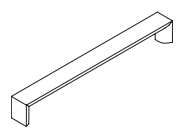

manhattan

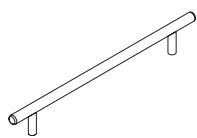

humber

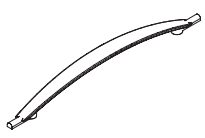

melbourne

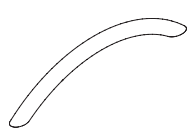

rosedale

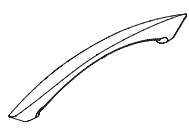

panel frames & connectors | panel frame

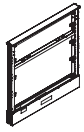

37-inch



45-inch



53-inch



61-inch



69-inch



77-inch

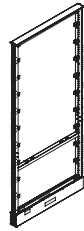

85-inch

what's included:

Panel frame, metal base raceway, metal to metal connection hardware.

application notes:

Any Cosmopolitan stack-on frame of the same width can be stacked on top of this panel frame.

An 8 wire, 4 circuit electrical system is available for the base-line or belt-line. 37-inch panel frames do not accommodate a flip-up belt-line tile. Specify the panel frame with flip-up capability on page 21 when this function is required.

Power and communications may be run into the panel frame using either a power pole or an electrical harness. See the electrics, communication, and lighting section for details.

The metal frame is only available in black.

how to specify:

Specify panel trim finish.

The color of the raceway defaults to the color of the top trim when a metal color is specified.

options

height	37, 45, 53, 61, 69, 77, 85
width	18, 24, 30, 36, 42, 48, 54, 60
top cap finish	metal colors
raceway finish	metal colors
power	8 wire 4 circuit electrical system (to be specified separately)

how to order and read your code

Sample Order: Panel frame, 69-inches high, 42-inches wide, top cap finished in silver (P112), raceway finishes in silver (P112).

NOTE: SAMPLE CODE HERE INCLUDES ALL AVAILABLE OPTIONS.

C product line	PF00 item	69 height	42 width	P112 top cap finish	P112 raceway finish
----------------------	--------------	--------------	-------------	---------------------------	---------------------------

panel frames & connectors | panel frame

Code	Price	H (in.)	W (in.)	Weight (lb.)	Volume (ft ³)
C-PF00-3718	187	37	18	14.6	1.2
C-PF00-3724	207	37	24	16.5	1.7
C-PF00-3730	225	37	30	18.5	2.1
C-PF00-3736	244	37	36	20.5	2.4
C-PF00-3742	263	37	42	22.4	2.9
C-PF00-3748	280	37	48	24.4	3.3
C-PF00-3754	299	37	54	26.4	3.7
C-PF00-3760	318	37	60	28.3	4.1
C-PF00-4518	198	45	18	16.4	1.5
C-PF00-4524	217	45	24	18.3	2
C-PF00-4530	235	45	30	20.3	2.5
C-PF00-4536	254	45	36	22.3	3
C-PF00-4542	273	45	42	24.2	3.5
C-PF00-4548	290	45	48	26.2	4
C-PF00-4554	309	45	54	28.2	4.5
C-PF00-4560	328	45	60	30.1	5
C-PF00-5318	208	53	18	18.2	1.8
C-PF00-5324	228	53	24	20.1	2.3
C-PF00-5330	245	53	30	22.1	2.9
C-PF00-5336	264	53	36	24.1	3.5
C-PF00-5342	282	53	42	26	4.1
C-PF00-5348	301	53	48	28	4.7
C-PF00-5354	319	53	54	30	5.3
C-PF00-5360	339	53	60	31.9	5.19
C-PF00-6118	220	61	18	20	2
C-PF00-6124	240	61	24	21.9	2.7
C-PF00-6130	258	61	30	23.9	3.4
C-PF00-6136	277	61	36	25.9	4
C-PF00-6142	296	61	42	27.8	4.7
C-PF00-6148	314	61	48	29.8	5.4
C-PF00-6154	332	61	54	31.8	6
C-PF00-6160	350	61	60	33.7	6.7
C-PF00-6918	231	69	18	21.8	2.3
C-PF00-6924	250	69	24	23.7	3
C-PF00-6930	267	69	30	25.7	3.8
C-PF00-6936	286	69	36	27.7	4.5
C-PF00-6942	305	69	42	29.6	5.3
C-PF00-6948	323	69	48	31.6	6.1
C-PF00-6954	342	69	54	33.6	6.8
C-PF00-6960	361	69	60	35.5	7.6
C-PF00-7718	240	77	18	23.6	2.5
C-PF00-7724	260	77	24	25.5	3.4
C-PF00-7730	278	77	30	27.5	4.2
C-PF00-7736	297	77	36	29.5	5.1
C-PF00-7742	315	77	42	31.4	5.9
C-PF00-7748	333	77	48	33.4	6.7
C-PF00-7754	351	77	54	35.5	7.6
C-PF00-7760	371	77	60	37.3	8.4
C-PF00-8518	250	85	18	25.4	2.8
C-PF00-8524	269	85	24	27.3	3.7
C-PF00-8530	287	85	30	29.3	4.6
C-PF00-8536	306	85	36	31.3	5.6
C-PF00-8542	324	85	42	33.2	6.5
C-PF00-8548	343	85	48	35.2	7.4
C-PF00-8554	362	85	54	37.2	8.3
C-PF00-8560	381	85	60	39.1	9.3

panel frames & connectors | panel frame for full acrylic panel

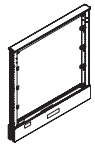

37-inch

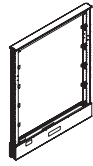

45-inch

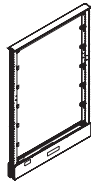

53-inch



61-inch



69-inch



77-inch



85-inch

what's included:

Panel frame for acrylic panel, metal base raceway, metal to metal connection hardware.

application notes:

An 8 wire, 4 circuit electrical system is available at the base-line.

Power and communications may be run into the panel frame using either a power pole or an electrical harness. See the electrics, communication, and lighting section for details.

The metal frame is only available in black.

how to specify:

Specify panel trim finish.

The color of the raceway defaults to the color of the top trim when a metal color is specified.

options

height	37, 45, 53, 61, 69, 77, 85
width	18, 24, 30, 36, 42, 48, 54, 60
top cap finish	metal colors
raceway finish	metal colors
power	8 wire 4 circuit electrical system (to be specified separately)

how to order and read your code

Sample Order: Panel frame for full acrylic panel, 61-inches high, 54-inches wide, top cap finished in silver (P112), raceway finished in silver (P112).

NOTE: SAMPLE CODE HERE INCLUDES ALL AVAILABLE OPTIONS.

C	PFG0	61	54	P112	P112
product line	item	height	width	top cap finish	raceway finish

panel frames & connectors | panel frame for full acrylic panel

Code	Price	H (in.)	W (in.)	Weight (lb.)	Volume (ft ³)
C-PFG0-3718	185	37	18	14.6	1.2
C-PFG0-3724	203	37	24	16.5	1.7
C-PFG0-3730	220	37	30	18.5	2.1
C-PFG0-3736	239	37	30	20.5	2.4
C-PFG0-3742	256	37	42	22.4	2.9
C-PFG0-3748	274	37	48	24.4	3.3
C-PFG0-3754	290	37	54	26.4	3.7
C-PFG0-3760	309	37	60	28.3	4.1
C-PFG0-4518	196	45	18	16.4	1.5
C-PFG0-4524	214	45	24	18.3	2
C-PFG0-4530	232	45	30	20.3	2.5
C-PFG0-4536	249	45	36	22.3	3
C-PFG0-4542	266	45	42	24.2	3.5
C-PFG0-4548	283	45	48	26.2	4
C-PFG0-4554	302	45	54	28.2	4.5
C-PFG0-4560	319	45	60	30.1	5
C-PFG0-5318	206	53	18	18.2	1.8
C-PFG0-5324	224	53	24	20.1	2.3
C-PFG0-5330	241	53	30	22.1	2.9
C-PFG0-5336	260	53	36	24.1	3.5
C-PFG0-5342	277	53	42	26	4.1
C-PFG0-5348	295	53	48	28	4.7
C-PFG0-5354	311	53	54	30	5.3
C-PFG0-5360	330	53	60	31.9	5.9
C-PFG0-6118	218	61	18	20	2
C-PFG0-6124	237	61	24	21.9	2.7
C-PFG0-6130	254	61	30	23.9	3.4
C-PFG0-6136	272	61	36	25.9	4
C-PFG0-6142	289	61	42	27.8	4.7
C-PFG0-6148	306	61	48	29.8	5.4
C-PFG0-6154	324	61	54	31.8	6
C-PFG0-6160	342	61	60	33.7	6.7
C-PFG0-6918	229	69	18	21.8	2.3
C-PFG0-6924	246	69	24	23.7	3
C-PFG0-6930	264	69	30	25.7	3.8
C-PFG0-6936	281	69	36	27.7	4.5
C-PFG0-6942	300	69	42	29.6	5.3
C-PFG0-6948	316	69	48	31.6	6.1
C-PFG0-6954	334	69	54	33.6	6.8
C-PFG0-6960	351	69	60	35.5	7.6
C-PFG0-7718	238	77	18	23.6	2.5
C-PFG0-7724	256	77	24	25.5	3.4
C-PFG0-7730	274	77	30	27.5	4.2
C-PFG0-7736	293	77	36	29.5	5.1
C-PFG0-7742	309	77	42	31.4	5.9
C-PFG0-7748	327	77	48	33.4	6.7
C-PFG0-7754	344	77	54	35.5	7.6
C-PFG0-7760	363	77	60	37.3	8.4
C-PFG0-8518	247	85	18	25.4	2.8
C-PFG0-8524	266	85	24	27.3	3.7
C-PFG0-8530	283	85	30	29.3	4.6
C-PFG0-8536	302	85	36	31.3	5.6
C-PFG0-8542	319	85	42	33.2	6.5
C-PFG0-8548	337	85	48	35.2	7.4
C-PFG0-8554	353	85	54	37.2	8.3
C-PFG0-8560	372	85	60	39.1	9.3

panel frames & connectors | panel frame with countertop capability

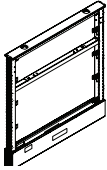
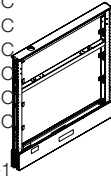
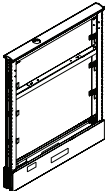
 <p>with countertop capability, single panel</p>	C-PF00-3724-C	 <p>with countertop capability, 1 hole</p>	 <p>with 54-inch countertop capability</p>	37	24	17.6	1.7
	C-PF00-3730-C			30	19.9	2.1	
	C-PF00-3736-C			37	22.2	2.5	
	C-PF00-3742-C			37	42	24.4	2.9
	C-PF00-3748-C			37	48	26.7	3.3
	C-PF00-3754-C			37	54	29.0	3.7
	C-PF00-3760-C			37	60	31.3	4.1
	C-PF00-3718-1			37	18	15.4	1.2
	C-PF00-3724-1			37	24	17.6	1.7
	C-PF00-3730-1			37	30	19.9	2.1
C-PF00-3730-1-P	37	30	19.9	2.1			

what's included:

Panel frame with countertop capability, metal base raceway, metal to metal connection hardware.

application notes:

An 8 wire, 4 circuit electrical system is available at the base-line. For belt-line, specify the panel frame with flip-up capabilities on page 21.

Power and communications may be run into the panel frame using either a power pole or an electrical harness. See the electrics, communication, and lighting section for details.

2 holes are used when a single panel frame is supporting a countertop of the same width.

1 hole, 6-inches away from the end of the panel frame is used when two panels are supporting a countertop equal to the sum of their widths.

1 hole, 9-inches away from the end of the panel frame is used when two 30-inch wide panels are supporting a 54-inch countertop.

The metal frame is only available in black.

how to specify:

Specify panel trim finish.

Specify this item when a 37-inch high or 45-inch high panel with countertop capabilities is required, but an electrical access door is not needed.

When a 54-inch countertop is supported by a 30-inch wide panel and a 24-inch wide panel, the hole in the 30-inch panel will be located 6-inches away from the end of the panel. When two 30-inch wide panels are used to support a 54-inch wide countertop, the holes will be located 9-inches away from the end of the panel. A 60-inch panel has two holes located 9-inches away from the ends of the panel to accommodate 54-inch wide countertops.

The color of the raceway defaults to the color of the top trim when a metal color is specified.

options

height	37, 45	
width	18, 24, 30, 36, 42, 48, 54, 60	
countertop capability	with countertop	with countertop, 1 hole
top cap finish	metal colors	

how to order and read your code

Sample Order: Panel frame with countertop capability, 37-inches high, 30-inches wide, with countertop capability 1 hole, top cap finished in silver (R112), raceway finished in silver (P112).

NOTE: SAMPLE CODE HERE INCLUDES ALL AVAILABLE OPTIONS.

C	PF00	37	30	1	R112	P112
product line	item	height	width	countertop capability	top cap finish	raceway finish

panel frames & connectors | panel frame with countertop capability

Code	Price	H (in.)	W (in.)	Weight (lb.)	Volume (ft ³)
37" High					
With Countertop Capability					
C-PF00-3724-C	214	37	24	17.6	1.7
C-PF00-3730-C	233	37	30	19.9	2.1
C-PF00-3736-C	252	37	36	22.2	2.5
C-PF00-3742-C	271	37	42	24.4	2.9
C-PF00-3748-C	288	37	48	26.7	3.31
C-PF00-3754-C	307	37	54	29	3.7
C-PF00-3760-C	325	37	60	31.3	4.1
With Countertop Capability, Side-by-side panels					
C-PF00-3718-1	196	37	18	15.4	1.2
C-PF00-3724-1	214	37	24	17.6	1.7
C-PF00-3730-1	233	37	30	19.9	2.1
With 54" Countertop Capability, Side-by-side panels					
C-PF00-3730-1-P	233	37	30	19.9	2.1
45" High					
With Countertop Capability					
C-PF00-4524-C	224	45	24	17.6	1.7
C-PF00-4530-C	242	45	30	19.9	2.1
C-PF00-4536-C	262	45	36	22.2	2.5
C-PF00-4542-C	280	45	42	24.4	2.9
C-PF00-4548-C	298	45	48	26.7	3.3
C-PF00-4554-C	316	45	54	29	3.7
C-PF00-4560-C	336	45	60	31.3	4.1
With Countertop Capability, Side-by-side panels					
C-PF00-4518-1	204	45	18	15.37	1.5
C-PF00-4524-1	224	45	24	17.6	2
C-PF00-4530-1	242	45	30	19.9	2.1
With 54" Countertop Capability, Side-by-side panels					
C-PF00-4530-1-P	242	45	30	19.88	2.5

panel frames & connectors | panel frame with flip-up capability

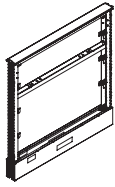

without countertop capability

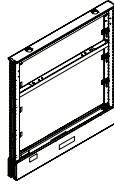

with countertop capability, single panel

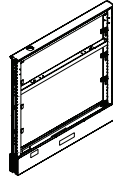

with countertop capability, 1 hole

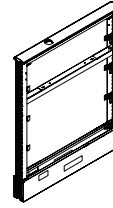

with 54-inch countertop capability

what's included:

Panel frame with flip-up capability, metal base raceway, metal to metal connection hardware.

application notes:

An 8 wire, 4 circuit electrical system is available for the base-line or belt-line.

Power and communications may be run into the panel frame using either a power pole or an electrical harness. See the electrics, communication, and lighting section for details.

2 holes are used when a single panel frame is supporting a countertop of the same width.

1 hole, 6-inches away from the end of the panel frame is used when two panels are supporting a countertop equal to the sum of their widths.

1 hole, 9-inches away from the end of the panel frame is used when two 30-inch wide panels are supporting a 54-inch countertop.

The metal frame is only available in black.

how to specify:

Specify panel trim finish.

Specify this product when a 37-inch high panel frame with a flip-up belt line is required.

When a countertop is supported by a single panel (C), the holes will be located six inches away from the end of the panel.

When a 54-inch countertop is supported by a 30-inch wide panel and a 24-inch wide panel, the holes in the 30-inch panel will be located 6-inches away from the end of the panel. When two 30-inch wide panels are used to support a 54-inch wide countertop, the holes will be located 9-inches away from the end of the panel. A 60-inch panel has 2 holes located 9-inches away from the ends of the panel to accommodate 54-inch wide countertops.

The color of the raceway defaults to the color of the top trim when a metal color is specified.

options

height	37			
width	18, 24, 30, 36, 42, 48, 54, 60			
countertop capability	without countertop	with countertop	with countertop, 1 hole	with 54" countertop capability
top cap finish	metal colors			
raceway finish	metal colors			

how to order and read your code

Sample Order: Panel frame with flip-up capability, 37-inches high, 54-inches wide, with countertop, top cap finished in espresso sparkle (P117), raceway finishes in espresso sparkle (P117).

NOTE: SAMPLE CODE HERE INCLUDES ALL AVAILABLE OPTIONS.

C	PF0F	37	54	C	P117	P117
product line	item	height	width	countertop capability	top cap finish	raceway finish

panel frames & connectors | panel frame with flip-up capability

Code	Price	H (in.)	W (in.)	Weight (lb.)	Volume (ft ³)
37" High					
With Flip-up					
C-PF0F-3718	196	37	18	14.6	1.2
C-PF0F-3724	214	37	24	16.5	1.7
C-PF0F-3730	233	37	30	18.5	2.1
C-PF0F-3736	252	37	36	20.5	2.4
C-PF0F-3742	271	37	42	22.4	2.9
C-PF0F-3748	288	37	48	24.4	3.3
C-PF0F-3754	307	37	54	26.4	3.7
C-PF0F-3760	325	37	60	28.3	4.1
With Countertop Capability, Single panel, Flip-up					
C-PF0F-3724-C	214	37	24	17.6	1.7
C-PF0F-3730-C	233	37	30	19.9	2.1
C-PF0F-3736-C	252	37	36	22.2	2.5
C-PF0F-3742-C	271	37	42	24.4	2.9
C-PF0F-3748-C	288	37	48	26.7	3.3
C-PF0F-3754-C	307	37	54	29	3.7
C-PF0F-3760-C	325	37	60	31.3	4.1
With Countertop Capability, Side-by-side panels, Flip-up					
C-PF0F-3718-1	196	37	18	15.4	1.2
C-PF0F-3724-1	214	37	24	17.6	1.7
C-PF0F-3730-1	233	37	30	19.9	2.1
With 54" Countertop Capability, Side-by-side panels, Flip-up					
C-PF0F-3730-1-P	233	37	30	19.9	2.1

panel frames & connectors | stack-on panel frame

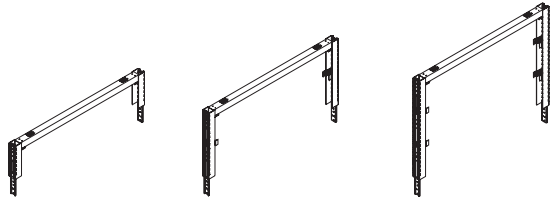

8-inch
16-inch
24-inch
regular frames

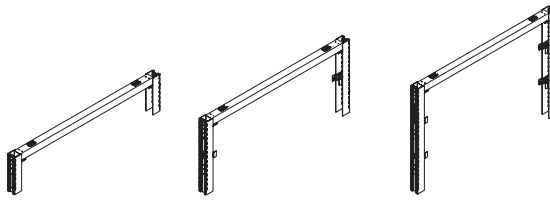

8-inch
16-inch
24-inch
door frames

what's included:
Stack-on panel frame, metal to metal connection hardware.

how to specify:
There are no color options for this product.

application notes:
Metal frame is only available in black.

Top trim is not included. Install the top trim from the panel below.

Regular stack-on panel frame may be installed on any panel frame of the same width. Door stack-on panel frame may be installed on a door of the same width between two other stackable frames or between a stackable panel frame and a panel filler.

options

frame type	0 regular frames 1 door frames
height	8, 16, 24
width	18, 24, 30, 36, 42, 48, 54, 60

how to order and read your code

Sample Order: Stack-on panel frame, door frame, 16-inches high, 36-inches wide.

C product line	PS01 item	16 height	36 width
----------------------	--------------	--------------	-------------

panel frames & connectors | stack-on panel frame

Code	Price	H (in.)	W (in.)	Weight (lb.)	Volume (ft ³)
Regular Frames					
C-PS00-0818	66	8	18	4.4	0.3
C-PS00-0824	70	8	24	5	0.3
C-PS00-0830	74	8	30	5.7	0.4
C-PS00-0836	80	8	36	6.3	0.5
C-PS00-0842	84	8	42	6.9	0.6
C-PS00-0848	90	8	48	7.6	0.7
C-PS00-0854	94	8	54	8.2	0.8
C-PS00-0860	100	8	60	8.9	0.9
C-PS00-1618	76	16	18	6.2	0.5
C-PS00-1624	80	16	24	6.8	0.7
C-PS00-1630	84	16	30	7.5	0.9
C-PS00-1636	90	16	36	8.1	1
C-PS00-1642	94	16	42	8.7	1.2
C-PS00-1648	100	16	48	9.4	1.4
C-PS00-1654	104	16	54	10	1.5
C-PS00-1660	109	16	60	10.7	1.7
C-PS00-2418	83	24	18	8	0.8
C-PS00-2424	88	24	24	8.6	1
C-PS00-2430	92	24	30	9.3	1.3
C-PS00-2436	98	24	36	9.9	1.5
C-PS00-2442	102	24	42	10.5	1.8
C-PS00-2448	106	24	48	11.2	2.1
C-PS00-2454	111	24	54	11.8	2.3
C-PS00-2460	115	24	60	12.5	2.6
Door Frames					
C-PS01-0836	73	8	36	6.3	0.5
C-PS01-0842	78	8	42	6.9	0.6
C-PS01-1636	83	16	36	8.1	1
C-PS01-1642	89	16	42	8.7	1.2
C-PS01-2436	91	24	36	9.9	1.5
C-PS01-2442	95	24	42	10.5	1.8

panel frames & connectors | panel door



right hand

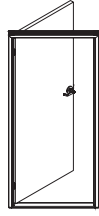

left hand

what's included:

Panel door, door frame, lever type handle, connection hardware.

application notes:

Door is powder painted MDF.

The door must be connected to 85-inch high panel frames or panel fillers.

how to specify:

Specify panel trim finish.

The panel trim finish must be specified. The door and door frame are available in all paint colors and will match the color of the top trim.

Right or left hand must be specified.

options

width	36, 42
hand	R right L left
door and door frame finish	metal colors
top cap finish	metal colors

how to order and read your code

Sample Order: Panel door, 85-inches high, 42-inches wide, right-handed, door and door frame finished in silver (P112), top cap finished in silver (P112).

NOTE: SAMPLE CODE HERE INCLUDES ALL AVAILABLE OPTIONS.

C product line	PD00 item	85 height	42 width	R hand	P112 door and door frame finish	P112 top cap finish
----------------------	--------------	--------------	-------------	-----------	---------------------------------------	---------------------------

panel frames & connectors | panel door

Code	Price	H (in.)	W (in.)	Weight (lb.)	Volume (ft ³)
C-PD00-8536-_ C-PD00-8542-_ 	2060 2244	85 85	36 42	68 80	5.6 6.5

panel frames & connectors | acrylic sliding door

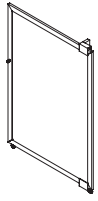

right hand

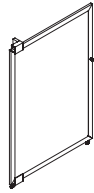

left hand

what's included:

Acrylic sliding door, metal to metal connection hardware.

application notes:

The sliding door height must be connected to a panel of equal height.

The acrylic sliding door provides visual privacy for individual stations. Sliding doors must always be connected to a panel.

how to specify:

Specify panel trim finish.

A metal color must be specified for the panel trim.

Right or left hand must be specified.

The acrylic option must be specified. When frosted or clear acrylic is specified, an upcharge of \$351 is applicable.

options

height	61, 69		
width	30, 36, 42		
hand	R right	L left	
acrylic option	L fluted	F frosted	C clear
frame finish	metal colors		

how to order and read your code

Sample Order: Acrylic sliding door, 61-inches high, 36-inches wide, right-handed, frosted acrylic (F), frame finished in silver (P112).

C product line	PDSG item	61 height	36 width	R hand	F acrylic option	P112 frame finish
----------------------	--------------	--------------	-------------	-----------	------------------------	-------------------------

panel frames & connectors | acrylic sliding door

Code	Fluted Price	H (in.)	W (in.)	Weight (lb.)	Volume (ft ³)
C-PDSG-6130-__	1350	61	30	53	4
C-PDSG-6136-__	1401	61	36	53	4
C-PDSG-6142-__	1451	61	42	53	4.6
C-PDSG-6930-__	1412	69	30	53	4
C-PDSG-6936-__	1464	69	36	53	4.5
C-PDSG-6942-__	1513	69	42	53	5.2

Upgrades:

F_Frosted

C_Clear

panel frames & connectors | lockable acrylic sliding door

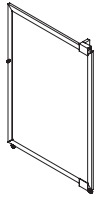

right hand

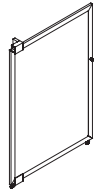

left hand

what's included:

Lockable acrylic sliding door, metal to metal connection hardware.

application notes:

The sliding door height must be connected to a panel of equal height.

The lockable acrylic sliding door provides visual privacy for individual stations.

Sliding doors must always be connected to a panel.

how to specify:

Specify panel trim finish.

A metal color must be specified for the panel trim.

Right or left hand must be specified.

The acrylic option must be specified. When frosted or clear acrylic is specified, an upcharge of \$351 is applicable.

options

height	61, 69		
width	30, 36, 42		
lock	LK		
hand	R right	L left	
acrylic option	L fluted	F frosted	C clear
frame finish	metal colors		

how to order and read your code

Sample Order: Acrylic sliding door, 61-inches high, 36-inches wide, right-handed, frosted acrylic (F), frame finished in silver (P112).

C product line	PDSG item	61 height	36 width	LK lock	R hand finish	F acrylic option	P112 frame
----------------------	--------------	--------------	-------------	------------	---------------------	------------------------	---------------

panel frames & connectors | lockable acrylic sliding door

Code	Fluted Price	H (in.)	W (in.)	Weight (lb.)	Volume (ft ³)
C-PDSG-6130-LK-L	1557	61	30	53	4
C-PDSG-6136-LK-L	1608	61	36	53	4
C-PDSG-6142-LK-L	1658	61	42	53	4.6
C-PDSG-6930-LK-L	1620	69	30	53	4
C-PDSG-6936-LK-L	1670	69	36	53	4.5
C-PDSG-6942-LK-L	1720	69	42	53	5.2

Upgrades:

F_Frosted

C_Clear

panel frames & connectors | end trim



full end trim



partial end trim

what's included:

Full End Trim: full end trim, connection hardware.
 Partial End Trim: partial end trim, connection hardware, bottom plastic connector trim.

how to specify:

Specify panel trim finish.
 A metal color must be specified.

application notes:

Use the full end trim to finish a panel at the end of a run. Use the partial end trim to finish a panel where a change of height occurs.

options

height	8, 16, 24, 32, 37, 40, 45, 48, 53, 56, 61, 64, 69, 72, 77, 85, 93, 101, 109	
type	0 full end trim	P partial end trim
end trim finish	metal colors	

how to order and read your code

Sample Order: End trim, partial, 40-inches high, panel trim finished in espresso sparkle (P117).

NOTE: SAMPLE CODE HERE INCLUDES ALL AVAILABLE OPTIONS.

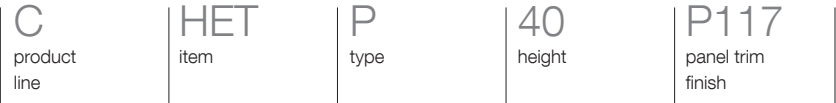

panel frames & connectors | end trim

Code	Price	H (in.)	Weight (lb.)	Volume (ft ³)
Full End Trim				
C-HETO-37	50	37	2.2	0.1
C-HETO-45	58	45	2.4	0.1
C-HETO-53	64	53	2.6	0.1
C-HETO-61	70	61	2.8	0.1
C-HETO-69	77	69	3	0.1
C-HETO-77	83	77	3.2	0.1
C-HETO-85	90	85	3.4	0.1
C-HETO-93	96	93	3.6	0.1
C-HETO-101	103	101	3.8	0.1
C-HETO-109	109	109	4.5	0.1
Partial End Trim				
C-HETP-08	27	8	1.2	0.1
C-HETP-16	34	16	1.6	0.1
C-HETP-24	40	24	2	0.1
C-HETP-32	47	32	2.4	0.1
C-HETP-40	55	40	2.8	0.1
C-HETP-48	61	48	3.2	0.1
C-HETP-56	67	56	3.4	0.1
C-HETP-64	73	64	3.6	0.1
C-HETP-72	80	72	3.8	0.1

panel frames & connectors | 90-degree filler



full 90-degree filler



partial 90-degree filler

what's included:

Full 90-degree filler: Full 90-degree filler, top cap, connection hardware.
 Partial 90-degree filler: Partial 90-degree filler, top cap, bottom plastic connector trim, connection hardware.

how to specify:

Specify panel trim finish.
 A metal color must be specified for the panel trim finish.

application notes:

Use the full 90-degree filler to connect two panel frames that are the same height. Use the partial 90-degree filler to connect two panel frames where a change of height occurs.

options

height	8, 16, 24, 32, 37, 40, 45, 48, 53, 56, 61, 64, 69, 72, 77, 85, 93, 101, 109	
type	R full filler	P partial filler
top cap finish	metal colors	
raceway finish	metal colors	

how to order and read your code

Sample Order: 90 degree filler, full, 48-inches high, top cap finished in espresso sparkle (P117), raceway finished in espresso sparkle (P117).

NOTE: SAMPLE CODE HERE INCLUDES ALL AVAILABLE OPTIONS.



panel frames & connectors | 90-degree filler

Code	Price	H (in.)	Weight (lb.)	Volume (ft ³)
Full 90-degree Filler				
C-HFNR-37	89	37	1.1	0.2
C-HFNR-45	107	45	1.3	0.3
C-HFNR-53	116	53	1.5	0.3
C-HFNR-61	127	61	1.7	0.3
C-HFNR-69	136	69	1.9	0.4
C-HFNR-77	146	77	2.1	0.4
C-HFNR-85	165	85	2.3	0.5
C-HFNR-93	182	93	2.5	0.5
C-HFNR-101	193	101	2.7	0.6
C-HFNR-109	201	109	2.9	0.6
Partial 90-degree Filler				
C-HFNP-08	45	8	0.2	0.1
C-HFNP-16	56	16	0.5	0.1
C-HFNP-24	73	24	0.6	0.1
C-HFNP-32	82	32	0.9	0.2
C-HFNP-40	102	40	1.1	0.2
C-HFNP-48	110	48	1.2	0.3
C-HFNP-56	121	56	1.4	0.3
C-HFNP-64	130	64	1.6	0.4
C-HFNP-72	139	72	1.8	0.4

panel frames & connectors | 180-degree connection filler



full 180-degree connection filler



partial 180-degree connection filler

what's included:

Two 180-degree connection filler (full or partial, as specified), top cap, connection hardware.

how to specify:

Specify panel trim finish.

A metal color must be specified for the top cap finish.

application notes:

Use the full 180-degree filler to connect two panels that are the same height. Use the partial 180-degree filler to connect two panel frames where a change of height occurs.

options

type	R full filler	P partial filler
height	8, 16, 24, 32, 37, 40, 45, 48, 53, 56, 61, 64, 69, 77, 72, 85, 93, 101, 109	
top cap finish	metal colors	
raceway finish	metal colors	

how to order and read your code

Sample Order: 180-degree connection filler, full, 53-inches high, top cap finished in espresso sparkle (P117), raceway finished in espresso sparkle (P117).

NOTE: SAMPLE CODE HERE INCLUDES ALL AVAILABLE OPTIONS.

C	HFS	R	53	P117	P117
product line	item	type	depth	top cap finish	raceway finish

panel frames & connectors | 180-degree connection filler

Code	Price	H (in.)	Weight (lb.)	Volume (ft ³)
Full 180-degree Filler				
C-HFSR-37	106	37	1.1	0.2
C-HFSR-45	128	45	1.3	0.3
C-HFSR-53	138	53	1.5	0.3
C-HFSR-61	150	61	1.7	0.3
C-HFSR-69	163	69	1.9	0.4
C-HFSR-77	173	77	2.1	0.4
C-HFSR-85	195	85	2.3	0.5
C-HFSR-93	216	93	2.5	0.5
C-HFSR-101	229	101	2.7	0.6
C-HFSR-109	239	109	2.9	0.6
Partial 180-degree Filler				
C-HFSP-08	55	8	0.2	0.1
C-HFSP-16	65	16	0.5	0.1
C-HFSP-24	87	24	0.6	0.1
C-HFSP-32	99	32	0.9	0.2
C-HFSP-40	121	40	1.1	0.2
C-HFSP-48	131	48	1.2	0.3
C-HFSP-56	143	56	1.4	0.3
C-HFSP-64	153	64	1.6	0.4
C-HFSP-72	166	72	1.8	0.4

panel frames & connectors | t-connection filler



full T-connection filler



partial T-connection filler

what's included:

Full Filler: full t-connection filler, top cap, connection hardware.

Partial Filler: partial t-connection filler, top cap, bottom plastic connector trim, connection hardware.

how to specify:

Specify panel trim finish.

A metal color must be specified for the top cap finish.

application notes:

Use the full t-connection filler to connect two panel frames that are the same height. Use the partial t-connection filler to connect two panel frames where a change of height occurs.

options

type	R full filler	P partial filler
height	8, 16, 24, 32, 37, 40, 45, 48, 53, 56, 61, 64, 69, 72, 77, 85, 93, 101, 109	
top cap finish	metal colors	
raceway finish	metal colors	

how to order and read your code

Sample Order: T-connection filler, partial, 56-inches high, top cap finished in silver (P112), raceway finished in silver (P112).

NOTE: SAMPLE CODE HERE INCLUDES ALL AVAILABLE OPTIONS.

C	HFT	P	56	P112	P112
product line	item	type	height	top cap finish	raceway finish

panel frames & connectors | t-connection filler

Code	Price	H (in.)	Weight (lb.)	Volume (ft ³)
Full T-Connection Filler				
C-HFTR-37	87	37	0.5	0.2
C-HFTR-45	106	45	0.6	0.3
C-HFTR-53	113	53	0.8	0.3
C-HFTR-61	121	61	0.9	0.3
C-HFTR-69	128	69	1	0.4
C-HFTR-77	135	77	1.1	0.4
C-HFTR-85	155	85	1.2	0.5
C-HFTR-93	175	93	1.4	0.5
C-HFTR-101	181	101	1.6	0.6
C-HFTR-109	190	109	1.8	0.6
Partial T-Connection Filler				
C-HFTP-08	46	8	0.2	0.1
C-HFTP-16	55	16	0.5	0.1
C-HFTP-24	73	24	0.6	0.1
C-HFTP-32	81	32	0.9	0.2
C-HFTP-40	101	40	1.1	0.2
C-HFTP-48	108	48	1.2	0.3
C-HFTP-56	115	56	1.4	0.3
C-HFTP-64	124	64	1.6	0.4
C-HFTP-72	130	72	1.8	0.4

panel frames & connectors | 135-degree 2-way connector



what's included:
135-degree 2-way connector, top cap, connection hardware.

how to specify:
Specify panel trim finish.

application notes:
Use the 135-degree 2-way connector to connect two panel frames that are the same height.

A metal color must be specified for the top cap finish.

options

height	37, 45, 53, 61, 69, 77, 85, 93, 101, 109
top cap finish	metal colors
raceway finish	metal colors

how to order and read your code

Sample Order: 135-degree 2-way connector, 77-inches high, top cap finished in silver (P112), raceway finished in silver (P112).

NOTE: SAMPLE CODE HERE INCLUDES ALL AVAILABLE OPTIONS.

C	HF1R	77	P112	P112
product line	item	height	top cap finish	raceway finish

panel frames & connectors | 135-degree 2-way connector

Code	Price	H (in.)	Weight (lb.)	Volume (ft ³)
C-HF1R-37	71	37	1.1	0.2
C-HF1R-45	87	45	1.3	0.3
C-HF1R-53	92	53	1.5	0.3
C-HF1R-61	99	61	1.7	0.3
C-HF1R-69	104	69	1.9	0.4
C-HF1R-77	109	77	2.1	0.4
C-HF1R-85	125	85	2.3	0.5
C-HF1R-93	139	93	2.5	0.5
C-HF1R-101	145	101	2.7	0.6
C-HF1R-109	150	109	2.9	0.6

panel frames & connectors | 120-degree 2-way connection filler



full 120-degree 2-way connection filler

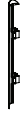

partial 120-degree 2-way connection filler

what's included:

Full Filler: full 120-degree 2-way connection filler, top cap, connection hardware.

Partial Filler: partial 120-degree 2-way connection filler, top cap, bottom plastic connector trim, connection hardware.

how to specify:

Specify panel trim finish.

A metal color must be specified for the top cap finish.

application notes:

Use the full 120-degree 2-way connection filler to connect two panel frames that are the same height. Use the partial 120-degree 2-way connection filler to connect two panel frames where a change of height occurs.

options

height	8, 16, 24, 32, 37, 40, 45, 48, 53, 56, 61, 64, 69, 72, 77, 85, 93, 101, 109	
type	R full filler	P partial filler
top cap finish	metal colors	
raceway finish	metal colors	

how to order and read your code

Sample Order: 120-degree 2-way connection filler, partial, 16-inches high, top cap finished in silver (P112).

NOTE: SAMPLE CODE HERE INCLUDES ALL AVAILABLE OPTIONS.

C	HF2	P	16	P112
product line	item	type	height	top cap finish

panel frames & connectors | 120-degree 2-way connection filler

Code	Price	H (in.)	Weight (lb.)	Volume (ft ³)
Full 120-degree 2-way Connection Filler				
C-HF2R-37	74	37	1.1	0.2
C-HF2R-45	91	45	1.3	0.3
C-HF2R-53	96	53	1.5	0.3
C-HF2R-61	103	61	1.7	0.3
C-HF2R-69	109	69	1.9	0.4
C-HF2R-77	115	77	2.1	0.4
C-HF2R-85	131	85	2.3	0.5
C-HF2R-93	147	93	2.5	0.5
C-HF2R-101	152	101	2.7	0.6
C-HF2R-109	159	109	2.9	0.6
Partial 120-degree 2-way Connection Filler				
C-HF2P-08	42	8	0.2	0.1
C-HF2P-16	48	16	0.5	0.1
C-HF2P-24	64	24	0.6	0.1
C-HF2P-32	70	32	0.9	0.2
C-HF2P-40	87	40	1.1	0.2
C-HF2P-48	92	48	1.2	0.3
C-HF2P-56	99	56	1.4	0.3
C-HF2P-64	105	64	1.6	0.4
C-HF2P-72	111	72	1.8	0.4

panel frames & connectors | 120-degree 3-way connection filler



120-degree 3-way connection filler

what's included:
120-degree 3-way connection filler, top cap, connection hardware.

how to specify:
Specify panel trim finish.

application notes:
Use the 120-degree 3-way connection filler to connect three panel frames that are the same height.

A metal color must be specified for the top cap finish.

options

height	37, 45, 53, 61, 69, 77, 85, 93, 101, 109
top cap finish	metal colors

how to order and read your code

Sample Order: 120-degree 3-way connection filler, 77-inch high, top cap finished in silver (P112).

NOTE: SAMPLE CODE HERE INCLUDES ALL AVAILABLE OPTIONS.

C product line	HP3R item	77 height	P112 top cap finish
----------------------	--------------	--------------	---------------------------

panel frames & connectors | 120-degree 3-way connection filler

Code	Price	H (in.)	Weight (lb.)	Volume (ft ³)
C-HF3R-37	52	37	1.1	0.2
C-HF3R-45	64	45	1.3	0.3
C-HF3R-53	67	53	1.5	0.3
C-HF3R-61	69	61	1.7	0.3
C-HF3R-69	71	69	1.9	0.4
C-HF3R-77	73	77	2.1	0.4
C-HF3R-85	85	85	2.3	0.5
C-HF3R-93	98	93	2.5	0.5
C-HF3R-101	101	101	2.7	0.6
C-HF3R-109	103	109	2.9	0.6

panel frames & connectors | 90-degree 4-way connection filler



90-degree 4-way connection filler

what's included:

90-degree 4-way connection filler, top cap, connection hardware.

application notes:

Use the 90-degree 4-way connection filler to connect four panel frames that are the same height.

how to specify:

Specify panel trim finish.

A metal color must be specified for the top cap finish.

options

height	37, 45, 53, 61, 69, 77, 85, 93, 101, 109
top cap finish	metal colors

how to order and read your code

Sample Order: 90-degree 4-way connection filler, 45-inches high, top cap finished in silver (P112).

NOTE: SAMPLE CODE HERE INCLUDES ALL AVAILABLE OPTIONS.

C	HF4R	45	P112
product line	item	height	top cap finish

panel frames & connectors | 90-degree 4-way connection filler

Code	Price	H (in.)	Weight (lb.)	Volume (ft ³)
C-HF4R-37	68	37	1.1	0.2
C-HF4R-45	87	45	1.3	0.3
C-HF4R-53	90	53	1.5	0.3
C-HF4R-61	93	61	1.7	0.3
C-HF4R-69	96	69	1.9	0.4
C-HF4R-77	99	77	2.1	0.4
C-HF4R-85	117	85	2.3	0.5
C-HF4R-93	136	93	2.5	0.5
C-HF4R-101	139	101	2.7	0.6
C-HF4R-109	143	109	2.9	0.6

panel frames & connectors | wall-to-panel connector



type 1



type 2



type 3

what's included:

Wall-to-Panel Connector (Type 1, 2 or 3, as specified), top cap, connection hardware for drywall applications.

application notes:

Wall-to-panel connectors fill in the gap between the wall and the panel. Type 1 connectors allow for an adjustment range of 2.25 to 3.25-inches, Type 2 connectors allow for an adjustment range of 3 to 4.25-inches, and Type 3 connectors allow for an adjustment range of 4 to 5.25-inches.

The top cap is 6-inches and must be cut to the proper size on-site.

how to specify:

Specify panel trim finish.

A metal color must be specified for the top cap finish.

The wall-to-panel connector finish color defaults to match the top cap.

options

type	1 type 1	2 type 2	3 type 3
height	37, 45, 53, 61, 69, 77, 85, 93, 101, 109		
top cap finish	metal colors		
raceway finish	metal colors		

how to order and read your code

Sample Order: Wall-to-panel connector, type 2, 61-inches high, top cap finished in espresso sparkle (P117).

NOTE: SAMPLE CODE HERE INCLUDES ALL AVAILABLE OPTIONS.

C product line	HWA item	2 type	61 height	P117 top cap finish
----------------------	-------------	-----------	--------------	---------------------------

panel frames & connectors | wall-to-panel connector

Code	Price	H (in.)	Weight (lb.)	Volume (ft ³)
Type 1 (2.25 to 3.25-inches)				
C-HWA1-37	167	37	1.1	0.2
C-HWA1-45	177	45	1.3	0.3
C-HWA1-53	188	53	1.5	0.3
C-HWA1-61	208	61	1.7	0.4
C-HWA1-69	218	69	1.9	0.4
C-HWA1-77	231	77	2.1	0.5
C-HWA1-85	243	85	2.3	0.5
C-HWA1-93	261	93	2.5	0.6
C-HWA1-101	272	101	2.7	0.6
C-HWA1-109	285	109	2.9	0.7
Type 2 (3.00 to 4.25-inches)				
C-HWA2-37	170	37	1.1	0.4
C-HWA2-45	181	45	1.3	0.4
C-HWA2-53	194	53	1.5	0.5
C-HWA2-61	213	61	1.7	0.6
C-HWA2-69	225	69	1.9	0.7
C-HWA2-77	238	77	2.1	0.7
C-HWA2-85	252	85	2.3	0.8
C-HWA2-93	269	93	2.5	0.9
C-HWA2-101	281	101	2.7	1
C-HWA2-109	297	109	2.9	1
Type 3 (4.00 to 5.25-inches)				
C-HWA3-37	173	37	1.1	0.4
C-HWA3-45	185	45	1.3	0.4
C-HWA3-53	198	53	1.5	0.5
C-HWA3-61	218	61	1.7	0.6
C-HWA3-69	232	69	1.9	0.7
C-HWA3-77	244	77	2.1	0.7
C-HWA3-85	260	85	2.3	0.8
C-HWA3-93	277	93	2.5	0.9
C-HWA3-101	289	101	2.7	1
C-HWA3-109	305	109	2.9	1

panel frames & connectors | floor grippers



carpet floors



non-carpet floors

what's included:
Floor Gripper (for carpet floors or non-carpet floors, as specified)

how to specify:
There are no color options for floor grippers.

application notes:
Floor grippers stabilize panels on either carpet floors or non-carpet floors.

options

type	C carpeted floors	N non-carpeted floors
------	-------------------	-----------------------

how to order and read your code

Sample Order: Floor grippers, non-carpeted floors.

NOTE: SAMPLE CODE HERE INCLUDES ALL AVAILABLE OPTIONS.



panel frames & connectors | floor grippers

Code	Price	Weight (lb.)	Volume (ft ³)
Carpet Floors			
C-HGC0	3	0.1	0.01
Non-Carpet Floors			
C-HGN0	3	0.1	0.01

tiles | acoustic tackable fabric tile

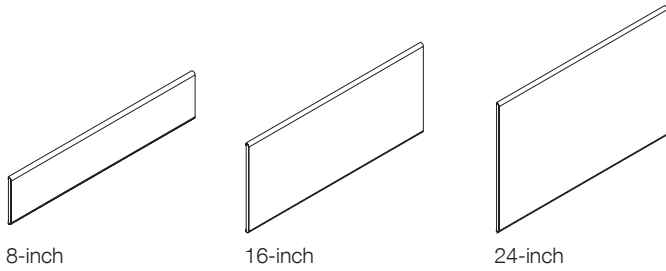

what's included:

Acoustic Tackable Fabric Tile, installation hardware.

how to specify:

Refer to the Finishes section of the Tayco binder for a complete listing of panel fabrics.

application notes:

Acoustic tackable fabric tiles provide acoustical privacy and a tackable vertical surface.

options

fabric grade	1 grade 1	2 grade 2	3 grade 3
height	8, 16, 24		
width	18, 24, 30, 36, 42, 48, 54, 60		
finish	panel fabrics		

how to order and read your code

Sample Order: Acoustic tackable tile, grade 1 fabric, 16-inches high, 42-inches wide, finished in Crosstown, Stucco (1121).

NOTE: SAMPLE CODE HERE INCLUDES ALL AVAILABLE OPTIONS.

C product line	PTA item	1 fabric grade	16 height	42 width	1121 finish
----------------------	-------------	----------------------	--------------	-------------	----------------

tiles | acoustic tackable fabric tile

Code	Grade 1 (PTF1)	Grade 2 (PTF2)	Grade 3 (PTF3)	H (in.)	W (in.)	Weight (lb.)	Volume (ft ³)
C-PTA_-0818	62	64	66	8	18	1.9	0.1
C-PTA_-0824	64	66	68	8	24	2.4	0.1
C-PTA_-0830	67	69	71	8	30	3.1	0.1
C-PTA_-0836	77	81	85	8	36	3.7	0.1
C-PTA_-0842	80	84	89	8	42	4.4	0.1
C-PTA_-0848	82	87	91	8	48	5	0.1
C-PTA_-0854	85	90	94	8	54	5.6	0.2
C-PTA_-0860	88	92	96	8	60	6.2	0.2
C-PTA_-1618	70	74	78	16	18	3.7	0.1
C-PTA_-1624	74	78	81	16	24	5	0.1
C-PTA_-1630	78	81	84	16	30	6.2	0.2
C-PTA_-1636	92	100	106	16	36	7.5	0.2
C-PTA_-1642	96	103	110	16	42	8.7	0.2
C-PTA_-1648	100	107	113	16	48	10	0.3
C-PTA_-1654	103	110	116	16	54	11.2	0.3
C-PTA_-1660	107	113	122	16	60	12.5	0.4
C-PTA_-2418	80	84	89	24	18	5.6	0.2
C-PTA_-2424	84	89	93	24	24	7.3	0.2
C-PTA_-2430	89	93	99	24	30	9.3	0.3
C-PTA_-2436	108	117	127	24	36	11.2	0.3
C-PTA_-2442	112	123	131	24	42	13.1	0.4
C-PTA_-2448	116	127	136	24	48	14.9	0.4
C-PTA_-2454	122	131	141	24	54	16.8	0.5
C-PTA_-2460	126	135	145	24	60	18.7	0.5

cosmopolitan | monolithic fabric tile

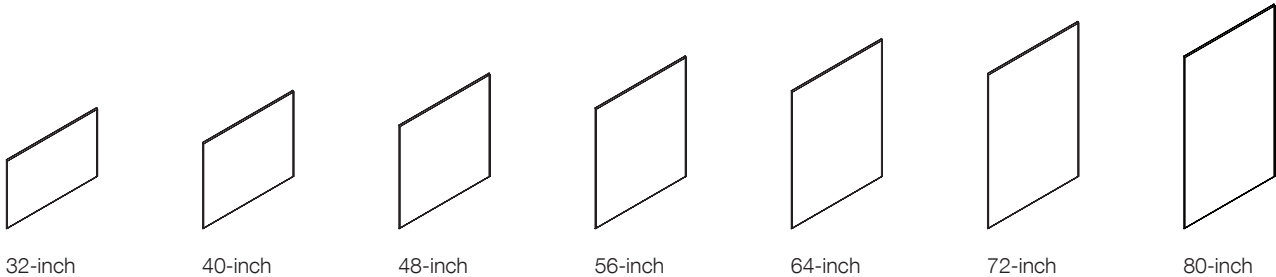

what's included:
 Monolithic fabric tile, installation hardware.

how to specify:
 Refer to the Finishes of the Tayco binder for a complete listing of panel fabrics.

application notes:
 Monolithic fabric tiles are solid-faced, tackable and offer visual and acoustical privacy.

Monolithic tiles are five inches less than the complete height of the panel frame.

options

fabric grade	1 grade 1	2 grade 2	3 grade 3
height	32, 40, 48, 56, 64, 72, 80		
width	18, 24, 30, 36, 42, 48		
finish	panel fabrics		

how to order and read your code

Sample Order: Fabric monolithic tile, grade 1 fabric, 56-inches high, 36-inches wide, finished in Dune, Deep Night (2311).

NOTE: SAMPLE CODE HERE INCLUDES ALL AVAILABLE OPTIONS.

C product line	PMA item	1 fabric grade	56 height	36 width	2311 finish
----------------------	-------------	----------------------	--------------	-------------	----------------

cosmopolitan | monolithic fabric tile

Code	Grade 1	Grade 2	Grade 3	H (in.)	W (in.)	Weight (lb.)	Volume (ft ³)
C-PMA1-3218	89	95	101	32	18	0	0.3
C-PMA1-3224	94	101	106	32	24	0	0.4
C-PMA1-3230	100	106	111	32	30	0	0.6
C-PMA1-3236	124	136	148	32	36	0	0.7
C-PMA1-3242	129	142	152	32	42	0	0.8
C-PMA1-3248	134	147	158	32	48	0	0.9
C-PMA1-3254	139	152	164	32	54	0	1
C-PMA1-3260	145	157	169	32	60	0	1.1
C-PMA1-4018	99	106	112	40	18	0	0.4
C-PMA1-4024	104	111	119	40	24	0	0.6
C-PMA1-4030	110	117	125	40	30	0	0.7
C-PMA1-4036	139	155	169	40	36	0	0.8
C-PMA1-4042	146	161	174	40	42	0	1
C-PMA1-4048	151	167	180	40	48	0	1.1
C-PMA1-4054	158	173	187	40	54	0	1.2
C-PMA1-4060	165	179	193	40	60	0	1.3
C-PMA1-4818	107	115	125	48	18	0	0.5
C-PMA1-4824	114	124	131	48	24	0	0.7
C-PMA1-4830	122	130	138	48	30	0	0.8
C-PMA1-4836	156	173	190	48	36	0	1
C-PMA1-4842	163	179	196	48	42	0	1.2
C-PMA1-4848	170	187	203	48	48	0	1.3
C-PMA1-4854	176	194	210	48	54	0	1.4
C-PMA1-4860	182	201	217	48	60	0	1.5
C-PMA1-5618	119	129	138	56	18	0	0.6
C-PMA1-5624	128	137	147	56	24	0	0.8
C-PMA1-5630	136	146	156	56	30	0	1
C-PMA1-5636	176	196	215	56	36	0	1.2
C-PMA1-5642	185	204	224	56	42	0	1.4
C-PMA1-5648	194	213	233	56	48	0	1.6
C-PMA1-5654	202	221	241	56	54	0	1.8
C-PMA1-5660	211	232	250	56	60	0	2
C-PMA1-6418	128	139	149	64	18	0	0.7
C-PMA1-6424	137	148	159	64	24	0	0.9
C-PMA1-6430	147	158	169	64	30	0	1.1
C-PMA1-6436	192	214	236	64	36	0	1.3
C-PMA1-6442	201	224	245	64	42	0	1.6
C-PMA1-6448	211	234	254	64	48	0	1.8
C-PMA1-6454	219	242	264	64	54	0	2
C-PMA1-6460	230	252	274	64	60	0	2.2
C-PMA1-7218	139	152	165	72	18	0	0.8
C-PMA1-7224	150	164	175	72	24	0	1
C-PMA1-7230	161	174	186	72	30	0	1.3
C-PMA1-7236	212	238	261	72	36	0	1.5
C-PMA1-7242	224	249	273	72	42	0	1.8
C-PMA1-7248	235	260	283	72	48	0	2
C-PMA1-8018	148	163	175	80	18	0	0.8
C-PMA1-8024	160	174	187	80	24	0	1.1
C-PMA1-8030	172	186	199	80	30	0	1.4
C-PMA1-8036	229	255	281	80	36	0	1.7
C-PMA1-8042	240	268	295	80	42	0	1.9
C-PMA1-8048	252	280	306	80	48	0	2.2

tiles | acrylic tiles

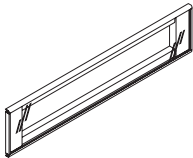

8-inch

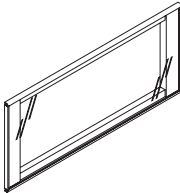

16-inch

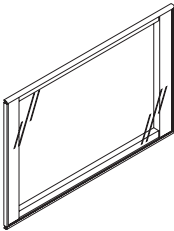

24-inch

what's included:

Acrylic tile, installation hardware.

how to specify:

Refer to the Finishes binder for a complete listing of metal colors.

application notes:

Acrylic tiles are priced by piece, not by pair.

options

acrylic options	C clear	F frosted	B bronze	L fluted
height	8, 16, 24			
width	18, 24, 30, 36, 42, 48, 54, 60			
tile frame finish	metal colors			

how to order and read your code

Sample Order: Acrylic tile, clear acrylic, 24-inches high, 60-inches wide, tile frame finished in silver (P112).

NOTE: SAMPLE CODE HERE INCLUDES ALL AVAILABLE OPTIONS.

C product line	PTG item	C acrylic options	24 height	60 width	P112 tile frame finish
----------------------	-------------	-------------------------	--------------	-------------	------------------------------

tiles | acrylic tiles

Code	Price	H (in.)	W (in.)	Weight (lb.)	Volume (ft ³)
Clear Acrylic					
C-PTGC-0818	123	8	18	2.1	0.1
C-PTGC-0824	133	8	24	2.6	0.1
C-PTGC-0830	145	8	30	3	0.1
C-PTGC-0836	156	8	36	3.5	0.1
C-PTGC-0842	169	8	42	4	0.1
C-PTGC-0848	182	8	48	4.4	0.1
C-PTGC-0854	194	8	54	4.9	0.2
C-PTGC-0860	204	8	60	5.4	0.2
C-PTGC-1618	148	16	18	3.3	0.1
C-PTGC-1624	165	16	24	4	0.1
C-PTGC-1630	179	16	30	4.7	0.2
C-PTGC-1636	198	16	36	5.5	0.2
C-PTGC-1642	216	16	42	6.2	0.2
C-PTGC-1648	232	16	48	6.9	0.3
C-PTGC-1654	247	16	54	7.6	0.3
C-PTGC-1660	263	16	60	8.3	0.4
C-PTGC-2418	177	24	18	4.5	0.2
C-PTGC-2424	198	24	24	5.5	0.2
C-PTGC-2430	220	24	30	6.5	0.3
C-PTGC-2436	241	24	36	7.4	0.3
C-PTGC-2442	264	24	42	8.1	0.4
C-PTGC-2448	283	24	48	9.4	0.4
C-PTGC-2454	304	24	54	10.3	0.5
C-PTGC-2460	330	24	60	11.3	0.5
Frosted Acrylic					
C-PTGF-0818	130	8	18	2.1	0.1
C-PTGF-0824	144	8	24	2.6	0.1
C-PTGF-0830	157	8	30	3	0.1
C-PTGF-0836	171	8	36	3.5	0.1
C-PTGF-0842	187	8	42	4	0.1
C-PTGF-0848	203	8	48	4.4	0.1
C-PTGF-0854	217	8	54	4.9	0.2
C-PTGF-0860	231	8	60	5.4	0.2
C-PTGF-1618	165	16	18	3.3	0.1
C-PTGF-1624	186	16	24	4	0.1
C-PTGF-1630	207	16	30	4.7	0.2
C-PTGF-1636	231	16	36	5.5	0.2
C-PTGF-1642	254	16	42	6.2	0.2
C-PTGF-1648	275	16	48	6.9	0.3
C-PTGF-1654	297	16	54	7.6	0.3
C-PTGF-1660	318	16	60	8.3	0.4
C-PTGF-2418	201	24	18	4.5	0.2
C-PTGF-2424	231	24	24	5.5	0.2
C-PTGF-2430	262	24	30	6.5	0.3
C-PTGF-2436	289	24	36	7.4	0.3
C-PTGF-2442	321	24	42	8.5	0.4
C-PTGF-2448	349	24	48	9.4	0.4
C-PTGF-2454	379	24	54	10.3	0.5
C-PTGF-2460	412	24	60	11.3	0.5

continues next page

tiles | acrylic tiles continued

Code	Price	H (in.)	W (in.)	Weight (lb.)	Volume (ft ³)
Bronze Acrylic					
C-PTGB-0818	123	8	18	2.1	0.1
C-PTGB-0824	133	8	24	2.6	0.1
C-PTGB-0830	144	8	30	3	0.1
C-PTGB-0836	155	8	36	3.5	0.1
C-PTGB-0842	169	8	42	4	0.1
C-PTGB-0848	181	8	48	4.4	0.1
C-PTGB-0854	194	8	54	4.9	0.2
C-PTGB-0860	204	8	60	5.4	0.2
C-PTGB-1618	148	16	18	3.3	0.1
C-PTGB-1624	164	16	24	4	0.1
C-PTGB-1630	179	16	30	4.7	0.2
C-PTGB-1636	197	16	36	5.5	0.2
C-PTGB-1642	215	16	42	6.2	0.2
C-PTGB-1648	231	16	48	6.9	0.3
C-PTGB-1654	246	16	54	7.6	0.3
C-PTGB-1660	262	16	60	8.3	0.4
C-PTGB-2418	176	24	18	4.5	0.2
C-PTGB-2424	197	24	24	5.5	0.2
C-PTGB-2430	219	24	30	6.5	0.3
C-PTGB-2436	239	24	36	7.4	0.3
C-PTGB-2442	262	24	42	8.1	0.4
C-PTGB-2448	281	24	48	9.4	0.4
C-PTGB-2454	302	24	54	10.3	0.5
C-PTGB-2460	327	24	60	11.3	0.5
Fluted Acrylic					
C-PTGL-0818	115	8	18	1.7	0.1
C-PTGL-0824	126	8	24	2	0.1
C-PTGL-0830	134	8	30	2.3	0.1
C-PTGL-0836	143	8	36	2.6	0.1
C-PTGL-0842	155	8	42	3	0.1
C-PTGL-0848	166	8	48	3.3	0.1
C-PTGL-0854	175	8	54	3.6	0.2
C-PTGL-0860	184	8	60	3.9	0.2
C-PTGL-1618	136	16	18	2.4	0.1
C-PTGL-1624	148	16	24	2.8	0.1
C-PTGL-1630	159	16	30	2.9	0.2
C-PTGL-1636	174	16	36	3.6	0.2
C-PTGL-1642	187	16	42	4	0.2
C-PTGL-1648	199	16	48	4.4	0.3
C-PTGL-1654	211	16	54	4.8	0.3
C-PTGL-1660	221	16	60	5.2	0.4
C-PTGL-2418	159	24	18	3.1	0.2
C-PTGL-2424	173	24	24	3.6	0.2
C-PTGL-2430	191	24	30	4.1	0.3
C-PTGL-2436	204	24	36	4.6	0.3
C-PTGL-2442	220	24	42	5.1	0.4
C-PTGL-2448	235	24	48	5.6	0.4
C-PTGL-2454	249	24	54	6.1	0.5
C-PTGL-2460	268	24	60	6.5	0.5

tiles | laminate tile



8-inch



16-inch

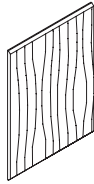

24-inch

what's included:

Laminate tile, installation hardware.

how to specify:

Refer to the laminate card for a complete listing of laminates.

application notes:

Laminate tiles provide an easy to clean hard surface.

options

height	8, 16, 24
width	18, 24, 30, 36, 42, 48, 54, 60
finish	laminate colors

how to order and read your code

Sample Order: Laminate tile, 16-inches high, 42-inches wide, finished in amber laminate (L111).

NOTE: SAMPLE CODE HERE INCLUDES ALL AVAILABLE OPTIONS.

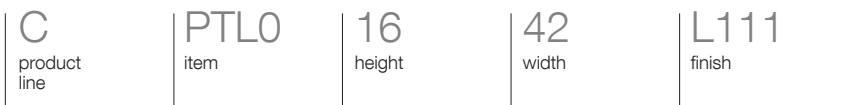

tiles | laminate tile

Code	Price	H (in.)	W (in.)	Weight (lb.)	Volume (ft ³)
C-PTL0-0818	66	8	18	1.8	0.06
C-PTL0-0824	70	8	24	2.4	0.08
C-PTL0-0830	76	8	30	3.1	0.1
C-PTL0-0836	80	8	36	3.7	0.11
C-PTL0-0842	85	8	42	4.4	0.13
C-PTL0-0848	89	8	48	5	0.15
C-PTL0-0854	96	8	54	5.7	0.17
C-PTL0-0860	100	8	60	6.3	0.19
C-PTL0-1618	77	16	18	3.7	0.11
C-PTL0-1624	83	16	24	4.9	0.15
C-PTL0-1630	92	16	30	6.2	0.19
C-PTL0-1636	99	16	36	7.5	0.23
C-PTL0-1642	107	16	42	8.7	0.27
C-PTL0-1648	115	16	48	9.1	0.31
C-PTL0-1654	124	16	54	10.3	0.35
C-PTL0-1660	132	16	60	11.5	0.39
C-PTL0-2418	89	24	18	5.6	0.17
C-PTL0-2424	99	24	24	7.3	0.23
C-PTL0-2430	110	24	30	9.3	0.29
C-PTL0-2436	121	24	36	11.2	0.34
C-PTL0-2442	131	24	42	13.1	0.4
C-PTL0-2448	141	24	48	14.7	0.46
C-PTL0-2454	152	24	54	16.6	0.51
C-PTL0-2460	163	24	60	18.5	0.57

tiles | monolithic laminate tile

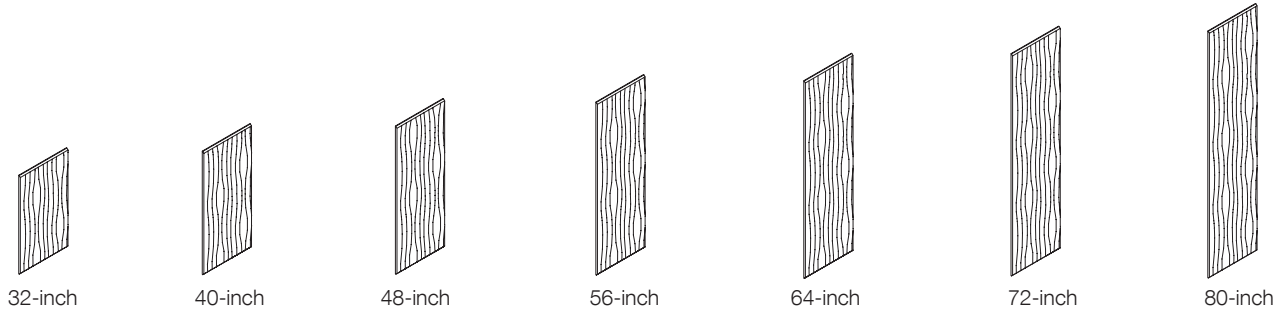

what's included:

Monolith laminate tile, installation hardware.

how to specify:

Refer to the laminate card for a complete listing of laminates.

application notes:

Monolithic laminate tiles provide an easy to clean hard surface.

Monolithic laminate tiles are five inches less than the complete height of the panel frame.

options

height	32, 40, 48, 56, 64, 72, 80
width	18, 24, 30, 36, 42, 48
finish	laminate colors

how to order and read your code

Sample Order: Laminate tile, 56-inches high, 42-inches wide, finished in amber laminate (L111).

NOTE: SAMPLE CODE HERE INCLUDES ALL AVAILABLE OPTIONS.

C product line	PTL0 item	56 height	42 width	L111 finish
----------------------	--------------	--------------	-------------	----------------

tiles | monolithic laminate tile

Code	Price	H (in.)	W (in.)	Weight (lb.)	Volume (ft ³)
C-PTLO-3218	99	32	18	30	0.23
C-PTLO-3224	110	32	24	31	0.31
C-PTLO-3230	126	32	30	32	0.38
C-PTLO-3236	138	32	36	33	0.46
C-PTLO-3242	152	32	42	34	0.53
C-PTLO-3248	165	32	48	35	0.61
C-PTLO-3254	198	32	54	36	0.68
C-PTLO-3260	235	32	60	37	0.76
C-PTLO-4018	110	40	18	30	0.29
C-PTLO-4024	126	40	24	31	0.38
C-PTLO-4030	141	40	30	32	0.48
C-PTLO-4036	159	40	36	33	0.57
C-PTLO-4042	174	40	42	34	0.67
C-PTLO-4048	191	40	48	35	0.76
C-PTLO-4054	225	40	54	36	0.85
C-PTLO-4060	264	40	60	37	0.93
C-PTLO-4818	122	48	18	32	0.34
C-PTLO-4824	139	48	24	33	0.46
C-PTLO-4830	158	48	30	35	0.57
C-PTLO-4836	178	48	36	36	0.69
C-PTLO-4842	197	48	42	38	0.8
C-PTLO-4848	215	48	48	39	0.92
C-PTLO-4854	253	48	54	40	1.03
C-PTLO-4860	295	48	60	41	1.15
C-PTLO-5618	139	56	18	36	0.4
C-PTLO-5624	161	56	24	37	0.53
C-PTLO-5630	181	56	30	39	0.67
C-PTLO-5636	206	56	36	40	0.8
C-PTLO-5642	228	56	42	42	0.94
C-PTLO-5648	247	56	48	44	1.07
C-PTLO-6418	149	64	18	42	0.46
C-PTLO-6424	173	64	24	44	0.61
C-PTLO-6430	197	64	30	46	0.76
C-PTLO-6436	224	64	36	45	0.92
C-PTLO-6442	247	64	42	48	1.07
C-PTLO-6448	272	64	48	50	1.22
C-PTLO-7218	163	72	18	26	0.52
C-PTLO-7224	190	72	24	35	0.69
C-PTLO-7230	216	72	30	43	0.86
C-PTLO-7236	245	72	36	52	1.03
C-PTLO-7242	273	72	42	60	1.2
C-PTLO-7248	299	72	48	69	1.38
C-PTLO-8018	172	80	18	29	0.57
C-PTLO-8024	202	80	24	38	0.76
C-PTLO-8030	232	80	30	48	0.95
C-PTLO-8036	264	80	36	58	1.15
C-PTLO-8042	294	80	42	67	1.34
C-PTLO-8048	322	80	48	77	1.53

tiles | perforated metal tile

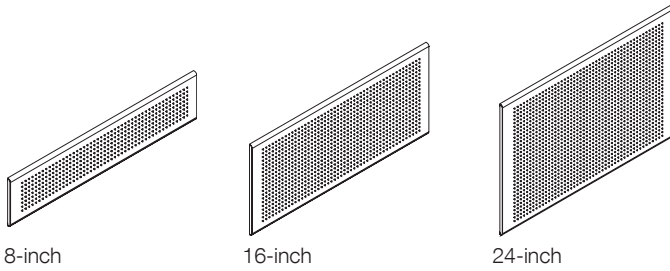

what's included:
Perforated metal tile, installation hardware.

how to specify:
Refer to the metal/vinyl card for a complete listing of metal colors.

application notes:
Perforated metal tiles provide a unique architectural element, while allowing for airflow.

options

height	8, 16, 24
width	18, 24, 30, 36, 42, 48, 54, 60
finish	metal colors

how to order and read your code

Sample Order: Perforated metal tile, 16-inches high, 48-inches wide, finished in espresso sparkle (P117).

NOTE: SAMPLE CODE HERE INCLUDES ALL AVAILABLE OPTIONS.

C product line	PTM0 item	16 height	48 width	P117 finish
----------------------	--------------	--------------	-------------	----------------

tiles | perforated metal tile

Code	Price	H (in.)	W (in.)	Weight (lb.)	Volume (ft ³)
C-PTM0-0818	64	8	18	1.5	0.1
C-PTM0-0824	69	8	24	2	0.1
C-PTM0-0830	73	8	30	2.5	0.1
C-PTM0-0836	78	8	36	3.1	0.1
C-PTM0-0842	83	8	42	3.6	0.1
C-PTM0-0848	89	8	48	4.1	0.1
C-PTM0-0854	95	8	54	4.6	0.2
C-PTM0-0860	100	8	60	5.1	0.2
C-PTM0-1618	81	16	18	3	0.1
C-PTM0-1624	88	16	24	4.1	0.1
C-PTM0-1630	94	16	30	5.1	0.2
C-PTM0-1636	101	16	36	6.1	0.2
C-PTM0-1642	108	16	42	7.1	0.2
C-PTM0-1648	116	16	48	8.1	0.3
C-PTM0-1654	125	16	54	9.1	0.3
C-PTM0-1660	133	16	60	10.2	0.4
C-PTM0-2418	101	24	18	4.6	0.2
C-PTM0-2424	112	24	24	6.1	0.2
C-PTM0-2430	124	24	30	7.6	0.3
C-PTM0-2436	135	24	36	9.2	0.3
C-PTM0-2442	147	24	42	10.7	0.4
C-PTM0-2448	160	24	48	12.2	0.4
C-PTM0-2454	172	24	54	13.7	0.5
C-PTM0-2460	182	24	60	15.2	0.5

tiles | whiteboard tile

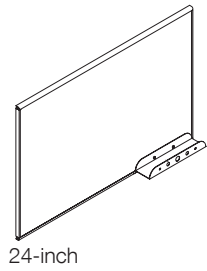
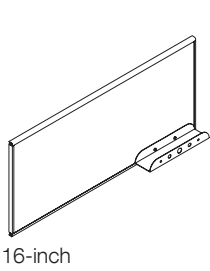

what's included:

Whiteboard Tile, installation hardware, eraser support.

how to specify:

Refer to the metal/vinyl card for a complete listing of metal colors.

application notes:

Only dry erase marker should be used on whiteboard tiles.

options

height	16, 24
width	18, 24, 30, 36, 42, 48, 54, 60
finish	metal colors

how to order and read your code

Sample Order: Whiteboard tile, 24-inches high, 54-inches wide, finished in Polished Metal (P116).

NOTE: SAMPLE CODE HERE INCLUDES ALL AVAILABLE OPTIONS.

C product line	PTW0 item	24 height	54 width	P116 finish
----------------------	--------------	--------------	-------------	----------------

tiles | whiteboard tile

Code	Price	H (in.)	W (in.)	Weight (lb.)	Volume (ft ³)
C-PTW0-1618	136	16	18	3.2	0.1
C-PTW0-1624	146	16	24	3.1	0.1
C-PTW0-1630	155	16	30	4.5	0.2
C-PTW0-1636	165	16	36	5.2	0.2
C-PTW0-1642	178	16	42	5.9	0.2
C-PTW0-1648	187	16	48	6.5	0.3
C-PTW0-1654	197	16	54	7.2	0.3
C-PTW0-1660	209	16	60	7.9	0.4
C-PTW0-2418	156	24	18	4.4	0.2
C-PTW0-2424	167	24	24	5.3	0.2
C-PTW0-2430	177	24	30	6.2	0.3
C-PTW0-2436	191	24	36	7	0.3
C-PTW0-2442	203	24	42	7.9	0.4
C-PTW0-2448	213	24	48	8.8	0.4
C-PTW0-2454	226	24	54	9.7	0.5
C-PTW0-2460	237	24	60	10.6	0.5

tiles | magnetic whiteboard tile

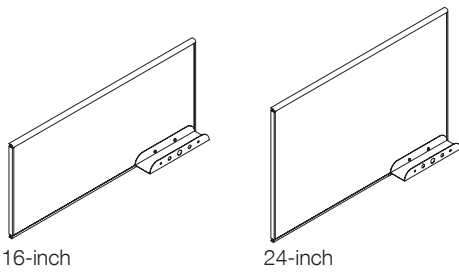

what's included:

Magnetic whiteboard tile, installation hardware, eraser support.

how to specify:

Refer to the metal/vinyl card for a complete listing of metal colors.

application notes:

Only dry erase marker should be used on magnetic whiteboard tiles.

options

height	16, 24
width	18, 24, 30, 36, 42, 48, 54, 60
finish	metal colors

how to order and read your code

Sample Order: Whiteboard tile, 24-inches high, 54-inches wide, finished in Polished Metal (P116).

NOTE: SAMPLE CODE HERE INCLUDES ALL AVAILABLE OPTIONS.

C product line	PTWM item	24 height	54 width	P116 finish
----------------------	--------------	--------------	-------------	----------------

tiles | magnetic whiteboard tile

Code	Price	H (in.)	W (in.)	Weight (lb.)	Volume (ft ³)
C-PTWM-1618	161	16	18	3.2	0.1
C-PTWM-1624	173	16	24	3.1	0.1
C-PTWM-1630	186	16	30	4.5	0.2
C-PTWM-1636	198	16	36	5.2	0.2
C-PTWM-1642	215	16	42	5.9	0.2
C-PTWM-1648	229	16	48	6.5	0.3
C-PTWM-1654	241	16	54	7.2	0.3
C-PTWM-1660	255	16	60	7.9	0.4
C-PTWM-2418	184	24	18	4.4	0.2
C-PTWM-2424	199	24	24	5.3	0.2
C-PTWM-2430	214	24	30	6.2	0.3
C-PTWM-2436	232	24	36	7	0.3
C-PTWM-2442	249	24	42	7.9	0.4
C-PTWM-2448	264	24	48	8.8	0.4
C-PTWM-2454	281	24	54	9.7	0.5
C-PTWM-2460	297	24	60	10.6	0.5

tiles | pass-through tile

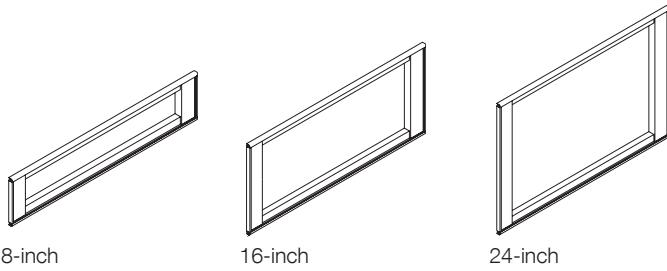

what's included:
 Pass-Through Tile, installation hardware.

how to specify:
 Refer to the metal/vinyl card for a complete listing of metal colors.

application notes:
 The pass-through tile allows data and communication cables to be shared between workstations.

options

height	16, 24
width	18, 24, 30, 36, 42, 48, 54, 60
tile frame finish	metal colors

how to order and read your code

Sample Order: Pass-through tile, 16-inches high, 54-inches wide, tile frame finished in Silver (P112).

NOTE: SAMPLE CODE HERE INCLUDES ALL AVAILABLE OPTIONS.

C	PT00	16	54	P112
product line	item	height	width	tile frame finish

tiles | pass-through tile

Code	Price	H (in.)	W (in.)	Weight (lb.)	Volume (ft ³)
C-PTO0-0818	99	8	18	1.5	0.1
C-PTO0-0824	106	8	24	1.7	0.1
C-PTO0-0830	112	8	30	2	0.1
C-PTO0-0836	119	8	36	2.2	0.1
C-PTO0-0842	128	8	42	2.5	0.1
C-PTO0-0848	134	8	48	2.7	0.1
C-PTO0-0854	142	8	54	3	0.2
C-PTO0-0860	148	8	60	3.2	0.2
C-PTO0-1618	111	16	18	2	0.1
C-PTO0-1624	119	16	24	2.2	0.1
C-PTO0-1630	126	16	30	2.5	0.2
C-PTO0-1636	132	16	36	2.7	0.2
C-PTO0-1642	141	16	42	3	0.2
C-PTO0-1648	147	16	48	3.2	0.3
C-PTO0-1654	155	16	54	3.5	0.3
C-PTO0-1660	161	16	60	3.7	0.4
C-PTO0-2418	128	24	18	2.5	0.2
C-PTO0-2424	134	24	24	2.7	0.2
C-PTO0-2430	141	24	30	3	0.3
C-PTO0-2436	147	24	36	3.2	0.3
C-PTO0-2442	156	24	42	3.5	0.4
C-PTO0-2448	164	24	48	3.7	0.4
C-PTO0-2454	170	24	54	4	0.5
C-PTO0-2460	176	24	60	4.3	0.5

tiles | fabric flip-up belt-line tile

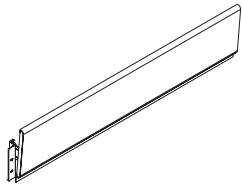

8-inch

what's included:

Fabric Flip-Up Belt-Line Tile, installation hardware.

how to specify:

Refer to the Finishes section of the Tayco binder for a complete listing of panel fabrics.

application notes:

The fabric flip-up belt-line tile can be used in place of an 8-inch high tile at desk height when access to power, data and communication is required at the belt-line.

The fabric flip-up belt-line tile is compatible with panel frames that have flip-up capability. See pages 16 & 21 for details.

options

fabric grade	1 grade 1	2 grade 2	3 grade 3
height	8		
width	18, 24, 30, 36, 42, 48, 54, 60		
finish	panel fabrics		

how to order and read your code

Sample Order: Fabric flip-up, belt-line tile, grade 2 fabric, 8-inches high, 36-inches wide, finished in Groove, Mocha (1942).

NOTE: SAMPLE CODE HERE INCLUDES ALL AVAILABLE OPTIONS.

C	PTB0	2	8	36	1942
product line	item	fabric grade	height	width	finish

tiles | fabric flip-up belt-line tile

Code	Price	H (in.)	W (in.)	Weight (lb.)	Volume (ft ³)
C-PTB0-0818	144	8	18	1.9	0.1
C-PTB0-0824	149	8	24	2.9	0.1
C-PTB0-0830	155	8	30	3.1	0.1
C-PTB0-0836	172	8	36	3.8	0.1
C-PTB0-0842	177	8	42	4.4	0.1
C-PTB0-0848	182	8	48	5	0.1
C-PTB0-0854	188	8	54	5.6	0.2
C-PTB0-0860	194	8	60	6.2	0.2

tiles | accessory tile

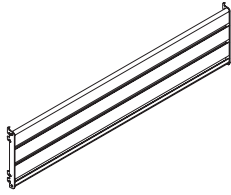

8-inch

what's included:

Accessory Tile, installation hardware.

how to specify:

Refer to the metal/vinyl card for a complete listing of metal colors.

application notes:

The accessory tile supports all personal organizers. Please refer to the accessories section of this price book for details.

options

height	8
width	18, 24, 30, 36, 42, 48, 54, 60
finish	metal colors

how to order and read your code

Sample Order: Accessory tile, 8-inches high, 48-inches wide, finished in Silver (P112).

NOTE: SAMPLE CODE HERE INCLUDES ALL AVAILABLE OPTIONS.

C product line	PTA0 item	8 height	48 width	P112 finish
----------------------	--------------	-------------	-------------	----------------

tiles | accessory tile

Code	Price	H (in.)	W (in.)	Weight (lb.)	Volume (ft ³)
C-PTA0-0818	89	8	18	3	0.1
C-PTA0-0824	103	8	24	3.8	0.1
C-PTA0-0830	117	8	30	4.7	0.1
C-PTA0-0836	133	8	36	5.6	0.1
C-PTA0-0842	148	8	42	6.4	0.1
C-PTA0-0848	164	8	48	7.3	0.1
C-PTA0-0854	177	8	54	8.2	0.2
C-PTA0-0860	193	8	60	9.1	0.2

worksurfaces | straight worksurface

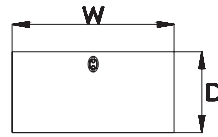
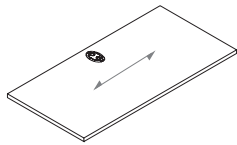

what's included:

Straight Worksurface, grommets (24 to 48-inch worksurfaces include one grommet, 54 to 84-inch worksurfaces include two grommets, 90 to 96-inch worksurfaces include three grommets).

application notes:

Grain direction is indicated in the above illustration. If you need the laminate wood grain direction to run from front to back please see bridge worksurfaces on page 117.

Keyboard trays can be mounted to this worksurface. Refer to the Accessories section for details.

how to specify:

Specify laminate color.

The worksurface trim color will default to match the laminate color unless otherwise specified, see the laminate finish card for details.

Not all laminate colors are available on 1.5-inch thick worksurfaces, see the laminate finish card for details and refer to the column "1.5-inch surface" or "Metropolis".

Edge profile must be specified for 1.5-inch thick worksurfaces. 1.5-inch thick worksurfaces are available in straight, gothic, and wave profiles.

options

thickness	C 1-inch	CT 1.5-inch
width	18, 24, 30, 36, 42, 48, 54, 60, 66, 72, 78, 84, 90, 96	
depth	24, 30, 36	
surface finish	laminate colors	
edge profile (1.5-inch only)	straight	gothic

how to order and read your code

Sample Order: 1-inch thick, straight worksurface, 54-inches wide, 30-inches deep, surface finished in Maple (L104), with matching trim color.

NOTE: SAMPLE CODE HERE INCLUDES ALL AVAILABLE OPTIONS.

C product line	WS0G item	54 width	30 depth	L104 surface finish	gothic edge profile
----------------------	--------------	-------------	-------------	---------------------------	---------------------------

worksurfaces | straight worksurface

Code	1" (C)	1.5" (CT)	W (in.)	D (in.)	Weight (lb.)	Volume (ft ³)
C_-WS0G-1818	158	212	18	18	8.18	0.19
C_-WS0G-2418	166	224	24	18	10.96	0.25
C_-WS0G-3018	178	238	30	18	13.73	0.31
C_-WS0G-3618	185	250	36	18	16.51	0.38
C_-WS0G-4218	210	283	42	18	19.29	0.44
C_-WS0G-4818	220	299	48	18	22.06	0.5
C_-WS0G-5418	263	354	54	18	24.69	0.56
C_-WS0G-6018	285	386	60	18	27.46	0.63
C_-WS0G-6618	325	441	66	18	30.24	0.69
C_-WS0G-7218	345	466	72	18	33.02	0.75
C_-WS0G-7818	374	506	78	18	35.8	0.81
C_-WS0G-8418	406	547	84	18	38.57	0.88
C_-WS0G-9018	461	625	90	18	41.2	0.94
C_-WS0G-9618	499	673	96	18	43.97	1
C_-WS0G-1824	169	230	18	24	10.96	0.25
C_-WS0G-2424	179	242	24	24	14.7	0.3
C_-WS0G-3024	190	258	30	24	18.4	0.4
C_-WS0G-3624	196	264	36	24	22.1	0.5
C_-WS0G-4224	230	310	42	24	25.8	0.6
C_-WS0G-4824	247	333	48	24	29.5	0.7
C_-WS0G-5424	298	403	54	24	33	0.8
C_-WS0G-6024	312	423	60	24	36.7	0.8
C_-WS0G-6624	347	469	66	24	40.4	0.9
C_-WS0G-7224	363	490	72	24	44.1	1
C_-WS0G-7824	394	534	78	24	47.8	1.1
C_-WS0G-8424	426	576	84	24	51.5	1.2
C_-WS0G-9024	485	656	90	24	55.1	1.3
C_-WS0G-9624	525	710	96	24	58.8	1.3
C_-WS0G-1830	178	238	18	30	13.73	0.31
C_-WS0G-2430	190	258	24	30	18.36	0.42
C_-WS0G-3030	224	302	30	30	22.99	0.52
C_-WS0G-3630	237	321	36	30	27.62	0.63
C_-WS0G-4230	258	346	42	30	32.25	0.73
C_-WS0G-4830	279	375	48	30	36.88	0.83
C_-WS0G-5430	311	420	54	30	41.35	0.94
C_-WS0G-6030	329	445	60	30	45.98	1.04
C_-WS0G-6630	375	507	66	30	50.61	1.15
C_-WS0G-7230	385	519	72	30	55.24	1.25
C_-WS0G-7830	419	567	78	30	59.86	1.35
C_-WS0G-8430	452	612	84	30	64.49	1.46
C_-WS0G-9030	515	695	90	30	68.97	1.56
C_-WS0G-9630	556	753	96	30	73.6	1.67
C_-WS0G-1836	185	250	18	36	13.73	0.38
C_-WS0G-2436	216	290	24	36	14.73	0.5
C_-WS0G-3036	237	321	30	36	15.73	0.63
C_-WS0G-3636	247	333	36	36	16.73	0.75
C_-WS0G-4236	267	362	42	36	17.73	0.88
C_-WS0G-4836	290	391	48	36	18.73	1
C_-WS0G-5436	324	437	54	36	19.73	1.13
C_-WS0G-6036	344	464	60	36	20.73	1.25
C_-WS0G-6636	391	530	66	36	21.73	1.38
C_-WS0G-7236	403	544	72	36	22.73	1.5
C_-WS0G-7836	437	591	78	36	23.73	1.63
C_-WS0G-8436	474	639	84	36	24.73	1.75
C_-WS0G-9036	539	727	90	36	25.73	1.88
C_-WS0G-9636	580	783	96	36	26.73	2

work surfaces | straight worksurface with power grommet

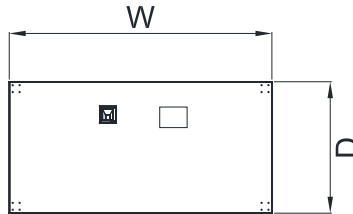
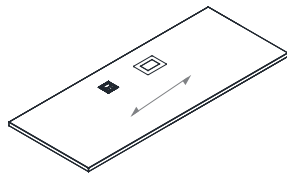

what's included:

Straight worksurface with a cable grommet and a power grommet.

how to specify:

Specify laminate colour.

application notes:

Grain direction is indicated in the above illustration.

The worksurface trim colour will default to match the laminate colour. Unless otherwise specified, see the laminate finish card for details.

Key board trays can be mounted to this worksurface. Refer to the accessories section for details.

Not all laminate colours are available in 1.5-inch thick worksurfaces, see the laminate finish card for details and refer to the column "1.5-inch surface" or "Metropolis."

Edge profile must be specified for 1.5-inch thick worksurfaces
1.5-inch thick worksurfaces are available in straight and gothic profiles.

options

thickness	C 1-inch CT 1.5-inch
width	36, 42, 48, 54, 60, 66, 72, 78, 84, 90, 96
depth	24, 30
surface finish	laminate colours
edge profile <small>(1.5-inch only)</small>	straight gothic

how to order and read your code

Sample Order: 1" thick melamine work surface with power grommet, 24" deep, 36" wide



worksurfaces | straight worksurface with power grommet

Code	Price	Width	Depth	Weight (lb.)	Volume (ft ³)	
1" Melamine						
C-WSPG-3624		670	36	24	17.28	0.5
C-WSPG-4224		704	42	24	20.16	0.58
C-WSPG-4824		721	48	24	23.04	0.67
C-WSPG-5424		772	54	24	25.92	0.75
C-WSPG-6024		786	60	24	28.8	0.83
C-WSPG-6624		821	66	24	31.68	0.92
C-WSPG-7224		837	72	24	34.56	1
C-WSPG-7824		868	78	24	37.44	1.08
C-WSPG-8424		900	84	24	40.32	1.17
C-WSPG-9024		959	90	24	43.2	1.25
C-WSPG-9624		999	96	24	46.08	1.33
C-WSPG-3630		711	36	30	21.6	0.63
C-WSPG-4230		732	42	30	25.2	0.73
C-WSPG-4830		753	48	30	28.8	0.83
C-WSPG-5430		785	54	30	32.4	0.94
C-WSPG-6030		803	60	30	36	1.04
C-WSPG-6630		849	66	30	39.6	1.15
C-WSPG-7230		859	72	30	43.2	1.25
C-WSPG-7830		893	78	30	46.8	1.35
C-WSPG-8430		926	84	30	50.4	1.46
C-WSPG-9030		989	90	30	54	1.56
C-WSPG-9630		1030	96	30	57.6	1.67
1.5" Melamine						
CT-WSPG-3624		738	36	24	23.28	0.5
CT-WSPG-4224		784	42	24	25.16	0.58
CT-WSPG-4824		807	48	24	28.04	0.67
CT-WSPG-5424		877	54	24	30.92	0.75
CT-WSPG-6024		897	60	24	33.8	0.83
CT-WSPG-6624		943	66	24	36.68	0.92
CT-WSPG-7224		964	72	24	39.56	1
CT-WSPG-7824		1008	78	24	42.44	1.08
CT-WSPG-8424		1050	84	24	45.32	1.17
CT-WSPG-9024		1130	90	24	48.2	1.25
CT-WSPG-9624		1184	96	24	51.08	1.33
CT-WSPG-3630		795	36	30	26.6	0.63
CT-WSPG-4230		820	42	30	30.2	0.73
CT-WSPG-4830		849	48	30	33.8	0.83
CT-WSPG-5430		894	54	30	37.4	0.94
CT-WSPG-6030		919	60	30	41	1.04
CT-WSPG-6630		981	66	30	44.6	1.15
CT-WSPG-7230		993	72	30	48.2	1.25
CT-WSPG-7830		1041	78	30	51.8	1.35
CT-WSPG-8430		1086	84	30	55.4	1.46
CT-WSPG-9030		1169	90	30	59	1.56
CT-WSPG-9630		1227	96	30	62.6	1.67

worksurfaces | straight worksurface with curved end

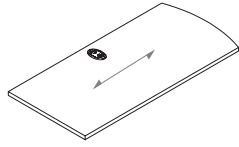

right hand curved end

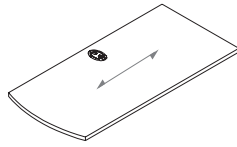

left hand curved end

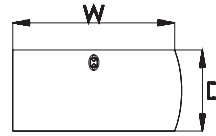

what's included:

Straight Worksurface with curved end, grommets (24 to 48-inch worksurfaces include one grommet, 54 to 84-inch worksurfaces include two grommets, 90-inch worksurfaces include three grommets).

application notes:

Grain direction is indicated in the above illustration.

Worksurfaces 54-inches and longer require a horizontal surface support (CH00), which must be specified separately.

how to specify:

Specify laminate color.

The straight worksurface with curved end must be specified as left or right. The handed end will be curved.

The worksurface trim color will default to match the laminate color unless otherwise specified, see the laminate finish card for details. Not all laminate colors are available on 1.5-inch thick worksurfaces, see the laminate finish card for details and refer to the column "1.5-inch surface" or "Metropolis".

Edge profile must be specified for 1.5-inch thick worksurfaces. 1.5-inch thick worksurfaces are available in straight, gothic, and wave profiles.

options

thickness	C 1-inch	CT 1.5-inch
hand	R right	L left
width	24, 30, 36, 42, 48, 54, 60, 66, 72, 78, 84, 90	
depth	18, 24, 30	
surface finish	laminate colors	
edge profile (1.5-inch only)	straight	gothic

how to order and read your code

Sample Order: 1.5-inch thick, straight with curved end, left handed, 42-inches wide, 24-inches deep, surface finished in Congo (L100), with matching trim color, wave profile.

NOTE: SAMPLE CODE HERE INCLUDES ALL AVAILABLE OPTIONS.

CT product line	WSLG item	42 width	24 depth	L100 surface finish	gothic edge profile
-----------------------	--------------	-------------	-------------	---------------------------	---------------------------

worksurfaces | straight worksurface with curved end

Code	1" (C)	1.5" (CT)	W (in.)	D (in.)	Weight (lb.)	Volume (ft ³)
C_-WS_G-1818	164	219	18	18	8.18	0.19
C_-WS_G-2418	175	234	24	18	10.96	0.25
C_-WS_G-3018	185	250	30	18	13.73	0.31
C_-WS_G-3618	196	264	36	18	16.51	0.38
C_-WS_G-4218	220	299	42	18	19.29	0.44
C_-WS_G-4818	232	314	48	18	22.06	0.5
C_-WS_G-5418	277	373	54	18	24.69	0.56
C_-WS_G-6018	300	407	60	18	27.46	0.63
C_-WS_G-6618	341	458	66	18	30.24	0.69
C_-WS_G-7218	361	485	72	18	33.02	0.75
C_-WS_G-7818	375	507	78	18	35.8	0.81
C_-WS_G-8418	423	571	84	18	35.57	0.88
C_-WS_G-9018	478	646	90	18	41.2	0.94
C_-WS_G-1824	171	233	18	24	10.96	0.25
C_-WS_G-2424	187	252	24	24	14.66	0.33
C_-WS_G-3024	200	268	30	24	18.36	0.42
C_-WS_G-3624	204	278	36	24	22.06	0.5
C_-WS_G-4224	242	325	42	24	25.77	0.58
C_-WS_G-4824	261	351	48	24	29.47	0.67
C_-WS_G-5424	312	423	54	24	33.02	0.75
C_-WS_G-6024	329	445	60	24	36.72	0.83
C_-WS_G-6624	363	490	66	24	40.42	0.92
C_-WS_G-7224	380	513	72	24	44.13	1
C_-WS_G-7824	412	556	78	24	47.83	1.08
C_-WS_G-8424	444	598	84	24	31.53	1.17
C_-WS_G-9024	505	679	90	24	55.08	1.25
C_-WS_G-1830	184	249	18	30	13.73	0.31
C_-WS_G-2430	200	268	24	30	18.36	0.42
C_-WS_G-3030	234	318	30	30	22.99	0.52
C_-WS_G-3630	250	340	36	30	27.62	0.63
C_-WS_G-4230	268	364	42	30	32.25	0.73
C_-WS_G-4830	293	393	48	30	36.88	0.83
C_-WS_G-5430	327	442	54	30	41.35	0.94
C_-WS_G-6030	346	468	60	30	45.98	1.04
C_-WS_G-6630	391	530	66	30	50.61	1.15
C_-WS_G-7230	404	545	72	30	55.24	1.25
C_-WS_G-7830	437	591	78	30	59.86	1.35
C_-WS_G-8430	474	639	84	30	64.49	1.46
C_-WS_G-9030	536	722	90	30	68.97	1.56

worksurfaces | wave return

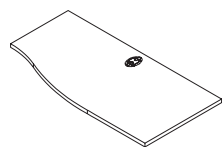

straight end
right hand

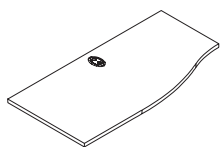

straight end
left hand

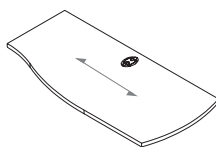

curved end
right hand

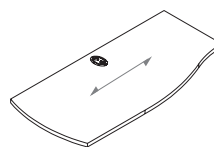

curved end
left hand

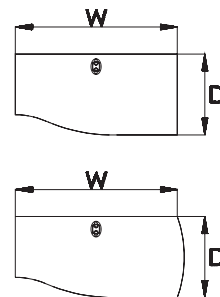

what's included:

Wave Return, grommets (24 to 48-inch worksurfaces include one grommet, 54 to 84-inch worksurfaces include two grommets, 90 to 96-inch worksurfaces include three grommets).

application notes:

Grain direction is indicated in the above illustration.

Worksurfaces 54-inches and longer require a horizontal surface support (CH00), which must be specified separately.

how to specify:

Specify laminate color.

The wave return work surface must be specified as left or right.

When the straight end is specified, the handed end will be deeper.

When the curved end is specified, the handed end will be deeper and curved.

The work surface trim color will default to match the laminate color unless otherwise specified, see the laminate finish card for details.

Not all laminate colors are available on 1.5-inch thick worksurfaces, see the laminate finish card for details and refer to the column "1.5-inch surface" or "Metropolis".

Edge profile must be specified for 1.5-inch thick worksurfaces. 1.5-inch thick worksurfaces are available in straight, gothic, and wave profiles.

options

thickness	C 1-inch	CT 1.5-inch
end shape	straight end	curved end
hand	R right	L left
width	30, 36, 42, 48, 54, 60, 66, 72, 78, 84, 90, 96	
depth	24, 30, 36	
surface finish	laminate colors	
edge profile (1.5-inch only)	straight	gothic

Sample Order: 1-inch thick, wave return, 54-inches wide, 30-inches deep, right-handed, surface finished in Congo (L100), with matching trim.

C product line	WWOG item	54 width	30 depth	R hand	L100 surface finish	gothic edge profile
----------------------	--------------	-------------	-------------	-----------	---------------------------	---------------------------

worksurfaces | wave return

Code	1" (C)	1.5" (CT)	W (in.)	D (in.)	Weight (lb.)	Volume (ft ³)
Straight End						
C_-WW0G-3024_-	196	264	30	24	27.54	0.63
C_-WW0G-3624_-	203	277	36	24	34.48	0.75
C_-WW0G-4224_-	242	325	42	24	38.65	0.88
C_-WW0G-4824_-	260	349	48	24	44.2	1
C_-WW0G-5424_-	298	403	54	24	49.53	1.13
C_-WW0G-6024_-	327	442	60	24	55.08	1.25
C_-WW0G-6624_-	366	495	66	24	60.63	1.38
C_-WW0G-7224_-	376	510	72	24	66.19	1.5
C_-WW0G-7824_-	411	555	78	24	71.74	1.63
C_-WW0G-8424_-	446	600	84	24	77.29	1.75
C_-WW0G-9024_-	506	682	90	24	82.62	1.88
C_-WW0G-9624_-	550	743	96	24	88.17	2
C_-WW0G-3030_-	237	321	30	30	34.48	0.78
C_-WW0G-3630_-	253	343	36	30	41.43	0.94
C_-WW0G-4230_-	269	365	42	30	48.37	1.09
C_-WW0G-4830_-	293	393	48	30	55.31	1.25
C_-WW0G-5430_-	323	436	54	30	62.02	1.41
C_-WW0G-6030_-	344	464	60	30	68.97	1.56
C_-WW0G-6630_-	389	525	66	30	75.91	1.72
C_-WW0G-7230_-	401	540	72	30	82.85	1.88
C_-WW0G-7830_-	426	576	78	30	89.79	2.03
C_-WW0G-8430_-	458	619	84	30	96.74	2.19
C_-WW0G-9030_-	518	700	90	30	103.45	2.34
C_-WW0G-9630_-	565	762	96	30	103.45	2.5
C_-WW0G-3036_-	254	345	30	36	34.48	0.94
C_-WW0G-3636_-	272	368	36	36	41.43	1.13
C_-WW0G-4236_-	286	387	42	36	48.37	1.31
C_-WW0G-4836_-	309	416	48	36	55.31	1.5
C_-WW0G-5436_-	341	458	54	36	62.02	1.69
C_-WW0G-6036_-	361	485	60	36	68.97	1.88
C_-WW0G-6636_-	408	548	66	36	75.91	2.06
C_-WW0G-7236_-	415	563	72	36	82.85	2.25
C_-WW0G-7836_-	444	598	78	36	89.79	2.44
C_-WW0G-8436_-	481	649	84	36	96.74	2.63
C_-WW0G-9036_-	544	733	90	36	103.45	2.81
C_-WW0G-9636_-	586	792	96	36	110.4	3
Curved End						
C_-WW_G-3024_-	204	278	30	24	18.36	0.42
C_-WW_G-3624_-	215	287	36	24	22.99	0.5
C_-WW_G-4224_-	253	343	42	24	25.77	0.58
C_-WW_G-4824_-	272	368	48	24	29.47	0.67
C_-WW_G-5424_-	312	423	54	24	33.02	0.75
C_-WW_G-6024_-	344	464	60	24	36.72	0.83
C_-WW_G-6624_-	384	517	66	24	40.42	0.92
C_-WW_G-7224_-	393	533	72	24	44.13	1
C_-WW_G-7824_-	428	579	78	24	47.83	1.08
C_-WW_G-8424_-	464	626	84	24	61.53	1.17
C_-WW_G-9024_-	525	710	90	24	55.08	1.25
C_-WW_G-3030_-	249	338	30	30	22.99	0.52
C_-WW_G-3630_-	266	361	36	30	27.62	0.63
C_-WW_G-4230_-	284	384	42	30	32.25	0.73
C_-WW_G-4830_-	307	413	48	30	36.88	0.83
C_-WW_G-5430_-	341	458	54	30	41.35	0.94
C_-WW_G-6030_-	361	485	60	30	45.98	1.04
C_-WW_G-6630_-	409	550	66	30	50.61	1.15
C_-WW_G-7230_-	416	564	72	30	55.24	1.25
C_-WW_G-7830_-	447	602	78	30	59.86	1.35
C_-WW_G-8430_-	478	646	84	30	64.49	1.46
C_-WW_G-9030_-	541	730	90	30	68.97	1.56

worksurfaces | extended corner with curved front

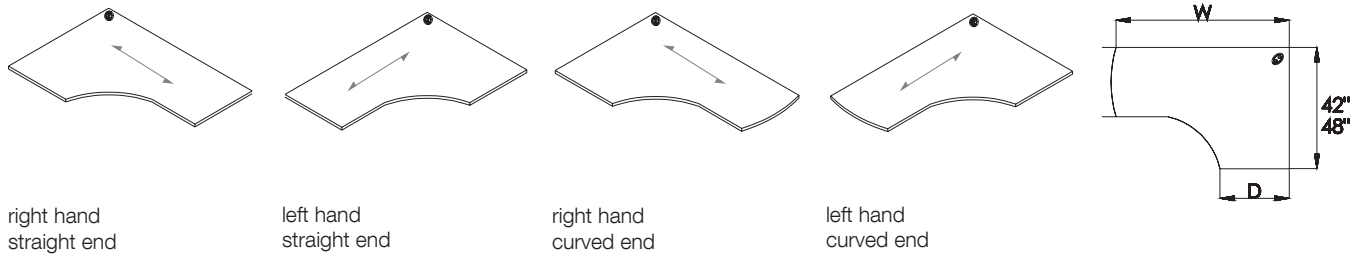

right hand
straight end

left hand
straight end

right hand
curved end

left hand
curved end

what's included:

Extended Corner with curved front, grommets (48-inch worksurfaces include one grommet, 54-inch worksurfaces and above include two grommets).

application notes:

Grain direction is indicated in the above illustration.

Worksurfaces 54-inches and longer require a horizontal surface support (CH00), which must be specified separately.

how to specify:

Specify laminate color.

The straight worksurface with curved end must be specified as left or right. When the straight end is specified, the handed end will be longer. When the curved end is specified, the handed end will be longer and curved.

The worksurface trim color will default to match the laminate color unless otherwise specified, see the laminate finish card for details.

Not all laminate colors are available on 1.5-inch thick worksurfaces, see the laminate finish card for details and refer to the column "1.5-inch surface" or "Metropolis".

Edge profile must be specified for 1.5-inch thick worksurfaces. 1.5-inch thick worksurfaces are available in straight, gothic, and wave profiles.

Keyboard tray can be mounted to this worksurface. Refer to the Accessories section for details.

options

thickness	C 1-inch	CT 1.5-inch
hand	R right	L left
width	36, 42, 48	
depth	18, 24, 30	
length	48, 54, 60, 66, 72	
surface finish	laminate colors	
edge profile (1.5-inch only)	straight	gothic

how to order and read your code

Sample Order: 1.5-inch thick, extended corner with straight front, 48-inches wide, 24-inches deep, 54-inches long, right-handed, finished in Congo (L100), with matching trim color, wave profile.

NOTE: SAMPLE CODE HERE INCLUDES ALL AVAILABLE OPTIONS.

CT product line	W5E item	0 hand	48 width	24 depth	54 length	L100 surface finish	gothic edge profile
-----------------------	-------------	-----------	-------------	-------------	--------------	---------------------------	---------------------------

worksurfaces | extended corner with curved front

Code	1" (C)	1.5" (CT)	W (in.)	D (in.)	Weight (lb.)	Volume (ft ³)
Straight End						
C_-W5E0-4218-_	427	578	42	18	29.09	0.8
C_-W5E0-4818-_	449	607	48	18	33.23	0.9
C_-W5E0-5418-_	477	645	54	18	37.38	1
C_-W5E0-6018-_	497	672	60	18	41.54	1.1
C_-W5E0-4824-_	471	634	48	24	38.77	1.2
C_-W5E0-5424-_	496	668	54	24	43.62	1.3
C_-W5E0-6024-_	523	707	60	24	48.46	1.5
C_-W5E0-5430-_	539	727	54	30	49.85	1.5
C_-W5E0-6030-_	584	791	60	30	55.38	1.7
C_-W5E0-6630-_	629	865	66	30	60.92	1.9
C_-W5E0-7230-_	671	927	72	30	66.46	2.1
One Curved End						
C_-W5E_-4218-_	449	607	42	18	73.29	1.31
C_-W5E_-4818-_	471	634	48	18	77.79	1.75
C_-W5E_-5418-_	500	675	54	18	82.29	2.25
C_-W5E_-6018-_	519	701	60	18	86.79	2.81
C_-W5E_-4824-_	492	665	48	24	78	1.75
C_-W5E_-5424-_	518	700	54	24	82.5	2.25
C_-W5E_-6024-_	548	740	60	24	87	2.81
C_-W5E_-5430-_	565	762	54	30	82.5	2.25
C_-W5E_-6030-_	613	828	60	30	87	2.81
C_-W5E_-6630-_	654	895	66	30	60.92	1.9
C_-W5E_-7230-_	694	956	72	30	66.46	2.1
Dual Curved Ends						
C-W5ED-4218-_	473	637	42	18	29.08	0.8
C-W5ED-4818-_	492	665	48	18	33.23	0.9
C-W5ED-5418-_	524	708	54	18	37.38	1
C-W5ED-6018-_	546	737	60	18	41.54	1.1
C-W5ED-4824-_	516	697	48	24	38.77	1.2
C-W5ED-5424-_	545	736	54	24	43.62	1.3
C-W5ED-6024-_	576	776	60	24	48.46	1.5
C-W5ED-5430-_	593	800	54	30	49.85	1.5
C-W5ED-6030-_	643	866	60	30	55.38	1.7
C-W5ED-6630-_	688	941	66	30	60.92	1.9
C-W5ED-7230-_	730	1003	72	30	66.46	2.1

worksurfaces | angled worksurface with curved front

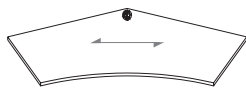

straight ends

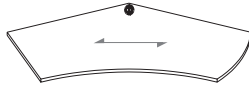

curved right end

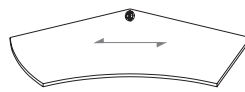

curved left end

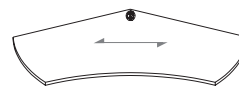

double curved ends

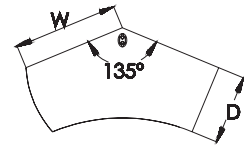

what's included:

Angled Worksurface with curved front (135-degree), grommet

application notes:

Grain direction is indicated in the above illustration.

how to specify:

Specify laminate color.

The worksurface trim color will default to match the laminate color unless otherwise specified, see the laminate finish card for details.

Not all laminate colors are available on 1.5-inch thick worksurfaces, see the laminate finish card for details and refer to the column "1.5-inch surface" or "Metropolis".

Edge profile must be specified for 1.5-inch thick worksurfaces. 1.5-inch thick worksurfaces are available in straight, gothic, and wave profiles.

Keyboard tray can be mounted to this worksurface. Refer to the Accessories section for details.

options

thickness	C 1-inch	CT 1.5-inch		
end shape	straight	curved right	curved left	curved double
width	24, 30, 36, 42, 48			
depth	18, 24, 30			
surface finish	laminate colors			
edge profile (1.5-inch only)	straight	gothic		

how to order and read your code

Sample Order: 1-inch thick, angled worksurface with curved front, straight ends, 30-inches wide, 24-inches deep, surface finished in Maple (L104), with matching trim color.

NOTE: SAMPLE CODE HERE INCLUDES ALL AVAILABLE OPTIONS.

C product line	WA00 item	30 width	24 depth	L104 surface finish	gothic edge profile
----------------------	--------------	-------------	-------------	---------------------------	---------------------------

worksurfaces | angled worksurface with curved front

Code	1" (C)	1.5" (CT)	W1 (in.)	D (in.)	Weight (lb.)	Volume (ft³)
Straight End						
C_-WA00-2418	293	393	24	18	20	0.47
C_-WA00-3018	386	522	30	18	26	0.67
C_-WA00-3618	436	589	36	18	28	0.91
C_-WA00-4218	500	672	42	18	30	1.1
C_-WA00-4818	606	828	48	18	32	1.3
C_-WA00-2424	330	446	24	24	24	0.56
C_-WA00-3024	402	541	30	24	28	0.75
C_-WA00-3624	503	678	36	24	30	1.01
C_-WA00-4224	557	756	42	24	32	1.2
C_-WA00-4824	686	943	48	24	34	1.4
C_-WA00-3030	457	617	30	30	30	0.84
C_-WA00-3630	571	771	36	30	32	1.11
C_-WA00-4230	610	836	42	30	34	1.4
C_-WA00-4830	751	1041	48	30	36	1.6
Curved Right End						
C_-WA0R-2418	298	403	24	18	20	0.47
C_-WA0R-3018	391	530	30	18	26	0.67
C_-WA0R-3618	442	597	36	18	28	0.91
C_-WA0R-4218	506	680	42	18	30	1.1
C_-WA0R-4818	612	837	48	18	32	1.3
C_-WA0R-2424	336	452	24	24	24	0.56
C_-WA0R-3024	408	548	30	24	28	0.75
C_-WA0R-3624	509	688	36	24	30	1.01
C_-WA0R-4224	563	764	42	24	32	1.2
C_-WA0R-4824	692	952	48	24	34	1.4
C_-WA0R-3030	464	626	30	30	30	0.84
C_-WA0R-3630	577	778	36	30	32	1.11
C_-WA0R-4230	617	845	42	30	34	1.4
C_-WA0R-4830	757	1051	48	30	36	1.6
Curved Left End						
C_-WA0L-2418	298	403	24	18	20	0.47
C_-WA0L-3018	391	530	30	18	26	0.67
C_-WA0L-3618	442	597	36	18	28	0.91
C_-WA0L-4218	506	680	42	18	30	1.1
C_-WA0L-4818	612	837	48	18	32	1.3
C_-WA0L-2424	336	452	24	24	24	0.56
C_-WA0L-3024	408	548	30	24	28	0.75
C_-WA0L-3624	509	688	36	24	30	1.01
C_-WA0L-4224	563	764	42	24	32	1.2
C_-WA0L-4824	692	952	48	24	34	1.4
C_-WA0L-3030	464	626	30	30	30	0.84
C_-WA0L-3630	577	778	36	30	32	1.11
C_-WA0L-4230	617	845	42	30	34	1.4
C_-WA0L-4830	757	1051	48	30	36	1.6
Double Curved End						
C_-WA0D-2418	305	411	24	18	20	0.47
C_-WA0D-3018	401	540	30	18	26	0.67
C_-WA0D-3618	449	607	36	18	28	0.91
C_-WA0D-4218	513	691	42	18	30	1.1
C_-WA0D-4818	619	848	48	18	32	1.3
C_-WA0D-2424	344	464	24	24	24	0.56
C_-WA0D-3024	413	559	30	24	28	0.75
C_-WA0D-3624	515	695	36	24	30	1.01
C_-WA0D-4224	570	776	42	24	32	1.2
C_-WA0D-4824	698	963	48	24	34	1.4
C_-WA0D-3030	471	634	30	30	30	0.84
C_-WA0D-3630	583	788	36	30	32	1.11
C_-WA0D-4230	623	856	42	30	34	1.4
C_-WA0D-4830	763	1061	48	30	36	1.6

worksurfaces | flexed worksurface with curved front

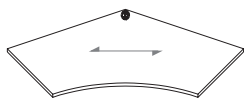

straight ends

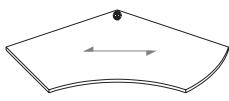

curved right end

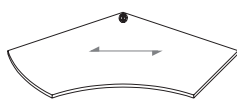

curved left end

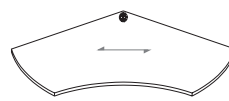

double curved ends

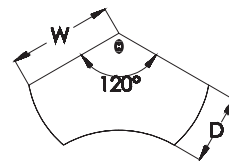

what's included:

Flexed Worksurface with curved front (120-degree), grommet

application notes:

Grain direction is indicated in the above illustration.

how to specify:

Specify laminate color.

The worksurface trim color will default to match the laminate color unless otherwise specified, see the laminate finish card for details.

Not all laminate colors are available on 1.5-inch thick worksurfaces, see the laminate finish card for details and refer to the column "1.5-inch surface" or "Metropolis".

Edge profile must be specified for 1.5-inch thick worksurfaces. 1.5-inch thick worksurfaces are available in straight, gothic, and wave profiles.

Keyboard tray can be mounted to this worksurface. Refer to the Accessories section for details.

options

thickness	C 1-inch	CT 1.5-inch		
end shape	0 straight	R curved right	L curved left	D curved double
width	24, 30, 36, 42, 48, 54			
depth	18, 24, 30			
surface finish	laminate colors			
edge profile (1.5-inch only)	straight	gothic		

how to order and read your code

Sample Order: 1-inch thick, flexed worksurface with curved front, curved left end, 36-inches wide, 30-inches deep, finished in Congo (L100), with matching trim color.

NOTE: SAMPLE CODE HERE INCLUDES ALL AVAILABLE OPTIONS.

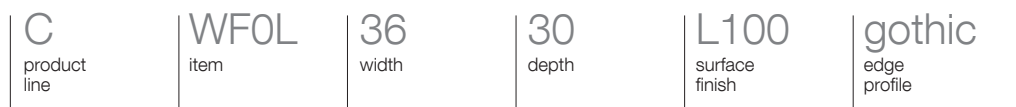

worksurfaces | flexed worksurface with curved front

Code	1" (C)	1.5" (CT)	W1 (in.)	D (in.)	Weight (lb.)	Volume (ft ³)
Straight End						
C-WF00-2418	286	387	24	18	5.18	0.25
C-WF00-3018	349	473	30	18	6.48	0.31
C-WF00-3618	442	597	36	18	7.78	0.38
C-WF00-4218	500	673	42	18	28	0.44
C-WF00-4818	615	845	48	18	10.37	0.5
C-WF00-5418	717	993	54	18	11.66	0.56
C-WF00-3024	404	545	30	24	8.64	0.42
C-WF00-3624	496	668	36	24	10.37	0.5
C-WF00-4224	547	743	42	24	12.1	0.58
C-WF00-4824	678	934	48	24	13.82	0.67
C-WF00-5424	782	1088	54	24	15.55	0.75
C-WF00-3630	503	678	36	30	12.96	0.63
C-WF00-4230	558	762	42	30	15.12	0.73
C-WF00-4830	691	959	48	30	17.28	0.83
C-WF00-5430	798	1117	54	30	19.44	0.94
Curved Right End						
C-WF0L-2418	294	394	24	18	5.18	0.25
C-WF0L-3018	354	479	30	18	6.48	0.31
C-WF0L-3618	448	606	36	18	7.78	0.38
C-WF0L-4218	506	682	42	18	9.07	0.44
C-WF0L-4818	622	853	48	18	10.37	0.5
C-WF0L-5418	723	1001	54	18	11.66	0.56
C-WF0L-3024	410	552	30	24	8.64	0.42
C-WF0L-3624	502	676	36	24	10.37	0.5
C-WF0L-4224	554	752	42	24	12.1	0.58
C-WF0L-4824	685	943	48	24	13.82	0.67
C-WF0L-5424	788	1097	54	24	15.55	0.75
C-WF0L-3630	509	688	36	30	12.96	0.63
C-WF0L-4230	564	771	42	30	15.12	0.73
C-WF0L-4830	697	968	48	30	17.28	0.83
C-WF0L-5430	804	1125	54	30	19.44	0.94
Curved Left End						
C-WF0R-2418	294	394	24	18	5.18	0.25
C-WF0R-3018	354	479	30	18	6.48	0.31
C-WF0R-3618	448	606	36	18	7.78	0.38
C-WF0R-4218	506	682	42	18	9.07	0.44
C-WF0R-4818	622	853	48	18	10.37	0.5
C-WF0R-5418	723	1001	54	18	11.66	0.56
C-WF0R-3024	410	552	30	24	8.64	0.42
C-WF0R-3624	502	676	36	24	10.37	0.5
C-WF0R-4224	554	752	42	24	12.1	0.58
C-WF0R-4824	685	943	48	24	13.82	0.67
C-WF0R-5424	788	1097	54	24	15.55	0.75
C-WF0R-3630	509	688	36	30	12.96	0.63
C-WF0R-4230	564	771	42	30	15.12	0.73
C-WF0R-4830	697	968	48	30	17.28	0.83
C-WF0R-5430	804	1125	54	30	19.44	0.94

continues next page

worksurfaces | flexed worksurface with curved front continued

Code	1" (C)	1.5" (CT)	W1 (in.)	D (in.)	Weight (lb.)	Volume (ft ³)
Double Curved End						
C-WF0D-2418	300	407	24	18	5.18	0.25
C-WF0D-3018	363	490	30	18	6.48	0.31
C-WF0D-3618	453	613	36	18	7.78	0.38
C-WF0D-4218	513	692	42	18	9.07	0.44
C-WF0D-4818	628	864	48	18	10.37	0.5
C-WF0D-5418	730	1012	54	18	11.66	0.56
C-WF0D-3024	415	563	30	24	8.64	0.42
C-WF0D-3624	509	688	36	24	10.37	0.5
C-WF0D-4224	560	762	42	24	12.1	0.58
C-WF0D-4824	691	954	48	24	13.82	0.67
C-WF0D-5424	795	1107	54	24	15.55	0.75
C-WF0D-3630	515	695	36	30	12.96	0.63
C-WF0D-4230	571	782	42	30	15.12	0.73
C-WF0D-4830	705	979	48	30	17.28	0.83
C-WF0D-5430	812	1136	54	30	19.44	0.94

worksurfaces | 5-sided corner worksurface with curved front

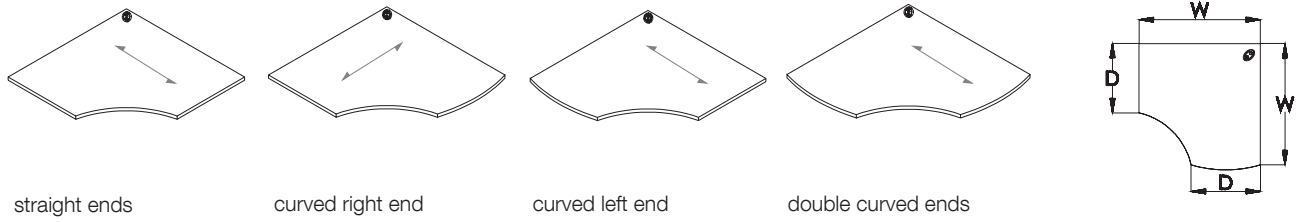

straight ends

curved right end

curved left end

double curved ends

what's included:

5-Sided Corner Worksurface with curved front, grommet

application notes:

Grain direction is indicated in the above illustration.

how to specify:

Specify laminate color.

The worksurface trim color will default to match the laminate color unless otherwise specified, see the laminate finish card for details.

Not all laminate colors are available on 1.5-inch thick worksurfaces, see the laminate finish card for details and refer to the column "1.5-inch surface" or "Metropolis".

Edge profile must be specified for 1.5-inch thick worksurfaces. 1.5-inch thick worksurfaces are available in straight, gothic, and wave profiles.

Keyboard tray can be mounted to this worksurface. Refer to the Accessories section for details.

options

thickness	C 1-inch	CT 1.5-inch		
end shape	0 straight	R curved right	L curved left	D curved double
width	36, 42, 48			
depth	18, 24, 30			
surface finish	laminate colors			
edge profile (1.5-inch only)	straight	gothic		

how to order and read your code

Sample Order: 1-inch thick, 5-sided corner worksurface with curved front, double curved ends, 48-inches wide, 24-inches deep, finished in Maple (L104), with matching trim color.

NOTE: SAMPLE CODE HERE INCLUDES ALL AVAILABLE OPTIONS.

C product line	W5CD item	48 width	24 depth	L104 surface finish	gothic edge profile
----------------------	--------------	-------------	-------------	---------------------------	---------------------------

worksurfaces | 5-sided corner worksurface with curved front

Code	1" (C)	1.5" (CT)	W1 (in.)	D (in.)	Weight (lb.)	Volume (ft ³)
Straight End						
C_-W5CO-3618	385	519	36	18	26.63	0.75
C_-W5CO-3624	385	519	36	24	27	0.75
C_-W5CO-4224	464	626	42	24	38.66	1.02
C_-W5CO-4824	485	656	48	24	47.45	1.33
C_-W5CO-4830	485	656	48	30	52.55	1.33
Curved Right End						
C_-W5CR-3618	404	545	36	18	26.63	0.75
C_-W5CR-4224	485	656	42	24	38.66	1.02
C_-W5CR-4824	511	689	48	24	47.45	1.33
C_-W5CR-4830	511	689	48	30	52.55	1.33
Curved Left End						
C_-W5CL-3618	404	545	36	18	26.63	0.75
C_-W5CL-4224	485	656	42	24	38.66	1.02
C_-W5CL-4824	511	689	48	24	47.45	1.33
C_-W5CL-4830	511	689	48	30	52.55	1.33
Double Curved End						
C_-W5CD-3618	424	572	36	18	26.63	0.75
C_-W5CD-4224	511	689	42	24	38.66	1.02
C_-W5CD-4824	536	722	48	24	47.45	1.33
C_-W5CD-4830	536	722	48	30	52.55	1.33

worksurfaces | 5-sided corner worksurface with straight front

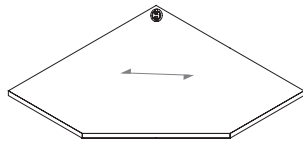

what's included:

5-Sided Corner Worksurface with curved front, grommet.

application notes:

Grain direction is indicated in the above illustration.

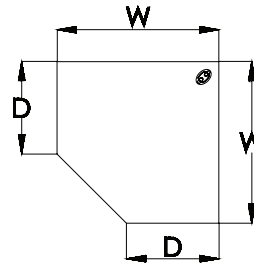

how to specify:

Specify laminate color.

The worksurface trim color will default to match the laminate color unless otherwise specified, see the laminate finish card for details.

Not all laminate colors are available on 1.5-inch thick worksurfaces, see the laminate finish card for details and refer to the column "1.5-inch surface" or "Metropolis".

Edge profile must be specified for 1.5-inch thick worksurfaces. 1.5-inch thick worksurfaces are available in straight, gothic, and wave profiles.

Keyboard tray can be mounted to this worksurface. Refer to the Accessories section for details.

options

thickness	C 1-inch	CT 1.5-inch
width	36, 42, 48	
depth	18, 24, 30	
surface finish	laminate colors	
edge profile (1.5-inch only)	straight	gothic

how to order and read your code

Sample Order: 1-inch thick, 5-sided worksurface with straight front, 48-inches wide, 24-inches deep, finished in Congo (L100), with matching trim color, gothic edge profile.



worksurfaces | 5-sided corner worksurface with straight front

Code	1" (C)	1.5" (CT)	W1 (in.)	D (in.)	Weight (lb.)	Volume (ft ³)
Straight End						
C_-W5S0-3618	385	519	36	18	39.94	1.13
C_-W5S0-3624	385	519	36	24	40.5	1.13
C_-W5S0-4224	464	626	42	24	57.99	1.53
C_-W5S0-4824	485	656	48	24	71.18	2
C_-W5S0-4830	485	656	48	30	78.82	2

worksurfaces | multi-functional corner workspace

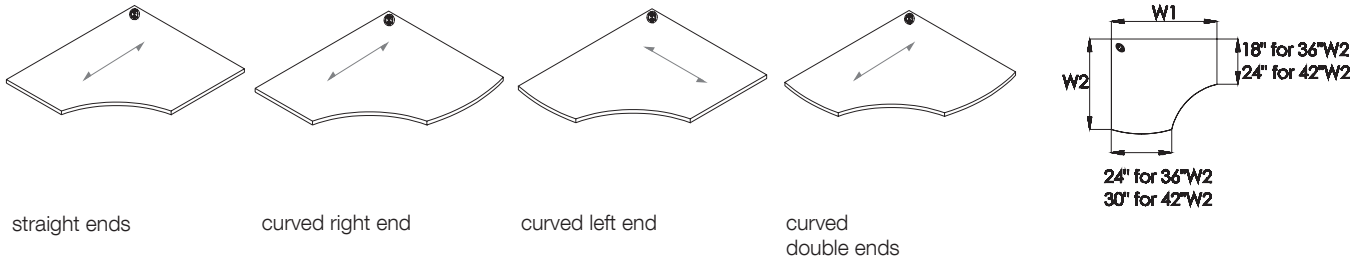

what's included:

Multi-Functional Corner Worksurface with curved front, grommet.

application notes:

Grain direction is indicated in the above illustration.

how to specify:

Specify laminate color.

The worksurface trim color will default to match the laminate color unless otherwise specified, see the laminate finish card for details.

Not all laminate colors are available on 1.5-inch thick worksurfaces, see the laminate finish card for details and refer to the column "1.5-inch surface" or "Metropolis".

Edge profile must be specified for 1.5-inch thick worksurfaces. 1.5-inch thick worksurfaces are available in straight, gothic, and wave profiles.

Keyboard tray can be mounted to this worksurface. Refer to the Accessories section for details.

options

thickness	C 1-inch	CT 1.5-inch		
end shape	0 straight	R curved right	L curved left	D curved double
hand	R right	L left		
width	42/36, 48/42			
depth	18/24, 24/30			
surface finish	laminate colors			
edge profile (1.5-inch only)	straight	gothic		

how to order and read your code

Sample Order: 1-inch thick, multi-functional corner worksurface, curved right end, 42/36-inches wide, 18/24-inches deep, right-handed, finished in Maple (L104) with matching trim color.

NOTE: SAMPLE CODE HERE INCLUDES ALL AVAILABLE OPTIONS.

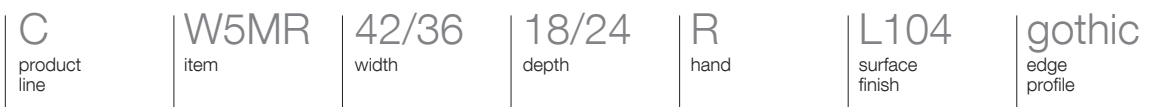

worksurfaces | multi-functional corner workspace

Code	1" (C)	1.5" (CT)	W1 (in.)	D (in.)	Weight (lb.)	Volume (ft ³)
Straight End						
C_-W5M0-4236-__	427	578	42/36	18/24	45	0.88
C_-W5M0-4842-__	471	634	48/42	24/30	45	1.17
Curved Right End						
C_-W5MR-4236-__	449	607	42/36	18/24	45	0.88
C_-W5MR-4842-__	492	665	48/42	24/30	45	1.17
Curved Left End						
C_-W5ML-4236-__	449	607	42/36	18/24	45	0.88
C_-W5ML-4842-__	492	665	48/42	24/30	45	1.17
Double Curved End						
C_-W5MD-4236-__	473	637	42/36	18/24	45	1.02
C_-W5MD-4842-__	516	697	48/42	24/30	45	1.33

worksurfaces | 6-sided corner worksurface

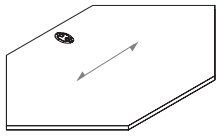

straight front

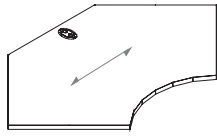

curved front

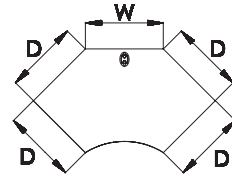
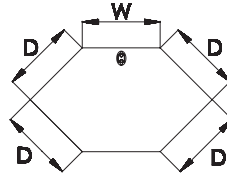

what's included:

6-Sided Corner Worksurface with grommet

application notes:

Grain direction is indicated in the above illustration.

how to specify:

Specify laminate color.

The worksurface trim color will default to match the laminate color unless otherwise specified, see the laminate finish card for details.

Not all laminate colors are available on 1.5-inch thick worksurfaces, see the laminate finish card for details and refer to the column "1.5-inch surface" or "Metropolis".

Edge profile must be specified for 1.5-inch thick worksurfaces. 1.5-inch thick worksurfaces are available in straight, gothic, and wave profiles.

Keyboard tray can be mounted to this worksurface. Refer to the Accessories section for details.

options

thickness	C 1-inch	CT 1.5-inch
front shape	S straight front	C curved front
width	24	
depth	24, 30	
surface finish	laminate colors	
edge profile (1.5-inch only)	straight	gothic

how to order and read your code

Sample Order: 1-inch thick, 6-sided corner worksurface, straight front, 30-inches deep, 24-inches wide, finished in Congo (L100), with matching trim color.

NOTE: SAMPLE CODE HERE INCLUDES ALL AVAILABLE OPTIONS.

C	W6SG	24	30	L100	gothic
product line	item	width	depth	surface finish	edge profile

worksurfaces | 6-sided corner workspace

Code	1" (C)	1.5" (CT)	W (in.)	D (in.)	Weight (lb.)	Volume (ft ³)
Straight Front						
C-W6SG-2424	471	634	24	24	27	0.75
C-W6SG-3024	496	668	30	24	27	0.87
Curved Front						
C-W6CG-2424	471	634	24	24	27	0.75
C-W6CG-3024	496	668	30	24	27	0.87

worksurfaces | panel-mounted d-table

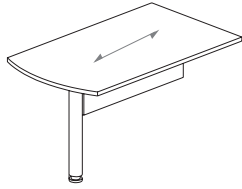

30-inches

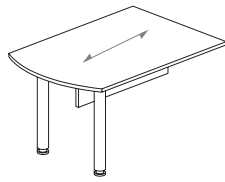

36-inches

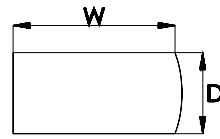

what's included:

Panel-Mounted D-Table, metal support post, laminate partial modesty

application notes:

Grain direction is indicated in the above illustration.

how to specify:

Specify laminate color.

Specify metal color for support posts.

The worksurface trim color will default to match the laminate color unless otherwise specified, see the laminate finish card for details.

Not all laminate colors are available on 1.5-inch thick worksurfaces, see the laminate finish card for details and refer to the column "1.5-inch surface" or "Metropolis".

Edge profile must be specified for 1.5-inch thick worksurfaces. 1.5-inch thick worksurfaces are available in straight, gothic, and wave profiles.

The color of the modesty will default to match the worksurface.

options

thickness	C 1-inch	CT 1.5-inch
width	60, 66, 72, 78, 84	
depth	30, 36	
surface finish	laminate colors	
edge profile (1.5-inch only)	straight	gothic
support finish	metal colors	

how to order and read your code

Sample Order: 1-inch thick, panel-mounted D-table, 72-inches wide, 36-inches deep, finished in Maple (L104), with matching trim color, supports finished in silver (P112).

NOTE: SAMPLE CODE HERE INCLUDES ALL AVAILABLE OPTIONS.



worksurfaces | panel-mounted d-table

Code	1" (C)	1.5" (CT)	W (in.)	D (in.)	Weight (lb.)	Volume (ft ³)
Without Grommet						
C_-WD00-6030	471	564	60	30	63.27	1.04
C_-WD00-6630	555	666	66	30	69.75	1.15
C_-WD00-7230	599	718	72	30	76.22	1.25
C_-WD00-7830	693	830	78	30	82.7	1.35
C_-WD00-8430	729	873	84	30	89.18	1.46
C_-WD00-6036	516	619	60	36	78.14	1.25
C_-WD00-6636	610	732	66	36	85.54	1.38
C_-WD00-7236	658	791	72	36	92.94	1.5
C_-WD00-7836	760	913	78	36	100.34	1.63
C_-WD00-8436	799	960	84	36	107.74	1.75
With Grommet						
C_-WD0G-6030	484	581	60	30	63.27	1.04
C_-WD0G-6630	569	682	66	30	69.75	1.15
C_-WD0G-7230	613	736	72	30	76.22	1.25
C_-WD0G-7830	708	849	78	30	82.7	1.35
C_-WD0G-8430	742	891	84	30	89.18	1.46
C_-WD0G-6036	531	639	60	36	78.14	1.25
C_-WD0G-6636	626	749	66	36	85.54	1.38
C_-WD0G-7236	673	806	72	36	92.94	1.5
C_-WD0G-7836	775	929	78	36	100.34	1.63
C_-WD0G-8436	815	977	84	36	107.74	1.75

worksurfaces | panel-mounted j-table

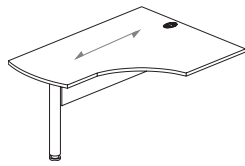

right hand

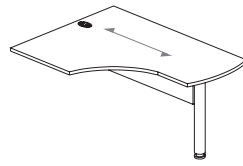

left hand

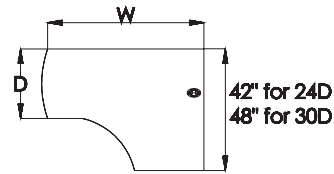

what's included:

Panel-Mounted J-Table, grommet, metal support post, laminate partial modesty

application notes:

Grain direction is indicated in the above illustration.

how to specify:

Specify laminate color.

Specify metal color for support posts.

The panel-mounted J-table must be specified as left or right. The handed end is the longer side of the J-table.

The worksurface trim color will default to match the laminate color unless otherwise specified, see the laminate finish card for details.

Not all laminate colors are available on 1.5-inch thick worksurfaces, see the laminate finish card for details and refer to the column "1.5-inch surface" or "Metropolis".

Edge profile must be specified for 1.5-inch thick worksurfaces. 1.5-inch thick worksurfaces are available in straight, gothic, and wave profiles.

The color of the modesty will default to match the worksurface.

Keyboard trays can be mounted to this worksurface. Refer to the accessories section for details.

options

thickness	C 1-inch	CT 1.5-inch
width	60, 66, 72, 78	
depth	24, 30	
hand	R right	L left
surface finish	laminate colors	
edge profile (1.5-inch only)	straight	gothic
support finish	metal colors	

how to order and read your code

Sample Order: 1-inch thick, panel mounted J-table, 66-inches wide, 30-inches deep, right-handed, finished in Maple (L104), with matching trim color, support finished in silver (P112).

NOTE: SAMPLE CODE HERE INCLUDES ALL AVAILABLE OPTIONS.

C	WJ06	66	30	R	L104	P112
product line	item	width	depth	hand	surface finish	support finish

worksurfaces | panel-mounted j-table

Code	1" (C)	1.5" (CT)	W (in.)	D (in.)	Weight (lb.)	Volume (ft ³)
CT-WJOG-6024-L	692	829	60	24	120	1.25
CT-WJOG-6624-L	736	884	66	24	124.5	1.38
CT-WJOG-7224-L	792	952	72	24	129	1.5
CT-WJOG-7824-L	837	1003	78	24	133.5	1.63
CT-WJOG-6030-L	741	890	60	30	120	1.56
CT-WJOG-6630-L	797	957	66	30	124.5	1.72
CT-WJOG-7230-L	840	1009	72	30	129	1.88
CT-WJOG-7830-L	935	1122	78	30	133.5	2.03

worksurfaces | panel-mounted p-table

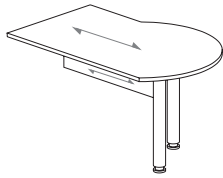

right hand

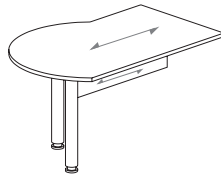

left hand

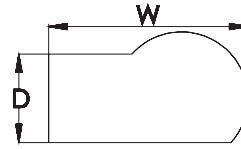

what's included:

Panel-Mounted P-Table, 2 metal support posts, laminate partial modesty

application notes:

Grain direction is indicated in the above illustration.

how to specify:

Specify laminate color.

Specify metal color for support posts.

The panel-mounted P-table must be specified as left or right. The handed end has a bubble on the outside.

The worksurface trim color will default to match the laminate color unless otherwise specified, see the laminate finish card for details.

Not all laminate colors are available on 1.5-inch thick worksurfaces, see the laminate finish card for details and refer to the column "1.5-inch surface" or "Metropolis".

Edge profile must be specified for 1.5-inch thick worksurfaces. 1.5-inch thick worksurfaces are available in straight, gothic, and wave profiles.

The color of the modesty will default to match the worksurface.

options

thickness	C 1-inch	CT 1.5-inch
width	60, 66, 72, 78, 84	
depth	30, 36	
hand	R right	L left
surface finish	laminate colors	
edge profile (1.5-inch only)	straight	gothic
support finish	metal colors	

how to order and read your code

Sample Order: 1-inch thick, panel mounted P-table, 78-inches wide, 36-inches deep, right-handed, finished in Congo (L100), with matching trim color, support finished in silver (P112).

NOTE: SAMPLE CODE HERE INCLUDES ALL AVAILABLE OPTIONS.

C product line	WP00 item	78 width	36 depth	R hand	L100 surface finish	P112 support finish
----------------------	--------------	-------------	-------------	-----------	---------------------------	---------------------------

worksurfaces | panel-mounted p-table

Code	1" (C)	1.5" (CT)	W (in.)	D (in.)	Weight (lb.)	Volume (ft ³)
Without Grommet						
C_-WP00-6030-_	514	617	60	30	73.13	1.04
C_-WP00-6630-_	583	699	66	30	79.59	1.15
C_-WP00-7230-_	621	745	72	30	86.07	1.25
C_-WP00-7830-_	729	873	78	30	92.55	1.35
C_-WP00-8430-_	784	942	84	30	99.02	1.46
C_-WP00-6036-_	572	688	60	36	77	1.25
C_-WP00-6636-_	642	770	66	36	83	1.38
C_-WP00-7236-_	679	816	72	36	90	1.5
C_-WP00-7836-_	786	943	78	36	96	1.63
C_-WP00-8436-_	858	1028	84	36	103	1.75
With Grommet						
C_-WP0G-6030-_	522	625	60	30	80	0.8
C_-WP0G-6630-_	591	709	66	30	83	0.9
C_-WP0G-7230-_	629	754	72	30	86	1
C_-WP0G-7830-_	737	883	78	30	89	1.1
C_-WP0G-8430-_	793	951	84	30	99.02	1.46
C_-WP0G-6036-_	581	696	60	36	80	1
C_-WP0G-6636-_	650	779	66	36	83	1.2
C_-WP0G-7236-_	688	824	72	36	86	1.3
C_-WP0G-7836-_	795	952	78	36	89	1.4
C_-WP0G-8436-_	866	1036	84	36	103	1.75

worksurfaces | panel-mounted y-table

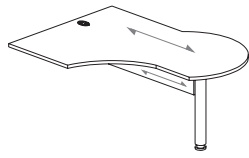

right hand

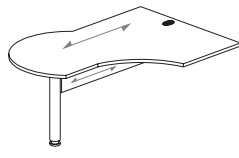

left hand

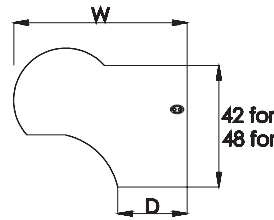

what's included:

Panel-Mounted Y-Table, grommet, metal support post, laminate partial modesty

application notes:

Grain direction is indicated in the above illustration.

how to specify:

Specify laminate color.

Specify metal color for support posts.

The panel-mounted Y-table must be specified as left or right. The handed end is rounded.

The worksurface trim color will default to match the laminate color unless otherwise specified, see the laminate finish card for details.

Not all laminate colors are available on 1.5-inch thick worksurfaces, see the laminate finish card for details and refer to the column "1.5-inch surface" or "Metropolis".

Edge profile must be specified for 1.5-inch thick worksurfaces. 1.5-inch thick worksurfaces are available in straight, gothic, and wave profiles.

The color of the modesty will default to match the worksurface.

Keyboard trays can be mounted to this worksurface. Refer to the Accessories section for details.

options

thickness	C 1-inch	CT 1.5-inch
width	60, 66, 72, 78, 84	
depth	24, 30	
hand	R right	L left
surface finish	laminate colors	
edge profile (1.5-inch only)	straight	gothic
support finish	metal colors	

how to order and read your code

Sample Order: 1-inch thick, panel mounted Y-table, 72-inches wide, 30-inches deep, right-handed, finished in Maple (L104), with matching trim color, support finished in silver (P112).

NOTE: SAMPLE CODE HERE INCLUDES ALL AVAILABLE OPTIONS.

C product line	WY0G item	72 width	30 depth	R hand	L104 surface finish	gothic edge profile	P112 support finish
----------------------	--------------	-------------	-------------	-----------	---------------------------	---------------------------	---------------------------

worksurfaces | panel-mounted y-table

Code	1" (C)	1.5" (CT)	W (in.)	D (in.)	Weight (lb.)	Volume (ft ³)
C_-WYOG-6024-_	907	1089	60	24	120	1.25
C_-WYOG-6624-_	969	1163	66	24	123	1.38
C_-WYOG-7224-_	1039	1245	72	24	126	1.5
C_-WYOG-7824-_	1105	1326	78	24	129	1.63
C_-WYOG-6630-_	1097	1316	66	30	129	1.72
C_-WYOG-7230-_	1111	1336	72	30	132	1.88
C_-WYOG-7830-_	1139	1367	78	30	135	2.03
C_-WYOG-8430-_	1154	1385	84	30	141	2.19

worksurfaces | studio table

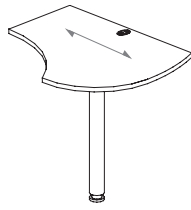

right hand

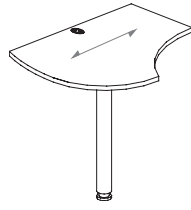

left hand

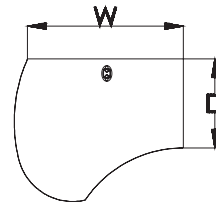

what's included:

Studio Table, grommet, metal support post

application notes:

Grain direction is indicated in the above illustration.

how to specify:

Specify laminate color.

Specify metal color for support posts.

The studio table must be specified as left or right. The handed end is rounded.

The worksurface trim color will default to match the laminate color unless otherwise specified, see the laminate finish card for details.

Not all laminate colors are available on 1.5-inch thick worksurfaces, see the laminate finish card for details and refer to the column "1.5-inch surface" or "Metropolis".

Edge profile must be specified for 1.5-inch thick worksurfaces. 1.5-inch thick worksurfaces are available in straight, gothic, and wave profiles.

options

thickness	C 1-inch	CT 1.5-inch
width	36, 42	
depth	18, 24, 30	
hand	R right	L left
surface finish	laminate colors	
edge profile (1.5-inch only)	straight	gothic
support finish	metal colors	

how to order and read your code

Sample Order: Studio table, 42-inches wide, 24-inches deep, right-handed, finished in Congo (L100), with matching trim color, support finished in silver (P112).

NOTE: SAMPLE CODE HERE INCLUDES ALL AVAILABLE OPTIONS.

C product line	WX0G item	42 width	24 depth	R surface finish	L100 surface finish	gothic edge profile	P112 support finish
----------------------	--------------	-------------	-------------	------------------------	---------------------------	---------------------------	---------------------------

worksurfaces | studio table

Code	1" (C)	1.5" (CT)	W (in.)	D (in.)	Weight (lb.)	Volume (ft ³)
C_-WX0G-3618-_ C_-WX0G-4218-_ 	503 540	605 647	36 42	18 18	20 23	0.4 0.4
C_-WX0G-3624-_ C_-WX0G-4224-_ 	536 577	642 692	36 42	24 24	26 29	0.5 0.58
C_-WX0G-3630-_ C_-WX0G-4230-_ 	586 631	701 758	36 42	30 30	31 36	0.63 0.73

worksurfaces | swing table

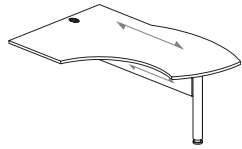

right hand

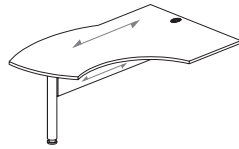

left hand

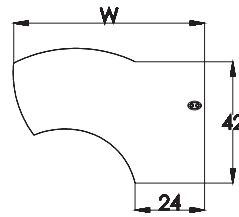

what's included:

Swing Table, grommet, metal support post, laminate partial modesty

application notes:

Grain direction is indicated in the above illustration.

how to specify:

Specify laminate color.

Specify metal color for support posts.

The swing table must be specified as left or right. The handed end is rounded.

The worksurface trim color will default to match the laminate color unless otherwise specified, see the laminate finish card for details.

Not all laminate colors are available on 1.5-inch thick worksurfaces, see the laminate finish card for details and refer to the column "1.5-inch surface" or "Metropolis".

Edge profile must be specified for 1.5-inch thick worksurfaces. 1.5-inch thick worksurfaces are available in straight, gothic, and wave profiles.

The color of the modesty will default to match the worksurface.

Keyboard trays can be mounted to this worksurface. Refer to the Accessories section for details.

options

thickness	C 1-inch	CT 1.5-inch
width	66, 72, 78	
depth	24	
hand	R right	L left
surface finish	laminate colors	
edge profile (1.5-inch only)	straight	gothic
support finish	metal colors	

how to order and read your code

Sample Order: Swing table, 72-inches wide, 24-inches deep, right-handed, finished in Maple (L104), with matching trim color, support finished in silver (P112).

NOTE: SAMPLE CODE HERE INCLUDES ALL AVAILABLE OPTIONS.



worksurfaces | swing table

Code	1" (C)	1.5" (CT)	W (in.)	D (in.)	Weight (lb.)	Volume (ft ³)
C_-WG0G-6624-_	969	1163	66	24	119.39	1.38
C_-WG0G-7224-_	1039	1245	72	24	129.11	1.5
C_-WG0G-7824-_	1105	1326	78	24	138.82	1.63

worksurfaces | zoid table

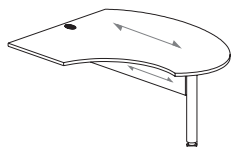

right hand

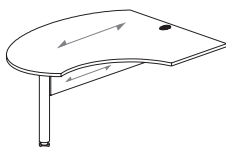

left hand

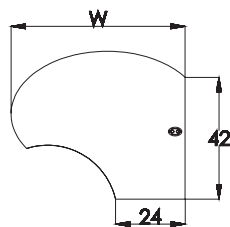

what's included:

Zoid Table, grommet, metal support post, laminate partial modesty

application notes:

Refer to the diagram in the introduction section for grain direction.

how to specify:

Specify laminate color.

Specify metal color for support posts.

The worksurface trim color will default to match the laminate color unless otherwise specified, see the laminate finish card for details.

Not all laminate colors are available on 1.5-inch thick worksurfaces, see the laminate finish card for details and refer to the column "1.5-inch surface" or "Metropolis".

Edge profile must be specified for 1.5-inch thick worksurfaces. 1.5-inch thick worksurfaces are available in straight, gothic, and wave profiles.

The color of the modesty will default to match the worksurface.

Keyboard trays can be mounted to this worksurface. Refer to the Accessories section for details.

options

thickness	C 1-inch	CT 1.5-inch
width	60, 66, 72, 78	
depth	24	
hand	R right	L left
surface finish	laminate colors	
edge profile (1.5-inch only)	straight	gothic
support finish	metal colors	

how to order and read your code

Sample Order: Zoid table, 66-inches wide, 24-inches deep, right-handed, finished in Congo (L100), with matching trim color, support finished in silver (P112).

NOTE: SAMPLE CODE HERE INCLUDES ALL AVAILABLE OPTIONS.

<p>C product line</p>	<p>WZ0G item</p>	<p>66 width</p>	<p>24 depth</p>	<p>R hand</p>	<p>L100 surface finish</p>	<p>gothic edge profile</p>	<p>P112 support finish</p>
--------------------------------------	-----------------------------	----------------------------	----------------------------	--------------------------	---	---	---

worksurfaces | zoid table

Code	1" (C)	1.5" (CT)	W (in.)	D (in.)	Weight (lb.)	Volume (ft ³)
C_-WZ0G-6024-_	907	1089	60	24	79.6	0.8
C_-WZ0G-6624-_	969	1163	66	24	79.6	0.9
C_-WZ0G-7224-_	1039	1245	72	24	86.1	1
C_-WZ0G-7824-_	1062	1274	78	24	92.6	1.1

worksurfaces | c-table extension

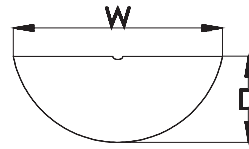
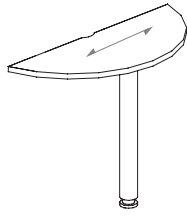

what's included:

C-Table Extension, metal support post

application notes:

Grain direction is indicated in the above illustration.

how to specify:

Specify laminate color.

Specify metal color for support posts.

The worksurface trim color will default to match the laminate color unless otherwise specified, see the laminate finish card for details.

Not all laminate colors are available on 1.5-inch thick worksurfaces, see the laminate finish card for details and refer to the column "1.5-inch surface" or "Metropolis".

Edge trim style must be specified for 1.5-inch thick worksurfaces. 1.5-inch thick worksurfaces are available in straight, gothic, and wave profiles.

options

thickness	C 1-inch	CT 1.5-inch
width	39, 51, 63	
depth	16, 21, 26	
trim style	R radiused	S straight
surface finish	laminate colors	
edge profile (1.5-inch only)	straight	gothic
support finish	metal colors	

how to order and read your code

Sample Order: C-table extension, 51-inches wide, 21-inches deep, radiused trim, finished in Maple (L104), with matching trim color, support finished in silver (P112).

NOTE: SAMPLE CODE HERE INCLUDES ALL AVAILABLE OPTIONS.

C	WC00	51	21	R	L104	gothic	P112
product line	item	width	depth	trim style	surface finish	edge profile	support finish

worksurfaces | c-table extension

Code	1" (C)	1.5" (CT)	W (in.)	D (in.)	Weight (lb.)	Volume (ft ³)
C_-WC00-3916	384	460	39	16	23.28	2.07
C_-WC00-5121	513	614	51	21	38.27	3.55
C_-WC00-6326	552	662	63	26	54.56	5.41

worksurfaces | u-table extension

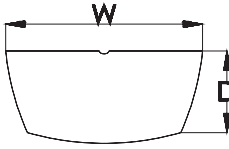
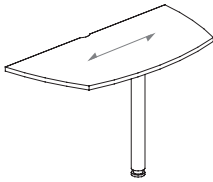

what's included:
U-Table Extension, metal support post

application notes:
Grain direction is indicated in the above illustration.

how to specify:
Specify laminate color.

Specify metal color for support posts.

The worksurface trim color will default to match the laminate color unless otherwise specified, see the laminate finish card for details.

Not all laminate colors are available on 1.5-inch thick worksurfaces, see the laminate finish card for details and refer to the column "1.5-inch surface" or "Metropolis".

Edge profile must be specified for 1.5-inch thick worksurfaces. 1.5-inch thick worksurfaces are available in straight, gothic, and wave profiles.

options

thickness	C 1-inch	CT 1.5-inch
width	39, 51, 63	
depth	18, 24, 28	
trim style	R radiused	S straight
surface finish	laminate colors	
edge profile (1.5-inch only)	straight	gothic
support finish	metal colors	

how to order and read your code

Sample Order: U-table extension, 51-inches wide, 24-inches deep, radiused trim, finished in Congo (L100), with matching trim color, support finished in silver (P112).

NOTE: SAMPLE CODE HERE INCLUDES ALL AVAILABLE OPTIONS.

C	WU00	51	24	R	L100	gothic	P112
product line	item	width	depth	trim style	surface finish	edge profile	support finish

worksurfaces | u-table extension

Code	1" (C)	1.5" (CT)	W (in.)	D (in.)	Weight (lb.)	Volume (ft ³)
C_-WU00-3918	409	490	39	18	13.12	0.62
C_-WU00-5124	541	649	51	24	17.14	0.81
C_-WU00-6328	623	748	63	28	21.17	1.02

worksurfaces | radiused straight surface

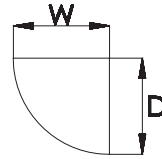
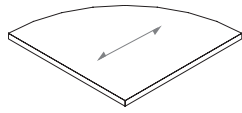

what's included:

Radiused Straight Surface

application notes:

Grain direction is indicated in the above illustration.

how to specify:

Specify laminate color.

Specify metal color for support posts.

The worksurface trim color will default to match the laminate color unless otherwise specified, see the laminate finish card for details.

Not all laminate colors are available on 1.5-inch thick worksurfaces, see the laminate finish card for details and refer to the column "1.5-inch surface" or "Metropolis".

Edge profile must be specified for 1.5-inch thick worksurfaces. 1.5-inch thick worksurfaces are available in straight, gothic, and wave profiles.

options

thickness	C 1-inch	CT 1.5-inch
width	24, 30	
depth	24, 30	
surface finish	laminate colors	
edge profile (1.5-inch only)	straight	gothic

how to order and read your code

Sample Order: Radiused straight surface, 24-inches wide, 24-inches deep, finished in Maple (L104), with matching trim color.

NOTE: SAMPLE CODE HERE INCLUDES ALL AVAILABLE OPTIONS.

C	WRS0	24	24	L104	gothic
product line	item	width	depth	surface finish	edge profile

worksurfaces | radiused straight surface

Code	1" (C)	1.5" (CT)	W (in.)	D (in.)	Weight (lb.)	Volume (ft ³)
C_-WRS0-2424	180	243	24	24	11.64	0.26
C_-WRS0-3030	225	304	30	30	11.64	0.41

worksurfaces | radiused extended surface

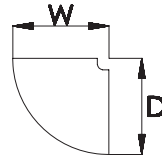
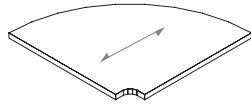

what's included:
Radiused Extended Surface

application notes:
Grain direction is indicated in the above illustration.

how to specify:
Specify laminate color.

Specify metal color for support posts.

The worksurface trim color will default to match the laminate color unless otherwise specified, see the laminate finish card for details.

Not all laminate colors are available on 1.5-inch thick worksurfaces, see the laminate finish card for details and refer to the column "1.5-inch surface" or "Metropolis".

Edge profile must be specified for 1.5-inch thick worksurfaces. 1.5-inch thick worksurfaces are available in straight, gothic, and wave profiles.

options

thickness	C 1-inch	CT 1.5-inch
width	27, 33	
depth	27, 33	
surface finish	laminate colors	
edge profile (1.5-inch only)	straight	gothic

how to order and read your code

Sample Order: Radiused extended surface, 33-inches wide, 33-inches deep, finished in Congo (L100), with matching trim color.

NOTE: SAMPLE CODE HERE INCLUDES ALL AVAILABLE OPTIONS.

C product line	WC01 item	33 width	33 depth	L100 surface finish	gothic edge profile
----------------------	--------------	-------------	-------------	---------------------------	---------------------------

worksurfaces | radiused extended surface

Code	1" (C)	1.5" (CT)	W (in.)	D (in.)	Weight (lb.)	Volume (ft ³)
C_-WC01-2727	210	283	27	27	13.81	0.33
C_-WC01-3333	254	345	33	33	14.3	0.49

worksurfaces | bridge worksurface

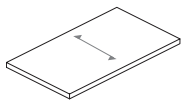

without grommet

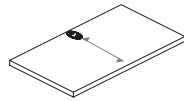

with grommet

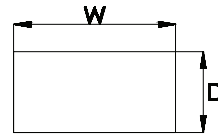

what's included:

Bridge worksurface.

application notes:

Grain direction is indicated in the above illustration.

how to specify:

The worksurface trim color will default to match the laminate color unless otherwise specified, see the laminate finish card for details.

Not all laminate colors are available on 1.5-inch thick worksurfaces, see the laminate finish card for details and refer to the column "1.5-inch surface" or "Metropolis".

Edge profile must be specified for 1.5-inch thick worksurfaces. 1.5-inch thick worksurfaces are available in straight, gothic, and wave profiles.

options

thickness	C 1-inch	CT 1.5-inch
grommet	0 without	G with grommet
width	24, 30, 36, 42, 48	
depth	18, 24, 30	
surface finish	laminate colors	
edge profile (1.5-inch only)	straight	gothic

how to order and read your code

Sample Order: Bridge worksurface, with grommet, 30-inches wide, 18-inches deep, finished in Congo (L100), with matching trim color.

NOTE: SAMPLE CODE HERE INCLUDES ALL AVAILABLE OPTIONS.

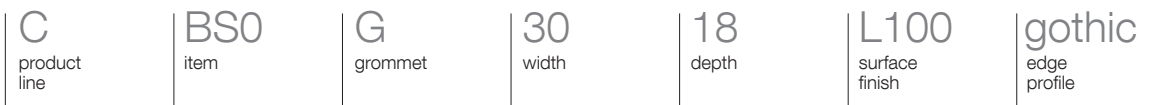

worksurfaces | bridge worksurface

Code	1" (C)	1.5" (CT)	W (in.)	D (in.)	Weight (lb.)	Volume (ft ³)
Without Grommet						
C-BS00-2418	157	215	24	18	5.18	0.25
C-BS00-3018	170	230	30	18	6.48	0.31
C-BS00-3618	176	241	36	18	7.78	0.38
C-BS00-4218	201	275	42	18	9.07	0.44
C-BS00-4818	212	289	48	18	10.37	0.5
C-BS00-2424	171	234	24	24	6.91	0.33
C-BS00-3024	180	249	30	24	8.64	0.42
C-BS00-3624	187	255	36	24	10.37	0.5
C-BS00-4224	220	302	42	24	12.1	0.58
C-BS00-4824	239	324	48	24	13.82	0.67
C-BS00-2430	180	249	24	30	8.64	0.42
C-BS00-3030	215	294	30	30	10.8	0.52
C-BS00-3630	229	312	36	30	12.96	0.63
C-BS00-4230	249	338	42	30	15.12	0.73
C-BS00-4830	271	367	48	30	17.28	0.83
With Grommet						
C-BS0G-2418	166	224	24	18	5.18	0.25
C-BS0G-3018	178	238	30	18	6.48	0.31
C-BS0G-3618	185	250	36	18	7.78	0.38
C-BS0G-4218	210	283	42	18	9.07	0.44
C-BS0G-4818	220	299	48	18	10.37	0.5
C-BS0G-2424	179	242	24	24	6.91	0.33
C-BS0G-3024	190	258	30	24	8.64	0.42
C-BS0G-3624	196	264	36	24	10.37	0.5
C-BS0G-4224	230	310	42	24	12.1	0.58
C-BS0G-4824	247	333	48	24	13.82	0.67
C-BS0G-2430	190	258	24	30	8.64	0.42
C-BS0G-3030	224	302	30	30	10.8	0.52
C-BS0G-3630	237	321	36	30	12.96	0.63
C-BS0G-4230	258	346	42	30	15.12	0.73
C-BS0G-4830	279	375	48	30	17.28	0.83

worksurfaces | straight transition worksurface

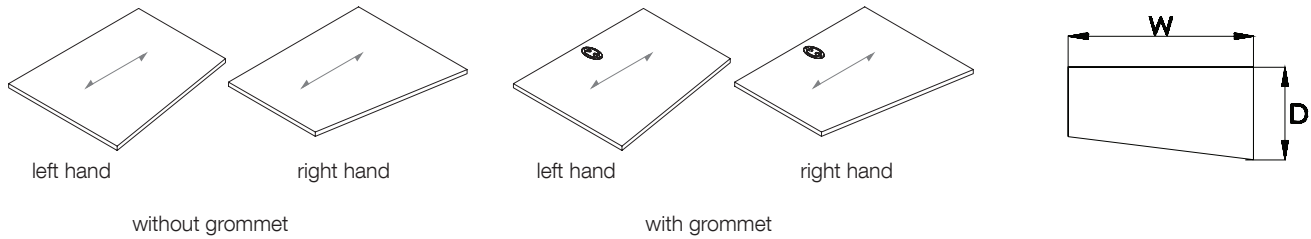

what's included:

Straight transition worksurface.

application notes:

Grain direction is indicated in the above illustration.

how to specify:

The worksurface trim color will default to match the laminate color unless otherwise specified, see the laminate finish card for details.

Not all laminate colors are available on 1.5-inch thick worksurfaces, see the laminate finish card for details and refer to the column "1.5-inch surface" or "Metropolis".

Edge profile must be specified for 1.5-inch thick worksurfaces. 1.5-inch thick worksurfaces are available in straight, gothic, and wave profiles.

options

thickness	C 1-inch	CT 1.5-inch
grommet	0 without	G with grommet
width	30, 36, 42, 48, 54, 60, 66, 72, 78, 84, 90, 96	
depth 1	24	
depth 2	30	
hand	L left	R right
surface finish	laminate colors	
edge profile (1.5-inch only)	straight	gothic

how to order and read your code

Sample Order: Straight transition worksurface, with grommet, 48-inches wide, 30-inches deep, left handed, finished in Congo (L100), with matching trim color.

NOTE: SAMPLE CODE HERE INCLUDES ALL AVAILABLE OPTIONS.



worksurfaces | straight transition worksurface

Code	1" (C)	1.5" (CT)	W (in.)	D1 (in.)	D2 (in.)	Weight (lb.)	Volume (ft ³)
Without Grommet							
C_-WST0-3030-_	215	302	30	24	30	10.8	0.52
C_-WST0-3630-_	229	321	36	24	30	12.96	0.63
C_-WST0-4230-_	249	346	42	24	30	15.12	0.73
C_-WST0-4830-_	271	375	48	24	30	17.28	0.83
C_-WST0-5430-_	303	420	54	24	30	19.44	0.94
C_-WST0-6030-_	320	445	60	24	30	21.6	1.04
C_-WST0-6630-_	365	496	66	24	30	23.76	1.15
C_-WST0-7230-_	374	509	72	24	30	25.92	1.25
C_-WST0-7830-_	409	556	78	24	30	28.08	1.35
C_-WST0-8430-_	441	602	84	24	30	30.24	1.46
C_-WST0-9030-_	504	685	90	24	30	32.4	1.56
C_-WST0-9630-_	545	742	96	24	30	34.56	1.67
With Grommet							
C_-WSTG-3030-_	224	310	30	24	30	10.8	0.52
C_-WSTG-3630-_	237	330	36	24	30	12.96	0.63
C_-WSTG-4230-_	258	354	42	24	30	15.12	0.73
C_-WSTG-4830-_	279	384	48	24	30	17.28	0.83
C_-WSTG-5430-_	311	430	54	24	30	19.44	0.94
C_-WSTG-6030-_	329	453	60	24	30	21.6	1.04
C_-WSTG-6630-_	375	505	66	24	30	23.76	1.15
C_-WSTG-7230-_	385	517	72	24	30	25.92	1.25
C_-WSTG-7830-_	419	564	78	24	30	28.08	1.35
C_-WSTG-8430-_	452	610	84	24	30	30.24	1.46
C_-WSTG-9030-_	515	693	90	24	30	32.4	1.56
C_-WSTG-9630-_	556	751	96	24	30	34.56	1.67

worksurfaces | tempered glass transaction top - straight

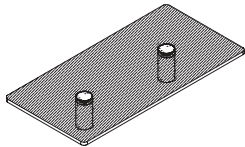

what's included:

Tempered Glass transaction top, installation hardware, two post legs

application notes:

The tempered glass transaction top can be mounted on top of one or two 37-inch high panel frames to provide a transaction surface for a reception station or between two workstations in a team environment.

The tempered glass transaction top is not applicable on 90, 120, or 135-degree configurations.

how to specify:

Specify metal finish.

When the tempered glass transaction top is to be mounted over a single panel frame, specify the transaction top to be the same width as the panel frame. When it is to be mounted over two panel frames, specify the transaction top to be the total width of the two panel frames.

Refer to page 11 for details on specifying panel frames.

options

width	24, 30, 36, 42, 48, 54
depth	12
metal finish	metal colors

how to order and read your code

Sample Order: Tempered glass transaction top, 36-inches wide, 12-inches deep, posts finished in silver (P112).

NOTE: SAMPLE CODE HERE INCLUDES ALL AVAILABLE OPTIONS.

C	WTGS	36	12	P112
product line	item	width	depth	metal finish

worksurfaces | tempered glass transaction top - straight

Code	Price	W (in.)	D (in.)	Weight (lb.)	Volume (ft ³)
C-WTGS-2412	560	24	12	5	0.2
C-WTGS-3012	603	30	12	6	0.2
C-WTGS-3612	641	36	12	7	0.3
C-WTGS-4212	678	42	12	8	0.3
C-WTGS-4812	716	48	12	9	0.3
C-WTGS-5412	754	54	12	10	0.3

worksurfaces | laminate countertop

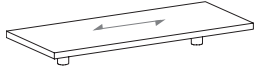

what's included:

Laminate countertop, installation hardware, two post legs.

application notes:

The laminate countertop can be mounted on top of one or two 37-inch high panel frames to provide a transaction surface for a reception station or between two workstations in a team environment.

Grain direction is indicated in the above illustration.

how to specify:

Specify laminate color.

Specify metal finish.

When the laminate countertop is to be mounted over a single panel frame, specify the countertop to be the same width as the panel frame. When it is to be mounted over two panel frames, specify the countertop to be the total width of the two panel frames.

Refer to page 11 for details on specifying panel frames.

options

width	24, 30, 36, 42, 48, 54, 60			
depth	15			
configuration	90-degree	120-degree	135-degree	180-degree
end shape	straight			
	right 90-degree corner	left 90-degree corner	dual 90-degree corner	
	right 120-degree corner	left 120-degree corner	dual 120-degree corner	
	right 135-degree corner	left 135-degree corner	dual 135-degree corner	
surface finish	laminate colors			
metal finish	metal colors			

how to order and read your code

Sample Order: Laminate countertop, 30-inches wide, 15-inches deep, 90-degree configuration, straight end shape, congo (L100) surface finish, posts finished in silver (P112).

NOTE: SAMPLE CODE HERE INCLUDES ALL AVAILABLE OPTIONS.

C	WTLO	30	15	90	S	L100	P112
product line	item	width	depth	configuration	end shape	surface finish	metal finish

worksurfaces | laminate countertop

Code	1" (C)	1.5" (CT)	W (in.)	D (in.)	Weight (lb.)	Volume (ft ³)
180-degree countertop						
C_-WTLO-2415	308	338	24	15	4.32	0.21
C_-WTLO-3015	331	370	30	15	5.4	0.26
C_-WTLO-3615	349	396	36	15	6.48	0.31
C_-WTLO-4215	357	407	42	15	7.56	0.36
C_-WTLO-4815	388	448	48	15	8.64	0.42
C_-WTLO-5415	403	470	54	15	9.72	0.47
C_-WTLO-6015	416	492	60	15	10.8	0.52
90-degree corner (single)						
C_-WTLA-2415-_	351	393	24	15	4.32	0.21
C_-WTLA-3015-_	375	425	30	15	4.32	0.26
C_-WTLA-3615-_	390	439	36	15	6.48	0.31
C_-WTLA-4215-_	406	448	42	15	7.56	0.36
C_-WTLA-4815-_	428	473	48	15	8.64	0.42
C_-WTLA-5415-_	447	491	54	15	9.72	0.47
C_-WTLA-6015-_	467	511	60	15	10.8	0.52
90-degree corner (dual)						
C_-WTLA-2415	393	445	24	15	4.32	0.21
C_-WTLA-3015	425	485	30	15	5.4	0.26
C_-WTLA-3615	439	507	36	15	6.48	0.31
C_-WTLA-4215	448	518	42	15	7.56	0.36
C_-WTLA-4815	473	555	48	15	8.64	0.42
C_-WTLA-5415	491	581	54	15	9.72	0.47
C_-WTLA-6015	511	608	60	15	10.8	0.52
120-degree corner (single)						
C_-WTLB-2415-_	343	379	24	15	4.32	0.21
C_-WTLB-3015-_	367	411	30	15	5.4	0.26
C_-WTLB-3615-_	381	433	36	15	6.48	0.31
C_-WTLB-4215-_	387	444	42	15	7.56	0.36
C_-WTLB-4815-_	419	485	48	15	8.64	0.42
C_-WTLB-5415-_	434	506	54	15	9.72	0.47
C_-WTLB-6015-_	452	534	60	15	10.8	0.52
120-degree corner (dual)						
C_-WTLB-2415	373	414	24	15	4.32	0.21
C_-WTLB-3015	397	449	30	15	5.4	0.26
C_-WTLB-3615	412	470	36	15	6.48	0.31
C_-WTLB-4215	426	488	42	15	7.56	0.36
C_-WTLB-4815	449	522	48	15	8.64	0.42
C_-WTLB-5415	470	548	54	15	9.72	0.47
C_-WTLB-6015	488	576	60	15	10.8	0.52
135-degree corner (single)						
C_-WTLC-2415-_	340	373	24	15	4.32	0.21
C_-WTLC-3015-_	358	402	30	15	5.4	0.26
C_-WTLC-3615-_	377	428	36	15	6.48	0.31
C_-WTLC-4215-_	384	438	42	15	7.56	0.36
C_-WTLC-4815-_	415	480	48	15	8.64	0.42
C_-WTLC-5415-_	430	527	54	15	9.72	0.47
C_-WTLC-6015-_	448	534	60	15	10.8	0.52
135-degree corner (dual)						
C_-WTLC-2415	367	404	24	15	4.32	0.21
C_-WTLC-3015	390	437	30	15	5.4	0.26
C_-WTLC-3615	405	459	36	15	6.48	0.31
C_-WTLC-4215	419	438	42	15	7.56	0.36
C_-WTLC-4815	442	512	48	15	8.64	0.42
C_-WTLC-5415	461	539	54	15	9.72	0.47
C_-WTLC-6015	476	559	60	15	10.8	0.52

worksurface supports | cantilever arm

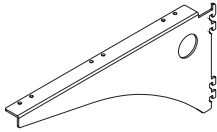

what's included:
 Cantilever Arm, installation hardware.

how to specify:
 Cantilever arms are available only in black.

application notes:
 The cantilever arm mounts to the panel frame to support worksurfaces.

Worksurfaces 24-inches and greater require the 22-inch cantilever to be used.

options

size	16, 22		
position	right	left	intermediate

how to order and read your code

Sample Order: Cantilever arm, 16-inch, left-handed.

NOTE: SAMPLE CODE HERE INCLUDES ALL AVAILABLE OPTIONS.



worksurface supports | cantilever arm

Code	Price	D (in.)	Weight (lb.)	Volume (ft ³)
C-CCAB-16-	63	16	2.2	0.01
C-CCAB-22-	68	22	2.7	0.01

worksurface supports | laminate gable

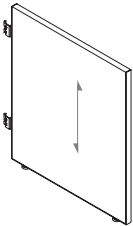

right

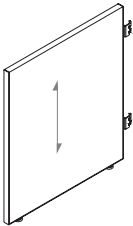

left

what's included:
Gable, installation hardware.

how to specify:
Specify laminate color.

application notes:
Grain direction is indicated in the above illustration.

The vinyl trim color will default to match the laminate color unless otherwise specified. See the laminate finish card for details.

Gables can be used for single or dual worksurface support in the left, right and center positions.

The left and right gables are designed to match the depth of standard worksurfaces. The center gable will be slightly shorter than the depth of the worksurface to allow for below worksurface leg room.

options

position	R right	L left	U universal
size	12, 18, 24, 30, 36		
finish	laminate colors		

how to order and read your code

Sample Order: Gable, right-handed, 30-inches, finished in Congo (L100), with matching trim color.

NOTE: SAMPLE CODE HERE INCLUDES ALL AVAILABLE OPTIONS.

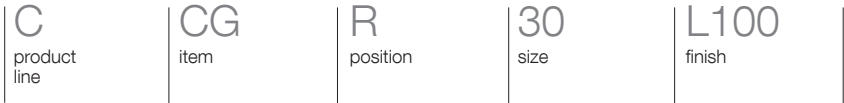

workspace supports | laminate gable

Code	Price	H (in.)	D (in.)	Weight (lb.)	Volume (ft ³)
C-CG_0-12	77	28	12	7.5	0.01
C-CG_0-18	91	28	18	11.47	0.01
C-CG_0-24	105	28	24	15.4	0.01
C-CG_0-30	122	28	30	19.32	0.01
C-CG_0-36	135	28	36	19.35	0.01

worksurface supports | intermediate gable

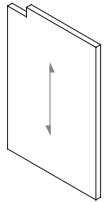

right

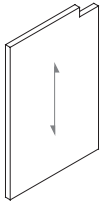

left

what's included:
Gable, installation hardware.

how to specify:
Specify laminate color.

application notes:
Grain direction is indicated in the above illustration.

The vinyl trim color will default to match the laminate color unless otherwise specified. See the laminate finish card for details.

Gables can be used in panel mounted or modesty mounted applications in the left, right, or center positions.

options

position	R right	L left	U universal
size	12, 18		
finish	laminate colors		

how to order and read your code

Sample Order: Gable, right-handed, 30-inches, finished in Congo (L100), with matching trim color.

NOTE: SAMPLE CODE HERE INCLUDES ALL AVAILABLE OPTIONS.



worksurface supports | intermediate gable

Code	Price	H (in.)	D (in.)	Weight (lb.)	Volume (ft ³)
C-CG_C-12	77	28	12	7.5	0.01
C-CG_C-18	91	28	18	11.47	0.01

worksurface supports | open metal gable

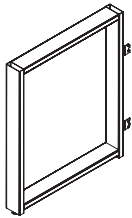

Right hand

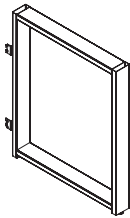

Left hand

what's included:

Open metal gable, installation hardware

how to specify:

Specify metal color.

application notes:

Open metal gables can be used to support worksurfaces in the left or right position.

The depth of the open metal gable should match the depth of the worksurface that it will support at the end of a run.

Use the 12 or 18 inch worksurfaces to support worksurface in the middle of a run.

Open metal gables cannot be used in freestanding applications.

options

position	R right	L left
size	12, 18, 24, 30	
finish	metal colors	

how to order and read your code

Sample Order: Open metal gable, right hand, 24-inch deep, finished in silver (P112).

NOTE: SAMPLE CODE HERE INCLUDES ALL AVAILABLE OPTIONS.

C product line	CG item	R position	24 size	P112 finish
----------------------	------------	---------------	------------	----------------

worksurface supports | open metal gable

Code	Price	H (in.)	D (in.)	Weight (lb.)	Volume (ft ³)
C-CGLM-12	294	28	12	6	0.58
C-CGLM-18	310	28	18	10	0.88
C-CGLM-24	332	28	24	14	1.17
C-CGLM-30	352	28	30	14	1.17
C-CGRM-12	294	28	12	6	0.58
C-CGRM-18	310	28	18	10	0.88
C-CGRM-24	332	28	24	14	1.17
C-CGRM-30	352	28	30	14	1.17

worksurface supports | single post

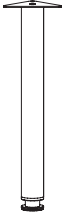

what's included:

Single Post, leveler, installation hardware.

how to specify:

Specify metal finish. See the metal finish card for details.

application notes:

The single post is 28-inch in height and includes an integral leveler that provides a 3-inch levelling range.

This item should be used together with panel-mounted worksurface supports to support semi-suspended worksurfaces.

options

finish

metal finish colors

how to order and read your code

Sample Order: Single post, finished in black (P114).

NOTE: SAMPLE CODE HERE INCLUDES ALL AVAILABLE OPTIONS.

C	CP1G	03	P114
product line	item	diameter	finish

worksurface supports | single post

Code	Price	H (in.)	Weight (lb.)	Volume (ft ³)
C-CP1G-03	89	28	7	0.11

workspace supports | horizontal surface support



what's included:

Horizontal Surface Support, installation hardware.

how to specify:

The horizontal surface support is available only in black.

application notes:

The horizontal surface support is used to support worksurfaces 54-inches and longer.

This item is mounted to the underside of a worksurface.

options

width	54, 60, 66, 72, 78
-------	--------------------

how to order and read your code

Sample Order: Horizontal surface support, 72-inches wide.

NOTE: SAMPLE CODE HERE INCLUDES ALL AVAILABLE OPTIONS.

C	CH00	72	
product line	item	width	

worksurface supports | horizontal surface support

Code	Price	W (in.)	Weight (lb.)	Volume (ft ³)
C-CH00-54	43	54	4	0.05
C-CH00-60	46	60	4.5	0.05
C-CH00-66	49	66	5	0.06
C-CH00-72	52	72	5.5	0.06
C-CH00-78	56	78	6	0.07

worksurface supports | universal bracket

Code	Price	Weight (lb.)	Volume (ft ³)
C-CB01-L	6	1	0.01

mounted storage | panel-mounted flipper cabinet

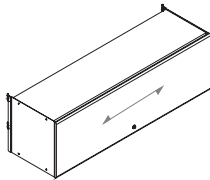

flipper cabinet

what's included:
 Panel-Mounted Flipper Cabinet, installation hardware.

application notes:
 The panel-mounted flipper cabinet mounts on-module to panel frames of the same width.

The optional pneumatic slide allows the flipper door to come down slowly and quietly.

Grain direction is indicated in the above illustration.

how to specify:
 Specify metal color.

Specify laminate color (for laminate faced flipper only).

Specify option P for pneumatic slides.

The vinyl trim color will default to match the laminate color unless otherwise specified. See the laminate finish card for details.

options

depth	14	
width	30, 36, 42, 48, 54, 60	
door finish	L laminate colors	M metal colors
enhancements	P pneumatic*	
case finish	metal colors	

* An upcharge is applicable when this option is specified.

how to order and read your code

Sample Order: Panel-mounted flipper cabinet, metal door, 14-inches deep, 54-inches wide, pneumatic slide, case finished in black (P114).

NOTE: SAMPLE CODE HERE INCLUDES ALL AVAILABLE OPTIONS.

C product line	SOF item	M door finish	14 depth	54 width	P enhancements	P114 case finish
----------------------	-------------	---------------------	-------------	-------------	-------------------	------------------------

mounted storage | panel-mounted flipper cabinet

Code	Standard	Pneumatic	H (in.)	W (in.)	D (in.)	Weight (lb.)	Volume (ft ³)
Laminate							
C-SOFL-1430	471	683	16	30	14	32.1	2.92
C-SOFL-1436	506	718	16	36	14	34.7	3.5
C-SOFL-1442	534	745	16	42	14	38.6	4.08
C-SOFL-1448	556	768	16	48	14	42.5	4.67
C-SOFL-1454	567	779	16	54	14	45.7	5.25
C-SOFL-1460	607	819	16	60	14	49.1	5.83
Metal							
C-SOFM-1430	516	728	16	30	14	32.1	2.92
C-SOFM-1436	556	768	16	36	14	34.7	3.5
C-SOFM-1442	588	800	16	42	14	38.6	4.08
C-SOFM-1448	612	824	16	48	14	42.5	4.67
C-SOFM-1454	623	835	16	54	14	45.7	5.25
C-SOFM-1460	667	880	16	60	14	49.1	5.83

mounted storage | suspended flipper cabinet

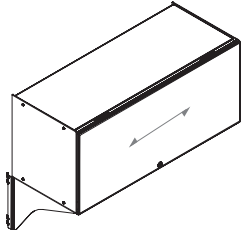

suspended flipper cabinet

what's included:

Suspended flipper cabinet, installation hardware.

application notes:

The suspended flipper cabinet mounts on-module to panel frames of the same width.

The optional pneumatic slide allows the flipper door to come down slowly and quietly.

Grain direction is indicated in the above illustration.

how to specify:

Specify metal color.

Specify laminate color (for laminate faced flipper only).

Specify option P for pneumatic slides.

The vinyl trim color will default to match the laminate color unless otherwise specified. See the laminate finish card for details.

options

depth	14	
width	30, 36, 42, 48, 54, 60	
door finish	L laminate colors	M metal colors
enhancements	P pneumatic*	
case finish	metal colors	

* An upcharge is applicable when this option is specified.

how to order and read your code

Sample Order: Suspended flipper cabinet, metal door, 14-inches deep, 54-inches wide, pneumatic slide, case finished in black (P114).

NOTE: SAMPLE CODE HERE INCLUDES ALL AVAILABLE OPTIONS.

C product line	SSF item	M door finish	14 depth	54 width	P enhancements	P114 case finish
----------------------	-------------	---------------------	-------------	-------------	-------------------	------------------------

mounted storage | suspended flipper cabinet

Code	Standard	Pneumatic	H (in.)	W (in.)	D (in.)	Weight (lb.)	Volume (ft ³)
Laminate							
C-SSFL-1430	580	802	30	14	14	32.1	2.1
C-SSFL-1436	615	836	36	14	14	34.7	3.5
C-SSFL-1442	642	863	42	14	14	38.6	4.1
C-SSFL-1448	661	882	48	14	14	42.5	4.7
C-SSFL-1454	668	890	54	14	14	45.7	5.3
C-SSFL-1460	709	930	60	14	14	49.1	5.8
Metal							
C-SSFM-1430	620	840	30	14	14	32.1	2.92
C-SSFM-1436	658	881	36	14	14	34.7	3.5
C-SSFM-1442	692	913	42	14	14	38.6	4.08
C-SSFM-1448	714	934	48	14	14	42.5	4.67
C-SSFM-1454	742	941	54	14	14	45.7	5.25
C-SSFM-1460	766	988	60	14	14	49.1	5.83

mounted storage | wall mounted flipper cabinet

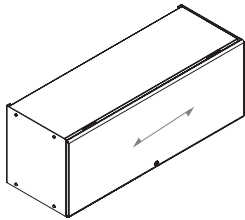

wall mounted flipper cabinet

what's included:

Wall mounted flipper cabinet, installation hardware.

application notes:

The wall-mounted flipper cabinet mounts off-module to walls to provide overhead storage in a workstation.

The optional pneumatic slide allows the flipper door to come down slowly and quietly.

Grain direction is indicated in the above illustration.

how to specify:

Specify metal color.

Specify laminate color (for laminate faced flipper only).

Specify option P for pneumatic slides.

The vinyl trim color will default to match the laminate color unless otherwise specified. See the laminate finish card for details.

options

depth	14	
width	30, 36, 42, 48, 54, 60	
door finish	L laminate colors	M metal colors
enhancements	P pneumatic*	
case finish	metal colors	

* An upcharge is applicable when this option is specified.

how to order and read your code

Sample Order: Wall mounted flipper cabinet, metal door, 14-inches deep, 54-inches wide, pneumatic slide, case finished in White (P121).

NOTE: SAMPLE CODE HERE INCLUDES ALL AVAILABLE OPTIONS.

C product line	SOF item	M door finish	14 depth	30 width	P enhancements	P121 case finish
----------------------	-------------	---------------------	-------------	-------------	-------------------	------------------------

mounted storage | wall mounted flipper cabinet

Code	Standard	Pneumatic	H (in.)	W (in.)	D (in.)	Weight (lb.)	Volume (ft ³)
Laminate							
C-SOFL-1430-W	471	663	16	30	14	32.1	2.92
C-SOFL-1436-W	506	697	16	36	14	34.7	3.5
C-SOFL-1442-W	534	723	16	42	14	38.6	4.08
C-SOFL-1448-W	556	746	16	48	14	42.5	4.67
C-SOFL-1454-W	567	756	16	54	14	45.7	5.25
C-SOFL-1460-W	607	795	16	60	14	49.1	5.83
Metal							
C-SOFM-1430-W	516	707	16	30	14	32.1	2.92
C-SOFM-1436-W	556	746	16	36	14	34.7	3.5
C-SOFM-1442-W	588	777	16	42	14	38.6	4.08
C-SOFM-1448-W	612	800	16	48	14	42.5	4.67
C-SOFM-1454-W	623	811	16	54	14	45.7	5.25
C-SOFM-1460-W	667	854	16	60	14	49.1	5.83

mounted storage | open metal shelf

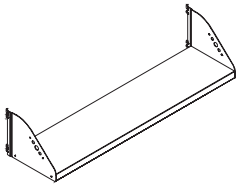

open metal shelf

what's included:
Open Metal Shelf, installation hardware

how to specify:
Specify metal color.

application notes:
The open metal shelf is panel-mounted on-module, and provides open storage within the workstation.

options

width 24, 30, 36, 42, 48, 54, 60
case finish metal colors

how to order and read your code

Sample Order: Open metal shelf, 12-inches deep, 36-inches wide, case finished in silver (P112).

NOTE: SAMPLE CODE HERE INCLUDES ALL AVAILABLE OPTIONS.

C	SOOM	12	36	P112
product line	item	depth	width	case finish

mounted storage | open metal shelf

Code	Price	W (in.)	D (in.)	Weight (lb.)	Volume (ft ³)
C-SOOM-1224	132	24	12	13.03	1
C-SOOM-1230	137	30	12	13.03	1.25
C-SOOM-1236	146	36	12	14.75	1.5
C-SOOM-1242	152	42	12	16.48	1.75
C-SOOM-1248	157	48	12	18.2	2
C-SOOM-1254	164	54	12	19.93	2.25
C-SOOM-1260	170	60	12	21.65	2.5

mounted storage | overhead back bracket

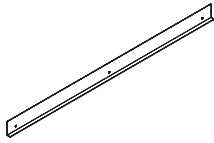

what's included:

Overhead Back Bracket, installation hardware

how to specify:

Specify metal color.

options

width	24, 30, 36, 42, 48, 54, 60
finish	metal colors

how to order and read your code

Sample Order: Overhead back bracket, 30-inches wide, finished in espresso sparkle (P117).

NOTE: SAMPLE CODE HERE INCLUDES ALL AVAILABLE OPTIONS.

C product line	SOBB item	30 width	P117 finish
----------------------	--------------	-------------	----------------

mounted storage | overhead back bracket

Code	Price	W (in.)	Weight (lb.)	Volume (ft ³)
C-SOBB-24	21	24	1	0.01
C-SOBB-30	23	30	1	0.02
C-SOBB-36	26	36	1.2	0.02
C-SOBB-42	28	42	1.4	0.02
C-SOBB-48	30	48	1.6	0.03
C-SOBB-54	33	54	1.8	0.03
C-SOBB-60	35	60	2	0.03

mounted storage | double channel wall mount bracket kit

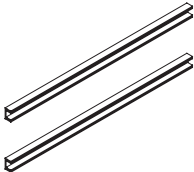

what's included:

Double channel wall mount bracket kit

how to specify:

The double channel wall mount bracket kit is only available in black.

options

width	24, 30, 36, 42, 48, 54, 60
finish	black

how to order and read your code

Sample Order: Double channel wall mount bracket kit, 30-inches wide.

NOTE: SAMPLE CODE HERE INCLUDES ALL AVAILABLE OPTIONS.

C	ADWB	30	
product line	item	width	

mounted storage | double channel wall mount bracket kit

Code	Price	W (in.)	Weight (lb.)	Volume (ft ³)
C-ADWB-24-KIT	70	23.5	2	0.03
C-ADWB-30-KIT	87	29.5	4	0.04
C-ADWB-36-KIT	106	35.5	6	0.05
C-ADWB-42-KIT	126	41.5	8	0.05
C-ADWB-48-KIT	143	47.5	10	0.06
C-ADWB-54-KIT	161	53.5	12	0.07
C-ADWB-60-KIT	179	59.5	14	0.08

mounted storage | top mounted shared open shelf

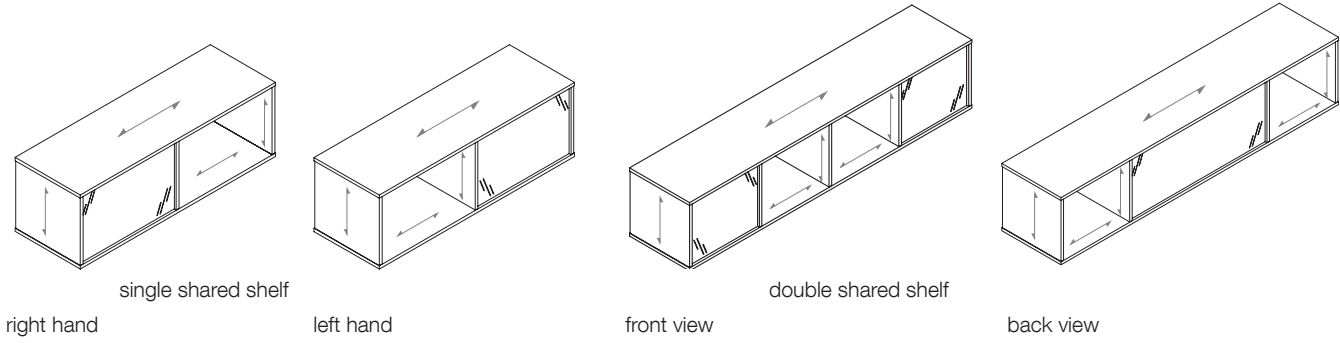

what's included:
Top mounted shared open shelf, installation hardware

how to specify:
Specify laminate color.

application notes:
The top mounted shared shelf mounts on top of a panel frame and provides open storage to two workstations.

Specify back option.

The back of the top mounted shared shelf can be finished in acrylic or whiteboard.

Grain direction is indicated in the above illustration.

The single unit can be used on top of one or two panel frames.

The double units is used over two or more panel frames where a 3-way or 4-way 90 degree connector is also present, as illustrated above.

options

back finish	G acrylic	W whiteboard
width	24, 30, 36, 42, 48, 54, 60	
depth	16	
height	16	
hand	L left	R right
case finish	laminate colors	

how to order and read your code

Sample Order: Top mounted shared open shelf, acrylic back, 36-inch wide, 16-inch deep, 16-inch high, right handed, finished in Tuxedo (L132).

NOTE: SAMPLE CODE HERE INCLUDES ALL AVAILABLE OPTIONS.



mounted storage | top mounted shared open shelf

Code	Acrylic	Whiteboard	H (in.)	W (in.)	D (in.)	Weight (lb.)	Volume (ft ³)
Single Shared Shelves							
C-SSO_-30-_	563	506	16	30	16	35	2.5
C-SSO_-36-_	614	542	16	36	16	38	3
C-SSO_-42-_	666	578	16	42	16	41	3.5
C-SSO_-48-_	717	613	16	48	16	44	4
C-SSO_-54-_	769	650	16	54	16	47	4.5
C-SSO_-60-_	821	686	16	60	16	50	5
C-SSO_-72-_	922	757	16	72	16	56	6
C-SSO_-84-_	1024	829	16	84	16	62	7
Double Shared Shelves							
C-SSO_-51-_	844	707	16	51	16	46	4.5
C-SSO_-57-_	900	743	16	57	16	49	5
C-SSO_-63-_	957	779	16	63	16	52	5.5
C-SSO_-69-_	1014	815	16	69	16	55	5.5
C-SSO_-75-_	1071	850	16	75	16	58	6.5
C-SSO_-81-_	1127	887	16	81	16	61	6.5
C-SSO_-87-_	1185	923	16	87	16	64	7.5

mounted storage | cubby storage

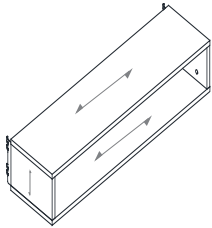

cubby storage

what's included:
Cubby storage, installation hardware.

application notes:
The panel-mounted cubby storage mounts on-module to panel frames of the same width.

Grain direction is indicated in the above illustration.

how to specify:
Specify laminate colour.

Specify hardware finish.

The vinyl trim colour will default to match the laminate colour unless otherwise specified. See the laminate finish card for details.

options

depth	11
width	24, 30, 36, 42, 48
height	8
finish	L laminate colours
hardware finish	M metal colours

how to order and read your code

Sample Order: Mounted cubby storage, 11" deep and 24" wide.

NOTE: SAMPLE CODE HERE INCLUDES ALL AVAILABLE OPTIONS.

C	SCS	11	24
product line	item	depth	width

mounted storage | cubby storage

Code	Price	H (in.)	W (in.)	D (in.)	Weight (lb.)	Volume (ft ³)
cubby storage						
C-SCS-081124	190	8	24	11	24	1.3
C-SCS-081130	204	8	30	11	30	1.7
C-SCS-081136	218	8	36	11	36	2
C-SCS-081142	233	8	42	11	42	2.3
C-SCS-081148	265	8	48	11	48	2.7

freestanding storage | mobile pedestal

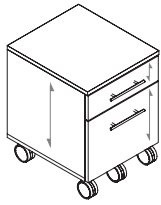

mobile pedestal

what's included:

One mobile pedestal, lock and key, pencil tray.

application notes:

The mobile pedestal is 21-inches deep and is equipped with castors for easy mobility.

The Manhattan handle style is offered on mobile pedestals.

Grain direction is indicated in the above illustration.

how to specify:

Refer to the laminate finish card for a complete listing of laminate colors.

The edge trim style will default to match the finish of the pedestal unless otherwise specified. Refer to the laminate finish card for details.

options

height	23
width	17
case and drawer finish	laminate colors

how to order and read your code

Sample Order: Mobile pedestal, finished in silver (L112).

NOTE: SAMPLE CODE HERE INCLUDES ALL AVAILABLE OPTIONS.

C	1000	23	17	L112
product line	item	height	width	case and drawer finish

freestanding storage | mobile pedestal

Code	Price	H (in.)	W (in.)	D (in.)	Weight (lb.)	Volume (ft ³)
C-1000-2317	726	28	17	23	75	4.75

freestanding storage | mobile pedestal with seat

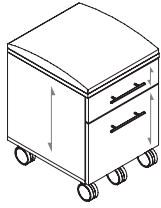

mobile pedestal with seat

what's included:

One mobile pedestal with seat, lock and key, pencil tray.

application notes:

The mobile pedestal with seat is 21-inches deep and is equipped with castors for easy mobility.

The Manhattan handle style is offered on mobile pedestals.

Grain direction is indicated in the above illustration.

how to specify:

Refer to the laminate finish card for a complete listing of laminate colors.

The edge trim style will default to match the finish of the pedestal unless otherwise specified. Refer to the laminate finish card for details.

options

height	23
width	17
case and drawer finish	laminate colors
seating upholstery	seating fabrics

how to order and read your code

Sample Order: Mobile pedestal with seat, white case and drawer finish (L121), Sigma Hydrogen seating fabric (9202)

NOTE: SAMPLE CODE HERE INCLUDES ALL AVAILABLE OPTIONS.

C product line	1030 item	23 height	17 width	L121 case and drawer finish	9202 seating upholstery
----------------------	--------------	--------------	-------------	-----------------------------------	-------------------------------

freestanding storage | mobile pedestal with seat

Code	Gr1	Gr2	Gr3	Gr6	H (in.)	W (in.)	D (in.)	Weight (lb.)	Volume (ft ³)
C-1030-2317	756	776	796	856	24	16	8 1/4	60	5.64

freestanding storage | freestanding pedestal

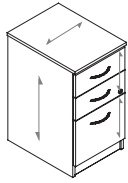

box/box/file

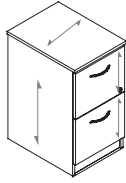

file/file

what's included:

Freestanding Pedestal, lock and keys.

application notes:

Pedestals are 21-inches deep.

The box/box/file freestanding pedestal includes a pencil tray.

Grain direction is indicated in the above illustration.

how to specify:

Specify laminate color.

Specify handle style.

Handles default to Melbourne, unless otherwise specified.

The vinyl trim color will default to match the laminate color unless otherwise specified. See the laminate finish card for details.

options

type	B box/box/file	F file/file
width	16	
depth	21	
case finish	laminate colors	
handle style	brooklyn	melbourne
	clifton	humber
	manhattan	rosedale

how to order and read your code

Sample Order: Freestanding pedestal, box/box/file, 16-inches wide, 21-inches deep, case finished in Congo (L100), with matching trim color, Humber handle style.

NOTE: SAMPLE CODE HERE INCLUDES ALL AVAILABLE OPTIONS.

C product line	FPBF item	16 height	21 depth	L100 case finish	HUMBER handle style
----------------------	--------------	--------------	-------------	------------------------	---------------------------

freestanding storage | freestanding pedestal

Code	Price	H (in.)	W (in.)	D (in.)	Weight (lb.)	Volume (ft ³)
Box/Box/File						
C-FPBF-1621	640	29	16	21	67.2	5.64
File/File						
C-FPFF-1621	565	29	16	21	67.2	5.64

storage | underdesk pedestal



box/box/file

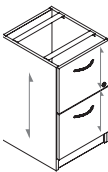

file/file

what's included:
 Freestanding Pedestal, lock and keys.

application notes:
 Pedestals are 18-inches deep.

The box/box/file freestanding pedestal includes a pencil tray.

Grain direction is indicated in the above illustration.

how to specify:
 Specify laminate color.

Specify handle style.

Handles default to Melbourne, unless otherwise specified.

The vinyl trim color will default to match the laminate color unless otherwise specified. See the laminate finish card for details.

options

type	B box/box/file	F file/file
width	16	
depth	18	
case finish	laminate colors	
handle style	brooklyn	melbourne
	clifton	humber
	manhattan	rosedale

how to order and read your code

Sample Order: Underdesk pedestal, 16-inches wide, 18-inches deep, case finished in white (L121), with matching trim, Brooklyn handle style.

NOTE: SAMPLE CODE HERE INCLUDES ALL AVAILABLE OPTIONS.

C product line	FPFU item	16 width	18 depth	L121 case finish	BROOKLYN handle style
----------------------	--------------	-------------	-------------	------------------------	-----------------------------

storage | underdesk pedestal

Code	Price	H (in.)	W (in.)	D (in.)	Weight (lb.)	Volume (ft ³)
Box/Box/File C-FPBU-1618	557	28	16	18	58	4.67
File/File C-FPFU-1618	493	28	16	18	56.5	4.67

storage | end gable pedestal



box/box/file

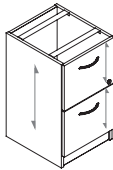

file/file

what's included:

End Gable Pedestal, lock and keys.

application notes:

End gable pedestals are 24-inches or 30-inches deep, depending on the depth of the worksurface that they will be supporting.

The box/box/file end gable pedestal includes a pencil tray.

Grain direction is indicated in the above illustration.

how to specify:

Specify laminate color.

Specify handle style.

Handles default to Melbourne, unless otherwise specified.

The vinyl trim color will default to match the laminate color unless otherwise specified. See the laminate finish card for details.

options

type	B box/box/file	F file/file
width	16	
depth	24, 30	
hand	R right	L left
case finish	laminate colors	
handle style	brooklyn	melbourne
	clifton	humber
	manhattan	rosedale

how to order and read your code

Sample Order: Gable pedestal, file/file, 16-inches wide, 24-inches deep, right-handed, case finished in Congo (L100), with matching trim color, Rosedale handle style.

NOTE: SAMPLE CODE HERE INCLUDES ALL AVAILABLE OPTIONS.

C product line	FPFU item	16 width	24 depth	R hand	L100 case finish	ROSEDALE handle style
----------------------	--------------	-------------	-------------	-----------	------------------------	-----------------------------

storage | end gable pedestal

Code	Price	H (in.)	W (in.)	D (in.)	Weight (lb.)	Volume (ft ³)
Box/Box/File						
C-FPBU-1624-_ C-FPBU-1630-_ 	607 641	28 28	16 16	24 30	58 71	6.22 5.2
File/File						
C-FPFU-1624-_ C-FPFU-1630-_ 	544 577	28 28	16 16	24 30	58 71	6.22 5.2

storage | underdesk metal pedestal

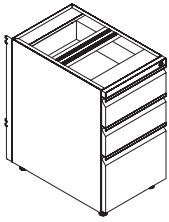

box/box/file - left

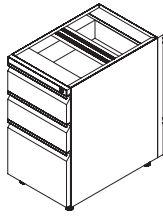

box/box/file - right

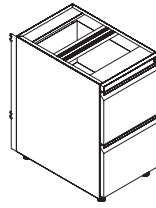

file/file - left

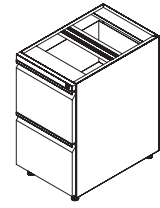

file/file - right

what's included:

Underdesk Metal Pedestal, bracket, lock and keys.

application notes:

Metal Pedestals are 23-inches deep, 15-inches wide and 28-inches tall.

Each pedestal comes with four adjustable 1.5-inch leveling glides that provide up to 1-inch of height adjustment.

Pedestal drawers are available in either box/box/file or file/file configurations.

All drawers are lockable, and are equipped with full-extension slides. File drawers have front to back or side to side filing capabilities. Top box drawers include a pencil tray.

Pedestals are made with durable 20-gauge steel and drawers feature a double wall steel construction.

how to specify:

Pedestals are finished in powder coated silver or white.

Pedestals are keyed randomly.

Brackets that secure metal pedestals to panels are handed.

Specify the metal pedestal and bracket ensemble to be the same depth as the worksurface under which it will be located.

options

type	B box/box/file	F file/file
width	15	
depth	24, 30	
case finish	S silver	
hand	L left	R right
face finish	P112 Silver	

how to order and read your code

Sample Order: Underdesk metal pedestal, box/box/file, 15-inches wide, 24-inches deep, left handed, finished in Silver (P112).

NOTE: SAMPLE CODE HERE INCLUDES ALL AVAILABLE OPTIONS.

C product line	FPBU item	15 height	24 depth	S case finish	L hand	P112 face finish
----------------------	--------------	--------------	-------------	---------------------	-----------	------------------------

storage | underdesk metal pedestal

Code	Price	H (in.)	W (in.)	D (in.)	Weight (lb.)	Volume (ft ³)
File/File						
C-FPFU-1524-S-L	391	28	15	24	92	8.0
C-FPFU-1524-S-R	391	28	15	24	92	8.0
C-FPFU-1530-S-L	413	28	15	24	92	8.0
C-FPFU-1530-S-R	413	28	15	24	92	8.0
Box/Box/File						
C-FPBU-1524-S-L	422	28	15	24	92	8.0
C-FPBU-1524-S-R	422	28	15	24	92	8.0
C-FPBU-1530-S-L	444	28	15	24	92	8.0
C-FPBU-1530-S-R	444	28	15	24	92	8.0

storage | underworksurface open shelf

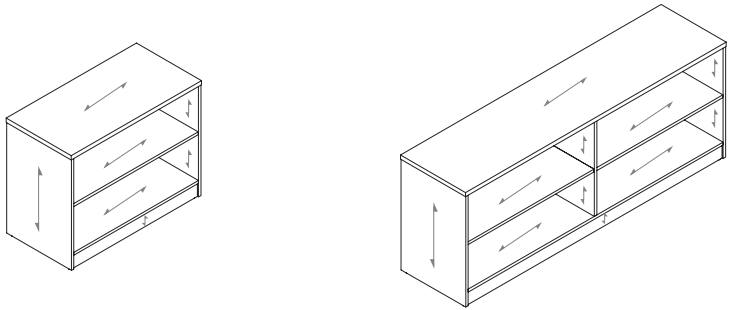

what's included:
Underworksurface open shelf, installation hardware.

how to specify:
Specify laminate color.

application notes:
The underworksurface open shelf support worksurfaces and provides below worksurface storage.

Grain direction is indicated in the above illustration.

options

width	24, 30, 36, 42, 48, 54, 60, 66, 72, 78, 84, 90, 96
depth	18
height	28
case finish	laminate colors

how to order and read your code

Sample Order: Under worksurface open shelf, 54-inch wide, 18-inches deep, 28-inches high, finished in white (L121)

NOTE: SAMPLE CODE HERE INCLUDES ALL AVAILABLE OPTIONS.

C product line	FSOU item	54 width	18 depth	28 height	L121 case finish
----------------------	--------------	-------------	-------------	--------------	------------------------

storage | under worksurface open shelf

Code	Price	H (in.)	W (in.)	D (in.)	Weight (lb.)	Volume (ft ³)
C-FSOU-2418	431	28	24	18	20	7.2
C-FSOU-3018	467	28	30	18	24	9
C-FSOU-3618	502	28	36	18	28	10.8
C-FSOU-4218	537	28	42	18	32	12.6
C-FSOU-4818	572	28	48	18	36	14.4
C-FSOU-5418	741	28	54	18	40	16.2
C-FSOU-6018	778	28	60	18	44	18
C-FSOU-6618	815	28	66	18	48	19.8
C-FSOU-7218	851	28	72	18	52	21.6
C-FSOU-7818	891	28	78	18	56	23.4
C-FSOU-8418	928	28	84	18	60	25.2
C-FSOU-9018	965	28	90	18	64	27
C-FSOU-9618	1001	28	96	18	68	28.8

freestanding storage | mobile pedestal

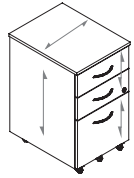

box/box/file

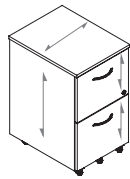

file/file

what's included:

Mobile Pedestal, lock and keys.

application notes:

Mobile pedestals are 21-inches deep.

The box/box/file mobile pedestal includes a pencil tray.

The fifth caster is lockable and provides stability for the mobile pedestal.

Grain direction is indicated in the above illustration.

how to specify:

Specify laminate color.

Specify handle style.

Handles default to Melbourne, unless otherwise specified.

The vinyl trim color will default to match the laminate color unless otherwise specified. See the laminate finish card for details.

options

type	B box/box/file	F file/file
width	16	
depth	21	
case finish	laminate colors	
handle style	brooklyn	melbourne
	clifton	humber
	manhattan	rosedale

how to order and read your code

Sample Order: Mobile pedestal, file/file/, 16-inches wide, 21-inches deep, case finished in Maple (L104), with matching trim color, Humber handle style.

NOTE: SAMPLE CODE HERE INCLUDES ALL AVAILABLE OPTIONS.

C product line	FPFM item	16 height	21 depth	L104 case finish	HUMBER handle style
----------------------	--------------	--------------	-------------	------------------------	---------------------------

freestanding storage | mobile pedestal

Code	Price	H (in.)	W (in.)	D (in.)	Weight (lb.)	Volume (ft ³)
Box/Box/File						
C-FPBM-1621	648	28	16	21	60	5.64
File/File						
C-FPFM-1621	575	28	16	21	60	5.64

freestanding storage | freestanding joined pedestal

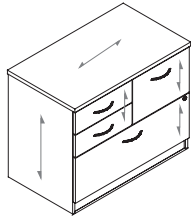

what's included:

Freestanding Joined Pedestal, lock and keys.

application notes:

Freestanding joined pedestals are 21-inches deep.

The freestanding joined pedestal includes a pencil tray.

Grain direction is indicated in the above illustration.

how to specify:

Specify laminate color.

Specify handle style.

Handles default to Melbourne, unless otherwise specified.

The vinyl trim color will default to match the laminate color unless otherwise specified. See the laminate finish card for details.

options

width	36	
depth	21	
case finish	laminate colors	
handle style	brooklyn	melbourne
	clifton	humber
	manhattan	rosedale

how to order and read your code

Sample Order: Freestanding joined pedestal, 36-inches wide, 21-inches deep, case finished in white (L121), with matching trim color, Humber handle style.

NOTE: SAMPLE CODE HERE INCLUDES ALL AVAILABLE OPTIONS.

C product line	FPJF item	36 height	21 depth	L121 case finish	HUMBER handle style
----------------------	--------------	--------------	-------------	------------------------	---------------------------

freestanding storage | freestanding joined pedestal

Code	Price	H (in.)	W (in.)	D (in.)	Weight (lb.)	Volume (ft ³)
C-FPJF-3621	1111	29	36	21	130	12.69

storage | underdesk joined pedestal

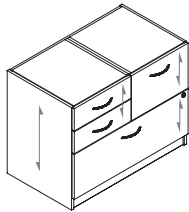

what's included:
 Freestanding Joined Pedestal, lock and keys.

application notes:
 Freestanding joined pedestals are 21-inches deep.

The underdesk joined pedestal includes a pencil tray.

Grain direction is indicated in the above illustration.

how to specify:
 Specify laminate color.

Specify handle style.

Handles default to Melbourne, unless otherwise specified.

The vinyl trim color will default to match the laminate color unless otherwise specified. See the laminate finish card for details.

options

width	36	
depth	21	
case finish	laminate colors	
handle style	brooklyn	melbourne
	clifton	humber
	manhattan	rosedale

how to order and read your code

Sample Order: Freestanding joined pedestal, 36-inches wide, 21-inches deep, case finished in white (L121), with matching trim color, Humber handle style.

NOTE: SAMPLE CODE HERE INCLUDES ALL AVAILABLE OPTIONS.

C	FPJU	36	21	L100	CLIFTON
product line	item	height	depth	case finish	handle style

storage | underdesk joined pedestal

Code	Price	H (in.)	W (in.)	D (in.)	Weight (lb.)	Volume (ft ³)
C-FPJU-3621	1089	28	36	21	130	12.69

freestanding storage | freestanding lateral file

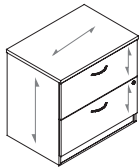

2-drawer

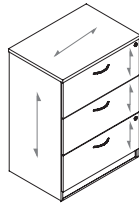

3-drawer

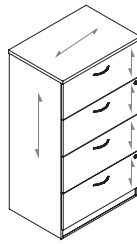

4-drawer

what's included:

Freestanding Lateral File, lock and keys.

application notes:

Laterals are 21-inches deep.

Grain direction is indicated in the above illustration.

Disclaimer: Please note that lateral file drawers are intended for filing letter and legal size paper front to back or side to side only. For details and weight restrictions please contact customer service.

how to specify:

Specify laminate color.

Specify handle style.

Handles default to Melbourne, unless otherwise specified.

The vinyl trim color will default to match the laminate color unless otherwise specified. See the laminate finish card for details.

options

type	2 two-drawer	3 three-drawer
	4 four-drawer	
width	30, 36, 42	
depth	21	
case finish	laminate colors	
handle style	brooklyn	melbourne
	clifton	humber
	manhattan	rosedale

how to order and read your code

Sample Order: Freestanding lateral file, 4-drawer, 42-inches wide, 21-inches deep, case finished in Congo (L100), with matching trim color, Rosedale handle style.

NOTE: SAMPLE CODE HERE INCLUDES ALL AVAILABLE OPTIONS.

C	FL4F	42	21	L100	ROSEDALE
product line	item	height	width	case finish	handle style

freestanding storage | freestanding lateral file

Code	Price	H (in.)	W (in.)	D (in.)	Weight (lb.)	Volume (ft ³)
2-Drawer						
C-FL2F-3021	893	29	30	21	107	10.57
C-FL2F-3621	947	29	36	21	130	12.69
C-FL2F-4221	994	29	42	21	150	14.8
3-Drawer						
C-FL3F-3021	1224	40.5	30	21	167	14.77
C-FL3F-3621	1296	40.5	36	21	180	17.72
4-Drawer						
C-FL4F-3021	1534	52.5	30	21	200	19.14
C-FL4F-3621	1625	52.5	36	21	240	22.97

storage | underdesk lateral file

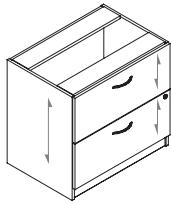

2-drawer

what's included:
Underdesk Lateral File, lock and keys.

application notes:
Laterals are 21-inches deep.

Grain direction is indicated in the above illustration.

Disclaimer: Please note that lateral file drawers are intended for filing letter and legal size paper front to back or side to side only. For details and weight restrictions please contact customer service.

how to specify:
Specify laminate color.

Specify handle style.

Handles default to Melbourne, unless otherwise specified.

The vinyl trim color will default to match the laminate color unless otherwise specified. See the laminate finish card for details.

options

width	30, 36, 42	
depth	21	
case finish	laminate colors	
handle style	brooklyn	melbourne
	clifton	humber
	manhattan	rosedale

how to order and read your code

Sample Order: Underdesk lateral file, 30-inches wide, 21-inches deep, case finished in Zebra (L108), with matching trim color, Clifton handle style.

NOTE: SAMPLE CODE HERE INCLUDES ALL AVAILABLE OPTIONS.

C product line	FL2U item	30 height	21 width	L108 case finish	CLIFTON handle style
----------------------	--------------	--------------	-------------	------------------------	----------------------------

storage | underdesk lateral file

Code	Price	H (in.)	W (in.)	D (in.)	Weight (lb.)	Volume (ft ³)
2-Drawer						
C-FL2U-3021	865	28	30	21	107	10.21
C-FL2U-3621	912	28	36	21	130	12.25
C-FL2U-4221	957	28	42	21	150	14.29

freestanding storage | freestanding storage cabinet

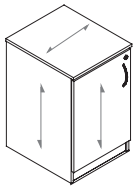

single door

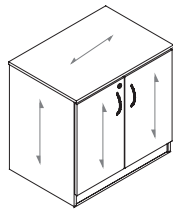

double door

what's included:

Freestanding Storage Cabinet, lock and keys.

application notes:

Storage cabinets are 21-inches deep.

Grain direction is indicated in the above illustration.

how to specify:

Specify laminate color.

Specify handle style.

Handles default to Melbourne, unless otherwise specified.

The vinyl trim color will default to match the laminate color unless otherwise specified. See the laminate finish card for details.

options

width	18, 30, 36	
hand (for single door cabinet only)	R right	L left
case finish	laminate colors	
handle style	brooklyn	melbourne
	clifton	humber
	manhattan	rosedale

how to order and read your code

Sample Order: Freestanding storage cabinet, 30-inches wide, 21-inches deep, case finished in Congo (L100), with matching trim color, Brooklyn handle style.

NOTE: SAMPLE CODE HERE INCLUDES ALL AVAILABLE OPTIONS.

C product line	FSF0 item	30 width	21 depth	L100 case finish	BROOKLYN handle style
----------------------	--------------	-------------	-------------	------------------------	-----------------------------

freestanding storage | freestanding storage cabinet

Code	Price	H (in.)	W (in.)	D (in.)	Weight (lb.)	Volume (ft ³)
Single Door						
C-FSF0-1821- <u> </u>	514	29	18	21	80	6.34
Double Door						
C-FSF0-3021	703	29	30	21	107	7.4
C-FSF0-3621	750	29	36	21	130	7.4

storage | underdesk storage cabinet

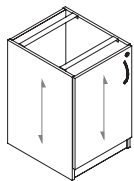

single door

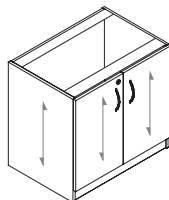

double door

what's included:

Underdesk Storage Cabinet, lock and keys.

application notes:

Storage cabinets are 21-inches deep.

Grain direction is indicated in the above illustration.

how to specify:

Specify laminate color.

Specify handle style.

Handles default to Melbourne, unless otherwise specified.

The vinyl trim color will default to match the laminate color unless otherwise specified. See the laminate finish card for details.

options

width	18, 30, 36	
depth	21	
hand (for single door cabinet only)	R right	L left
case finish	laminate colors	
handle style	brooklyn	melbourne
	clifton	humber
	manhattan	rosedale

how to order and read your code

Sample Order: Underdesk storage cabinet, 18-inches wide, 21-inches deep, right-handed, finished in White (L121), with matching trim color, Clifton handle style.

NOTE: SAMPLE CODE HERE INCLUDES ALL AVAILABLE OPTIONS.

C product line	FSU0 item	18 width	21 depth	R hand	L121 case finish	CLIFTON handle style
----------------------	--------------	-------------	-------------	-----------	------------------------	----------------------------

storage | underdesk storage cabinet

Code	Price	H (in.)	W (in.)	D (in.)	Weight (lb.)	Volume (ft ³)
Single Door						
C-FSU0-1821- <u> </u>	499	28	18	21	80	6.13
Double Door						
C-FSU0-3021	686	28	30	21	107	10.21
C-FSU0-3621	730	28	36	21	130	12.25

freestanding storage | open storage tower

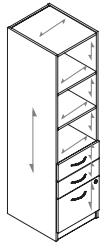

box/box/file

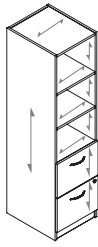

file/file

what's included:

Storage Tower, shelves, lock and keys, levelers.

application notes:

Shelves are adjustable in 1-inch increments.

Grain direction is indicated in the above illustration.

how to specify:

Specify laminate color.

Specify handle style.

Handles default to Melbourne, unless otherwise specified.

The vinyl trim color will default to match the laminate color unless otherwise specified. See the laminate finish card for details.

options

type	00 box/box/file	10 file/file
height	66	
width	18	
depth	21	
case finish	laminate colors	
handle style	brooklyn	melbourne
	clifton	humber
	manhattan	rosedale

how to order and read your code

Sample Order: Open storage, box/box/file, 66-inches high, 18-inches wide, 21-inches deep, case finished in Maple (L104), with matching trim color, Humber handle style.

NOTE: SAMPLE CODE HERE INCLUDES ALL AVAILABLE OPTIONS.

C	8000	66	18	21	L104	HUMBER
product line	item	height	width	depth	case finish	handle style

freestanding storage | open storage tower

Code	Price	H (in.)	W (in.)	D (in.)	Weight (lb.)	Volume (ft ³)
File/File						
C-8010-6618	1002	66	18	21	180	13.64
Box/Box/File						
C-8000-6618	1066	66	18	21	180	13.64

freestanding storage | closed storage tower

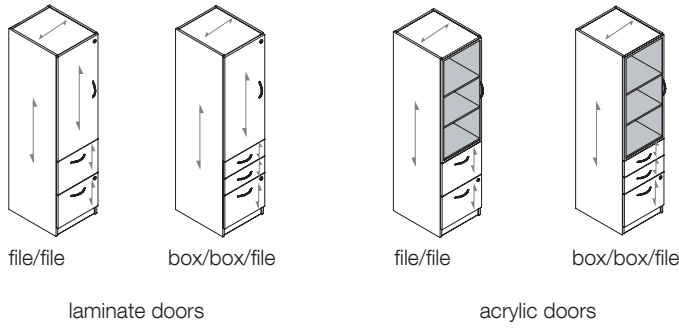

what's included:

Closed Storage Tower, shelves, lock and keys, levelers.

application notes:

Shelves are adjustable in 1-inch increments.

Grain direction is indicated in the above illustration.

how to specify:

Specify laminate color.

Specify handle style.

Handles default to Melbourne, unless otherwise specified.

The vinyl trim color will default to match the laminate color unless otherwise specified. See the laminate finish card for details.

options

type	00 box/box/file	10 file/file
height	66	
width	18	
depth	21	
hand	R right	L left
case finish	laminated colors	
handle style	brooklyn	melbourne
	clifton	humber
	manhattan	rosedale

how to order and read your code

Sample Order: Closed storage tower, box/box/file, 66-inches high, 18-inches wide, 21-inches deep, right-handed, finished in Maple (L104), with matching trim color, Humber handle style.

NOTE: SAMPLE CODE HERE INCLUDES ALL AVAILABLE OPTIONS.

C	7000	66	18	21	R	L104	HUMBER
product line	item	height	width	depth	hand	case finish	handle style

freestanding storage | closed storage tower

Code	Price	H (in.)	W (in.)	D (in.)	Weight (lb.)	Volume (ft ³)
laminate doors						
File/File						
C-7010-6618-__	1139	66	18	21	180	13.64
Box/Box/File						
C-7000-6618-__	1203	66	18	21	180	13.64
acrylic doors						
File/File						
C-7010-6618-_-G	1535	66	18	21	180	13.64
Box/Box/File						
C-7000-6618-_-G	1590	66	18	21	180	13.64

freestanding storage | open storage tower with wardrobe

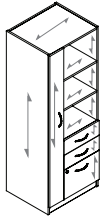

box/box/file
left hand

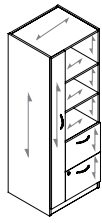

file/file
left hand

what's included:

Storage Tower with Wardrobe, shelves, lock and keys, levelers.

application notes:

Shelves are adjustable in 1-inch increments.

Cabinets are 21-inches deep.

Grain direction is indicated in the above illustration.

how to specify:

Specify laminate color.

Specify handle style.

Handles default to Melbourne, unless otherwise specified.

The vinyl trim color will default to match the laminate color unless otherwise specified. See the laminate finish card for details.

options

type	30 box/box/file	40 file/file
height	66	
width	24	
depth	21	
hand	R right	L left
case finish	laminate colors	
handle style	brooklyn	melbourne
	clifton	humber
	manhattan	rosedale

how to order and read your code

Sample Order: Open storage tower with wardrobe, file/file, 66-inches high, 24-inches wide, 21-inches deep, case finished in Zebra (L109), with matching trim color, Clifton handle style.

NOTE: SAMPLE CODE HERE INCLUDES ALL AVAILABLE OPTIONS.

C product line	8040 item	66 height	24 width	21 depth	L109 case finish	CLIFTON handle style
----------------------	--------------	--------------	-------------	-------------	------------------------	----------------------------

freestanding storage | open storage tower with wardrobe

Code	Price	H (in.)	W (in.)	D (in.)	Weight (lb.)	Volume (ft ³)
File/File						
C-8040-6624- <u> </u>	1320	66	24	21	190	19.25
Box/Box/File						
C-8030-6624- <u> </u>	1383	66	24	21	190	19.25

freestanding storage | closed storage tower with closet

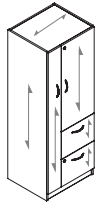

file/file



box/box/file

what's included:

Closed Storage Tower with Closet, shelves, coat rod, lock and keys, levelers.

application notes:

Shelves are adjustable in 1-inch increments.

Cabinets are 21-inches deep.

Grain direction is indicated in the above illustration.

how to specify:

Specify laminate color.

Specify handle style.

Handles default to Melbourne, unless otherwise specified.

The vinyl trim color will default to match the laminate color unless otherwise specified. See the laminate finish card for details.

options

type	00 box/box/file	10 file/file
height	66	
width	24	
depth	21	
hand	R right	L left
case finish	laminate colors	
handle style	brooklyn	melbourne
	clifton	humber
	manhattan	rosedale

how to order and read your code

Sample Order: Closed storage tower with closet, file/file, 66-inches high, 24-inches wide, 21-inches deep, right-handed, case finished in Zebra (L108), with matching trim color, Clifton handle style.

NOTE: SAMPLE CODE HERE INCLUDES ALL AVAILABLE OPTIONS.

C product line	6010 item	66 height	24 width	21 depth	R hand	L108 case finish	CLIFTON handle style
----------------------	--------------	--------------	-------------	-------------	-----------	------------------------	----------------------------

freestanding storage | closed storage tower with wardrobe

Code	Price	H (in.)	W (in.)	D (in.)	Weight (lb.)	Volume (ft ³)
File/File						
C-6010-6624- ₋	1474	66	24	21	195	19.25
Box/Box/File						
C-6000-6624- ₋	1538	66	24	21	195	19.25

freestanding storage | file/file/file storage tower

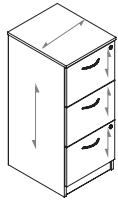

what's included:

File/File/File Storage Tower, lock and keys.

application notes:

Towers are 21-inches deep.

Grain direction is indicated in the above illustration.

how to specify:

Specify laminate color.

Specify handle style.

Handles default to Melbourne, unless otherwise specified.

The vinyl trim color will default to match the laminate color unless otherwise specified. See the laminate finish card for details.

options

height	42	
width	18	
depth	21	
case finish	laminate colors	
handle style	brooklyn	melbourne
	clifton	humber
	manhattan	rosedale

how to order and read your code

Sample Order: File/file/file storage tower, 42-inches high, 18-inches wide, 21-inches deep, case finished in Maple (L104), with matching trim color, Humber handle style.

NOTE: SAMPLE CODE HERE INCLUDES ALL AVAILABLE OPTIONS.

C	3000	42	18	21	L104	HUMBER
product line	item	height	width	depth	case finish	handle style

freestanding storage | file/file/file storage tower

Code	Price	H (in.)	W (in.)	D (in.)	Weight (lb.)	Volume (ft ³)
C-3000-4218	860	42	18	21	120	8.68

freestanding storage | single door storage cabinet

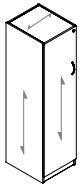

with coat bar
left hand

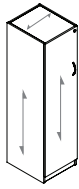

with shelves
left hand



with coat bar and shelves
left hand

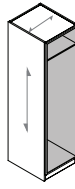

with coat bar
left hand

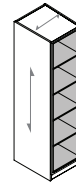

with shelves
left hand

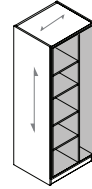

with coat bar and shelves
left hand

what's included:

Single Door Storage Cabinet, shelves and/or coat bar, lock and keys, levelers.

application notes:

One shelf is fixed at worksurface height, while the other shelves are adjustable in 1-inch increments.

Cabinets are 21-inches deep.

Grain direction is indicated in the above illustration.

how to specify:

Specify laminate color.

Specify handle style.

Handles default to Melbourne, unless otherwise specified.

The vinyl trim color will default to match the laminate color unless otherwise specified. See the laminate finish card for details.

options

height	66	
width	18, 24	
depth	21	
hand	R right	L left
case finish	laminate colors	
handle style	brooklyn	melbourne
	clifton	humber
	manhattan	rosedale

how to order and read your code

Sample Order: Single door storage cabinet, 66-inches high, 18-inches wide, 21-inches deep, right-handed, case finished in Congo (L100), with matching trim color, Rosedale handle style.

NOTE: SAMPLE CODE HERE INCLUDES ALL AVAILABLE OPTIONS.

C	FSDB	66	18	21	R	L100	ROSEDALE
product line	item	height	width	depth	hand	case finish	handle style

freestanding storage | single door storage cabinet

Code	Price	H (in.)	W (in.)	D (in.)	Weight (lb.)	Volume (ft ³)
laminate doors						
With Coat Bar C-FSDB-1821-_-	769	66	18	21	140	14.44
With Shelves C-FSDS-1821-_-	914	66	18	21	160	13.74
With Coat Bar and Shelves C-FSDC-2421-_-	1091	66	24	21	150	19.25
acrylic doors						
With Coat Bar C-FSDB-1821-_-G	1313	66	18	21	140	13.64
With Shelves C-FSDS-1821-_-G	1457	66	18	21	160	13.74
With Coat Bar and Shelves C-FSDC-2421-_-G	1727	66	24	21	150	19.25

freestanding storage | double door storage tower

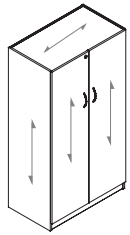

double laminate door with shelves

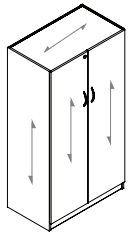

double laminate door with coat bar

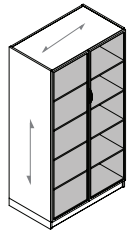

double acrylic door with shelves

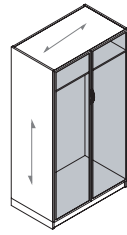

double acrylic door with coat bar

what's included:

Double Door Storage Cabinet, shelves or coat rod, lock and keys, levelers.

application notes:

One shelf is fixed at worksurface height, while the other shelves are adjustable in 1-inch increments.

Cabinets are 21-inches deep.

Grain direction is indicated in the above illustration.

how to specify:

Specify laminate color.

Specify handle style.

Handles default to Melbourne, unless otherwise specified.

The vinyl trim color will default to match the laminate color unless otherwise specified. See the laminate finish card for details.

options

height	66	
width	36	
depth	21	
case finish	laminate colors	
handle style	brooklyn	melbourne
	clifton	humber
	manhattan	rosedale

how to order and read your code

Sample Order: Double door storage tower, 66-inches high, 36-inches wide, 21-inches deep, case finished in Zebra (L108), with matching trim color, Clifton handle style.

NOTE: SAMPLE CODE HERE INCLUDES ALL AVAILABLE OPTIONS.

C	FSDB	66	36	21	L108	CLIFTON
product line	item	height	width	depth	case finish	handle style

freestanding storage | double door storage tower

Code	Price	H (in.)	W (in.)	D (in.)	Weight (lb.)	Volume (ft ³)
laminate doors						
With Coat Bar C-FSDB-3621	1191	66	36	21	195	28.88
With Shelves C-FSDS-3621	1323	66	36	21	195	29.09
acrylic doors						
With Coat Bar C-FSDB-3621-G	2223	66	36	21	195	29.09
With Shelves C-FSDS-3621-G	2448	66	36	21	195	29.09

freestanding storage | combination cabinet

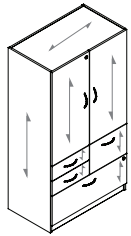

joined pedestal
left hand

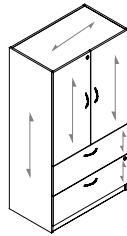

lateral file

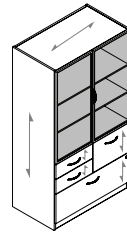

joined pedestal
left hand

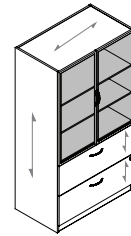

lateral file

what's included:

Combination Cabinet, shelves, lock and keys, levelers.

application notes:

Shelves are adjustable in 1-inch increments.

Cabinets are 21-inches deep.

Grain direction is indicated in the above illustration.

Disclaimer: Please note that lateral file drawers are intended for filing letter and legal size paper front to back or side to side only. For details and weight restrictions please contact customer service.

how to specify:

Specify laminate color.

Specify handle style.

Handles default to Melbourne, unless otherwise specified.

The vinyl trim color will default to match the laminate color unless otherwise specified. See the laminate finish card for details.

options

configuration	J joined pedestal	L lateral file
height	66	
width	30, 36	
depth	21	
case finish	lamine colors	
handle style	brooklyn	melbourne
	clifton	humber
	manhattan	rosedale

how to order and read your code

Sample Order: Combination cabinet with lateral file, 66-inches high, 30-inches wide, 21-inches deep, base finished in Zebra (L108), with matching trim color, Brooklyn handle style.

NOTE: SAMPLE CODE HERE INCLUDES ALL AVAILABLE OPTIONS.

C	FCS	L	66	30	21	L108	BROOKLYN
product line	item	configuration	height	width	depth	case finish	handle style

freestanding storage | combination cabinet

Code	Price	H (in.)	W (in.)	D (in.)	Weight (lb.)	Volume (ft ³)
laminate doors						
With Joined Pedestal						
C-FCSJ-3621	1820	66	30	21	240	29.09
With Lateral File						
C-FCSL-3021	1640	66	30	21	220	24.24
C-FCSL-3621	1751	66	36	21	240	29.09
acrylic doors						
With Joined Pedestal						
C-FCSJ-3621-G	2604	66	36	21	240	29.09
With Lateral File						
C-FCSL-3021-G	2379	66	30	21	220	24.24
C-FCSL-3621-G	2535	66	36	21	240	29.09

accessories | work organizers

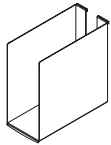

binder bin

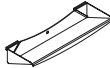

clip/pen tray

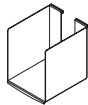

media holder



pen holder

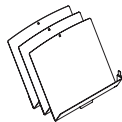

paper sorter

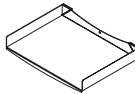

paper tray

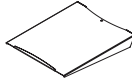

phone tray

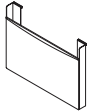

paper folder

what's included:

One work organizer, as specified.

how to specify:

Work organizers are available in a variety of metal finish colors.

application notes:

Work organizers hang from accessory tile, accessory bar, and surface mounted work organizer support.

Refer to the metal accent and metal finish card for a complete listing of metal colors.

Paper trays are available in letter and legal sizes.

Paper folders are available in letter and legal sizes.

Media holder accommodates CD/DVD

options

accessory type	B binder bin	R clip/pen tray	M media holder
	L-9 letter paper folder	L-13 legal paper folder	S paper sorter
	P-9 paper tray (letter)	P-13 paper tray (legal)	H pen holder
	T-9 phone tray (small)	T-13 phone tray (large)	
finish	metal colors (except chrome)		

how to order and read your code

Sample Order: Binder bin, finished in silver (P112).

NOTE: SAMPLE CODE HERE INCLUDES ALL AVAILABLE OPTIONS.

C	AA	B	P112
product line	item	accessory type	finish color

accessories | work organizers

Code	Price	H (in.)	W (in.)	D (in.)	Weight (lb.)	Volume (ft ³)
Binder Bin						
C-AAB	56	0	0	0	2.5	0.1
Clip/Pen Tray						
C-AAR	50	0	0	0	2.7	0.1
Media Holder						
C-AAM	46	0	0	0	3.2	0.1
Letter Paper Folder						
C-AAL-9	59	9	15	1	3.2	0.1
Legal Paper Folder						
C-AAL-13	64	9	12	1	3.2	0.1
Paper Sorter						
C-AAS	113	11	10	3	3.2	0.1
Paper Tray (Letter)						
C-AAP-9	57	2	15	9	3.2	0.1
Paper Tray (Legal)						
C-AAP-13	64	2	12	9	3.2	0.1
Pen Holder						
C-AAH	50	4	4	2	1.13	0.1
Phone Tray (Small)						
C-AAT-9	55	1	10	11	2.5	0.1
Phone Tray (Large)						
C-AAT-13	59	1	9	11	2.5	0.1

accessories | accessory bar

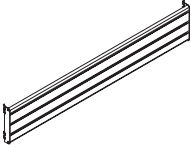

what's included:
Accessory Bar.

how to specify:
Specify metal color.

application notes:
Accessory bars are installed over panel tiles in 1-inch increments.

options

width	18, 24, 30, 36, 42, 48, 54, 60
finish	metal colors

how to order and read your code

Sample Order: Accessory bar, 30-inches wide, finished in silver (P112).

NOTE: SAMPLE CODE HERE INCLUDES ALL AVAILABLE OPTIONS.

C product line	AAB0 item	30 width	P112 finish color
----------------------	--------------	-------------	-------------------------

accessories | accessory bar

Code	Price	H (in.)	W (in.)	Weight (lb.)	Volume (ft ³)
C-AAB0-18	84	8	18	1.7	0.04
C-AAB0-24	99	8	24	1.7	0.06
C-AAB0-30	113	8	30	1.9	0.07
C-AAB0-36	129	8	36	2.3	0.08
C-AAB0-42	144	8	42	2.7	0.1
C-AAB0-48	159	8	48	2.9	0.11
C-AAB0-54	173	8	54	3.2	0.13
C-AAB0-60	188	8	60	3.5	0.14

accessories | pencil tray

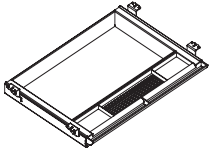

21-inch

what's included:
Pencil Drawer, installation hardware, mounting slides.

how to specify:
This product is available only in black.

application notes:
Pencil drawers provide compartmentalized pencil and stationary storage below the worksurface.

options

There are no options for this product.

how to order and read your code

Sample Order: Pencil drawer.

NOTE: SAMPLE CODE HERE INCLUDES ALL AVAILABLE OPTIONS.

C	ADPP
product line	item

accessories | pencil tray

Code	Price	W (in.)	D (in.)	Weight (lb.)	Volume (ft ³)
C-ADPP	53	21	16	2	0.62

accessories | magnetic whiteboard strips

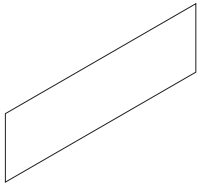

what's included:
Magnetic Whiteboard Strip.

application notes:
The magnetic whiteboard strip sticks to metal tiles
and metal flipper cabinet doors.

Dry erase markers should be used on magnetic
whiteboard strips.

options

width	30, 36, 42, 48, 54, 60
-------	------------------------

how to order and read your code

Sample Order: Magnetic whiteboard strip, 54-inch width.

NOTE: SAMPLE CODE HERE INCLUDES ALL AVAILABLE OPTIONS.

C product line	AMMS item	54 width
----------------------	--------------	-------------

accessories | magnetic whiteboard strips

Code	Price	H (in.)	W (in.)	Weight (lb.)	Volume (ft ³)
C-AMMS-30	95	13	30	1	0.03
C-AMMS-36	113	13	36	1.2	0.03
C-AMMS-42	129	13	42	1.4	0.04
C-AMMS-48	146	13	48	1.6	0.05
C-AMMS-54	164	13	54	1.8	0.05
C-AMMS-60	180	13	60	2	0.06

accessories | coat hook

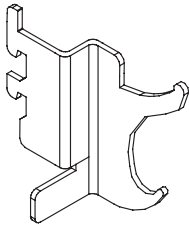

what's included:
Coat Hook.

how to specify:
Specify metal color.

application notes:
The coat hook can be attached to the hingeway between cosmopolitan panel frames.

options

finish metal colors

how to order and read your code

Sample Order: Coat hook, finished in polished metal (P116).

NOTE: SAMPLE CODE HERE INCLUDES ALL AVAILABLE OPTIONS.

C	ACH0	P116
product line	item	finish color

accessories | coat hook

Code	Price	Weight (lb.)	Volume (ft ³)
C-ACH0	49	0	0.01

accessories | name plate

Code	Price	Weight (lb.)	Volume (ft ³)
C-ANPS	93	1	0.01

accessories | worksurface edge mounted screen

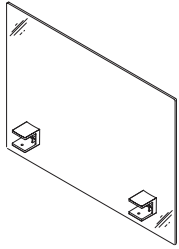

edge mounted screen

what's included:

Worksurface edge mounted screen, two clamps.

application notes:

The worksurface edge mounted screen is off-module and can be specified the same width as the worksurface it is to be mounted to, or smaller.

The worksurface edge mounted screen does not provide acoustical privacy.

Worksurface edge mounted screens that are 66-inches and greater come with 3 clamps.

how to specify:

The clamps on the worksurface edge mounted screens are finished in silver only.

Specify the width of the worksurface screen to be the same width or less than the worksurface or table that it is to be mounted to.

Refer to the finish section of the Tayco binder for screen finishes.

options

width	24, 30, 36, 42, 48, 54, 60, 66, 72, 78, 84, 90	
screen finish	F frosted	X spider
metal finish	P112 silver	

how to order and read your code

Sample Order: Worksurface edge mounted screen, 42-inch wide, frosted.

NOTE: SAMPLE CODE HERE INCLUDES ALL AVAILABLE OPTIONS.

C	VGGW	42	F	P112
product line	item	width	screen finish	metal finish

accessories | worksurface edge mounted screen

Code	Frosted	Spider	H (in.)	W (in.)	Weight (lb.)	Volume (ft³)
C-VGGW-24_	211	300	22	18	5.78	0.08
C-VGGW-30_	250	367	22	24	7.1	0.09
C-VGGW-36_	288	435	22	30	8.43	0.11
C-VGGW-42_	327	502	22	36	9.75	0.13
C-VGGW-48_	366	571	22	42	11.08	0.15
C-VGGW-54_	404	639	22	48	12.4	0.17
C-VGGW-60_	444	707	22	54	13.73	0.19
C-VGGW-66_	522	815	22	60	15.06	0.21
C-VGGW-72_	560	882	22	66	16.4	0.23
C-VGGW-78_	599	951	22	72	17.72	0.25
C-VGGW-84_	637	1018	22	78	19.05	0.27
C-VGGW-90_	677	1086	22	84	20.38	0.29

accessories | worksurface edge mounted work organizer screen

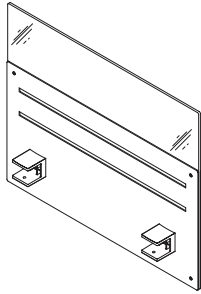

edge mounted work organizer screen

what's included:

Worksurface edge mounted work organizer screen, two clamps.

application notes:

The worksurface edge mounted work organizer screen is off-module and can be specified the same width as the worksurface it is to be mounted to, or smaller.

The worksurface edge mounted work organizer screen does not provide acoustical privacy.

Worksurface edge mounted work organizer screens that are 66-inches and greater come with 3 clamps.

how to specify:

The worksurface edge mounted work organizer screen and clamps are finished in silver only.

Specify the width of the worksurface work organizer screen to be the same width or less than the worksurface or table that it is to be mounted to.

Refer to the finish section of the Tayco binder for top screen finishes.

options

width	24, 30, 36, 42, 48, 54, 60, 66, 72	
top screen finish	F frosted	X spider
metal finish	P112 silver	

how to order and read your code

Sample Order: Worksurface edge mounted work organizer screen, 48-inch wide, frosted.

NOTE: SAMPLE CODE HERE INCLUDES ALL AVAILABLE OPTIONS.

A product line	VGOW item	48 width	F screen finish	P112 metal finish
----------------------	--------------	-------------	-----------------------	-------------------------

accessories | worksurface edge mounted work organizer screen

Code	Frosted	Spider	H (in.)	W (in.)	Weight (lb.)	Volume (ft ³)
C-VGOW-24-__	523	611	22	24	5.78	0.15
C-VGOW-30-__	633	751	22	30	7.14	0.19
C-VGOW-36-__	723	870	22	36	8.47	0.23
C-VGOW-42-__	871	1046	22	42	9.79	0.26
C-VGOW-48-__	937	1142	22	48	11.12	0.3
C-VGOW-54-__	1031	1264	22	54	12.44	0.34
C-VGOW-60-__	1152	1414	22	60	13.77	0.38
C-VGOW-66-__	1396	1688	22	66	15.1	0.42
C-VGOW-72-__	1606	1899	22	72	16.43	0.46

accessories | worksurface edge mounted modesty screen

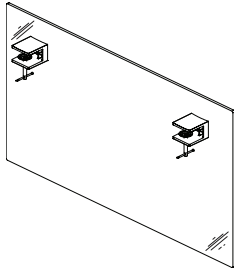

edge mounted modesty screen

what's included:

Worksurface edge mounted modesty screen, two clamps.

application notes:

The worksurface edge mounted modesty screen is off-module and can be specified the same width as the worksurface it is to be mounted to, or smaller.

how to specify:

The worksurface edge mounted modesty screen clamps are finished in silver only.

Specify the width of the worksurface work organizer screen to be the same width or less than the worksurface or table that it is to be mounted to.

Refer to the finish section of the Tayco binder for top screen finishes.

options

width	24, 30, 36, 42, 48, 54, 60, 66, 72, 78, 84, 90	
top screen finish	F frosted	X spider
metal finish	P112 silver	

how to order and read your code

Sample Order: Worksurface edge mounted modesty screen, 60-inch wide, spider acrylic.

NOTE: SAMPLE CODE HERE INCLUDES ALL AVAILABLE OPTIONS.

C product line	SM item	60 width	X screen finish	P112 metal finish
----------------------	------------	-------------	-----------------------	-------------------------

accessories | worksurface edge mounted modesty screen

Code	Frosted	Spider	H (in.)	W (in.)	Weight (lb.)	Volume (ft ³)
C-SM_-24	211	245	22	24	5.78	0.08
C-SM_-30	250	367	22	30	7.1	0.09
C-SM_-36	288	435	22	36	8.43	0.11
C-SM_-42	327	502	22	42	9.75	0.13
C-SM_-48	366	582	22	48	11.08	0.15
C-SM_-54	404	639	22	54	12.4	0.17
C-SM_-60	444	707	22	60	13.73	0.19
C-SM_-66	522	815	22	66	15.06	0.21
C-SM_-72	560	882	22	72	16.39	0.23
C-SM_-78	599	951	22	78	17.72	0.25
C-SM_-84	637	1018	22	84	19.05	0.27
C-SM_-90	677	1086	22	90	20.38	0.29

accessories | top trim mounted privacy screen

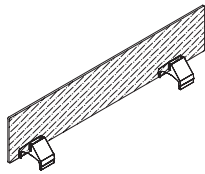

8-inch privacy screen

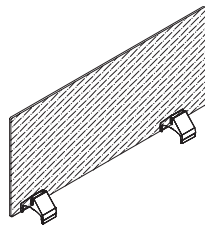

16-inch privacy screen

what's included:

Top trim mounted privacy screen, two clamps.

how to specify:

Specify metal color.

application notes:

The top trim mounted privacy screen is off-module and can be specified the same width as the worksurface it is to be mounted to, or smaller.

Specify the width of the top trim mounted privacy screen to be the same width or less than the panel frame that it is to be mounted to.

The top trim mounted privacy screen does not provide acoustical privacy.

The top trim mounted privacy screen is not load bearing.

60-inch top trim mounted privacy screens come with 3 clamps.

options

height	8, 16		
width	18, 24, 30, 36, 42, 48, 54, 60		
top screen finish	F frosted	X spider	C clear
metal finish	metal colors		

how to order and read your code

Sample Order: top trim mounted privacy screen, 8-inch high, 30-inch wide, frosted acrylic, finished in silver (P112).

NOTE: SAMPLE CODE HERE INCLUDES ALL AVAILABLE OPTIONS.

C product line	VGGP item	8 height	30 width	F screen finish	P112 metal finish
----------------------	--------------	-------------	-------------	-----------------------	-------------------------

accessories | top trim mounted privacy screen

Code	Price	H (in.)	W (in.)	Weight (lb.)	Volume (ft ³)
Frosted Acrylic					
C-VGGP-0818-F	191	8	18	2.2	1
C-VGGP-0824-F	202	8	24	2.4	1.2
C-VGGP-0830-F	215	8	30	2.6	1.4
C-VGGP-0836-F	228	8	36	2.8	1.6
C-VGGP-0842-F	238	8	42	3	1.8
C-VGGP-0848-F	251	8	48	3.2	2
C-VGGP-0854-F	263	8	54	3.4	2.2
C-VGGP-0860-F	351	8	60	3.6	2.4
C-VGGP-1618-F	228	16	18	4.4	1.6
C-VGGP-1624-F	254	16	24	4.8	1.8
C-VGGP-1630-F	279	16	30	5.2	2
C-VGGP-1636-F	306	16	36	5.6	2.2
C-VGGP-1642-F	331	16	42	6	2.4
C-VGGP-1648-F	358	16	48	6.4	2.6
C-VGGP-1654-F	385	16	54	6.8	2.8
C-VGGP-1660-F	488	16	60	7.2	3
Spider Acrylic					
C-VGGP-0818-X	214	8	18	2.2	1
C-VGGP-0824-X	235	8	24	2.4	1.2
C-VGGP-0830-X	256	8	30	2.6	1.4
C-VGGP-0836-X	277	8	36	2.8	1.6
C-VGGP-0842-X	298	8	42	3	1.8
C-VGGP-0848-X	319	8	48	3.2	2
C-VGGP-0854-X	340	8	54	3.4	2.2
C-VGGP-0860-X	438	8	60	3.6	2.4
C-VGGP-1618-X	277	16	18	4.4	1.6
C-VGGP-1624-X	323	16	24	4.8	1.8
C-VGGP-1630-X	369	16	30	5.2	2
C-VGGP-1636-X	415	16	36	5.6	2.2
C-VGGP-1642-X	459	16	42	6	2.4
C-VGGP-1648-X	506	16	48	6.4	2.6
C-VGGP-1654-X	553	16	54	6.8	2.8
C-VGGP-1660-X	675	16	60	7.2	3
Clear Acrylic					
C-VGGP-0818-C	181	8	18	2.2	1
C-VGGP-0824-C	193	8	24	2.4	1.2
C-VGGP-0830-C	206	8	30	2.6	1.4
C-VGGP-0836-C	216	8	36	2.8	1.6
C-VGGP-0842-C	228	8	42	3	1.8
C-VGGP-0848-C	239	8	48	3.2	2
C-VGGP-0854-C	250	8	54	3.4	2.2
C-VGGP-0860-C	336	8	60	3.6	2.4
C-VGGP-1618-C	216	16	18	4.4	1.6
C-VGGP-1624-C	242	16	24	4.8	1.8
C-VGGP-1630-C	266	16	30	5.2	2
C-VGGP-1636-C	293	16	36	5.6	2.2
C-VGGP-1642-C	315	16	42	6	2.4
C-VGGP-1648-C	341	16	48	6.4	2.6
C-VGGP-1654-C	367	16	54	6.8	2.8
C-VGGP-1660-C	466	16	60	7.2	3

accessories | panel mounted privacy screen

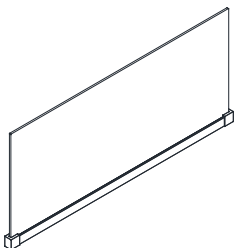

acrylic screen

what's included:

Panel mounted acrylic screen, installation hardware.

how to specify:

Specify metal colour.

application notes:

The panel top mounted privacy screen is on-module to panel frames of the same width.

Specify the width of the panel top mounted privacy screen to be the same width of the panel frame that it is to be mounted to.

The panel top mounted privacy screen does not provide acoustical privacy.

The panel top mounted privacy screen is not load bearing.

options

height	8, 16				
width	18, 24, 30, 36, 42, 48, 54, 60				
finish	F frosted acrylic	X spider acrylic	C clear acrylic	C-G clear glass	C-F frosted glass
metal	metal colours				

how to order and read your code

Sample Order: Panel mounted acrylic screen, 8" high and 18" wide in clear acrylic



accessories | panel mounted acrylic and glass screen

Code	Price	H (in.)	W (in.)	Weight (lb.)	Volume (ft ³)
Clear Acrylic					
C-VUCP-0818-C	209	8	18	2.2	0.17
C-VUCP-0824-C	237	8	24	2.4	0.22
C-VUCP-0830-C	265	8	30	2.6	0.28
C-VUCP-0836-C	294	8	36	2.8	0.33
C-VUCP-0842-C	324	8	42	3	0.39
C-VUCP-0848-C	353	8	48	3.2	0.44
C-VUCP-0854-C	382	8	54	3.4	0.5
C-VUCP-0860-C	403	8	60	3.6	0.56
C-VUCP-1618-C	260	16	18	4.4	0.33
C-VUCP-1624-C	321	16	24	4.8	0.44
C-VUCP-1630-C	375	16	30	5.2	0.56
C-VUCP-1636-C	420	16	36	5.6	0.67
C-VUCP-1642-C	465	16	42	6	0.78
C-VUCP-1648-C	510	16	48	6.4	0.89
C-VUCP-1654-C	554	16	54	6.8	1
C-VUCP-1660-C	599	16	60	7.2	1.11
Frosted Acrylic					
C-VUCP-0818-F	215	8	18	2.2	0.17
C-VUCP-0824-F	248	8	24	2.4	0.22
C-VUCP-0830-F	281	8	30	2.6	0.28
C-VUCP-0836-F	314	8	36	2.8	0.33
C-VUCP-0842-F	351	8	42	3	0.39
C-VUCP-0848-F	384	8	48	3.2	0.44
C-VUCP-0854-F	419	8	54	3.4	0.5
C-VUCP-0860-F	437	8	60	3.6	0.56
C-VUCP-1618-F	280	16	18	4.4	0.33
C-VUCP-1624-F	350	16	24	4.8	0.44
C-VUCP-1630-F	405	16	30	5.2	0.56
C-VUCP-1636-F	442	16	36	5.6	0.67
C-VUCP-1642-F	480	16	42	6	0.78
C-VUCP-1648-F	517	16	48	6.4	0.89
C-VUCP-1654-F	554	16	54	6.8	1
C-VUCP-1660-F	591	16	60	7.2	1.11
Spider Acrylic					
C-VUCP-0818-X	314	8	18	2.2	0.17
C-VUCP-0824-X	384	8	24	2.4	0.22
C-VUCP-0830-X	455	8	30	2.6	0.28
C-VUCP-0836-X	527	8	36	2.8	0.33
C-VUCP-0842-X	595	8	42	3	0.39
C-VUCP-0848-X	667	8	48	3.2	0.44
C-VUCP-0854-X	736	8	54	3.4	0.5
C-VUCP-0860-X	780	8	60	3.6	0.56
C-VUCP-1618-X	494	16	18	4.4	0.33
C-VUCP-1624-X	658	16	24	4.8	0.44
C-VUCP-1630-X	796	16	30	5.2	0.56
C-VUCP-1636-X	897	16	36	5.6	0.67
C-VUCP-1642-X	986	16	42	6	0.78
C-VUCP-1648-X	1084	16	48	6.4	0.89
C-VUCP-1654-X	1174	16	54	6.8	1
C-VUCP-1660-X	1271	16	60	7.2	1.11
Clear Tempered Glass					
C-VUCP-0818-C-G	280	8	18	3.4	0.17
C-VUCP-0824-C-G	305	8	24	4.53	0.22
C-VUCP-0830-C-G	330	8	30	5.67	0.28
C-VUCP-0836-C-G	355	8	36	6.8	0.33
C-VUCP-0842-C-G	380	8	42	7.93	0.39
C-VUCP-0848-C-G	405	8	48	9.07	0.44
C-VUCP-0854-C-G	430	8	54	10.2	0.5
C-VUCP-0860-C-G	455	8	60	11.33	0.56
C-VUCP-1618-C-G	310	16	18	6.8	0.33
C-VUCP-1624-C-G	360	16	24	9.07	0.44
C-VUCP-1630-C-G	410	16	30	11.33	0.56
C-VUCP-1636-C-G	460	16	36	13.6	0.67

accessories | panel mounted acrylic and glass screen

Code	Price	H (in.)	W (in.)	Weight (lb.)	Volume (ft ³)
C-VUCP-1642-C-G	510	16	42	15.87	0.78
C-VUCP-1648-C-G	560	16	48	18.13	0.89
C-VUCP-1654-C-G	610	16	54	20.4	1
C-VUCP-1660-C-G	660	16	60	22.67	1.11
Frosted Tempered Glass					
C-VUCP-0818-F-G	360	8	18	3.4	0.17
C-VUCP-0824-F-G	385	8	24	4.53	0.22
C-VUCP-0830-F-G	410	8	30	5.67	0.28
C-VUCP-0836-F-G	435	8	36	6.8	0.33
C-VUCP-0842-F-G	460	8	42	7.93	0.39
C-VUCP-0848-F-G	485	8	48	9.07	0.44
C-VUCP-0854-F-G	510	8	54	10.2	0.5
C-VUCP-0860-F-G	535	8	60	11.33	0.56
C-VUCP-1618-F-G	390	16	18	6.8	0.33
C-VUCP-1624-F-G	440	16	24	9.07	0.44
C-VUCP-1630-F-G	490	16	30	11.33	0.56
C-VUCP-1636-F-G	540	16	36	13.6	0.67
C-VUCP-1642-F-G	590	16	42	15.87	0.78
C-VUCP-1648-F-G	640	16	48	18.13	0.89
C-VUCP-1654-F-G	690	16	54	20.4	1
C-VUCP-1660-F-G	740	16	60	22.67	1.11

accessories | wall mounted tackboard

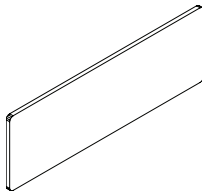

14-inch

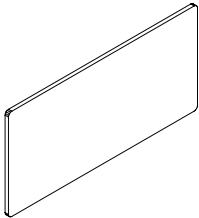

24-inch

what's included:
Wall mounted tackboard, fasteners.

application notes:
The wall mounted tackboard mounts to a wall in the workspace to provide a fabric wrapped tackable surface.

how to specify:
Specify fabric.

See the finish section of the Tayco binder for a complete listing of panel fabrics.

options

height	14, 24
width	24, 30, 36, 42, 48, 54, 60, 66, 72
screen finish	panel fabrics

how to order and read your code

Sample Order: Wall mounted tackboard, 14 inches high, 30 inches wide, finished in Crosstown Buff (1151).

NOTE: SAMPLE CODE HERE INCLUDES ALL AVAILABLE OPTIONS.

C product line	ATW0 item	14 height	30 width	1151 screen finish
----------------------	--------------	--------------	-------------	--------------------------

accessories | wall mounted tackboard

Code	Price	H (in.)	W (in.)	Weight (lb.)	Volume (ft ³)
C-ATW0-1424	71	14	24	1.91	0.76
C-ATW0-1430	76	14	30	2.13	0.85
C-ATW0-1436	95	14	36	2.55	1.02
C-ATW0-1442	100	14	42	2.98	1.19
C-ATW0-1448	104	14	48	3.4	1.36
C-ATW0-1454	110	14	54	3.83	1.53
C-ATW0-1460	114	14	60	4.25	1.7
C-ATW0-1466	144	14	66	4.68	1.87
C-ATW0-1472	156	14	72	5.1	2.04
C-ATW0-2424	91	24	24	2.56	1.02
C-ATW0-2430	96	24	30	3.2	1.28
C-ATW0-2436	126	24	36	3.84	1.54
C-ATW0-2442	131	24	42	4.48	1.79
C-ATW0-2448	135	24	48	5.12	2.05
C-ATW0-2454	143	24	54	5.76	2.3
C-ATW0-2460	148	24	60	6.4	2.56
C-ATW0-2466	164	24	66	7.04	2.82
C-ATW0-2472	175	24	72	7.68	3.07

accessories | mobile cpu holder

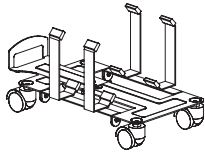

what's included:
Mobile CPU Holder.

how to specify:
This product is available only in black.

application notes:
The mobile CPU holder is adjustable to accommodate a wide range of CPUs.

options

There are no options for this product.

how to order and read your code

Sample Order: Mobile CPU holder.

NOTE: SAMPLE CODE HERE INCLUDES ALL AVAILABLE OPTIONS.

C	ACPU	M	
product line	item	mobile	

accessories | mobile cpu holder

Code	Price	H (in.)	W (in.)	D (in.)	Weight (lb.)	Volume (ft ³)
C-ACPU-M	181	4.3	15.5	9	8	0.34

accessories | underdesk cpu holder

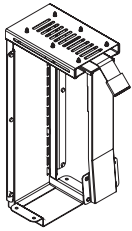

what's included:

Underdesk CPU Holder, installation hardware.

how to specify:

This product is available only in black.

application notes:

The underdesk CPU holder vertically supports CPUs under the worksurface, keeping CPUs off the floor to avoid clutter.

options

There are no options for this product.

how to order and read your code

Sample Order: Underdesk CPU holder.

NOTE: SAMPLE CODE HERE INCLUDES ALL AVAILABLE OPTIONS.

C	ACPU
product line	item

accessories | underdesk cpu holder

Code	Price	H (in.)	W (in.)	D (in.)	Weight (lb.)	Volume (ft ³)
C-ACPU	212	18	8.5	11.5	8	1.01

accessories | monitor arm

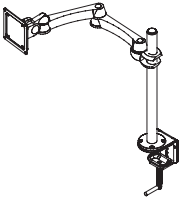

clamp on type

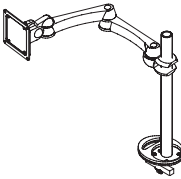

grommet hole type

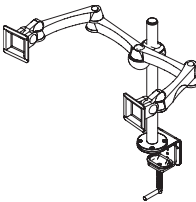

dual arm clamp on type

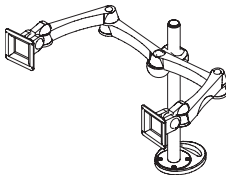

dual arm grommet hole type

what's included:
Monitor Arm, installation hardware.

how to specify:
Specify metal color.

application notes:
Monitor arms can be clamped onto a worksurface or can be fitted into a grommet hole.

options

type	C clamp-on	G grommet
configuration	1 single-arm	2 dual-arm
finish	black	sliver

how to order and read your code

Sample Order: Monitor arm, grommet hole type, single-arm, finished in silver (P112).

NOTE: SAMPLE CODE HERE INCLUDES ALL AVAILABLE OPTIONS.

C product line	AFMA item	G type	1 configuration	P112 finish color
----------------------	--------------	-----------	--------------------	-------------------------

accessories | monitor arm

Code	Price	H (in.)	W (in.)	Weight (lb.)	Volume (ft ³)
SINGLE ARM					
Clamp-On					
C-AFMA-C	295	16	20	10	0.8
Grommet					
C-AFMA-G	295	16	20	10	0.8
DUAL ARM					
Clamp-On					
C-AFMA-C-2	608	16	40	20	0.16
Grommet					
C-AFMA-G-2	608	16	40	20	0.16

accessories | adjustable keyboard tray

Code	Price	H (in.)	W (in.)	Weight (lb.)	Volume (ft ³)
C-KAS0-2510	287	25	10	15	0.94

accessories | adjustable keyboard tray with mouse

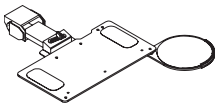

right hand

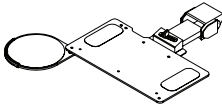

left hand

what's included:

Adjustable Keyboard Tray with mouse, installation hardware.

how to specify:

Right or left hand must be specified.

application notes:

Keyboard trays provide adjustable ergonomic support for individuals in multi-task environments.

This product is available only in black.

options

hand	R right	L Left
------	---------	--------

how to order and read your code

Sample Order: Adjustable keyboard tray with mouse, 20-inches wide, 11-inches deep, right-handed.

NOTE: SAMPLE CODE HERE INCLUDES ALL AVAILABLE OPTIONS.

C product line	KAS0 item	20 width	11 depth	R hand	
----------------------	--------------	-------------	-------------	-----------	--

accessories | adjustable keyboard tray with mouse

Code	Price	H (in.)	W (in.)	Weight (lb.)	Volume (ft ³)
C-KAS0-2011-L	317	20	11	3	0.83
C-KAS0-2011-R	317	20	11	3	0.83

accessories | retractable keyboard tray

Code	Price	H (in.)	W (in.)	Weight (lb.)	Volume (ft ³)
C-KRS0-2516	124	25	16	12	1.34

electrics, communication, lighting | base electrics power module

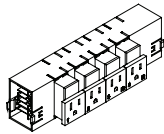

single-sided

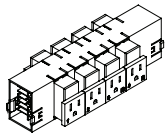

double-sided

what's included:

Base electrics power module as specified.

how to specify:

This product is available only in black.

application notes:

8 wire 4 circuit electrical system.

The base electrics power module can be retrofitted into the base raceway of existing Cosmopolitan panel frames.

Base electrics power modules can be single-sided or double-sided.

18-inch wide panel frame does not accommodate a base power module.

24-inch wide panel frames placed side-by-side only accommodates one base power module in one panel.

24-inch wide panel frame with base power module does not accommodate base data/communication kits.

options

type	S single-sided	D double-sided
------	----------------	----------------

how to order and read your code

Sample Order: Base electrics power module, double-sided.

NOTE: SAMPLE CODE HERE INCLUDES ALL AVAILABLE OPTIONS.



electrics, communication, lighting | base electrics power module

Code	Price	Weight (lb.)	Volume (ft ³)
Single-Sided C-EM84-S	136	1.7	0.2
Double-Sided C-EM84-D	215	2	0.2

electrics, communication, lighting | belt-line electrics power module

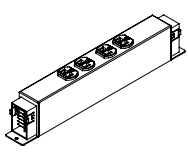

4 outlets

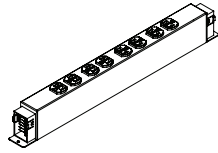

8 outlets

what's included:

Belt-line electrics power module as specified.

how to specify:

This product is available only in black.

application notes:

8 wire 4 circuit electrical system.

Belt-line electrics power modules are available with four outlets or eight outlets.

18-inch and 24-inch wide panel frames do not accommodate a belt-line power module.

30-inch wide panel frame accommodates belt-line power module with 4 outlets only.

30-inch wide panel frames placed side-by-side can only accommodate one 4 outlet module in one of the panel frames.

30-inch wide panel frame with a belt-line power module does not accommodate belt-line data/communication kits.

36-inch wide panel frame with a belt-line power module (8 outlets) does not accommodate belt-line data/communication kits.

options

type	B14 4 outlets (14")	B20 8 outlets (20")
------	---------------------	---------------------

how to order and read your code

Sample Order: Belt-line electrics power module, 4 outlets.

NOTE: SAMPLE CODE HERE INCLUDES ALL AVAILABLE OPTIONS.

C	EM84	B14
product line	item	type

electrics, communication, lighting | belt-line electrics power module

Code	Price	W (in.)	Weight (lb.)	Volume (ft ³)
4 Outlets C-EM84-B14	250	14	2	0.2
8 Outlets C-EM84-B20	321	20	2.7	0.2

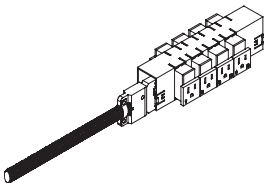

what's included:
Electric Starter Harness, as specified.

how to specify:
This product is available only in black.

application notes:
8 wire 4 circuit electrical system.

The starter harness is available in 72-inch and 168-inch lengths.

options

length	072 base-line (72")	168 belt-line (168')
configuration	B14 4 outlets (14")	B20 8 outlets (20")
accessibility	S single-sided	D double-sided

how to order and read your code

Sample Order: Electric starter harness, base-line (72"), double-sided.

NOTE: SAMPLE CODE HERE INCLUDES ALL AVAILABLE OPTIONS.

C product line	ES84 item	072 length	B14 configuration	D accessibility
----------------------	--------------	---------------	----------------------	--------------------

electrics, communication, lighting | electric starter harness

Code	Price	Weight (lb.)	Volume (ft ³)			
Base-Line						
C-ES84-072-S	295	2.48	0.4			
C-ES84-168-S	329	5.12	0.4			
C-ES84-072-D				375	2.28	0.4
C-ES84-168-D				410	5.22	0.4
Belt-Line						
C-ES84-072-B14				402	3.28	0.4
C-ES84-168-B14				436	4.48	0.4
C-ES84-072-B20				473	3.48	0.4
C-ES84-168-B20				507	5.22	0.4

electrics, communication, lighting | connector harness

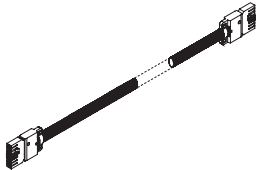

what's included:
Connector Harness, as specified.

how to specify:
This product is available only in black.

application notes:
8 wire 4 circuit electrical system.

The connector harness is equipped with two male ends.
Connector harnesses, 148-inches and longer
are comprised of two pieces connected together.

options

length	22, 25, 28, 31, 34, 37, 40, 43, 46, 49, 52, 55, 58, 61, 64, 67, 70, 73, 76, 79, 82, 85, 88, 91, 94, 97, 100, 103, 106, 109, 112, 115, 118, 121, 124, 127, 130, 133, 136, 139, 142, 145, 148, 151, 154, 157, 160, 163, 166, 169, 172, 175, 178, 181
--------	--

how to order and read your code

Sample Order: Connector harness, 43-inches long.

NOTE: SAMPLE CODE HERE INCLUDES ALL AVAILABLE OPTIONS.

C product line	Eh84 item	43 length	
----------------------	--------------	--------------	--

electrics, communication, lighting | connector harness

Code	Price	L (in.)	Weight (lb.)	Volume (ft ³)
one piece harnesses				
C-EH84-22	102	22	0.6	0.2
C-EH84-25	105	25	0.7	0.2
C-EH84-28	108	28	0.8	0.2
C-EH84-31	112	31	0.8	0.2
C-EH84-34	115	34	0.9	0.2
C-EH84-37	119	37	1	0.2
C-EH84-40	124	40	1.1	0.2
C-EH84-43	127	43	1.2	0.2
C-EH84-46	130	46	1.3	0.2
C-EH84-49	134	49	1.5	0.2
C-EH84-52	137	52	1.5	0.2
C-EH84-55	142	55	1.6	0.2
C-EH84-58	145	58	1.7	0.2
C-EH84-61	148	61	1.8	0.2
C-EH84-64	152	64	1.9	0.2
C-EH84-67	156	67	1.9	0.2
C-EH84-70	159	70	2	0.2
C-EH84-73	164	73	1.95	0.2
C-EH84-76	167	76	2.04	0.2
C-EH84-79	170	79	2.12	0.2
C-EH84-82	174	82	2.12	0.2
C-EH84-85	177	85	2.37	0.2
C-EH84-88	181	88	2.37	0.2
C-EH84-91	185	91	2.37	0.2
C-EH84-94	188	94	2.53	0.2
C-EH84-97	193	97	2.53	0.2
C-EH84-100	196	100	2.7	0.2
C-EH84-103	199	103	2.7	0.2
C-EH84-106	203	106	2.86	0.2
C-EH84-109	207	109	2.86	0.2
C-EH84-112	210	112	3.03	0.2
C-EH84-115	214	115	3.03	0.2
C-EH84-118	218	118	3.19	0.2
C-EH84-121	221	121	3.36	0.2
C-EH84-124	225	124	3.36	0.2
C-EH84-127	230	127	3.52	0.2
C-EH84-130	233	130	3.52	0.2
C-EH84-133	236	133	3.39	0.2
C-EH84-136	240	136	3.69	0.2
C-EH84-139	243	139	3.85	0.2
C-EH84-142	246	142	3.85	0.2
C-EH84-145	251	145	3.85	0.2
two piece harnesses				
C-EH84-148	336	148	3.85	0.2
C-EH84-151	339	151	4.18	0.2
C-EH84-154	343	154	4.26	0.2
C-EH84-157	347	157	4.35	0.2
C-EH84-160	350	160	4.43	0.2
C-EH84-163	353	163	4.51	0.2
C-EH84-166	358	166	4.59	0.2
C-EH84-169	362	169	4.68	0.2
C-EH84-172	365	172	4.76	0.2
C-EH84-175	369	175	4.84	0.2
C-EH84-178	372	178	4.92	0.2
C-EH84-181	376	181	5.01	0.2

electrics, communication, lighting | male/female extension harness

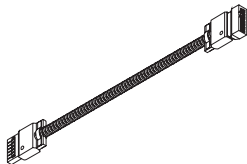

what's included:

Harness, as specified.

how to specify:

This product is available only in black.

application notes:

8 wire 4 circuit electrical system.

The harness is equipped with one male end and one female end. The harness connects connector harnesses to electrical power modules.

options

length	44, 122
--------	---------

how to order and read your code

Sample Order: Harness, 122-inches long.

NOTE: SAMPLE CODE HERE INCLUDES ALL AVAILABLE OPTIONS.

C product line	FM84 item	122 length	
----------------------	--------------	---------------	--

electrics, communication, lighting | male/female extension harness

Code	Price	L (in.)	Weight (lb.)	Volume (ft ³)
C-E8FM-044	130	44	0.3	0.2
C-E8FM-122	225	122	0.6	0.2

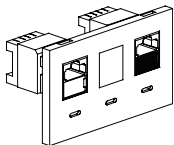

ECK1

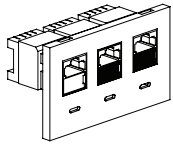

ECK2

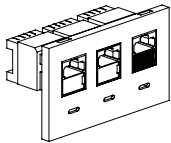

ECK3

what's included:
 Communication kit, face plate, and jacks, as specified.

how to specify:
 This product is available only in black.

application notes:
 Config 1: one communication outlet (RJ11), one data outlet (RJ45)
 Config 2: two communication outlets (RJ11), one data outlet (RJ45)
 Config 3: one communication outlet (RJ11), two data outlets (RJ45)

Specify configuration.

options

configuration	1 config 1	2 config 2
	3 config 3	
type	base-line	B belt-line

how to order and read your code

Sample Order: Communication kit, config 3, belt-line.

NOTE: SAMPLE CODE HERE INCLUDES ALL AVAILABLE OPTIONS.



electrics, communication, lighting | communication kit

Code	Price	Weight (lb.)	Volume (ft ³)
Base-Line			
C-ECK1	98	0.24	0.2
C-ECK2	119	0.34	0.2
C-ECK3	150	0.34	0.2
Belt-Line			
C-ECK1-B	124	0.24	0.2
C-ECK2-B	145	0.34	0.2
C-ECK3-B	176	0.34	0.2

electrics, communication, lighting | power pole

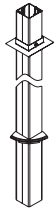

90-degree connection



t-connection



straight connection

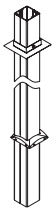

4-way connection

what's included:

Power pole, top cap, ceiling grommet.

how to specify:

Specify vinyl color.

application notes:

8 wire 4 circuit electrical system.

Refer to the vinyl/metal finish card for details.

The vinyl power pole attaches to cosmopolitan panel connectors in 90-degree connections, T-connections, straight connections or 4-way connections.

144-inch power poles have the option of being divided.

options

type	D divided	0 non-divided
height	72, 144	
connection	N 90-degree connection	T t-connection
	S straight connection	4 4-way connection
finish	vinyl colors	

how to order and read your code

Sample Order: Power pole, divided, 144-inches high, 4-way connection, finished in silver (V112).

NOTE: SAMPLE CODE HERE INCLUDES ALL AVAILABLE OPTIONS.

C product line	EPV item	D type	144 height	4 connection	V112 finish
----------------------	-------------	-----------	---------------	-----------------	----------------

electrics, communication, lighting | power pole

Code	Price	H (in.)	Weight (lb.)	Volume (ft ³)
90-Degree Connection				
C-EPVD-144-N	228	144	6	1.5
C-EPV0-072-N	135	72	3	1.0
C-EPV0-144-N	207	144	6	1.5
T-Connection				
C-EPVD-144-T	228	144	6	1.5
C-EPV0-072-T	135	72	3	1.0
C-EPV0-144-T	207	144	6	1.5
Straight Connection				
C-EPVD-144-S	228	144	6	1.5
C-EPV0-072-S	135	72	3	1.0
C-EPV0-144-S	207	144	6	1.5
4-Way Connection				
C-EPVD-144-4	228	144	6	1.5
C-EPV0-072-4	135	72	3	1.0
C-EPV0-144-4	207	144	6	1.5

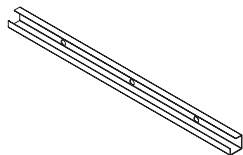

what's included:

Wire Manager, installation hardware.

application notes:

The horizontal wire manager attaches to the underside of a worksurface.

how to specify:

Specify the length of the wire manager to be 6-inches less than the width of the workstation to which it will be mounted.

options

width	12, 18, 24, 30, 36, 42, 48, 54, 60, 66, 72
-------	--

how to order and read your code

Sample Order: Wire manager, 24-inches wide.

NOTE: SAMPLE CODE HERE INCLUDES ALL AVAILABLE OPTIONS.

C product line	EWHB item	24 width	
-----------------------------	---------------------	--------------------	--

electrics, communication, lighting | wire manager

Code	Price	W (in.)	Weight (lb.)	Volume (ft³)
C-EWHB-12	2	12	0.15	0.1
C-EWHB-18	3	18	0.25	0.15
C-EWHB-24	4	24	0.35	0.2
C-EWHB-30	5	30	0.45	0.25
C-EWHB-36	6	36	0.55	0.3
C-EWHB-42	7	42	0.65	0.35
C-EWHB-48	8	48	0.75	0.4
C-EWHB-54	9	54	0.85	0.45
C-EWHB-60	11	60	0.95	0.5
C-EWHB-66	13	66	1.05	0.55
C-EWHB-72	15	72	1.15	0.6

electrics, communication, lighting | storage mounted task light

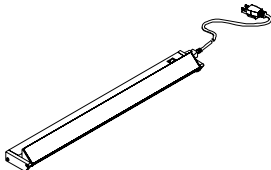

what's included:

Task Light, installation hardware.

how to specify:

This product is available only in silver.

application notes:

The task light can be mounted beneath an overhead cabinet or shelf to provide focused lighting within the workstation.

The task light cord is 9-feet long from the end of the task light.

options

width	24, 36, 48
-------	------------

how to order and read your code

Sample Order: Task light, 48-inches wide.

NOTE: SAMPLE CODE HERE INCLUDES ALL AVAILABLE OPTIONS.

C	ELU	48	
product line	item	width	

electrics, communication, lighting | task light

Code	Price	H (in.)	W (in.)	D (in.)	Weight (lb.)	Volume (ft ³)
C-ELU-24	124	1.1	24.53	3.5	9.50	0.16
C-ELU-36	138	1.1	36.34	3.5	13.70	0.27
C-ELU-48	147	1.1	48.15	3.5	17.90	0.38

tayco®

[tayco.com](https://www.tayco.com)

WORK WELL IS A TRADEMARK OF TAYCO PANELINK LTD.
ALL RIGHTS RESERVED. 0317